



Taycan

Good to know – Driver's Manual

Porsche, the Porsche crest, Taycan, PASM, PCM, PSM, Tequipment and other marks are registered trademarks of Dr. Ing. h.c. F. Porsche AG.

Printed in Germany.

Reprinting, even of excerpts, or duplication of any type is only permissible with the written authorisation of Dr. Ing. h.c. F. Porsche AG.

© Dr. Ing. h.c. F. Porsche AG

Porscheplatz 1
70435 Stuttgart
Germany

On-board literature

Always keep this on-board literature in the vehicle and please hand it over to the new owner if you sell your vehicle.

Do you have any questions, suggestions, or ideas for your vehicle or for the on-board literature?

Please write to us:

Dr. Ing. h.c. F. Porsche AG
Vertrieb Customer Relations
Porscheplatz 1
70435 Stuttgart
Germany

Equipment

Because our vehicles undergo continuous development, equipment and specifications may not be as illustrated or described by Porsche in this manual. Items of equipment are sometimes optional or vary depending on the country in which the vehicle is sold. For more information on retrofit equipment, please contact your Porsche partner.

Because of different legal requirements in individual countries, the equipment in your vehicle may vary from that described in this manual. Should your Porsche be fitted with any equipment not described

in this manual, your Porsche partner will be glad to provide information concerning correct operation and care of the items concerned.

Warnings and symbols

Various types of warnings and symbols are used in this manual.

 **DANGER** Serious injury or death

Failure to observe warnings in the "Danger" category will result in serious injury or death.

 **WARNING** Possible serious injury or death

Failure to observe warnings in the "Warning" category can result in serious injury or death.

 **CAUTION** Possible moderate or minor injury

Failure to observe warnings in the "Caution" category can result in moderate or minor injuries.

 **NOTICE** Possible vehicle damage

Failure to observe warnings in the "Notice" category can result in damage to the vehicle.

Information

Additional information is indicated using the word "Information".

- ✓ Conditions that must be met in order to use a function.
- ▶ Instruction that you must follow.
- 1. If an instruction comprises several steps, these are numbered.

- ▶ Notice on where you can find further important information on a topic.

Layout of the Manual

Driver's Manual – Digital



The Driver's Manual is available in digital form on-board in the vehicle and as an app.

▷ Page 3

Your first trip



Get to know your vehicle and find out about the main features for your first trip.

▷ From page 24

Contents

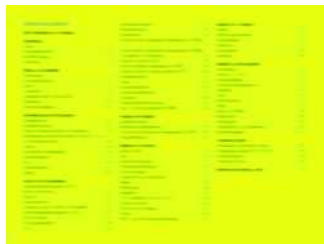

Gain an overview and find the topics you are looking for.

Topics from A – Z



Find out how components and controls work and how to operate them.

▷ From page 243

Safety and Driving Pleasure



Find out how to enjoy your driving pleasure safely.

▷ From page 5

Technical Data



Look for specific figures.

▷ From page 308

Overviews



Familiarise yourself with components and controls.

▷ From page 19

Index

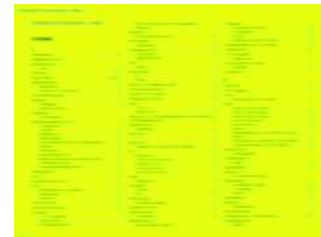

Get straight to the information you are looking for.

Driver's Manual - Digital

Further information about your vehicle is available (depending on country) in the **on-board** Driver's Manual in your vehicle and in the Porsche "Good to know" **app**: Detailed functions, video instructions, interactive graphics and keyword search function (index search).

On-board



You can find the Driver's Manual in the Porsche Communication Management (PCM) under:



App



You can download the Driver's Manual from the relevant app store by searching for **Gut zu wissen**, **Good to know** or **车主指南**:



Apple Disclaimer

Apple, the Apple logo, Apple CarPlay, iPhone, iPod, iOS, Siri and other designations of Apple are trademarks of Apple Inc., registered in the U.S. and other countries.

App Store is a service mark of Apple Inc., registered in the U.S. and other countries.

Contents

More Safety and More Driving Pleasure5

Overview Illustrations

▪ Sensors and cameras	19
Driver's Cockpit	20
Filler Openings	23
Overhead console	22
▪ Sensors and cameras	19

Your first trip24

Opening and locking

Alarm System	54
Bonnet	57
Central Locking	69
Driver's Key	104
Garage door opener (HomeLink®)	121
Rear lid	211
Windows	277

Air Conditioning and Ergonomics

Air Conditioning System Advanced Climate Control (2-/4-Zone Climate Control)	42
Airbag systems	40
Child Restraint Systems (Child Seats)	87
Interior lighting	134
Mirror	161
Personal settings	180
Seat Belts	220
Sun Visors	244
seats	223
steering wheel	241

Driving and Driver Assistance Systems

Active Lane Keeping	30
Adaptive Cruise Control (ACC)	34
Brakes	61
Cruise control (CC)	98
Driving mode	106
Emergency Stop Function	112

HOLD function	123
Intersection Assist	136
Lane Change Assist (LCA)	139
Lane Keep Assist	144
Lights	147
Night View Assist	171
ParkAssist	176
Porsche Active Suspension Management (PASM)	187
Porsche InnoDrive (PID)	199
Porsche Stability Management (PSM)	206
Porsche Vehicle Tracking System (PVTS)	208
Speed Limiter (LIM)	230
Spoiler	233
Starting, driving and stopping the vehicle	236
Traffic sign detection	247
Warn and Brake Assist (WBA)	267
Windscreen Wiper	279

Display and input

Centre console control panel	76
Porsche Communication Management (PCM) ... instrument cluster	125
voice control	264

Operation and use

Apple CarPlay	55
Apps	56
Device Manager	102
Home screen and MyScreen	124
Media	157
Messages	160
Navigation	165
Notifications	173
Over-the-Air (OTA) functions	174
Phone	182
Porsche Connect	196
Sport Chrono Stopwatch	234
Vehicle settings	257
Warning and information messages	271

Luggage and Transport

Luggage compartment	153
Roof Transport System	214
Smoker's Package	228
Socket	229
Storage	243
cupholder	100

Mobility and Breakdown Assistance

12-volt battery	282
Brake Fluid	60
Car Care	63
Charging high-voltage battery	79
Coolant	97
Emergency Call System	108
Flat Tyre	114
Fuses	117
Jack and Lifting Platform	138
Screenwash	219
Towing	245
Tyres and Wheels	249

Technical data

Radio equipment in accordance with 2014/53/EU	313
Radio equipment outside European countries	303
Software licences	287
Technical Data	308

Index316

Same Driving Pleasure, More Safety

Your Porsche: Extreme performance, extreme sportiness. A fascinating experience - no doubt about it. But only if you can remain relaxed whatever the situation. This is why safety for us is also a matter of maximum quality.

Here you can find out how you can play your part in ensuring safety while driving your Porsche.

Perfect technology: a prerequisite for your safety

High-quality materials and excellent workmanship will keep your car on the road for many years to come. In order to achieve its full potential, the vehicle requires attention and care. That way, you will also be able to rely on your Porsche in critical situations.

Getting to know the special features of the electric vehicle



Electrical system

The voltage in the high-voltage vehicle electrical system and high-voltage battery is extremely dangerous. Touching damaged high-voltage cables, the on-board charger, the high-voltage heater, the high-voltage battery, the power electronics or the A/C compressor can result in a fatal electric shock.

All components of the electrical system are marked with warning stickers. The high-voltage cables are orange.

- ▶ Do not perform any work on the high-voltage vehicle electrical system, orange-coloured high-voltage cables, on-board charger, high-voltage heater, high-voltage battery, power electronics or A/C compressor.
- ▶ Never damage, remove or disconnect the orange high-voltage cables from the high-voltage vehicle electrical system.
- ▶ Do not touch components of the electrical system that have been damaged, such as following an accident.
- ▶ Never remove the high-voltage battery.

Restricted perception

The vehicle produces considerably less driving and running noise than a vehicle with a combustion engine. In certain situations - in zones with traffic calming, when reversing or parking, for example - other road users may not hear your vehicle.

- ▶ Activating E-Sound.
- ▶ Drive with extreme care and attention.

Checking the vehicle for damage and correct functioning



A vehicle with technical defects may be the cause of accidents, such as due to faulty operating behaviour.

- ▶ Check your vehicle regularly (at least once a month and before any long journey) to ensure it is in good technical condition. In particular, pay attention to the following:
 - Tyres are not damaged and have the right pressure and sufficient tread
 - Headlights, brake lights and direction indicators all work
 - Aerodynamic components are undamaged
 - Wiper blades are intact
 - Windscreen/windows are unobstructed without any cracks or damage to the glass
 - Exterior and interior mirrors are intact and correctly positioned
 - Sensors and cameras are without cracks or damage
 - Cooling air ducts, sensors and cameras are not obstructed (e.g. through films or stone shields, number plate holders)
- ▶ Only use telephones or 2-way radios inside the vehicle with an external antenna connected so as not to exceed the limits for electromagnetic radiation in the vehicle.

Checking tyres for damage



Damaged tyres may burst while you are driving. You may lose control of the vehicle.

- ▶ Depending on how often you drive and the conditions, but at least once a month, check tyres

regularly for foreign bodies, nicks, cuts, cracks and bulges. Remember to also check the side walls of the tyres.

- ▶ If in doubt, have the tyres and the entire wheel checked by a qualified specialist workshop.
- ▶ Do **not** continue driving with damaged tyres. Have damaged tyres replaced immediately: Go to a qualified specialist workshop. Porsche recommends a Porsche partner as they have trained workshop personnel and the necessary parts and tools.

Adjusting the tyre pressure



Excessively low or high tyre pressure irreparably damages the tyre and the wheel, lengthens the braking distance and greatly increases the risk of an accident. If the tyre pressure is too low, power consumption can increase noticeably and the range may decrease.

- ▶ Adapt tyre pressure to suit your specific tyres and the payload.
 - ▷ Please refer to chapter "Tyres and Wheels" on page 249.
 - ▷ Please refer to chapter "Technical Data" on page 308.
- ▶ Make sure that the settings in the Tyre Pressure Monitoring menu on the multi-function display correspond to the tyres fitted on the vehicle and the load condition of the vehicle.

- ▶ Please refer to chapter "Configuring Tyre Pressure Monitoring (TPM) on the central display" on page 250.
- ▶ When a red tyre pressure warning appears on the instrument cluster: stop immediately in a suitable place and check the tyres for damage. Do **not** continue driving with damaged tyres. If necessary, remedy the damage with tyre sealant.
 - ▷ Please refer to chapter "Flat Tyre" on page 114.

Checking the lights



If lights are faulty, your vehicle is not illuminated and hard to see in conditions of poor visibility. Other drivers will see you too late and you could be involved in an accident. The lights to check are:

- Parking light, dipped beam, driving lights, high beam
- Direction indicators, brake lights, reversing lights
- Fog lights
- ▶ Check that all lights are working, and have defective lights repaired immediately.

Checking aerodynamic components



Damaged or missing aerodynamic components (e.g. spoilers or underbody panelling) impair vehicle handling.

- ▶ Inspect your vehicle for signs of damage.
- ▶ Have damaged or missing components replaced immediately.

Keeping windows and wiper blades clean and in good working order



Dirty windscreens, windows and defective wiper blades reduce visibility and dramatically increase the risk of an accident.

- ▶ Keep the vehicle and windscreen/windows clean.
- ▶ Thaw frozen wiper blades and free them from the windscreen.
- ▶ Replace wiper blades regularly, or at the latest when they leave streaks on the windscreen.

- ▶ Please refer to chapter "Windscreen Wiper" on page 279.

Maintenance and modifications only by qualified specialist workshops



Any modification to the vehicle can adversely affect or even disable safety functions. Unauthorised work performed during the warranty period may result in claims being invalidated.

- ▶ Have all maintenance and all modifications to the vehicle performed solely by a qualified specialist workshop. This ensures that your vehicle will remain reliable and safe to drive and that no consequential damage will occur to your vehicle. Porsche recommends a Porsche partner, as they have trained workshop personnel and the necessary parts and tools.

diagnostic socket

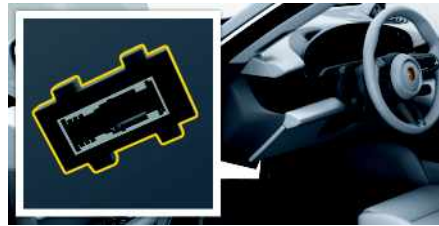

The diagnostic socket is used to connect diagnostic equipment in qualified specialist workshops. External equipment (e.g. navigation units, head-up displays) connected to the diagnostic socket can impair the function of the vehicle systems and run down or damage the battery (exhaustive discharge) when the vehicle is turned off. The external equipment and cables can obstruct clearance around the pedals or become caught between the pedals when braking or changing direction.

- ▶ Do not connect any equipment to the diagnostic socket.
- ▶ Do not place any equipment or cables in the driver's footwell.

Spare parts for your Porsche



- ▶ Only use genuine Porsche spare parts for your vehicle or spare parts of an equivalent quality

that have been manufactured according to the specifications and production requirements of Porsche. This ensures that your vehicle will remain reliable and safe to drive and that no consequential damage will occur to your vehicle. You can obtain these parts from a Porsche partner or a qualified specialist workshop. Porsche recommends a Porsche partner, as they have trained workshop personnel and the necessary parts and tools.

- ▶ Only use accessories that are from the Porsche Equipment range or the have been tested and approved by Porsche. For information on Porsche Equipment: Contact your Porsche partner.

i Information

If other spare parts or accessories are used, Porsche refuses to accept liability for any damage caused by their use. Even if the supplier of other spare parts or accessories is a recognised supplier, the safety of your vehicle may still be compromised. Using spare parts or accessories that are not approved by Porsche may invalidate your vehicle warranty.

Loading, safety systems, children in the vehicle: know-how for Porsche drivers

Your Porsche can accelerate to over 100 km/h (62 mph) in just a few seconds. With this amount of power at your disposal, you should do everything to ensure safety before you set off.

Therefore, put the same passion into getting reading for a trip as you do into driving.

Using seat belts correctly therefore saves lives.



Seat belts can only protect you from injury if they are used correctly and in full working order.

i Information

Severe injuries can occur at speeds as low as 30 km/h (20 mph) if you are not wearing a seat belt. Safety systems only protect you when working in combination. For example, airbags can only provide the right protection if the safety belt is also put on correctly.

- ▶ Always fasten seat belts tightly, even on short journeys.
- ▶ Use one seat belt to secure one occupant only.
- ▶ Remove bulky items of clothing (e.g. winter coats).
- ▶ Do not place the seat belts across hard or fragile objects (e.g. glasses or ball-point pens).
- ▶ Do not twist the seat belts.
- ▶ Always make sure unused seat belts are completely retracted.
- ▶ Pregnant drivers or passengers should position the lap belt well below their belly and lay the shoulder belt tautly over their chest.
- ▶ If worn or damaged, have the belt, belt buckle or attachment points replaced.

- ▶ Please refer to chapter "Seat Belts" on page 220.

Airbag system



Airbag systems can only perform their protective function if all occupants have their seat belts fastened and maintain the correct seat position. Objects and luggage must be stowed safely.

- ▶ Make sure that there are no persons, animals or objects between the occupants and the area into which the airbag deploys.
- ▶ Keep a distance from the airbags, e.g. do not lean against the inside of the doors. Always keep your feet in the footwell when driving. Do not put your feet on the dashboard or seat surface.

Airbag systems that have been tampered with offer no protection. They may either not trigger or be triggered in an uncontrolled manner. An airbag that triggers in an uncontrolled manner can cause serious injuries.

- ▶ Do not use seat covers.
- ▶ Do not attach any additional trims or stickers to

the steering wheel or in the vicinity of the airbags.

- ▶ Do not route any cables of additional electrical equipment in the vicinity of the airbag wiring.
- ▶ Do not remove airbag components (e.g. steering wheel, front seats, roof trims).
- ▶ Do not modify the wiring or components of the airbag system.
 - ▶ Please refer to chapter "Airbag systems" on page 40.

Securing all objects in the passenger compartment



An unsecured or incorrectly positioned load in the passenger compartment can slide around as a result of braking or acceleration as well as during changes of direction or an accident. This can endanger and injure vehicle occupants.

i Information

In the event of a collision at 50 km/h (30 mph), for example, unsecured objects can be thrown forwards with a force up to 50 times their weight. For example, a 1.5 litre bottle of water has a force of up to 75 kg as it flies through the interior.

- ▶ Always secure items for transport.
- ▶ Always transport objects in lockable storage compartments where possible.
- ▶ Always stow loads securely, e.g. in the luggage compartment.
- ▶ Stow small items in storage compartments and close all lockable storage compartments. Never let objects protrude from storage compartments.
- ▶ Never place objects on top of the dashboard.
- ▶ Secure loads with tie-down belts (tear strength at least 700 kg).
- ▶ Do not transport any heavy objects in open storage compartments.
- ▶ Also provide your passengers with all information regarding safety measures.

For correctly loading your Porsche and stowing items:

- ▷ Please refer to chapter "Storage" on page 243.
- ▷ Please refer to chapter "Luggage compartment" on page 153.

Preventing crushing hazards



Persons or animals can get caught or crushed if they are in the range of movement of the vehicle parts below. These parts include the following, among others:

- Adjustable front seats
- Doors
- Window

- Flaps and lids
- Lids of storage compartments
- ▶ Make sure that no persons or animals are within the range of movement when moving these vehicle components.

Supervising children's behaviour



Children often cannot judge dangers correctly and may behave inappropriately in dangerous situations. Children can accidentally trigger automatic settings (e.g. seat adjustment) and suffer injury. Children will not be able to exit the vehicle in emergency situations e.g. an overheated passenger compartment. This can be life-threatening, especially for small children.

- ▶ Keep children away from live or hot parts.
- ▶ Keep toxic materials, such as tyre sealant, out of reach of children.
- ▶ Do not leave children in the vehicle unattended.

Using a child restraint system safely



Child restraint systems can only work if they are correctly installed.

- ▶ **Only** use child restraint systems that have been approved for your Porsche.
- ▶ Before you use a child restraint system: Read and follow the child restraint system manufacturer's instructions as well as this manual.
 - ▷ Please refer to chapter "Child Restraint Systems (Child Seats)" on page 87.

Safe and competent driving: always making the right decision

Your Porsche is an all-rounder. From Launch Control to the emergency braking function – once you let it loose, everything is possible. However, at the end of the day, you are responsible for keeping your power house under control.

Avoid distraction



If you use the displays or other components in the vehicle while driving, you will be distracted from the traffic and may not react in time to dangerous situations. For your safety, some functions are only available when the vehicle is stationary.

- ▶ Never adjust the mirror, seat or steering wheel while driving. The seat or steering wheel may move unexpectedly far. You may lose control of the vehicle. Adjust the mirror, seat and steering wheel position before driving.
- ▶ Only use the multi-function steering wheel, infotainment system, etc. while driving if the traffic situation permits. In case of doubt, stop the vehicle when it is safe to do so.
- ▶ Do not use mobile phones or other mobile devices while driving.
- ▶ Always use hands-free equipment.
- ▶ Do not reach through the steering wheel spokes while driving. Otherwise, you may not be able to react in time to dangerous situations.

Awareness of braking behaviour in rain and snow

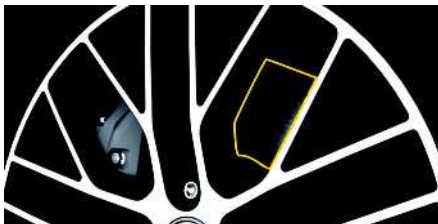

In heavy rain, while driving through water or after leaving a car wash, a film of water may form on the brakes, delaying the braking action and requiring increased pressure on the brake pedal.

Moreover, after a long drive in wintry road conditions, a coating may form on brake discs and pads that significantly reduces friction and therefore also the braking action.

- ▶ Brake the brakes dry, especially before parking the vehicle. This will prevent corrosion.
- ▶ Corroded brakes tend to "judder". If braking comfort is noticeably impaired, have the brake system checked.

Suitable tyres and appropriate driving style



- ▶ Please refer to chapter "Tyres and Wheels" on page 249.

Responding correctly to uneven running or vibrations

Damage to the tyres or vehicle can lead to uneven running or vibration while driving. You may lose control of the vehicle.

- ▶ Reduce your speed immediately, but without braking sharply.
- ▶ Stop the vehicle and check the tyres. If you cannot find a cause for the problem, continue driving carefully and have the problem fixed. Visit a qualified specialist workshop. Porsche recommends a Porsche partner as they have trained workshop personnel and the necessary parts and tools.

Keeping tyres in safe condition

Damaged tyres can burst, especially at high speeds. Prevent damage to tyres by driving in a manner that protects your tyres.

- ▶ Cross kerb edges slowly and at right angles if possible.
- ▶ Avoid driving over steep or sharp kerbs.

Running in new tyres

New tyres do not yet have maximum grip on the road surface.

- ▶ Run in new tyres at a moderate speed for the first 200 km (125 miles).

Driving with winter tyres

Winter tyres are subject to maximum speeds. If you exceed the maximum permitted speed, a tyre may burst.

- ▶ Always observe the maximum permitted speed for the tyres you are using.
- ▶ Affix a sticker showing the maximum permitted speed in the driver's field of vision. Observe country-specific laws.

Driving with summer tyres

Parking, manoeuvring or accelerating out of bends at outside temperatures below 15 °C may result in noises.

- ▶ Change to winter tyres when outside temperatures are below 7 °C.

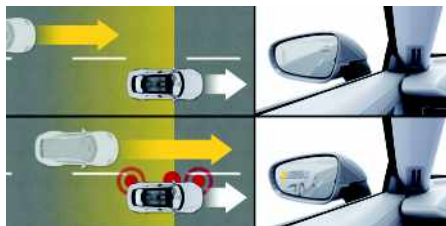
Assistance systems and their limitations

Your Porsche is equipped with assistance systems that enhance your safety and driving comfort.

None of these systems can overcome the laws of physics affecting driving.

- ▶ Do not be tempted to take greater risks with your safety. Assistance systems cannot reduce the risk of accidents caused by an inappropriate driving style.
- ▶ Assistance systems are no substitute for your careful attention. Always remain attentive so that you can react appropriately to the traffic situation.
- ▶ Familiarise yourself with assistance systems before you use them.

Here you can find the Assistance systems at a glance:

Adaptive Cruise Control (ACC) ▶ p. 34

Anti-lock brake system (ABS) ▶ p. 206

Active Lane Guidance ▶ p. 30

Speed limiter ▶ p. 230

HOLD function ▶ p. 123

Intersection Assist ▶ p. 136

Automatic headlights, PDLS Plus, dynamic high beam ▶ p. 147

Night View Assist ▶ p. 171

Emergency stop function ▶ p. 112

ParkAssist, reversing camera, Surround View ▶ p. 176

Porsche Active Suspension Management (PASM) ▶ p. 187
▶ p. 187

Porsche InnoDrive (PID) ▶ p. 199

Porsche Stability Management (PSM) ▶ p. 206

Porsche Vehicle Tracking System (PVTS) ▶ p. 208

Tyre Pressure Monitoring (TPM) ▶ p. 249

Lane Keep Assist ▶ p. 144

Lane Change Assist ▶ p. 139

cruise control ▶ p. 98

Traffic sign detection ▶ p. 247

Warn and Brake Assist (WBA) ▶ p. 267

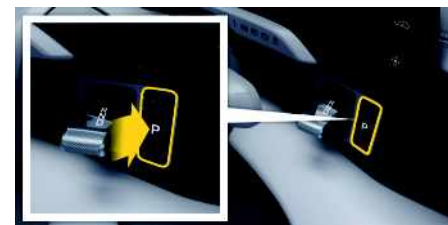
Emergency braking function

You can carry out emergency braking using the electric parking brake, for example if the conventional footbrake is defective.

Emergency braking takes place with very high braking power. As a result, the traffic behind may be endangered.

- ▶ Only use the emergency braking function in an emergency situation and not during normal driving.
- ▶ For emergency braking, press the **P** button. To stop braking, release the switch.
 - ▶ Please refer to chapter "Brakes" on page 61.

Driving with a loaded vehicle

The handling of your Porsche changes depending on the vehicle load. If you are using a roof transport system, there is also greater wind resistance.

- ▶ Adapt your driving style to the changed vehicle handling.
- ▶ Do not drive at a speed of more than 130 km/h (80 mph) with the roof transport system fitted and loaded.
- ▶ Do not drive at a speed of more than 180 km/h (110 mph) with the roof transport system fitted but not loaded.
- ▶ Do not exceed the maximum gross weight and axle load.

Driving off



The vehicle accelerates very quickly when driving off, particularly when using Launch Control. In certain circumstances (poor road conditions, lack of attention, etc.) you may lose control of the vehicle or endanger other road users.

- ▶ Adapt your speed to road and traffic conditions when starting off and driving.
- ▶ Only use Launch Control on public roads if road and traffic conditions permit.
- ▶ Do not endanger other road users when driving off.

Reacting correctly to warning signals



If the systems detect malfunctions or defective parts, your vehicle will warn you with lights or messages on the instrument cluster or central display. If you ignore vehicle warning signals, the risk of accidents, injuries and damage to the vehicle may increase.

- ▶ Familiarise yourself with the meaning of warning lights and messages before starting to drive so that you can respond correctly to the warnings. Stop driving if necessary.
 - ▶ Please refer to chapter "Warn- und Informationsmeldungen" on page 271.
 - ▶ Please refer to chapter "instrument cluster" on page 125.

Hazardous fluids



Besides transmission oil, battery acid, coolant and brake fluid are also hazardous to health.

- ▶ Only work on the vehicle in the open or in well-ventilated spaces.
- ▶ Fluid containers must be labelled appropriately and must be kept out of reach for children.
- ▶ Dispose of residues in an environmentally friendly manner and according to regulations.

Parking the vehicle safely

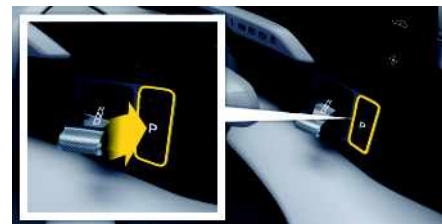

If the vehicle is not parked correctly, it can roll away uncontrolled, endangering people or causing material damage.

Before you leave the vehicle:

- ▶ Activate the parking lock and the electric parking brake by pressing the **P** button on the selector lever. If the **P** drive position is flashing on the instrument cluster, the parking lock is not activated. Press the **P** button on the selector lever once again.
- If your vehicle switches off because its high-voltage battery is fully discharged, you can still operate it briefly once more to park it safely.
- ▶ Press the **Power** button to establish operational readiness.
 - ▶ Move the vehicle out of the danger area.

Just in case: safety in the event of a breakdown or emergency

If you break down, pay attention to this information – for your own safety!

Do not use voice control in an emergency



In emergency situations, stress may cause your voice to change so that voice control does not recognise your instructions.

- ▶ Do **not** use voice control in an emergency.

Removing the fire extinguisher

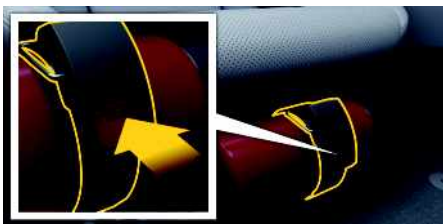

In vehicles that have one, the fire extinguisher is located under the passenger seat.

- ▶ Hold the extinguisher with one hand and press the **PRESS** button on the fire extinguisher holder with the other hand.

In order to ensure correct, safe operation of the fire extinguisher, observe the following points:

- ▶ Observe the inspection intervals for the fire extinguisher. If the fire extinguisher is used after the inspection interval has elapsed, functionality is no longer guaranteed.
- ▶ Observe the operating instructions on the fire extinguisher.
- ▶ Observe the safety instructions on the leaflet supplied by the fire extinguisher manufacturer on the extinguisher handle.
- ▶ The fire extinguisher should be checked by a specialist workshop every 1-2 years to ensure correct operation.
- ▶ Have the fire extinguisher refilled after use.

Hot vehicle parts



Vehicle parts in the chassis area and adjacent components get very hot while driving.

The fans can start running automatically at any time.

- ▶ Stop the vehicle and allow it to cool down if possible.
- ▶ Keep parts of the body, clothing, long hair and jewellery away from all moving parts such as fans.
- ▶ Wear safety gloves that provide protection from hot parts.

Protective equipment must be worn when performing certain operations on the vehicle, such as gloves to prevent cuts.

- ▶ Always have work on the vehicle carried out by a qualified specialist workshop. Porsche recommends a Porsche partner as they have trained workshop personnel and the necessary parts and tools.

Towing



Danger of significant damage to the vehicle as a result of tow-starting and push-starting.

- ▶ **Never** tow-start or push-start the vehicle.
- ▶ Before towing your vehicle or having your vehicle towed:
 - ▷ Please refer to chapter "Towing" on page 245.

Flat tyres



If you drive with damaged tyres, it may not be possible to steer the vehicle safely depending on your speed.

- ▶ **Never** continue driving with a flat tyre.
- ▶ Park the vehicle correctly and safely, and have the problem fixed.
 - ▷ Please refer to chapter "Flat Tyre" on page 114.

After a collision



The safety systems may not be operational (e.g. seat-belt pretensioners and airbags) after a collision. The safety systems can then no longer protect you.

- ▶ Have the safety systems checked even if they were not triggered.
- ▶ Always Have triggered safety systems replaced. Visit a qualified specialist workshop. Porsche recommends a Porsche partner as they have trained workshop personnel and the necessary parts and tools.

Before driving off: Important information on your Porsche

Breaking in the vehicle

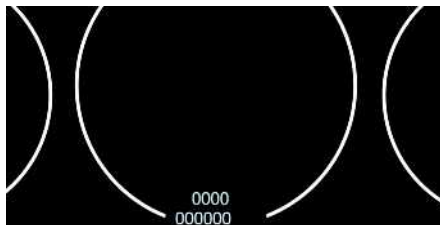

Fig. 1: Safety section: Breaking in the vehicle

In a new vehicle, the moving parts first have to be broken in with each other. The first 3,000 km (1,865 miles) are required for this. The oil and fuel consumption may be somewhat higher than the specified values during this time.

Drive as follows during the breaking-in period:

- ▶ Preferably take longer trips.
- ▶ Do not participate in motor racing events, sports driving schools, or similar.

Breaking in new brake pads

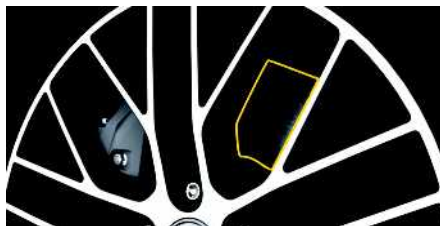

New brake pads and brake discs have to be "bedded in" and therefore only attain optimal friction once the vehicle has travelled several hundred miles.

The somewhat reduced braking action requires greater force when pressing the brake pedal. This is also the case whenever the brake pads or brake discs are replaced.

Pay attention to ground clearance



The vehicle has low ground clearance and can therefore easily bottom out.

- ▶ Avoid steep ramps.
- ▶ Drive carefully in the following situations:
 - Steep uphill and downhill slopes, such as in multi-storey car parks
 - Kerbs and speed bumps, such as at charging pedestals
 - Uneven road surfaces
 - Lifting platforms
- ▶ If the vehicle's undercarriage is damaged, park the vehicle safely and contact a qualified specialist workshop. Porsche recommends a Porsche partner, as they have trained workshop personnel and the necessary parts and tools.

Driving on race circuits



Compared with driving on roads, driving on race circuits involves disproportionately high vehicle loads, which pure race vehicles are able to withstand thanks to short maintenance and component reconditioning intervals. This includes carrying out checks and replacing individual components where necessary after each race circuit use and even overhauling entire assemblies after specified periods.

- ▶ Always make enquiries about the current stipulations before driving on race circuits: Contact your Porsche partner.

Following race circuit use, "cooling laps" must be driven in order to reduce the temperature of vehicle parts subjected to particularly high thermal loads in a controlled fashion. Stopping the vehicle right away would cause the component temperature to rise further due to stationary heat build-up. This can lead to irreparable damage to individual components.

Brake system

Brake fluid absorbs moisture from the air over time. This absorption of water lowers the boiling point and can considerably impair braking efficiency at high temperatures.

Brake pads and brake discs are subjected to very high stress when driving on a race circuit.

- ▶ If the brake fluid is more than 12 months old:

Replace brake fluid before driving on a race circuit.

- ▶ Have the brake pads and brake discs checked for wear before and after driving on race circuits.

tyre

Tyres are also subjected to very high loads when driving on a race circuit.

- ▶ Have tyres checked for wear before and after driving on race circuits.
- ▶ Do not fit racing tyres. Racing tyres are not approved by Porsche.

Before driving abroad



Not all Porsche models are sold in all countries. As a result, spare parts may not be available, or the Porsche Partner may not be able to carry out all repair work.

Find out the following information before driving abroad:

- Can the vehicle be repaired if it breaks down?
 - Does the vehicle require technical adjustments?
 - Do the headlights need to be changed for left-right-hand traffic?
- ▶ Please refer to chapter "Vehicle settings" on page 257.

Data processing in the vehicle



Electronic control units are installed in your vehicle. Some of these are required for the operational safety of your vehicle, while others provide assistance while driving (driver assistance systems). Moreover, your vehicle offers comfort and entertainment functions which are also made possible through electronic control units.

Your vehicle has a unique chassis number. This vehicle identification number (VIN) can be traced back to the present owner and to previous owners of the vehicle through the local authorities within the European Union. There are also other ways of tracing data collected from the vehicle back to the owner or driver, e.g. using the vehicle registration number.

Storing technical data in the vehicle

Electronic control units have data memories that can temporarily or permanently store technical information about vehicle status, component stress, servicing requirements, events or faults. Generally speaking, this technical information documents the status of a component, module, system or environment such as:

- Operating states of system components (e.g. fill levels)
- Status messages about the vehicle and its individual components (e.g. wheel revolutions, speed, deceleration, lateral acceleration)

- Malfunctions and faults in important system components (e.g. lights, brakes)
- Information about events that can damage the vehicle
- The vehicle response in special driving situations (e.g. triggering an airbag, activation of the stability control system)
- Environmental conditions (e.g. temperature)

In addition to providing the actual vehicle function, this data is used to detect and correct faults and enables the manufacturer to optimise vehicle functions. Most of this data is volatile and is only processed in the vehicle itself. Only a small part of the data is stored in event or fault memories. Moreover, your vehicle offers comfort and entertainment functions which are also made possible through electronic control units.

Read-out of technical data

You can have data that is only stored locally in the vehicle read out with the help of technical experts, e.g. in a workshop, for a fee if necessary. In individual cases, where statutory provisions exist to this end, Porsche as the manufacturer can be obliged, on foot of requests from state offices, to disclose data stored by the manufacturer in the required scope, e.g. to establish facts in the case of a criminal offence. When having your vehicle serviced, service network employees (e.g. workshops, breakdown services, manufacturers) can read out the technical information from the vehicle. Services include e.g. repair services, service processes, warranty claims and quality assurance measures. The data is read out using a legally prescribed connection for OBD (on-board diagnosis) in the vehicle. The data is collected, processed and used by the relevant service network personnel and may be sent to Porsche in order to comply with product monitoring obligations or to improve quality for example. The fault and event

memories in the vehicle can be reset by a repair workshop in the context of repair or service operations.

Using functions in the vehicle

Within the scope of the selected equipment options, you are able to enter information such as multimedia and address book data or navigation destinations and other settings in the vehicle comfort and infotainment functions. This data may be stored locally in the vehicle or it may be contained on a device which you have connected to the vehicle (e.g. mobile phone, USB stick or MP3 player). Where this data has been stored in the vehicle, you can delete it at any time. This data is only sent to third parties at your request and particularly while using online services, only in accordance with the settings you have selected.

If your vehicle has the required equipment, you can control your connected mobile phone or another mobile device using the controls integrated in the vehicle. Picture and sound from your mobile phone can be output via the multimedia system. Certain information can also be transferred to your mobile phone. This includes, depending on the relevant type of integration, e.g. general vehicle information or position data. This allows optimal use of selected apps on the mobile phone, e.g. for using a navigation system or playing music. Active access to the vehicle data via the mobile phone does not take place. The type of subsequent data processing is determined by the provider of the relevant app being used. Whether and which settings you can configure for this depends on the app and the operating system on your mobile phone.

Use of online services

If your vehicle has a wireless network connection, this can be used to exchange data between your

vehicle, the surrounding area and other systems. You can connect to the wireless network via the send and receive unit in the vehicle or via your connected mobile devices (e.g. mobile phone). Online functions can be used via this wireless network connection.

These include online services and applications/apps that are available to you through Porsche or other providers.

For Porsche online services, the various functions are described at a suitable place (e.g. the Porsche Connect website) and the related data protection legislation information is provided. Personal data can be used for the provision of online services. The required data exchange takes place via a protected connection, e.g. with the Porsche IT systems set up for this purpose. Collection, processing and use of personal data beyond that required for the provision of services takes place exclusively on the basis of a legal authorisation or consent.

Usually, you can activate or deactivate the (often fee-based) services and functions and in some cases, even the entire data connection in the vehicle. Excluded from this are in particular functions and services required by law.

If the option exists to use the online services of other providers, these are the responsibility of and subject to the data protection policy and terms of usage of the relevant provider. Porsche has no influence on the data exchanged in these cases. Please therefore obtain information from the relevant service provider on the type, scope and purpose of such data collection and the use of personal data in the context of third-party services.

Storing data in the event data recorder (EDR)

Your vehicle is fitted with an event data recorder (EDR). The EDR is a data storage device that records vehicle status data in the event of a critical event, such as in an accident situation in particular. The EDR is used to determine the circumstances of such

an event and in particular, the behaviour of the vehicle systems.

Potentially relevant status data, such as the type of event, accelerator/brake pedal position, steering wheel angle, speed, number/position of fastened seat belts, transverse and lateral acceleration of the vehicle, mileage, fault memory content, a time stamp and the vehicle identification number (VIN), in particular, is recorded for this purpose. This data is continually stored in a ring memory, which is overwritten again and again at five-second intervals. The EDR does not capture audio, image and/or video recordings or position data.

If indicators of a critical event are registered, the current memory state of the EDR is stored in a log file, i.e. the five seconds before the triggering event plus 300 milliseconds afterwards. After storing data permanently in this way, the EDR returns to ring storage mode until another triggering event triggers further permanent storage of data. The event memory can permanently store up to six log files. These log files will be overwritten later by newer log files if necessary. However, log files that were stored as a result of airbag/seat-belt pretensioner activity are overwrite-protected because this indicates a particularly critical event, such as an accident. As soon as four such overwrite-protected log files are stored in the event memory, a message to this effect will be displayed on the instrument cluster in the vehicle.

A device for communicating with the diagnostic interface in the vehicle is required for reading out the log files that are stored permanently in the EDR. Such devices are available not just to the vehicle manufacturer and service centres, but also to law enforcement authorities and possibly to third parties, for example. However, some of the data stored in the log files can only be accessed by Dr. Ing. h.c. F. Porsche AG as the vehicle manufacturer. The log files stored in the EDR cannot be accessed remotely.

The data stored in the EDR is not intended as a means of identifying certain people. After reading out the data, however, it may be possible to assign the log files stored in the EDR to certain people, e.g. to the owner of the vehicle based on the VIN, or through a link to other findings from other sources. Before reading out the data, the owner of the vehicle is always responsible for processing the data stored in the EDR. After reading out the log files, the relevant user is responsible for processing them. If Dr. Ing. h.c. F. Porsche AG is given access to the log files stored in the EDR, it uses these particularly for the following purposes, if necessary: Analyses aimed at product improvement; correcting malfunctions, particularly in relation to product monitoring obligations and for resolving liability issues. Dr. Ing. h.c. F. Porsche AG will only use log files containing personal data and/or pass these on to a third party if authorised to do so in accordance with data protection legislation. If law enforcement authorities, courts or other third parties are given access to the log files stored in the EDR, they use these particularly for the following purposes, if necessary: Clarification of facts relating to an accident; correction of causes of accidents in the vehicle; documentary evidence of the fact that the vehicle was not involved in an accident; (accident-related) research.

Please note that using and reading out the EDR may be subject to local legal requirements, which can include access rights to the log files stored in the EDR.

Overview Illustrations

On the following pages, you will find overview illustrations of all areas of the vehicle, with a brief explanation. Further information can be found on the relevant page.

- Sensors and cameras

A	Surround View	▷	p. 176
B	Active Lane Keeping	▷	p. 30
	Lane Keep Assist	▷	p. 144
	Intersection Assist	▷	p. 136
	Dynamic high beam	▷	p. 147
	Porsche InnoDrive (PID)	▷	p. 199
	Traffic sign detection	▷	p. 247
	Warning and Brake Assist (WBA)	▷	p. 267
C	Active Lane Keeping	▷	p. 30
	Intersection Assist	▷	p. 136
	Warning and Brake Assist (WBA)	▷	p. 267
D	ParkAssist	▷	p. 176
E	Adaptive Cruise Control (ACC)	▷	p. 34
	Porsche InnoDrive (PID)	▷	p. 199
	Warning and Brake Assist (WBA)	▷	p. 267
F	Night View Assist	▷	p. 171
G	ParkAssist	▷	p. 176
H	Active Lane Keeping	▷	p. 30
	Lane Change Assist	▷	p. 139
	Intersection Assist	▷	p. 136
I	Opening the tailgate using foot movement	▷	p. 211

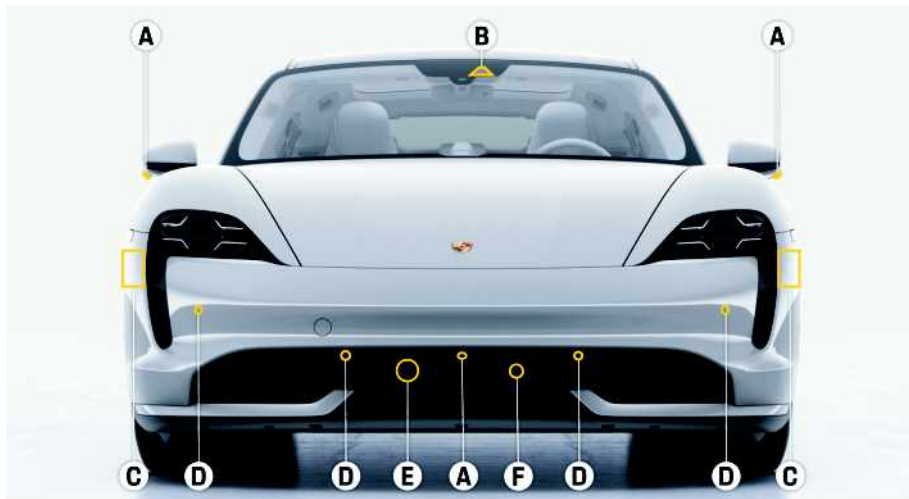

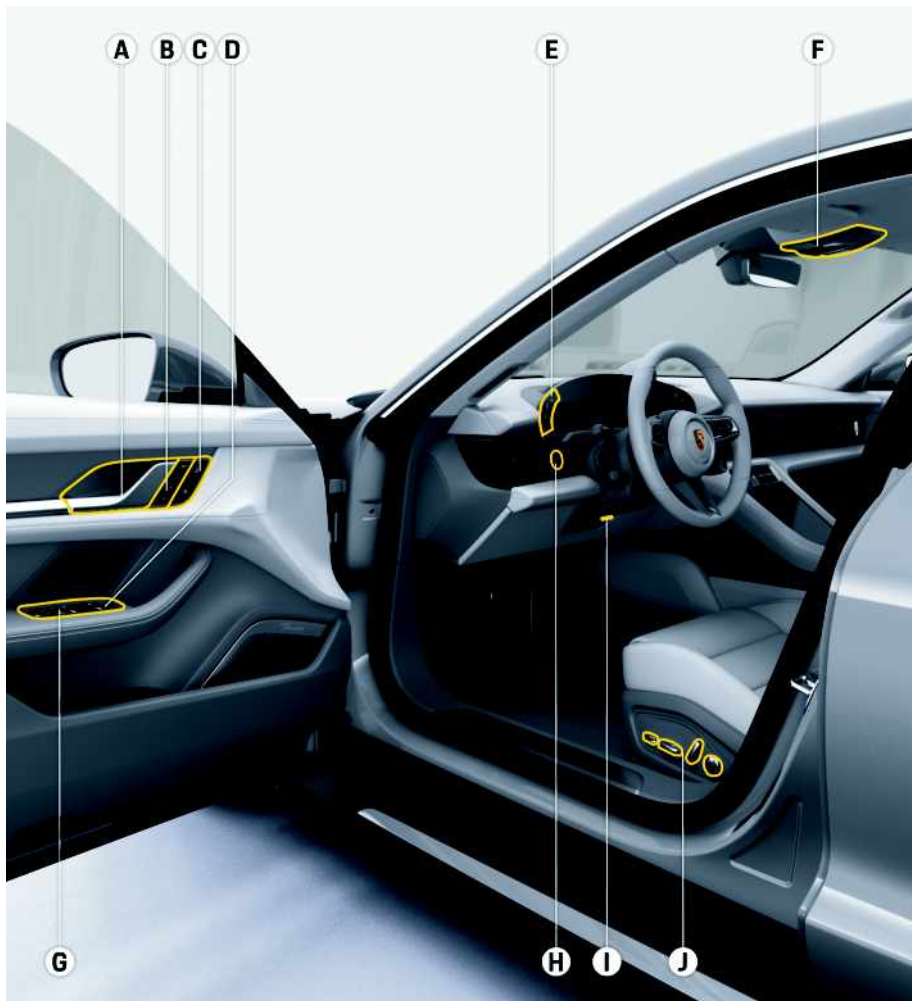

Driver's Cockpit

- A Door opener ▷ p. 69
- B Memory buttons ▷ p. 180
- Personal settings
- C Central locking buttons ▷ p. 69
- D Power windows ▷ p. 277
- E Light buttons ▷ p. 147
- F Overhead console ▷ p. 22
- G Exterior mirror adjustment ▷ p. 161
- H Power button ▷ p. 236
- I Steering wheel adjustment ▷ p. 241
- J Seat adjustment ▷ p. 223

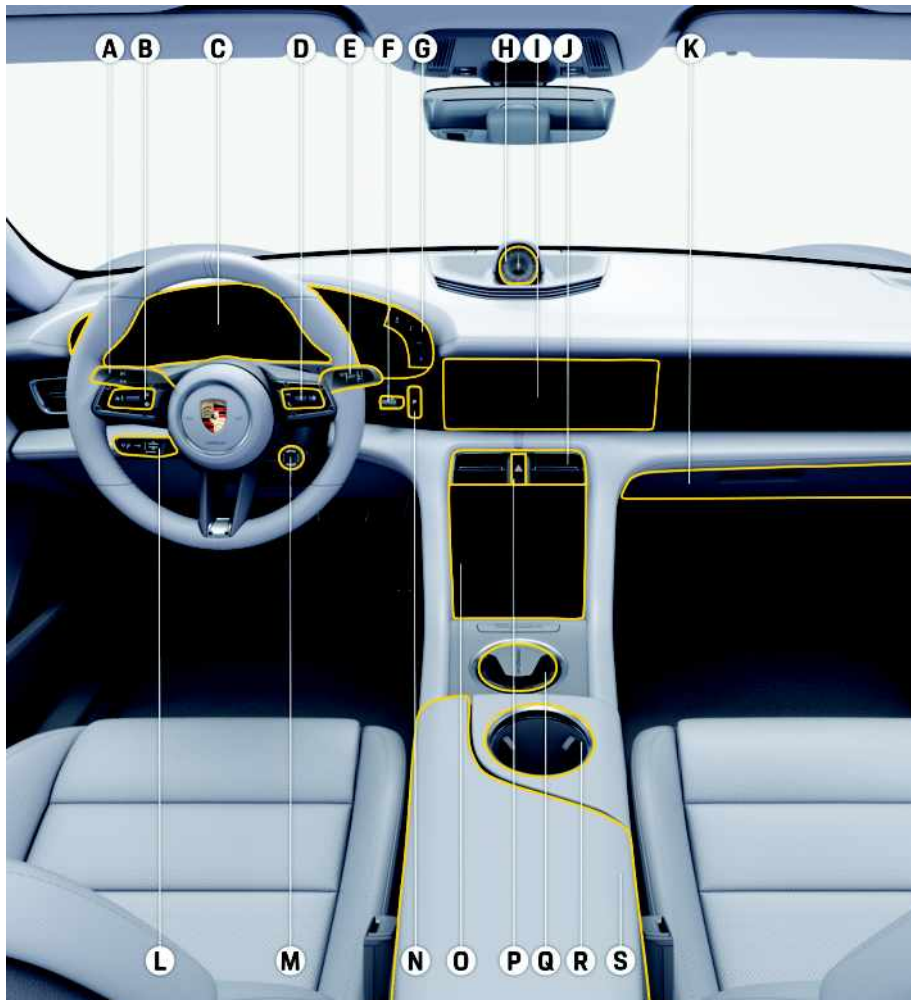

Cockpit

- A** Direction indicators and high beam ▷ p. 147
- B** Voice controls, infotainment, recuperation levels ▷ p. 125
- C** instrument cluster ▷ p. 125
- D** Phone controls, infotainment, instrument cluster ▷ p. 125
- E** windscreen wiper ▷ p. 279
- F** Gear selector ▷ p. 236
- G** Chassis and assistance settings
- H** Sport Chrono stopwatch ▷ p. 234
- I** Porsche Communication Management (PCM) ▷ p. 190
- J** Automatic air vents ▷ p. 42
- K** Glove box lock ▷ p. 243
- Airbag deactivation in the glove box ▷ p. 40
- L** Cruise control ▷ p. 98
- Adaptive Cruise Control (ACC) ▷ p. 34
- Porsche InnoDrive (PID) ▷ p. 199
- Lane Keep Assist ▷ p. 144
- Active Lane Keeping ▷ p. 30
- M** Mode switch ▷ p. 106
- N** Electric parking brake and parking lock ▷ p. 61
- O** Centre console control panel ▷ p. 76
- P** Hazard warning lights ▷ p. 147
- Q** Ashtray, drink holder ▷ p. 228
- R** Cupholder ▷ p. 100
- S** Armrest, storage compartment ▷ p. 243

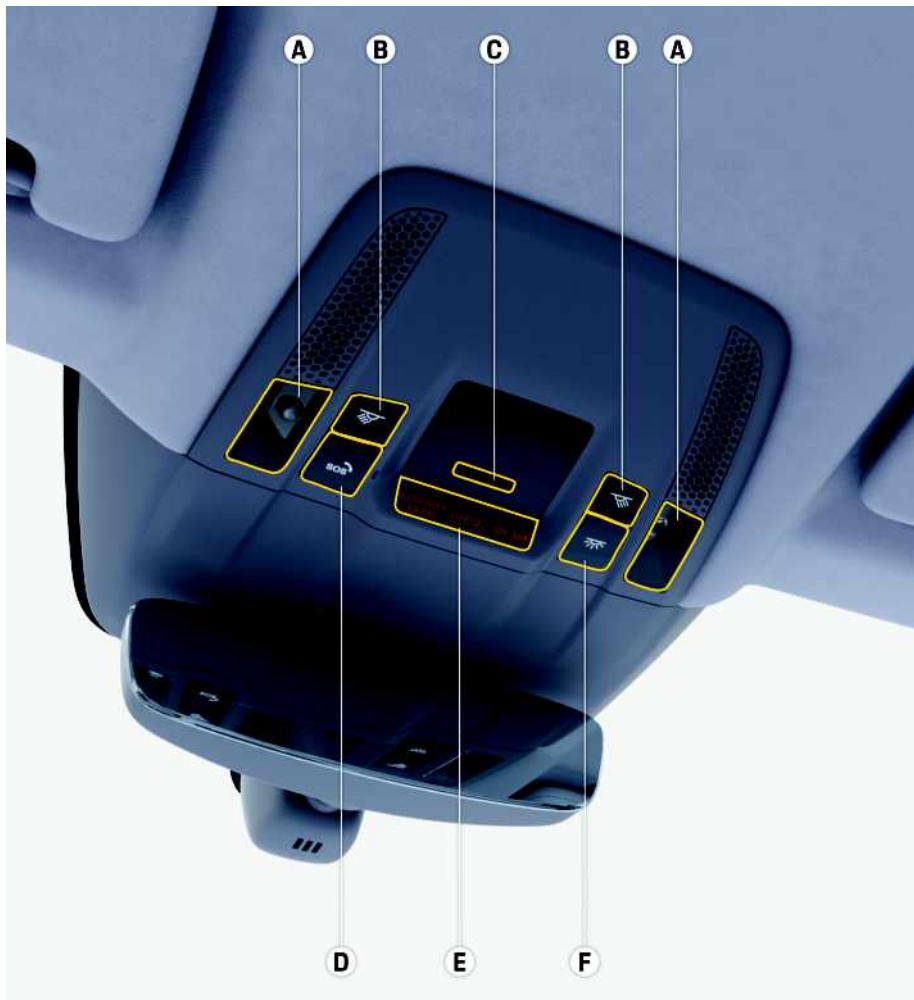

Overhead console

- A Reading lights ▷ p. 134
- B Button for interior/reading light ▷ p. 134
- C Interior light (lighting on the control panel) ▷ p. 134
- D SOS button ▷ p. 108
- E PASSENGER AIR BAG OFF/ON warning light ▷ p. 40
- F Button for interior light ▷ p. 134

Filler Openings

- A brake fluid
- B washer fluid

- ▷ p. 60
- ▷ p. 219

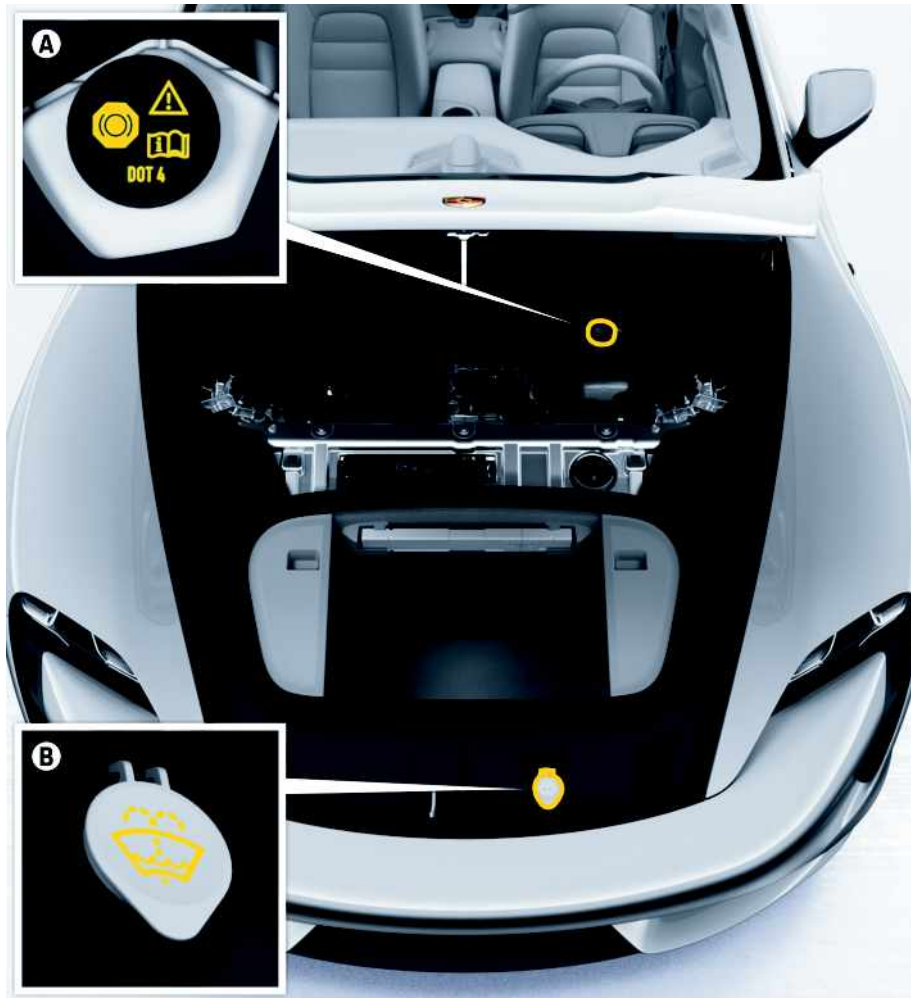

Your first trip

DANGER

Incorrect handling of the high-voltage system

The voltage in the high-voltage vehicle electrical system and high-voltage battery is extremely dangerous. Touching damaged high-voltage cables, the on-board charger, the high-voltage heater, the high-voltage battery, the power electronics or the A/C compressor can cause a fatal electric shock.

All components of the electrical system are marked with warning stickers. The high-voltage cables are orange.

- ▶ Do not perform any work on the high-voltage vehicle electrical system, orange high-voltage cables, on-board charger, high-voltage heater, high-voltage battery, power electronics or A/C compressor.
- ▶ Never damage, remove or disconnect the orange high-voltage cables from the high-voltage vehicle electrical system.
- ▶ Do not touch parts of the electrical system that have been damaged, such as following an accident.
- ▶ Never remove the high-voltage battery.

For further safety-relevant issues relating to electric vehicles:

- ▶ Please refer to chapter "Same Driving Pleasure, More Safety" on page 5.

Driving an electric vehicle

WARNING

Risks for people and objects

If the vehicle is not parked correctly, it can roll away uncontrolled, endangering people and objects.

- ▶ Before leaving the vehicle, activate the electric parking brake (P) and engage drive position P.

Driving an electric vehicle is like driving a vehicle with a combustion engine.

The main differences between the two drive types are as follows:

- The electric vehicle is powered by electric motors.
 - Regenerative braking is designed for energy recovery (recuperation) and increases the range of the vehicle.
 - The high-voltage battery must be charged using a suitable charger.
- ▶ Please refer to chapter "Charging high-voltage battery" on page 79.

Opening the vehicle

Depending on the equipment, the vehicle can be unlocked either with the driver's key or without a key using Comfort Access.

Once you open the vehicle, the vehicle is ready to drive.



Information

- ▶ Only use the driver's key when the vehicle is in your sight.

The doors of the vehicle can be unlocked using the driver's key by pressing the button.

With Comfort Access, the vehicle opens as soon as the driver's key is near the vehicle (depending on the country and equipment).



Fig. 2: Unlocking doors with Comfort Access

For further information: Please refer to chapter "Central Locking" on page 69.

Drive positions

The brake pedal must be pressed while engaging the drive position.

When the electric vehicle is ready to drive, the drive positions and the engaged gear are displayed.

- ▶ Please refer to chapter "Drive positions" on page 236.

The following drive positions can be selected:



Fig. 3: Engaging the parking lock

- To drive forward, select drive position D.
- To interrupt the supply of energy to the vehicle's drivetrain, select drive position N.
- To drive in reverse, select drive position R.
- After you have parked the vehicle, select drive position P.

E-Sound in the electric vehicle



WARNING

Reduced driving noise in electric vehicles

Even when E-Sound is switched on in accordance with legal requirements, an electric vehicle produces very little driving noise, which means that other road users might not even hear it. There is therefore a risk of accidents, particularly in areas with traffic calming, while manoeuvring or parking.

- ▶ Be particularly alert while driving!

Electric vehicles are fitted with an E-Sound system. The synthesised E-Sound is a legal requirement and

is designed as an audible sound to warn pedestrians about the vehicle. The E-Sound system cannot be switched off because it is legally required.

- ✓ The vehicle drives at a speed of less than 20 km/h (12 mph).

Drive-away behaviour of the electric vehicle

The creep function allows the vehicle to drive away automatically from a standstill when the brake pedal is released if drive position D or R is selected.



Information

The vehicle moves (creeps) when the drive position is engaged. To prevent unintentional creeping, only release the brake when you want to drive away.

Charging the high-voltage battery



DANGER

Incorrect charging

An incorrect charging process, non-observance of the generally applicable safety precautions and improper handling of the high-voltage battery can cause electric shocks, short circuits, explosions, fire or burns.

- ▶ Before starting the vehicle, remove the vehicle charging cable, close the cover and charge port door and store the vehicle charging cable in a safe place.
- ▶ Always observe the specified sequence when charging the high-voltage battery. Do not unplug the vehicle charging cable from the electrical socket during the charging process. Finish charging before disconnecting the vehicle

charging cable from the electrical socket.

- ▶ Observe the safety notes in the instructions for the Porsche charging equipment.
- ▶ Do not work in or on the vehicle during the charging process.
- ▶ Never charge the vehicle at both charge ports at the same time.



DANGER

Unsuitable or damaged electrical sockets and vehicle charging cables

The use of unsuitable or damaged electrical sockets and vehicle charging cables and improper handling of the high-voltage battery can cause electric shocks, short circuits, explosions, fire or burns.

- ▶ Only use vehicle charging cables that have been tested and approved by the manufacturer for charging the high-voltage battery in an electric vehicle.
- ▶ Always carry along the charging equipment that is suitable for the country you are driving in.
- ▶ Only connect vehicle charging cables to electrical sockets that were installed professionally.
- ▶ Do not connect vehicle charging cables to damaged or dirty electrical sockets.
- ▶ Do not use a damaged vehicle charging cable.
- ▶ Do not use extension cables, cable reels, multiple sockets or travel adapters.
- ▶ Do not modify or repair any of the electrical components.
- ▶ Protect electrical sockets and plug connections from water, moisture and other fluids and liquids.
- ▶ Do not use sharp-edged or pointed objects to remove dirt, ice and snow from the charging socket.
- ▶ Never insert objects into the charge port on the vehicle.

⚠ WARNING

Unsecured vehicle charging cable

An unsecured, incorrectly secured or incorrectly positioned vehicle charging cable can slip out of place and endanger the vehicle occupants during braking or direction changes or in the event of an accident.

- ▶ Never transport the vehicle charging cable in the passenger compartment (e.g. on or in front of the seats) or unsecured.
- ▶ Always store the vehicle charging cable in the charge bag in the boot or in the storage compartment provided for transporting it in the boot.

NOTICE

Risk of damage to the charging equipment and vehicle from overvoltages in the power supply.

- ▶ Do not charge the high-voltage battery via the vehicle charge port during a thunderstorm.
- ▶ If possible, disconnect charging equipment from the mains power supply during a thunderstorm.

Porsche recommends that you use the charging equipment supplied and approved by Porsche for charging. The high-voltage battery can be charged using the charging dock or the basic wall mount.

The high-voltage battery can be charged using either alternating current (AC) or direct current (DC).

- The high-voltage battery can be charged using alternating current (AC) at domestic and industrial electrical outlets or at public E-charging stations.
- Rapid charging of the battery is possible at public E-charging stations with direct current (DC). This shortens the charging time significantly.

The vehicle has either a manual or electric charge port door, depending on the equipment.

- ▶ Please refer to chapter "Charging high-voltage battery" on page 79.

The Porsche Charging Service can be used via the Porsche Connect app in some countries.

i Information

You will find more information about Porsche Connect functions (help videos, Porsche Connect operating instructions and questions & answers) at www.porsche.com/connect and in the "Good to know" app (availability dependent on country).

i Information

- The Porsche Connect services (except for the Safety and Security services) offer a free, inclusive period, which varies in length for each service package and country, but is always at least 3 months. More information about the free, inclusive periods and subsequent costs along with information about the availability of individual services for your country is available online at www.porsche.com/connect or from your Porsche partner.
- The Porsche Connect services can be used via the embedded SIM card.
- You may incur additional charges when receiving data packages from the Internet, depending on your mobile phone tariff and whether you are abroad. A flat-rate data plan is recommended.
- The availability, scope and provider of the services may vary depending on the country, model year, device and tariff.

Range and charging schedule



Fig. 4: Range display

The range of the electric vehicle is shown in the following displays:

- The instrument cluster.
- The central display.

i Information

When route guidance is active, the navigation system can show information about the route in the route monitor (e.g. traffic jam or charging stations).

The following factors can affect the range of the electric vehicle:

- The current charge state of the high-voltage battery.
- The current driving style.
- The current temperature of the high-voltage battery; for example, the range may be reduced at lower temperatures.

- The properties of the route, including hills and speed limits.
- The energy consumption of vehicle functions that are currently switched on.
- ▷ Please refer to chapter "Air Conditioning System Advanced Climate Control (2-/4-Zone Climate Control)" on page 42.

Increasing the range potential of the electric vehicle

Note the following points for improving the range:

- Anticipatory driving and recuperative braking can increase energy recovery.
- Do not carry unnecessary objects in the vehicle. Too much weight in the vehicle reduces energy savings.
- Driving with the windows closed reduces the vehicle's drag.
- Check that the tyre pressure is correct. The right tyre pressure reduces the vehicle's rolling resistance.
- Limited use of vehicle functions increases energy savings.
- ▷ Please refer to chapter "Tyres and Wheels" on page 249.
- ▷ Please refer to chapter "Air Conditioning System Advanced Climate Control (2-/4-Zone Climate Control)" on page 42.

Recuperation with the electric vehicle



WARNING

Unsuitable use of recuperation

Recuperation is a system that is used only for energy recovery. It is not a driver assistance system and

cannot take over any driver assistance system tasks.

- ▶ Do not use the deceleration effect of recuperation as a distance control system.
- ▶ Always be ready to brake and stay a safe distance away from the vehicle in front.
- ▶ For greater braking power or for braking the vehicle to a standstill, press the brake pedal as required.



WARNING

Automatic overrun recuperation limited or not available

The maximum overrun recuperation is limited.

The detection capability of the sensors can be impaired due to being dirty, bad weather conditions (rain, snow, ice, fog, spray) and unfavourable road conditions (loose gravel, reflective objects). Vehicles up ahead may not be adequately detected or may not be detected at all.

If automatic overrun recuperation (**Auto** setting) is not available, such as if sensors are dirty, a message to this effect will appear in the instrument cluster.

- ▶ Do not use automatic overrun recuperation in conditions of poor visibility and bad road conditions.

The recuperation mode can be set using the instrument cluster in the vehicle.

- ▷ Please refer to chapter "instrument cluster" on page 125.
- Recuperation occurs when the accelerator pedal is released while driving.
- Depending on the recuperation mode, the electric motor brakes the vehicle when the accelerator pedal is released. Feeding energy back (recuperation) into the high-voltage battery increases the range of the vehicle.

- The amount of recuperated energy increases to a maximum when the brake pedal is pressed. A higher braking response is achieved using the vehicle's wheel brakes.
- The maximum amount of regenerated energy can be temporarily reduced in certain situations. For example, when the high-voltage battery is fully charged or when the vehicle is driven in very high or low ambient temperatures.
- If the regenerative braking ability is reduced, a message to this effect will appear in the central display.

The standard regenerative braking level that occurs when the accelerator pedal is released can be configured between a low and high setting.

- ▷ Please refer to chapter "Energy recovery (recuperation)" on page 237.

In tube 2 on the instrument cluster, the Power meter shows the current amount of energy regenerated.

- ▷ Please refer to chapter "instrument cluster" on page 125.

The total amount of regenerated energy for the current trip and the regenerated energy for previous journeys or trips can be displayed in the central display.

- ▷ Please refer to chapter "Porsche Communication Management (PCM)" on page 190.

Setting the Advanced Climate Control air-conditioning system

NOTICE

Risk of damage to the air vents.

- ▶ Do not fasten objects (e.g. mobile phone cradles, plug-in air fresheners) to the air vents.
- ▶ Do not impede the electrical adjustment of the air vents (e.g. by blocking the slats).

The front air vents in the dashboard can be adjusted using the touch control panel in the centre console. As an optional feature, the rear air vents are adjusted using the rear control panel.



Fig. 5: Air-conditioning control panels

- ▷ Please refer to chapter "Air Conditioning System Advanced Climate Control (2-/4-Zone Climate Control)" on page 42.

Leaving and locking the vehicle

When you leave the vehicle and take the driver's key with you, the vehicle is locked automatically and switches off completely. If the Power button is pressed for longer than 3 seconds, the vehicle is switched off manually.

For more information: Please refer to chapter "Central Locking" on page 69.

Topics

On the following pages you will find topics listed in alphabetical order.

Active Lane Keeping

General safety instructions

WARNING

Lack of attention

Active Lane Keeping is designed for use on motorways and well-surfaced country roads only. The increased comfort offered by Active Lane Keeping should not induce you to risk your safety. Responsibility for staying in lane and correctly assessing the traffic situation always lies with the driver. The following situations may arise:

- In the event of heavy braking, corrective steering interventions may fail to take place.
- Supporting steering interventions may be reduced or not take place at all during active steering by the driver.
- The system cannot detect the entire surrounding area. Steering interventions may fail to take place.
- The system cannot interpret the surrounding area correctly. Unwanted steering interventions may occur.
- Steering interventions alone may not be sufficient to keep the vehicle in the driving lane due to lane grooves, winding roads, inclined road surfaces or crosswinds. The driver must actively steer in such situations.
- It is possible that the system will not function as expected in uncertain traffic situations such as turn-off lanes, motorway exits, construction sites or urban traffic. Steering interventions may fail to take place or may not make sense.
- It is possible that the system will remain active in unwanted or unexpected situations, or switch to passive mode unexpectedly.

- ▶ Keep your hands on the steering wheel at all times in order to always be ready to steer.
- ▶ Always be prepared to take over the driving tasks (accelerating or braking) yourself. If a warning message appears on the instrument cluster, take over control of the vehicle yourself immediately.
- ▶ Drive with extreme care.
- ▶ Always pay attention to the traffic situation and the area around the vehicle.
- ▶ Adapt your driving speed to road and weather conditions.

WARNING

Restricted environment monitoring

The environment monitored by the sensors (e.g. camera, radar, ultrasound) may be restricted by different influencing factors (e.g. rain, snow, ice, heavy water spray, oncoming headlights, dirt or damage). Steering interventions may fail to take place or unexpected steering interventions may occur as a result.

- ▶ Drive with extreme care.
- ▶ Always pay attention to the traffic situation and the area around the vehicle.
- ▶ Clean the front camera lens, front radar and ultrasound sensors regularly and keep them free of snow and ice.
- ▶ Do not cover the field of vision of the sensors.
- ▶ Check the windscreen for damage in the area of the camera lens at regular intervals.

WARNING

Unexpected system behaviour

In some situations, corrective steering intervention is not sufficient to keep the vehicle in the lane. Furthermore, the function can change from active to

passive at any time.

- ▶ Drive with extreme care.
- ▶ Always grip the steering wheel with both hands.

WARNING

System malfunction with a warning message

If a system fault occurs, Active Lane Keeping may switch off automatically. The status display disappears and a warning message appears on the instrument cluster.

- ▶ Drive with extreme care.
- ▶ Always grip the steering wheel with both hands.
- ▶ Always be prepared to take over the driving tasks (accelerating or braking) yourself.
- ▶ If a warning message appears on the instrument cluster, take over control of the vehicle yourself immediately.

System limitations

WARNING

Driving situations with risk of accidents

There are some driving situations in which the system cannot guarantee active lane guidance. There is therefore a risk of accidents when using the system! These include the following driving situations:

- when increased attention is required on the part of the driver
- during sporty driving
- in adverse weather conditions (e.g. fog, snow or heavy rain)
- in unfavourable road conditions (including poor or unclearly marked roads)
- in areas with roadworks
- when approaching humps and dips
- in urban traffic

- on winding and narrow country roads
- in uncertain traffic situations such as junctions or tollbooths
- off-road or on unpaved or slippery roads

The system does not always keep the vehicle in the centre of the lane or in a central position behind the last vehicle in the line.

Active Lane Keeping does not react to people and animals or vehicles crossing lanes or oncoming vehicles in the same lane. These are not detected as obstacles by the sensors.

- ▶ **Never** use Active Lane Keeping in the specified situations.
- ▶ Do not use Active Lane Keeping to steer the vehicle around obstacles lying on the road.

i Information

If there is a fault in the system or if Active Lane Keeping does not function as described in this section, do not use the assistance function. Visit a qualified specialist workshop. Porsche recommends a Porsche partner as they have trained workshop personnel and the necessary parts and tools.

Responding to warning messages

Always heed any warning and information messages displayed in the vehicle.

- ▶ Please refer to chapter "Warning and information messages" on page 271.

Operating principle

Active Lane Keeping uses the front camera as well as front and rear radar to continuously scan the area

around the vehicle and helps the driver to keep the vehicle in the selected lane.

- When the system is active, the driver can set a preferred position within the lane. When the driver keeps the vehicle at the desired position for several seconds, the system ends lane centre guidance and starts driving at the selected offset position. The shift in position is reset again when the system becomes passive or is switched off (e.g. by activating the direction indicator, changing lanes or braking).
- The system always prioritises the lane markings over other objects (e.g. vehicles). In some cases, this may mean that the driver has to position the vehicle in the centre of the lane in order to activate the system. Activation of the system outside the centre of the lane is prevented so that the driver does not feel a strong movement on the steering wheel immediately after the system is activated.
- The driver is responsible for moving to the side of the road to create a lane for emergency vehicles. In such situations, the driver can switch off the system or override it using the steering wheel.

Behaviour when the direction indicator is activated

Activating the direction indicator alerts the system to the driver's intention to change lanes. Active Lane Keeping therefore does not intervene in steering in this case.

Lane Change Assist, on the other hand, assists the driver when changing lanes by also activating the direction indicator.

- ▶ Please refer to chapter "Lane Change Assist (LCA)" on page 139.

Behaviour if there is no steering activity

The driver's steering behaviour is monitored when Active Lane Keeping is switched on and active. If there is no steering activity (e.g. hands not on the steering wheel or only resting lightly), a warning appears on the instrument cluster. The system prompts the driver to actively take over the steering. If the driver does not react to the takeover prompt, the system switches to passive mode. For vehicles with activated emergency stop function:¹ the vehicle can be slowed to a standstill.

Display elements









Fig. 6: Active Lane Keeping display

- A** Display of lane markings
- B** Active Lane Keeping status display

1. Available in some countries.

A
B
C
D
E
F
G
H
I
J
K
L
M
N
O
P
Q
R
S
T
U
V
W
X
Y
Z

Status display symbols

Symbol	Meaning
	Active Lane Keeping is switched off.
	Active Lane Keeping is switched on and passive.
	Active Lane Keeping is switched on and active.
	Active Lane Keeping and Lane Keep Assist are switched on and both are passive.
	Active Lane Keeping and Lane Keep Assist are switched on and both are active.
	Active Lane Keeping is active and Lane Keep Assist is passive.
	Active Lane Keeping is passive and Lane Keep Assist is active, e.g. when ACC status is "Ready".

Switching Active Lane Keeping on and off

Active Lane Keeping can only be activated when Adaptive Cruise Control (ACC) or Porsche InnoDrive (PID) is activated. Active Lane Keeping can be switched on and off when ACC or PID is activated. It can be selected or deselected using the control stalk, on the instrument cluster and on the central display.

Selecting and deselecting Active Lane Keeping

1. Press button **S** on the control stalk.
The options menu for the driver assistance systems appears on the instrument cluster.
2. Select **Active Lane Keeping** using the rotary knob on the steering wheel and press to confirm.

– or –



▶  ▶ Assistance ▶ Active Lane Keeping

Information

Active Lane Keeping can be deactivated at any time by pressing the brake or by steering to override it.

Additional information

Comparison of Lane Keep Assist and Active Lane Keeping

Position	Lane Keep Assist	Active Lane Guidance	Lane Keep Assist + Active Lane Keeping
Status icon			
Lane centre guidance	no	Yes	Yes
Lane departure warning	Yes	no	Yes
Steering intervention to prevent lane departure (lane edge guidance)	Yes	no	no
Speed range	approx. 65 - 250 km/h (40 - 156 mph)	approx. 0 - 210 km/h (0 - 130 mph)	See individual function
ACC dependence	no	Only in conjunction with active ACC	See individual function

Adaptive Cruise Control (ACC)

General safety instructions

WARNING Lack of attention

The increased comfort offered by the system should not induce you to risk your safety. The driver remains responsible when driving, such as by keeping a safe distance or driving at an appropriate speed, even when the system is activated. The system cannot replace the driver's attentiveness.

- ▶ Drive with extreme care.
- ▶ If the system-related deceleration is insufficient, slow the vehicle down immediately using the footbrake.
- ▶ Make sure that it is possible to take over control of the vehicle at all times.

WARNING Unsafe traffic situations and unfavourable road conditions

Use of the system may cause accidents if the current situation does not permit driving safely at an adequate distance from the vehicle in front and at a constant speed.

When driving in turn-off lanes, motorway exits or in areas with roadworks, the vehicle can accelerate to the set speed.

- ▶ Do not use the system in heavy traffic, where there are road works, in built-up areas, on private or field tracks, or in areas with traffic calming.
- ▶ Switch off the system temporarily when driving on turn-off lanes, motorway exits or in areas with roadworks.

WARNING Covered radar sensor

Covering the radar sensor can adversely affect or disable the function of the system.

- ▶ The radar sensor must always be kept free of dirt, ice and snow.



Fig. 7: Location of the radar sensor

WARNING Damage to the radar sensor

Shocks or damage to the bumper, wheel housings or underbody, e.g. through parking collisions, may move the sensors. This may impair performance of the Adaptive Cruise Control.

- ▶ Visit a qualified specialist workshop. Porsche recommends a Porsche partner as they have trained workshop personnel and the necessary parts and tools.

WARNING Foot placed on the accelerator pedal

The system does not brake automatically when the foot is placed on the accelerator pedal. Placing the foot on the accelerator may override cruise and distance control.

- ▶ When the system is activated, remove your foot from the accelerator pedal.

WARNING Inadequate braking power during automatic braking by the system

If the system detects that braking assistance is required on the part of the driver, a warning signal sounds and a warning symbol appears on the instrument cluster. In this case, the braking power of the system is not sufficient to prevent a collision.

- ▶ You must brake immediately in this case.

System limitations

WARNING Unfavourable road and weather conditions

Radar sensor vision can be impaired by rain, snow, ice, fog, loose gravel or spray. Vehicles in front will not be detected properly or may not be detected at all.

Reflective objects such as ice, heavy rain, crash barriers or tunnel entrances may impair the functionality of the radar sensor. A message indicating that the system is not available will appear on the instrument cluster.

- ▶ Do not use the system under such conditions.

⚠ WARNING

Undetected vehicles or objects

The radar sensor detects a narrow, cone-shaped area in front of your vehicle. As a result, vehicles or objects may not be detected in time or cannot be detected in the following situations:

- in the case of vehicles that change lanes or cut in
- in the case of vehicles with a small cross-section or narrow vehicles
- when driving into and out of bends
- in the case of stationary vehicles
- in the case of vehicles with large overhangs
- in the case of pedestrians, cyclists and animals
- in the case of objects on the road
- in the case of oncoming vehicles and cross traffic
- ▶ Take action and brake if necessary.
- ▶ Drive with extreme care and always pay attention to the traffic conditions and vehicle surroundings.

Vehicles changing lanes or cutting in and narrow vehicles

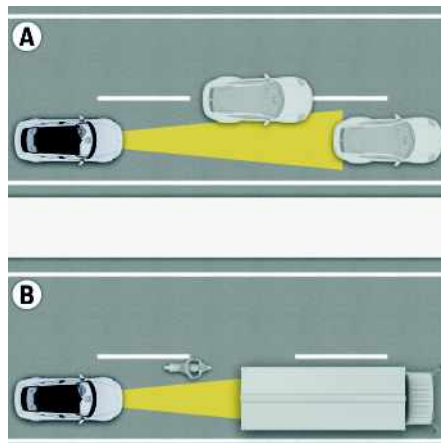

Fig. 8: Vehicles changing lanes or cutting in (A) and narrow vehicles (B)

A vehicle changing lanes or cutting in will not be detected until it is completely in the same lane. A narrow vehicle will not be detected or will be detected too late.

Cornering and stationary vehicles

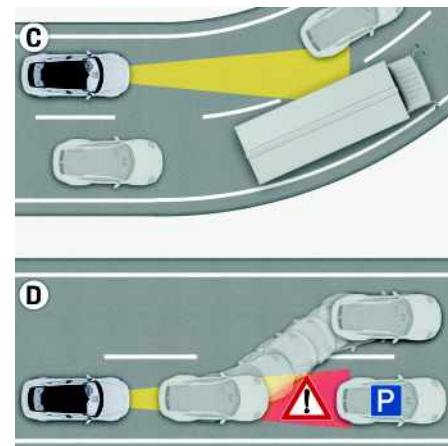

Fig. 9: Cornering (C) and stationary vehicles (D)

When driving into and out of bends, vehicles will not be detected or will be detected too late, or the system will react to vehicles in adjacent lanes.

A stationary vehicle or obstacle that appears suddenly in the detection field of the radar sensor, such as after a vehicle in front changes lanes or at the end of a traffic jam, can only be detected by Adaptive Cruise Control (ACC) to a limited extent.

Vehicles with large overhangs



Fig. 10: Vehicles with large overhangs

If there is a vehicle in front with a long overhang, such as a timber lorry, the radar sensor may not detect the end of the vehicle or may detect it incorrectly.

Responding to warning messages

Always heed any warning and information messages displayed in the vehicle.

▷ Please refer to chapter "Warning and information messages" on page 271.

Operating principle

Adaptive cruise control (ACC) operates between approx. 30 and 210 km/h (20 and 130 mph) to automatically maintain a selected speed and distance without you having to use the accelerator pedal.

If a vehicle travelling at less than the selected speed is detected in the same lane, ACC automatically maintains a specific distance. Adaptive cruise control applies the brakes if the distance to the vehicle ahead becomes too short, and it accelerates if the distance increases.

If the vehicle in front stops, ACC will slow down to a stop; it will automatically resume driving again if the vehicle in front starts moving again within 15 seconds. Otherwise, automatic speed control and distance control can be resumed by the driver.

The speed of the vehicle can be increased at any time by pressing the accelerator. The stored desired speed and distance are retained and restored after the accelerator pedal is released. The speed of the vehicle can be reduced at any time by braking. This will switch the system to passive operating condition.

Controls

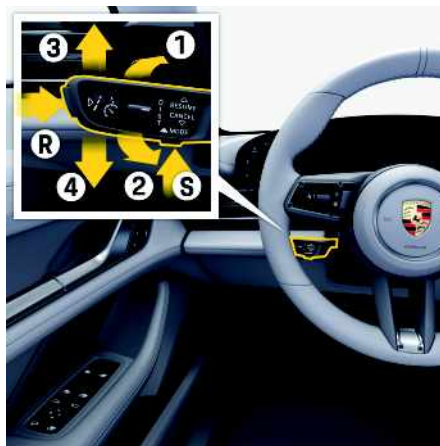

Fig. 11: Control stalk for driver assistance systems

- R** Switch systems on/off and open the options menu
- S** Open the options menu (when the system is switched on)
- 1** Set/increase the desired speed
- 2** Reduce the desired speed
- 3** RESUME: Resume control, adopt speed
- 4** CANCEL: Interrupt control

Display elements

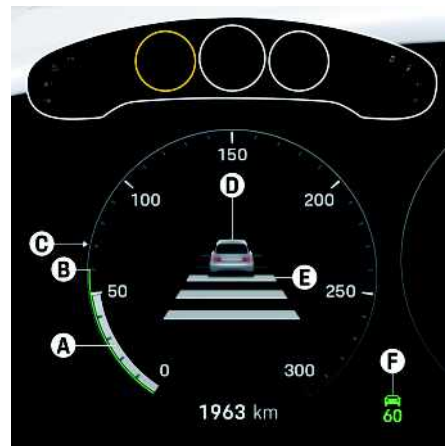





Fig. 12: ACC display

- A** Own speed
- B** Setting the desired speed
- C** Speed of vehicle in front
- D** Vehicle detected in front
- E** Desired distance from the vehicle in front
- F** Status display and desired speed

Status display symbols

Symbol	Meaning
	ACC is passive.
	ACC is passive at the set desired speed.

Symbol	Meaning
	ACC is active at the set desired speed.
	A vehicle was detected ahead while the desired speed was set. A vehicle symbol is displayed instead of the cruise control symbol.

Operating states

Passive

This mode is set after switching on and when ACC is active after pressing the brake pedal and after pressing down the control stalk (**CANCEL**).

- The status display **F** is grey.
- There is no control.
- The set desired speed and the set desired distance are retained.

Active

This mode is set after setting the speed, after resuming control (**RESUME**) and after temporarily overriding control by pressing the accelerator pedal.

- The status display **F** is green.
- Speed and distance to the vehicle ahead are controlled.

Temporarily passive

This mode is set while the accelerator pedal is pressed when ACC is active.

- A message indicating that ACC is passive appears in the instrument cluster.
- The status display **F** is grey.
- There is no control.

- The set desired speed and the set desired distance are retained.
- Control is active again after releasing the accelerator pedal.

Switch ACC on and off

The system that was selected last is always switched on. The system is initially in passive mode when switched on. It must first be activated before the control function starts working.

Switching the ACC on

- ✓ No driver assistance system has been switched on yet.

1. Press the **R** button on the control stalk.
The options menu for the driver assistance systems appears on the instrument cluster.
2. If ACC is not already selected, select **ACC** using the rotary knob on the steering wheel and press to confirm.

ACC is switched on and **passive**.

Switching from an already activated driver assistance system to ACC

1. Press the **S** button on the control stalk.
The options menu for the driver assistance systems appears on the instrument cluster.
2. Select **ACC** using the rotary knob on the steering wheel and press to confirm.

ACC is switched on and **passive**.

Information

The last selected driver assistance system is retained even after switching it off and operational readiness is restored.

Switching off ACC

- ▶ Press the **R** button on the control stalk.

The set desired speed is deleted.
The desired distance is stored.

Activating ACC

- ✓ ACC switched on.
1. Accelerate or decelerate to the desired speed using the accelerator pedal.
 2. Briefly press the control stalk forward (position **1**) and release the accelerator pedal.
ACC is **active**.

The current driving speed is set as the desired speed.

The current desired speed is green in the status display and is automatically maintained unless a slower vehicle is detected ahead.

Changing the desired speed

The set desired speed can be changed by pressing the control stalk.

- ✓ ACC is active.

Increasing the speed

- ▶ Press the control stalk forward (position **1**):
 - Brief press = 1 km/h (1 mph) increments
 - Press and hold = 10 km/h (6 mph) increments

Reducing the speed

- ▶ Pull the control stalk (position **2**):
 - Brief pull = 1 km/h (1 mph) increments
 - Pull and hold = 10 km/h (6 mph) increments

The set desired speed is indicated by the outer line at the edge of the speedometer and appears blue in the status display **F**. The display turns green as soon as the set desired speed is reached.

Changing the desired distance

The desired distance from the vehicle in front can be set in **5** stages. Stage **3** is recommended. The

distance depends on the driving speed. It reduces as the vehicle slows down and increases as it speeds up.



Fig. 13: Setting the desired distance

Increasing the desired distance

- ▶ Press rocker switch **Z** upwards.
Another segment is shown in desired distance display **E**.

Reducing the desired distance

- ▶ Press rocker switch **Z** downwards.
A segment disappears in desired distance display **E**.

i Information

When the system display is not active, pressing rocker switch **Z** for the first time displays the main menu for the driver assistance system without changing the desired distance.

Displaying the distance from the vehicle in front

The shorter the distance from vehicle in front **D**, the larger the vehicle displayed in area **E**. The longer the distance from vehicle in front **D**, the smaller the vehicle displayed in area **E**.

Symbol	Suitable for	Distance at 120 km/h (75 mph)
	Speedy driving in lines of traffic	approx. 33 m (± 1 sec.)
	Driving in stop-and-go traffic	approx. 47 m (± approx. 1.4 sec.)
	Corresponds to "two seconds time headway"	approx. 60 m (± approx. 1.8 sec.)
	Driving on country roads	approx. 73 m (± approx. 2.2 sec.)
	Driving in sparse traffic	approx. 87 m (± approx. 2.6 sec.)

Overriding speed and distance control temporarily

Speed and distance control can be overridden temporarily by pressing the accelerator pedal. This is useful while overtaking, for example.

- ✓ ACC is active.

1. Press the accelerator.

The system is **passive** while the accelerator pedal is pressed (operating status **temporarily passive**).

2. Take your foot off the accelerator pedal.
The system is **active**.

Interrupting and resuming speed and distance control

If the system is interrupted, it switches to passive standby mode and remains in standby until it is activated again manually.

Interrupting control

- ▶ Press the brake pedal.
– or –
- ▶ Press the control stalk down (**CANCEL**).
The system is **passive**. The desired speed and distance settings remain stored.
The status display changes from green to grey.

i Information

When the vehicle is stationary, the speed and distance control can only be cancelled using the control stalk.

Resuming control

- ▶ Tap the control stalk up (**RESUME**).
The system is **active**. The desired speed and distance settings are applied again.
The status display changes from grey to green.

i Information

ACC can be activated even while the vehicle is stationary by tilting the control stalk upwards.

Braking to a standstill and driving off again

If the vehicle in front stops, your vehicle will slow down and come to a stop within the control limits of the system if distance control is active.

Information

When distance control is active or while the vehicle is held, the brake pedal may feel different and you may hear hydraulic noises. This behaviour is normal for the system. It is not a fault.

Driving off again automatically



WARNING

Driving off when there is an obstacle

The vehicle may start driving again in stop-and-go traffic even if there is an obstacle between your vehicle and the vehicle in front. This can result in a collision.

- ▶ Brake immediately in this case.

After your vehicle is automatically braked to a standstill, the system assists the driver in driving off again automatically within 15 seconds.

A message on the instrument cluster informs the driver that the vehicle is ready to drive off.

Driving off manually

Several seconds after the vehicle is automatically braked to a standstill, the message indicating readiness to drive off disappears. The vehicle must then be driven off again manually.

Driving off manually when the system is active

- ✓ No obstructions detected in front.

- ▶ Press the control stalk up (**RESUME**).
– or –
- ▶ Press the accelerator pedal briefly.

Driving off manually when the system is passive

- ✓ No obstructions detected in front.
- ▶ Press the control stalk up (**RESUME**).

Airbag systems

**DANGER**

Incorrect seat position or incorrectly stowed load

Airbag systems can perform their safety function only if all occupants are wearing seat belts and are sitting in the correct position. Objects and luggage must be stowed safely.

- ▶ **Always fasten the seat belts.**
- ▶ Make sure that there are no persons, animals or objects between the driver or passengers and the area into which the airbag inflates.
- ▶ Always hold the steering wheel by the outer rim.
- ▶ For airbags to give effective protection, they must be a certain distance from the driver or passengers. Select a seat position that is not unnecessarily close to the airbags.
- ▶ Do not lean against the inside of the doors (airbag inflation area).
- ▶ Objects must not protrude out of the door storage compartments.
- ▶ Do not transport heavy objects on or in front of the seats.
- ▶ Do not place objects on top of the dashboard.
- ▶ Keep the glove box closed while driving.
- ▶ Always keep your feet in the footwell when driving. Do not put feet on the dashboard or the seat cushion.
- ▶ Share all the information in this section with your passengers.

Function of the airbag system

In conjunction with the seat belts, the airbags are a safety system designed to provide the vehicle occupants with maximum protection from injury in an accident.

Airbags protect the head, pelvis and upper body, while simultaneously damping the motion of the driver and passengers in the impact direction in the event of frontal impact or side impact.

The **front airbags** are installed under the padded steering wheel on the driver's side and in the dashboard on the passenger's side.

The **side airbags** on the front seats are located in the side of the seat side bolsters. The side airbags of the rear seats (depending on the equipment) are located in the side bolster.

The **head airbags** are located in the side roof frame.

The **knee airbags** for the driver and passenger are located below the dashboard.

Each of the airbags can trigger depending on the angle of impact and force of impact.

**DANGER**

No activation of already triggered airbag systems

Airbag systems can be triggered only once.

- ▶ Have triggered airbag systems replaced immediately.
- ▶ Visit a qualified specialist workshop. Porsche recommends a Porsche partner as they have trained workshop personnel and the necessary parts and tools.

**DANGER**

Malfunction due to airbags that have been tampered with

Airbag systems that have been tampered with offer no protection. They may either not trigger or be triggered in an uncontrolled manner. An airbag that triggers in an uncontrolled manner can cause serious

injuries.

- ▶ Do not modify the wiring or components of the airbag systems.
- ▶ Do not route any cables of additional electrical equipment in the vicinity of the airbag wiring harnesses.
- ▶ Do not attach any additional trims or stickers in the vicinity of the airbags.
- ▶ Do not use protective seat covers.
- ▶ Do not remove airbag components.

Recognising faults

Faults are indicated by the red airbag warning light  on the instrument cluster.

Consult a qualified specialist workshop in the following cases:

- The warning light does not come on when the vehicle is switched on.
or
- The warning light does not go off after readiness for operation has been established.
or
- The warning light comes on while driving.

Porsche recommends a Porsche partner as they have trained workshop personnel and the necessary parts and tools.

Switching off the passenger airbag



Fig. 14: PASSENGER AIR BAG OFF/ON indicator



DANGER

Passenger airbag switched off

The passenger airbag will not be triggered in an accident if it is switched off.

- ▶ Only switch off the passenger airbag if a child restraint system is fitted on the passenger seat.
- ▶ Switch the passenger airbag back on once the child restraint system has been removed.



DANGER

Failure or malfunction of the passenger airbag

If the **PASSENGER AIR BAG OFF** light does not come on when operational readiness is established and the passenger airbag is switched off, there may be a fault in the system.

- ▶ Do not install a child restraint system on the passenger seat.
- ▶ Visit a qualified specialist workshop. Porsche recommends a Porsche partner as they have trained workshop personnel and the necessary parts and tools.



Fig. 15: Switching off the passenger airbag

The passenger airbag is switched off using a key switch in the glove box, which is operated with the emergency key.

- ▶ Only switch off the passenger airbag if a child restraint system is fitted on the passenger seat.
- ▶ Please refer to chapter "Child Restraint Systems (Child Seats)" on page 87.

Air Conditioning System Advanced Climate Control (2-/4-Zone Climate Control)

Brief overview – Air conditioning system

Central display

The air-conditioning system can be operated using the central display, the centre console control panel and the rear display, depending on equipment.

The preconfigured automatic modes **Diffused** and **Focussed** provide fully automatic climate control.

This brief overview does not replace the comprehensive descriptions provided under "Air Conditioning System Advanced Climate Control (2-/4-Zone Climate Control)". Safety messages and warnings, in particular, are not replaced by this brief overview.

▷ Please refer to chapter "Porsche Communication Management (PCM)" on page 190.

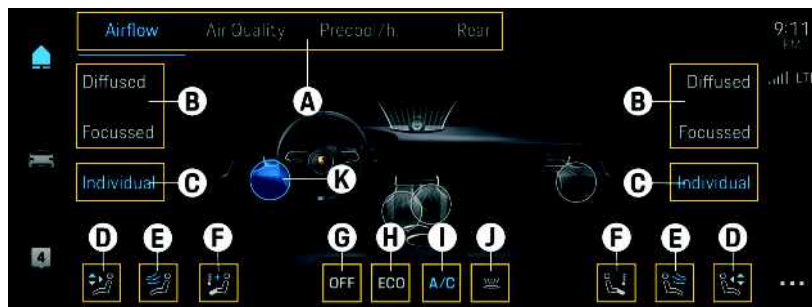

Fig. 16: Brief overview of the central display

What do I want to do?	What do I have to do?	Where?
Call up Air conditioning menu in the central display	<ul style="list-style-type: none"> – Central display: Touch ► Air conditioning – or – – Centre console control panel: Touch the Air conditioning softkey. 	–
Switch Air conditioning menu	Use menu area A .	–
Select preconfigured automatic modes	Select automatic mode (see B). <ul style="list-style-type: none"> – Diffused – Focussed 	▷ p. 46
Set Individual automatic mode	✓ C is selected.	▷ p. 46

What do I want to do?	What do I have to do?	Where?
	<ul style="list-style-type: none"> - Touch Adjust air distribution (see D). - Touch the required type of climate control (adjust strength of the air flow, see E). - Touch Adjust footwell temperature (see F). 	
Switch air conditioning on and off in the entire vehicle	Touch G .	▷ p. 46
Switch Eco mode on and off	Touch H .	▷ p. 49
Switch cooling function on and off	Touch I .	▷ p. 48
Switch upper ventilation panel on and off	✓ C is selected. Touch J .	▷ p. 47
Change air flow direction	✓ C is selected. Touch K and move the selected air vent.	▷ p. 46

Centre console control panel

- ▷ Please refer to chapter "Centre console control panel" on page 76.

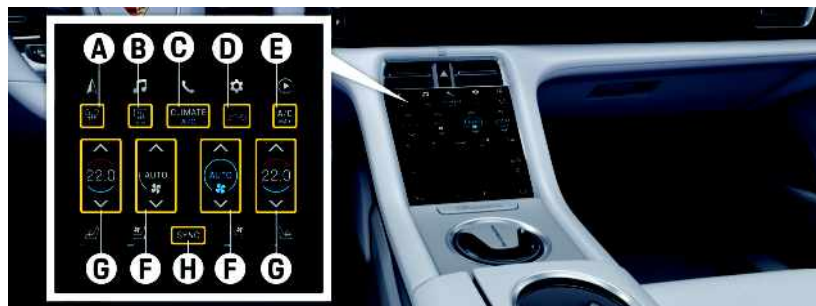





Fig. 17: Brief overview of centre console control panel

A
B
C
D
E
F
G
H
I
J
K
L
M
N
O
P
Q
R
S
T
U
V
W
X
Y
Z

A	What do I want to do?	What do I have to do?	Where?
B	Defrost windscreen	Touch the A softkey.	▷ p. 51
C	Switch on heated rear window and exterior mirror heating	Touch the B softkey.	▷ p. 51
D	Show/hide Air conditioning menu in the central display	Touch the C softkey.	–
E	Switch air-recirculation mode on and off manually	Touch the D softkey.	▷ p. 50
F	Switch maximum cooling output on and off - A/C MAX mode	Touch the E softkey.	▷ p. 48
G	Switch on automatic mode	Tap the F softkey in the middle.	▷ p. 46
H	Set the temperature	Tap or swipe the G softkey up  (warmer) or down  (colder).	▷ p. 48
I	Set air quantity manually	Tap or swipe the F softkey up  (more) or down  (less).	▷ p. 48
J	Use air conditioning settings for the entire vehicle – SYNC mode	Touch the H softkey.	▷ p. 50

Rear passenger touch screen (depending on equipment)

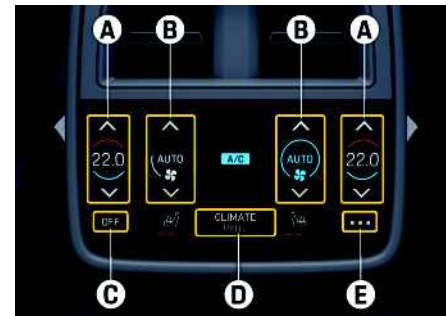

Fig. 18: Brief overview of rear passenger touch screen

What do I want to do?	What do I have to do?	Where?
Set the temperature	Tap A up ▲ (warmer) or down ▼ (colder).	▷ p. 48
Set air quantity manually	Tap B up ▲ (more) or down ▼ (less).	▷ p. 48
Switch rear air-conditioning system on and off	Touch C .	–
Adjust the air distribution	Touch D .	▷ p. 49
Call up settings	Touch E .	–

Air Conditioning System Advanced Climate Control (2-/4-Zone Climate Control)

Depending on factors such as the passenger compartment temperature, sunlight and air quality, the air-conditioning system adjusts the temperature, air

distribution and air quantity fully automatically in automatic mode.

Automatic mode is deactivated as soon as the settings for the function selected are adjusted manually. In this case, automatic climate control still regulates the functions that have not been modified manually.

The air-conditioning system can be operated using the central display, the centre console control panel and the rear display, depending on the equipment. The air conditioning system operates most effectively with the windows closed.

If heat accumulates in the passenger compartment:

- ▶ Briefly air the interior by opening the windows.

A
B
C
D
E
F
G
H
I
J
K
L
M
N
O
P
Q
R
S
T
U
V
W
X
Y
Z

Depending on the outside temperature and humidity, condensation may escape from under the vehicle. This is system-dependent and is not a defect. If the battery charge of the high-voltage battery is less than 10%, the air conditioning functions are initially restricted and then switched off.

The cooling function switches off automatically at temperatures below approx. 2 °C and cannot be switched on, even manually.

Setting the temperature temporarily to a lower or higher value does not cool or heat the passenger compartment to the desired temperature more quickly.

Enabling the intake of fresh air

- ▶ Keep the fresh-air intake between the wind-screen and the bonnet free from snow, ice and leaves.

2-zone climate control

The temperature, air flow, air distribution and type of climate control can be set individually for the **left** and **right** climate zones. The air vents in the rear can be opened and closed **manually**. The direction of the air flow can also be adjusted.



4-zone climate control

The temperature, air flow, air distribution and type of climate control can be set individually for the **front left**, **front right**, **rear left** and **rear right** climate zones. The footwell temperature can also be individually adjusted in the front zones.

Switching air conditioning on and off

Switching air conditioning on and off in the entire vehicle

Central display

- ▶  ▶ Air conditioning  ▶ Ventilation ▶ OFF
If the **OFF** notification appears on the centre console control panel and on the touch display in the rear, the outside air supply is interrupted and the air-conditioning system is switched off.

Reducing the air flow to the rear air-conditioned areas or switching the rear air conditioning system off does not improve passenger comfort in the front air-conditioned areas.



Switching on automatic mode

Selecting preconfigured automatic modes

There are two preconfigured automatic modes.

- **Diffused**: Draught-free setting with low air flow.
- **Focussed**: Stronger ventilation in the passenger compartment. The air flow is clearly noticeable.



Central display

1.  ▶ Air conditioning  ▶ Ventilation
2. Select the desired automatic mode for the relevant climate zone.

Configuring automatic mode Individual

- **Individual**: Temperature, air quantity and air distribution can be adjusted individually.

Central display

1.  ▶ Air conditioning  ▶ Ventilation ▶ Individual
2. Select the desired settings.

The front and rear climate zones can be switched to automatic mode independently of each another.

Centre console control panel

- ▶ Touch the  softkey for the required climate zone on the centre console control panel or on the rear passenger touch screen.
When automatic mode is active, the softkey lights up blue. Air flow and air distribution are automatically controlled.

The automatic system can be controlled manually if necessary. The manual setting is retained until you touch the relevant softkey again or until you touch the  softkey.

Adjusting front air vents

There are air vents on the dashboard and in the front and rear centre console. In the preconfigured automatic modes **Diffused** and **Focussed**, the opening of the air vents and the air flow direction are controlled automatically. In the automatic mode **Individual**, automatic control for each climate zone can be regulated manually in the central display as required.

NOTICE Risk of damage to the air vents.

- ▶ Do not fasten objects (e.g. mobile phone cradles, plug-in air fresheners) to the air vents.
- ▶ Do not impede the electrical adjustment of the air vents (e.g. by blocking the slats).

Opening and closing front air vents



Fig. 19: Opening and closing front air vents

Central display

1. ► **Air conditioning** ► **Ventilation** ► **Individual**

The adjustable air vents are shown by a white circle in the central display.

2. Select the desired air vent.
The slider for adjusting the air vent is displayed.
The selected air vent now turns blue.
3. Adjust the opening of the air vent using the slider.

Changing front air flow direction



Fig. 20: Changing front air flow direction

Central display

1. ► **Air conditioning** ► **Ventilation** ► **Individual**

The adjustable air vents are shown by a white circle in the central display.

2. Select the desired air vent.
The selected air vent now turns blue.
3. Adjust the air vane in the desired direction.

The air vents are automatically adjusted to the selected position by touching anywhere you want in the vehicle interior display.

Adjusting air distribution

Adjusting front air distribution

Central display

1. ► **Air conditioning** ► **Ventilation** ► **Individual** ►
2. Select the air distribution for the corresponding climate zone:



The air flows to the windscreen and to the side windows.



The air flows from the centre air vent and side vent.



The air flows to the footwell.

Switching the upper ventilation panel on and off



Fig. 21: Upper ventilation panel

The ventilation panel on top of the dashboard provides additional ventilation for the vehicle interior. The ventilation panel can be activated or deactivated separately in automatic mode **Individual**. The air-conditioning system adjusts the air flow automatically.

Central display

- ► **Air conditioning** ► **Ventilation** ► **Individual** ►

The icon turns blue when the function is switched on.

The upper ventilation panel is activated separately in the preconfigured automatic modes **Diffused** and **Focussed**.

Setting type of front climate control

The strength of the air flow can be individually adjusted relative to the overall interior temperature for the front climate zones.

Central display

1. ► Air conditioning ► Ventilation ► Individual ►

2. Select the type of climate control for the desired climate zone.

Setting footwell temperature (depending on equipment)

The footwell temperature can be individually adjusted relative to the overall interior temperature for the front climate zones.

Central display

1. ► Air conditioning ► Ventilation ► Individual ►

2. Select the desired footwell temperature for the relevant climate zone.

Switching the cooling function on and off

The cooling function cools and dries the air.

In automatic mode, the cooling function is always activated. The cooling output is automatically controlled.

Central display

► ► Air conditioning ► Ventilation ► A/C

When the function is switched on, the icon turns blue.

Switching maximum cooling output on and off - A/C MAX mode

In A/C MAX mode, the passenger compartment is cooled at maximum power.

Centre console control panel

- Touch the **A/C MAX** softkey. When A/C MAX mode is active, the softkey lights up blue. The air-conditioning system works at maximum cooling output.

Setting the temperature

The temperature can be adjusted to between 16 °C and 29.5 °C. Recommendation: 22 °C.

Setting the temperature temporarily to a lower or higher value does not cool or heat the passenger compartment to the desired temperature more quickly.



Fig. 22: Setting the front temperature



Fig. 23: Setting the rear temperature

Increasing and decreasing the temperature

Centre console control panel or touch display in the rear

- Tap or swipe the softkey of the respective climate zone up (warmer) or down (colder). The selected temperature is indicated in the display of the respective climate zone.

If **LO** or **HI** appears on the display, the system is operating at maximum cooling (LO) or heating (HI) power. Automatic mode is switched off.

Setting the air flow



Fig. 24: Setting the air flow in the front



Fig. 25: Setting the air flow in the rear

Increasing and decreasing the air flow

Centre console control panel or touch display in the rear

- ▶ Tap or swipe the softkey of the respective climate zone up (more) or down (less). The selected air flow is indicated in the display as a white circular arc. The longer the circular arc is, the more air flows into the passenger compartment.

Tapping the softkey switches back to automatic mode.

If the air flow has been reduced so much in all the climate zones that **OFF** appears on the air-conditioning displays, the outside-air supply will be interrupted and the air-conditioning system switched off.

Deactivating OFF mode in the rear from the front

With 4-zone air conditioning, **OFF** mode can be deactivated using the central display.

- ▶ Please refer to chapter "Setting rear climate zones from the front" on page 50.

The **SYNC** function does **not** deactivate **OFF** mode in the rear.

WARNING

Impaired vision with air flow OFF

The windows can mist up if the air flow setting is **OFF**.

- ▶ In order to increase the air flow again, tap the softkey up or switch on automatic mode again.

Setting air vents in rear (depending on equipment)

NOTICE

Risk of damage to the air vents.

- ▶ Do not fasten objects (e.g. mobile phone cradles, plug-in air fresheners) to the air vents.
- ▶ Do not impede the electrical adjustment of the air vents (e.g. by blocking the slats).

Opening and closing rear air vents

Touch display in rear

1. CLIMATE MENU

The adjustable air vents are shown by a white circle on the rear passenger touch screen.

2. Select the desired air vent.

The slider for adjusting the air vent is displayed. The selected air vent now turns blue.

3. Adjust the opening of the air vent using the slider.

Changing rear air flow direction

Touch display in rear

1. CLIMATE MENU

The adjustable air vents are shown by a white circle on the rear passenger touch screen.

2. Select the desired air vent.

The selected air vent now turns blue.

3. Adjust the air vent in the desired direction.

Setting air distribution in the rear (depending on the equipment)

Touch display in rear

1. A/C MENU

2. Select the air distribution for the relevant climate zone:



The air flows from the central vent.



The air flows to the footwell.

Setting climate control in the rear (depending on equipment)

The strength of the air flow can be individually adjusted relative to the overall interior temperature for the rear climate zones.

Touch display in rear

1. CLIMATE MENU

2. Select the type of climate control for the desired climate zone.

Switching Eco mode on and off

When Eco mode is switched on, the air-conditioning system operates particularly energy efficiently.

When the rear seat is unoccupied, the air conditioning in the rear is switched off. The level of comfort in the vehicle may be reduced in order to improve the

A
B
C
D
E
F
G
H
I
J
K
L
M
N
O
P
Q
R
S
T
U
V
W
X
Y
Z

range (e.g. the passenger compartment may take longer to heat up or cool down).
If the **Range** driving programme was selected, **ECO PLUS** mode can be switched on. Passenger compartment ventilation is active to a limited extent in **ECO PLUS** mode. All other air conditioning functions are significantly reduced or switched off and cannot be selected in order to optimise energy consumption. Selecting another function ends **ECO PLUS** mode and switches to **ECO** mode. The configured settings are retained. This does not affect the **Range** driving programme.

- ▶ Please refer to chapter "Driving mode" on page 106.
- ▶ Please refer to chapter "Charging Planner (available in some countries)" on page 169.

Central display

▶  ▶ Air conditioning  ▶ Ventilation ▶ ECO



Switching the ioniser on and off

✓ Vehicles with an ioniser.

In regions with poor air quality – such as in large cities – ionisation can help achieve better air quality in the passenger compartment.

Ionisation itself does not produce any odour.

Central display



▶  ▶ Air conditioning  ▶ Air quality 
When the function is switched on, the icon turns blue.

Switching automatic air-recirculation on and off

In automatic air-recirculation mode, the outside-air supply is automatically controlled depending on the

air quality. At outside temperatures below approx. 5 °C, air-recirculation mode is deactivated automatically to prevent the windows from misting.

Central display

▶  ▶ Air conditioning  ▶ Air quality 
When the function is switched on, the icon turns blue.

Switching air-recirculation mode on and off manually



WARNING

Impaired vision in manual air-recirculation mode

In extended manual air recirculation mode, the windows may mist up. As no fresh air is supplied, the driver can get tired and become less attentive.

- ▶ Do not switch on manual air-recirculation mode for an extended period.



Switching air-recirculation mode on manually

Centre console control panel

▶ Touch the  softkey.
When the function is switched on, the softkey lights up blue.

Switching air-recirculation mode off manually

Centre console control panel

▶ Touch the  softkey.
– or –
Touch the  softkey.

When the function is switched off, the  softkey lights up white.

Using air conditioning settings for entire vehicle – SYNC mode

Switching SYNC mode on and off on the centre console control panel

- ▶ Touch the **SYNC** softkey.
When SYNC mode is active, the **SYNC** softkey lights up blue. Only the **driver display** remains visible. The remaining climate zones are changed to the **driver's settings**.
Touch the **SYNC** softkey again to deactivate SYNC mode.

Recommended air-conditioning settings for lone drivers

- ▶ For maximum passenger compartment comfort, it is recommended that you activate SYNC mode via the centre console control panel.
SYNC lights up blue.



Storing air-conditioning settings

The selected air conditioning setting can be actively stored on the driver's key.

- ▶ Please refer to chapter "Personal settings" on page 180.

Setting rear climate zones from the front

With 4-zone climate control, the climate zones in the rear can be adjusted using the central display.

1.  ▶ Air conditioning  ▶ REAR
2. Adjusting the setting as required.

defrosting windscreen



Fig. 26: defrosting windscreen



Switching defrost mode on

- ▶ Touch the  softkey.
The softkey lights up orange.
The air flows to the windscreen and the front side windows.
The windscreen is demisted or defrosted as quickly as possible.

To achieve maximum defrosting efficiency, the air is directed exclusively to the windscreen.

4-zone air conditioning: The air conditioning control panel in the rear is disabled.

Switching defrost mode off

- ▶ Touch the  softkey.
– or –
Touch the  softkey.
When the function is switched off, the  softkey lights up white.

Switching the heated rear window and exterior mirror heating on and off



Fig. 27: Heated rear window / exterior mirror heating softkey

Switching on heated rear window and exterior mirror heating

- ▶ Touch the  softkey.
The softkey lights up orange.
Depending on the outside temperature, rear window and exterior mirror heating switches off automatically after approx. 5 to 20 minutes.

Switching off heated rear window and exterior mirror heating

- ▶ Touch the  softkey.
The softkey lights up white.

Using precool/heat timer and precooling/heating

- ✓ High-voltage battery is sufficiently charged (at least 25%).
- ✓ Vehicle switched off.

The Precool/heat function controls the air flow and air distribution automatically. The temperature can

be adjusted individually. To provide the greatest possible comfort, the vehicle intelligently controls precooling/heating as required in accordance with the outside temperatures. This is independent of whether precooling/heating was activated via a **Timer**, the driver's key, the Porsche Connect App or by selecting the **Precool/heat** function in the central display. Precooling/heating starts max. 60 minutes before the desired departure time.

The Precool/heat function enables climate control (depending on equipment) for:

- the passenger compartment
- the exterior mirrors
- the rear window
- the seats
- the steering wheel.

This occurs regardless of whether the vehicle plug is connected or not.

The available range is reduced when precooling/heating is switched on.

- ▶ Please refer to chapter "Charging high-voltage battery" on page 79.

Information



The exterior mirrors and rear window are automatically heated at low temperatures while the vehicle is charging or if a timer was set in order to de-ice the windows and mirror glass.

Precooling/heating can also be programmed and switched on using the Porsche Connect App.

- ▶ Please refer to chapter "Apps" on page 56.

Switching on precooling/heating

Central display

1.  ► **Air conditioning**  ► **Maintain temp.**
2. Touch **Precool/heat**.
3. Touch **On**.

Precooling/heating switches off automatically after 60 minutes at the latest when the vehicle is ready to drive or when the vehicle is stationary.

Centre console control panel



Fig. 28: Activating preconditioning

1. Touch the  softkey.
2. Touch the **A** softkey.



During preconditioning, the air conditioning settings of the last selected precool/heat timer are used automatically. If there is no precool/heat timer in the central display, the last used air conditioning settings for the air-conditioning system are adopted.

Information

The precool/heating power is reduced to the maximum charging power while charging. If preconditioning is started, the full precool/heating power is available irrespective of the charging power. During active charging with a very low charging power, preconditioning can cause the high-voltage battery to become discharged.

Switching off precooling/heating

Central display

1.  ► **Air conditioning**  ► **Maintain temp.**
2. Touch **Precool/heat**.
3. Touch **Off**.



This also stops precooling/heating, which was initiated by a precool/heat timer.

Programming and activating precooling/heating via a precool/heat timer

The interior temperature can be precooled/heated up to the departure time using the precool/preheat timer.

The timer can be set to start once (single timer) or at regular intervals (recurring timer).

Central display



1.  ► **Air conditioning**  ► **Maintain temp.**
2. Touch **Manage timers**.
3. Set the days or date and time of the desired departure time and activate the Timer entry.
4. Set the air conditioning zones, temperature and seat activation individually.

The selected Precool/heat function is maintained for up to 10 minutes after the set air conditioning period. The automatic mode can be adapted after operational readiness has been established.

- Please refer to chapter "Air Conditioning System Advanced Climate Control (2-/4-Zone Climate Control)" on page 42.

Deactivating the precool/heat timer



Central display

1.  ► **Air conditioning**  ► **Maintain temp.**
2. Touch **Manage timers**.
3. Deactivate the option.

This does not stop precooling/heating that has already started.



Setting precooling/heating individually

Setting air conditioning zones on the central display

1.  ► **Air conditioning**  ► **Maintain temp.**
2. **Air conditioning zones**
3. Activate the desired air conditioning settings.



The vehicle seats are heated or ventilated (depending on equipment). Depending on the outside temperature, the vehicle automatically controls the vehicle seat settings. If driver seat heating is active, the steering wheel will also be heated (depending on equipment).

Setting target temperature on the central display

1.  ► **Air conditioning**  ► **Maintain temp.**
2. Touch **Temperature**.
3. Set the temperature you want using the slider.

During precooling/heating, the vehicle regulates the interior temperature to the set target temperature.

Setting Precool/heat with remote unlocking on the central display

1.  ► Air conditioning  ► Maintain temp.
2. Activate **Precool/heat with remote unlocking**.
When you unlock the vehicle, 5-minute precooling/heating starts.

This function can be activated twice per stationary phase when unlocking the vehicle to prevent inadvertent activation.

Alarm System

Operating principle



The alarm system monitors the following alarm contacts:

- Alarm contacts in doors, front lid and boot lid
- Interior surveillance: Movement in the passenger compartment when the vehicle is locked, such as attempted theft by breaking a window
- Inclination sensor: Inclination of the vehicle (e.g. attempt to tow the vehicle)
- diagnostic socket

Switching the alarm system on and off

- ▶ The alarm system is activated after approx. 30 seconds when the vehicle is locked.
- ▶ The alarm system is deactivated when the vehicle is unlocked.

In addition, you can also use the central display to specify whether the passenger compartment monitoring system and inclination sensor should remain inactive when locking the vehicle.

- ▶  ▶ **Setting**  ▶ **Vehicle** ▶ **Vehicle locking system** ▶ **Interior surveillance**

Information

If you unlock the vehicle with the emergency key in the door lock, you must turn on the power button within 15 seconds of opening the door to prevent the alarm system from being triggered.

Depending on the country, the time until triggering of the alarm system may differ.

Switching off the alarm system if it is triggered

- ▶ Unlock the vehicle.
 - or –
- ▶ Press the power button and turn on the vehicle.

Deactivating interior surveillance and inclination sensor

If people or animals are remaining in the vehicle, the passenger compartment monitoring system and inclination sensor, together with SAFELOCK when locking the vehicle, can be deactivated (country-dependent).

- ▶ Please refer to chapter "Central Locking" on page 69.

Alarm system function indication

The locking condition is indicated by the indicator lights in the front doors flashing at different frequencies.

Alarm system is activated

The indicator lights flash rapidly when the vehicle is being locked, then flash in normal mode.

Alarm system is activated, interior surveillance and inclination sensor are switched off

The indicator lights flash rapidly while you are locking the vehicle, go out for 28 seconds and then flash in normal mode.

Faults in the central locking system and alarm system

During locking of the vehicle, the indicator lights flash rapidly, light up continuously for 28 seconds and then flash in normal mode.

Anti-theft protection

Before leaving the vehicle, always:

- ▶ Close the windows. This will also prevent a false alarm by the interior surveillance system.
- ▶ Activate the parking lock and the parking brake by pressing the **P** button on the selector lever.
- ▶ Close the glove box.
- ▶ Close all storage compartments.
- ▶ Remove valuables, car papers, phone and house keys from the vehicle.
- ▶ Close doors, bonnet and tailgate.
- ▶ Lock the vehicle.

Immobiliser

In every driver's key, there is a transponder (electronic component) with a stored code.

The immobiliser can only be deactivated and the vehicle rendered ready for operation with an authorised driver's key.

Apple CarPlay

Operating Apple CarPlay using Siri voice recognition

Starting Siri

- ✓ Siri has been enabled in the settings of the iPhone you are using.
- ✓ No phone call active.
- ✓ Park Assist not active.
- ✓ Voice control not active.



Fig. 29: Steering wheel with voice control button

1. Press and hold the  button on the steering wheel.
2. Say your desired voice command.

Ending Siri

- ✓ Siri active and waiting for a voice command.
- ▶ Press the  button on the steering wheel. A fading acoustic signal sounds.

For information on voice control:

- ▶ Please refer to chapter "voice control" on page 264.

A

Apps

Various apps are available for your vehicle, depending on the country (download from Apple App Store or GOOGLE® Play Store).



Setting and operating while driving

Setting and operating apps while driving may distract you from the traffic situation. You may lose control of the vehicle.

- ▶ Only use and manage apps when the vehicle is stationary.



Information

More information about Porsche Connect (help videos, Porsche Connect operating instructions and questions & answers) can be found at www.porsche.com/connect and in the "Good to know" app (availability dependent on country).

Porsche Connect App

Porsche Connect App provides for the networking of vehicle and mobile phone

Personal POIs (Points of Interest), destinations from the address book or calendar entries can be transferred to the PCM from the mobile phone. Depending on the country, music tracks can be accessed using the music streaming function if the necessary app has been installed and an account created.

Connecting Porsche Connect App to the PCM via WiFi and opening in the Zentralsdisplay

- ✓ Porsche Connect App is installed on your mobile phone (download from Apple App Store or GOOGLE® Play Store).
- ✓ Porsche Connect App started.

- ✓ WiFi enabled on the mobile phone.
- ✓ WiFi function enabled on the PCM.

1. ▶ **Devices** ▶ ▶ **WiFi settings** Touch ▶ **Allow internet access.**

2. Check the PCM WiFi access data: ▶ **Devices** ▶ **Connection assistant** ▶ **Connect with PCM hotspot.**

The PCM device name and WiFi password are shown on the central display.

3. Enter the displayed PCM WiFi access data in the WiFi settings on the device.

A connection to the PCM's wireless Internet access is established.

4. Touch ▶ **Apps** .

Available content of the Porsche Connect App is displayed.

Communication between vehicle and Porsche Connect App can be disabled.

- ▶ Please refer to chapter "Porsche Connect settings" on page 197.



Information

As the Porsche Connect App app can be used to access vehicle-specific data and other functions, we recommend that you protect this data to prevent unauthorised access by third parties. Use of the app may incur additional costs with your service provider since the data is transmitted via mobile communications networks.

Porsche "Good to know" app

The multi-media Driver's Manual is available for digital devices for vehicles from model year 2013 onwards in the "Good to know" app, which is available

in some countries. Following installation, the appropriate content package can be downloaded for the relevant vehicle.

Please refer to chapter "Driver's Manual - Digital" on page 3.

Charging app

The Charging app, together with the Porsche ID card, allows access to the Porsche Charging Service for fast and easy charging. The Porsche Charging Service allows you to use charging stations in many European countries – irrespective of the provider and with convenient invoicing through Porsche. More information is available at www.porsche.com/connect

Porsche 360+ app

With the Porsche 360+ app, the Porsche Lifestyle Assistant can be reached 24 hours a day, 365 days a year. You can ask lifestyle-related questions (e.g. find out about a newly opened trendy restaurant in your home town, get information about making a hair appointment or buying concert tickets).

Further information is available at www.porsche.com/connect

Porsche Road Trip app

The Porsche Road Trip app can be used to plan and book complete trips with all stopovers (for example, the best viewing points, restaurants and hotels along the route as part of the customised itinerary).

More information is available at www.porsche.com/connect

Bonnet

Unlocking and opening the bonnet

NOTICE

Risk of damage to the bonnet or windscreen wipers.

- ▶ Make sure that the windscreen wipers are not folded forwards when opening the bonnet.
- ▶ Always switch off windscreen wipers before opening the bonnet (wiper stalk in position **0**).

Unlocking the bonnet using the centre console control panel or central display

The bonnet can be unlocked using the lid screen on the centre console control panel or using the central display.

- ✓ Parking lock and parking brake are activated.

Centre console control panel



The bonnet is unlocked.

Central display

- ✓ Ready for operation.



The bonnet is unlocked.

Unlocking the bonnet with the driver's key



Fig. 30: Opening the bonnet with the driver's key

- ▶ Press the  button.
The bonnet and the vehicle doors are unlocked.

Unlocking bonnet with Comfort Access (keyless)



Fig. 31: Opening the bonnet with Comfort Access

- ✓ Vehicles with Comfort Access.
- ✓ Driver's key is located in the front area of the vehicle.
- ▶ Place your hand between the Porsche Crest and the number plate. Either move your hand in a forward and backward movement or make a swiping action.
The bonnet is unlocked.

Opening the bonnet

- ✓ Bonnet unlocked.



Fig. 32: Unlocking the bonnet

1. Lift the bonnet up slightly and release the safety latch (**arrow**).
2. Open the bonnet completely.

Closing the bonnet

1. Lower the bonnet and allow it to fall into the lock. Press the bonnet closed with the palm of your hand in the area of the lock.
2. Check that the bonnet has engaged correctly in the lock.

If the bonnet is not closed properly, a warning message appears on the instrument cluster when the vehicle is moving.

Perform emergency unlocking of the bonnet

In the event of a discharged 12V battery, the bonnet can only be unlocked using an external battery.

- ▷ Please refer to chapter "12-volt battery" on page 282.



Fig. 33: Emergency unlocking of the bonnet – connect positive pole

1. Use the emergency key to unlock the vehicle at the door lock. Please refer to chapter "Emergency unlocking and emergency locking of doors" on page 74.
2. Remove the plastic cover from the left-hand fuse box.
3. Pull out positive terminal **A** (red) in the fuse box.
4. Use the red jump lead to connect the positive terminal of the donor battery to the positive terminal **A** in the fuse box.

i Information

If the vehicle was locked, the alarm horn from the alarm system will sound when the negative terminal is connected.

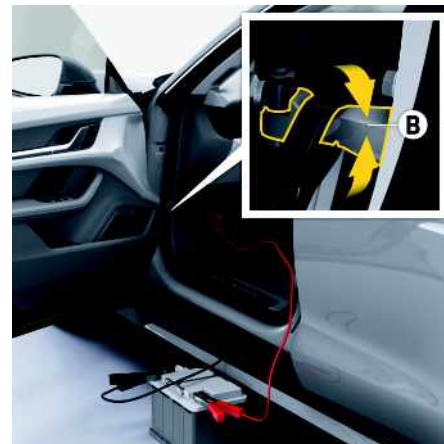



Fig. 34: Emergency unlocking of the bonnet – connect negative pole

5. Use the black jump lead to connect the negative terminal of the donor battery to the joint of the door arrester **B**.
6. Press the  button on the driver's key for approx. 2 seconds. The bonnet is unlocked and the alarm system is deactivated.
7. Disconnect the negative lead first, then the positive lead.
8. Push positive terminal **A** into the fuse box and fit the plastic fuse box cover.

Pedestrian protection

Sensors in the front bumper detect a collision with a pedestrian or similar object. The rear side of the bonnet then pops up to reduce the force of the impact.

**CAUTION**

Pedestrian protection
not triggered

Following a collision without triggering pedestrian protection, the system may be faulty.

- ▶ Have the pedestrian protection system checked, even if it was not triggered.
- ▶ Visit a qualified specialist workshop. Porsche recommends a Porsche partner as they have trained workshop personnel and the necessary parts and tools.

Closing the bonnet after pedestrian protection is triggered

If pedestrian protection is triggered, a message appears in the instrument cluster.

The bonnet cannot be pressed closed again after it has been triggered. The pedestrian protection components must be replaced.

1. Adapt your driving style to the situation.
2. Have the pedestrian protection system replaced immediately.
 - ▶ Visit a qualified specialist workshop. Porsche recommends a Porsche partner as they have trained workshop personnel and the necessary parts and tools.

Pedestrian protection system fault

A warning message appears on the instrument cluster in the event of a fault.

- ▶ Visit a qualified specialist workshop. Porsche recommends a Porsche partner as they have trained workshop personnel and the necessary parts and tools.

Brake Fluid

Responding to a warning message

If the brake fluid level is too low, the warning light  appears on the instrument cluster and a warning message is displayed. If the warning light comes on and the pedal travel is greater, this may also indicate a fault in the brake system.

- ▶ Stop as soon as it is safe to do so and do not continue driving.
- ▶ Visit a qualified specialist workshop. Porsche recommends a Porsche partner as they have trained workshop personnel and the necessary parts and tools.
- ▶ Please refer to chapter "Warning and information messages" on page 129.

Checking the brake fluid level



Fig. 35: Brake fluid reservoir

1. Remove the plastic cover in front luggage compartment.
 - ▶ Please refer to chapter "Installing and removing the plastic cover in the front luggage compartment" on page 155.
2. Read off the brake fluid level on the brake fluid reservoir. The fluid level must always be between the **MIN** and **MAX** markings.

Have the brake fluid topped up if the brake fluid level is below the **MIN** marking: Visit a qualified specialist workshop. Porsche recommends a Porsche partner as they have trained workshop personnel and the necessary parts and tools.
3. Install the plastic cover in front luggage compartment.
 - ▶ Please refer to chapter "Installing and removing the plastic cover in the front luggage compartment" on page 155.

Changing brake fluid

Regular checking and changing the brake fluid are part of servicing.

- ▶ Do **not** change the brake fluid yourself. Visit a qualified specialist workshop. Porsche recommends a Porsche partner as they have trained workshop personnel and the necessary parts and tools.
- ▶ Please refer to chapter "Driving on race circuits" on page 15.

Brakes

General safety instructions



WARNING

Blocked pedals

Unsuitable or improperly secured floor mats can restrict pedal travel or interfere with pedal operation. The accelerator pedal may be inadvertently actuated or the brake pedal blocked. This can result in an unexpected increase in speed or make braking more difficult.

- ▶ Only use floor mats that are suitable for the vehicle.
- ▶ Secure floor mats properly and do not place them loosely on the floor.
- ▶ Do not lay several floor mats on top of each other.
- ▶ Ensure that the floor mats are securely fitted again after they have been removed, such as for cleaning.



WARNING

No brake force boosting

The brake booster is ready for operation only while the engine is running. For this reason, much greater force has to be applied to the pedal when braking while the engine is switched off or if there is a defect in the brake booster.

- ▶ Vehicles with defective brakes must not be towed.



WARNING

Water film on brake discs

In heavy rain, when driving through water or after leaving a car wash, the braking action may be

delayed and increased foot pressure may be required.

- ▶ Check the brakes after washing the vehicle.
- ▶ For this reason, keep further back from the vehicle in front and "dry" the brakes by applying them at intervals. Make sure that the traffic behind you is not affected.



WARNING

Reduced braking action

After a long drive over salted or gritted roads, a coating may form on the brake discs and pads that significantly reduces friction and therefore the braking effect as well.

The brake discs will unavoidably start to corrode if your vehicle is parked for an extended period. The brakes will tend to "judder" as a result.

- ▶ If braking comfort is noticeably impaired: Go to a qualified specialist workshop. Porsche recommends a Porsche partner as they have trained workshop personnel and the necessary parts and tools.

For information on brake fluid and checking the brake fluid level:

- ▶ Please refer to chapter "Brake Fluid" on page 60.

Operating principle

Bedding in and cleaning the brakes

The vehicle has a braking recuperation system that feeds some of the braking energy back into the high-voltage battery. In order to bed in the wheel brake, the recuperation system is deactivated briefly on new vehicles or after changing the brake pads and this reduces the range. To assist in cleaning the brakes, the recuperation system is deactivated for a short time after standstill times of more than 6

hours. The recuperation system is activated again automatically afterwards.

Brake pads and brake discs

Wear on different components of the brake system (e.g. brake pads and brake discs) depends on the driving style and the conditions of use and cannot be expressed in actual miles on the road.

Certain speeds, braking forces and ambient conditions (e.g. temperature and humidity) can cause the brakes to squeal.

Porsche Ceramic Composite Brake (PCCB)

The values communicated by Porsche are based on normal operation adapted to the traffic situation. Wear increases considerably when the vehicle is driven on race tracks or as a result of aggressive driving.

- ▶ Before driving your vehicle in this way (e.g. on race circuits), ask your Porsche partner about currently applicable guidelines.

Porsche Surface Coated Brake (PSCB)

The brake disc friction surface of PSCB brakes has a specific look and cannot be compared with a standard brake disc. When a vehicle is driven normally according to the prevailing traffic situation, a shiny chrome-like friction surface covered with fine cracks appears. Wear, cracks and darkening of the shiny silver friction surface increase when the vehicle is driven in this way. These visual changes have no relevant effect on brake function and are partially diminished after driving several thousand kilometres.

- ▶ Before driving your vehicle in this way (e.g. on race circuits), ask your Porsche partner about currently applicable guidelines.

Activating the emergency braking function



Severe deceleration

Emergency braking takes place with very high braking power. The following traffic may be endangered and control over the vehicle may be lost.

- ▶ Only use the emergency braking function in an emergency situation.
- ▶ Do not use the emergency braking function to stop the vehicle when driving normally.

If the vehicle cannot be stopped by conventional braking, you can decelerate sharply and stop the vehicle using the electric parking brake.

- ▶ Press and hold the **P** button next to the selector lever.

The brake warning light  starts to flash.

To deactivate the emergency braking function:

- ▶ Release the **P** button.

Responding to warning messages

Brake pad wear limit

If the wear limit of the brake pads is reached, a warning symbol is displayed on the instrument cluster.

- ▷ Please refer to chapter "Warning and information messages" on page 271.
- ▶ Have brake pads replaced immediately. Visit a qualified specialist workshop. Porsche recommends a Porsche partner as they have trained workshop personnel and the necessary parts and tools.

Car Care

General care instructions



WARNING

Water film on brake discs

In heavy rain, when driving through water or after leaving a car wash, the braking action may be delayed and increased foot pressure may be required.

- ▶ Check the brakes after washing the vehicle.
- ▶ For this reason, keep further back from the vehicle in front and "dry" the brakes by applying them at intervals. Make sure that the traffic behind you is not affected.

Regular and expert care helps to maintain the value of your Porsche and can be a precondition for the upholding of claims under the vehicle warranty.

Porsche recommends car care products from Porsche Tequipment.

- ▶ Follow the instructions for use on the packaging of care products.
- ▶ Keep care products out of reach of children.
- ▶ Dispose of care products in accordance with regulations.

To ensure that the vehicle's condition is expertly checked and that the guarantee remains valid for the full period: Contact your Porsche partner. The dealer will prepare a condition report and will certify the level of care of the vehicle.

NOTICE

High-pressure cleaners and steam cleaners can damage the following components:

- Tyres
- Logos, emblems, decorative foils
- Painted surfaces

- Charge port
- Electrical components (e.g. high-voltage battery) and plug connections
- ParkAssist sensors
- (Radar) sensors of the Adaptive Cruise Control (ACC) and other assistance systems
- Cameras
- Windscreen wipers

No vehicle is absolutely leak-proof. Water may leak into the passenger compartment during cleaning.

- ▶ Always read the operating instructions provided by the equipment manufacturer.
- ▶ Always observe a minimum distance of 50 cm when cleaning. Being closer may trigger the tailgate release button and accidentally open the tailgate.
- ▶ Do not point the cleaning jet directly at any of the above-mentioned components.
- ▶ Never point the cleaning jet directly in openings. Cover the openings before washing.
- ▶ Do not use high-pressure cleaners or steam cleaners to clean decorative films.
- ▶ Never use high-pressure cleaners or steam cleaners with a round jet nozzle. A high-pressure cleaner or steam cleaner fitted with a round jet nozzle will damage your vehicle. The tyres are particularly susceptible to damage.

High-voltage battery care

General care instructions

The high-voltage battery is subjected to a physical and chemical ageing and wear process. This reduces the capacity of the high-voltage battery over its life cycle depending on the pattern of use and the environmental conditions, which reduces the maximum

possible range and increases charging times as the battery ages, among other things.

The following measures can be taken to reduce battery ageing and wear:

- ▶ If possible, avoid exposing the vehicle to temperatures of over 30 °C for long periods, e.g. as a result of parking it in direct sunlight.
- ▶ Ensure that the temperature of the vehicle is between approx. -20 °C and +30 °C during the charging process.
- ▶ If possible, begin charging the high-voltage battery via the Charging Planner and use the Timer or Profile function to charge the battery with alternating current (AC).
- ▶ Use the Timer or Profile function to program a maximum high-voltage battery charge of 85% for daily use of the vehicle without any long-distance driving.
- ▶ At ambient temperatures above 30 °C, connect the vehicle to the mains and charge the high-voltage battery with alternating current (AC). Use the Timer or Profile function.
- ▶ In ambient temperatures above 35 °C, avoid using "Range" drive mode immediately after charging with 150 kW direct current (DC) in order to maximise cooling of the high-voltage battery.

Notes on leaving the vehicle unused for long periods

For idle periods of two weeks or longer:

- ▶ Do not park the vehicle with a discharged high-voltage battery; connect it permanently to the mains supply instead.
- ▶ Make sure that the high-voltage battery is charged to between 20% and 50% throughout

- A the idle period. The Profile function can be used for this purpose, for example.
- B
- C ▶ Make sure that the ambient temperature is between 0 °C and 20 °C in the vehicle's location.

If it is not possible to connect the vehicle permanently to the mains supply:

- D ▶ Charge the high-voltage battery halfway (to a charge level of 50%) before parking the vehicle.
- E ▶ Check the charge level every three months and recharge if necessary so that the charge level does not drop below 20%.
- F ▶ Make sure that the ambient temperature is between 0 °C and 20 °C in the vehicle's location.
- G ▶ Avoid using the Porsche Connect smartphone app. Establishing a connection between the app and the vehicle activates the high-voltage system and therefore discharges the high-voltage and 12-volt batteries.

Washing the vehicle

The best protection for the vehicle against the damaging effects of the environment is frequent washing and preservation. The longer road salt, road dust, industrial dust, insect remains, bird excrement and tree exudations (e.g. resin, pollen) etc. are allowed to remain on the vehicle, the more harmful their effect. No vehicle is absolutely leak-proof.

Water may leak into the passenger compartment during cleaning.

Observe the following points in order to ensure that the vehicle is washed thoroughly without damaging the paintwork:

- ▶ The vehicle underbody should be washed thoroughly at the end of the gritting season at the latest.
- ▶ Wash the vehicle only at washing areas provided

- for this purpose to prevent soot, grease, oil and heavy metals from entering the environment.
- ▶ Do not wash the vehicle in direct sunlight or when the body is hot.
- ▶ If washing by hand, use a car shampoo, plenty of water and a soft sponge or washing brush.
- ▶ To start washing the vehicle, wet the paintwork thoroughly and rinse off heavy dirt.
- ▶ After washing the vehicle, rinse it thoroughly with water and rub it dry with chamois-leather. Do not use the same chamois for rubbing dry as you use for cleaning the windscreen and windows.

Cleaning in car washes

NOTICE

Optional add-on parts or parts that project beyond the contours of the vehicle may be damaged in car washes.

- ▶ Please consult the car wash operator before using automatic car washes.

Risk	What do you need to remember?
Windscreen wipers can start moving and become damaged in the car wash.	<ul style="list-style-type: none"> ▶ Switch windscreen wipers off. ▶ Do not operate headlight cleaning system in car washes.
Unintentional opening of the charge port door	<ul style="list-style-type: none"> ▶ Lock vehicle

Risk	What do you need to remember?
Damage to external parts	<ul style="list-style-type: none"> ▶ Fold in exterior mirrors. ▶ Retract an extended spoiler. ▶ Remove roof transport system completely. ▶ Close charge port doors. ▶ Lock the vehicle.
Damage to wheels	<ul style="list-style-type: none"> ▶ Check the dimensions of the car wash guide rail. The wider the rim and the lower the tyre height, the greater the risk of damage.
Scratches on high-gloss or silk-gloss wheels	<ul style="list-style-type: none"> ▶ Do not clean with the wheel-cleaning brushes in the car wash.

Caring for paintwork

NOTICE

Dust particles on painted surfaces can damage the paintwork if not properly dealt with.

- ▶ Do not rub dust with a dry cloth.

NOTICE

The matt effect of bodywork sections may be lost if not looked after properly.

- ▶ Do **not** use preservatives or polishes on components with a matt effect paint finish.

Preserving paintwork

The paint surface will dull over time due to weathering and should therefore be regularly protected with a paint preservative after washing the vehicle. This keeps the paint shiny and elastic, and prevents dirt from adhering to the paint surface and industrial dust from penetrating the paint.

Polishing paintwork

Paint polish should only be used to clean the paintwork when the original shine can no longer be obtained using preservatives.

Removing marks

Remove tar splatters, traces of oil, insects, etc. as soon as possible using an insect remover and wash the area carefully afterwards as they discolour the paint if left to work on it over time.

Repairing minor paint damage

Have minor paint damage (cracks, scratches or stone damage) repaired immediately before corrosion begins. Visit a qualified specialist workshop. Porsche recommends a Porsche partner as they have trained workshop personnel and the necessary parts and tools.

If traces of corrosion have already formed, these must be thoroughly removed. An anti-corrosion primer must then be applied to these spots, followed by top-coat paint.

Caring for wiper blades**NOTICE**

The graphite coating on the wiper blades can be damaged if they are not cleaned properly.

- ▶ Ensure that the cleaning jet does not hit the wiper blades.
- ▶ Do not clean wiper blades with a cloth or sponge.
- ▶ Clean wiper blades with clear water only.

Windscreen wiper blades that are in perfect condition are vital for a clear view.

- ▶ Clean the windscreen with window cleaner at regular intervals, especially after washing the vehicle in a car wash.
- ▶ If extremely dirty (e.g. due to insect residues), clean the windscreen using a sponge or cloth.

The wiper blades should be replaced twice a year (before and after the cold season) or if wiper performance deteriorates or the blades are damaged.

Cleaning windows**Cleaning the windscreen, side windows and rear window**

- ▶ Clean all windows regularly, inside and out, using a window cleaning agent.
- ▶ Do not dry the windows with the same chamois leather you use for the painted surface. Residue from preservatives could impair visibility.
- ▶ Remove insect residues with insect remover.

Cleaning the panoramic solid glass roof

- ▶ Dust off the window regularly on the inside using a clean, soft cloth.
- ▶ For stubborn dirt, clean the window with window cleaner, rinse with clean water and then dry using a clean, soft cloth.

Front side window coating

The front side windows have a water-repellent (hydrophobic) coating, which reduces soiling of the windows. This coating is subject to natural wear and can be renewed.

- ▶ Visit a qualified specialist workshop. Porsche recommends a Porsche partner as they have trained workshop personnel and the necessary parts and tools.

Repairing the underbody protection

The vehicle underbody is lastingly protected against chemical and mechanical effects. Damage to the protective coating while driving cannot be ruled out.

- ▶ Porsche recommends that you have the vehicle inspected at regular intervals by a qualified specialist workshop and the protective coating restored as necessary. Contact your Porsche partner.

Cleaning decorative films

NOTICE

Risk of damage through detachment of the decorative films during cleaning.

- ▶ Do not use polish or hot wax.
- ▶ Do not use high-pressure cleaning equipment or steam cleaners.
- ▶ Use a soft sponge, pH-neutral soap and plenty of water.

Cleaning headlights, lights, plastic components and surfaces, sensors and cameras

NOTICE

Cleaning agents can seep into the controls or switches, for example, and damage them. Unsuitable cleaning agents can damage the plastic surfaces.

- ▶ Do not spray water and interior window cleaner directly onto the interior plastic components.
- ▶ Clean headlights, lights, plastic components and surfaces, radar sensors for assistance systems and vehicle cameras using only clean water and a little washing-up liquid or window cleaning agent for interior windows. Use a soft sponge or a soft, lint-free cloth for this purpose.
- ▶ Clean the centre console with touch-sensitive buttons using a microfibre cloth only.
- ▶ Never use other chemical cleaners or solvents.

Care of wheels

WARNING

Cleaning agent film on brake discs

If cleaning agent (e.g. wheel cleaning agents) comes into contact with the brake discs, the film that forms on the brake discs may impair braking performance.

- ▶ Make sure that no cleaning agent comes into contact with the brake discs.
- ▶ If cleaning agent has come into contact with the brake discs, clean the brake discs thoroughly with a strong jet of water.
- ▶ Paying attention to any road users behind you, dry the brake discs by applying the brakes.

Metal particles (e.g. brass or copper in brake dust) must not remain too long on alloy wheels. Contact corrosion can cause pitting.

Cleaners with an oxide-removing effect or wrong pH value, as are commonly used for other metals, as well as mechanical tools and products, will damage the surface and are therefore unsuitable.

- ▶ Use only acid-free cleaners for alloy wheels (pH value between 4 and 10). Products with the wrong pH value can destroy the surface of the wheels.
- ▶ If possible, wash the wheels every two weeks with a sponge or washing brush. If the wheels are exposed to road salt, grit or industrial dust, weekly cleaning is necessary.

Cleaning door, cover, lid and window seals

NOTICE

Unsuitable cleaning and care products can damage the lubricant coating on the inner door seals.

- ▶ Do not use any chemical cleaning agents or solvents.
- ▶ Do not use any preservative agents.

To ensure proper cleaning of your vehicle, please observe the following:

- ▶ Wash dirt (e.g. abrasion, dust, road salt and grit) from all seals regularly using warm soapy water.
- ▶ If there is a risk of frost, protect the outer door seals and the lid and flap seals from freezing using a suitable care product.

Caring for leather

NOTICE

The leather may become damaged by the use of unsuitable cleaning agents and care products, and by inappropriate treatment.

- ▶ Do not use aggressive cleaners or hard cleaning objects.
- ▶ Ensure that perforated leather does not get wet on the reverse side.
- ▶ Remove water drops from the leather immediately.

To ensure proper cleaning and care of your vehicle, please observe the following:

- ▶ Clean all types of leather regularly to remove fine

dust using a soft, damp, white woollen cloth or a commercially available microfibre cloth.

- ▶ Remove heavy soiling (**not** water or moisture stains) with a leather cleaning agent. Read the instructions for use on the containers. Porsche recommends car care products from Porsche Tequipment.
- ▶ Treat cleaned leather only with a leather care product.

Cleaning seats with seat ventilation

Stains resulting from rainwater or moisture may occur on the perforated leather of the seats.

Removing water and moisture stains

- ✓ Seat heating and seat ventilation is switched off.
 - ✓ No direct sunlight.
1. Dab the entire seat and backrest surface using a clean, fine-pored sponge and distilled water. Make sure that the perforated leather does not get wet on its reverse side.
 2. Allow the seat cover to dry completely at room temperature out of direct sunlight. Do not switch on seat heating and seat ventilation.
 3. Once dry, wipe the seat cover with a dry, lint-free cloth.

Cleaning carpet and floor mats



WARNING

Blocked pedals

Unsuitable or improperly secured floor mats can restrict pedal travel or interfere with pedal operation. The accelerator pedal may be inadvertently actuated or the brake pedal blocked. This can result in an unexpected increase in speed or make braking more

difficult.

- ▶ Only use floor mats that are suitable for the vehicle.
- ▶ Secure floor mats properly and do not place them loosely on the floor.
- ▶ Do not lay several floor mats on top of each other.
- ▶ Ensure that the floor mats are securely fitted again after they have been removed, such as for cleaning.

To ensure proper cleaning of your vehicle, please observe the following:

- ▶ Clean using a vacuum cleaner or a brush that is not too soft.
- ▶ Remove heavy dirt and stains using a stain remover. Porsche recommends car care products from Porsche Tequipment.

To protect carpets, the Porsche range of accessories includes floor mats in the correct size and with the appropriate fasteners.

Cleaning airbag covers



DANGER

Improper cleaning

Unsuitable cleaning and care agents can penetrate into the airbag system. Improper handling can damage the airbag system. In the event of an accident, the airbag systems may not be triggered.

- ▶ Do not make any adjustments to individual components such as the steering wheel covers, the dashboard, the front seats and the door and ceiling panels.
- ▶ Do not use cleaning agents or other liquids in the area of the airbags.

Cleaning fabric linings

Fabric linings on pillars, roofliner, and sun blinds, etc. must only be cleaned using suitable cleaning agents, suitable dry foam and a soft brush.

Caring for Race-Tex

Never use leather care products to clean Race-Tex **microfibre covers**. For regular care, it is sufficient to clean the cover with a soft brush. Strong abrasion or rubbing when cleaning will create a lasting change to the surface.

- ▶ When lightly soiled, dampen a soft cloth with water or a pH neutral soap solution and wipe off the dirt.
- ▶ When heavily soiled, dampen a soft cloth with lukewarm water or thinned white spirit and dab off the dirt from the outside in.

Steering wheels with Race-Tex microfibre covers may be soiled more frequently due to the constant skin contact.

- ▶ When lightly soiled, wet a soft cloth with a pH neutral soap solution and wipe the outer steering wheel rim with this.
- ▶ When heavily soiled, the outer steering wheel rim can be cleaned by rubbing/dabbing it lightly with a soft cloth and a commercially available upholstery foam cleaner in accordance with the instructions provided by the foam manufacturer.

Cleaning seat belts

To ensure proper cleaning of your vehicle, please observe the following:

- ▶ Use mild detergent for soiled seat belts.
- ▶ When drying, avoid direct sunlight.
- ▶ Only use suitable cleaning agents.
- ▶ Do not dye or bleach seat belts. The belt fabric could be weakened, thus affecting safety.

Cleaning screens and touch displays

NOTICE

Unsuitable cleaning and care agents and incorrect treatment can damage screens and touch displays.

- ▶ Do not use solvents such as methylated spirits, thinner, petrol, acetone, alcohol (ethanol, methanol or isopropyl alcohol) or even scouring agents to clean the PCM.
- ▶ Do not spray cleaning agents or other liquids directly onto screens and touch displays. The electronics can be damaged irreparably if water leaks in. Instead dampen a cloth and wipe the screen carefully.

To ensure proper cleaning of your vehicle, please observe the following:

- ▶ Screens and touch displays are susceptible to scratching. From time to time, clean the screens and touch displays carefully with a dry, clean and soft cloth (microfibre cloth). Do not exert too much pressure on the surface while cleaning.
- ▶ Remove finger prints with a slightly damp cloth or a mild cleaning agent.

Laying up a vehicle

If the vehicle is to be laid up for an extended period of time: Contact your Porsche partner. They will be glad to give you information and advice about the necessary measures, e.g. corrosion prevention, care, maintenance and storage.

Central Locking

Brief overview: opening and locking doors from outside

This brief overview does not replace the complete information provided under "Central locking system". Safety messages and warnings, in particular, are not replaced by this brief overview.



Fig. 36: Driver's key

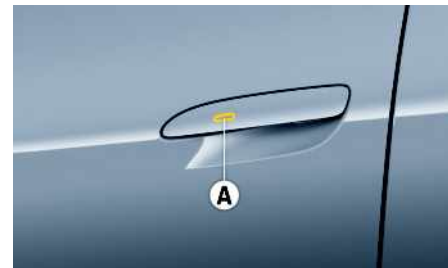





Fig. 37: Comfort Access

What do I want to do?	What do I have to do?	What happens?	Where?
Unlock	With driver's key: <ul style="list-style-type: none"> ▶ Press the  button on the driver's key. With Comfort Access: <ul style="list-style-type: none"> ▶ Grasp into the handle recess of the door handle. 	The hazard warning lights flash once. The door handles extend. The doors and tailgate can be opened.	▶ p. 71
Lock	With driver's key: <ul style="list-style-type: none"> ▶ Press the  button on the driver's key. With Comfort Access: <ul style="list-style-type: none"> ▶ Touch proximity sensor A on the door handle. 	The hazard warning lights flash twice. The door handles retract. The doors and boot are locked and cannot be opened from inside by pulling the door opener (SAFELOCK). The alarm system is triggered in the event of an attempt to open from the inside.	▶ p. 72

A
B
C
D
E
F
G
H
I
J
K
L
M
N
O
P
Q
R
S
T
U
V
W
X
Y
Z

What do I want to do?	What do I have to do?	What happens?	Where?
Lock if persons/animals are remaining in vehicle ▶ Switch off SAFELOCK and the alarm system's interior surveillance .	With driver's key: ▶ Press the  button on the driver's key twice (within approx. 2 seconds). With Comfort Access: ▶ Touch proximity sensor A on the door handle twice (within approx. 2 seconds).	The hazard warning lights will flash twice briefly and then once for a longer time. The door handles retract. The doors and tailgate are locked but can be opened from inside by pulling the door opener. The alarm is triggered if the door opener is pulled from the inside.	▶ p. 72
Switch off the alarm system's alarm sound	▶ Press the  button on the driver's key. – or – Press the power button to turn on the vehicle.	The alarm sound is switched off.	▶ p. 54

Using the central locking system

Depending on equipment, the vehicle can be unlocked and locked either with the driver's key or without a key using Comfort Access.

You can use the central display to specify whether only the driver's door or the entire vehicle should be unlocked when unlocking the vehicle.

All doors can be unlocked irrespective of the selected setting:

- ▶ Press the  button on the driver's key twice within 5 seconds.

Information

- ▶ Only use the driver's key when the vehicle is in your sight.

Information

The factory settings of the vehicle are described in this section.

Comfort Access¹



Vehicles with Comfort Access can be unlocked and locked without using the driver's key. However, the driver's key must always be carried, e.g. in your trouser pocket.

If the door handles are extremely dirty, the Comfort Access function may be impaired.

- ▶ Please refer to chapter "Car Care" on page 63.

Deactivating Comfort Access using the driver's key

To ensure that the vehicle cannot be unlocked and started by unauthorised third parties, the Comfort Access functions can be deactivated temporarily using the driver's key.

- ▶ Press the  button and the  button simultaneously and keep them pressed until the indicator light on the driver's key lights up continuously.

1. The Comfort Access system is state-of-the-art. We cannot, however, entirely rule out the possibility of the key codes for the radio keys being intercepted and used to open the vehicle and steal it.

Deactivation at the driver's key is confirmed when the indicator light on the driver's key lights up continuously.

The Comfort Access function is activated automatically when you press the buttons on the driver's key again.

- ▶ Do not expose the driver's key to a high level of electromagnetic radiation. Comfort Access may be impaired.

Unlocking doors

Unlocking the doors with the driver's key



Fig. 38: Unlocking the doors with the driver's key

1. Press the  button.
The hazard warning lights flash once.
The vehicle unlocks depending on the setting, and the door handles extend.
2. Pull the door handle.

Unlocking doors with proximity sensor in door handle



Fig. 39: Unlocking doors with Comfort Access

- ✓ Vehicles with Comfort Access.
 - ✓ Function activated.
 - ✓ Carry the driver's key with you, e.g. in your trouser pocket.
 - ✓ The doors can be unlocked on the side of the vehicle where the driver's key is located.
1. Grasp into the handle recess of the door handle. Do **not** touch the proximity sensor on the front of the door handle in the process.
The hazard warning lights flash once.
The vehicle unlocks depending on the setting, and the door handles extend.
 2. Pull the door handle.

i Information

To save the battery, unnecessary comfort functions are progressively switched off. The vehicle can then be unlocked using the driver's key.

Unlocking the doors when approaching the vehicle

- ✓ Vehicles with Comfort Access.
- ✓ Function activated.
- ✓ Carry the driver's key with you, e.g. in your trouser pocket.

The central locking can be configured such that the doors are automatically unlocked when you approach the vehicle (from a distance of approx. 2 m). The prerequisite for this is that the driver's key was at least approx. 6 m away from the vehicle after the last locking operation.

1. Approach the vehicle.
The hazard warning lights flash once.
The vehicle unlocks depending on the setting, and the door handles extend.
2. Grasp into the handle recess of the door handle. Do **not** touch the proximity sensor on the front of the door handle in the process.
3. Pull the door handle.

Unlocking doors from inside



Fig. 40: Central locking button in the door panel

- ▶ Press the  button in the door panel.
 - or –
 - Pull door opener.
- All doors and the tailgate are unlocked.** The door handles extend.
- The indicator light on the button goes out.

i Information

The doors cannot be opened from inside if the vehicle was locked with SAFELOCK activated or using the emergency key.

i Information

If the vehicle is de-energised, e.g. the high-voltage battery is flat, or if the door opener is pulled too quickly, the door opener may have to be activated twice.

- ▶ Release the door opener and pull again.

Unlocking the vehicle automatically

The vehicle is unlocked automatically when a door is opened.

i Information

- The door handles retract 45 seconds after the doors, bonnet and tailgate are closed. The vehicle remains unlocked.
- If the vehicle is unlocked and if a door, the bonnet or the tailgate is not opened within 45 seconds, the vehicle is locked again automatically.

i Information

In the event of an accident in which the airbag is triggered, the entire vehicle is unlocked automatically in order to enable helpers gain access to the vehicle. The hazard warning lights are also activated automatically.

Locking doors

Using SAFELOCK

 **WARNING** Locking the doors from outside

When you lock the doors from outside, ensure that no persons or animals are still in the vehicle as the

doors and windows cannot be opened from inside (SAFELOCK). Locked doors make it more difficult for helpers to access the inside of the vehicle in the case of an emergency.

- ▶ Make sure that no persons or animals are inside the vehicle when locking it.

SAFELOCK (country-dependent) is a component of the interior surveillance and disables the door openers and central locking button on the locked vehicle in order to make attempted break-ins more difficult. SAFELOCK activated: **Doors cannot be opened** from inside by pulling the door opener. The alarm system is triggered in the event of an attempt to open from the inside.

If persons or animals are remaining in the vehicle, deactivate SAFELOCK if the vehicle is locked.

Locking doors with the driver's key

- ✓ Parking lock and parking brake activated.
- ✓ All doors are closed.
- ▶ Press the  button once.
 - The hazard warning lights flash twice.
 - The door handles retract.

Deactivating SAFELOCK when the vehicle is locked

- ▶ Press the  button twice within 2 seconds.
 - The hazard warning lights will flash twice briefly and then once for a longer time.
 - The door handles retract.
 - The doors are locked, but can be opened from inside by pulling the door opener.
- ▶ Inform any persons remaining in the vehicle that the alarm system will be triggered if the door is opened.

i Information

The vehicle cannot be locked fully if the doors, bonnet or tailgate are not fully closed. A warning tone sounds and the hazard warning lights do not flash.

i Information

If the key is inside the vehicle when you lock it, the vehicle is unlocked again. Several warning tones sound and the vehicle flashes 4 times. The vehicle will only be locked if a door, the bonnet or the tailgate is not opened within approx. 45 seconds and can only be unlocked using a second key.

- ▶ Make sure that the driver's key is not left inside the vehicle when locking it.

Locking doors with proximity sensor in door handle

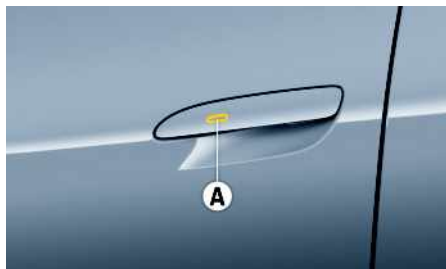

Fig. 41: Comfort Access

- ✓ Vehicles with Comfort Access.
- ✓ Parking lock and parking brake activated.
- ✓ Carry the driver's key with you, e.g. in your trouser pocket.
- ✓ All doors are closed.
- ▶ Touch proximity sensor **A** on the door handle. The hazard warning lights flash twice.

The door handles retract.

Deactivating SAFELOCK when the vehicle is locked

- ▶ Touch proximity sensor **A** on the door handle twice within 2 seconds. The hazard warning lights flash slowly once. The door handles retract. The doors are locked, but can be opened from inside by pulling the door opener.
- ▶ Inform any persons remaining in the vehicle that the alarm system will be triggered if the door is opened.

i Information

- The vehicle cannot be locked fully if the doors, bonnet or tailgate are not fully closed. A warning tone sounds and the hazard warning lights do not flash.
- The driver's key must be outside the vehicle when locking the vehicle doors, otherwise the vehicle doors cannot be locked.

Locking doors from inside



Fig. 42: Central locking button in the door panel

- ✓ Doors closed.
- ▶ Press the  button in the door panel. **All** doors and the tailgate are locked. The door handles retract. The indicator light on the button comes on. The doors can only be opened from inside by pulling the door opener.

Automatic locking

- ✓ Function activated. The vehicle is locked automatically from a speed of approx. 9 mph (15 km/h).

NOTICE

Extended door handles can be damaged in car washes.

- ▶ Lock the vehicle before starting the car wash.

Activating and deactivating child lock

The rear doors can be prevented from opening from inside. The child locks are activated in conjunction with child protection.

- ▶ Please refer to chapter "Disabling controls in the rear – child protection" on page 278.

A warning message appears on the instrument cluster in the event of a child lock fault.

- ▶ Please refer to chapter "instrument cluster" on page 125.

Setting up central locking



Settings for central locking behaviour can be adjusted via the central display.

Door unlocking (driver door only, side-selective, all doors)

- ▶  ▶  ▶ **Setting** ▶  ▶ **Vehicle** ▶ **Vehicle locking systems** ▶ **Door unlocking**

Unlocking the doors when approaching the vehicle

- ✓ Vehicles with Comfort Access.

- ▶  ▶  ▶ **Setting** ▶  ▶ **Vehicle** ▶ **Vehicle locking system** ▶ **Automatic unlocking when approaching**

Automatic locking of the vehicle from a speed of approx. 9 mph (15 km/h).

- ▶  ▶  ▶ **Setting** ▶  ▶ **Vehicle** ▶ **Vehicle locking systems** ▶ **Lock doors when driving**

Folding exterior mirrors in and out automatically

- ✓ Vehicles with electrically folding exterior mirrors in and out.

- ▶  ▶  ▶ **Setting** ▶  ▶ **Vehicle** ▶ **Vehicle locking system** ▶ **Fold in exterior mirrors when locking**

Emergency unlocking and emergency locking of doors

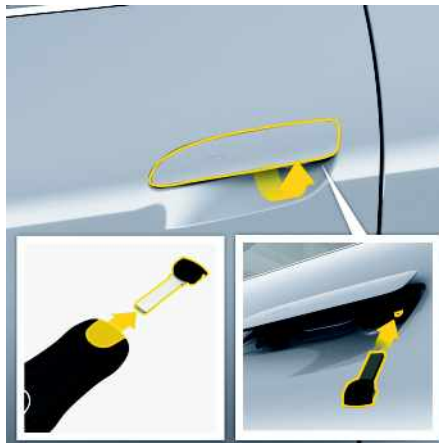



Fig. 43: Emergency unlocking/emergency locking

If the driver's key remote control does not work, the doors can also be unlocked and locked without the remote control. You must turn on the power button

within 15 seconds to prevent the alarm system from being triggered during an emergency release.

Performing emergency door unlocking

- ▶ Hold the driver's key at the top right of the rear window and press the  button at the same time.

If the vehicle still cannot be unlocked:

1. Remove the emergency key from the driver's key.
 - ▶ Please refer to chapter "Using the emergency key" on page 104.
2. Pull and hold the door handle on the driver's door.
3. Insert the emergency key with the round edge upwards into the door lock (right-hand drive: with the round edge facing downwards).
4. Turn the emergency key anti-clockwise until you feel initial resistance and then firmly turn it further as far as it will go.
5. Turn the emergency key back to its initial position again and remove it.
6. Pull the door handle from the closed position past the point at which there is tangible resistance.
 - Door can be opened.
7. You must press the power button to turn on the vehicle within 15 seconds to prevent the alarm system from being triggered.

Information

The time it takes to trigger the alarm system differs depending on the country.

Performing emergency door locking

i Information

Only emergency lock the doors when the engine has been switched off.

► Unlock the doors before starting to drive.

1. Remove the emergency key from the driver's key.
 - Please refer to chapter "Using the emergency key" on page 104.
2. Pull and hold the door handle on the driver's door.
3. Insert the emergency key with the round edge upwards into the door lock (right-hand drive: with the round edge facing downwards).
4. With the driver's door open, turn the emergency key clockwise until you feel initial resistance and then firmly turn it further as far as it will go.
5. Turn the emergency key back to its initial position again and remove it.
The door can be opened.
6. Close the driver's door.
7. Check that the vehicle is locked.

i Information

In the event of a central locking fault, all functional locks in the central locking system can be locked via the lock in the driver's door.

- Have faults in the central locking system repaired.
- Visit a qualified specialist workshop. Porsche recommends a Porsche partner as they have trained workshop personnel and the necessary parts and tools.

Performing emergency locking of the doors if the central locking system has failed

- ✓ Perform this procedure for the passenger's door and the rear doors.



Fig. 44: Performing emergency locking of the passenger's door

1. Open the door.
2. Unclip and remove cover.
3. Remove the emergency key from the driver's key.
4. Turn the lock outwards using the emergency key.
5. Refit the cover.
6. Pull and hold the door handle.
7. With the door open, turn the emergency key clockwise until you feel initial resistance and then firmly turn it further as far as it will go.
8. Turn the emergency key back to its initial position again and remove it.
9. Close the door.
10. Check that all doors are locked.
The doors can be opened from inside by pulling the door opener.

Centre console control panel

Brief overview of the centre console control panel

This brief overview does not replace the comprehensive descriptions. In particular, safety messages and warnings are not replaced by this brief overview.

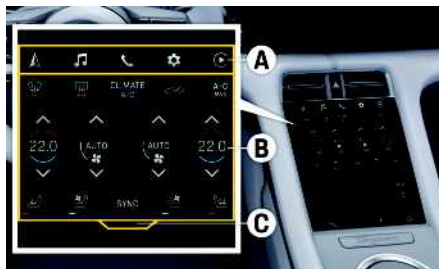

Fig. 45: Upper area of the centre console control panel

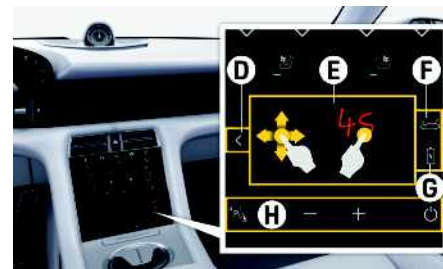











Fig. 46: Lower area of the centre console control panel

What do I want to do?	What do I have to do?	Where?
Showing and hiding the menu bar	<ul style="list-style-type: none"> ▶ To show and hide the menu bar (see A), swipe from top to bottom in the centre console control unit. – or – Tap  (see C). 	<p>–</p>
Displaying the quick filter (e.g. Navigation, Media, Phone, Settings, Apple CarPlay) on the centre display	<ul style="list-style-type: none"> ✓ Menu bar displayed. 1. Select the desired quick filter (e.g. Phone ) by tapping. <p>The selected quick filter is displayed in the central display.</p>	<p>–</p>
Operating the air-conditioning system	<ul style="list-style-type: none"> ▶ Using the control panels on the centre console control panel (see B). 	<p>▶ p. 42</p>
Navigating back	<ul style="list-style-type: none"> ▶ Tap the handwriting panel  (see D) to navigate back on the central display. 	<p>–</p>

What do I want to do?	What do I have to do?	Where?
Using the remote control	▶ Use the handwriting panel (see E) via gestures to navigate on the central display.	▶ p. 78
Entering text or characters	✓ The keyboard or input field is displayed on the central display. ▶ Write your desired text or characters in the handwriting panel (see E).	▶ p. 78
Displaying the lid screen	▶ Use F .	▶ p. 57 ▶ p. 211
Displaying charge screen	▶ Use G .	▶ p. 79
Adjust the volume	▶ Tap  /  in the quick access bar or swipe vertically with two fingers in the handwriting panel. Muting: by pressing and holding 	-
Displaying ParkAssist	▶ Tap  in the quick access bar (see H). ParkAssist is displayed on the central display.	▶ p. 176
Switching displays off or shutting PCM down	▶ Tap  in the quick access bar (see H). The following options are available on the central display: – Switching off the central display – Shutting down PCM	-
Configuring the centre console control panel	In the central display: ▶ Tap  ▶ Settings  ▶ Centre console control panel .	-

Using the centre console control panel

The central display can be controlled via the centre console control panel. The centre console keypad provides haptic feedback during operation.

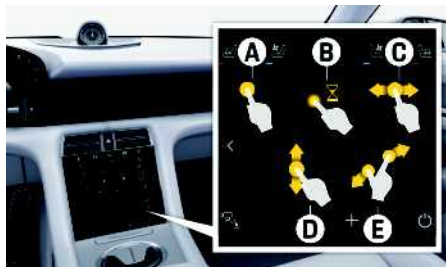

Fig. 47: Using the centre console control panel

A Touch (select)

Briefly touch the centre console control panel or handwriting panel using one finger. Example: Tap on a function or tick/untick a checkbox.

B Long press

Long-touch the centre console control panel or handwriting panel using one finger.

C Swipe

Swipe horizontally across the handwriting panel using one finger. Example: Scroll horizontally through lists in the central display.

D Vertical swiping (scroll and switch)

Swipe vertically across the handwriting panel using one finger. Example: Scroll vertically through lists in the central display.

E Zoom

Move two fingers further apart on the handwriting panel to enlarge a section of the map view in the central display.

Entering characters



Fig. 48: Freehand entry

✓ The keyboard or input field is displayed on the central display.

1. Write the desired text or characters directly with your finger (handwriting recognition).
 - To enter a space, swipe your finger from left to right (for menu languages written right to left, note the writing direction).
 - To delete a space, swipe your finger from

right to left (for menu languages written right to left, note the writing direction).

2. Confirm the entry with **K** in the centre console control panel and jump to the list of results.
3. The cursor can now be moved freely using remote control via the centre console control panel in the central display. You can select a result or other functions.

Charging high-voltage battery

Charging the high-voltage battery

**DANGER**

Incorrect charging

An incorrect charging process, non-observance of the generally applicable safety precautions and improper handling of the high-voltage battery can cause electric shocks, short circuits, explosions, fire or burns.

- ▶ Before starting the vehicle, remove the vehicle charging cable, close the cover and charge port door and store the vehicle charging cable in a safe place.
- ▶ Always observe the specified sequence when charging the high-voltage battery. Do not unplug the vehicle charging cable from the electrical socket during the charging process. Finish charging before disconnecting the vehicle charging cable from the electrical socket.
- ▶ Observe the safety notes in the instructions for the Porsche charging equipment.
- ▶ Do not work in or on the vehicle during the charging process.
- ▶ Never charge the vehicle at both charge ports at the same time.

**DANGER**

Unsuitable or damaged electrical sockets and vehicle charging cables

The use of unsuitable or damaged electrical sockets and vehicle charging cables and improper handling of the high-voltage battery can cause electric

shocks, short circuits, explosions, fire or burns.

- ▶ Only use vehicle charging cables that have been tested and approved by the manufacturer for charging the high-voltage battery in an electric vehicle.
- ▶ Always have the charging equipment with you that is required for the country you are driving in.
- ▶ Only connect vehicle charging cables to electrical sockets that were installed professionally.
- ▶ Do not connect vehicle charging cables to damaged or dirty electrical sockets.
- ▶ Do not use a damaged vehicle charging cable.
- ▶ Do not use extension cables, cable reels, multiple sockets or travel adapters.
- ▶ Do not modify or repair any of the electrical components.
- ▶ Protect electrical sockets and plug connections from water, moisture and other fluids and liquids.
- ▶ Do not use sharp-edged or pointed objects to remove dirt, ice and snow from the charging socket.
- ▶ Never insert objects into the charge port on the vehicle.

**WARNING**

Unsecured vehicle charging cable

An unsecured, incorrectly secured or incorrectly positioned vehicle charging cable can slip out of place and endanger the vehicle occupants during braking, changes of direction or in the event of an accident.

- ▶ Never transport the vehicle charging cable in the passenger compartment (such as on or in front of the seats) or unsecured.
- ▶ Always store the vehicle charging cable in the charge bag in the luggage compartment or in the storage compartment provided for transporting

it in the luggage compartment.

NOTICE

Risk of damage to the charging equipment and vehicle from overvoltages in the power supply.

- ▶ Do not charge the high-voltage battery via the vehicle charge port during a thunderstorm.
- ▶ If possible, disconnect charging equipment from the mains power supply during a thunderstorm.

Care instructions for the high-voltage battery

Please refer to chapter "Car Care" on page 63.

Instructions for charging the high-voltage battery

- ▶ Ensure that the temperature of the vehicle is between approx. $-20\text{ }^{\circ}\text{C}$ and $+30\text{ }^{\circ}\text{C}$ during the charging process.
- ▶ If possible, begin charging the high-voltage battery using the Charging Planner and use the Timer or Profile function to charge the battery with alternating current (AC).
- ▶ Use the Timer or Profile function to program a maximum high-voltage battery charge of 85% for daily use of the vehicle without any long-distance driving.
- ▶ If required, a battery charge of 100% can be programmed before starting long journeys.
- ▶ At ambient temperatures of over $30\text{ }^{\circ}\text{C}$, connect the vehicle to the mains and charge the high-voltage battery with alternating current (AC). Use the Timer or Profile function.
- ▶ At ambient temperatures of over $35\text{ }^{\circ}\text{C}$, avoid using "Range" drive mode immediately after charging with in excess of 150 kW direct current

(DC) in order to maximise cooling of the high-voltage battery.

Instructions for the charging equipment

- ▶ More information about the charger and about the web application is found under "E-Performance" at the following web address: <https://www.porsche.com>.
 - ▶ Only use vehicle charging cables that have been tested and approved for charging the high-voltage battery in an electric vehicle (the charging plug standardised in accordance with IEC 62196-2, SAE J1772 or GB/T 20234-2 and the charging process in accordance with IEC 61851-1, SAE J1772 or GB/T 18487 (modes 2 and 3)), and comply with national standards and legislation.
- Vehicle charging cables without protection (standardised in accordance with IEC 61851-1, SAE J1772 or GB/T 18487 (mode 1)) are not supported.
- ▶ Only use charging cables with a maximum length of 30 m.
 - ▶ Porsche recommends that you use charging equipment supplied and approved by Porsche together with the charging dock or the basic wall mount. Refer to the separate instructions for the Porsche charging equipment and the vehicle charging cable used.

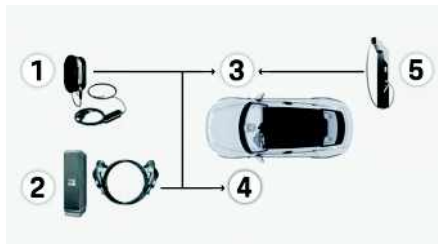

Fig. 49: Charging the high-voltage battery

Charging with alternating current (AC) at domestic and industrial electrical outlets or at public E-charging stations

The high-voltage battery in the vehicle can be charged with alternating current (AC) via the charge port on the driver's side (LHD: **4**, RHD: **3**). Depending on the country and equipment, there is another AC charge port on the passenger's side (LHD: **3**, RHD: **4**). Both charge ports have the same charging power. When you are using one charge port, the other charge port is disabled.

To reduce the charging time, Porsche recommends charging at industrial electrical outlets, at E-charging stations **2** or at the wall box **1**. Only charge the high-voltage battery at domestic electrical outlets **1** if no other charging option is available.

Rapid charging with direct current (DC) at public E-charging stations

The high-voltage battery in the vehicle can be charged with direct current (DC) **5** at a charging station via the charge port on the passenger's side (LHD: **3**, RHD: **4**). This shortens the charging time significantly.

Porsche recommends charging with direct current (DC) if you want to charge the high-voltage battery in the shortest possible time. The shortest charging times are achieved using the Charging Planner.

Opening and closing the charge port door

NOTICE

Risk of damage to the charge port door from foreign objects and ice.

- ▶ Check the charge port door for possible foreign objects and ice before opening and closing it.
- ▶ If the charge port door is damaged, visit a qualified specialist workshop. Porsche recommends a Porsche partner as they have trained workshop personnel and the necessary parts and tools.

▶ Please refer to chapter "Car Care" on page 63. The vehicle has either a manual or electric charge port door, depending on the equipment.

Opening and closing the manual charge port door

- ✓ Vehicle with a manual charge port door.
- ✓ Vehicle unlocked or driver's key near the charge port door (depending on the equipment).
- ✓ Parking lock and parking brake activated.

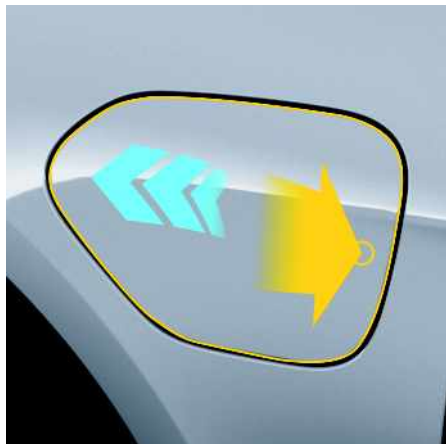

Fig. 50: Opening and closing the manual charge port door on the outside of the vehicle

1. Press on the rear part of the charge port door to open it.
Charge port door opens.
2. Press on the rear part of the charge port door until it engages securely to close it.

Opening and closing the electric charge port door

If the electric charge port door is open, it will close automatically after 120 seconds, 10 seconds after removing the vehicle plug or immediately after locking the vehicle.

- ✓ Vehicle with an electric charge port door.
- ✓ Vehicle unlocked or driver's key near the charge port door (depending on the equipment).
- ✓ Parking lock and parking brake activated.

Opening and closing the electric charge port door on the outside of the vehicle



Fig. 51: Opening the charge port door

- ▶ Move your hand along the underside of the fin to open it.
Charge port door opens.
- ▶ Move your hand along the underside of the fin to close it.
Charge port door closes.

Opening and closing the electric charge port door using the centre console control panel

1. Touch > .
2. Select the desired charge port door.
Charge port door opens or closes.

Inserting the vehicle plug into the vehicle charge port and starting the charging process

- ✓ Parking lock and parking brake activated.
 - ✓ Charge port door open.
 - ✓ Vehicle charging cable connected to the mains power supply.
1. Refer to the separate instructions for the Porsche charging equipment and instructions of the vehicle charging cable used.

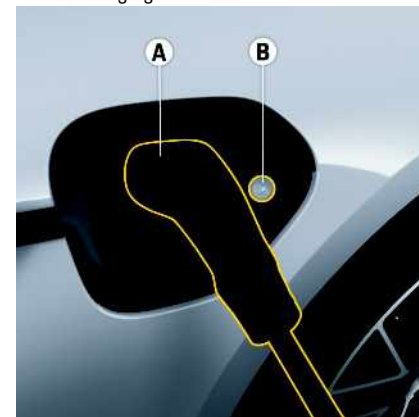

Fig. 52: Vehicle plug inserted

2. Insert vehicle plug **A** fully into the charge port until it clicks audibly into place. For heavy vehicle plugs, you may need to lift the vehicle plug slightly to ensure that it locks.
The vehicle plug is locked and the charging process is started. Release button ring **B** indicates whether the vehicle plug is locked and also shows the charge level of the high-voltage battery.

- ▶ Please refer to chapter "Display of the charge and locking status on the vehicle charge port" on page 82.

i Information

- If the vehicle plug is inserted when the vehicle is started, the vehicle plug remains locked.
- If gear **D** is selected during charging, the charging process is interrupted. The charging process is resumed after approx. 20 seconds if the vehicle plug is not removed.
- If the charge timer or profile function is activated while charging using alternating current (AC), the charge timer or profile function controls when the charging process starts and this may not start immediately after you insert and lock the vehicle plug.

Finishing the charging process and removing the vehicle plug from the vehicle charge port





1. Unlock the vehicle.
2. Press release button **B** on the vehicle charge port.
The vehicle plug is unlocked. If a charging process was started, it will be stopped.
3. Pull vehicle plug **A** from the vehicle charge port within approx. 20 Sekunden.
4. Disconnect the vehicle charging cable from the power supply and store it in a safe place.
5. Close the charge port door.





i Information

- Observe the specified sequence for charging the high-voltage battery.
- End the charging process before disconnecting the vehicle cable from the electrical socket.
- Observe the safety instructions for charging the high-voltage battery.

Display of the charge and locking status on the vehicle charge port

The release button ring indicates whether the vehicle plug is locked and also shows the charge level of the high-voltage battery.

B	Meaning
Off	The vehicle plug is not inserted or no connection to the mains supply is established.
	or
	Vehicle plug inserted: Vehicle in idle state. To detect the current connection status and battery charge level, press the  or  button on the driver's key.
 lights up	Vehicle plug inserted and locked.
 pulsates	Vehicle plug inserted and locked. Communications setup and dismantling

B	Meaning
 pulsates	Vehicle plug inserted and locked. The high-voltage battery is being charged.
 lights up	Vehicle plug inserted and locked. Charging process completed and target battery charge level reached.
 flashes	Vehicle plug inserted and locked. Charging paused due to programmed timer and profile settings.
 lights up	An error occurred while charging the high-voltage battery.

If the charging process was not started:

- ▶ Check that the vehicle plug is inserted correctly.
 - ▶ Refer to the separate instructions for the Porsche charging equipment and the instructions for the vehicle charging cable used and the instructions on the charging station.
 - ▶ Remove and insert the vehicle plug again.
- **or** –
1. Turn the vehicle off and get out.
 2. Remove the vehicle plug from the vehicle charge port.
 3. Close the doors, windows and charge port door, lock the vehicle and leave the keyless comfort access response area.
 4. Wait approximately 5 minutes. Do not use the app to access the vehicle during this time.
 5. Insert the vehicle plug into the vehicle charge port and start the charging process again.

Using the Immediate Charge function

- ✓ Vehicle plug inserted.

Central display

1.  ► **Charging** ► **Overview**

2. Activate **Charge Immediately**.

The high-voltage battery is being charged.

Centre console control panel

1. Touch the  softkey.

2. Touch the **Charge Immediately** softkey.

The high-voltage battery is being charged.

Using the charging functions in the central display.

The charging functions **Timer** and **Profile** can be used to programme various parameters for the charging process on the central display. Both functions are only available when charging with alternating current (AC).

Use the Timer or Profile function to programme a maximum high-voltage battery charge of 85% for daily use of the vehicle. The high-voltage battery is always charged to the minimum charge level programmed in the Profile function, even if a charge timer is active.

More information on the charger and the web application is available under "EPerformance" at the following web address: <https://www.porsche.com>.

Using the charge level display



Fig. 53: Charge level display

The battery charge condition display indicates the current charge level of the high-voltage battery in the central display and the centre console control panel.

Programming and activating the timer

- ✓ Departure time in the future.

The Timer function ensures that the high-voltage battery is charged to a specified charge level at a programmed departure time. The passenger compartment can be also pre-cooled/heated by the departure time by selecting the **Precool/heat** option.

- Please refer to chapter "Air Conditioning System Advanced Climate Control (2-/4-Zone Climate Control)" on page 42.

At some public charging stations, the charging process cannot be started if a departure timer has been programmed.

1.  ► **Load**  ► **Timer**

2. **Editing the Timer** .

3. **Programme the date and departure time.** If you use the selected timer regularly, activate **Repeat** and select **weekdays**.

4. Programming the **target charge**.

5. Activate **charging**.

6. Activate **parking pre-climatisation** if required.

7. Activating the timer.

Deactivating the timer

1.  ► **Charging**  ► **timer**

2. Deactivating the **timer**.

Starting charging using the timer

- ✓ Timer programmed and activated.
- ✓ Vehicle plug inserted.

The timer function defines the charging process, which then starts automatically. The high-voltage battery will be charged before the programmed departure time.

The high-voltage battery may not be fully charged if parking pre-climatisation is programmed.

Ending charging with the timer

- ✓ Vehicle plug inserted.
- ✓ Timer function activated.
- Press the release button.
- High-voltage battery charging stops.
- If charging is ongoing, wait until the ring has disappeared from the release button.

Programming and activating the charging profile

✓ Departure time in the future.

The Profile function ensures that the high-voltage battery is charged to a programmed minimum charge level at a specified departure time, such as to use specific energy rates.

Programming and activating the general charging profile

The high-voltage battery is charged automatically to the programmed charge level during the specified charging times when the vehicle is charged using alternating current (AC) and provided that no timer or location-dependent charging profile is active.

1. ► **Charging** ► **Profile**

2. Editing the **general charging profile**

3. **Programming** the minimum charge level.

4. Activating **optimised charging**.
– or –
Setting and activating your preferred charging times and programming **preferred charging times**.

5. Activating the **general charging profile**.

Programming and activating the location-dependent charging profile

1. ► **Charging** ► **Profile**

2. Select **Add new profile**.
– or –

Edit existing profile .

3. Programme the **name** and select the **location**.

4. **Programming** the minimum charge level.

5. Activate **optimised charging**.
– or –
Setting and activating your preferred charging times and programming **preferred charging times**.

6. Activate the **charging profile**.

Deactivate the profile

1. ► **Charging** ► **Profile**

2. Deactivate the **profile**.

Starting charging using the profile

✓ Profile programmed and activated.

✓ Vehicle plug inserted.

The profile function defines the charging process, which then starts automatically. The high-voltage battery will be charged to the specified charge level within the programmed charging time.

The high-voltage battery may not be fully charged depending on the minimum charge level programmed.

Stopping charging using the profile

✓ Vehicle plug inserted.

✓ Profile function activated.

▶ Press the release button.

High-voltage battery charging stops.

▶ If charging is ongoing, wait until the ring has disappeared from the release button.

Charging times

Charging powers and times depend on various factors, which may increase charging times considerably compared to the values indicated:

- Customer-specific installation, e.g. socket used.
- Power output of the country-specific energy infrastructure.
- Settings for charging current limiting on the control unit.
- Fluctuations in the mains voltage.
- Ambient temperature of the vehicle and the charging equipment.
- Temperature of the high-voltage battery and control unit.
- Charge level of the high-voltage battery.
- Age of the high-voltage battery and number of charges completed.
- Passenger compartment temperature precooling/heating activated.
- Current-carrying capacity of the vehicle plug.

The amount of energy taken from the mains power supply is greater than the amount of energy stored during charging of the high-voltage battery. The reasons for this include physical charging losses and the use of energy to control the temperature of the high-voltage battery.

For physical and chemical reasons, the charging speed decreases as the charge level approaches 100%.

The predominant use of fast charging columns (DC) causes charging times to increase in the long term.

- ▶ A maximum charging power of 50 kW should be selected for regular charging with direct current (DC).
- ▶ Charging with alternating current (AC) is recommended at home. Using an industrial electrical outlet (AC) will allow you to achieve higher

efficiency and a significantly lower charging duration than charging using a household socket.

Performing an emergency release of the charge port door

If the charging tray is faulty, the charge port door can be opened manually.

- ▶ Never perform an emergency release of the charge port doors on both sides at the same time or when one charge port door has already been opened correctly.

Performing an emergency release of the manual charge port door

After an emergency release of the manual charge port door, the vehicle can be charged via this charge port door using alternating current (AC) or direct current (DC). The charge port door located opposite is locked automatically.



Fig. 54: Emergency release of the manual charge port door

1. Remove the emergency release tool from the tool kit.
2. Guide the metal hook of the emergency release tool under the rear section of the charge port door.
3. Position the emergency release tool and pull to open.
4. Insert the metal hook of the emergency release tool into the tappet opening and turn the emergency release tool approx. 45 degrees towards the front of the vehicle, applying slight pressure.
5. Removing the tappet.
6. Carry out charging.
7. Close the charge port door after charging.

To have the unlocking mechanism of the charge port door checked:

- ▶ Visit a qualified specialist workshop. Porsche recommends a Porsche partner as they have trained workshop personnel and the necessary parts and tools.

Performing an emergency release of the electric charge port door

After an emergency release, the vehicle can only be charged using alternating current (AC).

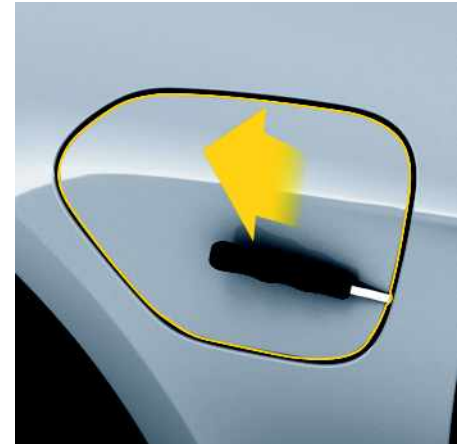

Fig. 55: Emergency release of the electric charge port door

1. Remove the emergency release tool from the tool kit.
2. Guide the metal hook of the emergency release tool behind the charge port door cover.
3. Position the emergency release tool and pull to loosen the charge port door from its anchor.
4. Carry out charging.
5. Place the charge port door cover on the anchor and push until it engages securely to close it.

To have the unlocking mechanism of the charge port door checked:

- ▶ Visit a qualified specialist workshop. Porsche recommends a Porsche partner as they have trained workshop personnel and the necessary parts and tools.

Performing an emergency release of the vehicle plug

If the vehicle plug cannot be released (e.g. due to a malfunction), an emergency release must be carried out.

The availability of the vehicle plug emergency release depends on the country.



Fig. 56: Performing an emergency release of the vehicle plug

1. Open the driver or passenger door.
2. Reach into the space between the driver or passenger door and wing. Pull the knob up to the point of resistance.
The vehicle plug is unlocked. If a charging process was started, it will be stopped.
3. Pull the vehicle plug from the vehicle charge port within approx. 20 seconds.
4. Close the charge port door. Visit a workshop.

Child Restraint Systems (Child Seats)

DANGER

Improper use of child restraint systems

Risk of serious or fatal injury resulting from the improper use of child restraint systems.

Child restraint systems that are not suitable for the vehicle type or that are not properly installed in the vehicle do not provide adequate protection in the event of an accident.

- ▶ Always refer to the separate installation instructions for the respective child restraint system.
- ▶ When using a child restraint system, always comply with the legal regulations that apply in your country.
- ▶ Use only child restraint systems recommended by Porsche. These restraint systems have been tested and adapted to suit the interior of Porsche vehicles and the corresponding child weight classes. Other systems have not been tested and could increase the risk of injury.
- ▶ Switch off the passenger airbag if a child restraint system is installed in the passenger seat.

Porsche recommends Porsche Tequipment child restraint systems. For information on installation options:

- ▶ Contact your Porsche partner.
- ▶ Please refer to chapter "Ensuring correct installation position of child restraint systems" on page 91.

DANGER

Child restraint system in the passenger seat

The passenger airbag offers protection only for persons of a certain minimum height and minimum weight. If a child restraint system is installed in the

passenger seat or if the seated passenger is a small or light person, there is a risk of serious or fatal injury from the passenger airbag deploying.

- ▶ Always check whether the passenger airbag needs to be switched off before installing a child restraint system in the passenger seat.
 - ▶ Adjust the backrest angle of the passenger seat so that there is solid contact between the passenger seat and child restraint system.
-
- ▶ Please refer to chapter "Ensuring correct installation position of child restraint systems" on page 91.
 - ▶ Please refer to chapter "Switching off the passenger airbag" on page 41.
 - ▶ Always switch off the seat heating if child restraint systems are installed.
 - ▶ Before installing a child restraint system in which the child sits forward-facing, adjust the relevant headrest as high as possible. If the headrest on the rear seat prevents you from installing the child restraint system even when adjusted to its highest position, the headrest must be removed. The headrest must always be re-installed once the child restraint system has been removed.
 - ▶ Please refer to chapter "Removing and installing headrests on rear seats" on page 226.



Fig. 57: Airbag warning sticker



Fig. 58: Airbag warning sticker on the sun visor

- ▶ Never remove, deface or render illegible airbag warning stickers **A** or warning signs.

Using child restraint systems correctly

1. Use a child restraint system of the correct weight and height category.
 - ▶ Please refer to chapter "Using child restraint systems of the correct weight and size class" on page 88.
2. Use the correct installation position for child restraint systems.
 - ▶ Please refer to chapter "Ensuring correct installation position of child restraint systems" on page 91.
3. Install the child restraint system securely.
 - ▶ Please refer to chapter "Installing child restraint systems" on page 93.

A
B
C
D
E
F
G
H
I
J
K
L
M
N
O
P
Q
R
S
T
U
V
W
X
Y
Z

Using child restraint systems of the correct weight and size class

- ▶ In addition the suitable weight and size class, also check the correct installation position.
- ▶ Please refer to chapter "Ensuring correct installation position of child restraint systems" on page 91.

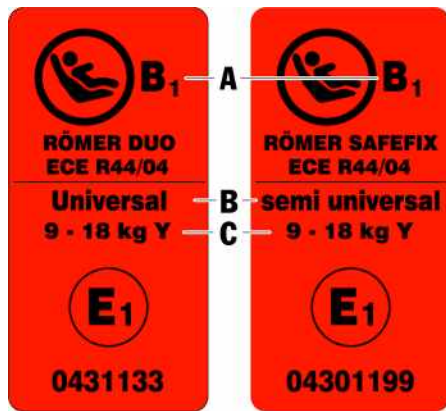

Fig. 59: Example of ECE child restraint system sticker

- A Size category
- B "Universal" or "semi universal" marking
- C Weight class

- ▶ In the case of child restraint systems with semi universal approval, please refer to the vehicle type list provided with the relevant child restraint system or available on the Internet.

Classification of child restraint systems into weight classes

Children in group 0 and 0+: up to 13 kg (secured with i-Size system, ISOFIX system and vehicle seat belt)

Children in this group are carried in child restraint systems **facing backward**. Whenever possible, these child restraint systems should be installed on the rear seats.

Children in group I: 9 to 18 kg (secured with i-Size system, ISOFIX system or vehicle seat belt)

Children in this group must be carried in child restraint systems **facing forward**. In exceptional cases, children in this weight group can also be carried in special child restraint systems that are facing backward. Whenever possible, these child restraint systems should be installed on the rear seats.

Children in group II: 15 to 25 kg (secured with the vehicle seat belt)

Children in this group must be carried in child restraint systems **facing forward**. Whenever possible, these child restraint systems should be installed on the rear seats.

Children in group III: 22 to 36 kg (secured with the vehicle seat belt)

Children in this group must be carried in child restraint systems **facing forward**. Whenever possible, these child restraint systems should be installed on the rear seats.

Classification of child restraint systems by size classes

- A ISO/F3: front-facing, full-height child restraint system
- B ISO/F2: front-facing, reduced-height child restraint system
- B1 ISO/F2X: front-facing, reduced-height child restraint system
- B2 ISO/B2: front-facing child restraint system with backrest
- C ISO/R3: rear-facing, full-size child restraint system
- D ISO/R2: rear-facing, reduced-size child restraint system
- E ISO/R1: rear-facing, child restraint system for infants
- F ISO/L1: left side-facing child restraint system (baby carrier)
- G ISO/L2: right side-facing child restraint system (baby carrier)

- ▶ Observe the scope of application of the child restraint system as well as the manufacturer's installation and operating instructions for the child restraint system being used.

Weight class	Size category	Child restraint system
Group 0: 0 to 10 kg	F	ISO/L1
	G	ISO/L2
	E	ISO/R1
Group 0+: 0 to 13 kg	C	ISO/R3

Weight class	Size category	Child restraint system
	D	ISO/R2
	E	ISO/R1
Group I: 9 to 18 kg i-Size child restraint systems ¹	A	ISO/F3
	B	ISO/F2
	B1	ISO/F2X
	B2	ISO/B2
	C	ISO/R3
	D	ISO/R2

1. Country-dependent

A
B
C
D
E
F
G
H
I
J
K
L
M
N
O
P
Q
R
S
T
U
V
W
X
Y
Z

Recommended child restraint systems

Weight class	Manufacturer	Secured with the vehicle seat belt			Secured with i-Size and ISOFIX system ¹		
		Type	Authorisation number	Porsche part number	Type	Authorisation number	Porsche part number
Group 0 and 0+ : up to 13 kg	Britax-Römer	Porsche Baby Seat G0+	E1 04301146	955.044.805.84	Porsche Baby-seat ISOFIX G0+ only in conjunction with: Base ISOFIX ¹	E1 04301146	955.044.805.84 only in conjunction with: 955.044.805.97
Group I : 9 to 18 kg	Britax-Römer	Porsche Junior Seat ISOFIX G1 ²	E1 04301199	955.044.806.13	Porsche Junior Seat ISOFIX G1 ^{2, 1}	E1 04301199	955.044.806.13
Group II : 15 to 25 kg	Britax-Römer	Porsche Junior Plus G2 + G3	E1 04301169	955.044.806.19	Porsche Junior Plus ISOFIT G2 + G3 ¹	E1 04301198	955.044.806.18
Group III : 22 to 36 kg	Britax-Römer	Porsche Junior Plus G2 + G3	E1 04301169	955.044.806.19	Porsche Junior Plus ISOFIT G2 + G3 ¹	E1 04301198	955.044.806.18

1. There is no i-Size or ISOFIX system available for the passenger seat.

2. **Not** permissible for use on the centre rear seat (vehicle with 3 rear seats) because this seat is not suitable for installation of child restraint systems with support leg.

Ensuring correct installation position of child restraint systems

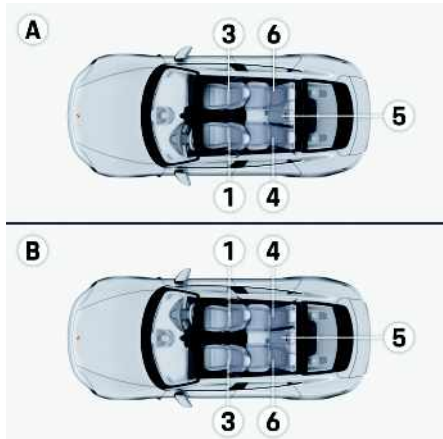

Fig. 60: Seat numbering for installation of child restraint systems in vehicles with 3 rear seats

- A Left-hand drive vehicle with 3 rear seats
- B Right-hand drive vehicle with 3 rear seats

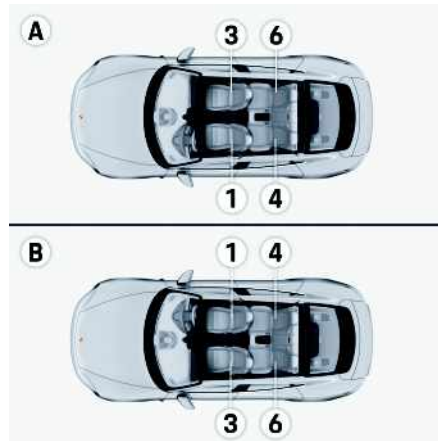

Fig. 61: Seat numbering for installation of child restraint systems in vehicles with 2 rear seats

- A Left-hand drive vehicle with 2 rear seats
- B Right-hand drive vehicle with 2 rear seats

Overview of how child restraint systems can be used in accordance with standard ECE-R 16.

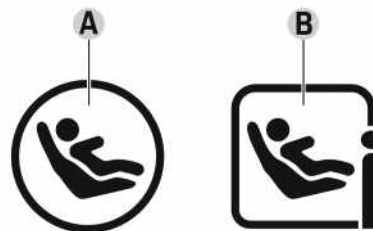

Fig. 62: ISOFIX and i-Size symbols

- A Symbol for attachment of an ISOFIX child restraint system (country-dependent)
- B Symbol for attachment of an i-Size child restraint system (country-dependent)

i-Size and ISOFIX are standardised anchorage systems for child restraint systems which are available on a country-dependent basis. ISOFIX child restraint systems and i-Size child restraint systems which are approved in accordance with ECE-R 129 and ECE-R 44 can be attached to the i-Size anchorage points.

A
B
C
D
E
F
G
H
I
J
K
L
M
N
O
P
Q
R
S
T
U
V
W
X
Y
Z

	Secured with i-Size system	Secured with the vehicle seat belt			Secured with ISOFIX system	
B	Permissible installation positions according to seat numbering	4 and 6	3, 4, 5 ¹ and 6			4 and 6
C						
D	Seat numbering for installation of child restraint systems	1	3 ²	4 ³	5 ^{4, 1}	6 ³
E	Secured with the vehicle seat belt	No	Yes	Yes	Yes	Yes
F	ISOFIX installation position	No	No	Yes	No	Yes
G	i-Size installation position	No	No	Yes	No	Yes
H	Sideward-facing child restraint systems	No	No	No	No	No
I	Largest suitable rear-facing child restraint system	No	R2	R3	R2 ⁵	R3
J	Largest suitable forward-facing child restraint system	No	F3/B2	F3	F2X ⁵	F3/B2
K	No: Seat is not suitable for installation of a child restraint system of this group.					

Overview of installation of child restraint systems on the passenger seat

When installing child restraint systems of the Universal (U) or "semi universal" (L) approval categories on the passenger seat, check whether the passenger airbag needs to be switched off using the table below.

For information on the approval category, please refer to the orange certification mark on the child restraint system.

- X: Seat is not suitable for child restraint systems of this group.
- U / L: Suitable for forward-facing child restraint systems in the "Universal" or "semi universal" approval categories, which are secured with the seat belt for adults and are approved for use with this group.

1. Seat 5 is only available for vehicles with 3 rear seats and is only suitable for installing child restraint systems secured with the vehicle seat belt.
2. Always check whether the passenger airbag needs to be switched off.
3. This installation position is suitable for child restraint systems with support leg.
4. This installation position is **not** suitable for child restraint systems with support leg.
5. Secured with the vehicle seat belt.

Group	Passenger airbag switched on ¹	Passenger airbag switched off
Group 0: 0 to 10 kg	X	U / L
Group 0+: 0 to 13 kg	X	U / L
Group I: 9 to 18 kg Backward-facing	X	U / L
Group I: 9 to 18 kg Forward-facing	U / L	U / L
Group II: 15 to 25 kg	U / L	U / L
Group III: 22 to 36 kg	U / L	U / L

Installing child restraint systems

Baby carriers

Left or right-facing child restraint systems from size categories F and G (e.g. baby carriers) should not generally be used on any of the seat versions.

Porsche recommends Porsche Tequipment child restraint systems (e.g. Porsche Babyseat ISOFIX GO+).

Switching passenger airbag on and off

 **DANGER** Passenger airbag switched off

The passenger airbag will not be triggered in an accident if it is switched off.

- ▶ Only switch off the passenger airbag if a child restraint system is fitted on the passenger seat.
- ▶ Switch the passenger airbag back on once the child restraint system has been removed.

1. Adjust the passenger seat to the rearmost upper position.



Fig. 63: Switching off the passenger airbag

✓ Vehicle switched off.

1. Open the glove box.
 - ▶ Please refer to chapter "Driver's Key" on page 104.

NOTICE

Risk of damage to the key switch and airbag system

- ▶ Only turn the emergency key when it is inserted fully into the key switch. It must be possible to turn the key switch without exerting excessive force.
- ▶ Only switch the passenger airbag on or off when the vehicle is switched off.

3. Insert the emergency key as far as it will go into the key switch.
4. Using the emergency key, switch the passenger airbag off (switch position **OFF**) or on (switch position **ON**).

DANGER

Risk of serious or fatal injury due to the passenger airbag triggering inadvertently

If the emergency key is left in the key switch during driving, it may inadvertently turn in the key switch due to vibration, possibly triggering the airbag.

- ▶ Never leave the emergency key in the key switch while driving.

5. Remove the emergency key from the key switch.
6. Close the glove box.

PASSENGER AIR BAG OFF/ON indicator



Fig. 64: PASSENGER AIR BAG OFF/ON indicator

The **PASSENGER AIR BAG OFF/ON** indicator is located on the overhead console.

OFF Lamp check

Once readiness for operation is established, the **PASSENGER AIR BAG OFF/ON** indicator comes on for approx. 5 seconds for a lamp check.

OFF Passenger airbag switched off

When the passenger airbag is switched off, the **PASSENGER AIR BAG OFF** indicator stays on when readiness for operation is established.

ON Passenger airbag switched on

When the passenger airbag is switched on, the **PASSENGER AIR BAG ON** indicator comes on for approx. 1 minute when readiness for operation is established and then goes off.

DANGER

Failure or malfunction of the passenger airbag

If the **PASSENGER AIR BAG OFF** indicator does not come on when readiness for operation is established and the passenger airbag is switched off, there may be a fault in the system.

- ▶ Do not install a child restraint system on the passenger seat.
- ▶ Visit a qualified specialist workshop. Porsche recommends a Porsche partner as they have trained workshop personnel and the necessary parts and tools.

Installing child restraint system with vehicle seat belt

Installing child restraint system on rear seats with vehicle seat belt

1. Adjust the backrest angle of the passenger seat so that there is solid contact between the passenger seat and child restraint system.
2. Adjust the passenger seat to the rearmost upper position.
 - ▶ Please refer to chapter "seats" on page 223.
3. If possible, adjust the seat belt guide on the backrest of the child restraint system so that it is

in front of and underneath the belt outlet on the B-pillar of the vehicle.

4. Make sure there is a comfortable distance between the passenger seat and the passenger sitting behind it and if necessary, adjust the passenger seat as required.
5. Make sure to leave a comfortable space between the child's feet and legs and the dashboard and if necessary, adjust the passenger seat as required.

Installing child restraint system on rear seats with vehicle seat belt

- ▶ For booster seats with no backrest, make sure that the booster seat is touching the rear seat backrest.

Installing child restraint system with i-Size or ISOFIX system

- ▶ Please refer to chapter "Using child restraint systems of the correct weight and size class" on page 88.
- ▶ Always refer to the separate installation instructions for your child restraint system.

Installing child restraint system on the rear seats



Fig. 65: i-Size or ISOFIX anchorage system on rear seats (country-dependent)

The retaining lugs **A** of the i-Size or ISOFIX anchorage system for the child restraint system are located under the marked protection caps on the seat cushion.

1. Remove the protection caps of the i-Size or ISOFIX anchorage system if necessary and put them in a safe place.
2. Secure the child restraint system to retaining lugs **A** as described in the instruction manual for the child restraint system.
3. Pull the child restraint system to check that both anchorage points are properly engaged.
4. Ensure a comfortable distance between the front passenger seat and a passenger sitting behind it.

To prevent it from rotating, the child restraint system must be additionally secured with the support leg or top tether.

Installing child restraint system with support leg

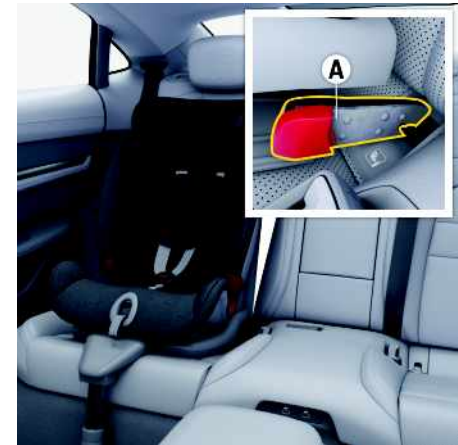

Fig. 66: Installing child restraint system with support leg

1. Install the child restraint system with ISOFIX or i-Size anchorage correctly using the retaining lug **A**.
 - ▶ Please refer to chapter "Installing child restraint system with i-Size or ISOFIX system" on page 95.
2. Position the support leg in accordance with the child restraint system manufacturer's instructions.
3. Ensure that the child restraint system is positioned flush against the rear seat.

Installing child restraint system with top tether

- ▶ When using a child restraint system with top tether, the top tether must be attached at the anchorage points on the back of the rear seat backrests.

A
B
C
D
E
F
G
H
I
J
K
L
M
N
O
P
Q
R
S
T
U
V
W
X
Y
Z

A
B
C
D
E
F
G
H
I
J
K
L
M
N
O
P
Q
R
S
T
U
V
W
X
Y
Z



Fig. 67: Anchorage points for top tether

1. Open the top tether cover.

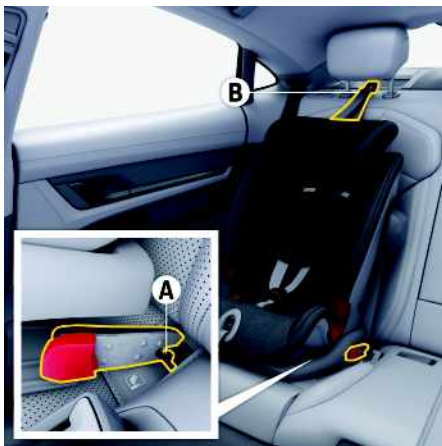

Fig. 68: Installing child restraint system with top tether

2. Install the child restraint system with ISOFIX or i-Size anchorage correctly with the retaining lug **A**.
 - ▷ Please refer to chapter "Installing child restraint system with i-Size or ISOFIX system" on page 95.
3. Guide the top tether **B** through the headrest. The headrest can be removed for ease of installation.
 - ▷ Please refer to chapter "Removing and installing headrests on rear seats" on page 226.

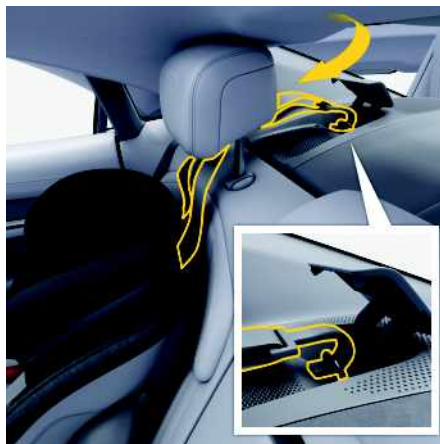

Fig. 69: Securing child restraint system with i-Size or ISOFIX top tether

4. Fasten the top tether to the anchorage point on the rear of the backrest and tighten the top tether.

Coolant

⚠ WARNING

coolant tank

The coolant tank is pressurised and contains hot coolant. Coolant can spray out suddenly when the coolant tank is opened.

- ▶ **Never** open the cap of the coolant tank. Go to a qualified specialist workshop. Porsche recommends a Porsche partner, as they have trained workshop personnel and the necessary parts and tools.
- ▶ Take care when working near hot vehicle parts.

NOTICE

If the vehicle continues to move after the warning light is displayed, there is a risk of damage.

- ▶ Park the vehicle and allow it to cool.
- ▶ Have the fault remedied without delay. Contact a qualified specialist workshop. Porsche recommends a Porsche partner, as they have trained workshop personnel and the necessary parts and tools.

NOTICE

A drop in coolant level indicates a vehicle defect, such as leaks in the coolant system.

- ▶ **Never** add coolant yourself.
- ▶ Have the cause remedied without delay. Contact a qualified specialist workshop. Porsche recommends a Porsche partner, as they have trained workshop personnel and the necessary parts and tools.

The coolant provides year-round protection from corrosion and freezing down to $-37\text{ }^{\circ}\text{C}$. Regular checking of the coolant level is part of servicing.

- ▶ Porsche recommends Glysantin® G40® (alternatively: antifreeze in accordance with G12++/VW TL 774 G).
- ▶ ViGo to sit a qualified specialist workshop. Porsche recommends a Porsche partner, as they have trained workshop personnel and the necessary parts and tools.

Cruise control (CC)

General safety instructions



WARNING

Unsafe traffic situation and unfavourable road conditions

Use of the cruise control may cause an accident if the current traffic situation does not permit driving safely at an adequate distance from the vehicle in front and at a constant speed.

- ▶ Do not use cruise control in heavy traffic, on twisting roads or in unfavourable road conditions (e.g. wintry or wet conditions, varying road surfaces).

Responding to warning messages

Always heed any warning and information messages displayed in the vehicle.

- ▶ Please refer to chapter "Warning and information messages" on page 271.

Operating principle

Cruise control (CC) maintains the selected speed between approx. 30 km/h and 240 km/h (20 and 150 mph) without the user having to press the accelerator.

Controls



Fig. 70: Control stalk for driver assistance systems

- R** Switching systems on/off and opening the options menu
S Open the options menu (when the system is switched on)
1 Set/increase speed
2 Reduce speed
3 RESUME: Resume control
4 CANCEL: Interrupt control

Display elements

Status display symbols

Symbol	Meaning
	Cruise control is passive.
	Cruise control is passive. Control is interrupted and the desired speed is still displayed.
	Cruise control is active at the set desired speed.

Switching cruise control on and off

The system that was selected last is always switched on. The system is initially in passive mode when switched on. It must first be activated before the control function starts working.

Switching on cruise control

- ✓ No driver assistance system has been switched on yet.

1. Press the **R** button on the control stalk.
The options menu for the driver assistance systems appears on the instrument cluster.
2. If cruise control is not already selected, select **CC** using the rotary knob on the steering wheel and press to confirm.

Cruise control is switched on and **passive**.

Switching from an already activated driver assistance system to cruise control

1. Press the **S** button on the control stalk.
The options menu for the driver assistance systems appears on the instrument cluster.
2. Select **CC** using the rotary knob on the steering wheel and press to confirm.
Cruise control is switched on and **passive**.
The operating status appears grey in the status display. There is no speed stored.

Information

The last selected driver assistance system is retained even after switching it off and operational readiness is restored.

Switching cruise control off

- ▶ Press the **R** button on the control stalk.
The memory is cleared and the readiness symbol disappears.

Activating cruise control

- ✓ Cruise control switched on.
 - ✓ Speed is higher than 30 km/h (20 mph)
1. Accelerate or decelerate to the desired speed using the accelerator pedal.
 2. Briefly press the control stalk forwards (position 1).

Cruise control is **active**.

The current driving speed appears green in the status display and is maintained automatically.

Changing the desired speed

The desired speed can be increased or decreased by pressing the control stalk.

- ✓ Cruise control active.

Increasing the speed

- ▶ Push the control stalk forward (position 1):
 - Press briefly = 1 km/h (1 mph) increments
 - Press and hold = 10 km/h (6 mph) increments

Reduce speed

- ▶ Pull the control stalk (position 2):
 - Pull briefly = 1 km/h (1 mph) increments
 - Pull and hold = 10 km/h (6 mph) increments

The new maximum speed is displayed on the instrument cluster.

Information

The speed can be increased using the accelerator pedal as usual. This does not change the stored value; it is resumed after the accelerator pedal is released.

Interrupting and resuming cruise control

Following deactivation, cruise control switches to standby mode and remains in standby until it is activated manually again.

Interrupting control

- ▶ Press the control stalk downwards (**CANCEL**).
 - or –
- ▶ Press the brake pedal.
 - or –
- ▶ Select position **N**.
Cruise control is passive. The set value for the desired speed remains stored. The status display changes from green to grey.

Cruise control operation is interrupted automatically in the following situations:

- The vehicle speed is above or below the set speed for a certain time.
- Porsche Stability Management (PSM) is active.

Resuming control

- ▶ Press the control stalk up (**RESUME**).
Cruise control accelerates or brakes the vehicle to the stored speed.

cupholder

Using cupholders



CAUTION

Spilled hot drinks

Hot drinks can cause scalding if spilled.

- ▶ Only use lidded containers that fit.
- ▶ Never put overfull containers in the cupholder.
- ▶ Do not use for hot drinks.
- ▶ Only use the cupholder for the storage of drinks as intended.

NOTICE

Risk of damage from spilled drinks.

- ▶ Only use lidded containers that fit.
- ▶ Never put overfull containers in the cupholder.

Using front cupholders



Fig. 71: Front cupholder

There is a cupholder in the front centre console and another in the front armrest.

Using the rear cupholders

There are two additional cupholders in the rear armrest.



Fig. 72: Cupholders in the rear armrest

- ✓ Vehicles with 3 rear seats.
- ▶ Unlocking and opening armrests.



Fig. 73: Cupholders in the rear armrest

- ✓ Vehicles with 2 rear seats.
- ▶ Open the armrest.

Stowing bottles

- ▶ Stow bottles in the storage compartments in the doors.

A
B
C
D
E
F
G
H
I
J
K
L
M
N
O
P
Q
R
S
T
U
V
W
X
Y
Z

Device Manager

Opening the Device Manager

The Device Manager provides an overview of the available devices and of their connection status.

- ▶ ▶ **Devices**
- or –

Touch the or in the status area (depending on the connection status).

Displaying connection status

Colours and meanings of the symbols

- Blue symbol: Connection is active.
- White symbol: Connection is possible, not yet active.
- No symbol: Connection is not possible.

Available functions

- **Telephone**: Mobile phones[®] connected via Bluetooth. Please refer to chapter "Phone" on page 182.
- **Music**: External media sources connected via Bluetooth[®]. Please refer to chapter "Media" on page 157.
- **Data**: Data connection established via the access point. Please refer to chapter "Porsche Connect" on page 196.
- **WiFi**: WiFi devices connected via the PCM WiFi hotspot. Please refer to chapter "Porsche Connect" on page 196.
- **Apple CarPlay**: iPhone connected via the USB port or wirelessly with access to Apple CarPlay. Please refer to chapter "Apple CarPlay" on page 55.

- ▶ The Connection Assistant will help you to connect devices or media sources: ▶ **Devices** ▶ **Connection assistant**

Pairing a new device via Bluetooth[®]

1. Touch ▶ **Devices** ▶ **Connection assistant** ▶ **Connect new telephone/Connect new music player**.
2. Select the device from the list.
A 6-digit Bluetooth[®] code is generated and displayed on the central display and device.
3. Compare the Bluetooth[®] code on the central display and device.
4. If the Bluetooth[®] code in the PCM and on the device match, confirm.
If the mobile phone has been successfully connected, it appears in the device overview.

For information on operating Porsche Communication Management (PCM):

- ▶ Please refer to chapter "Porsche Communication Management (PCM)" on page 190.

Device Manager settings

- ▶ Touch ▶ **Devices** ▶

The following settings are available (country-dependent):

- **Telephone settings**: Please refer to chapter "Phone" on page 182.
- **Bluetooth settings**:
 - Switching **Bluetooth** on or off.
 - Modifying the **Bluetooth name** of the PCM.
- **WiFi settings**:

- Switching **WiFi** on or off.
- **Allowing internet access**: Activate the PCM WiFi hotspot and allow a data connection for WiFi devices.
- **Allowing internet access**: Display and set up the PCM WiFi access data. This data is required to be able to connect a device (e.g. mobile phone) to the PCM via WiFi and to use a WiFi hotspot.
- **Data connection settings**:
 - **Display online data traffic**
 - **Reset online data counter**

Interfaces

USB interfaces (type C) are located in the front armrest and in the rear. The USB interfaces in the rear can only be used for charging purposes.



Fig. 74: USB charge ports in the rear

Connecting an external device via USB



Fig. 75: Interfaces in the armrest

1. Open the armrest.
2. Connect an external device, e.g. iPod®, USB storage medium, to the USB interface **A**.
3. Under **Media**  ► **Play** select the desired media source.
 - ▷ Please refer to chapter "Media" on page 157.
4. Adjust the volume on the external device and in the central display, as required.

Notes on ports and externally connected devices

- If a storage device contains a large number of files, folders or playlists, it may take longer to load media tracks for the first time.
- Audio files are automatically displayed with stored additional information (e.g. artist, title, album cover) during playback. If this information is not available on the medium in question, an available Internet database is used. Despite this, certain additional information may not be displayed.
- Do not use USB extension cables or adapters. These impair the functionality.
- USB hubs are not supported.
- Porsche will not assume any liability for damaged or lost files or media.

Technical data on supported media and file formats:

- ▷ Please refer to chapter "Technical Data" on page 308.

Driver's Key

Using the driver's key

i Information

- ▶ Only use the driver's key when the vehicle is in your sight.

The Porsche Crest on the driver's key lights up when the driver's key is actuated. The crest on the driver's key may light up while driving even without actuating it.

Data of relevance for servicing and maintenance is stored on the driver's key while driving. The Porsche Crest on the driver's key may therefore light up without being actuated. For more information on storing and reading out the data on the driver's key:

- ▶ Contact your Porsche partner.

The remote control may not work for the following reasons:

- Radio waves can cause transmission interference (also radio contact between the driver's key and vehicle, such as in vehicles with Comfort Access).
- The remote control is malfunctioning due to a fault.
- The battery in the driver's key is flat.
- ▶ Ensure that you do not store the driver's key together with electronic devices that are switched on (e.g. mobile phone, notebook, charging cable). Store the driver's key somewhere else if necessary.

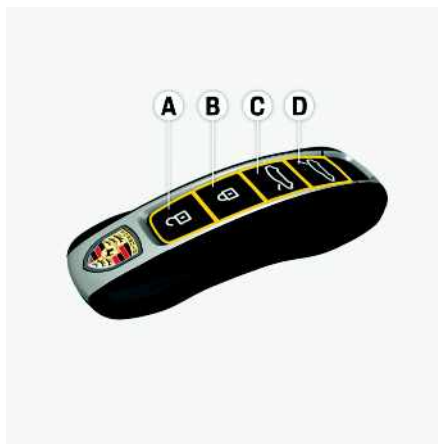

Fig. 76: Driver's key

- A** Unlocking the vehicle
- B** Lock the vehicle
- C** Unlocking the bonnet and vehicle
- D** Opening the tailgate and unlocking the vehicle

There is an emergency key integrated in every driver's key. The driver's keys can be used to operate all of the vehicle locks.

- ▶ Take care of your driver's keys: Do not part with them except under exceptional circumstances.
- ▶ Do not leave the driver's key in the vehicle.

Using the emergency key

Removing emergency key



Fig. 77: Removing emergency key

- ▶ Push the emergency key out of the driver's key upwards.

Insert the emergency key

- ▶ Insert the emergency key into the driver's key until latched.

Replacing battery in driver's key

⚠ WARNING

Internal chemical burns or death from swallowing the lithium button cell

The driver's key contains a lithium button cell (battery).

Swallowing the battery can lead to internal chemical burns within two hours and thus to death.

- ▶ Keep children away from removed or new batteries.
- ▶ Keep the driver's key away from children. Children may open the driver's key and remove the battery.
- ▶ If the battery has been swallowed or inserted into a bodily orifice, seek medical attention immediately.

i Information

- ▶ Observe the disposal instructions for batteries.

When the battery in the driver's key needs to be replaced, a message appears on the instrument cluster. The Porsche crest on the driver's key no longer lights up when the driver's key is used.

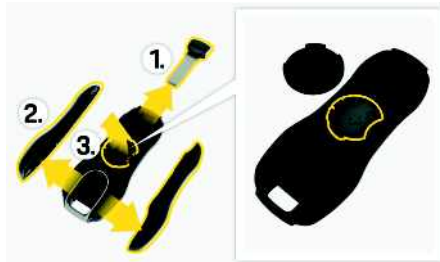

Fig. 78: Changing battery

Change the battery (CR 2032, 3 V)

1. Remove the emergency key.
2. Unclip the two-part driver's key housing to the right and left.
3. Turn the battery cover anti-clockwise to open it, and remove it.
4. Replace the battery (check the polarity).
5. Replace the battery cover and turn it clockwise to close it.
Ensure that the emergency key can be pushed in.
6. Press the driver's key housing up from below and clip it in place.
7. Insert the emergency key.

Starting the vehicle with discharged driver's key battery or radio interference.

Malfunctions of wireless communication between the vehicle and the driver's key, or a discharged driver's key battery can disable detection of the driver's key.

To switch on the vehicle in this case, proceed as follows:

1. Place the driver's key in the rear cupholder in the centre console. Hold the driver's key in the 12 o'clock position against the wall of the cupholder.
2. Press the power button and turn on the vehicle.

Ordering and storing replacement keys

Driver's keys can only be ordered from a Porsche partner. This can take a long time.

- ▶ Always have a replacement key available.
- ▶ Keep the replacement key in a safe place, but under no circumstances in or on the vehicle.

To register new driver's keys for the vehicle:

- ▶ Visit a qualified specialist workshop. Porsche recommends a Porsche partner as they have trained workshop personnel and the necessary parts and tools.
- ▶ Register all driver's keys belonging to the vehicle again.

i Information

A total of eight driver's keys can be taught.

i Information

- ▶ If a driver's key is lost or stolen, have a Porsche partner disable this driver's key in the vehicle and change the mechanical locks if necessary.
- ▶ You should notify your insurance company of the loss or theft of driver's keys or of the production of additional or replacement keys.

Driving mode

The vehicle offers driving modes that are coordinated to different requirements and driving conditions.

RANGE

The control systems are designed for efficient, consumption-optimised driving.

NORMAL

The control systems are designed for day-to-day driving with an emphasis on comfort.

SPORT

Adjusts the control systems more towards higher performance and greater dynamism during day-to-day driving.

SPORT PLUS

Maximum performance for racetrack-like operation.

INDIVIDUAL

Driving mode for individual adjustments.

Selecting drive mode

Information

NORMAL drive mode is automatically active after operational readiness has been established.

Selecting the drive mode via central display

 Drive  Drive mode

Selecting SPORT drive mode via the centre console control

- ✓ Vehicles without the Sport Chrono package.



Fig. 79: Button for SPORT drive mode

Activating SPORT drive mode:

- ▶ Press the **SPORT** button.
SPORT drive mode has been activated.
The corresponding button lights up blue.

Deactivating SPORT drive mode:

- ▶ With SPORT drive mode activated, press the **SPORT** button again.
SPORT drive mode is deactivated and NORMAL drive mode is activated.

Selecting driving mode using the mode switch

- ✓ Vehicles with Sport Chrono package.



Fig. 80: Drive mode on the steering wheel

- ▶ Turn the mode switch to the left or to the right to the desired drive mode.
The selected drive mode is displayed on the instrument cluster.

Configuring INDIVIDUAL driving mode

In INDIVIDUAL driving mode, settings for chassis systems and E-Sound can be combined on the basis of the existing driving modes. The combination stored can be retrieved by turning the mode switch to INDIVIDUAL or via the central display.

Selecting and storing settings under INDIVIDUAL

 Drive  Individual drive mode configuration

The selected settings become activated when INDIVIDUAL driving mode is selected.

Configuring RANGE drive mode

The following settings can be changed in RANGE drive mode:

Air conditioning

- Sets the air conditioning mode: ECO or ECO PLUS.
- ▶ Please refer to chapter "Air Conditioning System Advanced Climate Control (2-/4-Zone Climate Control)" on page 42.

Speed limitation

Sets the maximum speed for efficient and consumption-optimised driving. The speed can be limited to between 90 km/h – 140 km/h (56 mph – 87 mph) and is displayed on the instrument cluster. The speed limiter can be interrupted by initiating a kickdown. In this case, the speed limiter is deactivated temporarily, and the display on the instrument cluster turns grey. The speed limiter is activated again as soon as the vehicle speed drops to below the set limit.

Route-based adaptation

When route guidance is active and the Porsche Intelligent Range Manager (PIRM) is activated, the air conditioning and speed limit are adapted as required for the current route. If a change is initiated by PIRM, "Auto" appears in the speed limit display on the instrument cluster.

The changes are only made for the current route. The previously selected settings are not lost.

Overview of the vehicle setup in the selected drive mode

The table below shows only some of the available driving settings for the relevant drive modes.

- ▶ Please refer to the relevant section for further information on the individual vehicle functions.

Driving mode	RANGE	NORMAL	SPORT	SPORT PLUS
Launch Control	cannot be activated	cannot be activated	Can be activated	Can be activated
Basic boost recuperation setting	Off	Off	On	On
Chassis height	Low	Medium Depending on driving speed	Medium Depending on the driving speed	Low
Electric Sport Sound	Normal	Normal	Normal	Sport
Air conditioning	Eco or Eco Plus	Normal	Normal	Normal

Additional information

Range

The range depends, among other things, on the driving style, the climatic conditions, the use of energy-intensive loads and the selected vehicle

For further information on PIRM:

- ▶ Please refer to chapter "Charging Planner (available in some countries)" on page 169.

Selecting and storing settings under RANGE

- ▶  ▶ Drive ▶  ▶ Range drive mode configuration

The selected settings are activated when RANGE drive mode is selected.

Information

When RANGE drive mode is active, the chassis height cannot be changed and the PSM SPORT and PSM OFF settings are not available.

Responding to warning messages

Always heed any warning and information messages displayed in the vehicle.

- ▶ Please refer to chapter "Warning and information messages" on page 271.

Emergency Call System

Different emergency call systems may be used depending on model, country and equipment. Help can be requested via the emergency call system in an emergency or in dangerous situations.

Despite activated private mode, location information for the vehicle can be transmitted in the event of a breakdown or emergency call as well as theft.

Legal emergency call

- ✓ Legal emergency call system (for example EU eCall).
- ✓ Mobile phone network available.
- ✓ The emergency call system is operational (approximately 20 seconds after turning on the vehicle).

i Information

The emergency call system does **not** require a mobile phone logged on in the vehicle as it features an independent mobile communications module.

The emergency call system is activated by default upon vehicle delivery.

Under unfavourable conditions, an emergency call to an emergency call centre cannot be ensured (e.g. no mobile phone network available). Due to technical or organisational restrictions that lie outside the area of influence of Porsche (e.g. vehicle outside of country coverage of the legal emergency call system or no public emergency call infrastructure available), it might **not** be possible to make an emergency call to the specified public emergency call centre under certain circumstances. In countries outside the scope of the legal emergency call system, an attempt will be made in such cases to place an emergency call to an alternative public emergency call centre. This public emergency call centre **cannot**

process the data transmitted by the emergency call system for determination of the necessary rescue measures (for example, the current position of the vehicle is **not** automatically communicated).

If the vehicle battery is disconnected or defective, an integral battery ensures that the emergency call system remains available for at least one hour for queries from the emergency call centre.

i Information

When the cover flap is open, the SOS button can be pressed accidentally, thereby activating an emergency call unintentionally.

- ▶ The cover flap for the SOS button must be kept closed during driving.
- ▶ Only press the SOS button in an emergency.

Triggering an emergency call via SOS button



Fig. 81: SOS button and indicator light

- A SOS button
- B Indicator light

i Information

No emergency call can be placed when the vehicle is turned off.

1. Open the cover plate by pressing on it.
2. Press SOS button **A** for at least 1 second. If the SOS button is pressed again for at least 1 second within 6 seconds, the emergency call is cancelled.
Indicator light **B** flashes green while the call to the emergency call centre is being established.
3. If the circumstances allow, wait in the vehicle until the connection to the emergency call centre has been established.

Indicator light **B** flashes green when the call to the emergency call centre has been established. If queries from the emergency call centre remain unanswered, rescue measures can be initiated automatically.

i Information

If the indicator light flashes, but the emergency call centre cannot be heard via the loudspeaker, the loudspeaker may be defective, for example. You can, however, still be heard by the emergency call centre.

Indicator light status display

Indicator light	Status
Off	Emergency call system is off
Lights up green	Emergency call system is ready for operation
Lights up or flashes red	Error – emergency call not or only restrictedly possible ¹

Flashes green

Active emergency call – emergency call is established and data transmission to emergency call centre

Lights up orange

Active automatic emergency call – emergency call is established and data transmission to emergency call centre

Automatic emergency call

i Information

No automatic emergency call can be placed when the vehicle is turned off.

A connection to the emergency call centre is established automatically immediately after triggering of the airbags. The automatic emergency call cannot be prevented by pressing SOS button **A**. If queries from the emergency call centre remain unanswered, rescue measures can be initiated.

Data transmission

During an emergency call, person and vehicle-related data for determination of the necessary rescue measures is transmitted to the emergency call centre, provided that this is available.

The collection and transmission of the data to emergency service control centre is solely for the purpose of using the emergency call system within the specified emergency situations and in the

context of the applicable legal provisions. The emergency call system is not traceable and there is no permanent tracking of the vehicle. Any data collected is deleted immediately after the data transmission.

The following data is transmitted:

- Vehicle identification number
- Vehicle type
- Vehicle drive type
- Vehicle GPS position data
- GPS position data of the route shortly before the emergency call is triggered
- Log file of automatic activation of the emergency call system
- Time of the triggered emergency call
- Manually or automatically activated emergency call
- Number of persons in the vehicle
- Direction of travel

Emergency call

- ✓ Mobile phone network available.
- ✓ The emergency call system is operational (approximately 20 seconds after turning on the vehicle).

i Information

The emergency call system does **not** require a mobile phone logged on in the vehicle as it features an independent mobile communications module.

Under unfavourable conditions, an emergency call to an emergency call centre cannot be ensured (e.g. no mobile phone network available).

1. Visit a qualified specialist workshop. Porsche recommends a Porsche partner as they have trained workshop personnel and the necessary parts and tools.

Due to technical or organisational restrictions that lie outside the area of influence of Porsche (e.g. vehicle outside of the emergency call country coverage), it may be that **no** emergency call to the designated emergency call centre can be established under certain circumstances. In this case, if legally permissible an emergency call to an alternative public emergency call centre is established. A public emergency call centre **may not** be able to process the data transmitted by the emergency call system to determine necessary rescue measures (for example, the current position of the vehicle is **not** automatically communicated).

If the vehicle battery is disconnected or defective, an integral battery ensures that the emergency call system remains available for at least one hour for queries from the emergency call centre.

i Information

When the cover flap is open, the SOS button can be pressed accidentally, thereby activating an emergency call unintentionally.

- ▶ The cover flap for the SOS button must be kept closed during driving.
- ▶ Only press the SOS button in an emergency.

Triggering an emergency call via SOS button



Fig. 82: SOS button and indicator light

- A** SOS button
- B** Indicator light

i Information

No emergency call can be placed when the vehicle is turned off.

1. Open the cover plate by pressing on it.
2. Press SOS button **A** for at least 1 second. If the SOS button is pressed again for at least 1 second within 6 seconds, the emergency call is cancelled.

Indicator light **B** flashes green while the call to the emergency call centre is being established.

3. If the circumstances allow, wait in the vehicle until the connection to the emergency call centre has been established.

Indicator light **B** flashes green when the call to the emergency call centre has been established.

If queries from the emergency call centre remain unanswered, rescue measures are initiated automatically.

i Information

If the indicator light flashes, but the emergency call centre cannot be heard via the loudspeaker, the loudspeaker may be defective, for example. You can, however, still be heard by the emergency call centre.

Indicator light status display

Indicator light	Status
Off	Emergency call system is off
Lights up green	Emergency call system is ready for operation

Lights up or flashes red Error – emergency call not or only restrictedly possible¹

Flashes green Active emergency call – emergency call is established and data transmission to emergency call centre

- Severity of the accident
- Orientation of the vehicle during the accident
- Vehicle menu language

Automatic emergency call

i Information

No automatic emergency call can be placed when the vehicle is turned off.

A connection to the emergency call centre is established automatically immediately after triggering of the airbags. The automatic emergency call cannot be prevented by pressing SOS button A.

If queries from the emergency call centre remain unanswered, rescue measures are initiated automatically.

Data transmission

When an emergency call is made, any available data is transmitted to the emergency call centre to determine the rescue measures required. This can include:

- Current vehicle location
- Position data of the route immediately before the emergency call
- Vehicle identification number
- Vehicle type

1. Visit a qualified specialist workshop. Porsche recommends a Porsche partner as they have trained workshop personnel and the necessary parts and tools.

- A
- B
- C
- D
- E
- F
- G
- H
- I
- J
- K
- L
- M
- N
- O
- P
- Q
- R
- S
- T
- U
- V
- W
- X
- Y
- Z

Emergency Stop Function

General safety instructions



Lack of attention and failure to detect objects

The system can only assist the driver within the limits of the system, but it cannot replace the driver. The assistance offered by the system should not induce you to risk your safety.

Nor can the system prevent an accident under all circumstances. The driver is always responsible for an appropriate response.

The system cannot detect the following situations:

- Persons, cyclists and animals
- Objects on the road
- Oncoming vehicles and cross traffic

- ▶ Drive with extreme care.
- ▶ Always pay attention to the traffic situation and the area around the vehicle.

System limitations

The function may be limited, unresponsive or deactivate automatically in the following situations:

- If the driver actuates the accelerator pedal, brake or steering.
- If driving systems such as Lane Keep Assist, Active Lane Keeping, ACC or PID are limited.
- If the radar sensors or the windscreen in the area of the camera are damaged or soiled.

Responding to warning messages

Always heed any warning and information messages displayed in the vehicle.

- ▶ Please refer to chapter "Warning and information messages" on page 271.

Operating principle

The system monitors the steering, accelerator and brake pedal activity of the driver and provides support in the speed range from 0 km/h (0 mph) to approx. 210 km/h – 250 km/h (130 mph – 156 mph)¹.

If the emergency stop function is active, it will initiate visual, acoustic or haptic warnings in stages and will brake the vehicle to a standstill.

The following conditions must be met for the switched-on emergency stop function to be active:

In the speed range from 0 km/h (0 mph) to 65 km/h (40 mph):

- Active Lane Guidance is active and the driver does not react to the takeover prompts of Active Lane Guidance.

In the speed range from 65 km/h (40 mph) to 210 km/h (130 mph):

- Active Lane Guidance is active and the driver does not react to the takeover prompts of Active Lane Guidance.
- Active Lane Guidance is switched off, Lane Keep Assist is active and the driver does not react to the takeover prompts from Lane Keep Assist.
- Active Lane Guidance is switched off, Lane Keep Assist is switched off and the emergency stop function does not detect any steering, braking or accelerator pedal activity.

In the speed range from 210 km/h (130 mph) to 250 km/h (156 mph):

- Lane Keep Assist is active and the driver does not react to the takeover prompts from Lane Keep Assist.
- Lane Keep Assist is switched off and the emergency stop function does not detect any steering, braking or accelerator pedal activity.

If Active Lane Guidance is deactivated in the speed range below 65 km/h (40 mph), the emergency stop function is not available.

These warnings prompt the driver to take control of the vehicle:

- Driver instructions in instrument cluster
- Warning signals
- PCM muting
- Jerking belt
- Warning jerks and gentle braking

If the driver still fails to act, the emergency stop function executes an emergency stop:

- The hazard warning lights are activated.
- The seat belt is tensioned.
- The windows are closed.
- The seat side bolsters are inflated (depending on the equipment).
- The vehicle is braked to a stop in its own lane. Additional warning jerks are executed as this happens.

After the vehicle has come to a standstill, the parking lock and parking brake are activated, the doors are unlocked, the interior lighting is activated and an emergency call² and equipment.

To drive on again, select drive position **D** or **R**.

1. The specified speed range depends upon various factors, e.g. drive power, tyre type, loading, road surface, uphill and downhill gradients etc.
2. is triggered depending on the country

Overriding the emergency stop function

The emergency stop function can be overridden while driving. This temporarily deactivates the system. This also happens when the driver does this without knowing it. Override the emergency stop function by:

- ▶ Move the steering wheel
 - or –
- ▶ Pressing the brake pedal
 - or –
- ▶ Heavily pressing the accelerator pedal.

Activating and deactivating the emergency stop function

- ▶  ▶ Assistance ▶ Basic assistance ▶ Emergency Stop Function

Information

The emergency stop function is activated automatically after operational readiness has been established.

Flat Tyre

Depending on the model and vehicle equipment, the vehicle may come with either a tyre sealing compound kit or a spare wheel.

Responding to Tyre Pressure Monitoring warning messages

If the Tyre Pressure Monitoring system has detected a severe pressure loss, a message appears on the instrument cluster. Pressure loss can be an indication of damage to the tyres.

- ▶ Stop in a suitable place and check the indicated tyre for damage.
- ▶ Please refer to chapter "Tyres and Wheels" on page 249.

Parking the vehicle safely

1. Stop the vehicle as far away from the driving lane as possible. The vehicle must be parked on a firm and flat surface that is skid-proof.
 2. Switch hazard warning lights on.
 3. Activate the parking brake.
 4. Straighten the front wheels.
 5. Get all passengers to leave the vehicle. Pay attention to the traffic as they do so.
 6. Set up the warning triangle at a suitable distance.
 7. Secure the vehicle to prevent it from rolling away, e.g. by means of wedges under the wheels on the diagonally opposite side.
- ▶ Please refer to chapter "Jack and Lifting Platform" on page 138.

Sealing defective tyres

- ✓ Vehicles with tyre sealant.



WARNING

Temporarily repaired tyres

Damaged tyres with tyre sealing compound can burst or lose pressure if the vehicle is driven at an inappropriate speed or under continuous load.

- ▶ Sealing the tyre with tyre sealing compound is only an emergency solution to enable you to drive to the nearest specialist workshop.
- ▶ Use tyre sealing compound only for cuts or punctures no larger than 4 mm.
- ▶ Never use tyre sealing compound if the rim is damaged.
- ▶ Have the tyre replaced by a specialist workshop as soon as possible. Inform the specialist workshop that the tyre contains tyre sealing compound.
- ▶ Tyres **must not** be repaired.
- ▶ Avoid hard acceleration and high cornering speeds.
- ▶ Do not drive faster than the maximum permitted speed of 80 km/h (50 mph).
- ▶ Read and follow the safety and operating instructions, which can be found in the separate operating instructions for the tyre sealing compound and compressor.

In the event of a flat tyre, tyre damage can be temporarily sealed using the tyre sealant provided in the vehicle.

The **tyre sealant set** and the compressor that goes with it are located in the front luggage compartment.

- ▶ Please refer to chapter "Luggage compartment" on page 153.

Filling in tyre sealant



WARNING

Flammable and harmful sealant

The sealant is highly flammable and harmful to health.

- ▶ Fire, naked flames and smoking are prohibited when handling tyre sealant.
- ▶ Avoid contact with skin, eyes and clothing.
- ▶ Keep tyre sealant away from children.
- ▶ Do not inhale vapours.



CAUTION

In the event of contact with tyre sealing compound:

Irritation or allergic reactions after contact with tyre sealant.

- ▶ Avoid contact with skin, eyes and clothing.
- ▶ If tyre sealing compound gets on your skin or into your eyes, thoroughly rinse the affected part of your body immediately with plenty of water.
- ▶ Change soiled clothing immediately.
- ▶ Consult a doctor immediately in the event of an allergic reaction.
- ▶ If tyre sealant is swallowed, thoroughly rinse out the mouth without delay and drink plenty of water. Do not induce vomiting. Consult a doctor immediately.



WARNING

Failure to detect pressure loss in the tyre

A tyre pressure sensor that is soiled with tyre sealant cannot determine the tyre pressure correctly.

- ▶ When the defective tyre is changed, have the tyre pressure sensor replaced as well.

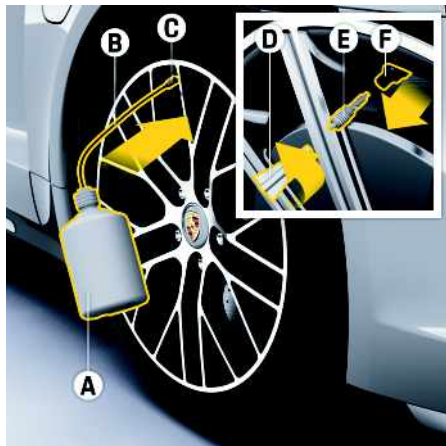

Fig. 83: Filling in tyre sealant

- A Filler bottle
- B Filler hose
- C Filler hose plug
- D Valve turner
- E Valve insert
- F Tyre valve

Preparing to fill

1. Leave the object that caused the puncture in the tyre.
2. Remove the tyre sealant and the enclosed sticker from the left-hand box in the front luggage compartment.
 - ▷ Please refer to chapter "Luggage compartment" on page 153.
3. Affix the sticker in the driver's field of vision.

Filling in tyre sealant

- ▷ Follow the separate operating instructions for using the tyre sealant.
1. Shake filler bottle **A**.
 2. Screw filler hose **B** onto the filler bottle.

The filler bottle is open.

3. Unscrew valve cap from the tyre valve **F**.
4. Remove valve insert **E** from the tyre valve with valve turner **D**.
If a replacement valve insert is not available, keep the valve insert in a clean, dry place.
5. Remove plug **C** from the filler hose **B**.
6. Push the filler hose onto the tyre valve.
7. Hold the filler bottle higher than the level of the tyre valve and squeeze it forcefully until the bottle is completely emptied into the tyre.
8. Pull the filler hose off the tyre valve.
9. If available, screw the replacement valve insert or alternatively valve insert **E** with valve turner **D** firmly into the tyre valve.

Inflating the tyres

- ▷ Read and follow the operating instructions on the compressor.
1. Remove the compressor from the right-hand box in the front luggage compartment.
 - ▷ Please refer to chapter "Luggage compartment" on page 153.
 2. Connect the compressor to a plug socket in the vehicle and inflate the tyre to at least 2.5 bar (36 psi). If this tyre pressure cannot be reached, the tyre is too severely damaged. You must not continue driving with this tyre.
 3. Screw valve cap onto the tyre valve **F**.

Checking pressure

- ▷ Check the tyre pressure after driving for approx. 10 minutes. If the tyre pressure is less than 1.5 bar (22 psi), do not continue driving.
- ▷ Please refer to chapter "Technical Data" on page 308.

Changing tyres

- ▷ Please refer to chapter "Changing tyres and wheels" on page 252.

Updating the Tyre Pressure Monitoring tyre settings after changing a wheel

- ▷ Please refer to chapter "Tyres and Wheels" on page 249.

Using the spare wheel

- ✓ Vehicles with a spare wheel.



WARNING

Changed vehicle handling

The use of a spare wheel can impair vehicle handling.

- ▶ The spare wheel must be used only over short distances in cases of emergency.
For safety reasons, replace the tyres **before** the wear indicators appear (webs in the tyre grooves, 1.6 mm high).
- ▶ Never deactivate the Porsche Stability Management (PSM) system.
- ▶ Avoid hard acceleration and high cornering speeds.
The admissible maximum speed is **80 km/h (50 mph)** and must not be exceeded due to changed vehicle characteristics and wear.
- ▶ Do not use a spare wheel from a different vehicle type.
- ▶ Do not fit the spare wheel from your vehicle on a different vehicle.
- ▶ Only fit one spare wheel on the vehicle at any time.

The collapsible spare wheel is located in the boot.

- ▷ Please refer to chapter "Changing a wheel" on page 255.

A
B
C
D
E
F
G
H
I
J
K
L
M
N
O
P
Q
R
S
T
U
V
W
X
Y
Z

- ▷ Please refer to chapter "Inflating tyres" on page 251.

After using the collapsible spare wheel

- ▶ Stow the spare wheel in the boot again for transport.

If the spare wheel is defective:

- ▶ Visit a qualified specialist workshop. Porsche recommends a Porsche partner as they have trained workshop personnel and the necessary parts and tools.

Fuses

WARNING

Short circuit

Working on the electrical system of the vehicle can result in a short circuit. Short circuits can cause fires.

- ▶ Disconnect the negative terminal on the 12-volt lithium battery for all work on the electrical system.
- ▶ Please refer to chapter "12-volt battery" on page 282.

WARNING

Improper intervention and incorrect accessories

Improper intervention in the fuse box and the use of the incorrect accessories can result in damage and malfunctions in electrical and electronic systems.

- ▶ Do not attempt to replace any electrical components except the fuses (e.g. relays) listed here.
- ▶ Visit a qualified specialist workshop. Porsche recommends a Porsche partner as they have trained workshop personnel and the necessary parts and tools.
- ▶ Only use accessories that have been approved by Porsche. For information on approved accessories: Contact your Porsche partner.

Checking and changing fuses

In order to prevent damage to the electrical system due to short circuits and overloads, the individual circuits are protected by fuses.

Fuse boxes are located in the footwell and at the outer ends of the dashboard on the driver and passenger sides.

Depending on the equipment, further fuse boxes are located at various locations in the vehicle, which are only accessible to a specialist workshop.

Fuse ratings

Colour		Amperage rating
	Light brown	5 A
	Brown	7.5 A
	Red	10 A
	blue	15 A
	Yellow	20 A
	White / clear	25 A
	Green	30 A
	Blue-green	35 A
	Orange	40 A

Checking and changing fuses

The numbering of the fuse slots is embossed on the fuse holder.

Unassigned fuse slots are not listed in the following overviews.

1. Switch off the load with the defective fuse if possible.
 2. Open the relevant fuse box cover.
 3. If necessary, carefully remove the purple plastic strip over the fuses.
 4. Remove the fuse from its slot using the plastic gripper **D** in order to check it. A blown fuse can be identified by the melted metal strip.
 5. Insert the new fuse. Only use fuses with the same rating as the fuse you are replacing.
 6. Fit the purple plastic strip back into place.
- If the same fuse blows repeatedly, the cause of the fault must be corrected immediately.
- ▶ Visit a qualified specialist workshop. Porsche recommends a Porsche partner as they have trained workshop personnel and the necessary parts and tools.

Opening the fuse box on the dashboard on the left side

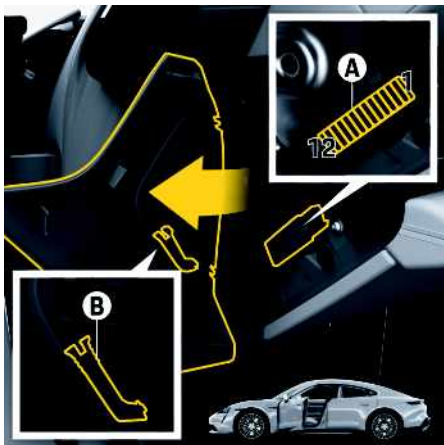

Fig. 84: Left fuse box

- A 1–12 fuses (dependent on equipment)
- B Plastic gripper

Left fuse box

- ▶ Carefully lever off the cover starting from the underside and remove it.

No.	Load
2	Rear air conditioning, seat heating control unit in the rear
3	Air conditioning control unit
5	Steering column electronics control unit
6	Control unit for steering column adjustment

No.	Load
8	Instrument cluster
9	Card reader ETC toll system (availability dependent on country):
10	Digital/stopwatch
12	Heated steering wheel

Opening the fuse box on the dashboard on the right-hand side

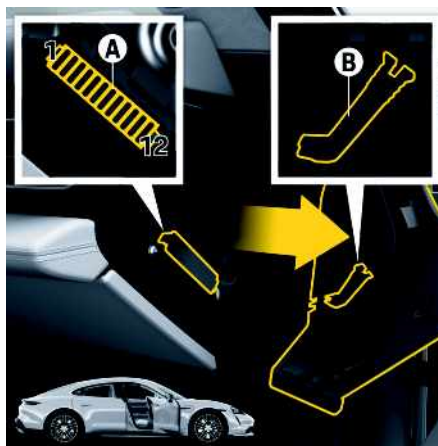

Fig. 85: Right fuse box

- A 1–12 fuses (dependent on equipment)
- B Plastic gripper

- ▶ Carefully lever off the cover starting from the underside and remove it.

Right fuse box

No.	Load
1	Smartphone tray
2	PCM
3	Central display
4	Central display
5	Audio interfaces
6	Fresh air fan
7	PCM control unit
8	Gear selector
12	diagnostic socket

Opening the fuse box in the left footwell



Fig. 86: Opening the fuse box in the left footwell

Row A

No.	Load
1	Heating circuit coolant pump
2	Heating circuit coolant pump
3	Cooling circuit relay
5	BCM control unit (left-hand drive)
6	BCM control unit (left-hand drive)
7	Light/rain sensor

No.	Load
8	Radio-controlled parking control unit (left-hand drive), charge port sensor (right-hand drive)
9	Overhead console
10	BCM control unit (left-hand drive)
11	Wireless data transfer control unit (left-hand drive)
12	Communication box

Row B

No.	Load
1	Driver assistance systems control unit
2	Rear left door control unit
3	Heating circuit control unit (left-hand drive) charge ports (right-hand drive)
4	Windscreen wiper (left-hand drive)
5	PSM control unit
7	Seat belt, front left
8	BCM control unit (left-hand drive)
9	BCM control unit (left-hand drive)
10	Left headlight electronics

No.	Load
11	Front left door control unit
12	BCM control unit (left-hand drive)

Row C

No.	Load
1	Wireless data transfer control unit (left-hand drive)
3	BCM control unit (left-hand drive)
4	Diagnostic socket (left-hand drive)
6	Front left radar sensor control unit
7	Brake booster control unit (left-hand drive)
8	Interior mirror
9	Communication box
10	Right voltage supply terminal 15 (right-hand drive)
11	Rear voltage supply terminal 15 (right-hand drive)

Opening the fuse box in the right footwell

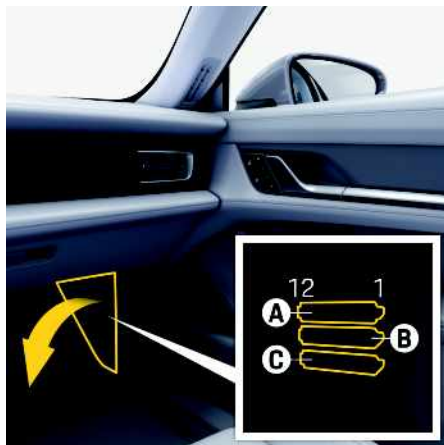

Fig. 87: Opening the fuse box in the right footwell

Row A

No.	Load
1	BCM control unit (right-hand drive)
3	BCM control unit (right-hand drive)
4	Windscreen wiper (right-hand drive)
5	BCM control unit (right-hand drive)
6	Rear right door control unit
7	Assistance systems control unit
8	Front right door control unit

No.	Load
9	Airbag control unit
10	Seat belt, front right
11	Charge port sensor (left-hand drive), radio-controlled parking control unit (right-hand drive)
12	BCM control unit (right-hand drive)

Row B

No.	Load
1	Gateway control unit
2	Wireless data transfer control unit (right-hand drive)
3	Heating circuit control unit (right-hand drive), charge ports (left-hand drive)
4	Right headlight electronics
5	BCM control unit (right-hand drive)
6	BCM control unit (right-hand drive)
7	Night View Assist control unit
8	Driver assistance systems front camera
9	Front PDCC control unit

No.	Load
10	Wireless data transfer control unit (right-hand drive)
11	Radar sensor control unit, front right

Row C

No.	Load
1	Diagnostic socket (right-hand drive)
2	Gateway control unit
3	Brake booster control unit (right-hand drive)
4	BCM control unit (right-hand drive)
5	Front pulse-controlled inverter
6	Ioniser
7	Power supply left, terminal 15 (left-hand drive)
8	Power supply rear, terminal 15 (left-hand drive)
9	DC/DC converter
10	Electric power steering control unit
12	Adaptive Cruise Control (ACC)

Garage door opener (HomeLink®)

General Safety Instructions

WARNING

Pinching, crushing or knocking against the operated equipment

Risk of accidents when using or programming the garage door opener if persons or animals are within the range of movement of the equipment that is being operated.

- ▶ When using or programming the HomeLink® system, ensure that no persons, animals or objects are within the range of movement of the equipment that is being operated.
- ▶ Observe the safety notes for the original remote control.

Operating principle

With the HomeLink® system, up to eight remote-controlled items (e.g. for garage doors / entry gates to your property, security systems, house lights) can be operated from the vehicle via profiles in the central display.

- ▶ Observe the instructions for the original remote control.

Information

For information on the compatibility of your vehicle's HomeLink® system with the original hand transmitter:

- ▶ Contact your Porsche partner.
- ▶ Visit www.homelink.com or call the free HomeLink® hotline (0)0800 046 635 465 or (0) 08000 HOMELINK.

Information

- ▶ Before selling your vehicle, remember to delete the garage door opener signals.

Using the garage door opener

Manually executing the taught HomeLink® profile

- ✓ Ready for operation.
- ✓ Vehicle is aligned towards the receiver and within range of the receiver (signal is transmitted in direction of travel).

1. ▶ HomeLink®

2. Select the desired profile.

If the existing HomeLink® profiles are assigned to GPS coordinates, the profiles are filtered on the basis of the current vehicle position.

HomeLink® Automatically executing profiles

- ✓ Ready for operation.
- ✓ Vehicle is aligned towards the receiver and within range of the receiver (signal is transmitted in direction of travel).
- ✓ GPS coordinates assigned to HomeLink® profile.

Shortly before reaching a HomeLink® system with assigned GPS coordinates, the relevant profile is displayed automatically and proposed for execution.

Programming garage door opener

- ✓ Ready for operation.
- ✓ Vehicle is aligned towards the receiver and within range of the receiver (signal is transmitted in direction of travel).

Programming a new garage door opener

1.  ▶ HomeLink®  ▶ Teach new profile
2. Follow the instructions displayed.

Synchronising systems with changeable code

For systems with a rolling code, synchronisation of the HomeLink® system is also required. This starts automatically after teach-in. A second person makes programming easier.



Information

If you have not been able to successfully assign signals to the buttons even though you have carefully followed the instructions in this section and the operating instructions for the original remote control:



- ▶ Contact your Porsche partner.
- ▶ Make sure that the battery in the remote control for the garage door opener is new. If the battery voltage is inadequate, faults may occur in signal transmission. The system in the vehicle then learns an incorrect code, which cannot be reliably recognised.
- ▶ Check the compatibility of the vehicle's HomeLink® system with the original hand transmitter.

A Managing learned profiles

B Renaming learned profiles; adding or deleting C GPS coordinates

1.  ▶ HomeLink® 
2. Select the  button for the respective profile.
3. Select the desired option.

G Deleting a learned profile

1.  ▶ HomeLink® 
2. Swipe to drag the profile you wish to delete from the profile list.

L Deleting all learned profiles

- ▶  ▶ HomeLink®  ▶  ▶ Delete all Home-Link® profiles

HOLD function

General Safety Instructions

WARNING

Loss of control over the vehicle

Despite the HOLD function, responsibility for stopping and starting on gradients lies with the driver. When stopping and starting on slippery surfaces, e.g. icy or loose substrate, the HOLD function cannot be guaranteed to provide assistance. The vehicle can roll away.

- ▶ Always adjust your driving style to the road surface and the vehicle load; use the footbrake if necessary.

If the HOLD function is not working, the driver can no longer be assisted when driving off on gradients.

- ▶ Hold the vehicle with the footbrake.

WARNING

Slight rolling back on uphill slopes

If the vehicle comes to a standstill on steep gradients without the driver applying the footbrake, the vehicle can roll back until the HOLD function stops it. In this situation it is possible to reduce the roll-back by applying the footbrake.

- ▶ Increase the braking force with the footbrake to support stopping.

Responding to warning messages

Always heed any warning and information messages displayed in the vehicle.

- ▶ Please refer to chapter "Warning and information messages" on page 271.

Operating principle

The HOLD function assists the driver when stopping and driving off on upward slopes. The vehicle is automatically prevented from rolling back away from the desired direction of travel.

When the HOLD function is active, the indicator light **HOLD** on the instrument cluster comes on.

When Adaptive Cruise Control (ACC) is operating normally, the HOLD function actively holds the vehicle at a standstill following automatic braking.

If the driver seat belt is unfastened and the driver door is opened while the HOLD function is active, the parking lock and parking brake are activated automatically.

If the vehicle is held on an upward slope, you can drive off in the usual way.

Activating the HOLD function

- ✓ Drive position **D** or **R** selected.
- ▶ Press the brake pedal until the vehicle comes to a standstill.

The HOLD function is activated. The vehicle is held stationary even without pressing the brake pedal.

Information

The HOLD function can also be activated, irrespective of the gradient, by quickly flooring the pressed brake pedal while the vehicle is stationary. Changing the drive position will not deactivate the HOLD function in this case.



Information

When the HOLD function is active, the driver may feel a difference in the brake pedal, and hydraulic noises may be heard.

This behaviour is normal for the system. It is not a fault.

Home screen and MyScreen

Configuring Home screen

1.  ►  ► **Modify sorting**
2. Select, hold and move the desired tile to any position via drag & drop.
3. Touch **Confirm**.



The main applications **Navigation, Media, Phone, Setting** and **Apple CarPlay** cannot be moved.

Configuring MyScreen



Fig. 88: Areas of MyScreen

The different areas of the second page of the Home screen (MyScreen) can be personalised.

1. Swipe to the left in the Home screen .
MyScreen  is displayed.
2.  ► **Configure MyScreen**
3. Select, hold and move the desired category into any area (see **A, B, C**) via drag & drop.
4. A tile can be removed by replacing it with another tile.

For information on operating Porsche Communication Management (PCM):

- Please refer to chapter "Porsche Communication Management (PCM)" on page 190.

instrument cluster

Instrument cluster overview

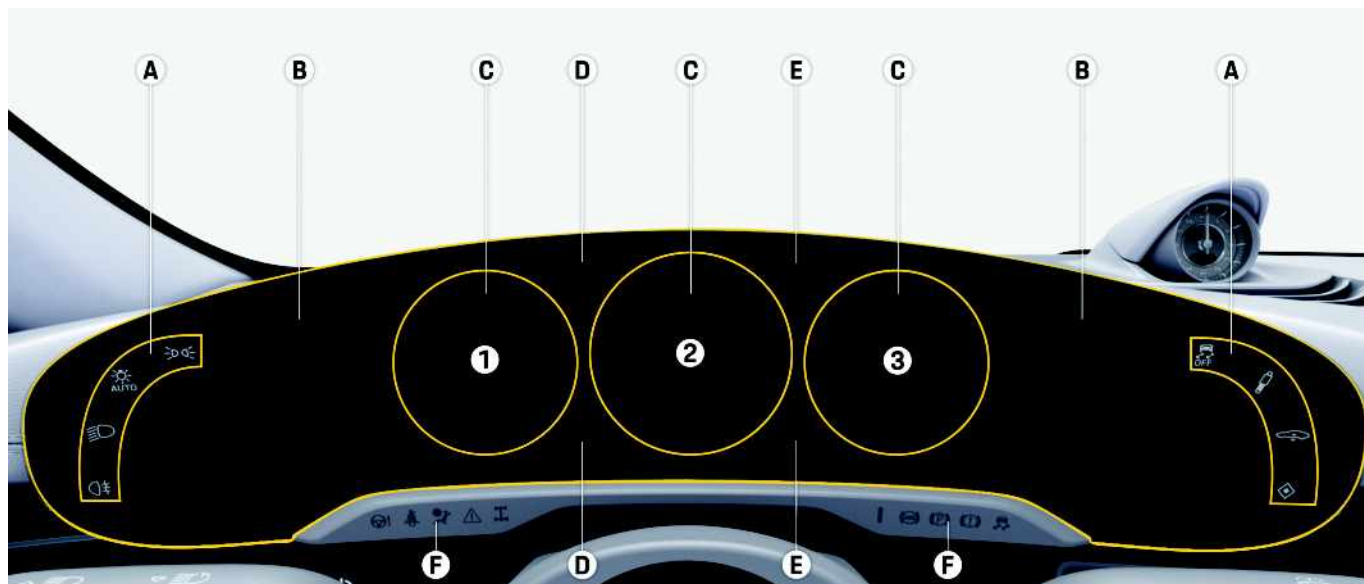

Fig. 89: Instrument cluster

The fully digital instrument cluster is divided into 3 tubes (C) and has capacitive touch buttons (A) on the outer edges (light, vehicle settings and \diamond -button). The temperature, time and date can be displayed between the outer tubes and the capacitive touch buttons (B). There are various warning and indicator lights (F) on the lower edge of the instrument cluster. Additional warning and indicator lights can be found in areas D (Assistance & Systems) and E (Driving & Entertainment).

Using the tube menu

You can toggle between tubes and select menu options using the multi-function steering wheel.

► Please refer to chapter "Operating the instrument cluster" on page 129.

List entries are displayed in different colours:

- White: List entry available
- Blue: List entry selected
- Grey: List entry not available.

Tube 1 – Speed & Assist display

Information on assistance systems and vehicle-related information is shown in the left tube 1.

Tube 2 – Power meter

Information on the drive power, speed, battery charge level and navigation is shown in the middle tube 2. The tube display can be changed and expanded to tubes 1 and 3 in some cases:

- A – Power meter (can be personalised and configured)
- B – Night View Assist
- C – Map
- D – Extended map (Full HD map across all three tubes)
- E – Reduced view

The current electric drive power (from "12 o'clock" to "6 o'clock" position) and the current recuperation capacity (from "12 o'clock" to "9 o'clock" position anti-clockwise) is shown in the Power meter. The display can be activated and deactivated.

- ▶ Please refer to chapter "Instrument cluster display content" on page 131.

Tube 3 – Car & Info display

Information on navigation, driving programme and media as well as messages are shown in the right tube 3. Incoming calls can also be displayed in this tube.

Configuring the information area

You can select four of the many items of vehicle information for display in tube 3.

Central display

- ▶ Touch  ▶ Setting  ▶ Displays ▶ Instrument cluster ▶ Customised view.

- Current charge state High-voltage
- Battery temperature High-voltage
- Electrical system voltage 12-volt
- GPS altitude
- Compass
- Lateral acceleration
- Longitudinal acceleration

- Delay
- Date
- Phone
- Station/track
- Arrival
- Driving time and distance

Identification for location of charge port door



The vehicle has up to two charging sockets (one on the driver's side and one on the passenger's side, depending on country and vehicle equipment). The arrow points towards the side of the vehicle on which the direct current (DC) charge port door is located. Please refer to chapter "Charging high-voltage battery" on page 79.

Warning and indicator lights

NOTICE

Faults are indicated by the warning lights. The corresponding warning light only goes out when the cause of the fault has been rectified.

Consult a qualified specialist workshop in the following cases:

- The warning light does **not** come on briefly when switched on.
- The warning light comes on or flashes when the vehicle is switched on or is in motion.
- ▶ Porsche recommends a Porsche partner as they have trained workshop personnel and the necessary parts and tools.

When certain warning lights appear, an additional acoustic signal sounds.

In response to certain events, additional messages appear in the instrument cluster that have high priority for the driver or serve information purposes. These messages must be acknowledged before the tube menu can be opened.

- ▶ Please refer to chapter "Operating the instrument cluster" on page 129.
- ▶ Please refer to chapter "Warning and information messages" on page 271.

The following warning and indicator lights are available depending on the vehicle equipment:



Warning light if there is no steering activity

- ▶ Actively take over steering.
- ▶ Please refer to chapter "Active Lane Keeping" on page 30.
- ▶ Please refer to chapter "Lane Keep Assist" on page 144.



Coolant temperature warning light

The coolant temperature is too high.

- ▶ Do not keep driving. Stop safely in a suitable place.
- ▶ Turn the vehicle off and allow it to cool down.
- ▶ Check the radiators and air guides in and around the vehicle for obstructions. Check the coolant level.
- ▶ Have the fault remedied immediately at a qualified specialist workshop.¹
- ▶ Please refer to chapter "Coolant" on page 97.

1. Porsche recommends a Porsche partner as they have trained workshop personnel and the necessary parts and tools.

**Porsche Active Suspension Management (PASM) warning light**

The Porsche Active Suspension Management (PASM) function could be faulty.

Limited and adapted driving possible.

- ▶ Adapt your driving style to the situation.
- ▶ Have the fault rectified immediately at a qualified specialist workshop.¹
- ▶ Please refer to chapter "Porsche Active Suspension Management (PASM)" on page 187.

**Airbag warning light**

Airbag system could be faulty.

- ▶ Have the fault remedied immediately at a qualified specialist workshop.¹
- ▶ Please refer to chapter "Airbag systems" on page 40.

**Seatbelt warning light**

Seatbelt is not fastened or is fastened incorrectly.

- ▶ Fasten seatbelt correctly.
- ▶ Please refer to chapter "Seat Belts" on page 220.

**Brake system warning light**

If the warning light is **on** constantly or is **flashing**: The brake system is faulty. The brake fluid level may be too low.

- ▶ Have the fault remedied immediately at a qualified specialist workshop.¹
- ▶ Please refer to chapter "Brakes" on page 61.
- ▶ Please refer to chapter "Brake Fluid" on page 60.

**Critical charge level warning light**

The high-voltage battery charge level is 7% or less.

- ▶ Charge the high-voltage battery immediately.
- ▶ Please refer to chapter "Charging high-voltage battery" on page 79.

**Charge level warning light**

The high-voltage battery charge level is 20% or less.

- ▶ Charge the high-voltage battery as soon as possible.
- ▶ Please refer to chapter "Charging high-voltage battery" on page 79.

**Warning light indicating a critical high-voltage battery defect**

A critical defect has been detected in the high-voltage battery.

- ▶ Stop the vehicle immediately in a suitable place.
- ▶ Do not keep driving. Stop safely in a suitable place and shut off the vehicle.
- ▶ Call a roadside assistance service or have your vehicle towed.
- ▶ Have the fault remedied immediately at a qualified specialist workshop.¹

**Warning light indicating a high-voltage battery defect**

A defect has been detected in the high-voltage battery.

- Limited and adapted driving possible.
- ▶ Adapt your driving style to the situation.
- ▶ Have the fault remedied promptly at a qualified specialist workshop.¹

**Warning light indicating that a critical drive or charging system is defective**

A critical defect has been detected in the vehicle's drive or charge system.

- ▶ Stop the vehicle immediately in a suitable place.
- ▶ Do not keep driving. Stop safely in a suitable place and shut off the vehicle.
- ▶ Call a roadside assistance service or have your vehicle towed.
- ▶ Have the fault remedied immediately at a qualified specialist workshop.¹

**Warning light indicating that a drive or charging system is defective**

A defect has been detected in the vehicle's drive or charging system. Limited and adapted driving possible.

- ▶ Adapt your driving style to the situation.
- ▶ Have the fault remedied promptly at a qualified specialist workshop.¹

**Central warning light**

At least one warning message is displayed or saved.

- ▶ Please refer to chapter "Warning and information messages" on page 271.

**Brake pad wear warning light**

Brake pads are worn. Limited and adapted driving possible.

- ▶ Have the brake pads replaced by a qualified specialist workshop as soon as possible.¹
- ▶ Please refer to chapter "Brakes" on page 61.

1. Porsche recommends a Porsche partner as they have trained workshop personnel and the necessary parts and tools.

A
B
C
D
E
F
G
H
I
J
K
L
M
N
O
P
Q
R
S
T
U
V
W
X
Y
Z



Electric parking brake warning light

If the warning light **is on** constantly or is flashing: The electric parking brake is on. If the warning light **is flashing**: The brake system is faulty.

- ▶ If the fault occurs frequently or continuously, have it remedied at a qualified specialist workshop.¹
- ▶ Please refer to chapter "Porsche Stability Management (PSM)" on page 206.
- ▶ Please refer to chapter "Brakes" on page 61.



Anti-lock brake system warning light

Anti-lock brake system (ABS) or Porsche Stability Management (PSM) failure. The brake booster could be defective. Limited and adapted driving possible.

- ▶ Avoid any abrupt braking if at all possible. Allow for a longer braking distance.
- ▶ Have the fault remedied promptly at a qualified specialist workshop.¹
- ▶ Please refer to chapter "Porsche Stability Management (PSM)" on page 206.



Porsche Stability Management warning light

Warning light **is flashing**: controlled Porsche Stability Management (PSM) braking process. Please refer to chapter "Porsche Stability Management (PSM)" on page 206. Warning light **is flashing** continuously:

Porsche Stability Management (PSM) failure.

Limited and adapted driving possible.

- ▶ Avoid hard acceleration, deceleration and curving speeds in extreme driving situations
- ▶ If the fault occurs frequently or continuously, have it remedied at a qualified specialist workshop.¹
- ▶ Please refer to chapter "Porsche Stability Management (PSM)" on page 206.

Steering system warning light

The steering system could be faulty. Limited and adapted driving possible.

- ▶ Adapt your driving style to the situation.
- ▶ Have the fault remedied promptly at a qualified specialist workshop.¹

AWD system warning light

A defect has been detected in the vehicle's AWD system. Limited and adapted driving possible.

- ▶ Adapt your driving style to the situation.
- ▶ Have the fault remedied promptly at a qualified specialist workshop.¹

Restricted drive power warning light

Drive power is restricted. The high-voltage battery may not be sufficiently charged or is at its operating temperature limits, such as in very cold outdoor temperatures.

Tyre pressure warning light

During the learning process for newly fitted wheels or tyre pressure sensors, the warning light may flash or light up in

the event of pressure loss in one or more tyres, a fault or a temporary malfunction of the Tyre Pressure Monitoring (TPM) system.

- ▶ Adapt your speed and driving style and speed to the situation. Avoid any heavy braking or steering manoeuvres.
- ▶ Stop safely in a suitable place and shut off the vehicle: Check the indicated tyre for damage. Add sealant if necessary. Set the correct tyre pressure at the next opportunity.
- ▶ If the fault occurs frequently or continuously, have it remedied immediately at a qualified specialist workshop.¹

E-Sound warning light

E-Sound deactivated.

- ▶ Drive extremely carefully, as other road users may not be able to hear your vehicle while driving under electric power.
- ▶ Have the fault remedied promptly at a qualified specialist workshop.¹
- ▶ Please refer to chapter "Vehicle settings" on page 257.

Distance warning light

Safety hazard by driving too closely to the car in front.

- ▶ Please refer to chapter "Warn and Brake Assist (WBA)" on page 267.



1. Porsche recommends a Porsche partner as they have trained workshop personnel and the necessary parts and tools.

**Warn and Brake Assist warning light**

Warn and Brake Assist operation is limited.

Limited and adapted driving possible.

► Adapt your driving style to the situation.

► If the fault occurs frequently or continuously, have it remedied at a qualified specialist workshop.¹

► Please refer to chapter "Warn and Brake Assist (WBA)" on page 267.

**Porsche Dynamic Light System Plus (PDLS Plus) warning light**

Porsche Dynamic Light System Plus (PDLS Plus) operation is faulty.

Limited and adapted driving possible.

► Adapt your driving style to the situation.

► If the fault occurs frequently or continuously, have it remedied at a qualified specialist workshop.¹

**Lights warning light**

Vehicle lighting may be faulty.

Limited and adapted driving possible.

► Adapt your driving style to the situation.

► Have the fault remedied promptly at a qualified specialist workshop.¹

**Lane Change Assist indicator light**

Lane Change Assist is on. Please refer to chapter "Lane Change Assist (LCA)" on page 139.

**Night View Assist indicator light**

Night View Assist is on. Please refer to chapter "Night View Assist" on page 171.

**HOLD function indicator light**

The HOLD function is activated. The vehicle is automatically held stationary.

► Please refer to chapter "HOLD function" on page 123.

**Operational readiness indicator light**

Vehicle is ready to drive.

► Please refer to chapter "Starting, driving and stopping the vehicle" on page 236.

**Dynamic High Beam Assist indicator light**

Dynamic High Beam Assist is switched on. High beams are switched on and off automatically depending on the traffic situation.

► Please refer to chapter "Lights" on page 147.

**High beam indicator light**

The high beams are switched on.

► Please refer to chapter "Lights" on page 147.

**Rear fog light indicator light**

The rear fog lights are switched on.

► Please refer to chapter "Lights" on page 147.

**Direction indicator, left****Direction indicator, right**

Warning and information messages

In response to certain events, messages appear on the instrument cluster that have high priority for the driver or serve information purposes. These messages must be acknowledged before the tube menu can be opened.

- Please refer to chapter "Operating the instrument cluster" on page 129.
- Please refer to chapter "Warning and information messages" on page 271.

Operating the instrument cluster

**WARNING**

Setting and operating while driving

Setting and operating the multi-function steering wheel, infotainment system, etc. while driving may distract you from the traffic situation. You may lose control of the vehicle.

- Only operate these components while driving if the traffic situation allows you to do so safely.
- In case of doubt, safely pull out of traffic and only carry out extensive operations and settings while the vehicle is stationary.

The instrument cluster is only active when the ignition is switched on. For safety reasons, some functions are only available when the vehicle is stationary.

1. Porsche recommends a Porsche partner as they have trained workshop personnel and the necessary parts and tools.

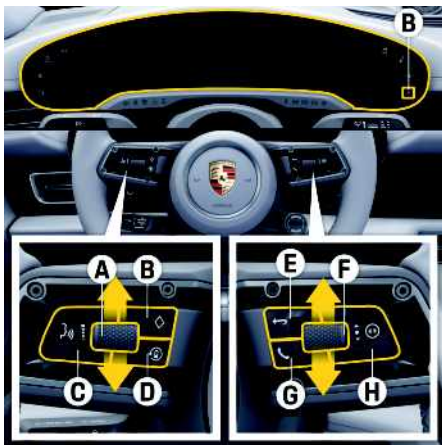

Fig. 90: Operating the instrument cluster with the multi-function steering wheel

A – Adjusting the volume and muting the audio source

- ▶ Adjusting the volume: Turn rotary knob A upwards or downwards.
- ▶ Mute: Press rotary knob A.

B – Calling up a stored function

Assigning quick access buttons

The button on the steering wheel and in the instrument cluster can be assigned individually.

- ▶ Press and hold button B (◊ button) to adjust the settings in the central display.
 - ▷ Please refer to chapter "Vehicle settings" on page 257.

C – Calling up voice control

- ▶ Press button C.

- ▷ Please refer to chapter "voice control" on page 264.

D – Recuperation button

- ▶ Press button D to gradually adjust the recuperation mode.
 - or –
 - Press and hold button D to switch on automatic recuperation.
- ▶ Please refer to chapter "Energy recovery (recuperation)" on page 237.

E – Go back one or more selection levels in the menu selection, acknowledge notifications

- ▶ Press Back button E.
- ▶ Please refer to chapter "Notifications" on page 173.

F – Scroll and select menus and functions in the tubes

- ▶ To scroll: Turn the rotary knob F up or down to scroll through the menu of the respective tube.
- ▶ Select/Enter: Press rotary knob F.

G – Accepting and ending a call

- ▶ Press button G. To exit, press and hold button G.
 - ▷ Please refer to chapter "Phone" on page 182.

H – Switching between the tubes

- ▶ Press button H.

Selecting options and activating functions

A preceding symbol indicates whether an option is selected or a function is activated.

Selecting one of several options

- Option is selected.
- Option is not selected.

Activating and deactivating a function

- Function is activated.
- Function is deactivated.

Adjusting view on the instrument cluster

The content that is displayed can be configured:

- ▶ ▶ Setting ▶ Display settings ▶ Instrument cluster

Instrument cluster display content

Certain displays are only available when the vehicle is stationary.

Not all functions are explained in detail in this Driver's Manual. The examples clearly demonstrate the operating principle and clarify the menu structure. On the first level, the menu is displayed by turning the rotary knob up/down. On the second level, push the rotary knob and you will then be able to scroll through the menu. Press the Back button to exit the second level and view the display content.

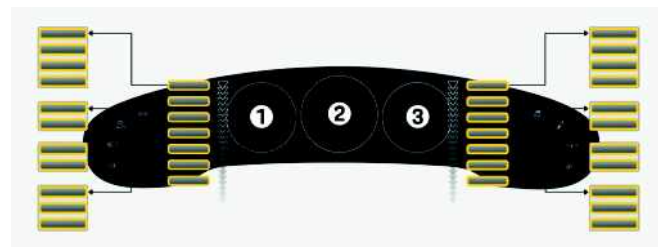

Fig. 91: Instrument cluster display content

Tube	Display	What can I do?/What is displayed?	Where?
1	▶ Assistance systems	Activate and display Lane Keep Assist - active lane guidance.	▷ p. 144 ▷ p. 30
		Choose between Porsche InnoDrive, Adaptive Cruise Control (ACC) or Speed Limiter (LIM) and display it.	▷ p. 199 ▷ p. 34 ▷ p. 230
1	▶ Traffic signs	Display up to 3 current traffic signs.	▷ p. 247
1	▶ G-Force	Display the current and maximum longitudinal and lateral acceleration forces in the form of a circular diagram and reset them.	–
1	▶ All-wheel	Display the current torque distribution between the front and rear axle in the form of bar diagrams.	–
1	▶ Tyre info	Display the current tyre pressure and pressure difference.	▷ p. 249
1	▶ PDCC	Display roll stabilisation status.	–
1	▶ Mileage	Display odometer.	–

A	Tube	Display	What can I do?/What is displayed?	Where?
B	2	▶ Range display	Display remaining range.	▷ p. 168
C			The charge level of the high-voltage battery is also indicated by a symbol. Meaning:	
D			– White symbol: Charge level greater than 20%	
E			– Yellow symbol: Charge level less than 20%	
F			– Red symbol: Charge level less than 7%	
G				
H				
I				
J	2	▶ Speedometer	Display the speedometer.	–
K	2	▶ Power meter / Map display / Night View Assist	The instrument cluster display view can be changed and expanded using the tubes:	▷ p. 125
L			– Display Power meter (standard view)	
M			– Display Night View Assist with thermal image detection	
N			– Show and adapt the map display	
O			– Show and adapt the extended map (Full HD map)	
P			– Display reduced view	
Q				
R				
S	3	▶ Navigation	Display and select navigation information (turn-off instructions, etc.).	▷ p. 165
T				
U	3	▶ Trip	Display and reset driving data (average fuel consumption, range, driving time, etc.).	–
V				
W				
X	3	▶ Media	Display current media (e.g. radio).	▷ p. 157
Y	3	▶ Sport Chrono		▷ p. 234
Z				

Tube	Display	What can I do?/What is displayed?	Where?
3	▶ Sport Chrono	Measure times with the stopwatch.	▷ p. 234
3	▶ Drive mode	Display selected driving programme.	▷ p. 106
3	▶ Telephone	If a phone is connected, incoming calls are shown, for example.	▷ p. 182

Interior lighting

Adjusting brightness

Central display

- ▶  ▶ Settings ▶ Vehicle settings ▶ Light and visibility ▶ Interior lighting ▶ Brightness Adjusting the brightness of the interior lighting.

Switching interior lighting on and off

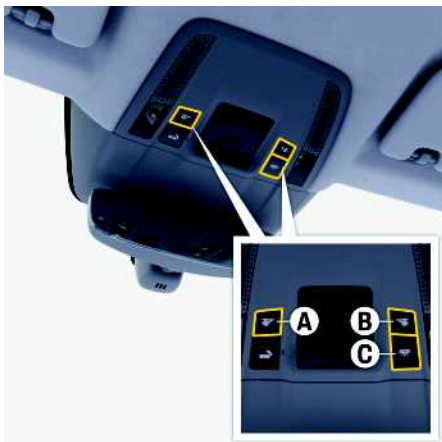

Fig. 92: Operating interior lighting

- A** Button for front left reading light
- B** Button for front right reading light
- C** Button for front and rear interior lights



Fig. 93: Operating reading lights

Switching front and rear interior lighting on and off

- ▶ Press the **C** button.

Switching reading lights on and off

Front reading lights

- ▶ Press the **A** or **B** button.

Rear reading lights

- ▶ Press the **D** button above the relevant door.

Adjusting brightness

- ▶ Press and hold the button for the relevant light for at least 1 second until the desired brightness is achieved.

Switching interior lighting on and off automatically

- ▶  ▶ Settings ▶ Vehicle settings ▶ Light and visibility ▶ Interior lighting ▶ Activate interior lighting during locking or unlocking.

When it is dark, the interior lighting is switched on in the following situations:

- When the vehicle is unlocked or a door is opened
- After turning off the vehicle

The interior lighting is dimmed and switched off again in the following situations:

- after readiness for operation is established
- after locking the vehicle

The interior lighting is switched off again in the following situations depending on the fade-out duration selected:

- after all doors are closed
- automatically approx. 10 minutes after the interior lighting is switched on

Setting the fade-out duration for the interior lighting

- ▶  ▶ Settings ▶ Vehicle settings ▶ Light and visibility ▶ Interior lighting ▶ Set the fade-out duration.

Switching ambient lighting on and off

Switching ambient lighting on and off

1.  ▶ Comfort ▶ Ambient lighting.
2. Activate **switching lighting on**.

Setting colour of ambient lighting

1.  ▶ Comfort ▶ Ambient lighting.
2. Select **Colour**.
3. Set the desired light colour.

Adjusting brightness of ambient lighting

Setting the brightness throughout the passenger compartment

1.  ► **Comfort** ► **Ambient lighting**.
2. Touch **Overall brightness**.
3. Set the desired brightness value.

Setting the brightness in individual passenger compartment areas

1.  ► **Comfort** ► **Ambient lighting**.
2. Touch **Cupholder, Doors, Centre console** or **Footwell**.
3. Set the desired brightness value.

Intersection Assist

General Safety Instructions



WARNING

Restricted detection around the vehicle

Detection of the area around the vehicle by the sensors (e.g. camera, radar) may be restricted by different influencing factors (e.g. rain, snow, ice, heavy water spray, oncoming headlights, dirt or damage). As a result, warnings might not be activated.

- ▶ Drive with extreme care.
- ▶ Always pay attention to the traffic situation and the area around the vehicle.
- ▶ Clean the front camera lens and front radars regularly and keep them free of snow and ice.
- ▶ Do not cover the sensors.
- ▶ Check the windscreen for damage in the area of the camera lens at regular intervals.



WARNING

No warning jolt

When PSM is switched off, no warning jolt is triggered ahead of a possible collision. In this case, the system only warns the driver by issuing a visual and acoustic warning.

- ▶ Adapt your driving style and driving manoeuvres to the current situation.

System limitations



WARNING

System is subject to limited availability

The assistance provided by the system cannot be guaranteed in certain situations. Such situations

include:

- Pedestrians and animals are not detected.
- Cyclists may not always be detected.
- Vehicles approaching very fast or very slowly may not always be detected in time.
- Highly reflective surroundings (e.g. steel bridges, railings) can cause incorrect warnings or prevent warnings from being issued.
- Crossing objects that give rise to acceleration or changes in driving style (e.g. sudden turn-offs) can trigger incorrect warnings or prevent warnings from being issued.
- If your vehicle is not facing in the direction of the driving lane when turning off (but is inclined diagonally, at a right angle to it or sharply upwards or downwards), approaching vehicles may not be detected or may not be detected in time.
- When your vehicle pulls away from a stationary position, a turn-off may under certain circumstances not be recognised or recognised late. The system's assumed move straight ahead can result in the issue of a false collision warning.
- ▶ Drive with extreme care.
- ▶ Always pay attention to the traffic situation and the area around the vehicle.

Responding to warning messages

Always heed any warning and information messages displayed in the vehicle.

- ▶ Please refer to chapter "Warning and information messages" on page 271.

Operating principle

Intersection Assist monitors the areas to the front and sides of the vehicle at intersections and exits. This monitoring is performed by the camera and radar sensors integrated into the vehicle.

In the event of a potential collision, the system warns the driver via the instrument cluster and the central display by means of visual and acoustic signals as well as a brief warning jolt where necessary.

Display elements

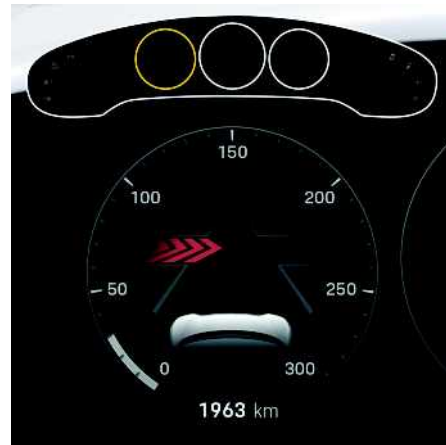

Fig. 94: Intersection Assist display on the instrument cluster

If the system detects a possible collision, it can warn the driver by issuing a warning tone and displaying a warning in the instrument cluster.

In the event of a possible collision, red arrows indicate the direction from which the cross traffic is approaching.

- This is indicated in the central display only when ParkAssist is activated.
- The display in the instrument cluster only appears when the **ACC** main menu is activated.

Switching Intersection Assist on and off

Intersection Assist can be switched on and off on the central display.

- ✓ Drive position **D** selected.
- ✓ Speed is not higher than approx. 30 km/h.

▶  ▶ Assistance ▶ Junction Assist

Intersection Assist is automatically active after operational readiness has been established.

A
B
C
D
E
F
G
H
I
J
K
L
M
N
O
P
Q
R
S
T
U
V
W
X
Y
Z

Jack and Lifting Platform raising the vehicle

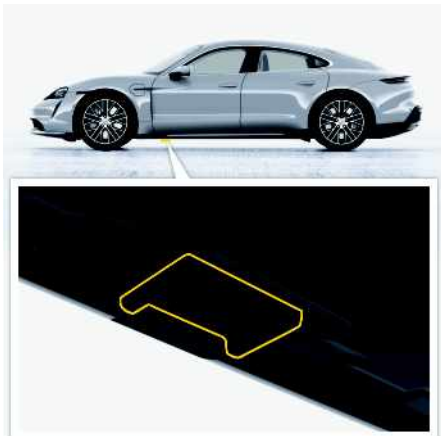

Fig. 95: Front jacking point for jack and lifting platform

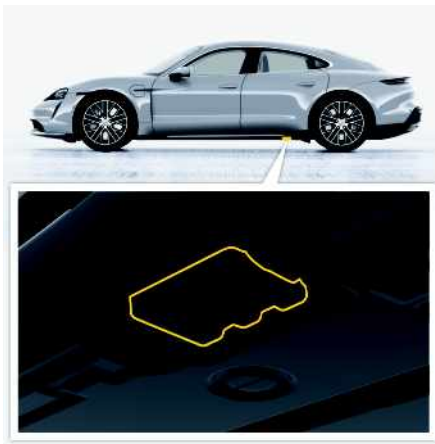

Fig. 96: Rear jacking point for jack and lifting platform

⚠ WARNING

Insufficiently secured vehicle.

A vehicle that is not secured or that is incorrectly secured may move unintentionally or tip or fall off lifting equipment, e.g. jack or lifting platform. This can result in serious injury and damage.

- ▶ The vehicle must be raised using the jack only when on a solid and level surface.
- ▶ Raise the vehicle only at the prescribed jacking points on the vehicle underbody.
- ▶ Always place the vehicle on solid supports when working under the vehicle.
- ▶ Activate the electric parking brake when working on the vehicle while it is switched on.

⚠ WARNING

Control operation of the levelling system

A vehicle on which the levelling system is activated can move unexpectedly or tip or fall off lifting

equipment, e.g. a jack or lifting platform. This can result in serious injury and damage.



- ▶ Set the vehicle to the medium level and switch off the levelling system before hoisting the vehicle.

⚠ WARNING

Lifting the vehicle

If a PASM or hot vehicle warning message is displayed, there is a risk of injuries and damage to the vehicle if the vehicle is hoisted.

- ▶ The vehicle must only be hoisted when cool.
- ▶ If a PASM warning message is displayed, you should not perform any work on the chassis yourself. Call in a qualified specialist workshop. Porsche recommends a Porsche partner as they have trained workshop personnel and the necessary parts and tools.

- ▶  **Setting**  **Vehicle** ▶ **Additional chassis settings** ▶ **Deactivate chassis adjustment before using a jack**

Lane Change Assist (LCA)

General safety instructions

WARNING

Lack of attention

Even with Lane Change Assist and Rear Turn Assist, absolute care and attention on the part of the driver is still required while driving. Ultimately, the driver is still responsible for changing lanes.

- ▶ Keep the direction of travel and the relevant area around the vehicle in view at all times.

WARNING

Vehicles not detected

Vehicles cannot or may not be detected by the system in time in the following situations:

- The view of the radar sensors may be reduced in adverse weather conditions (rain, snow, ice, heavy spray), in tight bends, and when approaching crests.
- Lane Change Assist will only warn of approaching vehicles or vehicles in the blind-spot area from a speed of approx. 15 km/h (9 mph).
- Vehicles that approach at high speed from behind or vehicles that are falling back.
- If the vehicle is not facing in the direction of the driving lane when turning, but is facing diagonally or at right angles to it, approaching vehicles can no longer be detected by the radar sensors.
- In the case of the Rear Turn Assist, it is possible that, owing to the small differences in speed between your vehicle and moving or stationary objects, fixed objects (e.g. a metal post) may also trigger a warning, or that slow-moving vehicles are not detected.
- The Rear Turn Assist is activated when driving

off. It is therefore possible that vehicles that are already moving or are driving off are not detected or are only detected late. Vehicles already located immediately next to your vehicle and therefore outside of the detection range of the sensor may also not be detected.

- The rear collision warning does not respond to cross traffic, small cross-section vehicles, narrow vehicles, and objects that are not recognised as vehicles.
- ▶ Keep the direction of travel and the relevant area around the vehicle in view at all times.

System limitations

- Only Rear Turn Assist is available at speeds below 15 km/h (9 mph). When driving off, the driver is therefore only supported by monitoring of the area behind the vehicle on the side where the direction indicator was actuated.
- Lane Change Assist and Rear Turn Assist are not available if the system detects that the radar sensors are covered.
- The rear collision warning may be switched off if there is a malfunction in the Lane Change Assist.
- The radar sensors cover the adjacent lane to the left and right. Other lanes are **not** covered by the radar sensors.
- The radar sensors can sometimes detect other objects (e.g. high or raised crash barriers), not just vehicles.

i Information

If the position of the radar sensors was changed following an accident, for example, this can impair the function of Lane Change Assist.

- ▶ Visit a qualified specialist workshop. Porsche recommends a Porsche partner as they have trained workshop personnel and the necessary parts and tools.

i Information

To ensure that Lane Change Assist can work properly:

- ▶ Do not cover the radar sensors on the rear bumper (e.g. with stickers). Also remove any dirt, snow and ice from this area.
- ▶ Do not cover the warning indicator in the exterior mirror (e.g. with stickers).
- ▶ Subsequent painting of the bumper may lead to a reduction in the sensor range owing to the thicker coating layer. The electrical properties may also differ from those of the approved paints.



Fig. 97: Radar sensors in the rear bumper

Responding to warning messages

Always heed any warning and information messages displayed in the vehicle.

- ▶ Please refer to chapter "Warning and information messages" on page 271.

Operating principle

Lane Change Assist (LCA) warns the driver about vehicles approaching from behind or those in the blind-spot area. This applies both when overtaking other vehicles and when your vehicle is being overtaken.

Lane Change Assist measures the distance and speed difference of detected vehicles compared to your vehicle using the radar sensors integrated in the rear bumper. The radar sensors capture an area of up to 70 m to the rear and in the blind-spot area.

As soon as the direction indicator is activated for a lane change regarded as critical, the warning indicator in the respective exterior mirror lights up brightly and briefly several times. The system therefore provides assistance separately for both sides of the vehicle.

When slowly overtaking another vehicle (speed difference of less than approx. 15 km/h (9 mph)), the warning indicator lights up as soon as this vehicle is in your blind-spot area and is detected by Lane Change Assist. If there is a greater speed difference, this is not indicated in the exterior mirror.

Rear Turn Assist is always automatically switched to standby together with Lane Change Assist. The driver is supported by Rear Turn Assist until the Lane Change Assist speed range is reached after driving off.

When the direction indicator is on, Rear Turn Assist detects objects located next to and behind your vehicle, but only at the side on which the indicator has been activated. If a potential hazard is detected, the respective warning indicator on the exterior mirror lights up. If your own calculated driving path crosses that of a detected vehicle on the side of the vehicle on which the indicator has been activated, the corresponding warning indicator on the exterior mirror will flash brightly and briefly several times.

Rear collision warning

If the radar sensors in the rear of the vehicle detect vehicles travelling behind, the system calculates the probability of a rear-end collision.

If a collision risk is detected, the hazard warning lights come on to alert the driver in the vehicle travelling behind to the imminent danger situation.

In this case, the hazard warning lights could flash faster than they normally would when switched on manually.

Display elements

Lane Change Assist provides information by means of two indicator levels, an information level and a warning level, which are activated accordingly depending on whether or not the direction indicator has been set.

Information stage

If the direction indicator is not set, Lane Change Assist informs you about detected vehicles that are considered critical for a possible lane change. The warning indicator on the respective mirror lights up dimly.

Warning stage

If the direction indicator is on and Lane Change Assist has detected a vehicle on this side that it regards as critical, the warning indicator in the exterior mirror on this side will briefly flash **brightly** multiple times. You should check the driving situation again by looking in the exterior mirror and looking over your shoulder.

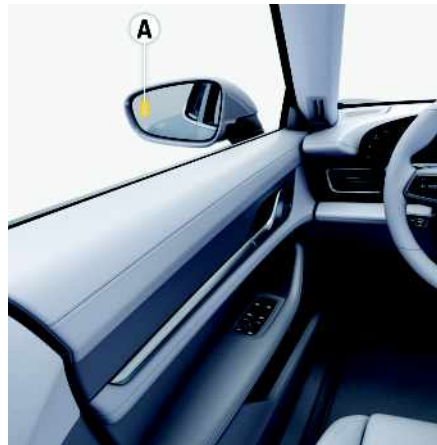

Fig. 98: Warning indicator on the exterior mirror

Switching Lane Change Assist on and off

Lane Change Assist can be switched on and off in the central display.

▶ ▶ Assistance ▶ Lane Change Assist

When Lane Change Assist is active, the symbol appears on the instrument cluster.

Setting display brightness of Lane Change Assist

The brightness of the display in the exterior mirror is adjusted automatically to the ambient brightness. The basic brightness can also be adjusted.

▶ ▶ Assistance ▶ ▶ Assistance system settings ▶ Lane Change Assist ▶ LED brightness

Additional information

Driving situations

The following driving situations describe possible scenarios and the associated Lane Change Assist and Rear Turn Assist warning indicators.

Vehicles approaching quickly

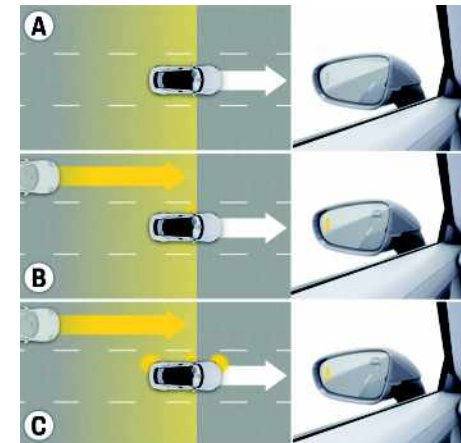

Fig. 99: Vehicle approaching fast

A – Warning indicator in exterior mirror does not light up

The sensors do not detect a vehicle. Warning indicator in exterior mirror does not light up.

B – Warning indicator lights up in the information stage

A fast approaching vehicle – in the left lane in the example – is detected. This vehicle is already regarded as critical for changing lanes due to the significant speed difference, even though it is still a good distance away. Warning indicator in the exterior mirror lights up.

C – Warning indicator flashes in the warning stage

If the direction indicator is switched on in driving situation **B**, the warning indicator in the exterior mirror flashes briefly several times. Lane Change Assist alerts you to the fact that you may have overlooked a vehicle.

Vehicles approaching slowly

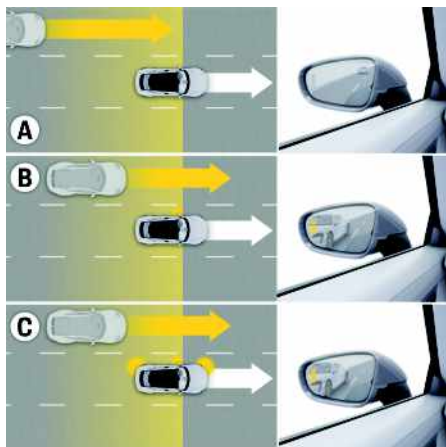

Fig. 100: Vehicle approaching slowly

A – Warning indicator in the exterior mirror does not light up

A slowly approaching vehicle – in the left lane in the example – is detected. Due to the small speed difference and the large distance, the warning indicator in the exterior mirror does not light up.

B – Warning indicator lights up in the information stage

The slowly approaching vehicle is now closer. Warning indicator in the exterior mirror lights up. Only when Lane Change Assist regards the speed difference and distance as critical for changing lanes does

the warning indicator in the exterior mirror light up. You are alerted to all vehicles detected by Lane Change Assist when they are in the blind-spot area at the latest.

C – Warning indicator flashes in the warning stage

If the direction indicator is switched on in driving situation **B**, the warning indicator in the exterior mirror flashes briefly several times. Lane Change Assist alerts you to the fact that you may have overlooked a vehicle.

Vehicles falling back slowly

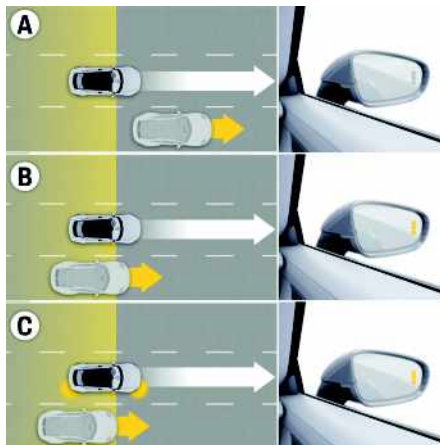

Fig. 101: Vehicle falling back slowly

A – Warning indicator in the exterior mirror does not light up

The overtaken vehicle is not yet detected. Warning indicator in the exterior mirror does not light up.

B – Warning indicator lights up in the information stage

The vehicle on the right that is falling back slowly (speed difference of less than approx.

15 km/h (9 mph)) – in the right lane in the example – is detected. Warning indicator in the exterior mirror lights up.

C – Warning indicator flashes in the warning stage

If the direction indicator is switched on in driving situation **B**, the warning indicator in the exterior mirror flashes briefly several times. Lane Change Assist alerts you to the fact that you may have overlooked a vehicle.

Vehicles falling back quickly

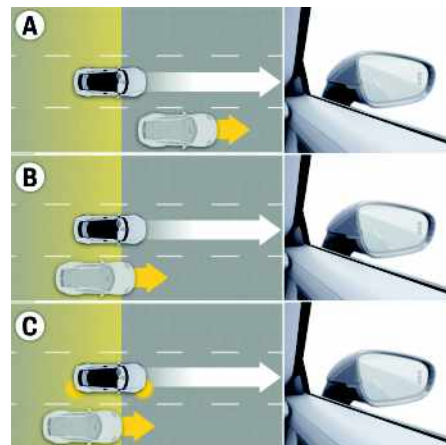

Fig. 102: Vehicle falling back quickly

A – Warning indicator in the exterior mirror does not light up

The overtaken vehicle is not yet detected. Warning indicator in the exterior mirror does not light up.

B – Warning indicator in the exterior mirror does not light up

The vehicle on the right that is falling back fast (speed difference of more than approx. 15 km/h (9 mph)) – in the right lane in the example

– is detected, but is not regarded as critical for changing lanes because it is falling back fast. Warning indicator in the exterior mirror does not light up.

C – Warning indicator in the exterior mirror does not light up

If the direction indicator is switched on in driving situation **B**, the warning indicator in the exterior mirror is still not activated.

Pulling away to turn off

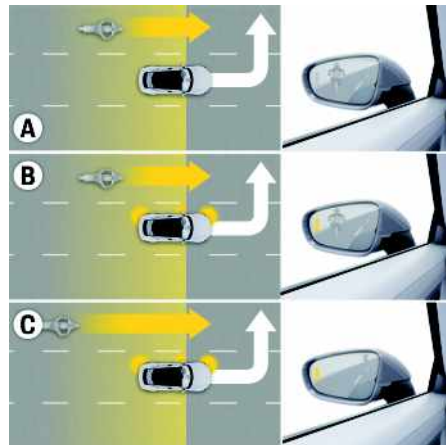

Fig. 103: Pulling away to turn off

A – Warning indicator in the exterior mirror does not light up

The direction indicator has not been actuated. The rear turn assist is therefore not active after driving off and the motorbike located in the blind spot is not detected. A fast approaching vehicle may not be detected as well. Warning indicator in the exterior mirror does not light up.

B – Warning indicator lights up in the information stage

If the relevant direction indicator is switched on in driving situation **A**, the warning indicator in the exterior mirror lights up. Turn Assist alerts you to the fact that you may have overlooked a vehicle.

C – Warning indicator flashes in the warning stage

If, in driving situation **B**, the driver has initiated turning off by steering to the corresponding side and this results in his own calculated driving path crossing that of a detected vehicle, the warning indicator in the exterior mirror flashes briefly several times and then lights up. This warns you of a potential collision with a vehicle that may have been overlooked.

Driving around bends

When driving around a bend, Lane Change Assist may react to a vehicle driving in the next lane but one and the warning indicator in the exterior mirror may light up.

Lane Change Assist cannot detect vehicles in tight bends.

- ▶ Be particularly careful when driving around bends.

Lane width

When driving on narrow lanes, the detection area may cover even more lanes, particularly when driving at the edge of a lane. In such situations, vehicles driving two lanes away may be detected and Lane Change Assist may switch to the information or warning stage.

Likewise, when driving on very wide lanes, vehicles in the adjacent lane may not be detected as they are outside the detection area.

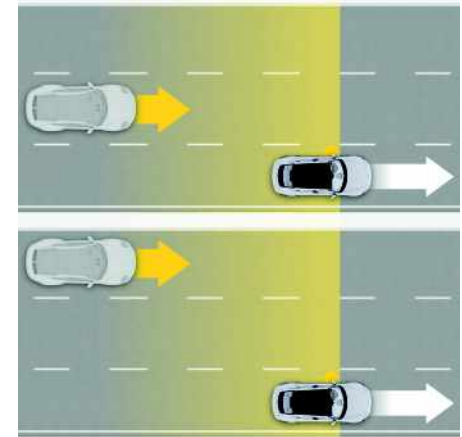

Fig. 104: Lane width and detection area

Lane Keep Assist

General safety instructions

WARNING

Lack of attention

The system can assist the driver within its limits to keep the vehicle in its lane, but it does not drive itself. The driver remains responsible at all times when driving, e.g. for staying in the lane, despite Lane Keep Assist being active. The system is no substitute for attention on the part of the driver.

- ▶ Drive especially carefully and keep your hands on the steering wheel at all times in order to always be ready to steer.
- ▶ Always pay attention to the traffic situation and the area around the vehicle.
- ▶ If a warning message appears on the instrument cluster, take over control of the vehicle yourself immediately.
- ▶ Adapt your driving speed to road and weather conditions.
- ▶ Do not attach any objects to the steering wheel.

WARNING

No or very little steering intervention

In the event of heavy braking, corrective steering intervention may fail to take place. Likewise, in the case of active steering by the driver, corrective steering intervention can be reduced or may not take

place.

- ▶ Drive especially carefully and keep your hands on the steering wheel at all times in order to always be ready to steer.
- ▶ Always pay attention to the traffic situation and the area around the vehicle.
- ▶ If a warning message appears on the instrument cluster, take over control of the vehicle yourself immediately.

WARNING

Insufficient corrective steering intervention

Corrective steering intervention alone may not be sufficient to keep the vehicle in the driving lane in the case of track ruts, winding roads, inclined road surfaces or crosswinds.

- ▶ In such situations, assist by steering actively.
- ▶ Drive with extreme care.
- ▶ Always hold the steering wheel with both hands.



Information

- ▶ If there is a fault in the system or if Lane Keep Assist does not function as described in this section, do not use Lane Keep Assist. Visit a qualified specialist workshop. Porsche recommends a Porsche partner as they have trained workshop personnel and the necessary parts and tools.

System limitations

WARNING

Physical limits and system limits

In some situations, the system may not detect the lane properly, the corrective steering intervention may not be sufficient to keep the vehicle in the lane,

or the functional status can suddenly change from active to passive. Risk of accident! Such situations include:

- when increased attention is required on the part of the driver
- during sporty driving
- in adverse weather conditions (e.g. fog, snow or heavy rain)
- in unfavorable road conditions (including road surface state, pot holes, dirty road surface)
- in areas with roadworks
- when approaching humps and dips
- in urban traffic
- on winding and narrow country roads
- ▶ Do not use the system in these situations.

WARNING

Impaired camera view

Camera vision can be impaired by various factors (e.g. rain, snow, ice, heavy spray, oncoming headlights or damage). Under certain conditions, the camera cannot detect the lane markings, or cannot detect them correctly. In this case, no steering intervention or unexpected steering intervention can occur. Steering intervention can only take place on the side where a lane marking has been detected. Other road structures or objects may also be incorrectly identified as lane markings. This can lead to unexpected or

missing steering interventions/acoustic warnings.

- ▶ Drive with extreme care.
- ▶ Keep the direction of travel and the lane lines in view at all times.
- ▶ Clean the camera lens regularly and keep it free from snow and ice.
- ▶ Do not cover the camera lens.
- ▶ Check the windscreen for damage in the area of the camera lens at regular intervals.

System is subject to limited availability

The system may enter into a passive status in the following situations:

- The vehicle speed is below the activation speed of approx. 65 km/h (40 mph).
- The markings of the current lane are not detected. (e.g. in the case of snow, dirt, wet, on-coming headlights or a vehicle close ahead).
- The quality of the lane markings is not sufficiently good for activation of Lane Keep Assist.
- The radius of a bend is too small.
- The distance to the nearest lane marking is too great.
- The lane markings are too close to the vehicle.
- Temporarily in conjunction with an extremely dynamic driving style.
- The direction indicator is actuated.
- The system has detected that your hands are not on the steering wheel.

Responding to warning messages

Always heed any warning and information messages displayed in the vehicle.

- ▶ Please refer to chapter "Warning and information messages" on page 271.

Operating principle



Fig. 105: Windscreen camera

The Lane Keep Assist helps the driver to keep the vehicle in the lane. To do this, the system uses front camera **A** to detect the course of the road ahead based on the lane markings and initiates corrective steering intervention to keep the vehicle in the lane whenever it nears a detected lane marking and is in danger of leaving the lane. The driver can override the steering intervention at any time, however.

If the vehicle crosses a lane marking without using the direction indicator, the system can provide the driver with an acoustic warning. To do this, the acoustic warning must be enabled in the central display. The system will not issue a warning or steer if the driver uses the direction indicator before crossing a lane marking. In such situations, it interprets the lane change as intentional.

The system is designed for driving on motorways and well-surfaced country roads and works in a speed range of approx. 40 mph (65 km/h) - 156 mph (250 km/h).

Vehicles with Lane Change Assist

If the vehicle is equipped with Lane Change Assist, the active system warns the driver through corrective steering intervention when changing lanes in a potentially critical situation. Steering intervention also occurs if the direction indicator is actuated for

the relevant direction. If the steering intervention is overridden by the driver, an additional warning is provided via a warning signal (if enabled).

Behaviour if there is no steering activity

The driver's steering behaviour is monitored when Lane Keep Assist is switched on and active. If there is no steering activity (e.g. hands not on the steering wheel or only resting lightly), a warning appears on the instrument cluster. The system prompts the driver to actively take over steering. If the driver does not react to the takeover prompt, the system switches to a passive state.

Controls



Fig. 106: Control stalk for driver assistance systems

- R** Switch driver assistance system on/off
- S** Select driver assistance systems

Display elements

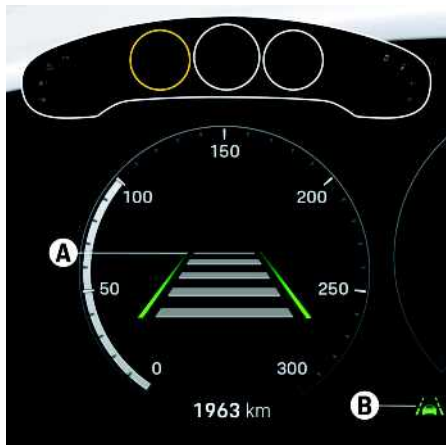

Fig. 107: Lane Keep Assist display

- A Display lane markings (only in vehicles with Adaptive Cruise Control (ACC))
- B Status display

System status icons

Lane Keep Assist display	Status display	Meaning
--------------------------	----------------	---------



Lane Keep Assist is switched on and passive.



Lane Keep Assist is switched on and active on both sides.

Lane Keep Assist display	Status display	Meaning
--------------------------	----------------	---------



The lane markings can also be detected on one side.



Lane Keep Assist performs a corrective steering intervention (example on the right).

If Active Lane Guidance is also activated, a combined indicator may be displayed for both functions instead of the Lane Keep Assist icon.

Switching Lane Keep Assist on and off

1. Press button **R** on the control stalk.
Driver assistance systems are on
2. Press button **S** on the control stalk.
The selection of driver assistance systems appears on the instrument cluster.
3. Select **Lane Keep Assist** using the rotary push button on the steering wheel and press to confirm.

Setting acoustic warning

The acoustic warning can be switched on and off. The warning tone volume can also be selected.

- ▶ ▶ Assistance ▶ ▶ Assistance system settings ▶ Lane departure warning

Lights

Brief overview Lights

This brief overview does not replace the comprehensive descriptions. Safety messages and warnings, in particular, are not replaced by this brief overview.

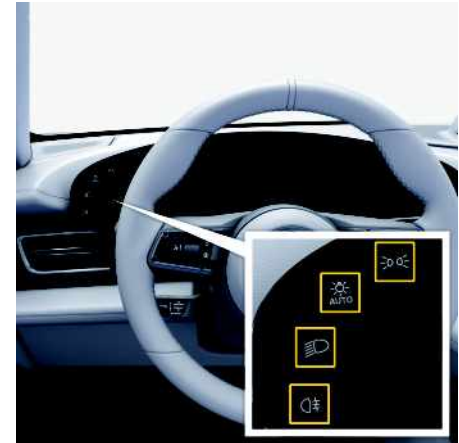









Fig. 108: Light control panel

What do I want to do?	What do I have to do?	Where?
Switch on automatic headlights	<ul style="list-style-type: none"> ▶ Press the  button. <p>The button lights up green. The  pilot light lights up white. Automatic headlights and the Porsche Dynamic Light System Plus (PDLS Plus, depending on equipment) are switched on.</p>	▶ p. 148
Switch on parking light	<ul style="list-style-type: none"> ▶ Press the  button. <p>Number plate light, instrument lighting and side lights are switched on.</p>	–
Switching on dipped beams manually	<ul style="list-style-type: none"> ✓ Operational readiness established. ▶ Press the  button. <p>The button lights up green. The indicator light  goes out. Dipped beams are switched on. Automatic headlights, daytime driving lights and the Porsche Dynamic Light System Plus (PDLS Plus, depending on the equipment) are switched off.</p>	–

A
B
C
D
E
F
G
H
I
J
K
L
M
N
O
P
Q
R
S
T
U
V
W
X
Y
Z

What do I want to do?	What do I have to do?	Where?
Switch on rear fog light	▶ Press the  button.	–
Switch exterior lights off completely	▶ Press the  button for approx. 2 seconds. The green lighting of the  button goes out. All exterior lights remain switched off completely until a speed of 10 km/h or a driven distance of 100 m has been exceeded.	▶ p. 148

General safety instructions

⚠ WARNING Driving without lights

If you drive without lights, this may significantly restrict your visibility and also the ability of other road users to see your vehicle.

- ▶ Carefully monitor the automatic headlights and switch the dipped beam headlights on manually if necessary.
- ▶ Observe the laws on driving with dipped beam headlights in the specific country.

⚠ WARNING Lack of attention when driving with dynamic high beam

In spite of dynamic high beam, it is always the driver's responsibility to manually adapt high beam according to light conditions, visibility and traffic conditions during driving, for example. The system is not a substitute for careful attention on the part of the driver. Manual intervention may be required in the following situations:

- in unfavourable weather conditions, such as rain, fog, snow, ice, heavy spray
- on roads where oncoming traffic is partly

- obscured, e.g. motorways
- where there are road users with poor lighting, e.g. cyclists
- on narrow bends, steep crests or hollows
- in poorly lit villages and towns
- where there are strong reflectors, e.g. signs.
- where the windscreen in the camera area is misted, dirty, icy or covered with stickers.
- ▶ Drive with extreme care.
- ▶ Always pay attention to the traffic situation and the area around the vehicle.
- ▶ If necessary, manually adjust the high beam to the light, visibility and traffic conditions.

Responding to warning messages

Always heed any warning and information messages displayed in the vehicle.

- ▶ Please refer to chapter "Warning and information messages" on page 271.

Switching automatic headlights/ exterior lights on and off



Switching on automatic headlights

- ▶ Press the  button.

The button lights up green. The pilot light  lights up white.

The dipped beams are switched on automatically in the following situations:

- Dusk
- Darkness
- Driving through tunnels
- Rain

When low beams are switched on automatically, the  button lights up green. The pilot light  lights up.

i Information

Fog is not recognised.

- ▶ In the event of fog, switch on the dipped beams and rear fog light manually.

Switch exterior lights off completely

- ▶ Press the  button for approx. 2 seconds.

The green light in the  button goes out. The automatic lights are switched on again in the following situations¹:

- from a speed of 10 km/h (6 mph)
- when a distance of more than 100 m has been driven after switching off the exterior lights

1. Country-dependent

i Information

The vehicle's exterior lights can mist up depending on temperature and humidity. This misting will evaporate after a sufficient distance has been driven.

Adjusting Automatic Coming Home lights

✓ Automatic headlights switched on.

The following lights can be switched on for a certain period to allow you to get in and out of your vehicle with improved visibility in darkness:

When the last vehicle door is closed or after unlocking the vehicle, the following lights are switched on:

- Daytime running lights
- Dipped beams when approaching
- Front and rear side marker lights
- Number plate light

These are switched off again when operational readiness is switched on or the automatic headlights are switched off.

The duration of the off delay can be set on the central display.

- ▶ ▶ **Setting** ▶ **Vehicle** ▶ **Light and visibility** ▶ **Exterior lights** ▶ **Fade-out duration**

Porsche Dynamic Light System Plus (PDLS Plus) with LED headlights

✓ Automatic headlights switched on.

Dynamic cornering lights

Above a speed of around 5 km/h (3 mph), the dipped beam or high-beam headlights are swivelled in the direction of the curve to illuminate the road more

clearly, depending on the speed of the vehicle and the extent to which the steering wheel is turned.

Situational lighting distribution

Depending on the country, situational lighting control adapts the light distribution of the dipped and high-beam headlights to urban, country-road or motorway driving.

Adverse weather lights

When the fog lights are switched on, the dipped beam distribution changes at a speed of less than approx. 60 km/h (38 mph). The light beam becomes wider and reduces glare.

Dynamic high beam



Fig. 109: Windscreen camera

Light sources of other road users can be detected by camera A in the vicinity of the interior mirror. Their detection continuously adjusts the light/dark limit of the driving light in several phases between dipped-beam and full-high beam illumination. The stage is selected in such a way that the light/dark limit of the driving light reaches the next recognised vehicle.

Dynamic high beam is switched on or off at speeds between 30 km/h (20 mph) and 60 km/h (37 mph), depending on the navigation data. Full high-beam illumination is switched to dipped beam when the camera detects street lights.

Dynamic high beam can be activated or deactivated on the central display:

- ▶ ▶ **Setting** ▶ **Vehicle** ▶ **Light and visibility** ▶ **Exterior lights** ▶ **Dynamic high beam**

i Information

To avoid impairing the detection performance:

- ▶ Do not cover the camera area on the interior mirror with objects (e.g. stickers).
- ▶ The camera must always be kept free of dirt, ice and snow.

Porsche Dynamic Light System Plus (PDLS Plus) with LED-Matrix headlights

✓ Automatic headlights switched on.

PDLS Plus LED-Matrix headlights also include the PDLS Plus functions.

Dynamic high beam



Fig. 110: Windscreen camera

Light sources and other road users can be detected by means of the camera (A). Depending on the position of other vehicles, the speed and other environmental and traffic conditions, the individual LED segments of the high beam headlights are activated

A
B
C
D
E
F
G
H
I
J
K
L
M
N
O
P
Q
R
S
T
U
V
W
X
Y
Z

or deactivated. The beam in the relevant area in front of the vehicle is low, the rest remains high. This ensures that the environment is lit without dazzling other road users.

Dynamic high beam is switched on or off at speeds between 30 km/h (20 mph) and 60 km/h (37 mph), depending on the navigation data. Full high beam illumination is switched to dipped beam when the camera detects street lights. The dynamic high beams can be activated or deactivated in the central display:

- ▶ ▶ **Setting** ▶ **Vehicle** ▶ **Light and visibility**
 - ▶ **Exterior lights** ▶ **Full beam adaptation on vehicle recognition**

Information

To avoid impairing the detection performance:

- ▶ Do not cover the camera area on the interior mirror with objects (e.g. stickers).
- ▶ The camera must always be kept free of dirt, ice and snow.

Passing lights

- ✓ No oncoming traffic.
- ✓ Vehicle ahead.
- ▶ Operate the direction indicator for overtaking while driving. The area next to the vehicle ahead is illuminated brightly. This makes it easier to see the road ahead. Passing lights are automatically deactivated again when the turn signal is deactivated or if oncoming traffic is detected.

Encounter lights

- ✓ No vehicle ahead.

- ✓ Oncoming traffic with detected headlights. The light distribution is briefly changed so that the lane being driven on is illuminated brightly. This draws the direction of vision onto the lane being driven on. The driver is less dazzled by the oncoming traffic.

Signage glare reduction

- ✓ Dynamic high beam is switched on. The glare of reflective traffic signs and other signage can – particularly when driving with high beams – cause the driver to be dazzled. The signage glare reduction briefly dims individual LED segments of the vehicle's low or high beam headlights in a targeted manner. The driver is dazzled less due to reflecting traffic signs and other signage.

Automatic headlight calibration

- ✓ No object in the field of vision that could be affected by the headlights during calibration.
- ✓ Vehicle positioned as straight as possible in front of a projection surface, such as a wall (distance > 5 m).
- ✓ Dipped beam on when vehicle stationary.
- ✓ Test run performed automatically when low beams are activated.

Automatic headlight calibration starts on its own if the conditions are right (depending on ambient lighting, a good projection surface). The LED segments of the headlight are automatically activated and deactivated repeatedly from right to left during calibration and detected by the camera (A). Calibration is used to check headlight alignment and does not replace manual headlight adjustment.

Operating direction indicators and the high-beam stalk

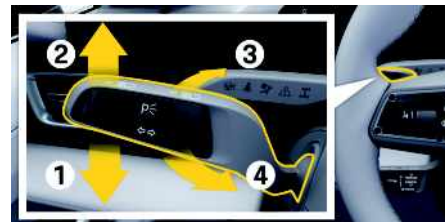

Fig. 111: Operating direction indicators, high beam and headlight flasher

- 1 Direction indicator / left parking light
- 2 Direction indicator / right parking light
- 3 High beams
- 4 Headlight flasher

Operating direction indicators

- ▶ Push the stalk past pressure point 1 or 2. The direction indicator remains active until the stalk is returned to the initial position manually or automatically due to steering wheel movement.

Engaging comfort direction indication

- ▶ Push the stalk once to pressure point 1 or 2. The direction indicators flash three times.
- ▶ In order to interrupt comfort direction indication, press the stalk in the opposite direction.

Switching high beam on and off

- ✓ Vehicles without Porsche Dynamic Light System Plus (PDLs Plus).
 - or –
 - Dynamic high beam deactivated.

Switching on

- ▶ Push the stalk once to pressure point 3.

The indicator light  lights up.

Switching off

- ▶ Push the stalk once to pressure point 4.

The indicator light  goes out.

Switching dynamic high beam on and off

- ✓ Vehicles with Porsche Dynamic Light System Plus (PDLS Plus).
- ✓ Automatic headlights switched on.
- ✓ Dynamic high beam activated.

Switching on

- ▶ Push the stalk once to pressure point 3.

The indicator light  lights up.

Vehicles with LED headlights: Changes are made automatically in several stages between dipped-beam and full high-beam illumination.

Vehicles with LED Matrix headlights: Depending on various factors, such as the position of other vehicles and speed, the individual LED segments of the high beam headlights are activated or deactivated.

If high beam are partly or fully activated, the indicator light  comes on.

Switching off

- ▶ Push the stalk once to pressure point 4.

The dynamic high beam can only be deactivated when the indicator light  is on.

If the dynamic high beam was deactivated or if the requirements for the dynamic high beam are not met, high beam can be switched on and off manually.

Switching on manually

- ▶ Push the stalk twice to pressure point 3.

The indicator light  lights up.

Switching off manually

- ▶ Push the stalk once to pressure point 4.

The indicator light  goes out.

Operating the headlight flasher

- ▶ Briefly push the stalk once to pressure point 4.

The indicator light  comes on briefly.

Switching parking lights on and off

- ✓ Operational readiness switched off.
- ▶ Press the stalk past pressure point 2 or 1 to switch on the right or left parking light.

When the parking light is switched on, a message appears on the instrument cluster after the door is opened.

Switching hazard warning lights on/off



Fig. 112: Switching hazard warning lights on and off

Switching hazard warning lights on and off

- ▶ Press the hazard warning light button on the centre console.
All direction indicators and the button flash.

Deactivating hazard warning lights after emergency braking

If the vehicle is travelling at a speed of more than approx. 70 km/h (43 mph) and is braked fully to a standstill, the hazard warning lights are activated automatically. The brake lights flash during braking.

- ▶ Press the hazard warning light button on the centre console to deactivate the hazard warning lights. The hazard warning lights are deactivated automatically when the vehicle begins to move again.

Hazard warning lights following an accident

The hazard warning lights are activated automatically in the event of an accident in which the airbag is triggered.



Activating overseas mode

When you cross the border into a country where traffic drives on the other side of the road, the light distribution of the headlights must be adapted.

Adaptation of the light distribution normally occurs automatically based on the navigation data.

After conversion, a message appears in the instrument cluster every time the ignition is turned on and the vehicle is ready for operation.

If conversion does not occur automatically, this can also be performed manually on the central display:

- ▶  ▶ **Setting**  ▶ **Vehicle settings** ▶ **Light and visibility** ▶ **Exterior lights** ▶ **Inverted setting of dipped beam**

- ▶ Readjust headlights on the return journey.

Changing bulbs

The vehicle's exterior and interior lights are fitted with LEDs. The LEDs cannot be replaced individually.

A
B
C
D
E
F
G
H
I
J
K
L
M
N
O
P
Q
R
S
T
U
V
W
X
Y
Z

Removing and installing lamps involves a great deal of effort.

- ▶ Always have faulty bulbs and lamps replaced or repaired by a qualified specialist workshop. Porsche recommends a Porsche partner as they have trained workshop personnel and the necessary parts and tools.

NOTICE

Abrasion and excessive temperatures can cause damage to the headlights.

- ▶ Do not install any coverings (e. g. stone guards or films) in the headlight area.

Information

On vehicles featuring LED Matrix headlights, the bonnet has to be open in order to check the dipped beam setting.

- ▶ Adjustment of the headlights should only be performed at a qualified specialist workshop using suitable adjustment equipment. Porsche recommends a Porsche partner as they have trained workshop personnel and the necessary parts and tools.

Luggage compartment

Stowing loads

WARNING

Changed vehicle handling when vehicle is loaded

Vehicle handling changes depending on the vehicle load.

- ▶ Adapt your driving style to the changed vehicle handling.
- ▶ Do not exceed the maximum gross weight and axle load.

WARNING

Unsecured, incorrectly secured or incorrectly positioned load

As a result of braking, changes of direction or in an accident, unsecured or incorrectly positioned loads can slide out of place and endanger vehicle

occupants.

- ▶ Never transport unsecured objects (accident, braking, cornering).
- ▶ Always carry loads in the luggage compartment, never in the passenger compartment (e.g. on or in front of the seats).
- ▶ Support the load at the seat backrests wherever possible. Always engage the backrests.
- ▶ Only transport heavy objects when the backrests are upright and engaged.
- ▶ Place the load behind unoccupied seats whenever possible.
- ▶ Store heavy objects as far as possible from the floor with light objects behind them.
- ▶ Do not transport any objects on the rear shelf.
- ▶ On unoccupied rear seats, the backrests can be additionally secured using the seat belts. To do this, cross the outer seat belts and fasten them to the respective opposite belt buckles.
- ▶ Do not transport any heavy objects in open storage compartments.
- ▶ Always keep lockable storage compartment covers closed when driving.

WARNING

Incorrect tyre pressure

An incorrect tyre pressure can impair driving safety.

- ▶ Adapt the tyre pressure to the load.
- ▶ After you change the tyre pressure, you must also update the setting for Tyre Pressure Monitoring.

The maximum permissible load on the luggage compartment floor is 200 kg. The weight must be evenly distributed over the entire luggage compartment.

Securing loads with tie-down belts

- ▶ Do not use elastic belts or straps to tie down a load.
- ▶ Do not route belts and straps over sharp edges.
- ▶ Cross the belts over the load.
- ▶ Only tighten the belts manually. Do not use additional tensioning aids (ratchet).
- ▶ Observe the instructions and information for the tie-down belts.

Opening and closing the bonnet and tailgate

- ▶ Please refer to chapter "Bonnet" on page 57.
- ▶ Please refer to chapter "Rear lid" on page 211.

Removing and stowing the tyre sealing compound, tool kit and equipment for minor repairs

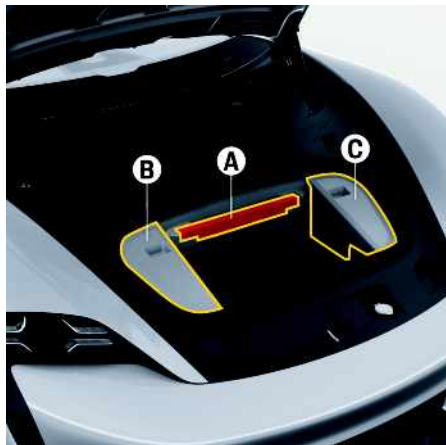

Fig. 113: Plastic boxes in the front luggage compartment

- A Warning triangle (country-dependent)
- B Plastic box for tyre sealant, towing lug and first-aid kit (country-dependent)
- C Plastic box for tool kit and tyre filling compressor

Removing the warning triangle (country-dependent)

The warning triangle **A** is located on the back of the luggage compartment.

Removing the tyre sealant, towing lug and first-aid kit (country-dependent)

- ▶ Remove the cover from the plastic box **B** and take out the desired equipment.

Removing the tool kit and tyre filling compressor

- ▶ Remove the cover from plastic box **C** and take out the desired equipment.

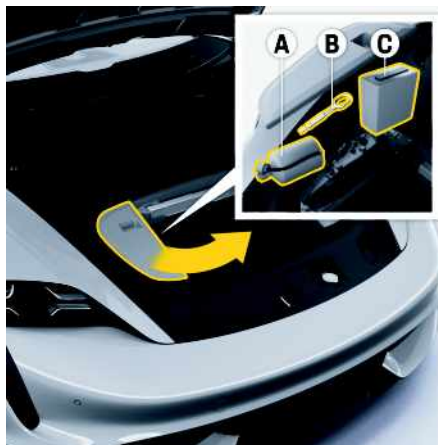

Fig. 114: Plastic box for tyre sealant, towing lug and first-aid kit (country-dependent)

- A Tyre sealant
- B Towing lug
- C First-aid kit (country-dependent)

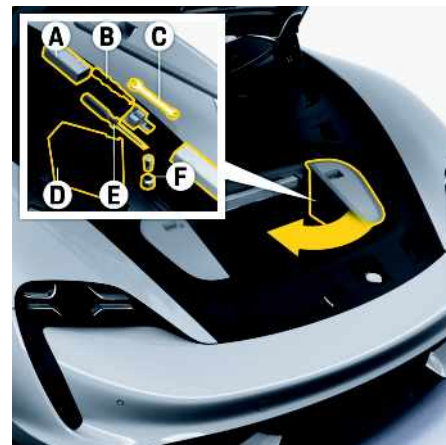

Fig. 115: Plastic box for tool kit and tyre filling compressor

- A Tool box
- B Emergency release tool for the charge port door
- C Open-ended spanner
- D Tyre filling compressor
- E Screwdriver
- F Wrench socket for security wheel bolts

Installing and removing the plastic cover in the front luggage compartment

Removing the plastic cover in the front luggage compartment

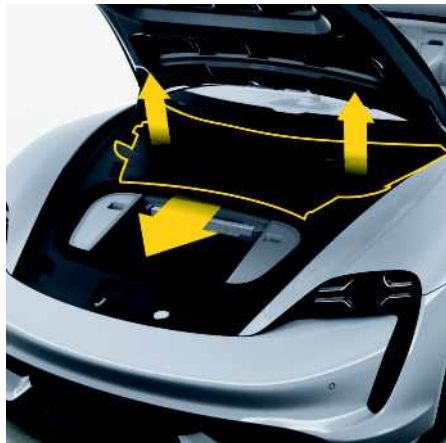

Fig. 116: Detaching and lifting the plastic cover

1. Lift the plastic cover until the latch audibly disengages.
2. Pull the plastic cover forwards slightly and lift at the front.
3. Remove the plastic cover.

Installing the plastic cover in the front luggage compartment

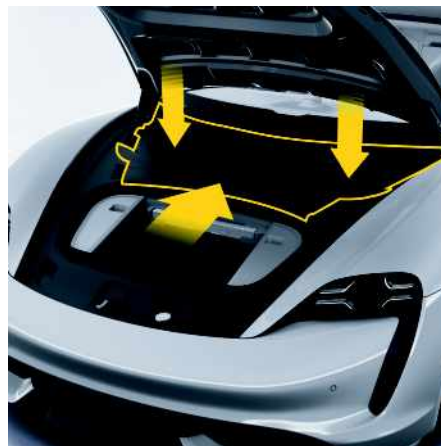

Fig. 117: Closing the plastic cover

1. Insert the plastic cover with the guides at the rear edge and lay it on the holders. Lower the plastic cover in the front.
2. Ensure that the centring pins on the underside of the cover engage in the respective guides. Press the cover downwards at the handle recesses until the latch audibly engages.

Opening and closing the boot floor

Opening the luggage compartment floor



Fig. 118: Opening the boot floor

- ▶ Lift the boot floor by the tab.

Closing the luggage compartment floor

- ▶ Lower the boot floor using the tabs.

Using the ski bag

Skis or snowboards can be transported safely without damaging the passenger compartment.

NOTICE

Risk of damage to the ski bag from sharp edges on the load (e.g. snowboard).

- ▶ Protect sharp edges on the load.

Storing a snowboard or skis in the ski bag



Fig. 119: Using the ski bag

The ski bag is stored in the gear bag for it in the luggage compartment.

1. Fit edge protectors to the snowboard or skis.
2. Place the snowboard or skis into the ski bag and close the ski bag. The skis must be positioned with the tips at the front in the ski bag. The ski bag zip must be pointing towards the rear of the vehicle.
3. Fasten the skis using the tightening strap. The ski bindings must be behind this band.
4. Fold down the pass-through cover between the rear seats.
5. Hook the spring hooks of the tension straps into the tie-down rings.
6. Tighten the tension straps.

Using tie-down rings



Fig. 120: Using tie-down rings

Tie-down straps can be fastened to the tie-down rings to secure the load in the boot to prevent it from slipping.

- ▶ Make sure that all rings are equally loaded when securing a load.

i Information

The tie-down rings are not designed to restrain a heavy load in an accident.

Media

Brief Overview – Media

This brief overview does not replace the comprehensive descriptions. Safety messages and warnings, in particular, are not replaced by this brief overview.

















For information on operating Porsche Communication Management (PCM):

- ▶ Please refer to chapter "Porsche Communication Management (PCM)" on page 190.



Fig. 121: Playing media

What do I want to do?	What do I have to do?	Where?
Connecting a media source	<ul style="list-style-type: none"> – Connect an external device via Bluetooth®. – Connect an external device via USB. 	▶ p. 102
Playing media	▶ Open the desired menu option in the quick filter bar (see A) ▶ Select the desired station/track.	–
Selecting a media source	▶ On the filter bar (see B), ▶ Select the desired media source.	–
Find a station/track/album (the search includes all available media sources)	▶ ▶ Media ▶ on the filter bar (see B) ▶ Enter the desired station/track.	–
Select media source/reception range	▶ ▶ Media ▶ Play (see A) ▶ on the filter bar (see B), select a media source (e.g. Radio).	–
Displaying media source content / reception range	▶ ▶ Media ▶ List (see A) ▶ on the filter bar (see B), select a media source (e.g. Radio).	–

	What do I want to do?	What do I have to do?	Where?
A			
B			
C	Play/pause music	▶ Touch  ▶ Media  ▶ Play (see A) ▶  or  (see E).	-
D			
E	Play next/previous station/track	▶ Touch  ▶ Media  ▶ Play (see A) ▶  or  (see E).	-
F			
G	Storing a station as a favourite	▶ Long-press and hold a station ▶ Touch  . - or - Touch  ▶ Media  ▶ Play (see A) ▶  .	▶ p. 158
H			
I			
J	Display station/track list	▶  ▶ Media  ▶ List (see A) Depending on the selected media source, further subfolders such as Playlists , Artists are available.	-
K			
L			
M	Activate online station tracking	▶  ▶ Media  ▶  (see F) ▶ Online station tracking ¹ . If the reception is poor, stations are automatically received online, and Online appears beside the station name.	-
N			
O			
P			
Q			

Playing media

Available radio and media sources

The radio supports the FM and DAB (digital radio) frequency ranges.

Depending on equipment, the following media sources are available: external devices via USB or Bluetooth®, online media services, online radio.



Technical data on supported media and file formats:

- ▶ Please refer to chapter "Technical Data" on page 308.

Other functions during media playback







✓  ▶ **Media**  ▶ **Play** selected.

In addition to the functions from the brief overview, the following functions are available:

- Display current playlist: 
- Activate random playback: 
- Repeat track: 



Storing and editing a favourite

Storing a favourite



- ▶  ▶ **Media**  ▶ **List** ▶ Press the desired station for a longer time ▶ Touch .
- or -
Touch  ▶ **Media**  ▶ **Play** ▶ .

1. Prerequisite: A data connection is established. Porsche Connect Services activated.

Organising favourites

1.  ▶ **Media**  ▶ **Favourites** ▶  ▶ **Adapt sorting of favourites**
2. Press the desired station for a longer time and move to the desired position (drag & drop).

Deleting a favourite

1.  ▶ **Media**  ▶ **Favourites**
2. Press the desired station for a longer time. The delete symbol will appear.
3. Touch the delete symbol.

Changing media settings

- ▶  ▶ **Media**  ▶  ▶ Selected the desired setting.

Messages

Displaying and editing messages



You can read text messages and e-mails, have the messages read out to you or use the numbers contained in the messages for making phone calls. The mobile phone may not support all functions. You will find further information on these settings in the operating instructions for the mobile phone.

The **Message** function is displayed in the Home screen when a mobile phone is connected.



Information

- If the mobile phone is only able to display the text message stored in the device memory, the text message received in the vehicle may not appear in the mobile phone message list. Otherwise, received text messages are stored on the SIM card.
- Multimedia Messaging Service (MMS) is not supported by the PCM.



Writing text messages/e-mails

1.  ► **Message** ► **Text messages/E-mail**
2. Touch 
3. Add the recipient (by entering the number or selecting a contact).
4. Enter text using the input field and confirm with **OK**.
5. Touch **Send**.

Replying to or forwarding text message/e-mail

1.  ► **Message** ► **Text messages/E-mail**
2. Select the text message/e-mail that you want to reply to/forward.
3. Touch  ► **Reply/Forward**.

Editing messages

-  ► **Message** ► Text message/e-mail folder ►  ► Select the desired setting.

Mirror

Using the exterior mirrors

⚠ WARNING

Incorrect assessment of traffic situation due to distorted representation of surroundings in exterior mirrors

Vehicles or objects appear smaller in convex mirrors and further away than they are in reality. This may lead to incorrect assessment of the driving situation and an accident.

- ▶ Take account of distortion when estimating the distance of vehicles behind you and when parking.
- ▶ Use the interior mirror for judging distance as well.

⚠ CAUTION

Escaping electrolyte fluid

Electrolyte fluid may escape from a broken mirror. This fluid causes irritation to the skin and eyes.

- ▶ In the event of contact with the skin or eyes, immediately rinse off the electrolyte fluid using clean water.
- ▶ Seek medical attention from a doctor if necessary.

NOTICE

Risk of damage to paintwork, leather, plastic components and clothing.

Electrolyte fluid can only be removed while it is still wet.

- ▶ Clean affected parts with water.

NOTICE

Risk of damage to the exterior mirrors when washing the vehicle in car washes.

- ▶ Fold in exterior mirrors before using the car wash.

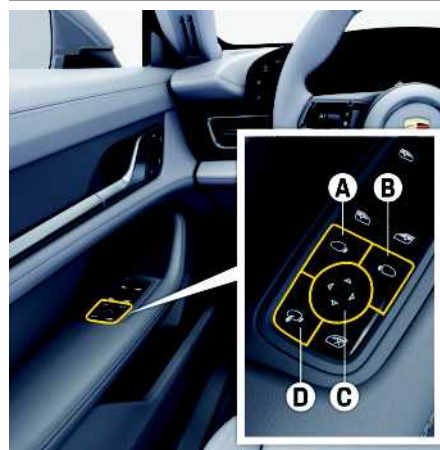

Fig. 122: Exterior mirror operation

- A** Exterior mirror selection on the left side
- B** Exterior mirror selection on the right side
- C** Adjusting exterior mirrors
- D** Folding exterior mirrors in and out (depending on equipment)

Adjusting exterior mirrors



Fig. 123: Adjusting exterior mirrors

- ✓ Ready for operation.

– or –

Vehicle switched off, driver's or passenger's door not yet opened (for a maximum of 10 minutes).

1. Press button **A** for the left exterior mirror and button **B** for the right exterior mirror. When the  symbol on the selected button is illuminated red, the corresponding exterior mirror glass can be adjusted.
2. Move the exterior mirrors to the correct position by pressing the adjustment button **C**.

If the electric function fails

- ▶ Adjust the mirrors by pressing on the mirror surface.

Folding exterior mirrors in and out



Fig. 124: Folding exterior mirrors in and out

Folding in exterior mirrors manually

- ▶ Swivel the mirror housing diagonally upwards by hand as far as it will go.

Folding out exterior mirrors manually

- ▶ Swivel the mirror housing diagonally downwards by hand as far as it will go.

Folding exterior mirrors in and out electrically (depending on equipment)

- ✓ Maximum speed of approx. 50 km/h (30 mph).
- ▶ Press button **D**.
Both exterior mirrors fold in or out.

If the electrical folding function fails

- ▶ Fold mirror in or out manually.

Folding exterior mirrors in and out from the outside

The exterior mirrors can be folded in when the vehicle is locked.

- ▶ Press and hold the  button on the driver's key for at least 1 second.
In vehicles with Komfortzugang: Touch the proximity sensor on the door handle of the driver's side for at least 1 second.
The exterior mirrors fold in.



Folding exterior mirrors out automatically

- ▶ Press the power button and turn on the vehicle.
The exterior mirrors fold out automatically.

Folding exterior mirrors in and out automatically (depending on equipment)

The automatic folding in and out function of the exterior mirrors can be activated in the central display.

Activating function

- ▶  ▶  ▶ **Vehicle settings** ▶ **Vehicle locking system** ▶ **Fold in exterior mirrors when locking**

Folding exterior mirrors in automatically

- ✓ Function activated.
- ▶ Please refer to chapter "Vehicle settings" on page 257.
- ▶ Lock the vehicle.
The exterior mirrors fold in.

Folding exterior mirrors out automatically

- ✓ Function activated.
- ▶ Unlock the vehicle.
The exterior mirrors fold out.

Information

The exterior mirrors will not fold out automatically after the ignition is switched on if they were folded in manually beforehand using button **D**.

Storing exterior mirror settings

In vehicles with memory package, individual exterior mirror settings can be stored on the memory buttons on the driver's door and on the driver's key.

- ▶ Please refer to chapter "Personal settings" on page 180.

Switching automatic anti-dazzle function of exterior mirrors on and off

The exterior mirrors change to anti-dazzle position automatically in synchronisation with the interior mirror.

- ▶ Please refer to chapter "Switching automatic anti-dazzle function of exterior mirrors on and off" on page 162.

Swivelling down mirror glass as a parking aid

In vehicles with a memory package, the mirror on the **passenger's side** swivels down slightly to show the kerb area when reverse gear is engaged.



Fig. 125: Swivelling down mirror glass as a parking aid

Swivelling mirror glass downwards automatically

Downward swivelling of the passenger side mirror glass can be activated on the central display.

Activating the function

- ▶ ▶ ▶ **Vehicle settings** ▶ **Light and visibility** ▶ **Reversing options** ▶ **Lowering the mirror glass while reversing**

- ✓ Vehicle switched on.
- ✓ Reverse gear engaged.
- ✓ Function activated.

Swivelling down mirror glass manually

On vehicles with a memory package, the mirror glass on the passenger's side can be swivelled downwards.

1. Engage reverse gear.

The symbol for adjusting the exterior mirror on the passenger's side lights up.

2. Press button **B** for adjusting the exterior mirror on the right-hand side (on a right-hand drive vehicle press button **A**).

The mirror glass on the passenger's side swivels downwards.

Individually adjusting the position of the lowered mirror glass:

- ▶ Move the exterior mirror glass to the required position by pressing adjustment button **C**.

In vehicles with a memory package, this setting is stored on the memory buttons in the driver door or on the driver's key.

For information on retrieving and storing vehicle settings:

- ▶ Please refer to chapter "Personal settings" on page 180.

Moving mirror glass to its initial position

The mirror glass swivels back to its initial position:

- after a certain time delay if the vehicle is shifted out of reverse gear, or
- immediately if the vehicle reaches a speed of more than 15 km/h (9 mph).

Moving the mirror glass on the passenger's side to its initial position manually:

- ▶ Press button **A** for the exterior mirror on the driver's side.

Dimming interior mirror manually



Fig. 126: Dimming interior mirror manually

When the mirror is being adjusted, the anti-dazzle lever **A** must point towards the passenger compartment.

- ▶ Basic setting – swivel lever towards the passenger compartment.
- ▶ Low beam position – swivel lever towards the windscreen.

Using the automatic anti-dazzle mirror function

The exterior and interior mirrors each automatically change to the dimmed position as soon as bright light shines onto the mirror face of the interior mirror.

The mirrors do not dim when reverse gear is engaged or when interior lighting is switched on.

A
B
C
D
E
F
G
H
I
J
K
L
M
N
O
P
Q
R
S
T
U
V
W
X
Y
Z

Likewise, the incident light onto the interior mirror or coming through the windscreen to the front light sensor must not be restricted by stickers.

- ▶ Do not affix any stickers to the windscreen in front of the interior mirror or on the rear window.
- ▶ Do not transport any luggage on the rear shelf.

 **CAUTION**

Escaping electrolyte fluid

Electrolyte fluid may escape from a broken mirror. This fluid causes irritation to the skin and eyes.

- ▶ In the event of contact with the skin or eyes, immediately rinse off the electrolyte fluid using clean water.
- ▶ Seek medical attention from a doctor if necessary.

NOTICE

Risk of damage to paintwork, leather, plastic components and clothing.

Electrolyte fluid can only be removed while it is still wet.

- ▶ Clean affected parts with water.

Navigation

Brief Overview - Navigation

This brief overview does not replace the comprehensive descriptions. Safety messages and warnings, in particular, are not replaced by this brief overview.

For information on operating Porsche Communication Management (PCM):

- Please refer to chapter "Porsche Communication Management (PCM)" on page 190.

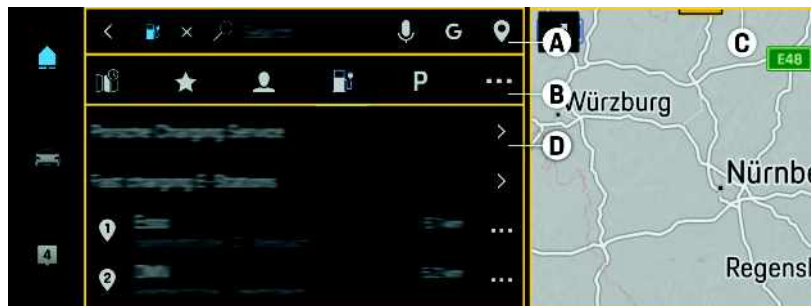



















Fig. 127: Entering/searching for a destination

What do I want to do?	What do I have to do?	Where?
Find a destination/enter a destination address	<ul style="list-style-type: none"> ▶ ▶ Navigation ▶ Suggestions are displayed in the content and interaction area (see D). Input options (see A) – Voice input – Search area: Search along the route or nearby – Search (availability dependent on country)¹: Internet search – Google search (availability dependent on country)¹Internet search via Google 	–
Select previous destination	<ul style="list-style-type: none"> ▶ On the filter bar (see B), select . 	–

1. Prerequisite: A data connection is established. Porsche Connect services and Online navigation services are activated.

A	What do I want to do?	What do I have to do?	Where?
B	Select a destination from contacts	▶ On the filter bar (see B), select  .	-
C	Filter search results	▶ Search results can be filtered in the filter bar (see B).	-
D		- Recent destinations	
E		- Favourites	
F		- Contacts	
G		- E-Charging	
H		- Parking	
I		Additional filters (e.g. points of interest) can be displayed in the filter bar under Options  (see B).	
J			
K	Start route guidance	▶  ▶ Navigation  ▶  ▶ Enter destination ▶ Touch Start route guidance .	-
L			
M	Stop route guidance	▶ Touch  ▶ Navigation  ▶ Stop on the map display.	
N			
O	Add destination to Favourites	▶  ▶ Navigation  ▶  ▶ Enter a destination or select from a list of suggestions (see D) ▶  in the content and interaction area (see D) ▶  .	-
P			
Q		Favourites are marked with a  in the map view.	
R			
S	Activate online navigation	▶  ▶ Setting  ▶ Select Porsche Connect ▶ Porsche Connect Services settings. Information about the services purchased and the contract duration is displayed.	-
T			
U			
V			
W			
X			
Y			
Z			

What do I want to do?	What do I have to do?	Where?
Configuring navigation announcements	<ul style="list-style-type: none"> ▶  ▶ Navigation  ▶  ▶ Navigation settings ▶ Select navigation announcement volume. 	–
Use Porsche Connect services (e.g. online map update)	<ul style="list-style-type: none"> ✓ Data connection established. Porsche Connect services activated. Further information on Porsche Connect can be found at <ul style="list-style-type: none"> ▶ www.porsche.com/connect 	▶ p. 196

WARNING

Risk of accident through disregarding road traffic laws

If a recommended driving instruction contradicts the road traffic laws in force, the country-specific traffic regulations always apply. The driver is always responsible for road safety.

- ▶ Always pay attention to the traffic situation.
- ▶ Adapt your speed and driving style to the visibility, weather, road and traffic conditions.



WARNING

Risk of accident owing to system-related inaccuracies and malfunctions

Incorrect directions and malfunctions cannot be ruled out during satellite-based navigation. The driver is always responsible for driving the vehicle.

- ▶ Always pay attention to the terrain.

Choosing a destination from a map

1. Select  ▶ Navigation .
2. Touch the destination on the map for longer.
3. Touch the address displayed to start route navigation.

Alternative routes

Up to 3 routes are displayed in the map view. For vehicles with Charging Planner (available in some countries), an alternative route is also calculated for the **Normal** and **Range** driving modes.

1. Select  ▶ **Alternative routes** in the map view.
2. Available alternative routes are displayed.
3. Tap an alternative route to select it. The selected route is highlighted.
4. Select **Start** to start the route guidance.

- ▶ Please refer to chapter "Selecting drive mode" on page 106.

Planning a tour (entering a stopover)

A tour consists of one destination and a maximum of eight stopovers.



Entering and starting a tour

1.  ▶ Navigation  ▶  ▶ Enter the destination ▶ **Start**.
2.  ▶ Navigation  ▶  ▶ Enter or select a stopover ▶  ▶ **Add as a stopover**.
3. **Start tour**.



Editing a tour

You can reorganise the stopovers at a later time.

- ✓ Tour started.

- ▶ Select the  symbol for the relevant stopover under Options  ▶ **Edit route**, then drag to the desired position.

Configuring map content

1.  ▶ Navigation  ▶  (links on sidebar)
2. Activate/deactivate the desired map content (availability dependent on country):

- **North up:** The map always faces north.
- **3D map:** Show or hide the 3D map view (otherwise 2D view).
- **Google Earth:** Show or hide the satellite view on the map.
- **Range:** Show or hide range on the map.

Changing map settings

1. > **Navigation** > > **Navigation settings**
 > **Map settings**

2. Activate/deactivate the desired map content (availability dependent on country):

- **Auto zoom:** Activate or deactivate the auto zoom function in the map.
- **Display points of interest:** Show or hide points of interest on the map.
- **3D buildings:** Show or hide the 3D map view (otherwise 2D view).
- **Show speed limits** (availability depends on the equipment): Show or hide speed limits on the map.
- **Day and night view:** Select map view mode.

Display traffic information

Displaying traffic information on the map¹

You can display the following traffic information on the current location or on the selected route on the map:

- **Coloured warning symbols:** Imminent traffic disruption on the selected route. If route guidance is not active, all current traffic disruptions are highlighted in colour.

- **Greyed-out warning symbols:** Traffic disruption which is not on the selected route.

The following traffic flow information is displayed:

- Free lines: freely flowing traffic
- Yellow lines: Bumper-to-bumper traffic
- Orange lines: Slow-moving traffic
- Red lines: traffic jam
- Dark red lines: Traffic jam and roads closed

In addition, notifications regarding roadworks, accidents, black spots etc. are displayed.

Avoiding traffic disruptions

Traffic disruptions can be automatically avoided or displayed in route guidance.

> Activate > **Navigation** > > **Route options** > **Dynamic reroute/Refer to traffic announcements.**

Radio stations or online content providers are responsible for traffic notices. For that reason, no liability can be accepted for the completeness and correctness of the information.

Trip overview



Fig. 128: Information in the trip overview

When route guidance is active, the trip overview can be opened by touching the area **A**. It displays information about the current route plan:

- Arrival time and charge state at destination (see **A**)
- Delays, e.g. due to traffic jams; the extent of the delay is also shown (see **B**)
- Stopover (see **C**)
- Charging station with charging time² (see **D**)

The following traffic flow information is displayed:

- Blue: Freely flowing traffic
- Yellow: Slow-moving traffic
- Red: Traffic jam

Display additional information

> Select, for example, delays due to traffic jams (see **B**) in the map or in the trip overview. The central display detail area provides additional information about this message.

1. Prerequisite: A data connection is established. Porsche Connect services activated.
 2. Prerequisite: Charging Planner active (availability dependent on country).

Charging Planner (available in some countries)

If a destination is entered that is out of range, the driver will be informed by a sound and a notice. The Charging Planner will then automatically add necessary charging stations to the route. Charging stations with a charging power of min. 50 kW are selected, taking into account driving and charging times.

If an alternative route is selected, the Charging Planner automatically adjusts the driving mode to the route (**Normal** or **Range**), and a corresponding notice appears on the monitor.

▷ Please refer to chapter "Alternative routes" on page 167.

The charging stations and the associated charging time are displayed in the route monitor.

The high-voltage battery is preconditioned to achieve optimum charging power.

The Charging Planner can also be displayed in the Porsche Connect app, and the data can then be transferred from the mobile phone to the PCM.

▷ Please refer to chapter "Apps" on page 56.

Displaying details on charging stations

▷  ▷ Navigation  ▷ Route options  ▷ Edit route

The following details about individual charging stations are constantly updated and can be displayed:

- Name of the charging station
- Battery charge condition when reaching the charging station
- Arrival time at the charging station
- Distance to the charging station
- Charging duration
- Battery charge condition when reaching the destination

Manually adding a charging station

Charging stations can be added manually as stopovers and as the final destination.

▷ Please refer to chapter "Planning a tour (entering a stopover)" on page 167.

The charging duration for the manually added charging stations is calculated, and the automatically added charging stations are adjusted. The high-voltage battery is preconditioned to achieve optimum charging power.

Manually added charging stations are displayed as blue flags in the map view, and automatically added charging stations are displayed as white flags.

Activating/deactivating the Charging Planner

▷  ▷ Navigation  ▷ Route options  ▷ Charging Planner

The high-voltage battery is preconditioned to achieve optimum charging power.

Porsche Intelligent Range Manager (PIRM) (available depending on the equipment)

- ✓ Charging Planner activated.
- ✓ Data connection established.
- ✓ PIRM activated in Porsche Connect Services.

Der Porsche Intelligent Range Manager (PIRM) is an extension of the Charging Planner for the **Range** driving mode.

If route guidance with a driving mode other than **Range** is selected, PIRM will search for a faster alternative for the route in the **Range** driving mode. If PIRM finds a suitable route, a message will appear on the monitor.

If a route with the **Range** driving mode is selected, PIRM will adjust the settings for **Range** to the route.

If the **Permit adaptation to range** option is activated, PIRM can also fall below the set speed limit and can change the air-conditioning settings if needed.

The settings can still be changed manually.

▷ Please refer to chapter "Configuring RANGE drive mode" on page 106.

Display map view and navigation information on the instrument cluster

For information on operating the instrument cluster:

▷ Please refer to chapter "Operating the instrument cluster" on page 129.

Displaying and configuring the map display



1. Select map view on the instrument cluster (Power meter).
 - ▷ Please refer to chapter "Tube 2 – Power meter" on page 125.
2. Select the desired view option via the multi-function steering wheel:
 - **Man. zoom:** Adjust zoom factor of the map display.
 - **Auto zoom:** The map scale is adjusted automatically.
 - **3D map:** Three-dimensional map display.
 - **North up:** The map always faces north.
 - **Map info:** If no map view is selected in the Car & Info display on the instrument cluster, the map is displayed automatically in the event of a navigation event.
 - **Arrow info:** If the menu is **Navigation not** selected in the Speed & Assist display on the instrument cluster, the menu is displayed automatically in the event of a navigation event.

A
B
C
D
E
F
G
H
I
J
K
L
M
N
O
P
Q
R
S
T
U
V
W
X
Y
Z

Displaying navigation information in the instrument cluster

- ▶ Select **Navigation** the menu in the Speed & Assist display on the instrument cluster.
 - ▷ Please refer to chapter "Instrument cluster overview" on page 125.

Changing navigation settings

- ▶  ▶ **Navigation**  ▶  ▶ **SET NAV** ▶ Select the desired setting.

Toll devices

Secure toll devices on the inside of the windscreen only outside of the field of vision.

- ✓ Vehicle with thermal insulation glazing



Fig. 129: Attaching toll devices

Secure toll devices at the marked position on the inside of the windscreen in order to guarantee optimum reception.

Night View Assist

General safety instructions

WARNING

Lack of attention and failure to detect objects via Night View Assist

Night View Assist is a support system and cannot warn of an impending collision under all circumstances. Risk of accident!

Responsibility for timely braking and appropriate vehicle lighting for the situation always lies with the driver.

- ▶ Drive with extreme care.
- ▶ Always pay attention to the traffic situation and the area around the vehicle.

CAUTION

Night View Assist restricted or not available

Shocks or damage to the bumper, e.g. through parking bumps, can move the sensors. This may impair performance of the system.

- ▶ Visit a qualified specialist workshop. Porsche recommends a Porsche partner as they have trained workshop personnel and the necessary parts and tools.

System limitations

WARNING

The system has restricted availability

The assistance provided by the system cannot be guaranteed in certain situations. Such situations include:

- Pedestrians and animals cannot always be detected.

- In poor weather conditions, such as heavy rain, snowfall and icing, camera operation and consequently the detection of a collision hazard may be impaired.
- Unintentional pedestrian and animal warnings may be triggered in complex driving situations owing to internal limitations of the system.
- ▶ Keep the direction of travel and the relevant area around the vehicle in view at all times.

Responding to warning messages

Always heed any warning and information messages displayed in the vehicle.

- ▶ Please refer to chapter "Warning and information messages" on page 271.

Operating principle

The thermal imaging camera in the front bumper provides a thermal image of the surroundings, which can be displayed on the instrument cluster. The system can detect persons and animals beyond the area illuminated by the headlights and highlight these in the camera image.

Night View Assist detects persons and animals when it is sufficiently dark and at an ambient temperature of under 28 °C.

Because the thermal imaging camera is only sensitive in the heat radiation range, the image in the camera may differ significantly from the image as perceived by the human eye.

Night View Assist offers the following functions:

Pedestrian warning

If the system detects a possible collision with a pedestrian, it can warn the driver by means of a warning tone and an appropriate display in the instrument cluster on the vehicle speed range up to

250 km/h (156 mph). The camera image is displayed with the person marked in red.

The pedestrian warning is output if a pedestrian is standing or moving onto the driving lane. On vehicles with LED-Matrix headlights, the endangered person is flashed at in order to enhance recognition. When this warning is given, it may still be possible to prevent a collision by the driver avoiding the pedestrian or braking sharply. The warning time varies depending on the traffic situation and the driver's behaviour.

Animal warning

A warning is also issued within the limitations of the system prior to an impending collision with large wild animals such as deer outside urban areas. In this case, the system warns the driver visually and audibly. The camera image with the animal marked in red is also displayed in order to support the driver in locating the danger.

The animal warning is triggered if an animal is located in the projected driving lane or is in dangerously close proximity. In urban areas, the animal warning is automatically deactivated in order to prevent false warnings from being caused by leashed dogs, for example.

Display elements

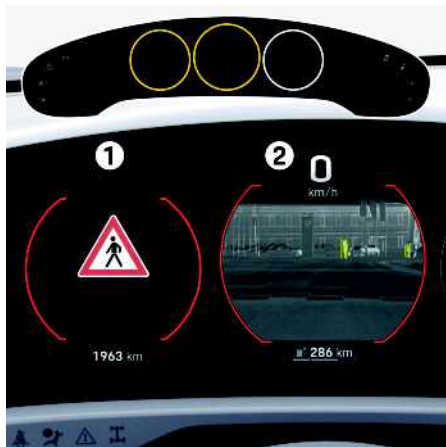



Fig. 130: Night View Assist

- 1 Pedestrian and animal warning
- 2 Thermal imaging display

Symbols

Symbol	Meaning
	Indicates when the camera image is displayed that, owing to the prevailing ambient conditions (outside temperature and brightness), the system cannot reliably detect persons or animals and no warning function is available. The symbol is also displayed when the system is switched off.

Switching Night View Assist on and off

Switching Night View Assist on and off via the central display

- ▶  ▶ Assistance ▶ Basic assistance ▶ Night View Assist

Information

Deactivation will only disable the warning feature and the marking of pedestrians and wildlife. It is still possible to display the image on the instrument cluster.

Setting the warning time and picture contrast

The warning time for the collision warning and the picture contrast of the Night View Assist can be set in the central display.

- ▶  ▶ Assistance ▶  ▶ Assistance system settings ▶ Night View Assist

Clean Night View Assist camera

The thermal imaging camera of the Night View Assist in the front bumper must be cleaned at regular intervals.

- ✓ Dipped beam activated.
- ▶ Press  under the wiper stalk.

Information

- ▶ If windscreen is very dirty, repeat wash.
- ▶ Persistent dirt (e.g. insect remains) should be removed regularly.

Information

The system has an internal heater which automatically heats the camera when below a certain temperature to prevent or melt icing.

Notifications

Brief overview - Notifications





This brief overview does not replace the comprehensive descriptions. Safety messages and warnings, in particular, are not replaced by this brief overview.

For information on operating Porsche Communication Management (PCM):

- ▶ Please refer to chapter "Porsche Communication Management (PCM)" on page 190.



Fig. 131: Areas in the Notifications main menu





What do I want to do?	What do I have to do?
Display notifications	▶ Touch  in the main menu.
Filter notifications	▶ Touch  in the main menu ▶ e.g. Vehicle (see A) in the quick filter bar.
Open notification	▶ Select  in the main menu ▶ e.g. All (see A) ▶ Notification (see C). Notification is displayed in the detail area (see B).
Configure how content is displayed	▶  in the main menu ▶ 

Opening notifications



- ▶ Touch  in the main menu.

Filtering notifications

The notifications can be filtered in the quick filter bar (see **A**). The content is divided into the following areas:

-  Display of all existing notifications.
-  Display of vehicle notifications.
-  Display of notifications for the connected mobile phone.
-  Display of information notifications.

Changing notification settings

- ▶  ▶ **Setting**  ▶ **Notification centre** ▶ Select the desired setting.

A
B
C
D
E
F
G
H
I
J
K
L
M
N
O
P
Q
R
S
T
U
V
W
X
Y
Z

Over-the-Air (OTA) functions

Using OTA functions that are available depending on the country, the PCM and vehicle can be updated over the air, such as by using updates or Function on Demand (FoD).

In addition, the vehicle can identify maintenance and repair requirements via Smart Service. This is displayed in My Porsche and in the PCM and transferred to the Porsche partners defined in My Porsche.

A breakdown can be reported and Porsche Assistance contacted using the breakdown call function via the PCM or the Porsche Connect app. Porsche Assistance can identify various problems and remedy these directly, using OTA access if required, or prepare the required repair measures.

Information

You will find more information on the Porsche Connect functions (help videos, Porsche Connect operating instructions and questions & answers) at www.porsche.com/connect and in the "Good to know" app (availability dependent on country).

Update

Download update

Updates are automatically downloaded in the background. All PCM and vehicle functions are fully usable during downloading. The download is paused when the vehicle is switched off and automatically resumed when it is switched on. The download time depends on the connection quality. After completion of the download, the installation can be started.

- ✓ Data connection is successfully established.
- ✓ Porsche Connect services and any individual services are activated in My Porsche.
- ✓ Private mode is deactivated.

- ▶ Please refer to chapter "Porsche Connect settings" on page 197.

Install update

When ready for installation, a notification of the current update appears once. Please refer to chapter "Notifications" on page 173.

- ▶ For information on the update or to determine a desired installation time, select  **Updates** on your home screen.

NOTICE

Usage restrictions during the update.

Readiness for operation is blocked. Displays and vehicle functions (e.g. comfort functions or anti-theft functions) may temporarily be disabled.

- ▶ Park the vehicle safely.
- ▶ Follow any requests in the central display, such as exiting the vehicle with all passengers.
- ▶ Do **not** use the vehicle during the update.
- ▶ Only use the vehicle after installation.

Only one installation process can be started. This installation process **cannot** be interrupted. The installation time depends on the content of the update. An installed update **cannot** be reversed.

- ✓ Update successfully downloaded.
- ✓ Vehicle switched off.
- ✓ Parking lock and parking brake activated.
- ✓ Battery charged sufficiently.

Information

The installation time is automatically shifted if the confirmation for installation is missing or with **Install later**.

- ▶ Confirm installation of the update with **Yes**. The installation progress is displayed in the central display. After successful installation, a one-time message will appear in the central display. The vehicle can be fully used again.

Function on Demand (FoD)

Activating Function on Demand (FoD)

- ✓ The data connection has been successfully established.
 - ✓ Porsche Connect services and any individual services are activated in My Porsche.
1. Purchase the desired FoD service in My Porsche. After the purchase is complete, a one-off message will appear on the central display. A notification will also appear concerning the FoD service. Please refer to chapter "Notifications" on page 173.
 2. Activate the FoD service in the message or under the notification on the central display ( in the main menu).

Deactivating Function on Demand (FoD)

- ✓ The data connection has been successfully established.
 - ✓ Porsche Connect services and any individual services are activated in My Porsche.
 - ✓ FoD service has been purchased in My Porsche and activated in the vehicle.
 - ✓ Private mode is deactivated.
 - ▶ Please refer to chapter "Porsche Connect settings" on page 197.
1. Deactivate the desired FoD service in My Porsche.

After deactivation is complete, a one-off message will appear on the central display. A notification will also appear concerning the FoD service.

Please refer to chapter "Notifications" on page 173.

- Deactivate the FoD service in the message or under the notification on the central display (📱 in the main menu).

Breakdown Call

Help can be requested via the breakdown call in the case of breakdowns or accidents.

- ✓ Mobile phone network available.
- ✓ The breakdown call system is ready for operation (approx. 20 seconds after turning on the vehicle).
- ✓ Private mode is deactivated.
 - Please refer to chapter "Porsche Connect" on page 196.

Information

The breakdown call system does **not** require a mobile phone registered in the vehicle as it has its own mobile phone module.

Due to technical or organisational restrictions outside of Porsche's control (e.g. no roaming or no active data connection), it may not be possible to establish a breakdown call to Porsche Assistance.

Data transmission



In the event of a breakdown call, data to determine the necessary measures can be transmitted to Porsche Assistance, if available. This can include:

- Current vehicle location
- Vehicle identification number

- Vehicle type
- Fault codes and other data for localising the fault

Triggering a breakdown call

- ✓  ▶ **Phone**  ▶ **Keypad** is selected.

- Press  **Breakdown call** switch. Select  to end the test emergency call.
- If circumstances allow, wait in the vehicle until the connection to Porsche Assistance has been established.

The breakdown call can also be triggered via the using the Porsche Connect App (availability dependent on country).

Accessing the vehicle

- ✓ Breakdown call triggered.
- ✓ The vehicle data was transferred successfully to Porsche Assistance.
- ✓ Online measures available.

If possible, Porsche Assistance can write access to the vehicle. Porsche can make adjustments to the software of individual control units in the vehicle.

Allow write access to the vehicle

- Observe the instructions in the central display and grant access with **Yes**.
- Follow the instructions in the central display. Online measures are performed.

NOTICE

Usage restrictions during write access.

Readiness for operation is blocked. Displays and vehicle functions (e.g. comfort functions, driver assistance systems or emergency functions) may be

temporarily disabled.

- ▶ Park the vehicle safely.
- ▶ Follow any requests in the central display, such as exiting the vehicle with all passengers.
- ▶ Do **not** use the vehicle while online measures are performed.
- ▶ Use the vehicle only after online measures are completed.

Fault in OTA function

Faults may occur while using OTA features (such as installing updates or accessing the vehicle during a breakdown call).

The severity of the fault caused and its consequences are shown in the central display.

- Please refer to chapter "Warning and information messages" on page 129.

NOTICE

Damage and usage restriction due to failed OTA function.

The vehicle's readiness for operation may be blocked, depending on the severity of the fault caused. Displays and vehicle functions cannot work correctly.

- ▶ When the vehicle is ready for operation: Adapt your driving behaviour to the situation.
- ▶ If the vehicle is not ready for operation: Call a roadside assistance service and have your vehicle towed.
- ▶ Have the fault corrected at a qualified specialist workshop. Porsche recommends a Porsche partner as they have trained workshop personnel and the necessary parts and tools.

ParkAssist

General Safety Instructions

⚠ WARNING

Lack of attention when manoeuvring or parking

The increased comfort offered by ParkAssist must not induce you to risk your safety. Even when the system is active, the driver is still responsible for taking due care when parking and when assessing obstacles. The system cannot replace the driver's attentiveness.

- ▶ Make sure that no persons, animals or obstacles are within the manoeuvring area.

⚠ WARNING

Dirty sensors or cameras

Dirty sensors or cameras can prevent obstacles and obstructions from being detected.

- ▶ Sensors and cameras must always be kept clean and free of ice and snow.

System limitations

The system cannot detect the following obstacles:

- sound-absorbing obstacles (e.g. wintry conditions, powder snow, clothing made from fabric, skin or fur)
- sound-reflecting obstacles (e.g. glass surfaces, flat painted surfaces)
- very thin obstacles (e.g. thin posts)
- obstacles above and below the sensors

i Information

other ultrasound sources (e.g. pneumatic brakes of other vehicles, sweeping machines and jack hammers) can interfere with the detection of obstacles.

Responding to warning messages

Always heed any warning and information messages displayed in the vehicle.

- ▶ Please refer to chapter "Warning and information messages" on page 271.

Operating principle

When the driver is parking and manoeuvring the vehicle, ParkAssist indicates the distance between the vehicle and an obstacle by visual and audible means. The visual ParkAssist parking aid is displayed in the central display. Obstacles in front of and behind the vehicle are displayed using differently coloured fields. These fields show the shape of the obstacles and their distance from the vehicle.

Distance measurement

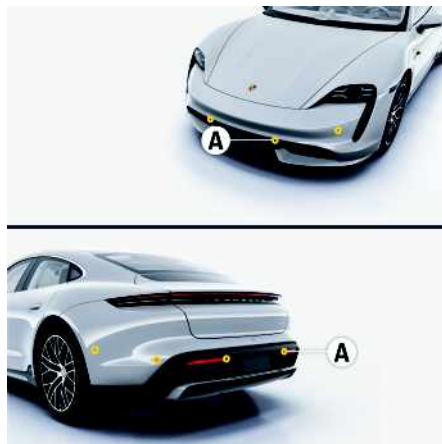

Fig. 132: Ultrasonic sensors for distance measurement

The ultrasonic sensors (A) on the front and rear bumper measure the distance from the closest obstacle. A detected obstacle is signalled by the following sounds:

- **Intermittent tone:** An obstacle was detected.
- **Decreasing intervals:** Approaching the obstacle.
- **Continuous tone:** Distance less than approx. 30 cm.

Activating ParkAssist

Automatically

ParkAssist is activated automatically at speeds of up to approx. 15 km/h and during readiness for operation in the following cases:

- ✓ Reverse gear is engaged.

– or –

- ✓ Distance in front less than approx. 80 cm.
– or –
- ✓ Rolling backwards is detected.

Manually

ParkAssist can be activated manually in the central display:

▶  ▶ Assistance ▶ ParkAssist



Display in the central display



Fig. 133: ParkAssist display

Colour	Distance at front	Distance at rear
White	Distance to obstacles that are not in the path of the vehicle.	
Orange	< 120 cm	< 180 cm

Colour	Distance at front	Distance at rear
Red	< 40 cm	< 40 cm
Red with continuous tone	< 30 cm	< 30 cm

Symbol	Meaning
	Deactivate ParkAssist for the current parking manoeuvre. Deactivation is cancelled if a speed of 15 km/h is exceeded or if gear R is selected again.
	Switch off audio playback.

For information on operating the central display:

- ▶ Please refer to chapter "Porsche Communication Management (PCM)" on page 190.

Deactivating ParkAssist



- ▶ Press the **P** button.

Adjusting the ParkAssist volume

▶  ▶ Assistance ▶  ▶ Assistance system settings ▶ ParkAssist

Switching off automatic activation of ParkAssist

The automatic activation of ParkAssist can be switched off when approaching an obstacle.

▶  ▶ Assistance ▶  ▶ Assistance system settings ▶ ParkAssist

reversing camera



WARNING

Risk of injury due to distorted representation

The objects shown by the camera appear distorted. The reversing camera image does not show the complete area behind the vehicle.

- ▶ Always pay attention to the entire vehicle surroundings.
- ▶ Make sure that no persons, animals or obstacles are within the manoeuvring area.

The reversing camera facilitates monitoring of the area behind the vehicle during parking manoeuvres. The reversing camera image is displayed on the central display.

Activating the reversing camera

Automatically

The reversing camera is activated automatically in the following cases when operational readiness is established.

- ✓ Reverse gear is engaged.
– or –
- ✓ Rolling backwards is detected.

Manually

The reversing camera can be activated or deactivated manually in the central display:

▶  ▶ Assistance ▶ ParkAssist

i Information

In addition to the camera image, guide lines are superimposed on the rear camera view as well. These guide lines indicate the direction the vehicle can follow with the steering wheel in the current position. The guide lines change as the position of the front wheels changes.

Deactivating reversing camera Automatically

✓ Speed is higher than 15 km/h.

Manually

- ▶ Press the **P** button.

Cleaning the reversing camera

- ▶ Press the  button on the vehicle rear once briefly on the camera display.

i Information

- ▶ If windscreen is very dirty, repeat wash.
- ▶ Persistent dirt (e.g. insect remains) should be removed regularly.

Surround View



WARNING

Risk of injury due to distorted display

The objects detected by the camera appear distorted. Many of the screen windows do not show the

entire area around the vehicle.

- ▶ Always pay attention to the entire vehicle surroundings.
- ▶ Make sure that no persons, animals or obstacles are within the manoeuvring area.

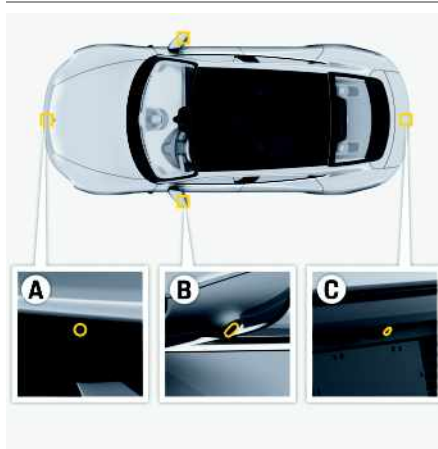

Fig. 134: Position of Surround View cameras

- A** Camera in the centre of the front bumper
- B** Camera in both exterior mirrors
- C** Camera between the number plate lights in the tailgate

Surround View provides a bird's eye view of the vehicle and covers the area around the vehicle. Using the cameras, obstacles or markings are detected, along with the exact position of the vehicle. When Surround View is active, the courtesy lighting is switched on for better illumination.

Activating Surround View

Automatically

- ✓ ParkAssist is active.
- or –





- ✓ Reverse gear is engaged.
- or –
- ✓ Rolling backwards is detected.

Manually

1.  ▶ Assistance ▶ ParkAssist

2. Select the desired view.

The symbol for the active view is highlighted in blue.

Symbol	Meaning
	Parking Switch view by touching the front or rear camera symbol.
	Panorama Switch the view by touching the front or rear camera symbol.
	3D view <ul style="list-style-type: none"> – Switch the perspective by touching one of the side camera symbols. – Select the all-round view by touching the camera symbol at the bottom of the screen and by turning the perspective 360° by swiping the camera image.
	Clean the reversing camera.

i Information

In addition to the camera image, guide lines are superimposed on the front and rear camera views. These guide lines indicate the direction the vehicle can follow with the steering wheel in the current position. The guide lines change as the position of the front wheels changes.

Deactivating Surround View**Automatically**

- ✓ Speed is higher than 15 km/h (9 mph).

Manually

- ▶ Press the **P** button.

A
B
C
D
E
F
G
H
I
J
K
L
M
N
O
P
Q
R
S
T
U
V
W
X
Y
Z

Personal settings

Ergonomic settings can be manually saved and retrieved via the memory buttons in the driver door. In addition, individual accounts that automatically store and retrieve ergonomic and comfort settings can be registered via the central display. Both functions can be used independently of one another.

Saving and retrieving personal settings

When the vehicle is turned off, the settings previously made are saved automatically to the selected account and linked to the driver's key used. The settings are loaded automatically when the door is unlocked. During this process, the account linked with the driver's key is detected. If you and others use the vehicle, it is advantageous to use one account and driver's key per person. If necessary, the accounts can be changed manually.

Ergonomic settings affect: seat, exterior mirror and steering wheel settings. Additionally, up to three ergonomic settings can be manually saved and retrieved via the memory buttons in the driver door.

Comfort settings (depending on the country) affect the following:

Ergonomic, air conditioning, light, vision, assistance-system, instrument cluster and infotainment settings.

Information

Some functions cannot be personalised (e.g. the charge timer, time zones or precooling/preheating).

CAUTION

Retrieving automatic settings for seats, exterior mirrors and steering wheel

Parts of the body may be pinched or crushed if the settings are activated in an uncontrolled manner.

- ▶ Do not leave children in the vehicle unattended.
- ▶ Automatic retrieval of the **ergonomic settings** can be **cancelled** if necessary by pressing a memory button, a seat adjustment button or the central display.

Storing and loading comfort settings

Due to the various usage options, the features described here are not available in all models, countries and equipment versions.

Storing comfort settings

- ▶ When the vehicle is switched off and locked, the previously made settings are **automatically** saved in the account.
- ▶ If the switch is made from an active account to another account, the comfort settings are overwritten. The ergonomic settings are not overwritten.

Loading comfort settings

- ▶ Unlock the vehicle.
The account settings are loaded.
– or –
- ✓ Vehicle is stationary.
- ▶ Change account via the central display.

Managing accounts

Up to 7 accounts can be registered and managed in the central display. One guest account is available; it cannot be deleted.

The driver's personal settings are saved in the account.

When you start the system for the first time, the **Set-up wizard** is displayed in the central display; this will guide you through important configuration steps. We recommend that you run the **Set-up wizard** fully to create the first account correctly. A Porsche ID (Porsche Connect user) is required to set up and use an account. Please refer to chapter "Using Porsche Connect" on page 196.

You can switch between registered accounts at any time via the central display when the vehicle is switched on.

Driver detection occurs automatically via the driver's key. A driver's key is always automatically assigned to the active account.

Information

More information about Porsche Connect (help videos, Porsche Connect operating instructions and questions & answers) can be found at www.porsche.com/connect and in the "Good to know" app (availability dependent on country).

Managing accounts

The accounts can be managed in the central display.

- ▶ Please refer to chapter "Using Porsche Connect" on page 196.

If the activated personalization settings do not match the current driver, we recommend switching to another, registered account. We recommend using your own account. If necessary, a new account can be created and the vehicle settings then

adjusted. This avoids inadvertent adjustment of vehicle settings in the first selected account.

Storing and retrieving ergonomic settings

Storing ergonomic settings on the memory buttons



Fig. 135: Driver door memory buttons

1. Press the **SET** button.
The inscription on the button lights up.
2. Press the relevant memory button **1**, **2** or **3** within 10 seconds.

The settings are stored.

Storage is acknowledged acoustically (driver door only) and the lighting on the **SET** button goes out.

Retrieving ergonomic settings with the memory buttons

- ▶ Press and hold the relevant memory button **1**, **2** or **3** until all settings are retrieved.
– or –
- ✓ Vehicle switched off.
- ✓ The driver door is open.
- ▶ Briefly press the relevant memory button **1**, **2** or **3**.
The settings are automatically applied.

Phone

Brief Overview – Phone

This brief overview does not replace the comprehensive descriptions. In particular, safety messages and warnings are not replaced by this brief overview.

For information on operating Porsche Communication Management (PCM):

- ▶ Please refer to chapter "Porsche Communication Management (PCM)" on page 190.

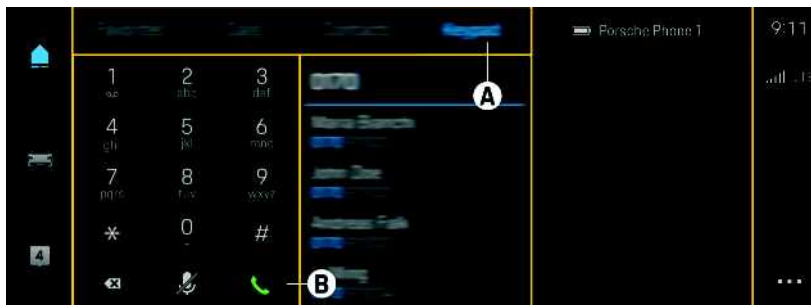















Fig. 136: Dialling a number (keypad)

What do I want to do?	What do I have to do?	Where?
Connecting a phone via Bluetooth®	<ul style="list-style-type: none"> ▶ Touch ▶ Devices ▶ Connection assistant ▶ Connect new telephone. 	▶ p. 183
Switch between two connected mobile phones	<ul style="list-style-type: none"> ▶ Selecting the currently connected mobile phone in the status area. The two devices already connected are displayed ▶ Select the desired mobile phone. 	–
Establishing a data connection		▶ p. 196
Wireless mobile phone charging	<p>Activate the function in the central display: ▶ Phone ▶ ▶ Telephone settings ▶ General settings ▶ Cableless charging.</p> <ul style="list-style-type: none"> ▶ Stow the mobile phone in the smartphone tray. 	▶ p. 185
Dial number	<ul style="list-style-type: none"> ▶ ▶ Phone ▶ Keypad (see A) ▶ Touch (see B) 	–

What do I want to do?	What do I have to do?	Where?
Select emergency call	▶ Trigger an emergency call using SOS button in the overhead console.	▶ p. 108
Store contact as favourite	▶  ▶ Phone  ▶ Favourites (see A) ▶ Add favourite ▶ Select the desired contact from the list ▶ Touch  .	▶ p. 184
Display call list	▶  ▶ Phone  ▶ Call list (see A)	–
Display a contact	▶  ▶ Phone  ▶ Contacts (see A)	–
Display messages	▶ Touch  ▶ Message.	▶ p. 160
Listen to mailbox	▶  ▶ Phone  ▶ Keypad (see A) ▶ Press and hold button 1 (see B).	–
Accept/reject a call	▶ Touch Accept  or Reject  .	–
End a call	▶ Touch  in the footer or Phone menu. – or – Press the  button on the multi-function steering wheel.	–

Various use options are available depending on model, country and equipment. The features described here are therefore not available in all models, countries and equipment versions.



WARNING

Risk of accident due to using mobile phone

Using mobile phones while driving may distract from the traffic situation. You may lose control of the

vehicle.

- ▶ Only make or receive calls using hands-free equipment.



WARNING

Danger of injury

Mobile phones must be switched off in certain danger areas, e.g. near petrol stations, fuel depots, chemical plants or during blasting work. They may

interfere with technical equipment.

- ▶ Always comply with instructions as well as legal requirements and local restrictions.

Connecting a mobile phone via Bluetooth®

Connecting a new mobile phone

- ✓ Bluetooth® function of the mobile phone is activated and is visible to other devices.
- ✓ Bluetooth® function of the PCM activated.

- ▶ Please refer to chapter "Device Manager" on page 102.

1. Tap  ▶ **Devices**  ▶ **connection assistant** ▶ **Connect new telephone**.

2. Select a mobile phone from the device list. A 6-digit Bluetooth® code is generated and displayed both on the central display and mobile phone.

3. Compare the Bluetooth® code on the central display and mobile phone.

4. If the Bluetooth® code in the mobile phone match, confirm.
When the phone is successfully connected, the numeric input (**Keypad** menu) is displayed in the central display.



Information

- Depending on the Bluetooth® capability of the mobile phone, it is possible to access the content of the phone book, call lists and messages. It is also possible to transfer a current call to the mobile phone after stopping the vehicle and continue it outside the vehicle if the mobile phone supports this function.
- You will find an overview of compatible mobile phones on the Porsche website for your country under: Models ▶ Your model (e.g. 911 Carrera) ▶ Download Brochures ▶ Via Bluetooth®.

Connecting a mobile phone (Windows® and iOS operating system)



For mobile phones with Windows® or iOS operating systems, we recommend initiating the connection from the mobile phone:

- ✓ Bluetooth® function of the PCM activated.

1. Search for available devices in the mobile phone's Bluetooth® menu.
2. Select the PCM from the list of available devices. The Bluetooth® device name of the PCM can be displayed in the  ▶ **Devices**  ▶  ▶ **Bluetooth settings** ▶ **Bluetooth name**.

Connecting to registered mobile phones



- ✓ The mobile phone's Bluetooth® function is activated.
 - ✓ Bluetooth® function of the PCM activated.
- ▶ Please refer to chapter "Device Manager" on page 102.

1. Tap  or  in the status area (depending on the connection status).
A list with a maximum of 20 registered mobile phones will be displayed.

2. Select a mobile phone from the list.
The mobile phone is connected via Bluetooth®.

Connecting and using a second mobile phone

- ✓ A mobile phone is already connected to the PCM.

1. Tap  or  in the status area (depending on the connection status).

2. Select a mobile phone from the list or connect a new mobile phone.
Both connected mobile phones can receive calls, but only the active mobile phone can make calls.







3. Select the currently connected device on the right in the status area in order to switch between the two connected mobile phones.
The two devices already connected are displayed.

– or –

Phone  ▶  ▶ **Phone settings** ▶ Select the desired device.



Displaying connection status

The following displays may appear in the status area depending on the model, country and equipment:



-  No phone connected.
-  No data connection available (possible causes: no connection, poor network quality, interruption of the data connection during a voice connection).
-  Data connection via the LTE mobile phone network.
-  Data connection via the UMTS/HSPA mobile phone network (3G).
-  Data connection via the EDGE mobile phone network (GSM).
-  Reception field strength of the mobile phone network for the phone function.
-  Data connection via external WiFi hotspot.

Storing and editing a favourite

Storing a favourite

1.  ▶ **Phone**  ▶ **Favourites**
2. Select a contact from **Last contacted** and move to **Favourites** via drag & drop.

Organising favourites

1.  ▶ **Phone**  ▶ **Favourites**
2. Select the desired contact and move to the desired position via drag & drop.

Deleting a favourite

1. ► **Phone** ► **Favourites**
2. Select the desired contact and move upwards from the **Favourites** display area via drag & drop.
– or –
If available, tap the icon.

Functions during a phone call

- ✓ ► **Phone** ► **Keypad** selected.

Muting the microphone

- ✓ Active phone call.
- Tap to mute the microphone.

Holding a call

- ✓ Active phone call.
- Tap .
- To resume the call, tap .

Starting a conference call

- ✓ Active phone call.
1. ► Add a new call (enter a number or select a contact) ►
 2. Tap to activate the conference call.
 3. Tap to disconnect the conference call.

Switching between two conversations (swapping)

- ✓ First phone call is active.

- ✓ Second phone call is on hold.

- Tap to activate the call on hold and put the previously active call on hold instead.

Displaying phone information in the instrument cluster

- Select the desired function in the Car & Info display on the instrument cluster:
 - Please refer to chapter "instrument cluster" on page 125.
- **Incoming call: Accept** or **Reject** the incoming call using the phone buttons on the steering wheel.
- **Last calls:** Display a list of the last numbers dialled using the phone button and rotary knob on the steering wheel.
- **Conference:** Make other calls or add the participants to a conference call during an active phone call using the rotary knob and phone button on the steering wheel.

For information on operating the instrument cluster:

- Please refer to chapter "instrument cluster" on page 125.

Stowing a mobile phone (availability dependent on country)



Fig. 137: Smartphone tray in the armrest

The smartphone tray in the armrest is used to connect to the vehicle's external antenna and has a USB port for charging the mobile phone and for connecting to the PCM. Using the external antenna ensures less radiation in the vehicle and better reception quality for a mobile phone connected via Bluetooth®.

- ✓ Keypad/code lock on the mobile phone is activated.
- Insert the mobile phone into the smartphone holder with its back facing the side wall.
- Please refer to chapter "Interfaces" on page 102.

Wireless mobile phone charging (availability dependent on country)

The wireless charging function can be activated or deactivated in the central display.



CAUTION

Metal objects in the smartphone tray

Metal objects that are located between the phone and the charging pad during wireless mobile phone charging can become very hot and cause personal injury and damage to property.

- Do not place any objects between the mobile phone and the charging pad.

- ✓ Function activated ► **Phone** ► **...** ► **Telephone settings** ► **General settings** ► **Cableless charging**.
- ✓ Wireless charging according to Qi standard supported by the mobile phone.
- Insert the mobile phone into the smartphone holder with its back facing the side wall.

The symbol appears in the status area of the central display.

A
B
C
D
E
F
G
H
I
J
K
L
M
N
O
P
Q
R
S
T
U
V
W
X
Y
Z

Charging performance can vary according to mobile phone.

Information

A magnetic alternating field is used for wireless charging. Reactions such as irritation of the sensory organs or malfunction of active implants (such as pacemakers, infusion pumps or neurostimulators) or interference with passive implants (such as artificial joints) are possible.

- ▶ Always observe a minimum distance of 10 cm from the charging pad.

The continuous exposure limits according to IC-NIRP1998 are met at this distance.

- ▶ Implant users should consult a specialist if they have any questions.

Changing phone settings

General settings

- ▶  ▶ Phone  ▶  ▶ Telephone settings ▶
Select desired setting.

Managing contacts

- ▶  ▶ Phone  ▶ Contacts ▶  ▶ Select desired setting.

Porsche Active Suspension Management (PASM)

General safety instructions

Responding to warning messages

Always heed any warning and information messages displayed in the vehicle.

- ▶ Please refer to chapter "Warning and information messages" on page 271.

Operating principle

The PASM system actively adjusts the chassis dynamics. Your vehicle may be equipped with one of the following versions:

- PASM with steel suspension.
- PASM with selectable air suspension and levelling system

The adjustable chassis system individually sets the appropriate damper force level for each wheel. 3 different chassis setups can be selected at the push of a button:

- **Normal:** comfort setup
- **Sport:** sporty setup
- **Sport Plus:** very sporty shock setup, such as for driving on the race circuit.

PASM with selectable air suspension and levelling system

The levelling system provided with the air suspension automatically balances load changes and maintains a constant ride height. The following chassis heights are available:

Medium

- Standard level in the "Normal" and "Sport" chassis setups

- Can be selected manually in the "Sport Plus" chassis setup

Lift

- Increases the ground clearance by approx. 20 mm compared to the "Medium" level.
- Can be selected at speeds of up to approx. 30 km/h (19 mph) and is deselected automatically at higher speeds.
- Used to drive over obstacles.

Lower

- Reduces the ground clearance by approx. 10 mm compared to the "Medium" level.
- Can be selected manually.

Low

- Reduces the ground clearance by approx. 22 mm compared to the "Medium" level.
- Used for sporty driving.
- Can be selected manually.
- Selected automatically when the "Sport Plus" chassis setup is active or when RANGE drive mode is active.

When RANGE drive mode is active, a range-optimised chassis setup is selected and the low level is applied. Chassis setup selection is locked in RANGE drive mode.

Selecting chassis setup

Selecting chassis setup using buttons



Fig. 138: PASM button

- ✓ Ready for operation.
- ▶ Press button (repeatedly).

Selecting chassis setup via the central display

- ✓ Ready for operation.



The last selected chassis setup is shown on the instrument cluster. It remains effective even when the vehicle is no longer ready for operation.

Display	Chassis setup
None	Normal
	Sport
	Sport Plus

Selecting the chassis height

- ✓ Porsche Active Suspension Management (PASM) with air suspension and levelling system

- A
- B
- C
- D
- E
- F
- G
- H
- I
- J
- K
- L
- M
- N
- O
- P
- Q
- R
- S
- T
- U
- V
- W
- X
- Y
- Z

A
B
C
D
E
F
G
H
I
J
K
L
M
N
O
P
Q
R
S
T
U
V
W
X
Y
Z

Selecting chassis height via the central display

✓ Ready for operation.

▶  ▶ Drive ▶ Chassis height

Selecting chassis height "Lift" using the button

The chassis height "Lift" can be selected using the button on the instrument cluster in order to increase ground clearance quickly.

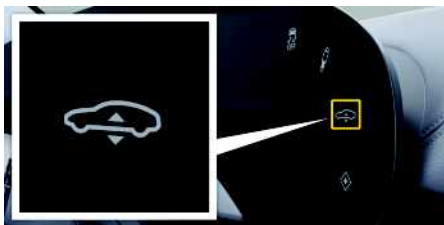



Fig. 139: Lift button



✓ Ready for operation.

▶ Press the button.

The selected chassis height is displayed on the instrument cluster.

The last selected chassis height is shown on the instrument cluster. This is retained even after the vehicle has been turned off.

Display	Chassis height
None	Medium
	Lift

Display	Chassis height
	Lower
	Low

Information

The vehicle will not be lowered with the door open. The selected level is set after closing the door.

Information

Frequent level changes can cause the compressor to overheat. In this case, the compressor must cool for several minutes before the levelling system is fully functional again. The vehicle adjusts automatically to the selected level when the compressor cools down.

Switching the levelling system off

 **WARNING** Lifting the vehicle

If a PASM or hot vehicle warning message is displayed, there is a risk of injuries and damage to the vehicle if the vehicle is hoisted.

- ▶ The vehicle must only be hoisted when cool.
- ▶ If a PASM warning message is displayed, you should not perform any work on the chassis yourself. Call in a qualified specialist workshop. Porsche recommends a Porsche partner as they have trained workshop personnel and the necessary parts and tools.

 **WARNING** Control operation of the levelling system

A vehicle on which the levelling system is activated can move unexpectedly or tip or fall off lifting equipment, e.g. a jack or lifting platform. This can result in serious injury and damage.

- ▶ Set the vehicle to the medium level and switch off the levelling system before hoisting the vehicle.

- ▶ Please refer to chapter "Jack and Lifting Platform" on page 138.

▶  ▶ Setting  ▶ Vehicle ▶ Additional chassis settings ▶ Deactivate chassis adjustment before using a jack

Information

The levelling system is switched on automatically at speeds of more than approx. 7 km/h (4 mph).

Additional information

Lowering the vehicle after leaving it unused for long periods

✓ Porsche Active Suspension Management (PASM) with air suspension and levelling system

If the vehicle is left unused for several weeks, the ride height may be lowered. The vehicle will compensate for this lowering automatically once operational readiness has been established. This process may take several minutes depending on the vehicle. During this time, ground clearance is reduced.

Levelling after parking the vehicle

- ✓ Porsche Active Suspension Management (PASM) with an air suspension and levelling system

The ride height may be adjusted automatically in order to balance the vehicle load after the vehicle is parked.

A
B
C
D
E
F
G
H
I
J
K
L
M
N
O
P
Q
R
S
T
U
V
W
X
Y
Z

Porsche Communication Management (PCM)





Brief Overview – PCM







This brief overview does not replace the complete descriptions provided in this section.











Safety messages and warnings, in particular, are not replaced by this brief overview.



Fig. 140: Areas of the central display

What do I want to do?	What do I have to do?	Where?
Switch on the PCM	▶ Switch on the vehicle.	–
Shut down PCM	▶ Touch  in the centre console control panel ▶ Touch Shut down PCM in the central display.	▶ p. 76
Switch off central display	▶ Touch  in the centre console control panel ▶ Touch Switch off central display in the central display.	▶ p. 76
Adjust the volume	▶ Turn volume control (rotary knob) on the multi-function steering wheel. – or – Touch  /  on the quick access bar. – or – Swipe the handwriting panel vertically with two fingers.	▶ p. 129

What do I want to do?	What do I have to do?	Where?
	Mute: Press the volume control (rotary knob) on the multi-function steering wheel briefly or press longer on  .	
Remote operation of central display	▶ Use the handwriting panel via gestures to navigate in the central display.	▶ p. 76
Use Global search	▶ Enter search text in search area A or use voice input.	–
Display time, connection and status symbols, use options	▶ Use status area B . The relevant settings (e.g. loniser) can be called up directly by selecting the status symbols.	▶ p. 194
Adapt sorting of apps	✓  selected. ▶ In status area B , touch  ▶ Adapt sorting of apps .	▶ p. 124
Open MyScreen	▶ Swipe to the left in the Home screen  . MyScreen  is displayed.	▶ p. 124
Configure My Screen	✓ MyScreen  is displayed. ▶ In status area B , touch  ▶ Configure My Screen .	▶ p. 124
Use content from the main and sub-menus	▶ Use main menu C and content and interaction area E .	▶ p. 194
Open messages	▶ Touch a message in message area D .	▶ p. 173
Context-dependent display area	▶ Use extended display area F .	–
Call up Set-up wizard	When you start the PCM for the first time, the Set-up wizard is displayed and guides you through important steps for configuring the PCM. Calling up Set-up wizard manually:	–

A	What do I want to do?	What do I have to do?	Where?
B C		▶  ▶ Setting  ▶ Set-up wizard	
D E	Activate/deactivate Private mode (available in some countries)	▶ Touch  ▶ Setting  ▶ Porsche Connect settings ▶ Private mode .	▶ p. 196
F G H	Display service interval	▶ Touch  ▶ Service  The display indicates when the next service is due.	–
I	Change system and vehicle settings	▶ Touch  ▶ Setting  ▶ System/Car .	▶ p. 257
J K	Display vehicle information	▶ Touch  (see C) ▶ Drive .	–
L	Display notifications	▶ Touch  in the main menu C.	▶ p. 173

Central display



Fig. 141: Control elements of the central display

A – Home Screen & MyScreen

- ▶ Please refer to chapter "Home screen and MyScreen" on page 124.

B – Main menu (main operating area)

The main menu is divided into three main areas:

- Homescreen/ MyScreen
 - Vehicle Settings
 - Notifications
- ▶ Please refer to chapter "Opening menus" on page 194.

C – Fast filter search/Global search (sub operating area)

Depending on the menu selection, a menu bar appears with further menu items in this area (quick filter bar). The global search is displayed here in the Home Screen.

D – Time/Temperature

- ▶ Please refer to chapter "Setting time or temperature display" on page 194.

E – Filter bar

Depending on the menu selection, a filter bar appears.

F – Connection and status symbols

- ▶ Please refer to chapter "Device Manager" on page 102.

G – Content and interactive area

H – Options and the most important settings depending on content and interactive area

Using options, context-specific settings for the respective display can be made per screen.

I – Detail area

The detail area displays additional information on the content area.

Important information on operation

The Porsche Communication Management (PCM) is the central control unit.

For safety reasons, some functions are only available when the vehicle is stationary.



WARNING

Setting and operating while driving

Setting and operating the multi-function steering wheel, infotainment system, etc. while driving may distract you from the traffic situation. You may lose control of the vehicle.

- ▶ Only operate these components while driving if the traffic situation allows you to do so safely.
- ▶ In case of doubt, safely pull out of traffic and only carry out extensive operations and settings while the vehicle is stationary.

Operating the central display

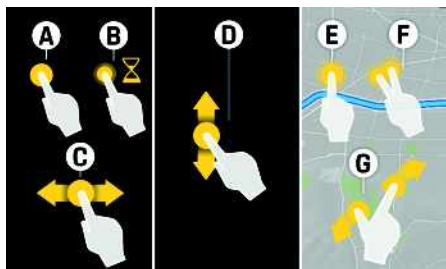

Fig. 142: Operating the central display

A Touch (select)

Briefly tap the central display with your finger. Example: Tap on a function or tick/un-tick a checkbox.

B Long press

Touch the central display with your finger for longer. Example: Confirming a destination on the map (Navigation).

C Swipe

Swipe horizontally across the central display using one finger. Example: Scrolling through lists horizontally.

D Vertical swiping (scroll and switch)

Swipe vertically across the central display using one finger. Example: Scrolling through content vertically.

Zoom

E Briefly tapping the central display twice enlarges that section.

F Briefly tapping the central display using two fingers reduces the size of that section.

G Moving two fingers further apart on the central display enlarges the section.

Opening menus

Opening main menu

- ▶ Tap the menu in the main operating area (e.g.).

Calling up sub-menu

- ▶ Tap the menu item in the quick filter bar (e.g. **Drive**).

Opening the settings for each menu item

- ✓ Desired menu is selected.
- ▶ Tap options. Settings and other functions of the respective content or interactive area are displayed.

Setting time or temperature display

- ▶ Touch time or temperature in the status area to adjust the display.

To adjust the central display:

- ▶ ▶ **Setting** ▶ **Display settings**

Entering text and characters

As soon as you can enter text or characters, e.g. for entering a navigation destination or search term, an input field appears. Touching a search result will zoom in on the results list.

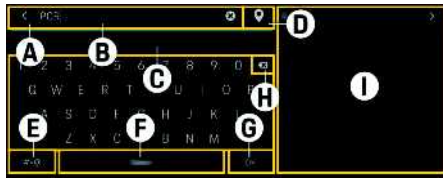

Fig. 143: Central display keyboard

- A Back
- B Current cursor position
- C Auto-correction and suggested results
- D Search area (availability dependent on country)
- E Toggle between entry of letters/numbers and special characters
- F Insert space
- G Zoom in on results list
- H Delete entry
- I Results list

There are various options for entering text and characters:

Entry using the keyboard

1. Touch the input field.
The central display keyboard appears.
2. Enter the desired text or characters.
3. To enter accents, umlauts, etc. press the desired letters for longer.
A window then opens containing accents, umlauts, etc. for these letters.

Entry using the handwriting panel

The handwriting panel in the centre console control panel has handwriting recognition and allows you to write text and characters directly with your finger.



Fig. 144: Freehand entry

- ✓ The keyboard or input field is displayed in the central display.

- ▶ Write text and characters directly with your finger (handwriting recognition).

For information on handwriting entry:

Please refer to chapter "Centre console control panel" on page 76.

Entry via voice input

Text and numbers can also be entered using voice control (e.g. for dialling a phone number or entering a navigation destination).

For information on using voice control:

- ▶ Please refer to chapter "voice control" on page 264.

Using the central display via the handwriting panel

Use the handwriting panel of the centre console control panel via gestures to navigate in the central display.

For information on using the centre console control panel:

- ▶ Please refer to chapter "Centre console control panel" on page 76.

Opening Driver's Manual in Zentralsdisplay

- ✓ Vehicle is stationary.

- ▶  ▶ eBAL

Porsche Connect

Due to the various use options, the features described here are not available in all models, countries and equipment versions.

Depending on the country, the data connection can be established via the embedded SIM card or an external WiFi hotspot. The currently active data connection is shown in the status area of the central display and in the device manager.

- ▶ Please refer to chapter "Porsche Communication Management (PCM)" on page 190.
- ▶ Please refer to chapter "Device Manager" on page 102.

Establishing data connection via embedded SIM card (available in some countries)

- ✓ Private mode is deactivated.
- ▶ Please refer to chapter "Activating Privacy mode (available in some countries)" on page 198.



The data connection is established automatically when operational readiness is established.

Information

If a data connection cannot be established, check the following:

- Private mode is deactivated.
- The vehicle is in an area with sufficient network reception (not a coverage blackspot).
- ▶ Restart the PCM if necessary.

Show data volume



- ▶  ▶ **Setting**  ▶ **Privacy and Porsche Connect settings** ▶ **Remaining data volume display**

Information about the data package booked is displayed in some countries.

When a data package has been fully used, a message appears automatically on the central display.

Establishing a data connection via an external WiFi hotspot (available in some countries)

- ✓ Mobile phone WiFi hotspot or public hotspot available.

1. In the  or  status area (depending on the connection status),  ▶ **select WiFi settings** ▶ **Search for external WiFi hotspot**.



A search is performed for WiFi networks and the results are displayed.

2. Select a WiFi hotspot (e.g. public hotspot or the mobile phone's personal hotspot) and enter WiFi access data in the PCM. When entering the data, pay attention to upper and lower case. A connection is established to the external WiFi hotspot.



Activating the PCM WiFi hotspot (available in some countries)

Up to eight WiFi devices can be connected to the vehicle hotspot.

- ✓ Data connection successfully established via integrated SIM card (available in some countries).
- ✓ Corresponding data package booked at www.porsche.com/connect.

1. In the  or  status area (depending on

connection status),  ▶ **select WiFi settings** ▶ **Configure vehicle hotspot**.

2. Accessing WiFi access data PCM:  ▶ **Setting**  ▶ **Connection assistant** ▶ **Connect to vehicle hotspot**

The PCM device name and WiFi password are shown on the central display.

3. Enter the PCM WiFi access data in the device WiFi settings or scan the QR code displayed in the PCM with the device. A connection to the PCM's wireless Internet access is established.

Using Porsche Connect

A data connection is required in order to use Porsche Connect services.

Information

More information about Porsche Connect (help videos, Porsche Connect operating instructions and questions & answers) can be found at www.porsche.com/connect and in the "Good to know" app (availability dependent on country).

Activating Porsche Connect services

Before starting to use the Porsche Connect services for the first time, they must be activated.

- ▶ Activate Porsche Connect Services under www.porsche.com/connect.

Using services in the navigation system and voice control system

- Online search function for entering navigation destinations and for loading portal POIs and other POI categories from My Porsche



- Additional map display.
- Real-time Traffic provides information on accidents, construction works, traffic jams and other incidents from the Internet.
- Online voice search

Logging in Porsche ID (Porsche Connect user ID)

The Porsche ID is a verified e-mail address that is used as the Porsche Connect username in My Porsche, the Porsche Connect Store and Porsche Connect App.

- ✓ Porsche Connect A user (Porsche ID) is registered in My Porsche.
- ✓ Porsche ID security code created in My Porsche and known.

You must log in with the Porsche ID in the vehicle to use some Porsche Connect services. Logging in allows you to access personal My Porsche settings in the vehicle.

1.  ▶ **Setting**  ▶ **Accounts** ▶ **Create account**



2. Enter Porsche ID and My Porsche password and touch **Next** to confirm.

3. Enter the **security code** from My Porsche.

User is logged in and the  symbol appears in the status area.

Managing your Porsche ID (Porsche Connect user)

- ✓ Porsche ID (Porsche Connect user) is logged in.

▶  ▶ **Setting**  ▶ **Accounts** ▶ Select account
▶  ▶ Complete action:

- **Log in using security code:** When operational readiness is established or the account is

changed, the Porsche ID must be confirmed and the security code entered.

- **Login without security code:** When operational readiness is established or the account is changed, it is only necessary to confirm the Porsche ID.
- **Automatic login:** When operational readiness is established or the account is changed, the Porsche ID is logged in automatically without needing to be reconfirmed.
- **Delete account:** The Porsche ID is deleted from the vehicle.
- **Deregister account:** The Porsche ID is deregistered from the vehicle. The guest account is activated.

Using Porsche apps



- ▶ Please refer to chapter "Apps" on page 56.

Information

- The Porsche Connect service package offers a wide range of Porsche Connect services for a free, inclusive period, which may vary in length for each service and country. More information about the free, inclusive periods and subsequent costs along with information about the availability of individual services for your country is available online at www.porsche.com/connect or from your Porsche partner.
- Depending on the country, Porsche Connect Services can be used via the embedded SIM or the external WiFi hotspot.
- You may incur additional charges when receiving data packages from the Internet, depending on your mobile phone tariff and whether you are abroad. A flat-rate data plan is recommended.
- The availability, scope and provider of the services may vary depending on the country, model year, device and tariff.

Porsche Connect settings

Displaying service overview



▶  ▶ **Setting**  ▶ **Privacy and Porsche Connect settings** ▶ **Select overview of all Porsche Connect services.**

Information about the services purchased and contract duration is displayed.

Granting remote access authorisation

- ✓ Main user logged into the vehicle at least once. Remote access authorisation is required to use service control programmes in My Porsche or the Porsche Connect App (available in some countries) in the vehicle. Remote access authorisation is

A granted automatically as soon as the main user logs into the vehicle for the first time.

- B
- C ▶ Check registered accounts under:  ▶ **Setting**
 ▶ **Accounts**
- D

E **Activating Privacy mode (available in some countries)**

F Communication between the vehicle and the Porsche Connect App as well as My Porsche is suppressed when privacy mode is active. No vehicle-specific information is transmitted. This means that no vehicle settings can be configured using the app or My Porsche.

J  Remote access authorisation granted.

- K
- L ▶  ▶ **Setting**  ▶ **Privacy and Porsche Connect settings** ▶ **Privacy mode**

M Privacy mode can be activated or deactivated globally, for individual services or for service groups.

N ▶ Please refer to chapter "Apps" on page 56.

O Despite activated private mode, location information for the vehicle can be transmitted in the event of a breakdown or emergency call as well as theft.

P ▶ Please inform all persons using the vehicle that communication may be disabled.

Q

R

S

T

U

V

W

X

Y

Z

Porsche InnoDrive (PID)

General safety instructions

⚠ WARNING Lack of attention

The increased comfort offered by the system should not induce you to risk your safety. The driver remains responsible when driving, such as by keeping a safe distance or driving at an appropriate speed, even when the system is activated. The system cannot replace the driver's attentiveness.

- ▶ Drive with extreme care.
- ▶ If the system-related deceleration is insufficient, slow the vehicle down immediately using the footbrake.
- ▶ Make sure that it is possible to take over control of the vehicle at all times.

⚠ WARNING Unsafe traffic situations and unfavourable road conditions

Use of the system may cause accidents if the current situation does not permit driving safely at an adequate distance from the vehicle in front and at a constant speed.

The system assists the driver when turning off and driving on exits. If conditions are particularly poor, unwanted driving situations may arise.

The vehicle may accelerate to the set speed in areas near construction sites.

- ▶ Do not use the system in heavy traffic, in the vicinity of construction sites or in built-up areas.
- ▶ When turning off and driving on exits while the system is active, be sure to indicate in good time, take particular care and, if necessary, take

control of the vehicle.

⚠ WARNING Covered front camera or radar sensor

Covering the front camera or radar sensor can adversely affect or disable the function of the system.

- ▶ Always keep the radar sensor and camera area **A** on the interior mirror free of dirt, ice and snow.
- ▶ Do not cover camera area **A** on the interior mirror with objects (e.g. stickers).



Fig. 145: Location of the radar sensor



Fig. 146: Windscreen camera

⚠ WARNING Damage to the radar sensor and camera

Shocks or damage to the bumper, wheel housings or underbody, such as through parking collisions, may move the sensors. Stone damage in the area of the camera on the interior mirror can impair the camera view. This can adversely affect the system.

- ▶ Visit a qualified specialist workshop. Porsche recommends a Porsche partner as they have trained workshop personnel and the necessary parts and tools.

⚠ WARNING Foot placed on the accelerator pedal

The system does not brake automatically when the foot is placed on the accelerator pedal. Placing the foot on the accelerator may override cruise and distance control.

- ▶ When the system is activated, remove your foot from the accelerator pedal.

⚠ WARNING Braking behaviour at Stop and Yield signs

The system assists the driver when approaching Stop and Yield signs if they are stored in the navigation data. This will only slow down the vehicle but not brake it to a standstill.

- ▶ You should brake to a standstill when approaching Stop signs and, where the traffic situation requires it, when approaching Yield signs as well.

WARNING

Detecting traffic light signals

The system does not detect traffic light signals.

- ▶ You should take control of the vehicle at traffic lights that require your vehicle to brake and stop.

WARNING

Inadequate braking power during automatic braking by the system

If the system detects that braking assistance is required on the part of the driver, a warning signal sounds and a warning symbol appears on the instrument cluster. In this case, the braking power of the system is not sufficient to prevent a collision.

- ▶ You must brake immediately in this case.

WARNING

The system is switched off.

The system switched off if the following situations arise:

- PSM is deactivated.
- The driver's door is opened.
- The driver's seat belt is unfastened.
- Drive position **N** or **R** is selected.
- The parking lock or parking brake is activated.
- While driving on private roads and field tracks or on streets where traffic calming measures are in place (e.g. residential streets).
- Where the vehicle is in a position that cannot be detected clearly by the system.
- In a country that has not been enabled.
- At a speed limit of under 30 km/h.
- ▶ You need to take control of the vehicle in such situations.

i Information

In some cases, the system automatically identifies that driver intervention is necessary. In such cases, a corresponding message appears in the instrument cluster.

System limitations**WARNING**

Unfavourable road and weather conditions

Radar sensor vision can be impaired by rain, snow, ice, fog, loose gravel or spray. Vehicles in front will not be detected properly or may not be detected at all.

Reflective objects such as ice, heavy rain, guardrails or tunnel entrances may impair the functionality of the radar sensor. A message indicating that the system is not available will appear on the instrument cluster.

- ▶ Do not use the system under such conditions.

WARNING

Undetected vehicles or objects

The radar sensor detects a narrow, cone-shaped area in front of your vehicle. As a result, vehicles or objects may not be detected in time or cannot be detected in the following situations:

- in the case of vehicles that change lanes or cut in
- in the case of vehicles with a small cross-section or narrow vehicles
- when driving into and out of bends
- in the case of stationary vehicles
- in the case of vehicles with large overhangs
- in the case of pedestrians, cyclists and animals
- in the case of objects on the road

- in the case of oncoming vehicles and cross traffic
- ▶ Take action and brake if necessary.
- ▶ Drive with extreme care and always pay attention to the traffic conditions and vehicle surroundings.

Vehicles changing lanes or cutting in and narrow vehicles

Fig. 147: Vehicles changing lanes or cutting in (A) and narrow vehicles (B)

Vehicles changing lanes will not be detected until they are completely in the same lane and within the detection range of the sensors.

Cornering and stationary vehicles

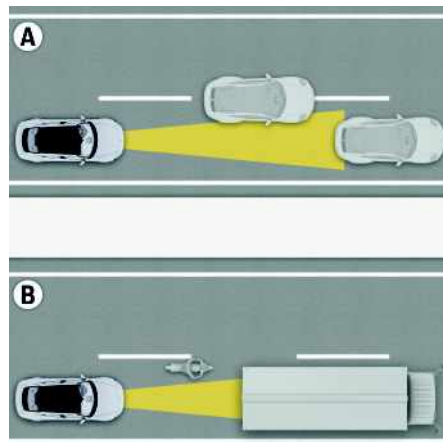
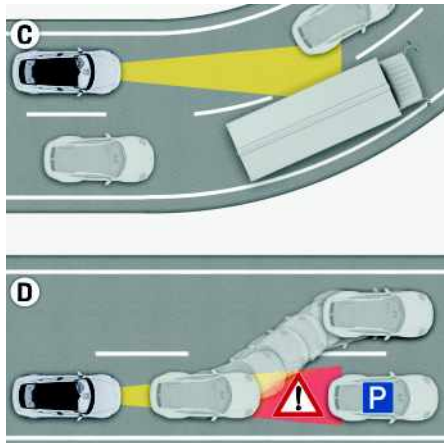

Fig. 148: Cornering (C) and stationary vehicles (D)

When driving into and out of bends, vehicles will not be detected or will be detected too late, or the system will react to vehicles in adjacent lanes.

A stationary vehicle or obstacle that appears suddenly in the detection range of the radar sensor, such as after a vehicle in front changes lanes or at the end of a traffic jam, can only be detected by Adaptive Cruise Control (ACC) to a limited extent.

Vehicles with large overhangs



Fig. 149: Vehicles with large overhangs

If there is a vehicle in front with a long overhang (such as a timber lorry), the radar sensor may possibly not detect the end of the vehicle or detect it incorrectly.

Responding to warning messages

Always heed any warning and information messages displayed in the vehicle.

▷ Please refer to chapter "Warning and information messages" on page 271.

Operating principle

Porsche InnoDrive (PID) is a driver assistance system that assists the driver when driving on well-surfaced country roads and motorways.

Using navigation data as well as data from radars and cameras, PID detects both the area directly around the vehicle and the route ahead, determines the best possible driving strategy in advance and adapts the speed accordingly.

PID can assist the driver in the following situations:

Vehicle driving ahead

If a vehicle was detected ahead, PID brakes if the vehicle is driving slower than the set desired speed and keeps the distance from the vehicle ahead constant in the preselected range. PID can continue

braking until your vehicle is stationary and starts driving again automatically as soon as the vehicle in front drives off again. A detected vehicle and the fact that the vehicle has started driving again will be indicated on the instrument cluster.

In bends

Navigation data and vehicle information is used to adapt the speed to the road ahead. Tight bends detected in advance are displayed on the instrument cluster and the speed of the vehicle is reduced in good time. The speed calculated for the bend is also indicated through the speed prediction system. If no bend ahead warning is displayed, the speed will only be reduced slightly or will not be reduced at all. Vehicle handling in bends is also influenced by the driving mode selected.

At roundabouts, junctions and on uphill and downhill slopes

When navigation is active or when the driver indicates in good time, PID reduces the speed before the vehicle starts to change direction. A corresponding display appears on the instrument cluster.

i Information

When route guidance is active in the navigation system, PID always orients itself according to the proposed route. If route guidance is not active, it adapts to the most plausible route.

On roads with speed limits

PID uses navigation data and data from cameras (traffic sign recognition) to automatically detect the speed limit within the system limits and changes the desired speed accordingly.

A Speed limits detected in advance are displayed on the instrument cluster and the speed of the vehicle is reduced in good time. If a speed limit is not detected in advance, the speed will not be reduced until the vehicle is driving past the detected traffic sign.
E Consideration of speed limits is active automatically when PID is activated.

At Stop and Yield signs

H When approaching Stop and Yield signs, a message appears in the instrument cluster and the speed is reduced if the traffic signs are stored in the navigation data. It is up to the driver, however, to brake the vehicle to a standstill.

K If the driver accidentally continues driving at a Stop sign, PID switches to passive mode and can be activated again afterwards by the driver.

L If the driver continues driving at a Yield sign, PID remains active, passes the Yield sign at a reduced speed and accelerates again to the previously set speed as soon as the traffic situation allows it. The previously set speed can be resumed again immediately by pressing **RESUME**.

Controls

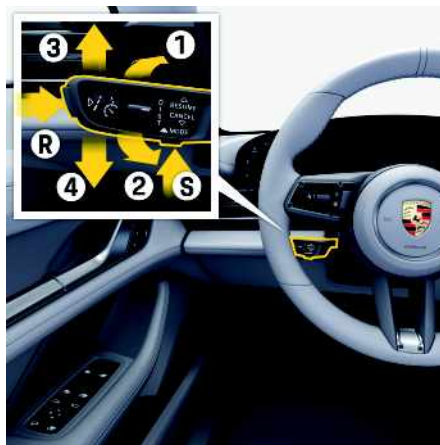

Fig. 150: Control stalk for driver assistance systems

- R** Switch systems on/off and open the options menu
- S** Open the options menu (when the system is switched on)
- 1** Set/increase the desired speed
- 2** Reduce the desired speed
- 3** RESUME: Resume control, adopt speed/confirm speed limit
- 4** CANCEL: Interrupt control

Display elements

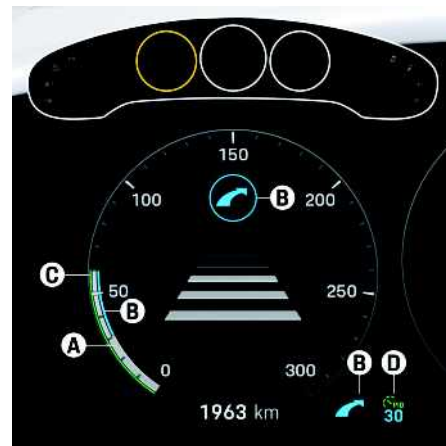





Fig. 151: PID display

- A** Own speed
- B** Event up ahead: Display on speedometer and via symbols (or one of the symbols)
- C** Set speed
- D** Status display

Status display symbols

Symbol	Meaning
	PID is passive.
	PID is passive at set desired speed.

Symbol	Meaning
	PID is active at set desired speed.
	PID is active. A speed limit was detected ahead or the set desired speed was not yet reached.
	A vehicle was detected ahead while the desired speed was set. A vehicle symbol is displayed instead of the speedometer symbol.

Operating states

Passive

This mode is set after switching on and when PID is active after pressing the brake pedal and after pressing down the control stalk (**CANCEL**).

- The status display is grey.
- There is no control.
- The desired speed stored and desired distance set are retained.

Active

This mode is set after setting the desired speed, after resuming control (**RESUME**) and after temporarily overriding control by pressing the accelerator pedal.

- The status display is green or blue.
- The speed and distance from the vehicle in front are regulated subject to the recognised speed limit (if activated) and the road ahead.

Temporarily passive

This mode is set while the accelerator pedal is pressed when PID is active.

- A message indicating that PID is passive appears on the instrument cluster.
- The status display is grey.
- There is no control.
- The stored target speed and selected target distance are retained.
- Control is active again after releasing the accelerator pedal.

Switching PID on and off

The system that was selected last is always switched on. The system is initially in passive mode when switched on. It must first be activated before the control function starts working.

Switching the PID on

✓ No driver assistance system has been switched on yet.

1. Press the **R** button on the control stalk. The options menu for the driver assistance systems appears on the instrument cluster.
2. If PID is not already selected, select **PID** using the rotary knob on the steering wheel and press to confirm.

PID is switched on and **passive**.

Switching from an already activated driver assistance system to PID

1. Press the **S** button on the control stalk. The options menu for the driver assistance systems appears on the instrument cluster.
2. Select **PID** using the rotary knob on the steering wheel and press to confirm.

PID is switched on and **passive**.

i Information

The last selected driver assistance system is retained even after switching it off and operational readiness is restored.

Switching off PID

- ▶ Press the **R** button on the control stalk. The set desired speed is deleted. The desired distance is stored.

Activating PID

- ✓ PID switched on.

Setting the current driving speed as the desired speed

1. Accelerate or decelerate to the desired speed using the accelerator pedal.
2. Briefly press the control stalk forward (position **1**) and release the accelerator pedal.

PID is **active**. The current speed is set as the desired speed, shown in the status display and automatically maintained unless a slower vehicle is detected ahead.

Setting the detected speed limit as the desired speed

- ✓ Consider speed limits activated.
- ▶ Press the control stalk upwards (**RESUME**) and release the accelerator pedal.

PID is **active**. The current detected speed limit is set as the desired speed, shown in the status display and automatically maintained unless a slower vehicle is detected ahead.

i Information

- Speed limits are only considered when PID is activated.
- The set maximum speed is adopted for roads with no speed limit.
- When the system is active, it is also possible to switch the driver assistance system using the **S** button. The newly selected system is in passive mode after switching.

Changing the desired speed

The set desired speed or the detected speed limit can be changed by pressing the control stalk.

- ✓ PID is active.

Increasing the speed

- ▶ Push the control stalk forward (position 1).
 - Press briefly = 1 km/h (1 mph) increments
 - Press and hold = 10 km/h (6 mph) increments

Reduce speed

- ▶ Pull the control stalk (position 2).
 - Pull briefly = 1 km/h (1 mph) increments
 - Pull and hold = 10 km/h (6 mph) increments

Resetting the changed desired speed to the detected speed limit

- ▶ Briefly push the control stalk up (**RESUME**). The currently detected speed limit is confirmed.

Discarding an automatically accepted speed limit

- ▶ Push the control stalk up for longer (**RESUME**). The set speed limit is discarded and the previously set desired speed is retained.

Changing the desired distance

- ▶ Please refer to chapter "Adaptive Cruise Control (ACC)" on page 34.

Overriding speed and distance control temporarily

- ▶ Please refer to chapter "Adaptive Cruise Control (ACC)" on page 34.

Interrupting and resuming cruise control and distance control

- ▶ Please refer to chapter "Adaptive Cruise Control (ACC)" on page 34.

Braking to a standstill and driving off again

- ▶ Please refer to chapter "Adaptive Cruise Control (ACC)" on page 34.

Activating and deactivating consideration of speed limits

- ▶  ▶ Assistance ▶  ▶ Assistance system settings ▶ Porsche InnoDrive ▶ Consider speed limits

Manually considering a detected speed limit

If the consideration of speed limits is deactivated, Porsche InnoDrive still displays detected events such as bends, grades and vehicles driving ahead. A detected speed limit can be manually accepted by the driver.

- ✓ Consideration of speed limits deactivated.
- ✓ The speed limit is detected and appears grey in the status display.
- ▶ Push the control stalk up (**RESUME**).

The set speed limit is displayed in the status display in blue.

Setting the maximum speed

On roads with no speed limit or if no speed limit has been detected, the maximum speed will be set as the desired speed. If a speed limit is detected, the following applies:

- If the maximum speed is above the speed limit, the speed limit will be set as the new desired speed.
- If the maximum speed is below the speed limit, the maximum speed will be set as the new desired speed.

Setting the maximum speed

- ▶  ▶ Assistance ▶  ▶ Assistance system settings ▶ Porsche InnoDrive ▶ Maximum speed

The maximum speed set remains active until it is reset, even with a change of driver or when the vehicle is restarted.

Additional information**Example of how Porsche InnoDrive works**

The example below compares two scenarios when driving into a city with a 50 km/h (30 mph) speed limit - one scenario with the Consider speed limits function activated and the other with the Consider speed limits function deactivated.

Consider speed limits function activated

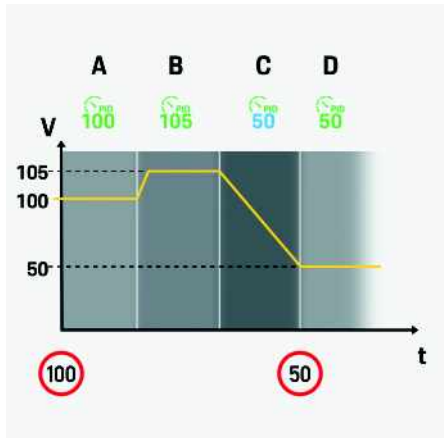

Fig. 152: Example of driving with the Consider speed limits function activated

- A** The vehicle regulates the speed to the detected speed limit of 100 km/h (60 mph).
- B** The driver sets the desired speed 5 km/h (3 mph) higher based on the detected speed limit. The vehicle regulates the speed to 105 km/h (63 mph).

- C** A speed limit of 50 km/h (30 mph) has been detected ahead (e.g. built-up area boundary). The vehicle progressively reduces the speed until the municipal boundary is reached.

The detected speed limit is displayed in blue.

- D** When the municipal boundary is reached, PID regulates the speed to the new speed limit of 50 km/h (30 mph).

Consider speed limits function deactivated

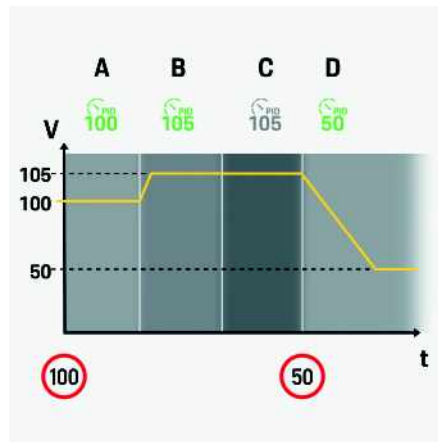

Fig. 153: Example of driving with the Consider speed limits function deactivated

- A** The vehicle regulates the speed to the desired speed of 100 km/h (60 mph) set by the driver.
- B** The driver sets the speed 5 km/h (3 mph) higher. The vehicle regulates the speed to 105 km/h (63 mph).
- C** After driving past a 50 km/h (30 mph) speed limit sign, the vehicle regulates the speed to the desired speed of 105 km/h (63 mph) set by the driver. The speed limit of 50 km/h (30 mph) is displayed in grey on the instrument cluster.
- D** The driver acknowledges the currently detected speed limit of 50 km/h (30 mph) by pressing up the control stalk (**RESUME**). The vehicle regulates the speed to 50 km/h (30 mph) and the set desired speed appears green in the status display. If the speed is set again before reaching the traffic sign, the set desired speed will be displayed in blue.

Porsche Stability Management (PSM)

General safety instructions

WARNING

Loss of control over the vehicle

PSM does not reduce the risk of accidents owing to an inappropriate driving speed.

The increased safety provided should not induce you to take greater risks with your safety. The physical driving limits cannot be overcome, even with PSM.

- ▶ Despite PSM, the driver remains responsible for adapting the driving style and manoeuvres to the road and weather conditions, as well as the traffic situation.

Responding to warning messages

Always heed any warning and information messages displayed in the vehicle.

- ▶ Please refer to chapter "Warning and information messages" on page 271.

Operating principle

Porsche Stability Management (PSM) is an active control system for stabilising the vehicle in extreme driving situations. It is automatically enabled when operational readiness is established. The main components of the PSM system are the Automatic Brake Differential (ABD) and Anti-slip Regulation (ASR) systems, the drive drag torque control system and the Anti-lock Brake System (ABS).

PSM adjustments can be indicated by the following:

- The PSM warning light flashes on the instrument cluster.
- Hydraulic noises can be heard

- The vehicle decelerates and steering-wheel forces are altered as PSM controls the brakes
- Reduced engine power
- The brake pedal pulsates and its position is changed during braking

Automatic Brake Differential

If one wheel of a driven axle starts to spin, it is braked so that the other wheel on the same axle can be driven.

Anti-slip Regulation

The Anti-slip Regulation system prevents the wheels from spinning by adjusting the drive power, thereby ensuring good lane-holding ability and stable handling.

Drive drag torque control

In excessively slippery conditions, the drive drag torque control system prevents all driven wheels from obstructing when the vehicle is accelerating. This is also the case when downshifting on a slippery road.

Anti-lock brake system (ABS)

The anti-lock brake system prevents the wheels from locking during full braking.

- ▶ Please refer to chapter "ABS brake system (Anti-lock Brake System)" on page 207.

Steering torque pulse

The steering torque pulse provides the driver with steering assistance when braking on road surfaces with differing friction values. Targeted pulses also assist the driver during countersteering.

Activating PSM Sport

WARNING

Limited PSM support

In PSM SPORT mode, PSM support is limited in critical driving situations outside the ABS control range.

- ▶ PSM SPORT mode should always be switched off during "normal" driving.
- ▶ Never activate PSM SPORT mode when driving with a spare wheel.

- ✓ Vehicles with Sport Chrono package.

In PSM SPORT mode, the system is switched to a particularly sporty mode.

- ▶ Press the button briefly.
The button lights up yellow and **PSM SPORT** is displayed on the instrument cluster.

Switching off PSM

WARNING

No PSM support

When PSM is switched off, PSM support is no longer provided in critical driving situations outside the ABS control range.

- ▶ PSM should always be switched on during "normal" driving.
- ▶ Never switch off PSM when driving with a spare wheel.



Fig. 154: PSM OFF button

- ▶ Press and hold the  button for at least 2 seconds.

The  button lights up yellow and **PSM OFF** is displayed on the instrument cluster.

Information

When you brake in the ABS control range, the vehicle is stabilised even when PSM is switched off. One-sided spinning of the wheels is prevented even when PSM is switched off.



In exceptional situations, however, it can be advantageous to switch off PSM temporarily:

- on loose surfaces
- in deep snow
- when "rocking the vehicle free"

Information

When PSM SPORT mode is active, it is only possible to switch to PSM OFF mode if PSM was activated beforehand.

Switching PSM back on

- ▶ Press the  button.
PSM is active immediately.
The  button lights up white.

PSM SPORT or PSM OFF no longer appears on the instrument cluster.

ABS brake system (Anti-lock Brake System)

 **WARNING** Loss of control over the vehicle

ABS does not reduce the risk of accidents owing to an inappropriate driving speed.

The increased safety provided should not induce you to take greater risks with your safety. The limits set by the laws of driving physics cannot be overcome, even with ABS.

- ▶ Despite the advantages of ABS, the driver is responsible for adapting his or her driving style and manoeuvres in line with road and weather conditions, as well as the traffic situation.

Operating principle

The anti-lock brake system (ABS) prevents the wheels from locking during full braking. This gives the vehicle improved driving stability and manoeuvrability in hazardous situations.

ABS begins to take control as soon as one wheel shows a tendency to lock.

This controlled braking process is comparable with extremely rapid cadence braking. A pulsating brake pedal and a "juddering noise" alert the driver to adapt his or her driving speed to the road conditions.

Performing full braking with ABS

Full braking is necessary:

- ▶ Fully depress the brake pedal during the entire braking operation, despite the pulsing pedal. Do not reduce the braking pressure.

Multi-collision braking

During an accident, multi-collision braking can help the driver reduce the risk of skidding and further collisions during the accident through automatically initiated braking.

Prerequisites

Multi-collision braking only works:

- in the event of front, side and rear-end collisions
- if the airbag control unit detects a corresponding activation threshold during an accident
- if an accident occurs when the vehicle is travelling at a speed of more than approx. 10 km/h

Information

The vehicle is decelerated automatically by the PSM system, provided the hydraulic brake system, PSM, and electrical system remain undamaged and operational during the accident.

Exceptional conditions

The following activities prevent automatic braking in the event of an accident:

- The driver presses noticeably on the accelerator pedal.
- The braking pressure exerted by the driver on the brake pedal is stronger than the brake pressure applied by the system.

Porsche Vehicle Tracking System (PVTS)

General safety instructions

Responding to warning messages

Always heed any warning and information messages displayed in the vehicle.

- ▶ Please refer to chapter "Warning and information messages" on page 271.

Operating principle

PVTS is a GSM/GPS-based tracking system that allows a Security Operating Centre (SOC) to locate the vehicle if it is stolen. It can then be found by the authorities.

As soon as PVTS detects a theft alarm, the location of the vehicle in question is sent to the Security Operating Centre (SOC). PVTS vehicle equipment is available in two versions depending on whether the driver is in possession of a Driver Card:

- **PVTS Plus** with Driver Card
- **PVTS** without Driver Card

The PVTS vehicle equipment is affected by the insurance and legal requirements in the relevant country. If you have questions about the installed PVTS variant:

- ▶ Contact your Porsche partner.

Information

For vehicles with the smartphone app Porsche Connect or Car Connect¹ some PVTS Plus settings can be implemented directly using the app or at www.porsche.com/connect.

Detailed information on installation, functions and management of the contract can be found at: www.porsche.com/connect.

Scope of delivery and initial activation

PVTS is tested by your Porsche partner and activated together with the vehicle owner.

Following activation, the vehicle owner receives important details, such as the telephone number of the local Security Operating Centre (SOC) and of your service provider.

Detailed information on activating the system is available at www.porsche.com/connect or from a Porsche partner.

Functions

Vehicle tracking is only carried out if the vehicle is stolen. In this case, a notification is sent to the specified mobile phone number. The location of the vehicle is not specified in the notification for safety reasons.

- ▶ Contact the Security Operating Centre (SOC) if your vehicle is stolen. In addition, report the theft to the competent police authority.

The following alarms can be set:

- **Unauthorised movement of the vehicle:** The vehicle is being moved with the ignition switched off. For vehicles with a Driver Card: The vehicle is

being moved without the Driver Card being present.

- **Sabotage:** PVTS was used without authorisation.
- **Break-in alarm:** The alarm system was triggered and has been active for more than 15 seconds.

Information

- There is no guarantee that the theft of a vehicle will always be detected.
- The PVTS alarm can be triggered even if the vehicle battery is flat.

Information

Note for Belgium / Luxembourg:

If the Driver Card remains in the parked vehicle for longer than 30 minutes, it becomes invalid. In order to reactivate the card, disarm mode must be activated via the app, customer portal or Security Operating Centre (SOC).

Information

- If the vehicle was stolen, the Security Operating Centre (SOC) can prevent the engine from starting.
- For vehicles with the smartphone app Porsche Connect or Car Connect¹ in case of theft, access to the app or My Porsche the vehicle is prevented.

1. (available in some countries)

Operating the PVTS without a Driver Card

When PVTS is operated normally, no intervention on the driver's part is required.

Operating PVTS Plus with Driver Card

PVTS Plus can be activated and deactivated automatically using a Driver Card.



Fig. 155: PVTS Plus Driver Card

Activating PVTS Plus with the Driver Card

- ▶ Switch off the ignition and take the Driver Card with you when you leave the vehicle.
If the Driver Card is far enough away from the vehicle, PVTS Plus will be activated after approx. 70 seconds.
Theft of the vehicle can be detected.

Deactivating PVTS Plus with the Driver Card

- ▶ Store the Driver Card in the centre console of the vehicle or keep it on you.
PVTS Plus is deactivated when the Driver Card is located inside the vehicle.

Information

- Do not put the Driver Card in the luggage compartment or engine compartment or in the immediate vicinity of metal (e.g. coins) or a mobile phone.
- Vehicles are very often stolen using stolen driver's keys. Do not fasten the Driver Card to the driver's key.

Information

The PVTS Plus can detect up to 7 Driver Cards per vehicle. Only one Driver Card must be present in the vehicle. If you wish to add, delete or replace a Driver Card:

- ▶ Contact your Porsche partner.

Driver Card malfunction

In exceptional cases (e.g. interference from radio waves), the Driver Card may not be detected. A warning message appears on the instrument cluster.

Driver Card emergency deactivation

- ▶ If PVTS Plus cannot be deactivated using the Driver Card (e.g. if the Driver Card battery is flat or the Driver Card has been lost), contact the Security Operating Centre (SOC) to have the system deactivated, or activate "Disarm mode" using the app or at www.porsche.com/connect.

Transport

If the vehicle is to be transported (e.g. on a ferry), transport mode must be activated.

If the vehicle is not transported in transport mode, the system may trigger a false alarm, which is also subject to a charge (further information is available at www.porsche.com/connect).

Activating and deactivating transport mode

- ▶ Contact the Security Operating Centre (SOC) before transporting the vehicle and when you have finished transporting the vehicle.
– or –
- ▶ Using the Porsche Connect, Car Connectsmartphone app¹ or at www.porsche.com/connect, before transporting the vehicle and when you have finished transporting the vehicle.

Service

PVTS must be set to vehicle servicing mode in the following situations:

- during customer service (e.g. for regular servicing)
- when the vehicle battery is disconnected

If the vehicle is not serviced in vehicle servicing mode, the system can trigger a false alarm, for which you may be billed (further information is available at www.porsche.com/connect).

Activating and deactivating service mode

- ▶ Contact the Security Operating Centre (SOC) before having the vehicle serviced or after the vehicle has been serviced.
- ▶ When your vehicle is being serviced, please inform the relevant employee at the qualified specialist workshop or the Porsche partner that your vehicle is equipped with PVTS.

1. (available in some countries)

i Information

In the case of vehicle equipment PVTS Plus, the Driver Card and driver's key must be handed to Customer Service to ensure that PVTS Plus is deactivated for a service.

Changing the Driver Card battery**WARNING**

Internal chemical burns or death from swallowing the lithium button cell

The Driver Card contains a lithium button cell (battery).

Swallowing the battery can lead to internal chemical burns within two hours and thus to death.

- ▶ Keep children away from removed or new batteries.
- ▶ Keep the Driver Card away from children. Children may open the Driver Card and remove the battery.
- ▶ If the battery has been swallowed or inserted into a bodily orifice, seek medical attention immediately.

If the battery in the Driver Card is too weak, a text message will be sent automatically to the specified mobile phone number. A message appears on the instrument cluster.

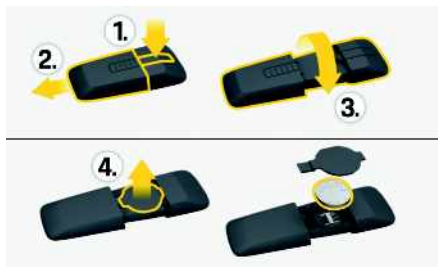

Fig. 156: Changing the PVTS Plus Driver Card battery

1. Remove the Driver Card cover (1.-3.)
2. Carefully open the battery cover on the Driver Card using a suitable tool (e.g. a screwdriver) (4.).
3. Change the battery (check polarity).
4. Close the Driver Card and press it shut firmly. Make sure that the cover on the Driver Card has firmly clicked in place.

Rear lid

General Safety Instructions

⚠ WARNING

Uncontrolled opening or closing of the automatic rear lid

Danger of injury as a result of uncontrolled opening or closing of the automatic rear lid.

- ▶ Open or close the rear lid only when the vehicle is stationary.
- ▶ Open or close the rear lid only when there are no persons or animals within its movement range.
- ▶ Always keep a close eye on the opening and closing operation so that movement can be stopped at any time in the event of danger.

NOTICE

Risk of damage as a result of uncontrolled opening or closing of the rear lid.

- ▶ Make sure there is sufficient clearance behind and above the vehicle (e.g. roof transport systems, garage ceiling).
- ▶ Do not allow a load to protrude over the edge of the luggage compartment.

Interrupting the opening or closing operation in the event of danger

Press one of the following buttons to immediately interrupt the opening or closing operation:

- ▶  button on the driver's key.
 - or –
 - One of the two buttons in the rear lid trim panel.
 - or –

Release button underneath the rear lid at the outside (rear skirt).

– or –

Gesture using your foot.

- ▶ Press the appropriate button to resume one-touch operation.

Opening the tailgate

Opening the tailgate using the release button

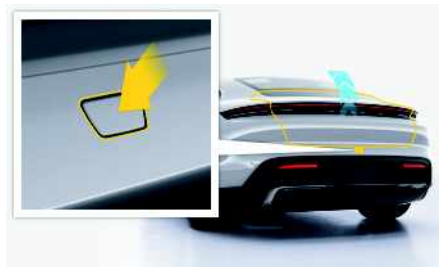

Fig. 157: Tailgate release button

- ✓ Vehicle unlocked (vehicles without Comfort Access).
 - or –
 - ✓ Driver's key is carried (vehicles with Comfort Access).
- ▶ Press the button.
 - All doors on the vehicle are unlocked.
 - The tailgate opens as far as the set opening height.

Opening the tailgate using the centre console control panel or central display

The tailgate can be closed using the flap screen on the centre console control panel or using the central display.

- ✓ Ready for operation.

- ✓ Parking lock and parking brake activated.

Centre console control panel

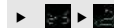

The tailgate opens as far as the set opening height.

Central display

- ▶  ▶ **Setting**  ▶ **Vehicle** ▶ **bonnet, tailgate and charging ports** ▶ **Opening the tailgate**

The tailgate opens as far as the set opening height.

Opening the tailgate with the driver's key

- ✓ Parking lock and parking brake activated.
- ▶ Press the  button on the driver's key.
 - All doors on the vehicle are unlocked.
 - The tailgate opens as far as the set opening height.

Opening the tailgate using foot movement



Fig. 158: Foot gesture control

CAUTION

Unintentional movement of the tailgate

If the sensors in the rear detect persons, movements or objects and a valid driver's key is located at the rear of the vehicle, the rear lid may open or close automatically, causing injury to persons or damage to the vehicle.

To prevent unintentional movement of the rear lid:

- ▶ Deactivating the function in the central display.
- or –
- ▶ Deactivate Comfort Access.

- ✓ Vehicles with Comfort Access.
- ✓ Function activated.
- ✓ Driver's key is carried.
- ✓ The max. distance to the vehicle is approx. 75 cm.

1. Stand in a central position behind the vehicle.
2. Move your foot toward the vehicle and back in one sequence.

The tailgate opens as far as the set opening height.

The function can be activated or deactivated in the central display.

- ▶  ▶ **Setting**  ▶ **Vehicle** ▶ **Vehicle locking systems** ▶ **Tailgate comfort access**

i Information

The foot gesture function may not be available in the following situations:

- The weather conditions are bad (rain, snow or ice).
- The bumper is dirty.
- The driver's key radio signal is interfered with through radio waves.

Adjusting the opening height of the tailgate

The opening height of the tailgate can be adjusted individually.

On vehicles with level control, always adjust the tailgate when the vehicle is at its highest level.

1. Stand behind the vehicle and open the tailgate.
2. Press the button  on the driver's key or in the tailgate trim panel to stop the opening operation.
3. Move the tailgate by hand to the desired opening height.
4. Press button **A** in the tailgate trim panel for approx. 3 seconds.

An acoustic signal confirms the programmed opening height.

Automatic stop in the event of unintentional tailgate movement

If the tailgate lowers unaided immediately after opening, such as due to the weight of snow, an electrical mechanism brakes the tailgate and a series of brief warning signals sound until the tailgate stops moving.

- ▶ Bring the tailgate to rest for approx. 1 second. The automatic stop is disabled.

Closing the rear lid**Closing rear lid using button in rear lid trim panel**

Fig. 159: Buttons in rear lid trim panel

- A** Close rear lid
- B** Close rear lid and lock vehicle

- ▶ Press button **A** in the rear lid trim panel. The rear lid is closed.

Closing and locking rear lid using button in rear lid trim panel

- ✓ Vehicles with Comfort Access.
- ✓ Driver's key is carried.
- ▶ Press button **B** in the rear lid trim panel. The rear lid is closed and the vehicle is locked.

i Information

If the key is inside the vehicle when you lock it, the vehicle is unlocked again. Several warning tones sound and the vehicle flashes 4 times. Only if a door or the tailgate is not opened within approx. 45 seconds is the vehicle locked and can only be unlocked using a second key.

- ▶ Make sure that the driver's key is not left inside the vehicle when locking it.

Closing rear lid using centre console control panel or central display

The rear lid can be closed using the flap view on the centre console control panel or using the central display.

- ✓ Ready for operation.
- ✓ Parking lock and parking brake activated.

Centre console control panel



- ▶ Keep pressing the central display until the rear lid is closed.
A warning signal sounds and the rear lid is closed.

Central display



- ▶ **Setting** ▶ **Vehicle** ▶ **Bonnet, rear lid and charge port door** ▶ **Close rear lid**
- ▶ Keep pressing the central display until the rear lid is closed.
A warning signal sounds and the rear lid is closed.

Closing rear lid using foot gesture



CAUTION

Unintentional movement of the tailgate

If the sensors in the rear detect persons, movements or objects and a valid driver's key is located at the rear of the vehicle, the rear lid may open or close automatically, causing injury to persons or damage to the vehicle.

To prevent unintentional movement of the rear lid:

- ▶ Deactivating the function in the central display.

– or –

- ▶ Deactivate Comfort Access.

- ✓ Vehicles with Comfort Access.
- ✓ Driver's key is carried.
- ✓ The max. distance to the vehicle is approx. 75 cm.

1. Stand in a central position behind the vehicle.
2. Move your foot toward the vehicle and back in one sequence.
The rear lid is closed.

Detection of obstacles during closing

The closing operation is interrupted automatically if closing of the rear lid is blocked by an obstacle.

A warning signal sounds and the rear lid stops moving.

1. Remove the obstruction.
2. Close the rear lid automatically or slowly by hand.

Roof Transport System

Transporting objects on the roof.



WARNING

Unsecured or incorrectly secured roof transport system or individual load-carrying devices

An unsecured or incorrectly secured roof transport system can become detached from the vehicle while driving and cause serious accidents.

- ▶ Install individual load-carrying attachments such as a ski/snowboard holder or roof box as centrally as possible with respect to the supports.
- ▶ Check the roof transport system and load-carrying devices before every trip and at regular intervals during longer trips to ensure that they are fitted correctly and securely.
- ▶ Tighten all fastening screws again.



WARNING

Changed vehicle handling

The handling of the vehicle changes when the roof transport system is fitted and loaded.

- ▶ Adapt your driving style accordingly.
- ▶ Do not drive at a speed of more than 130 km/h (81 mph) when the roof transport system is loaded.
- ▶ When the roof transport system is fitted but not loaded, do not drive at a speed of more than 180 km/h (110 mph).



WARNING

Unsecured or incorrectly secured load

An unsecured or incorrectly secured load can become detached from the roof transport system while

driving and cause serious accidents.

- ▶ Secure the load so that it will not move during the journey.
- ▶ Load the roof transport system so that the load does not protrude over the sides of the roof transport system. Never load the roof transport system wider than the width of the vehicle.
- ▶ Do not use elastic rubber tensioners.
- ▶ Position the centre of gravity of the load as low as possible with respect to the roof transport system and distribute the load evenly over the load area.

NOTICE

Washing the vehicle in a car wash or failure to observe the overall vehicle height or the maximum permitted gross weight can damage the vehicle or roof transport system.

- ▶ Remove the complete roof transport system before washing the vehicle in a car wash.
- ▶ Check the overall vehicle height with the roof transport system fitted before driving through height-restricted entrances (e.g multi-storey car parks).
- ▶ Do not exceed the maximum roof load, maximum vehicle weight and maximum axle loads.



Information

- ▶ If you are not using the roof transport system, remove it completely from the vehicle in order to optimise power consumption and reduce noise.

Various objects can be transported safely and securely using the roof transport system and attachments, e.g. ski/snowboard holder, roof box or bicycle rack.

- ▶ Only use roof transport systems that have been tested and approved by Porsche. Conventional roof rack systems cannot be mounted on the vehicle.

For more information on the roof transport system:

- ▶ Contact your Porsche partner.

Fitting the roof transport system

- ✓ Vehicles with a panoramic solid glass roof.



Fig. 160: Components of the roof transport system

- A Front carrier bar (long)
- B Rear carrier bar (short)
- C Cover trims
- D Torque wrench
- E key
- F Assembly protection
- G Adapter

When fitting for the first time:

- ▶ Adjust the front and rear carriers to fit the width of the vehicle.

NOTICE

Risk of damage to paintwork and/or glass from the carrier foot.

- ▶ Secure the assembly protection to the carrier foot while assembling the carrier.

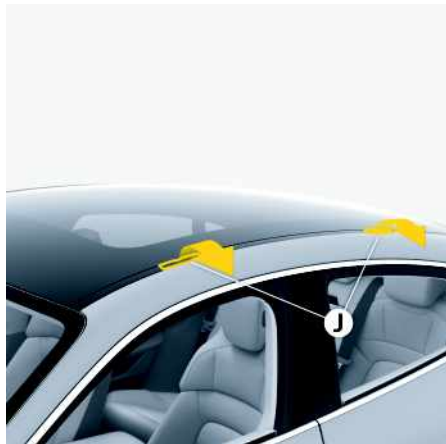

Fig. 161: Open the flaps of the roof trim

1. Open the flaps J of the roof trim.

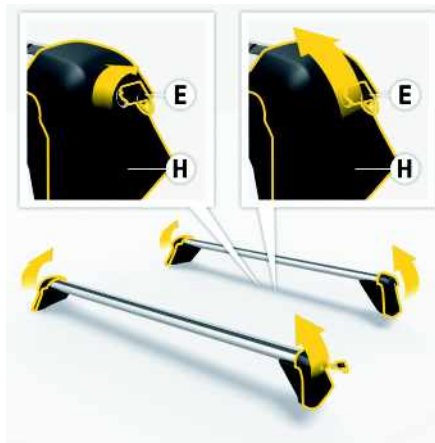

Fig. 162: Locking and folding up the cover flaps

2. Unlock cover flap H with the key E and fold up.

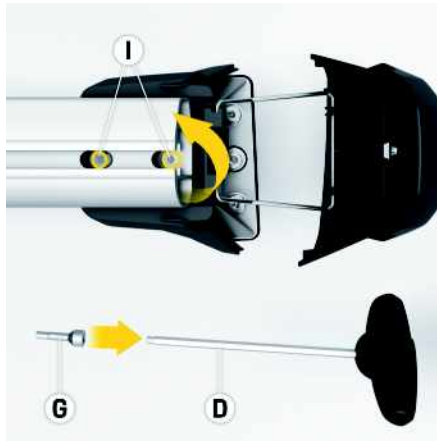

Fig. 163: Loosen adjusting screws.

3. Initial assembly:

- a. Place adapter G on torque wrench D. Loosen adjusting screws I on the two upper sides of the respective carrier using torque wrench D.

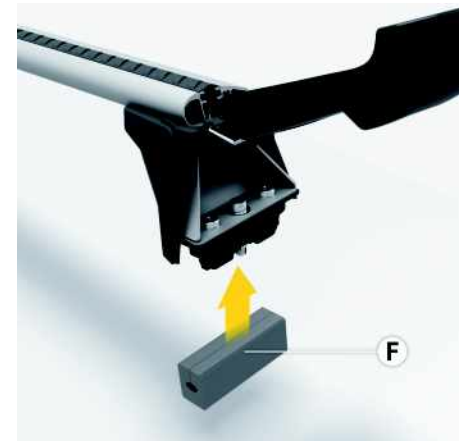

Fig. 164: Affix assembly protection

- b. Secure assembly protection F to the carrier foot on the opposite side.

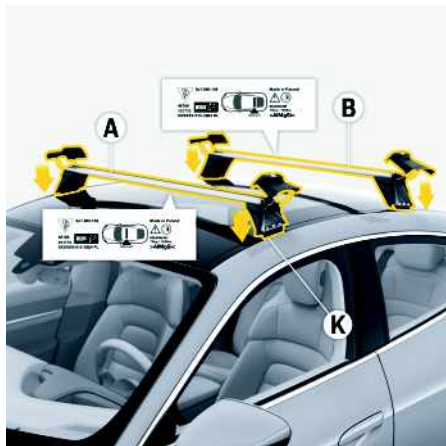

Fig. 165: Placing the carrier on the roof

- c. Place long carrier **A** at the front and short carrier **B** at the rear in the holders on the vehicle **K** and, at the same time, adapt to the vehicle width by means of the adjustable carrier feet.

Ensure that the carriers are fitted in accordance with the stickers on the underside of the carriers.



Fig. 166: Tighten fastening screws.

- d. Screw in all 4 fastening screws on the carriers using torque wrench **D** until flush with the surface, but **do not yet** tighten fully.

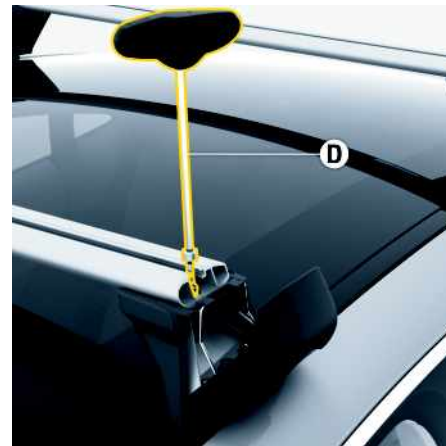

Fig. 167: Tighten adjusting screws.

- e. Tighten the adjusting screws on the tops of the carriers on both sides **slightly**, but do **not yet** tighten them fully. Then tighten the adjusting screws on the top to a torque of 8 Nm using torque wrench **D**. In order to do this, turn torque wrench **D** until you hear a "crack".
Continue with Assembly Step 4.

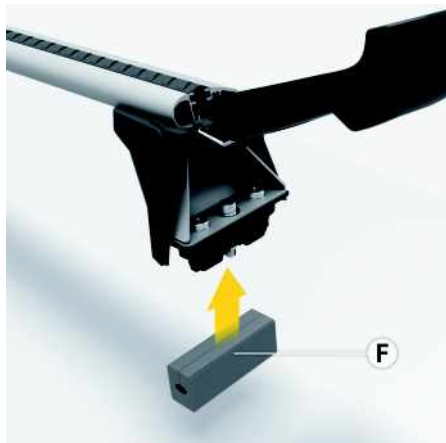

Fig. 168: Affix assembly protection

3. Further assembly:

- a. Secure assembly protection **F** to the carrier foot on the opposite side.

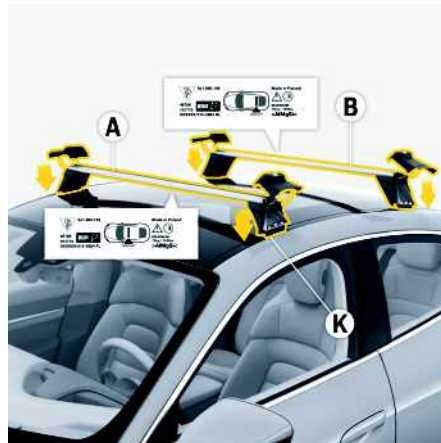

Fig. 169: Placing the carrier on the roof

- b. Place long carrier **A** at the front and short carrier **B** at the rear in the holders on the vehicle **K** located in the recesses on the trims.



Fig. 170: Tighten fastening screws.

4. Screw in all 4 fastening screws on the carriers using torque wrench **D** until flush with the surface. Then tighten all fastening screws to a torque of 8 Nm. In order to do this, turn torque wrench **D** until you hear a "crack".
- ▶ Check carriers to ensure they are sitting correctly and securely on the vehicle

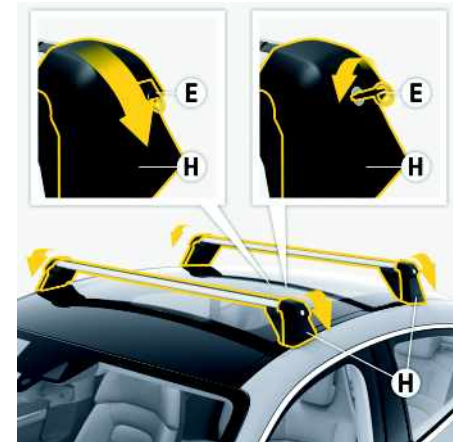

Fig. 171: Fold down the cover flaps and lock

5. Fold cover flaps **H** of the carriers fully downwards and mount the desired load-carrying device (e.g. for roof box, bicycle rack) on the carrier. Then close the cover flaps and lock using key **E**.

A
B
C
D
E
F
G
H
I
J
K
L
M
N
O
P
Q
R
S
T
U
V
W
X
Y
Z



Fig. 172: Cutting the profile trims to size and attaching

6. Cut profile trims **C** to size and push them sideways into the carriers or press them into the carriers from above to protect against moisture and dirt and also to prevent wind noise.

i **Information**

After driving 50 km (30 mls), retighten all screws on the carriers and load-carrying devices.

Fitting mounting components



Fig. 173: Fitting mounting components

1. Unlock cover flaps with the key and fold back.
2. Insert the mounting components into the T-groove provided.
3. Close the cover flaps and lock them with the key.
4. Always read the relevant installation instructions for fitting and securing mounting components.

Closing the profile trim

For protection against moisture and dirt and to prevent wind noise, the T-groove of the profile trim should be closed when the fasteners are not in use.



Fig. 174: Cutting the profile trims to size and attaching

1. Cut the profile trim to the length of the basic carrier.
2. Press the profile trim into the T-groove.

Screenwash

Selecting washer fluid



Fig. 175: Washer fluid reservoir

Note the following points:

- ▶ Mix the water with the appropriate additives (window cleaner concentrate, antifreeze), depending on the season. Always use the right mixture ratio and read all instructions on the containers of the additives used.
- **Summer:** Fill with water and window cleaner concentrate
- **Winter:** Fill with water, antifreeze and window cleaner concentrate

Only use window cleaner concentrate that meets the following requirements:

- Dilutability 1:100
- Phosphate-free
- Suitable for plastic headlight lenses

For information on washer fluid concentrates approved by Porsche: Contact your Porsche partner. If the washer-fluid level is too low, a warning message appears on the instrument cluster.

Adding washer fluid

1. Open the cap on the washer fluid reservoir.
2. Add washer fluid.
 - ▶ Please refer to chapter "Filling capacities" on page 309.
3. Close the cap carefully.

Seat Belts

Using seat belts correctly

DANGER

Unfastened or incorrectly used seat belts

Seat belts do not offer any protection in an accident if they are not worn. Incorrectly worn seat belts increase the risk of injury in an accident.

- ▶ For their own safety, all occupants of the vehicle must wear a seat belt on all trips.
- ▶ Share all the information in this section with your passengers.
- ▶ Never use **one** seat belt for two persons at the same time.
- ▶ Remove any loose or bulky items of clothing that prevent the seat belt from fitting correctly and restrict your freedom of movement.
- ▶ Do not lay the seat belt across hard or breakable objects (glasses, ball-point pens, pipes, etc.). These objects may pose an additional risk of injury.
- ▶ Belt straps must not be twisted or loose.

DANGER

Using damaged seat belts.

Damaged, heavily stressed or worn seat belts do not offer adequate protection in the event of an

accident.

The seat belt pretensioner system can only be triggered once; the system must then be replaced.

- ▶ Check all seat belts regularly for signs of damage to the fabric and check that the seat-belt buckle and attachment points function correctly.
- ▶ Protect seat-belt buckle from soiling and keep it clean.
- ▶ Have seat belts that are damaged or have been heavily stressed in an accident replaced immediately.

The same applies to the seat belt pre-tensioner systems and force limiters installed on the seats that have been triggered.

- ▶ In addition, have the anchor points of the seat belts checked.
- Visit a qualified specialist workshop. Porsche recommends a Porsche partner as they have trained workshop personnel and the necessary parts and tools.
- ▶ Ensure that the seat belts are fully retracted when not in use to protect them from dirt and damage.

- ▶ Please refer to chapter "Cleaning seat belts" on page 67.

Seat-belt pre-tensioners

Triggering of the seat-belt pre-tensioners depends on the severity of the accident.

The seat-belt pre-tensioners can be triggered:

- In front and rear impacts
- In side impacts
- If the vehicle turns over



Information

Smoke is released when the seat-belt pretensioners are triggered. This does not indicate a fire in the vehicle.

Observe the seat belt warning light and warning message



Fig. 176: Seat belt status display in the instrument cluster

- A** Seat belt status display for the left rear seat
- B** Seat belt status display for the centre rear seat (depending on the equipment)
- C** Seat belt status display for the right rear seat
- D** Warning light: driver's or passenger seat belt not fastened

Front seats

When the vehicle is ready for operation, red warning light **D** lights up on the instrument cluster and

stays on until the driver side and occupied passenger side seat belts have been fastened.

A warning symbol is also displayed on the instrument cluster.

When the speed exceeds approx.

24 km/h (15 mph), a warning message sounds and red warning light **D** on the instrument cluster flashes if the driver side or occupied passenger side seat belts are not fastened.

Rear seats

When the vehicle drives off, a seat belt status display for the rear seats appears for about 60 seconds in the instrument cluster.

Green symbol **A + B** indicates that the person sitting in the seat in question has fastened their seat belt.

Red symbol **C** indicates that the person sitting in the seat in question has not fastened their seat belt, or that the seat is empty. If a seat belt on the rear seats is opened while the vehicle is moving, a warning message sounds and the relevant symbol turns red and flashes for about 60 seconds **C**.

Adjusting the seat belt



Fig. 177: Adjusting belt height

The height of the belt outlets for the front seats can be adjusted.

- ▶ Adjust the height of the belt outlet so that the belt runs across the middle of your shoulder, not against your neck.
 - a. Upwards – push belt outlet upwards.
 - b. Downwards – press locking button **A** and move belt outlet downwards.

Fastening seat belt

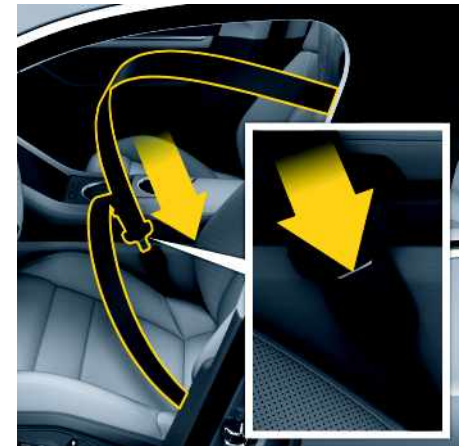

Fig. 178: Fastening seat belt

1. Assume a comfortable sitting position.
2. Adjust the backrest so that the seat belt always rests on your upper body and runs across the middle of your shoulder.
3. Grasp the seat belt latch and pull the belt in a slow, continuous motion across your chest and lap.

i Information

The seat belt may be blocked if the vehicle is standing at an angle or if the seat belt is pulled out abruptly.

The seat belt can also jam when accelerating or decelerating, when negotiating bends or on inclines.

4. Insert the belt latch into the appropriate seat-

- A belt buckle on the inner side of the seat until it locks with an audible click.
5. Make sure that the seat belt is not trapped or twisted and that it is not rubbing against sharp edges.
 6. Ensure that the horizontal section of the belt always fits snugly across the pelvis. Therefore, after fastening the seat belt, always pull the diagonal part of the belt upwards.
Pregnant women: should position the lap belt as low as possible across the pelvis and ensure that it is not pressing against the abdomen.
 7. Also pull on the diagonal section of the belt now and again during the journey to ensure that the horizontal section remains tight.

1. Hold the belt latch.
2. Press the red button on the belt buckle.
3. Guide belt latch to approx. 7 cm (2.75 inches) underneath the belt outlet.
On the front seats and the centre rear seat (depending on the equipment), the belt latch is held in the end position via a stopper button. On the outer rear seats, the belt latch is held in an easily accessible position by a plastic slide (see graphic).
4. Push the plastic slide under the belt latch (see graphic).

Opening seat-belt buckle and removing seat belt

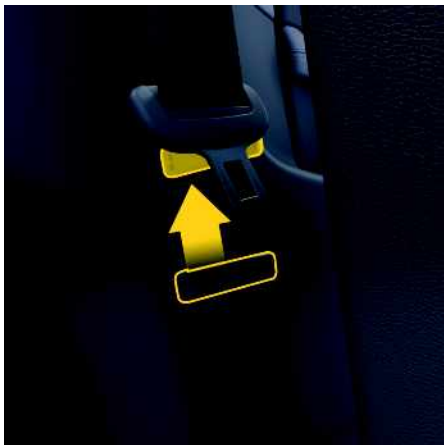

Fig. 179: Removing the seat belt

seats

Choosing the correct seat position

The correct sitting position is important for safe and fatigue-free driving. To adjust the driver seat position to suit individual requirements, proceed as follows:

1. Adjust the seat height to ensure that you have enough headroom and a good overview of the vehicle.
2. Adjust the seat's fore-and-aft position so that your legs are not fully straight and your foot is touching the entire pedal surface when pressing the pedals fully.
3. Grip the top half of the steering wheel. Set the backrest angle and the steering wheel position so that your arms are almost outstretched. Your shoulders must still rest on the backrest, however.
4. Adjust the seat's fore-and-aft position if necessary.

Adjusting the seat



WARNING

Adjusting the seat when driving

The seat may move further than desired if you attempt to adjust it whilst driving. You may lose control of the vehicle.

- ▶ Do not adjust the seat while driving.



CAUTION

Seat adjustment

If persons or animals are within the range of movement of the seat, there is a risk of parts of the body

being squeezed or crushed when you adjust the seat.

- ▶ Adjust the seat so that no-one is put at risk.

NOTICE

Risk of damage to headrests, roof and sun visor.

- ▶ Set the seat position to ensure sufficient clearance between the headrest, roof and sun visor.

Adjusting an electric seat

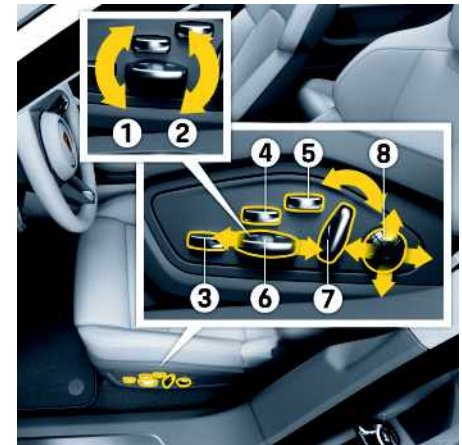

Fig. 180: Adjusting an electric seat

- 1 Seat angle adjustment
- 2 Seat height adjustment
- 3 Thigh support adjustment
- 4 Seat cushion side bolster adjustment (depending on the equipment)
- 5 Seat backrest side bolster adjustment (depending on the equipment)
- 6 Fore-and-aft adjustment
- 7 Backrest angle adjustment
- 8 Lumbar support adjustment

- ▶ Press each control in the direction indicated by the arrows until the desired setting or the end position is reached.

Storing seat settings

For information on storing and retrieving the seat settings:

- ▶ Please refer to chapter "Personal settings" on page 180.

A Using the Comfort Entry function

The Comfort Entry function makes it easier for you to get in and out of the vehicle.

B CAUTION

Automatic adjustment of driver's seat

Persons behind the driver's seat may be trapped by the seat as a result of automatic adjustment of the driver's seat towards the rear.

- ▶ Switch off the Easy Entry function if there is a person behind the driver's seat.

C Activating function

The Comfort Entry function can be activated in the central display.

- ▶ ▶ **Comfort** ▶ **Comfort Entry**

- ▶ Please refer to chapter "Vehicle settings" on page 257.

D Exiting the vehicle

- ✓ Function activated.
- ▶ Press the power button, switch off the vehicle **and** open the driver's door.
The steering wheel moves upwards.
The driver's seat moves backwards.

E Entering the vehicle

- ✓ Function activated.
- ✓ Driver's seat and steering wheel are in their Comfort Entry positions.
- ▶ Close the driver's door, press the power button and switch on the vehicle.
The driver's seat and steering wheel move to the stored position.

F Information

When the key is changed, the seat and steering wheel move to the entry position stored on the driver's key.

G Information

Manual intervention in the seat setting interrupts the Comfort Entry function.

- ▶ Adjust driving position manually.

H Switching seat heating/seat ventilation on and off

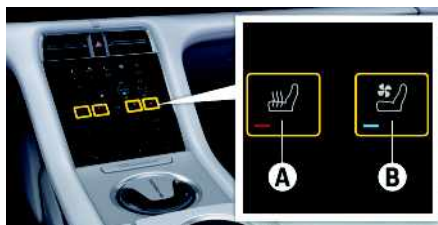

Fig. 181: Switching seat heating / seat ventilation on and off

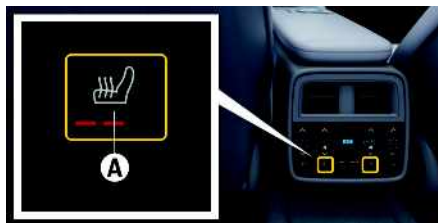

Fig. 182: Switching rear seat heating on and off

I Switching on seat heating/seat ventilation

- ✓ Vehicle ready for operation

- ▶ Tap softkey **A** (seat heating) or **B** (seat ventilation) — repeatedly, if necessary.
The number of illuminated indicator lights shows the selected heating or ventilation setting.

J Switching off seat heating/seat ventilation

- ▶ Tap softkey **A** (seat heating) or **B** (seat ventilation) — repeatedly, if necessary — until all pilot lights go out.

K Information

Seat heating is not available when the interior temperature is high.

Seat ventilation is not available when the interior temperature is below 15 °C.

If the battery voltage is too low, seat heating/seat ventilation is restricted initially and then switched off.

L Setting front seat heating / seat ventilation

For the front seat heating and seat ventilation, the balance between the seat surface and backrest can be set via the central display.

1. ▶ **Comfort** ▶ **Driver seat/Passenger seat** ▶ **Seat heating balance/Seat ventilation balance**
2. Set balance.

M Setting rear seat heating

For the rear seat heating, the balance between the seat surface and backrest can be set via the rear display.

1. ▶ **Seat heating balance left/Seat heating balance right**
2. Set balance.



Using the front seat massage function (depending on the equipment)

Switching the massage function on

- ✓ Vehicle ready for operation
- ▶ Press the **8** (Fig. 180) button on the corresponding seat.

The massage function is switched on.

A menu for selecting the massage programme is displayed briefly on the central display.

- ▶ Touch the  icon to select the massage strength.
- ▶ Touch the  icon to switch the massage function on or off.

The massage function switches off automatically after 10 minutes.

Configuring the massage programme on the central display

- ✓ Vehicle ready for operation.

1.  ▶ **Comfort ▶ Driver seat/Passenger seat ▶ Massage programme**
2. Select the desired massage programme.

Setting the massage strength on the central display

- ✓ Vehicle ready for operation.
- ✓ Massage programme selected.

1.  ▶ **Comfort ▶ Driver seat/Passenger seat ▶ Massage strength**
2. Select the desired massage strength.

Adjusting passenger seat from the driver's seat

1.  ▶ **Comfort ▶ Adjust the passenger seat**
2. Set the passenger seat position using the controls on the driver's seat.

To end the adjustment:

- ▶ Select **Cancel seat adjustment**.

Adjusting headrests

Adjusting headrests on front seats

The fore-and-aft position of the headrests on the front seats can be adjusted.

- ▶ Always make sure that the headrest is engaged correctly.



Fig. 183: Adjusting the fore-and-aft position of headrests on front seats

Forwards

- ▶ Press button **A** and at the same time pull the headrest forwards with both hands until the desired setting is reached.

Backwards

- ▶ Press button **A** and at the same time push the headrest backwards with both hands until the desired setting is reached.

Adjusting headrests on rear seats



WARNING

Headrest on occupied centre rear seat in storage position

Driving with headrests not adjusted correctly increases the risk of serious injury.

- ▶ If the centre rear seat is occupied, move the headrest out of its storage position and adjust it to one of the higher, detent positions.

The height of the headrests on the rear seats can be adjusted.

- ▶ Adjust the height of the relevant headrest so that the upper edge of the headrest is at eye level. If eye level cannot be reached, the topmost position of the headrest is to be selected.
- ▶ Always make sure that the headrest is engaged correctly.



Fig. 184: Setting the height of the headrests on the rear seats (example: 3 rear seats)

Raising

- ▶ Push headrest upwards until the desired setting is reached.

Lowering

- ▶ Press button **A** and at the same time push the headrest downwards until the desired setting is reached.

To improve your view to the rear, the headrest on the centre rear seat can be moved to a storage position that is lower than the lowest usable position.

Removing and installing headrests on rear seats

The headrests on the rear seats may have to be removed in order to install a child restraint system correctly.

- ▶ Please refer to chapter "Child Restraint Systems (Child Seats)" on page 87.

⚠ WARNING

Headrests on rear seats removed or not adjusted correctly

Driving with headrests removed or not adjusted correctly increases the risk of serious injury.

- ▶ If the rear seats are occupied, install the relevant headrests.
- ▶ Adjust the height of each headrest so that the upper edge of the headrest is at least at eye level or the headrest has engaged in the topmost detent.
- ▶ Always make sure that the relevant headrest is engaged correctly.



Fig. 185: Removing and installing headrests on rear seats

Removing

1. Push headrest up as far as it will go.
2. Fold the rear seat backrest roughly half-way forward.
3. Press buttons **A** and **B** and at the same time push the headrest up until button **B** remains engaged.
4. Remove the headrest and stow safely in the vehicle.
5. Fold up and engage the rear seat backrest if necessary.

⚠ WARNING

Swapping headrests

The individual headrests are designed specifically for use on the respective seats. If headrests are not fitted on the correct seats during re-installation, the risk of serious injury is increased.

- ▶ Ensure that the headrests are not interchanged during re-installation.

Installing

1. Fold the rear seat backrest roughly half-way forward.
2. Insert headrest into the guides and push it down until it engages with an audible click.
3. Press button **A** and push the headrest down fully. It should no longer be possible to pull the headrest out of the backrest.
4. Fold up and engage the rear seat backrest.

Folding the rear seat backrest forward

The rear seat backrests can be folded forward individually to make the luggage compartment larger.

NOTICE

Risk of damage from objects on the rear seats.

- ▶ Do not place objects on the seats when folding the backrests forward.

i Information

The backrests on the left and centre rear seats are joined together. When you fold the left backrest forward, the centre backrest will also fold over. The centre rear-seat backrest can also be folded forward separately (depending on fittings).

Folding outer rear seat backrests forward

Fig. 186: Folding outer rear seat backrests forward

1. Push the headrests down.

- ▶ Please refer to chapter "Adjusting headrests" on page 225.

2. Push the release button **A** and fold the backrest forwards.

Folding the backrest on the centre rear seat forward

Fig. 187: Folding the backrest on the centre rear seat forward

- ✓ Vehicles with 3 rear seats
- ▶ Actuate release handle **A** in direction of arrow and fold the backrest forward.

Returning rear seat backrests to the upright position**WARNING**

Seat backrest not engaged correctly

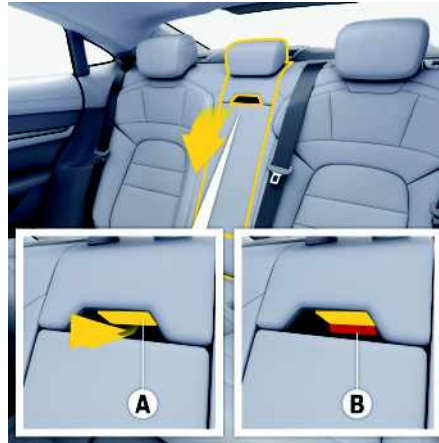
If the rear seat backrests are not engaged correctly, they can fold forwards unintentionally while the

vehicle is moving.

If the red marking **B** is still visible, the seat backrest is not engaged correctly.

- ▶ Make sure that the red marking **B** is no longer visible after the seat backrest has engaged.
- ▶ Release the seat backrest and engage it again if necessary.
- ▶ Fold up the backrest until it locks with an audible click. Make sure that the seat belts are not trapped.

Smoker's Package

Using the ashtray



WARNING

Fire hazard from flammable objects

Paper in the ashtray can catch fire.

- ▶ Do not put any flammable objects into the ashtray.

Inserting ashtray

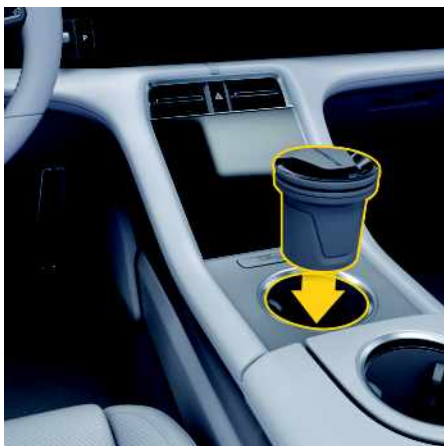

Fig. 188: Inserting ashtray

Depending on the equipment, an ashtray is available in the cupholder in the centre console.

- ▶ Please refer to chapter "cupholder" on page 100.
- ▶ Insert the ashtray in the cupholder and press down as far as it will go.

Opening and closing the ashtray



Fig. 189: Opening and closing the ashtray

- ▶ Open and close the ashtray by lifting and folding down the lid.

Removing the ashtray

- ▶ Grip the ashtray and remove it.

Socket

Using the 12-volt socket

Electrical accessories can be connected to the 12-volt plug socket.

The 12-volt plug sockets are located in the storage compartment in the front armrest and in the rear luggage compartment on the right in the direction of travel.

Connecting the charging adapter

i Information

- The 12 V plug socket and the connected electrical accessories function even if the vehicle is switched off. The power supply is interrupted after a maximum of 30 minutes to protect the vehicle battery. To turn on the load again, the power button must be pushed and the vehicle switched on.
- The maximum load capacity of a 12-volt plug socket is 20 A but only if one load is operating. Do not exceed a 10 A load per 12-volt plug socket if several loads are operating simultaneously.
- Unshielded devices and equipment can cause interference to radio reception and malfunctions in the vehicle electronics.

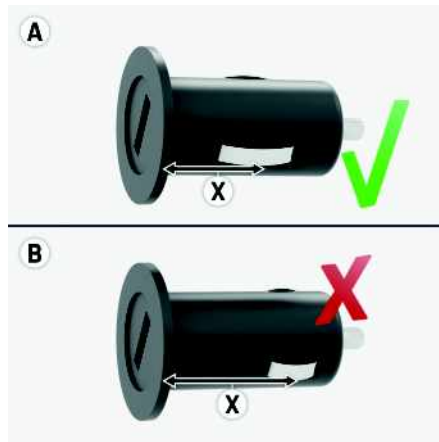

Fig. 190: Charging adapter for 12-volt plug sockets

- A** Suitable charging adapters
B Unsuitable charging adapters

NOTICE

Risk of damage to the electrical system.

- ▶ Only use suitable charging adapters (**A**):
 The **distance X** between the ground connection and the upper edge of the charging adapter must be **less than approx. 16 mm**.
- ▶ Unsuitable charging adapters (**B**) where the **distance X** between the earth connection and the upper edge is more than 16 mm can damage the 12-volt plug sockets.

Speed Limiter (LIM)

General Safety Instructions

WARNING

Lack of attention

The increased comfort offered by the system should not induce you to risk your safety. The driver remains responsible when driving, e.g. keeping a safe distance or driving at an appropriate speed, even when the system is activated. The system cannot replace the driver's attentiveness.

- ▶ Drive with extreme care.
- ▶ If the system-related deceleration is insufficient, slow the vehicle down immediately using the footbrake.
- ▶ Make sure that it is possible to take over control of the vehicle at all times.

Responding to warning messages

Always heed any warning and information messages displayed in the vehicle.

- ▷ Please refer to chapter "Warning and information messages" on page 271.

System limitations

WARNING

Restricted availability of the system

The assistance provided by the adaptive speed limiter cannot be guaranteed in certain situations.

Such situations include:

- poor weather conditions (e.g. snow or ice)
- unfavourable road conditions (including pot holes, dirty road surfaces, ruts, unclear road markings, loose gravel)

- areas with high volumes of traffic
- unsafe traffic situations (driving on motorway exits, accelerating briefly)
- a vehicle position that cannot be clearly detected by the system
- covered or damaged traffic signs
- damaged or covered front camera lens
- out-of-date navigation data

Possible consequences:

- The speed limit is not detected or adopted correctly.
- The vehicle drives at the set maximum speed.
- An information message is displayed on the instrument cluster.
- ▶ Do not use the adaptive speed limiter in such situations.

Operating principle

The speed limiter (LIM) helps you to stay below a certain speed you set yourself.

Adaptive speed limiter (depending on the country)

The adaptive speed limiter uses navigation and camera data (traffic sign recognition) to automatically detect the speed limit within the system limits and changes the maximum speed accordingly. Speed limits detected in advance are displayed on the instrument cluster, and the speed of the vehicle is reduced in good time. If a speed limit is not detected in advance, the speed will not be reduced until the vehicle is driving past the detected traffic sign.



Information

When using navigation with active route guidance, the adaptive speed limiter always adapts to the proposed route. If route guidance is not active, it adapts to the most plausible route.

Controls







Fig. 191: Control stalk for driver assistance systems

- R Switch systems on/off and open options menu
- S Open options menu (when system is switched on)
- 1 Set/increase speed limit
- 2 Reduce speed limit
- 3 RESUME: Resume control, adopt speed
- 4 CANCEL: Interrupt control

Display elements

Status display symbols

Symbol	Meaning
	Speed limiter is passive.
	Speed limiter is passive with a set maximum speed.
	Speed limiter is active with a set maximum speed.
	Speed limiter is active and a speed limit has been detected ahead. As soon as the vehicle reaches the start of the speed limit zone, the colour of the displayed speed changes from blue to green.

Activating and deactivating the speed limiter

The system that was selected last is always switched on. The system is initially in passive mode when switched on. It must first be activated before the control function starts working.

Switching on the speed limiter

✓ No driver assistance system has been switched on yet.

1. Press button **R** on the control stalk.

The options menu for the driver assistance systems appears on the instrument cluster.

2. If LIM is not already selected, select **LIM** using the rotary knob on the steering wheel and press to confirm.

Speed limiter is on and **passive**.

Switching from an already activated driver assistance system to the speed limiter

1. Press button **S** on the control stalk.

The options menu for the driver assistance systems appears on the instrument cluster.

2. Select **LIM** using the rotary knob on the steering wheel and press to confirm.

Speed limiter is on and **passive**.

The operating status appears grey in the status display. If the adaptive speed limiter is active, the currently detected speed limit is also displayed in grey.

Information

The last selected driver assistance system is retained even after switching it off and operational readiness is restored.

Deactivating the speed limiter

- ▶ Press button **R** on the control stalk.

The set desired maximum speed is deleted.

Information

If the speed limiter is deactivated automatically due to a system fault, it is only deactivated completely when the accelerator pedal is released or when the system is switched off by pressing the **R** button.

Activating the speed limiter

Setting current driving speed as the maximum speed

- ▶ Briefly press the control stalk forwards (position 1).

The speed limiter is **active**.

The current driving speed is set as the maximum speed and appears green in the status display.

Setting the detected speed limit as the maximum speed

✓ The adaptive speed limiter is activated

- ▶ Press the control stalk up (**RESUME**).

The speed limiter is **active**.

The detected speed limit is set as the maximum speed and is displayed in the status display.

Changing the maximum speed

The set maximum speed or the detected speed limit can be changed by pressing the control stalk.

✓ Speed limiter active.

Increasing the speed

- ▶ Push the control stalk forward (position 1):
 - Brief press = 1 km/h (1 mph) increments
 - Press and hold = 10 km/h (6 mph) increments

Reduce speed

- ▶ Pull the control stalk (position 2):
 - Brief pull = 1 km/h (1 mph) increments
 - Pull and hold = 10 km/h (6 mph) increments

If the adaptive speed limiter is active, the \pm symbol will appear next to the maximum speed.

Interrupting and resuming the speed limiter

Interrupting causes the system to switch to passive standby mode and remain in standby until it is activated again manually.

Interrupting control

- ▶ Press the control stalk downwards (**CANCEL**). Speed limiter is passive. The maximum speed set or the speed limit detected before interrupting is displayed in grey.

Resuming control

The driving speed is lower than the set maximum speed.

- ▶ Press the control stalk up (**RESUME**). The speed limiter is active. The set maximum speed or speed limit set before interrupting is resumed.

The driving speed is higher than the set maximum speed.

- ▶ Press the control stalk up twice (**RESUME**). The speed limiter is active. The vehicle brakes to the maximum speed or speed limit set before interrupting.

Information

If a different driver assistance system is selected, the speed limiter is interrupted. The previously set maximum speed is retained and will be resumed when the speed limiter is reactivated. If the adaptive speed limiter is active, the currently detected speed limit is adopted.

Overriding the speed limiter temporarily

The speed limiter can be overridden temporarily by initiating a kickdown (pressing the accelerator down fully). This can be useful when overtaking, for example.

- ✓ Speed limiter active.
- ▶ Accelerator pedal pressed down fully. The system is temporarily passive. A warning signal sounds. The speed limiter symbol with the set maximum speed flashes on the instrument cluster.

To resume control:

- ▶ Press the control stalk up (**RESUME**). If the current driving speed is above the set maximum speed, the vehicle is slowed down until the set maximum speed is reached again.
 - or –
 - Take your foot off the accelerator or press the brake pedal to bring the speed of the vehicle to below the displayed maximum speed. The speed limiter is active. The previously set maximum speed or the currently detected speed limit is resumed.

Activating and deactivating the adaptive speed limiter

- ▶  ▶ Assistance ▶  ▶ Assistance system settings ▶ Adaptive Speed Limiter ▶ Consider recognised speed limits

The currently detected speed limit is set as the maximum speed.

Setting the maximum speed

On roads with no speed limit or if no speed limit has been detected, the maximum speed that is set will be used as the top speed.

Setting the maximum speed

- ▶  ▶ Assistance ▶  ▶ Assistance system settings ▶ Adaptive Speed Limiter ▶ Maximalgeschwindigkeit

The set maximum speed remains active until it is reset, even with a change of driver or when the vehicle is restarted.

Using a personal speed limit

The personal speed limits function allows you to set your own speed limit. A warning message appears and a warning signal sounds if the limit is exceeded. One way the function can be used is as a reminder of the maximum speed permitted for the tyre type fitted on the vehicle.

Setting and activating a personal speed limit

Two speed limits can be set, but only one can be activated at any one time.

- ▶  ▶ Speed limit ▶  ▶ Assistance system settings ▶ Personal assistance

Spoiler

General Safety Instructions

⚠ WARNING Failure of the extendible rear spoiler

Driving stability will be adversely affected by increased rear axle lift at higher speeds.

- ▶ Adapt your driving style and speed to the changed driving behaviour.
- ▶ Have the fault corrected at a qualified specialist workshop.

Porsche recommends a Porsche partner as they have trained workshop personnel and the necessary parts and tools.

NOTICE

Risk of damage to rear spoiler.

- ▶ Do not pull or push the vehicle by the rear spoiler.
- ▶ Please retract the rear spoiler before using automatic car washes.

Responding to warning messages

Always heed any warning and information messages displayed in the vehicle.

- ▶ Please refer to chapter "Warning and information messages" on page 271.

Operating principle

The rear spoiler improves driving stability at high speeds. Depending on the vehicle speed and the selected drive mode, the rear spoiler is automatically extended or retracted.

Moving the rear spoiler to cleaning position

⚠ CAUTION Extending and retracting the rear spoiler

When extending or retracting the rear spoiler manually when the vehicle is stationary, parts of the body may become trapped between the moving spoiler and stationary vehicle parts.

- ▶ Make sure that no persons or objects are within the range of movement of the rear spoiler.

The rear spoiler can be moved manually to cleaning position via the central display.

Moving the rear spoiler to cleaning position

- ✓ Ready for operation
- ✓ Parking lock and parking brake activated.

▶  ▶ **Setting**  ▶ **Vehicle** ▶ **Spoiler manual cleaning position**

A
B
C
D
E
F
G
H
I
J
K
L
M
N
O
P
Q
R
S
T
U
V
W
X
Y
Z

Sport Chrono Stopwatch

The Sport Chrono Stopwatch can be used to stop, evaluate and display times on the instrument cluster. The following information can be recorded and evaluated:

- Lap number
- Completed lap distance
- Lap time
- Optional: Various other data (such as vehicle position or speed)

During a recording the following can be displayed:

- Number of the current lap
- Fastest lap time and the current lap time in colour comparison
- How much of the lap has been completed in relation to a reference lap
- Colour rating to indicate whether the current lap time is quicker than, slower than or identical to the current fastest lap or selected lap
- Remaining recording time

Up to 10 hours can be recorded and displayed.

Stopwatch on the dashboard



Fig. 192: Sport Chrono stopwatch

The total time is displayed in the stopwatch on the dashboard.

The analogue pointer indicates the seconds. The digital display shows 1/100 second up to the first minute. Subsequently, the display is in second steps.

Setting the time display and illumination of the stopwatch on the dashboard

- ▶ Please refer to chapter "Vehicle settings" on page 257.

Stopwatch in the instrument cluster

The stopwatch is displayed on the Car & Info display.

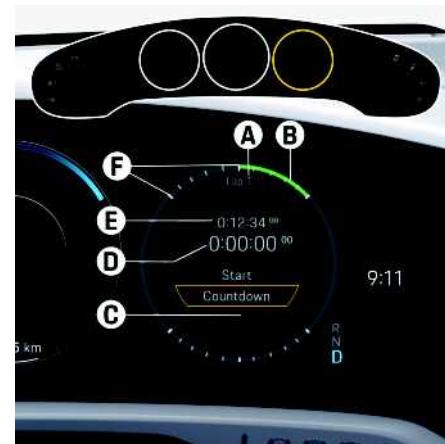

Fig. 193: Stopwatch in the instrument cluster

- A** Lap counter
- B** Circle diagram: how much of the lap has been completed compared to a reference lap.
- C** Control commands
- D** Current lap time
- E** Lap time reference lap
- F** Selected interim time

Starting timing

- ▶ **Sport Chrono ▶ Start**
Data recording begins. If a reference lap has not been loaded, the first lap is used as the reference lap.

Stopping timing

- ✓ Timing has started.

- ▶ **Sport Chrono ▶ Stop**

Continuing timing

✓ Timing was stopped.

▶ **Sport Chrono ▶ Continue**

Stopping lap/starting new lap

The current stopwatch time is stored as a lap time while the stopwatch is still running.

✓ Timing has started.

▶ **Sport Chrono ▶ Lap**

The lap counter **A** is incremented by one lap.
The time of the fastest completed lap is stored as the fastest lap time.

Storing interim time

✓ Timing has started.

▶ **Sport Chrono ▶ Interim time**

The intermediate time is displayed briefly and is not stored. Timing continues in the background.
The **F** area in the circle diagram shows every set interim time.

Resetting the stopwatch time

✓ Timing was stopped.

▶ **Sport Chrono ▶ Reset**

All stopwatch time displays are reset to zero.

A
B
C
D
E
F
G
H
I
J
K
L
M
N
O
P
Q
R
S
T
U
V
W
X
Y
Z

Starting, driving and stopping the vehicle

General Safety Instructions



WARNING

Reduced driving noise with electric vehicles

Even when E-Sound is switched on in accordance with legal requirements, an electric vehicle produces very little driving noise, which means that other road users might not even hear it. There is therefore a risk of accidents, particularly in areas with traffic calming, while manoeuvring or parking.

- ▶ Be particularly attentive while driving!

Operating principle

A distinction is made between readiness for operation (standby) and readiness to drive. Both are activated separately.

Readiness for operation

When you get into the vehicle, the key you have with you is detected by the vehicle and **readiness for operation** is established automatically. Some electrical equipment and electronic systems, such as the central display, are available.

- ▶ To save the battery, only leave the vehicle in standby (ready for operation) and only use the active electrical equipment for as long as is absolutely necessary.

Readiness to drive

The vehicle is **ready to drive** when drive position **D**, **N** or **R** is engaged. The vehicle is now ready to drive and can be moved.

Drive positions



Fig. 194: Drive position display

The following drive positions are available:

D — Drive

Drive position **D** for driving forwards.

R — Reverse gear

Drive position **R** for driving in reverse.

Only engage while the vehicle is stationary and the brake is applied.

N — Neutral

Drive position **N** must be engaged while the vehicle is being transported or in car washes, for example.

P — Park

Drive position **P** for securing the vehicle.

Drive positions **D**, **R** and **N** are selected using the selector lever to the right of the steering wheel, while drive position **P** is selected by pressing the **P** button.

Starting and driving the vehicle

Establishing readiness for operation

- ✓ High-voltage battery is sufficiently charged.
- ✓ Disconnect the vehicle plug from the vehicle charge port.
- ✓ Driver's key in passenger compartment.

Automatically

- ▶ Get in and shut the driver's door. Driver's key is detected in the passenger compartment. Ready for operation.

Manually

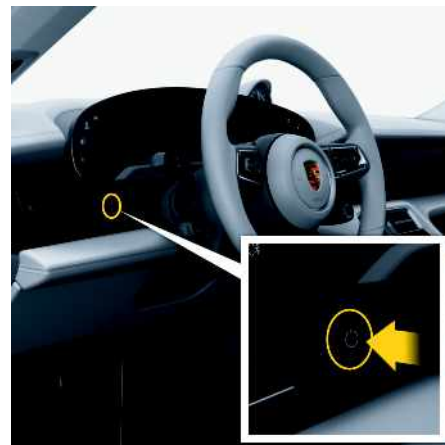

Fig. 195: Power button

- ✓ Readiness for operation switched off.
- ▶ Press the Power button. Driver's key is detected in the passenger compartment. Ready for operation.

Establishing readiness for operation and driving off

- ✓ Ready for operation.
 - ✓ Vehicle plug removed from the charge port, charge port door closed and charging cable safely stowed.
1. Press the brake pedal.
 2. Select transmission range **D** or **R** with the selector lever.
The parking lock and the electric parking brake are deactivated automatically.
 3. To drive off, release the brake pedal and slowly press the accelerator pedal.

The range depends on, among other things, the driving style, the climatic conditions, the use of energy-intensive loads and the selected vehicle settings, e.g. driving mode.

i Information

The readiness for operation is switched off in the following situations:

- with corresponding settings in the energy management system
- if the vehicle was locked from outside
- by opening the driver's door and the driver's seat belt in drive positions **D** or **R**
- by pressing the **P** button
- by other systems that, for example, automatically activate drive position **P** or request the activation of **P** if there is an error

Driving off at high acceleration (Launch Control)

⚠ WARNING

Driving off at high acceleration

When driving off at high acceleration, you may lose control of the vehicle or endanger other road users under certain circumstances (poor road conditions, lack of attention, etc.).

- ▶ Only drive off at high acceleration on public roads if the road and traffic conditions permit.
- ▶ Do not endanger other road users when driving off at high acceleration.

The vehicle already permits you to drive off at an extremely high rate of acceleration in normal driving mode. Maximum acceleration from a standstill is achieved using Launch Control, however.

Driving off with Launch Control

- ✓ Vehicle is at a standstill.
 - ✓ Readiness for operation established.
 - ✓ Steering wheel is not turned.
 - ✓ Drive position **D** selected.
 - ✓ Driving mode **SPORT** or **SPORT PLUS** activated.
1. Press the brake pedal with your left foot.
 2. Quickly press down the accelerator fully and hold it down.
A message appears on the instrument cluster.
 3. Release the brake pedal within a short space of time.

Vehicle accelerates to the maximum.

i Information

Stress on components increases dramatically when starting with maximum acceleration in comparison with normal driving off.

Energy recovery (recuperation)

⚠ WARNING

Unsuitable use of recuperation

Recuperation is a system that is used only for energy recovery. It is not a driver assistance system and cannot take over any driver assistance system tasks.

- ▶ Do not use the deceleration effect of recuperation as a distance control system.
- ▶ Always be ready to brake and stay a safe distance away from the vehicle in front.
- ▶ For greater braking power or for braking the vehicle to a standstill, press the brake pedal as required.

⚠ WARNING

Automatic overrun recuperation limited or not available

The maximum overrun recuperation is limited.

The detection capability of the sensors can be impaired by soiling, bad weather conditions (rain, snow, ice, fog, spray) and unfavourable road conditions (stone chippings, reflective objects). Vehicles up ahead may not be adequately detected, or may not be detected at all.

If automatic overrun recuperation (**Auto** setting) is not available, e.g. if sensors are dirty, a message to this effect will appear in the instrument cluster.

- ▶ Do not use automatic overrun recuperation in conditions of poor visibility and bad road conditions.

Operating principle



During recuperation, the drive converts most of the kinetic energy into electrical energy, which is stored in the high-voltage battery. A distinction is made

between overrun recuperation and braking recuperation:

- **Overrun recuperation** starts as soon as you take your foot off the accelerator pedal and slows down the vehicle. You can configure the overrun recuperation strength.
- When you press the brake, **braking recuperation** increases the amount of recuperated energy to a maximum. A higher braking request is then achieved using the vehicle's wheel brakes.

Overrun recuperation settings

The following overrun recuperation settings can be selected:

Setting	Display	Meaning
Off	No display	No overrun recuperation. Vehicle coasting.
On		Overrun recuperation with moderate deceleration of the vehicle.
Auto		Variable adaptation of overrun recuperation based on data relating to the area around the vehicle.

Information

The deceleration effect of overrun recuperation can be limited if the charge state of the high-voltage battery is high, for example.

- ▶ Compensate for reduced overrun recuperation by pressing the brake if necessary. The overrun recuperation strength is displayed in the power meter.

Selecting overrun recuperation level

- ▶ Press the recuperation button on the steering wheel:
 - Quick press = Switch overrun recuperation on and off
 - Press and hold = Switch automatic overrun recuperation (Auto) on and off

– or –

▶ Drive ▶ Recuperation (accelerator pedal)

The selected setting is shown on the instrument cluster.

Information

Automatic overrun recuperation is only available when PSM is active. Automatic overrun recuperation is not available in "PSM SPORT" mode.

Information

The various overrun recuperation settings are assigned to the driving modes, but can also be freely selected by the driver.

Personalisation is possible in the INDIVIDUAL driving mode.

Driving in coasting mode

"Coasting" is the term used to describe driving without the braking effect of overrun recuperation. This function is designed to increase efficiency by reducing power consumption and increasing the range. Coasting occurs after the accelerator pedal is fully released slowly. Coasting ends when the accelerator pedal is pressed.

- ✓ Driving in transmission range D.
- ✓ PSM is active.
- ✓ No severe uphill or downhill gradients.
- ✓ Recuperation is switched off.
- ▶ Slowly remove your foot from the accelerator pedal.

Information

Coasting mode is also possible in "SPORT" and "SPORT PLUS" driving modes. The overrun recuperation setting that is activated as standard for these driving modes must be switched off when selecting these modes.

Stop, park and exit the vehicle

WARNING

Inactive power steering and brake booster

The power steering and brake booster are only effective when the vehicle is ready for operation. If the vehicle is not ready for operation, much greater force is required to turn the steering wheel or brake.

- ▶ Only turn the vehicle off when it is stationary.

⚠ WARNING

Danger of the vehicle rolling away

In the following situations, the parking brake is not active and the vehicle may roll away.

- Leaving the vehicle with the **N** drive position engaged.
- If the driver door is opened and the driver's seat belt is unfastened, the parking brake is deactivated when the brake pedal is applied and the **D** or **R** drive position is selected again.

This can result in injury and damage to the vehicle. A warning about the danger of the vehicle rolling away is displayed on the instrument cluster.

- ▶ Before leaving the vehicle, activate the parking brake by pressing the **P** button.

Stopping the vehicle

- ▶ For a brief stop (e.g. at traffic lights), leave the selector lever in the **D** drive position and hold the vehicle with the brake pedal.
- ▶ The HOLD function actively holds the vehicle automatically at a standstill after braking to a stop on an incline.

Parking the vehicle

Selecting the **P** drive position secures the vehicle against rolling away.

Activating the P drive position manually

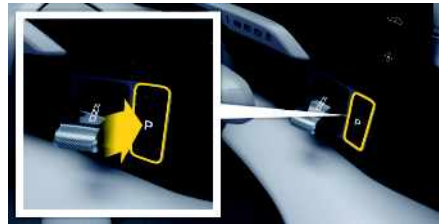

Fig. 196: Parking lock and electric parking brake button

- ✓ Hold the vehicle still by pressing the brake pedal.
- ▶ Press the **P** button.
The parking lock and the electric parking brake are activated simultaneously.
The brake warning light (ⓘ) and the **P** drive position display light up on the instrument cluster

Activating the P drive position automatically

- ✓ Hold the vehicle in place by pressing the brake pedal.
- ✓ **D** or **R** drive position selected.
- ▶ Open the driver's door and driver side seat belt.
The parking lock and the electric parking brake are activated automatically.
The brake warning light (ⓘ) and the **P** drive position display light up on the instrument cluster
– or –
- ▶ Turn off the vehicle using the power button.
The parking lock is activated automatically.
The **P** drive position display lights up on the instrument cluster.
The parking brake is also activated when parking the vehicle on inclines and gradients of over 8%.
The brake warning light (ⓘ) lights up.

⚠ WARNING

Electric parking brake is deactivated

If the vehicle is turned off using the power button on an incline or gradient, the electric parking brake may not be activated (e.g. in the case of a slight incline or gradient). The vehicle can roll away.

- ▶ Always press the **P** button to activate the parking brake on inclines and gradients before turning off the vehicle.

Activating and deactivating the electric parking brake manually.

The electric parking brake can be activated or deactivated on the central display independently of the **P** drive position.

- ▶ ▶ **Setting** ▶ **Vehicle** ▶ **Electric parking brake**

The brake warning light (ⓘ) lights up or goes out.

Responding to warning messages

The brake warning light (ⓘ) flashes if the electric parking brake has not been applied fully in a stationary vehicle.

If it was not possible to activate the parking lock, a warning appears in the instrument cluster.

Always heed any warning and information messages displayed in the vehicle.

- ▶ Please refer to chapter "Warn- und Information-smeldungen" on page 271.

Turn off the vehicle and get out.

- ✓ Parking lock and parking brake activated.
- ▶ Exit and lock the vehicle.
The vehicle is turned off.

i Information

If you do not exit the vehicle, the vehicle may also be turned off by pressing and holding the power button (approx. 1 second).

i Information

The vehicle is turned off automatically in the following situations:

- after 30 minutes
 - Battery charge level below minimum limit
-

Additional information

Leaving the vehicle in drive position N

In drive position **N**, driving readiness is switched off after 30 seconds in the following situations:

- Parking brake is not activated
- Driver's door is opened and driver's seat belt is not fastened
- Brake pedal is not pressed

S

steering wheel

Adjusting steering wheel



WARNING

Adjusting the steering wheel while driving

The steering wheel may move further than desired if you attempt to adjust it while driving. You may lose control of the vehicle.

- ▶ Do not adjust the steering wheel while driving.

Adjusting steering wheel manually



Fig. 197: Steering wheel adjustment lever

1. Swivel the lever downwards, away from the driver.
2. Move the steering wheel vertically and horizontally in order to adjust the steering wheel

position to the tilt of the backrest and seat position.

3. Swivel the lever back to the initial position, towards the driver until you feel it engage.

Adjusting the steering wheel electrically



CAUTION

Uncontrolled retrieval of the memory settings

If persons or animals are within the range of movement of the steering wheel while it is being adjusted, there is a risk of body parts being trapped or crushed.

- ▶ Do not leave children in the vehicle unattended.



Fig. 198: Steering wheel adjustment control switch

- ▶ Move the control switch under the steering column in the relevant direction until the desired setting is reached.

Storing steering wheel settings

On vehicles with memory package, the steering wheel settings can be stored on the memory buttons in the driver door and on the driver's key.

- ▶ Please refer to chapter "Personal settings" on page 180.

Operating instrument cluster with multi-function steering wheel

For further information on operating the instrument cluster:

- ▶ Please refer to chapter "Operating the instrument cluster" on page 129.

Switching steering wheel heating on/off



Fig. 199: Heated steering wheel button

- ✓ Ready for operation.
- ▶ Press the button on the central steering wheel spoke until the message **Steering wheel heating**

A or **Steering wheel heating** appears briefly on the instrument cluster.

B

C

D

E

F

G

H

I

J

K

L

M

N

O

P

Q

R

S

T

U

V

W

X

Y

Z

Storage

Stowing objects



WARNING

Unsecured or incorrectly positioned objects

An unsecured or incorrectly positioned load can slide or be thrown about and injure the vehicle occupants as a result of hard braking, direction changes or an accident.

- ▶ Only use the storage options described in these instructions.
- ▶ Always transport objects in lockable storage compartments where possible.
- ▶ Stow objects so that they cannot slip or slide around in the aforementioned situations.
- ▶ Always ensure that objects are not protruding from storage compartments or luggage nets.
- ▶ Do not transport heavy, hard, pointed, sharp-edged or fragile objects in open storage compartments or trays.
- ▶ Keep lockable storage compartments closed while driving.

The vehicle offers the following storage options:

- glove box
- Front and rear drink holders
- Clothes hooks on the B-pillars and the rear grab handles
- Storage compartment under the boot floor
- Storage compartment in the front armrest
- Storage compartment and bottle holder in the front and rear door panel
- Open storage compartments on the left and right in the boot
- Open storage compartment between the rear seats (vehicles with 2 rear seats)

Depending on the equipment, the vehicle has the following additional storage options:

- Storage tray with side boundaries under the centre console control panel
- Storage tray on the centre tunnel in front of the rear seats
- Storage net in the boot
- Bag hook in the boot

Opening and closing the glove box



Fig. 200: Opening the glove box

Opening the glove box

- ▶ Pull the handle.
Glove box opens automatically.

Closing the glove box

- ▶ Close the cover by pressing on it.

The glove box can be locked and unlocked using the emergency key.

- ▶ Please refer to chapter "Driver's Key" on page 104.

Opening the storage compartment in the armrest

Opening the storage compartment in the front armrest



Fig. 201: Opening the storage compartment in the front armrest

- ▶ Press the button on the driver side of the armrest.
Lid opens automatically.

Sun Visors

Adjusting sun visor



Fig. 202: Adjusting sun visor

- ▶ Swivel the sun visor down to prevent glare from the front.

If you are dazzled from the side:

- ▶ Unclip the sun visor from the inner bracket and swivel it round so that it is in front of the side window.

Opening vanity mirror



CAUTION

Cover of vanity mirror open

The mirror glass may break in the event of an accident and may fall into the passenger compartment if the cover is open.

- ▶ Keep the cover closed when driving.



Fig. 203: Opening vanity mirror

- ▶ Open the cover of the vanity mirror on the inside of the sun visor.

The vanity mirror light comes on.

NOTICE

Risk of damage to the vanity mirror cover.

- ▶ Do not force the cover beyond its end position.

Towing

Tow-starting and push-starting the vehicle

NOTICE

Danger of significant damage to the vehicle as a result of tow-starting or push-starting.

- ▶ **Never** tow-start or push-start the vehicle.
- ▶ Do not attempt to tow the vehicle.
- ▶ Call a roadside assistance or breakdown recovery service.
- ▶ Have the vehicle transported with both axles on a recovery vehicle, car transporter or trailer.
- ▶ Tie the vehicle down only at its wheels. Do not attach tension straps to the towing lug.

If the high-voltage battery is defective or fully discharged, the vehicle can only be started after the high-voltage battery has been recharged.

- ▶ Call in a qualified specialist workshop. Porsche recommends a Porsche partner as they have trained workshop personnel and the necessary parts and tools.
- ▶ Please refer to chapter "12-volt battery" on page 282.

Towing the vehicle



Fig. 204: Permissible towing



Fig. 205: Impermissible towing

- ▶ Please refer to chapter "Transporting the vehicle on car trains, ferries and car transporters" on page 246.

Towing another vehicle

- ▶ For specifications and mounting instructions, please refer to the manual from the accessory

manufacturer. Observe the manufacturer's safety and operating instructions.

- ▶ Observe the permissible towing force of the towing rope or towing bar. The towing rope or towing bar must be approved for the vehicle weight. Never exceed the manufacturer's specifications.
- ▶ The towed vehicle must not be heavier than the towing vehicle.
- ▶ Vehicles with defective brakes must **not** be towed.
- ▶ When towing, screw the towing lug to the vehicle before the towing rope or towing bar is secured to the towing lug.
 - ▷ Please refer to chapter "Using the towing lug" on page 245.

Using a towing rope

- ▶ Always keep the towing rope taut when towing. Avoid jerky and sudden loads.

Using a towing bar

- ▶ Do **not** attach the towing bar diagonally between the vehicles.

Using the towing lug

i Information

- ▶ Always observe the laws governing vehicle transport.
- ▶ Before starting off, the driver should become familiarised with the special conditions that apply to vehicle transport.



Fig. 206: Towing lug in front

Fitting the front towing lug

The towing lug is stored in the tool kit.

- ▷ Please refer to chapter "Luggage compartment" on page 153.
1. Press the lower edge of the plastic cover into the bumper until the cover disengages.
 2. Pull the plastic cover out of the bumper and let it hang by its thread.
 3. Screw in towing lug **A** anti-clockwise as far as it will go (left-hand thread) and tighten hand-tight.

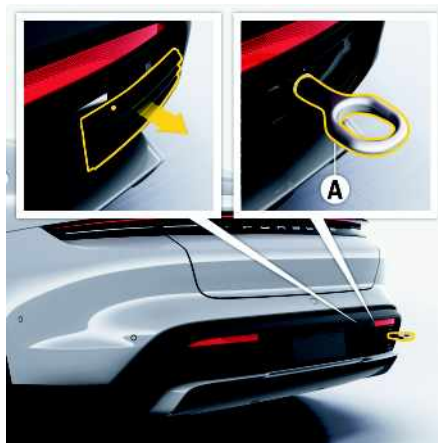

Fig. 207: Towing lug at rear

Fitting the rear towing lug

The towing lug is stored in the tool kit.

- ▷ Please refer to chapter "Luggage compartment" on page 153.
1. Press the top edge of the plastic cover at the marking, and carefully disengage the plastic cover using a suitable tool.
 2. Pull the plastic cover out of the bumper and stow it safely in the vehicle.
 3. Screw in towing lug **A** anti-clockwise as far as it will go (left-hand thread) and tighten hand-tight.

Removing the towing lug

1. Screw out towing lug **A** clockwise (left-hand thread).
2. Insert the plastic cover at the lower edge of the opening.
3. Fold i[the plastic cover and press on the upper edge until it engages in the bumper.
4. Store the towing lug in the tool kit.

Transporting the vehicle on car trains, ferries and car transporters

1. Tie the vehicle down only at its wheels. Do **not** attach tension straps to the towing lug.
2. Deactivate interior surveillance and the inclination sensor.
 - ▷ Please refer to chapter "Alarm System" on page 54.
3. Activate Porsche Vehicle Tracking System Plus (PTVS Plus) transport mode.
 - ▷ Please refer to chapter "Transport" on page 209.

Traffic sign detection

General Safety Instructions



WARNING

Lack of attention

Responsibility when driving, e.g. choosing an appropriate speed, remains with the driver even if traffic sign recognition is being used. The system is no substitute for attention on the part of the driver.

- ▶ Drive with extreme care.
- ▶ Always pay attention to the traffic situation and the area around the vehicle.
- ▶ Adapt your driving speed to traffic conditions.



WARNING

Failure of camera to detect traffic signs

Camera vision can be impaired by various factors, e.g. rain, snow, ice, heavy spray, oncoming headlights, reflections, dirt or damage.

Sometimes the camera cannot detect traffic signs or cannot detect them correctly. When this happens, no speed limit or bend ahead warning, or an incorrect speed limit or bend ahead warning is displayed.

Traffic signs on the road always have priority.

- ▶ Always pay attention to traffic signs when driving on public roads.
- ▶ Drive with extreme care.
- ▶ Always pay attention to the direction of travel.
- ▶ Clean the camera lens regularly and keep free of snow and ice.
- ▶ Do not cover the camera lens, and check for damage regularly.

System limitations

The assistance provided by the system cannot be guaranteed if traffic signs are covered or damaged.

Responding to warning messages

Always heed any warning and information messages displayed in the vehicle.

- ▶ Please refer to chapter "Warning and information messages" on page 271.

Operating principle

Traffic sign recognition (availability dependent on country) detects speed limits, the beginning and end of no-overtaking zones as well as bend ahead signs. Traffic signs are evaluated and shown on the instrument cluster using camera (A) and the navigation system's map data.

If a traffic sign is confined to a certain time or weather conditions (e.g. fog or wet), the detected sign is compared with the information provided by the vehicle (e.g. rain sensor, navigation data and time) and possibly displayed.

In countries where traffic sign recognition is not available, a message appears on the instrument cluster.



Fig. 208: Windscreen camera

Display elements

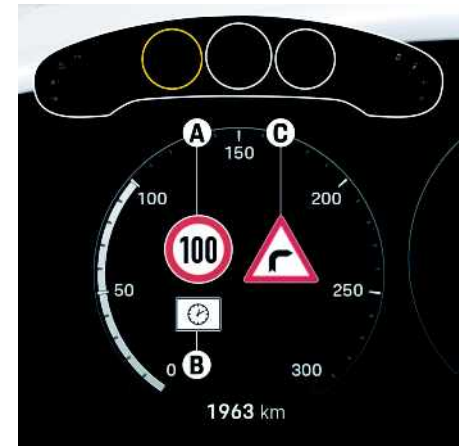

Fig. 209: Traffic sign display on the instrument cluster

- A Main traffic signs
- B Additional signs
- C Bend ahead warning

Up to 3 main traffic signs (A) including additional signs (B) can be displayed on the instrument cluster. The highest priority traffic sign is displayed on the left.

The bend ahead warning (C) is issued approx. 150 m before a bend and continues until the bend has been passed.

Speed limit display

After operational readiness is established, the most recent valid speed limit appears on the instrument cluster. If no speed limit is detected or if traffic sign recognition is not available in the current area, a message appears on the instrument cluster.

i Information

- In zones with traffic calming or residential streets, the display reads "5 km/h" (3 m/h).
- At unsigned motorway and dual carriageway entry and exit points, the relevant speed limit for country roads is displayed.

Speed limit warning display

- The first time the speed limit is exceeded, the sign flashes once.
- A red frame appears around the sign that flashes for 10 seconds.
- The frame then remains constantly lit up.

Speed limit warning

A speed limit warning with a warning threshold of 0 km/h – 10 km/h (0 mph – 5 mph) can be set in the central display. The function must also be activated. When the set threshold is exceeded, the relevant traffic sign is highlighted on the instrument cluster.

Setting and activating speed limit warning

▶  ▶ Assistance ▶  ▶ Assistance system settings ▶ Traffic sign recognition

Tyres and Wheels

In addition to correct tyre inflation pressure and correct wheel alignment, the service life of the tyres also depends on your driving style. Abrupt acceleration, high cornering speeds and heavy braking increase tyre wear. Tyre wear is also greater at higher outside temperatures and on rough road surfaces.

Complying with load and speed requirements

- ▶ Drive at an appropriate speed.
- ▶ Do not overload the vehicle, and check the roof load.
- ▶ Please refer to chapter "Technical Data" on page 308.

Checking tyre pressure

NOTICE

Insufficient tyre pressure can cause tyres to overheat and thus be damaged – even invisibly.

- ▶ Hidden tyre damage will not be eliminated by correcting the tyre pressure.
- ▶ Never let air out of warm tyres. When tyres are warm, the tyre inflation pressure is increased. This could cause the tyre pressure to fall below the prescribed value.



Fig. 210: Tyre-pressure plate fixing point

The tyre inflation pressure must match the prescribed value. These values are for cold tyres (20 °C).

- ▶ Observe tyre-pressure plate.
- ▶ Check the tyre pressure at least every 2 weeks when the tyres are cold.

Tyre Pressure Monitoring (TPM)

Tyre Pressure Monitoring offers the following functions:

- Permanent monitoring of tyre pressure and temperature.
- Display of actual tyre pressure (actual pressure) while driving.
- Tyre pressure warnings in two stages (yellow and red warning).
- Vehicle is stationary: Display of the pressure deviation from the required pressure.

The tyre pressure warning light  and a corresponding message on the instrument cluster warn

against loss of pressure in two stages (yellow and red tyre pressure warning, depending on the extent of the pressure loss).

The tyre pressure warning light goes out only when the tyre pressure has been corrected.

The yellow tyre pressure warning is displayed for around 10 seconds after the car comes to a standstill and is switched off when the vehicle is turned on again. The yellow tyre pressure warning can be acknowledged when the vehicle is turned on. The red tyre pressure warning also appears during driving and can be acknowledged.

- ▶ If the tyre pressure warning light lights up and a tyre pressure warning is displayed despite the correct tyre pressure: Visit a qualified specialist workshop. Porsche recommends a Porsche partner as they have trained workshop personnel and the necessary parts and tools.

Information

Tyre Pressure Monitoring gives a warning about a pressure drop caused by natural diffusion as well as about a gradual loss of pressure caused by foreign objects. Tyre Pressure Monitoring cannot warn you about tyre damage that occurs suddenly (e.g. a flat tyre due to unexpected external effects).

WARNING

Defective tyres

Driving with defective tyres can result in serious accidents.

- ▶ When a red tyre pressure warning appears on the instrument cluster: stop immediately in a suitable place and check the tyres for damage. If necessary, correct the damage using tyre sealant

or fit the spare wheel.

- ▶ **Do not** continue driving with defective tyres. Have defective tyres replaced immediately. Visit a qualified specialist workshop. Porsche recommends a Porsche partner as they have trained workshop personnel and the necessary parts and tools.
- ▶ **Do not** drive with tyres in which the tyre pressure drops again very quickly. In case of doubt, have tyres checked by a qualified specialist workshop. Porsche recommends a Porsche partner as they have trained workshop personnel and the necessary parts and tools.

Faults in the Tyre Pressure Monitoring (TPM) system

TPM will not function correctly in the following situations, for example:

- If the Tyre Pressure Monitoring is faulty
- If wheel transmitters for Tyre Pressure Monitoring are missing
- During the learning phase after the tyre settings have been updated
- After a wheel change without updating the tyre settings
- If tyre temperatures are too high

Checking the tyre pressure in the instrument cluster

The individual tyre pressures are only displayed above a speed of approx. 25 km/h (16 mph) or if the tyre has been inflated by at least 0.1 bar (1.5 psi). When the vehicle is turned on after the vehicle has been stationary for more than approx. 10 minutes, lines (-.-) will appear instead of the tyre pressures.

- ▶ **Tyre info ▶ Current press.**

- ▶ Please refer to chapter "Operating the instrument cluster" on page 129.

The display of the actual pressure is only for information. The tyre pressures change depending on the temperature.

- ▶ Under no circumstances should the tyre pressures be changed based on this display.

Checking the pressure deviation in the instrument cluster



Fig. 211: Example of pressure difference

- ✓ Vehicle is stationary.

▶ Tyre info ▶ Pressure deviation

- ▶ Please refer to chapter "Operating the instrument cluster" on page 129.

The difference to the required pressure is displayed on the relevant wheel. Example: If **-0.1 bar (-1.5 psi)** is displayed for the rear right wheel, 0.1 bar (1.5 psi) must be added to this tyre. The displayed pressures take into account the tyre temperature.

- ▶ Always use the pressure deviation from the display or from the corresponding tyre pressure warning to correct the tyre pressure.

Setting tyres

Settings for tyre type, tyre size and load can be adjusted via the central display:

- ▶ Please refer to chapter "Configuring Tyre Pressure Monitoring (TPM) on the central display" on page 250.

Configuring Tyre Pressure Monitoring (TPM) on the central display



WARNING

Incorrect settings

Low or high tyre pressure irreparably damages the tyre and the wheel, lengthens the braking distance and greatly increases the risk of an accident.

Despite the Tyre Pressure Monitoring system, it is still the driver's responsibility to ensure that the tyres are inflated with the correct tyre pressure and the vehicle settings are correct. Incomplete or incorrect settings may affect the accuracy of warnings and messages.

- ▶ Adapt tyre pressure to suit your specific tyres and the payload.
- ▶ Make sure that the settings in the TPM menu correspond to the tyres fitted on the vehicle and its payload (especially after a wheel change or changes in vehicle loading).
- ▶ Then select the type and size of fitted tyre again in the TPM menu, even if the settings for the newly fitted set of wheels are the same as for the old wheels.

Accessing filling information

- ✓ Vehicle is stationary.

- ▶ ▶ **Setting** ▶ **Vehicle** ▶ **Tyre pressure monitoring**

Load, tyre type and tyre size settings are displayed:

If the tyres have not yet been registered dashes (-.-) are displayed instead of the tyre pressures.

Displaying pressure difference

- ✓ Vehicle is stationary.

▶  ▶  ▶ **Vehicle** ▶ Tyre pressure monitoring ▶ **pressure deviation**

Displaced are the required pressure and the pressure deviation from the required pressure for each wheel along with the load, tyre type and tyre size information.

Example: If **-0.1 bar** [-1.5 psi] is displayed for the rear right wheel, 0.1 bar (1.5 psi) must be added to this tyre. The displayed pressures take into account the tyre temperature.

- ▶ Always use the pressure deviation from the display or from the corresponding tyre pressure warning to correct the tyre pressure.

If the tyres are not yet taught, the new required pressures are displayed instead of the actual pressure deviations.

Setting tyre type and tyre size

Information

The options available depend on the model and tyre type. For this reason, some of the selection options shown here may not be available.

- ▶ Before fitting tyres and wheels with dimensions that are not available for selection in the TPM menu, the missing information should be added. Visit a qualified specialist workshop. Porsche recommends a Porsche partner as they have trained workshop personnel and the necessary parts and tools.
- ▶ Use only tyres and wheels authorised by Porsche.

▶  ▶ **Setting**  ▶ **Vehicle** ▶ Tyre pressure monitoring ▶ **tyre selection**

Selecting full load or partial load

▶  ▶  ▶ **Vehicle** ▶ Tyre pressure monitoring ▶ **full load**

- Full load**
Full load is activated.
- Full load**
Partial load is activated.

- ▶ Adapt the tyre pressures to the selected load type.

Information

If the option **Full load** is not displayed, the specified tyre pressures are valid for all types of vehicle load.

Teaching in Tyre Pressure Monitoring

Tyre Pressure Monitoring begins to learn the tyres after a wheel change, wheel transmitter replacement or update of the tyre settings. During this process, Tyre Pressure Monitoring recognises the wheels and their locations. Position and pressure information is displayed as soon as Tyre Pressure Monitoring has assigned the wheels recognised as belonging to the vehicle to the correct wheel positions.

During the learning process, the target pressures for cold tyres (20 °C) are displayed on the central display and a message appears on the instrument cluster.

The tyre pressure warning light  on the instrument cluster remains lit until all the wheels have been registered.

Inflating tyres



Hot filling hose

The compressor's filling hose can get hot during the inflation process and can cause burns.

- ▶ Wear gloves.

The compressor is housed in the right-hand box in the front luggage compartment.

- ▶ Please refer to chapter "Luggage compartment" on page 153.
- ▶ Read and follow the operating instructions on the compressor.

1. Screw the compressor's filler hose onto the tyre valve.
2. Connect the compressor to a plug socket in the vehicle and switch on the compressor.
The tyre is inflated.
3. Check inflation pressure using the pressure gauge and reduce tyre pressure or add more air if necessary. Check the inflation pressure again.
4. Switch off compressor.
5. Unscrew the compressor's filler hose.

Information

The tyre pressure can also be checked at a service station and the tyres can be inflated.

Reducing inflation pressure

1. Switch off compressor.
2. Open air bleed screw on the filler hose until the correct inflation pressure is achieved.

Reading off inscription on tyres



Fig. 212: Inscription on tyres

- A Nominal width in mm
- B Cross-section ratio in %
- C Belt type code letter
- D Rim diameter in inches
- E Load rating code number
- F Speed code letter

The speed code letter **F** indicates the maximum permitted speed for the tyre.

H	up to 210 km/h (130 mph)
V	up to 240 km/h (150 mph)
W	up to 270 km/h (168 mph)

Y up to 300 km/h (186 mph)

(Y) up to 300 km/h (186 mph) as for Y tyres. Speeds of more than 300 km/h (186 mph) are also possible at a maximum tyre load capacity of 85 % (confirmation from tyre manufacturer required for speeds of more than 300 km/h (186 mph)).

Detecting tyre damage



WARNING

Hidden tyre damage and rim flange damage

Hidden tyre damage can cause the tyre to burst. You may lose control of the vehicle.

- ▶ Check tyres, including the sidewalls, regularly for foreign bodies, nicks, cuts, cracks and bulges.
- ▶ Cross kerb edges slowly and at right angles if possible. Avoid heavy or sharp-angled impact against steep and sharp kerbs or sharp-edged objects (e.g. stones).
- ▶ If in doubt, have the wheel – particularly the inner side – checked by an expert. Visit a qualified specialist workshop. Porsche recommends a Porsche partner as they have trained workshop personnel and the necessary parts and tools.
- ▶ Tyres must never be repaired under any circumstances. Sealing the tyre with the tyre sealant is only an emergency solution to enable you to drive to the nearest workshop.

In the case of the following tyre damage, the tyre must be replaced for safety reasons:

- Tyre damage where the possibility of a ply fracture cannot be ruled out.

- If the tyre has been thermally and mechanically overloaded following a loss of pressure or other previous damage.

Changing tyres and wheels

- ▶ Switch off the ignition when changing a wheel.



WARNING

Lack of grip

In the initial period, new tyres do not yet have their full road-holding ability or grip.

- ▶ You should therefore drive at moderate speeds during the first 200 km (125 miles) to extend the service life of the tyres and achieve full performance capability.
- ▶ Only fit tyres of the same make and type and with the same specification number (e.g. "N...").
- ▶ Before fitting new tyres, inquire about their current approval status: Contact your Porsche partner.
- ▶ Use only tyre makes tested and approved by Porsche.
- ▶ The deviation in tread depth on an axle must not be more than 30 %.
- ▶ Only use second-hand tyres if you know their history.
- ▶ Always replace both tyres on an axle so that different profile depths will not unnecessarily influence vehicle handling.
- ▶ Tyres should only be fitted by professionals. Visit a qualified specialist workshop. Porsche recommends a Porsche partner as they have trained

workshop personnel and the necessary parts and tools.

- ▶ Adapt your driving style to the changed vehicle handling.
- ▶ Only use tyres with tyre pressure sensors for Tyre Pressure Monitoring (TPM).
- ▶ Make sure that the wheels are compatible with the TPM system in the vehicle. For information on suitable wheels and on the TPM system in the vehicle: Contact your Porsche partner.
- ▶ When changing a tyre, check the battery charge condition of the tyre pressure sensors: Visit a qualified specialist workshop. Porsche recommends a Porsche partner as they have trained workshop personnel and the necessary parts and tools.
- ▶ Please refer to chapter "Technical Data" on page 308.

i Information

If new tyres are fitted to only one axle, the different tread depths on the two axles can cause a marked change from the previous driving behaviour to which you have become accustomed. This is particularly true when new tyres are fitted to the rear axle. The effect is reduced continuously, however, as tyre mileage increases.

Checking and replacing valves and valve caps

- ▶ Use only genuine Porsche valves for the Tyre Pressure Monitoring (TPM) system.
- ▶ Check the valves whenever the tyres are changed and replace them if necessary. Porsche recommends a Porsche partner as they have trained workshop personnel and the necessary parts and tools.

If valve caps are missing, the valve is unprotected from dust and dirt, resulting in leaks.

- ▶ Always screw on valve caps tightly to protect valve inserts from dirt. Dirty valve inserts can cause creeping air loss.
- ▶ Replace missing valve caps immediately.
- ▶ Use only plastic valve caps.

Using winter tyres



WARNING

Exceeding the maximum permitted speed

Exceeding the maximum permitted speed can cause tyres to burst.

- ▶ Observe the maximum permitted speed for the tyre.
 - ▶ Only fit winter tyres rated for a lower permitted top speed than the specified maximum vehicle speed if they bear the M+S designation or the snowflake symbol on the tyre sidewall. Observe country-specific laws.
 - ▶ Affix a sticker showing the maximum permitted speed in the driver's field of vision. Observe country-specific laws.
 - ▶ Set the maximum permitted speed as the speed limit.
-
- ▶ Install winter tyres in a timely manner before the cold season begins.
 - ▶ Use only tyre makes tested and approved by Porsche.
 - ▶ Before fitting new tyres, inquire about their current approval status: Contact your Porsche partner.



Information

At low temperatures, juddering noises caused by the tyres can occur during manoeuvring or accelerating out of curves on both dry and wet road surfaces.



The driving performance and comfort of summer tyres is reduced at low temperatures below 7 °C. Porsche therefore recommends that you fit winter tyres on the vehicle when temperatures are below 7 °C.

Extremely low temperatures below –15 °C can cause permanent damage to summer tyres.

Winter tyres are no longer suitable if their tread depth is less than 4 mm.

Using snow chains

Snow chains can be fitted to the rear axle only, with the tyre/wheel combinations listed under "Technical Data" and marked for snow chain use.

- ▶ Please refer to chapter "Technical Data" on page 308.
- ▶ Use only the snow chains approved by Porsche to guarantee sufficient clearance between the wheel well and the chain.
- ▶ Remove ice and snow deposits in the wheel well before installing the chains.
- ▶ Vehicles with rear axle steering: Deactivate rear axle steering.
 -  ▶ **Setting**  ▶ **Vehicle settings** ▶ **Additional chassis settings**
- ▶ Observe the different national regulations regarding maximum speeds.

Checking tyre tread

Most tyres have integrated wear indicators in the centre of the tread. These wear indicators are

located in the main tread channels and display the minimum tread depth of 1.6 mm.

- ▶ Check the tyre tread regularly, particularly before and after long journeys.

Measuring the tyre tread depth

- ▶ Insert a commercially available tread depth gauge or calliper in the tyre tread and measure the tyre tread depth.

i Information

Uneven tyre wear indicates a defect on the vehicle:

- ▶ Visit a qualified specialist workshop. Porsche recommends a Porsche partner as they have trained workshop personnel and the necessary parts and tools.

Storing wheels

Tyres must **not** be more than 6 years old. Chemical additives, which make the rubber in the tyre elastic, lose their effect over the course of time and the rubber becomes brittle. The age of a tyre can be seen from the DOT code on the tyre sidewall. If the last four digits are 3016, for example, the tyre was manufactured in the 30th week of 2016.

- ▶ Always store wheels in cool, dry and dark conditions. Tyres without rims should be stored in a standing position.
- ▶ Do not store summer tyres or park vehicles fitted with summer tyres at ambient temperatures below -15 °C.
- ▶ Avoid contact with petrol, oil and grease.

Balancing wheels

As a precaution, have wheels balanced in spring (summer tyres) and before winter (M+S tyres).

- ▶ Visit a qualified specialist workshop. Porsche recommends a Porsche partner as they have trained workshop personnel and the necessary parts and tools.

Changing a wheel

⚠ WARNING

Working under the vehicle

The vehicle can slip off the jack.

- ▶ Make sure that no one is in the vehicle when jacking up and changing a wheel.
 - ▶ Raise the vehicle only at the prescribed jacking points on the vehicle underbody.
 - ▶ Never jack up the vehicle when it is parked on a surface that slopes up, down or to the side.
 - ▶ Only use the jack to raise the vehicle for changing wheels.
 - ▶ Always place the vehicle on solid supports when working under the vehicle.
-
- ▶ Please refer to chapter "Jack and Lifting Platform" on page 138.

i Information

The tools needed for changing wheels (jack, wheel bolt wrench, mounting aids, etc.) are not included in the standard scope of supply for the vehicle.

- ▶ For information on the tool required: Contact your Porsche partner.

i Information

The tyre and wheel sizes are different on each of the two axles. When wheels are removed, mark the direction of rotation and position of each wheel and fit the wheels in accordance with this marking.

- ▶ Only use wheels/tyres with approved dimensions for each axle.

Vehicle registration documents or Please refer to chapter "Technical Data" on page 308.

Caring for wheel attachment faces

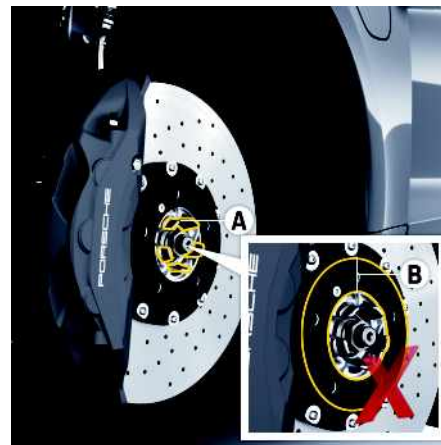

Fig. 213: Wheel attachment faces

NOTICE

Risk of damage to the wheel and wheel attachment face.

- ▶ The wheel attachment face **B** on the brake disc and on the wheel hub itself must **not** be greased.
- ▶ Only the areas **A** may be greased. Grease these areas very thinly with Optimoly® TA: Contact your Porsche partner. Do not use any other grease or paste.

Caring for wheel bolts

- ▶ Always clean the wheel bolts before fitting.
- ▶ Wheel bolts must not be greased.
- ▶ Replace damaged wheel bolts. Only use genuine Porsche wheel bolts intended for this particular model or wheel bolts of similar quality which have been manufactured according to Porsche specifications and production requirements.
- ▶ **Tighten wheel bolts to a tightening torque of 160 Nm (118 ftlb.).**
- ▶ Do not use any force-activated tools such as impact screwdrivers.

Using security wheel bolts



Fig. 214: Adapter for security wheel bolts

The adapter for the security wheel bolts is located in the tool kit.

- ▶ To loosen and tighten the wheel bolt with anti-theft protection, the adapter must be used between the wheel bolt and the wheel bolt wrench.
- ▶ When positioning the adapter ensure that it engages fully in the teeth of the wheel bolt.

Changing a wheel

Preparing the vehicle



WARNING

Control operation of the levelling system

A vehicle on which the levelling system is activated can move unexpectedly or tip or fall off lifting equipment, e.g. a jack or lifting platform. This can

result in serious injury and damage.

- ▶ Manually set Normal Level and switch off the levelling system before lifting the vehicle.

▶  ▶  ▶ **Setting** ▶ **Vehicle** ▶ **Additional chassis settings** ▶ **Deactivate chassis adjustment before using a jack**

1. Activate the electric parking brake.
2. Turn off the vehicle.
3. Secure the vehicle to prevent it from rolling away, e.g. by placing wheel chocks at the wheels on the opposite side.
4. Slightly loosen the wheel bolts or wheel nuts on the wheel to be changed.
5. Lift the vehicle only at the specified jacking points.
 - ▶ Please refer to chapter "Jack and Lifting Platform" on page 138.
6. Raise the vehicle until the wheel lifts off the ground.

Changing a wheel



Fig. 215: Screw in one assembly aid on vehicles without PCCB

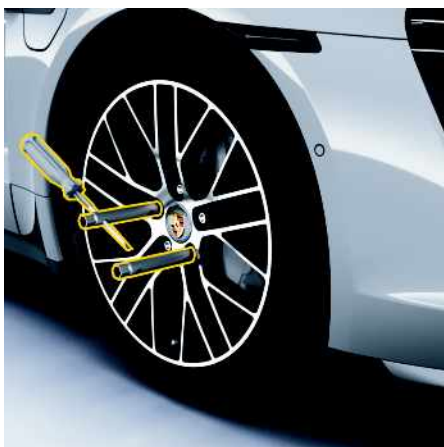

Fig. 216: Screw in two assembly aids on vehicles with PCCB

1. For vehicles without PCCB: Remove one wheel bolt and screw in one assembly aid.
– or –
1. For vehicles with PCCB: Remove two wheel bolts and screw in two assembly aids **A** and **B**.

NOTICE

The brake discs can become damaged in the case of improper wheel change, especially in vehicles with PCCB.

► Screw in assembly aids when changing a wheel.

2. Remove the remaining wheel bolts.
3. Remove the wheel.
4. Fit a new wheel.
5. Insert wheel bolts and tighten slightly in diagonally opposite sequence.
6. Remove assembly aids and screw in remaining wheel bolts. Initially tighten wheel bolts only slightly in diagonally opposite sequence so that the wheel is centred.
7. Inflate the tyre if necessary.
8. Lower the vehicle fully and remove the jack.
9. Tighten the wheel bolts in diagonally opposite sequence. Do not use any force-activated tools such as impact screwdrivers.
10. **Immediately after changing a wheel, use a torque wrench to check the prescribed tightening torque of the wheel bolts (1600 Nm / 1180 ftlb.).**
11. The settings for Tyre Pressure Monitoring (TPM) are updated.
 - Please refer to chapter "Teaching in Tyre Pressure Monitoring" on page 251.



Vehicle settings

Different vehicle settings can be adjusted depending on the model, country and equipment. The vehicle settings described here are therefore not available in all models, countries and equipment versions. For safety reasons, some functions are only available when the vehicle is stationary.



The vehicle settings remain stored after the vehicle is switched off.

► Please refer to chapter "Personal settings" on page 180.



System settings

What do I want to do?	What should I choose?	Where?
Configuring general system settings (language, time, units, etc.)	<ul style="list-style-type: none"> ▶ Touch  ▶ Setting  ▶ System. – Language and keyboard – Date and time – Units – Reset system to factory settings 	–



Display settings

What do I want to do?	What should I choose?	Where?
Configuring general display settings (brightness, touch tone setting, etc.)	<ul style="list-style-type: none"> ▶ Touch  ▶ Setting  ▶ Displays. – Central display – Touch control panel – Instrument cluster – Additional instrument 	–



Volume settings

What do I want to do?	What should I choose?	Where?
Adjusting the volume (navigation announcements, ParkAssist, etc.)	<ul style="list-style-type: none"> ▶ Touch  ▶ Setting  ▶ Volume. – Nav. announcements – ParkAssist – Volume reduced when ParkAssist is active – Speed dependent volume – Lane departure warning – Call tone – Message tone – Mute navigation during call 	–



Sound settings

What do I want to do?	What should I choose?	Where?
Setting the sound (treble/bass, balance/fader)	<ul style="list-style-type: none"> ▶ Touch  ▶ Setting  ▶ Sound. – Bass and treble – Balance and fader 	–



Voice control settings

What do I want to do?	What should I choose?	Where?
Configuring voice control settings	<ul style="list-style-type: none"> ▶ Touch  ▶ Setting  ▶ Voice control. – Activation with "Hi Porsche" – Short dialogue – Interrupt voice control – Online voice recognition 	▷ p. 264



Vehicle settings

What do I want to do?	What should I choose?	Where?
Configuring vehicle settings / using vehicle functions (unlocking when approaching the vehicle, folding in mirrors, tyre selection, activation of dynamic high beam, etc.)	<ul style="list-style-type: none"> ▶ Touch  ▶ Setting  ▶ Vehicle. – Spoiler manual cleaning position – Electric parking brake – Quick access buttons – Bonnet, tailgate and charging ports – Vehicle locking system – Tyre pressure monitoring – Light and visibility 	<ul style="list-style-type: none"> ▷ p. 233 ▷ p. 61 ▷ p. 125 ▷ p. 57 ▷ p. 69 ▷ p. 249 ▷ p. 147



Assistance system settings

What do I want to do?	What should I choose?	Where?
Adjusting assistance system settings (warning signal volume, warning time setting, etc.)	<ul style="list-style-type: none"> ▶ Touch  ▶ Setting  ▶ Assistance systems. – ParkAssist – Porsche Active Safe – Porsche InnoDrive – Adaptive Speed Limiter – Lane departure warning – Lane Change Assist – Night View Assist – Traffic sign recognition – Personal speed limits – Dangerous situations 	<ul style="list-style-type: none"> ▷ p. 176 ▷ p. 267 ▷ p. 199 ▷ p. 230 ▷ p. 144 ▷ p. 139 ▷ p. 171 ▷ p. 247 ▷ p. 230 –



Notification centre

What do I want to do?	What should I choose?	Where?
Configuring notification settings	<ul style="list-style-type: none"> ▶ Touch  ▶ Setting  ▶ Notification centre. – Allow notifications – Notification tone 	▷ p. 173



Radio settings

What do I want to do?	What should I choose?	Where?
Configuring radio settings	<ul style="list-style-type: none"> ▶ Touch  ▶ Setting  ▶ Media. – Traffic notices – Station tracking in case of weak reception – Online station tracking in case of weak reception 	–



Porsche Connect settings

What do I want to do?	What should I choose?	Where?
Configuring settings for Porsche Connect (privacy, etc.), displaying the Legal Notice and data privacy information	▶ Touch  ▶ Setting  ▶ Privacy and Porsche Connect.	▶ p. 196









Set-up wizard

What do I want to do?	What should I choose?	Where?
<p>Calling up the set-up wizard</p> <p>When you start the PCM for the first time, the Set-up assistant is displayed and guides you through important steps for configuring the PCM.</p> <p>The Set-up assistant can also be accessed manually.</p>	▶ Touch  ▶ Setting  ▶ Set-up assistant.	▶ p. 180



Software information

What do I want to do?	What should I choose?	Where?
Displaying software information (version, components)	▶ Touch  ▶ Setting  ▶ Software information.	–

Drive



What do I want to do?	What should I choose?	Where?
Set drive mode	▶ Touch  ▶ Drive ▶ Drive mode.	▶ p. 106
Set chassis tuning	▶ Touch  ▶ Drive ▶ Chassis.	▶ p. 187
Set chassis height	▶ Touch  ▶ Drive ▶ Chassis height.	▶ p. 187
Set recuperation	▶ Touch  ▶ Drive ▶ Recuperation (accelerator).	▶ p. 236
Set E-sound	▶ Touch  ▶ Drive ▶ E-Sound.	▶ p. 106
Configure Individual drive mode	▶  ▶ Drive ▶  ▶ Individual drive mode configuration Touch.	▶ p. 106
Configure Range drive mode	▶  ▶ Drive ▶  ▶ Range drive mode configuration Touch.	▶ p. 106

Assistance





What do I want to do?	What should I choose?	Where?
Switch basic assistance systems on The basic assistance systems are designed for safety and should always be switched on.	▶ Touch  ▶ Assistance ▶ Basic assistance. – Porsche Active Safe – Emergency Stop Function – Night View Assist	▶ p. 267 ▶ p. 112 ▶ p. 171
Display ParkAssist	▶ Touch  ▶ Assistance ▶ ParkAssist.	▶ p. 176
Switch assistance systems on	▶ Touch  ▶ Assistance.	

What do I want to do?	What should I choose?	Where?
	– Lane Keep Assist	▷ p. 144
	– Active Lane Keeping	▷ p. 30
	– Manoeuvring Assist	–
	– Rear Cross Traffic Alert	–
	– Intersection Assist	▷ p. 136
	– Lane Change Assist	▷ p. 139
	– Traffic sign recognition	▷ p. 247
	– Traffic Jam Pilot	–

Trip

What do I want to do?	What should I choose?	Where?
Display trip data (average fuel consumption, range, driving time, etc.)	▶ Touch  ▶ Trip.	–
Configure how trip data is displayed	▶ Touch  ▶ Trip ▶ Personal trip.	–
Reset trip data	▶ Touch  ▶ Trip ▶ Reset trip data.	–

Comfort

What do I want to do?	What should I choose?	Where?
Adjust ambient lighting (brightness, colour)	▶ Touch  ▶ Comfort ▶ Ambient lighting.	
Set comfort functions on driver/passenger seat (massage function, seat heating/seat ventilation balance)	▶ Touch  ▶ Comfort ▶ Driver seat/Passenger seat.	▷ p. 223
Switch comfort entry function on	▶ Touch  ▶ Comfort ▶ Comfort Entry.	▷ p. 223
Adjust passenger seat from the driver's seat	▶ Touch  ▶ Comfort ▶ Adjust passenger seat.	▷ p. 223

voice control

Quick overview Voice control

This brief overview does not replace the comprehensive descriptions. Safety messages and warnings, in particular, are not replaced by this brief overview.

For information on operating Porsche Communication Management (PCM):

- ▶ Please refer to chapter "Porsche Communication Management (PCM)" on page 190.

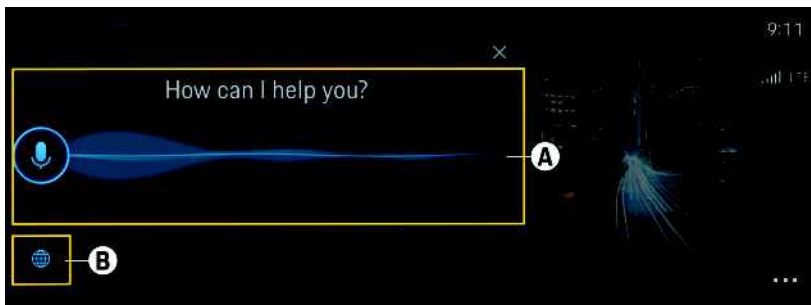



Fig. 217: Using voice control

What do I want to do?	What do I have to do?	Where?
Starting voice control	<ul style="list-style-type: none"> ▶ Press the  button on the steering wheel. An acoustic signal sounds and a corresponding window (see A) appears in the central display. 	▶ p. 264
Displaying the voice control settings	<ul style="list-style-type: none"> ▶ Tap  (see B) in the central display. 	▶ p. 266

Due to the various usage options, the features described here are not available in all models, countries and equipment versions.

WARNING Impaired voice recognition

Your voice may change in stressful situations. This can lead to the desired telephone connection failing or not being established quickly enough under

certain circumstances.

- ▶ Do not use voice control in an emergency.
- ▶ Enter the emergency number using the central display.

The voice control system communicates with the driver, thereby providing assistance for using the vehicle and completing various tasks while driving. It is your helpful companion and can be used interactively. The voice control system acts on and reacts to voice input, makes suggestions, performs searches based on your queries and incorporates environmental data.

Selected Precool/heat, Ergonomics, Media, Navigation and Phone functions can be activated, and controlled and used simply and easily via voice commands.

A Help function is available under Voice control.

Using voice control

- ✓ Vehicle ready for operation.
- ✓ No phone call active.
- ✓ Parking aid is not active.



Starting voice control via steering wheel



Fig. 218: Steering wheel with voice control button

1. Press the  button on the steering wheel.
An acoustic signal sounds and a corresponding window appears in the central display.
2. Say the voice command.



Starting voice control via the central display

1. Tap  ►  in Zentralsdisplay.
An input request sounds and a corresponding window appears in the central display.
2. Say the voice command.

The search results are limited to the currently selected quick filter bar, for example, if the quick filter bar **Media** is selected, only search results for this quick filter bar are displayed.

Starting voice control by saying "Hey Porsche"

- ✓ "Hey Porsche" activated:

1.  ► **Setting**  ► **Voice control** ► **Activation with "Hey Porsche"**
2. Say "**Hey Porsche**" and the desired voice command.

Pausing voice control

- ✓ Voice control is active and waiting for a voice command.
 - ▶ Tap  in Zentralsdisplay.
The dialogue will be paused and can be re-started by tapping again.

Ending voice control

- ✓ Voice control is active and waiting for a voice command.
 - ▶ Press the  button on the steering wheel.
– or –
Say **Cancel**.
A fading acoustic signal sounds.



Interrupting voice control via button

The voice output of the voice control can be interrupted during the dialogue.

- ▶ Briefly press the  button on the steering wheel.

Interrupting voice commands via voice input

The voice commands of voice control can be interrupted during the dialogue, for example, to say other voice commands or execute voice commands immediately. Activate the function in Zentralsdisplay:

- ▶ Tap  ► **Setting**  ► **Voice control** ► **Interrupt voice control**.

Starting external voice control (e.g. Siri)

- ▶ Please refer to chapter "Apple CarPlay" on page 55.

 1. Press and hold the  button on the steering wheel.
 2. Say your desired voice command.

Ending external voice control (e.g. Siri)

- ▶ Please refer to chapter "Apple CarPlay" on page 55.
- ▶ Press the  button on the steering wheel.
A fading acoustic signal sounds.

Notes on communication using voice control

Note the following points when using voice control:

- Speak clearly and at a normal volume.
- Stress voice commands evenly, without long pauses in your speech.
- Reduce disruptive sounds caused by closing doors, windows and sliding roof, for example.
- Voice control is optimised for the driver.

Using natural voice commands

The voice control system is operated using natural voice commands and can work using various types of spoken commands.

- Use natural instructions, such as "Set air conditioning to 22 °C.", "Turn on Shiatsu massage." or "Drive me to Parliament Street, London."
- Say what you need, e.g. "I'm cold" or "I want to go to a charging station."
- Use situation-related voice commands, e.g. "Avoid motorway." or "I would like to park here."
- Ask for information, e.g. "What's my battery charge level?" or "What's the weather like in London?"
- Use general search queries or questions, e.g. "What can I do in the Media area?" or "How does voice recognition work?"
- Use main functions, e.g. "I would like to see the map." or "Show my contacts."
- Use a destination from the map: Press your desired destination for longer and say "Hey Porsche, drive me there."

A
B
C
D
E
F
G
H
I
J
K
L
M
N
O
P
Q
R
S
T
U
V
W
X
Y
Z

General voice commands

The following voice commands can be said at any point in the dialogue:

- Correction
- Pause
- Cancel
- Help

Using lists by voice control

Browsing through lists

- ✓ Voice control is active.
- ▶ Say **Next page/Previous page**.

Selecting an entry from the list

Line numbers and list entries displayed in blue in the central display can be spoken and thereby selected.

- ✓ Voice control is active.
- ▶ Say **Line 1**.
 - or –
 Say a list entry.

Examples of commands

These are not complete lists and show only some of the possible natural voice commands and instructions for the voice control system.

A good data connection improves the search results and makes the search faster.

Air-conditioning system/Comfort functions

- Set seat heating to level 2
- The windscreen is misted up
- I would like a massage
- Change the ambient light to red

Navigation/while driving/Finder

- Drive me to the Porsche Museum

- When do I have to charge?
- Let me show you something on the map: Select a destination on the map on the central display.
- Find a restaurant along the route/at the destination
- How much longer will it take?
- I would like to park here
- Drive me to work
- Where have I driven to recently?

Media

- Play the song "Get a Life", for example, from Porsche Sounds
- A different song
- What am I listening to now?
- I would like to search for music
- Play Nelly Furtado in Apple Music
- Play Classic FM
- Skip on one track
- I would like to choose a different source

Phone

- ✓ No phone call active.
- Please call John Doe
- Dial 020 911, for example
- Try Andrew Forbes again
- Show my call list
- I would like to connect a new phone

Reacting to previous dialogues

- ✓ Voice control is active.
- It is possible to react to an older dialogue of a main function (e.g. Phone) using other voice commands:
- Please call John Doe again

Voice Control Help

The system can assist in different ways, questions can be asked or specific issues can be raised.

- I need help (general)
- How does voice control work?
- What can I do in the navigation area?
- What can you do?

Changing voice control settings

▶  ▶ **Setting**  ▶ **Voice control** ▶ Select the desired setting.

Online mode

- ✓ Data transfer to the cloud permitted.
- ✓ Data connection sufficient.
- ✓ Voice control is active.

The entire range of Voice Control functions, such as online search, can be accessed in online mode.

Online mode is displayed on the central display by means of the  symbol.

If the data connection is insufficient, PCM switches automatically to offline mode. Some Voice Control function are only available to a limited extent in offline mode.

If Voice Control is in offline mode, this is indicated on the central display by means of the  symbol.

Warn and Brake Assist (WBA)

General Safety Instructions



WARNING

System not available or has restricted availability

The system supports the driver within the limits of the system but cannot prevent an accident under all circumstances.

Responsibility for appropriate driving reactions aimed at avoiding an accident always lies with the driver.

- ▶ Drive with extreme care.
- ▶ Always pay attention to the traffic situation and the area around the vehicle.
- ▶ The driver must be ready at all times to assume control of the vehicle if the system is not available or fails to function as expected.

System limitations

Within the system limits, the system can warn against impending head-on collisions and initiate the appropriate braking manoeuvres (depending on the country) or steering assistance (depending on equipment). Not all road users and dangerous situations can be recognised correctly and in time.

The lateral vehicle areas and the rear area are not monitored.

In complex driving situations, the system can issue undesired warnings and perform undesired brake interventions.

Not all Warn and Brake Assist protection measures are triggered, depending on the hazardous situation.

The system is available above walking speed and can react to pedestrians or cyclists up to a speed of

85 km/h (53 mph). It can react to vehicles up to a speed of 250 km/h (156 mph).

The system does **not** respond to animals, crossing vehicles, oncoming vehicles and objects such as bars, fences and rail vehicles.

The function is not available:

- when reversing
- if the brake lights are defective
- if PSM malfunctions and if PSM is switched off
- if the airbag control unit malfunctions

The function may be restricted, or unavailable:

- up to 10 seconds after establishing readiness for operation
- if the seat belts are not fastened
- in sharp bends
- in the presence of reflective objects such as guardrails or when entering a tunnel
- in heavy rain, snow, fog and ice
- in the event of damage to the windscreen
- in the event of damage to the bumper, e.g. through parking bumps
- in the event of damaged or soiled radar sensors
- if the Adaptive Cruise Control (ACC) malfunctions

Responding to warning messages

Always heed any warning and information messages displayed in the vehicle.

- ▶ Please refer to chapter "Warning and information messages" on page 271.

Operating principle

Warn and Brake Assist (WBA) can initiate measures to protect the occupants and other road users in certain dangerous situations.

Warn and Brake Assist (WBA) includes the following functions depending on the country:

- Distance warning (depending on equipment)
- Collision warning
- Acute warning (warning jolt)
- Automatic braking and brake assistance
- Swerve Assist (depending on equipment)
- Turn Assist (depending on equipment)
- Preventive occupant protection functions (depending on equipment)

The camera behind the windscreen and the radar sensor of the Adaptive Cruise Control (ACC) (depending on the equipment) detect the surroundings in front of the vehicle. An impending frontal collision with other road users (vehicles, pedestrians or cyclists) can be detected.



Information

A warning time can be set for the distance and collision warning. This varies depending on the traffic situation and driver behaviour.

i Information

Observe the following information:

- ▶ Turn off Warn and Brake Assist while the vehicle is being used off public roads or being loaded onto car transporters, trains, ships or the like. This can prevent any undesired intervention by the system.
- ▶ Observe any applicable country-specific regulations, especially regarding driving, vehicle distance, speed, etc. The driver is always responsible for complying with the relevant regulations that apply in each country.
- ▶ Deactivate Warn and Brake Assist (WBA) during transport.

Distance warning

If Warn and Brake Assist (WBA) detects a safety hazard due to driving too closely to the car in front, the driver is warned by the  symbol on the instrument cluster.¹

Detection can take place within a speed range from approx. 65 km/h (40 mph) – 250 km/h (155 mph).

Collision warning

Fig. 219: Collision warning on the instrument cluster

If the system detects a possible collision, it can warn the driver by issuing a warning tone and displaying a warning on the instrument cluster.

Urgent warning (warning jolt)

If the driver does not respond to the collision warning, a warning jolt is performed in addition to the warning tone and display of the symbol on the instrument cluster.

With the warning jolt, the system draws attention to the increasing danger of collision.

In the event of this warning, it may still be possible to prevent a collision through the driver avoiding the pedestrian or braking sharply.

The urgent warning function is automatically active and cannot be manually adjusted.

Automatic braking and brake assistance (availability depending on country)

If the driver does not respond to the acute warning or does not brake sufficiently, the Warn and Brake Assist can support the driver while braking or brake the vehicle to a standstill by applying progressively increasing braking force.

Additionally, a warning tone is emitted and a symbol appears on the instrument cluster.

By reducing the vehicle speed, the consequences of a possible accident are mitigated.

i Information

Automatic braking interventions can be aborted with the following measures:

- ▶ Pressing the brake pedal
- ▶ Fully depress the accelerator pedal
- ▶ steer actively

i Information

Once the vehicle has reached a standstill, it is not held permanently by the brake system.

- ▶ If necessary, actuate the brake and resume control of the vehicle.

Swerve Assist

Swerve Assist can help in hazardous situations to steer the vehicle around an obstacle.

If the system detects a critical situation and the driver actively avoids the obstacle after the urgent warning, Swerve Assist will support the driver by selectively braking individual wheels and correcting

1. Not available in some country versions.

the steering angle with a slight steering movement. If Swerve Assist is active, automatic braking or brake assistance is aborted.

System limitations

Swerve Assist is available for speeds of 50 km/h (31 mph) – 150 km/h (93 mph).

Turn Assist

Turn Assist can assist with driving off or slow driving via a braking intervention, so that the vehicle¹ does not collide with an oncoming vehicle when turning left. The braking intervention keeps the vehicle in its own lane.

System limitations

Turn Assist is only available when using the direction indicator and up to a maximum speed of 10 km/h (6 mph).

Preventive occupant protection function

Seat belt system optimisation

When driving off, the front seat belts are gently tightened once to ensure an optimal position with regard to the occupants.

Activation is performed when reaching a driving speed of approx. 30 km/h (20 mph) or when the seat belts are fastened again.

Preconditioning of the seat belt and passenger compartment

In hazardous situations, Warn and Brake Assist can initiate measures to prepare for a possible collision in

order to support the effectiveness of the passive occupant protection systems. For this purpose, depending on the situation, the front seat belts are pretensioned, opened windows are closed and the side bolsters of the front seats are inflated (depending on the equipment).

Within the system limits, the preventive occupant protection measures can be activated in the following situations:

- during emergency braking initiated by the driver from a speed of approx. 30 km/h (20 mph)
- during an automatic brake intervention initiated by the vehicle

As soon as the collision hazard has passed and a stable driving condition is achieved, the preconditioning measures are ended and existing seat belt tension is released again.

System limitations

- In the case of repeated activation (e.g. in the context of driver safety training), the belt tension increases progressively so that it may no longer be possible to reliably release the belt tensioning. In this case, unfasten and refasten the seat belt or deactivate Warn and Brake Assist.
- In the event of a defect in the reversible belt tensioner, the preventive occupant protection systems are only available to a limited extent.
- After an accident, the seat-belt pretensioner may be damaged. Visit a qualified specialist workshop. Porsche recommends a Porsche partner as they have trained workshop personnel and the necessary parts and tools.
- If the functionality of PSM is restricted or switched off, the preventive Warn and Brake

Assist occupant protection functions are deactivated.

Switching Warn and Brake Assist on and off

NOTICE

- ▶ Switch off Warn and Brake Assist in the following situations:
 - during removal
 - when driving off public roads
 - during transport, e.g. on a car transporter, train or ship

▶  ▶ Assistance ▶ Basic assistance ▶ Warn and Brake Assist

If the Warn and Brake Assist is restricted or switched off, a display appears in the instrument cluster.

The Warn and Brake Assist is automatically switched on after operational readiness has been established.

Setting the distance warning

The distance warning can be switched off and on. The warning time can also be set.

▶  ▶ Assistance ▶ Basic assistance ▶ Warn and Brake Assist ▶ Distance warning

Setting the collision warning

The collision warning can be switched off and on. The warning time can also be set.

1. Country-dependent: Turn Assist is available in countries with right-hand traffic only when turning left and in countries with left-hand traffic only when turning right.

- A
- B
- C
- D
- E
- F
- G
- H
- I
- J
- K
- L
- M
- N
- O
- P
- Q
- R
- S
- T
- U
- V
- W**
- X
- Y
- Z

▶  ▶ Assistance ▶ Basic assistance ▶ Warn and Brake Assist ▶ Collision warning

Switching Turn Assist on and off

▶  ▶ Assistance ▶ Basic assistance ▶ Warn and Brake Assist ▶ Turn Assist

Switching Serve Assist on and off

▶  ▶ Assistance ▶ Basic assistance ▶ Warn and Brake Assist ▶ Swerve Assist

Warning and information messages

If a warning message appears, refer to the corresponding chapters in this manual. Warning messages only appear if all measurement prerequisites are met – all fluid levels should therefore be checked regularly. The message will disappear either after a certain time has elapsed or after it has been acknowledged.

If a warning light appears, refer to the corresponding chapters in this manual. Please refer to chapter "instrument cluster" on page 125.

Important messages are stored under  in the central display of the main menu. Depending on the message, its display can vary and be used, for example, in connection with graphics, symbols or buttons to acknowledge or confirm a prompt. Some messages can include other functions such as the display of instructions in the central display or the search for a nearby Porsche partner.

► Please refer to chapter "Notifications" on page 173.

General message structure

The following table shows the various types of message and their meaning.

colour	Message structure	Example	Urgency	Meaning and action required
Red	Cause : e.g. component failure/ Component defective/ Component faulty	Drive system fault Electric drive overheated	High risk of damage	Stop the vehicle immediately in a suitable place. ► Do not keep driving. Stop safely in a suitable place and switch off the vehicle. ► Call roadside assistance or have your vehicle towed. ► Please refer to chapter "Towing" on page 245. ► Have the fault remedied immediately at a qualified specialist workshop. ¹
	Step: Park the vehicle safely	Park the vehicle safely		
	if necessary, further step	Let the electric drive cool down		
Yellow	Cause : e.g. component failure/ Component defective/ Component faulty/ Component overloaded/ Component limited/ Component not available	Chassis fault	Increased risk of damage	Limited and adapted driving permitted. ► Adapt your driving style to the situation. ► Reduce load. ► If the fault occurs frequently or continuously, have it remedied at a qualified specialist workshop. ¹
	Step and, if necessary, further step: e.g. service necessary/	Consult a workshop		

1. Porsche recommends a Porsche partner as they have trained workshop personnel and the necessary parts and tools.

A
B
C
D
E
F
G
H
I
J
K
L
M
N
O
P
Q
R
S
T
U
V
W
X
Y
Z

colour	Message structure	Example	Urgency	Meaning and action required
	Consult a workshop/ Check component/ (adapted or restricted) driving possible/ Adapt or reduce speed/ Reduce load	adapted driving permitted		
White	Cause : e.g. component fault/ Component limited/ Component not (no longer) available	Camera system not available	Low risk of damage	Adapted driving permitted. <ul style="list-style-type: none"> ▶ Temporary condition. Normal condition is restored automatically while driving or after the vehicle has been restarted. ▶ Adapt your driving style to the situation. ▶ If the fault occurs frequently or continuously, have it remedied at a qualified specialist workshop.²
	Explanation: e.g. temporary condition	Temporary condition		
	If necessary, further step: e.g. driving permitted/ Reduce load/ Adapt your driving style	Driving permitted		

Messages with more information in this manual

Message on the instrument cluster or central display	Meaning and action required
Active Parking Support not available Limited sensor system, see Driver's Manual	Active parking support is restricted or is faulty. Adapted driving permitted. <ul style="list-style-type: none"> ▶ Adapt your driving style to the situation. ▶ Have the fault remedied as soon as possible at a qualified specialist workshop.²
A Function on Demand is currently in progress. Some displays, control units and functions of possible safety relevance as well as driver assistance systems may not be available. The vehicle currently won't start. Please consult the Driver's Manual for further information.	An update is being installed or a Function on Demand (FoD) is being activated. Readiness for operation is blocked. Displays and vehicle functions (e.g. comfort functions or anti-theft functions) may be temporarily disabled.

2. Porsche recommends a Porsche partner as they have trained workshop personnel and the necessary parts and tools.

Message on the instrument cluster or central display	Meaning and action required
<p style="text-align: center;">– OR –</p> <p>An online software update is currently in progress. Some displays, control units and functions of possible safety relevance as well as driver assistance systems may not be available. The vehicle currently won't start. Please consult the Driver's Manual for further information.</p>	<ul style="list-style-type: none"> ▶ Follow any requests in the central display, such as exiting the vehicle with all passengers. ▶ Do not use the vehicle while the update is being installed or Function on Demand (FoD) is activated. ▶ Please refer to chapter "Over-the-Air (OTA) functions " on page 174.
<p>Curb warning not available. Limited sensor system. See Driver's Manual.</p>	<p>Kerb warning is limited or is faulty.</p> <p>Adapted driving permitted.</p> <ul style="list-style-type: none"> ▶ Adapt your driving style to the situation. ▶ Have the fault remedied as soon as possible at a qualified specialist workshop.³
<p style="text-align: center;">Brake pad worn pads</p> <p style="text-align: center;">Driving permitted</p>	<p>Brake pads are worn.</p> <p>Limited and adapted driving permitted.</p> <ul style="list-style-type: none"> ▶ Have the brake pads replaced at a qualified specialist workshop as soon as possible.³
<p style="text-align: center;">Brake booster failure</p> <p style="text-align: center;">– OR –</p> <p style="text-align: center;">Brake booster fault</p>	<p>Power steering has failed or is faulty.</p> <p>Stop the vehicle immediately in a suitable place.</p> <ul style="list-style-type: none"> ▶ Do not keep driving. Stop safely in a suitable place and switch off the vehicle. ▶ Call roadside assistance or have your vehicle towed. <ul style="list-style-type: none"> ▷ Please refer to chapter "Towing" on page 245. ▶ Have the fault remedied immediately at a qualified specialist workshop.³
<p>The online software update could not be carried out. This may result in functional restrictions. Please observe the warning and information lights and the Driver's Manual. Please consult your qualified specialist workshop to have the update carried out in full.</p>	<p>An update has failed. The vehicle's readiness for operation may be blocked, depending on the severity of the fault caused. Displays and vehicle functions cannot work correctly. The severity of the fault caused and its consequences are shown in the central display.</p> <ul style="list-style-type: none"> ▶ When the vehicle is ready for operation: Adapt your driving style to the situation. ▶ If the vehicle is not ready for operation: Call a roadside assistance service and have your vehicle towed. <ul style="list-style-type: none"> ▷ Please refer to chapter "Towing" on page 245. ▶ Have the fault remedied immediately at a qualified specialist workshop.³
<p style="text-align: center;">Intervention was</p>	<p>The intervention of a driver assistance system was aborted.</p>

3. Porsche recommends a Porsche partner as they have trained workshop personnel and the necessary parts and tools.

A	Message on the instrument cluster or central display	Meaning and action required
B		
C	aborted	Limited and adapted driving permitted.
D		<ul style="list-style-type: none"> ▶ Take over control of the vehicle.
E		<ul style="list-style-type: none"> ▶ Adapt your driving style to the situation.
F		<ul style="list-style-type: none"> ▷ Please refer to chapter "Vehicle settings" on page 257.
G	Chassis failure	Chassis has failed or is faulty.
H	Adapted driving permitted. See Driver's Manual.	Limited and adapted driving permitted.
I	– OR –	<ul style="list-style-type: none"> ▶ Adapt your driving style to the situation.
J	Chassis fault	<ul style="list-style-type: none"> ▶ Reduce load.
K	Adapted driving permitted. See Driver's Manual.	<ul style="list-style-type: none"> ▶ Have the fault remedied as soon as possible at a qualified specialist workshop.⁴
L		
M		
N		There is too much strain on the steering lock. Steering column is strained.
O	Move steering wheel	Adapted driving permitted.
P		<ul style="list-style-type: none"> ▶ Adapt your driving style to the situation.
Q		<ul style="list-style-type: none"> ▶ While the vehicle is stationary, relieve the steering lock by turning the steering wheel to the left or right.
R		
S		
T		
U	Opening the doors while the vehicle is moving not possible	The doors can lock automatically from a speed of approx. 15 km/h (9mph) and no longer be opened.
V	See Driver's Manual	<ul style="list-style-type: none"> ▶ Setting door locking options.
W		<ul style="list-style-type: none"> ▷ Please refer to chapter "Vehicle settings" on page 257.
X		
Y		
Z		
A	Parking brake in service mode	Parking brake is in service mode.
B		Limited and adapted driving permitted.
C		<ul style="list-style-type: none"> ▶ Adapt your driving style to the situation.
D		<ul style="list-style-type: none"> ▶ Have the fault remedied as soon as possible at a qualified specialist workshop.⁴
E		
F		
G	Intelligent location-based chassis failure	Intelligent location-based chassis failure.
H	See Driver's Manual	Limited and adapted driving permitted.
I		<ul style="list-style-type: none"> ▶ Adapt your driving style to the situation.
J		<ul style="list-style-type: none"> ▶ Reduce load.
K		<ul style="list-style-type: none"> ▶ Have the fault remedied as soon as possible at a qualified specialist workshop.⁴

4. Porsche recommends a Porsche partner as they have trained workshop personnel and the necessary parts and tools.

Message on the instrument cluster or central display	Meaning and action required
<p style="text-align: center;">Rain or light sensor faulty Inspection necessary</p>	<p>Rain/light sensor is defective.</p> <p>Adapted driving permitted.</p> <ul style="list-style-type: none"> ▶ Switch on windscreen wipers and lights manually. ▶ Have the fault remedied as soon as possible at a qualified specialist workshop.¹
<p style="text-align: center;">Tyre pressure too low Reduce speed</p>	<p>Speed for set tyre pressure has been exceeded.</p> <p>Adapted driving permitted.</p> <ul style="list-style-type: none"> ▶ Reduce speed. ▶ Set the correct tyre pressure at the next opportunity. <ul style="list-style-type: none"> ▷ Please refer to chapter "Tyres and Wheels" on page 249.
<p style="text-align: center;">Check tyres</p>	<p>Significant pressure loss in one or several tyres.</p> <p>Park the vehicle correctly and safely.</p> <ul style="list-style-type: none"> ▶ Do not keep driving. Stop safely in a suitable place and switch off the vehicle. ▶ Check the indicated tyre for damage. ▶ Add sealant if necessary. ▶ Set the correct tyre pressure at the next opportunity. <ul style="list-style-type: none"> ▷ Please refer to chapter "Tyres and Wheels" on page 249. ▷ Please refer to chapter "Flat Tyre" on page 114. ▶ If necessary, call roadside assistance and have your vehicle towed. <ul style="list-style-type: none"> ▷ Please refer to chapter "Towing" on page 245. ▶ Have the fault remedied immediately at a qualified specialist workshop.¹

1. Porsche recommends a Porsche partner as they have trained workshop personnel and the necessary parts and tools.

	Message on the instrument cluster or central display	Meaning and action required
B C D E F G	<p style="text-align: center;">Key not found</p> <p>Place the key in the storage compartment. See Driver's Manual</p>	<p>Key signal faulty. Key not detected due to wrong key position or flat battery in the driver's key.</p> <ul style="list-style-type: none"> ▶ Place the driver's key in the rear drinks holder in the central console. ▶ Replace battery. ▶ Switch off possible interference sources. <p>Please refer to chapter "Driver's Key" on page 104.</p>
H I J K L M N O P Q R S T U V	<p style="text-align: center;">Warn and Brake Assist limited</p> <p style="text-align: center;">See Driver's Manual</p>	<p>Warn and Brake Assist is limited or faulty.</p> <p>Limited and adapted driving permitted.</p> <ul style="list-style-type: none"> ▶ Adapt your driving style to the situation. ▶ Have the fault remedied as soon as possible at a qualified specialist workshop.¹
W		
X		
Y		
Z		

1. Porsche recommends a Porsche partner as they have trained workshop personnel and the necessary parts and tools.

Windows

Opening and closing side windows

⚠ WARNING

Opening and closing the side windows

When opening or closing the side windows, particularly in one-touch mode, parts of the body may get trapped between the moving side window and fixed vehicle parts.

- ▶ When opening and closing the side windows, make sure that no parts of the body can become trapped between the moving side window and fixed vehicle parts.
- ▶ Push the power button and switch off the vehicle when you leave the vehicle. Uninformed persons could injure themselves by operating the power windows.
- ▶ In the event of danger, immediately release the button on the driver's key or the proximity sensor in the door handle on vehicles with Comfort Access.
- ▶ Do not leave children in the vehicle unattended.

⚠ WARNING

Closing a side window manually

If one-touch operation has been disabled following blockage of a side window, the side window shuts with its full closing force during manual closing. Parts of the body that become trapped between the moving side window and fixed vehicle parts may be crushed.

- ▶ Make sure that nobody is trapped or crushed when closing the side windows.

i Information

If a side window is blocked by an object during closing, it will stop and open again by several centimetres.

If the side window is blocked a second time within approx. 10 seconds, one-touch operation will be disabled for this window. The side window can be closed manually. One-touch operation is enabled again once the side window has been closed completely using the manual closing function.

Opening and closing side windows

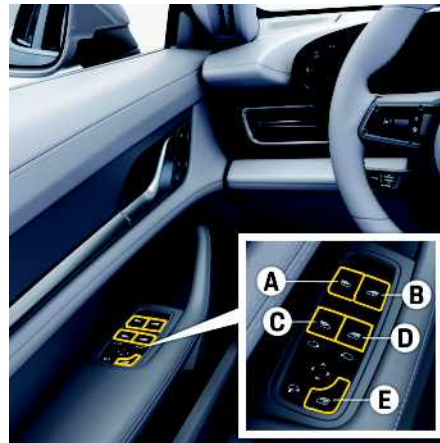

Fig. 220: Power window buttons in the driver's door

- A Power window, front, driver's side
- B Power window, front, passenger's side
- C Power window, rear, driver's side
- D Power window, rear, passenger's side
- E Child protection safety button

- ✓ Operational readiness established.
- or –
- ✓ The vehicle is turned off, but not for longer than 10 minutes.
- ✓ Driver's or passenger's door not yet opened.

The rocker switches have a **two-stage function**. When actuating the buttons, both positions can be clearly felt through resistance when pulling or pressing.

First setting – manual operation

- ▶ Press or pull the relevant rocker switch to the first setting until the desired position is reached. The process stops when the switch is released.

Second setting – one-touch operation

- ▶ Briefly push or pull the relevant rocker switch all the way to the second setting. The side window opens or closes automatically to the end position.
- ▶ Actuate the button again to stop the side window at the desired position.



The window closes faster during one-touch operation than during manual operation.

Opening and closing side windows with the driver's key



Fig. 221: Opening and closing side windows with the driver's key

✓ Function activated.

- ▶ Press and hold the  or  on the driver's key until the side window has reached the desired position.

The hazard warning lights flash twice when all side windows and the roof system have closed.

The function can be activated or deactivated in the central display.

- ▶  ▶ **Setting**  ▶ **Vehicle** ▶ **Vehicle locking system** ▶ **Comfort access**

Closing side windows with the proximity sensor in the door handle

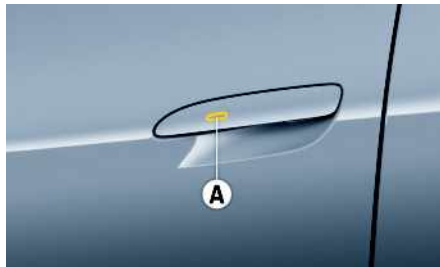

Fig. 222: Comfort Access

- ✓ Vehicles with Comfort Access.
 - ✓ Carry the driver's key with you, such as in your trouser pocket.
 - ▶ Touch proximity sensor **A** in the door handle when locking the vehicle until the desired position has been reached.
- The hazard warning lights flash twice when all side windows and the roof system have closed.

Storing the end position of side windows

The end positions of the side windows will be lost if the 12 V power supply fails. One-touch operation of the side windows is disabled.

Perform these steps for all side windows:

1. Close side the window completely once by pulling the rocker switch to the second setting.
2. When the side window is completely closed, briefly pull the rocker switch to the second setting again.
3. Completely open the side window once by pressing the rocker switch.

Disabling controls in the rear – child protection

The power window buttons on the rear doors and the rear passenger touch screen can be disabled by pressing the safety button **E** in the control panel on the driver's door.

Switching child protection on/off

- ▶ Press the safety button **E**.
The indicator light on the button comes on.
The rear power window buttons in the rear doors and the rear display are deactivated.

Windscreen Wiper

General safety instructions



WARNING

Unintended wiping

In rain sensor mode, the windscreen wipers wipe automatically if moisture is detected on the windscreen.

- ▶ Always switch off the windscreen wipers before cleaning the windscreen.

NOTICE

Risk of damage to luggage compartment lid, windscreen and wiper system.

- ▶ Only wipe the windscreen when sufficiently wet, otherwise it could become scratched.
- ▶ Carefully detach frozen wiper blades from the windscreen before driving.
- ▶ Always switch off windscreen wipers in car washes to prevent them wiping unintentionally (rain sensor operation).

Responding to warning messages

Always heed any warning and information messages displayed in the vehicle.

- ▶ Please refer to chapter "Warning and information messages" on page 271.

Controls



Fig. 223: Windscreen wiper stalk

- 0 Windscreen wipers off
- 1 Rain sensor operation
- 2 Slow wiping
- 3 Fast wiping
- 4 Wiping with one-touch function
- 5 Spray and wipe

Switching on rain sensor operation

In rain sensor mode, the speed of the windscreen wipers depends on the quantity of water measured on the windscreen.

- ▶ Move the wiper stalk upwards to the first detent (position 1).
The rain sensor operation is active.

Adjusting the rain sensor sensitivity

By adjusting the sensitivity in 4 stages, it is possible to determine what water quantity on the windscreen will trigger the next wiper operation.



Fig. 224: Switch for rain sensor/intermittent operation

High sensitivity (more frequent wiping)

- ▶ Move switch (A) upwards.
The setting is confirmed by one wipe of the windscreen.

Low sensitivity (more infrequent wiping)

- ▶ Press switch (A) downwards.

Switching on continuous wiping

Slow wiping

- ▶ Move wiper stalk upwards to the second detent (position 2).

Fast wiping

- ▶ Move wiper stalk upwards to the third detent (position 3).

Wiping with one-touch function

One-time wiping

- ▶ Briefly press the wiper stalk downwards (position 4).

Multiple wiping

- ▶ Press and hold the wiper stalk downwards (position 4).

Spraying and wiping

- ▶ Pull wiper stalk towards the steering wheel. Spray nozzles and windscreen wipers are active as long as the wiper stalk is held.

When the wiper stalk is released, the windscreen wipers continue to perform a few drying wipes.

Switching the windscreen wipers off

- ▶ Move the wiper stalks to position 0.

Information

After switching off the windscreen wipers or operational readiness, the wipers move up slightly from their rest position so that the wiping edges are aligned correctly.

Replacing wiper blades



CAUTION

Incorrectly fitted wiper blades

If they are not changed properly, the incorrectly fitted wiper blades can come loose while driving.

- ▶ The wiper blades must latch properly in the wiper arm.
- ▶ Check that the wiper blades are fitted securely.

NOTICE

If the wiper arms accidentally fall back onto the windscreen, they can damage the windscreen.

- ▶ Always hold the wiper arms securely when replacing the wiper blades.

It is essential for wiper blades to be in perfect condition for a clear view. The wiper blades should be replaced twice a year (before and after the cold season) or if wiper performance deteriorates or the blades are damaged.

Replacing front wiper blades

The windscreen wipers must be extended to replace the wiper blades or fit ice or sun protective covers underneath.

Extending the windscreen wipers

- ✓ Switch off readiness for operation.
 - 1. Press the wiper lever **downwards** once (position 4).
The windscreen wipers move upwards by approx. 90°.
 - 2. Replace the wiper blades according to the separate instructions provided by the manufacturer.
- Note the different lengths of the wiper blades!**

Retracting the windscreen wipers

- ✓ Switch on readiness for operation.
- ▶ Press the wiper lever **downwards** for at least 2 seconds (position 4).
The windscreen wipers return to their home position.

Information

Get a qualified specialist workshop to carry out this work if necessary. Porsche recommends a Porsche partner as they have trained workshop personnel and the necessary parts and tools.

Cleaning the Night View Assist and reversing cameras

- ▶ Please refer to chapter "Night View Assist" on page 171.
- ▶ Please refer to chapter "ParkAssist" on page 176.

Additional information

Wiper behaviour when operational readiness has been established.

- The wiper stalk is in position **1**: The rain sensor is activated from 4 km/h (2.5 mph).
- The wiper stalk is in position **2** or **3**: The windscreen wipers remain off until the wiper stalk is actuated.

For example, this prevents the wipers from wiping an ice-covered windscreen as soon as operational readiness is established.

Wiper behaviour when the speed is changed

- ✓ The wiper stalk is in position **2** or **3**.
- At speeds below 4 km/h (2.5 mph): The wipers switch to rain sensor operation.
- The speed increases above 12 km/h (8 mph): The wipers switch to the selected setting.

Application example: When braking at traffic lights, the wipers switch to rain sensor operation. When the vehicle accelerates, the wipers switch to the selected setting from 12 km/h (8 mph).

i Information

The wipers stop when the bonnet is opened.

- ▶ To switch on the windscreen wipers again, move the windscreen wiper stalk upwards/downwards.
-

A
B
C
D
E
F
G
H
I
J
K
L
M
N
O
P
Q
R
S
T
U
V
W
X
Y
Z

12-volt battery

General safety instructions

The 12-volt lithium battery is automatically disconnected from the vehicle electrical system if the battery charge condition is low. The vehicle cannot be operated if the 12 V lithium battery is discharged. The electrical system is deactivated temporarily.

- ▶ Observe warning message.

To charge the 12 V lithium battery:

- ▶ Establish operational readiness.
 - ▷ Please refer to chapter "Starting, driving and stopping the vehicle" on page 236.
- or –
- ▶ Charging the 12 V battery using the charger.
 - or –
- ▶ Supply external power from another vehicle for at least 5 minutes. Then establish operational readiness or charge the 12 V battery using a charger.

After establishing operational readiness and when the battery is charged (for at least 10 minutes) or when the vehicle has been connected to an external power supply, the electrical system is reactivated automatically. The 12-volt lithium battery is automatically reconnected to the vehicle electrical system.

Another vehicle's battery can be used as an external power supply with the help of jump leads. Both batteries must have a nominal voltage of 12 V. The capacity (Ah) of the donor battery must not be substantially less than that of the flat battery. The flat 12 V lithium battery must be connected properly to the vehicle electrical system.

The need to repeatedly provide power from a power supply or repeated charging of the 12 V lithium battery under normal operating conditions may indicate that the 12 V lithium battery is damaged.

- ▶ Never connect jump leads or a the charger directly to the 12 V lithium battery.

WARNING

Electric shock, short circuit, fire or explosion

Touching conductive parts of the vehicle can give you an electric shock. You can cause a short circuit when working on the vehicle's electrical system. Short circuits can cause fires.

- ▶ The battery should only be removed and installed or have work performed on it at a qualified specialist workshop. Porsche recommends a Porsche partner as they have trained workshop personnel and the necessary parts and tools.

WARNING

Escaping electrolyte fluid and toxic gases

Risk of electrolyte fluid and toxic gases escaping in exceptional cases if the 12 V lithium battery is damaged or handled incorrectly.

- ▶ Avoid any inhalation of the vapours and any skin contact with the electrolyte fluid.
- ▶ Keep people away and stay on the side facing into the wind.
- ▶ The 12 V lithium battery should only be charged in well-ventilated areas.

NOTICE

Risk of short circuit, fire and damage to electronic control units and components.

- ▶ The battery should only be removed or installed by a qualified specialist workshop. Porsche recommends a Porsche partner as they have trained workshop personnel and the necessary parts and

tools.

- ▶ Disconnect the negative terminal on the battery during all work on the electrical system.

The 12 V lithium battery is located under a plastic cover in the front luggage compartment. Please refer to chapter "Installing and removing the plastic cover in the front luggage compartment" on page 155.

Safety symbols on the 12 V lithium battery



Read instructions



Wear eye protection



Danger of explosion



Fire, sparks, naked flames and smoking are prohibited

Avoid causing sparks and short circuits when handling cables and electrical devices.



Danger of caustic burns

Electrolyte fluid is highly corrosive: wear safety gloves and eye protection.

First aid

If electrolyte fluid splashes into your eye, rinse immediately for a few minutes with clean water. Immediately seek medical attention from a doctor. If electrolyte fluid splashes onto your skin or clothing, neutralise immediately with soapsuds and rinse with plenty of water. If you accidentally drink electrolyte fluid, consult a doctor immediately.

Keep children away





Disposal

Hand in the old battery at a battery collection point.



Never dispose of an old battery with domestic waste.



Always have maintenance work carried out by qualified technicians

Never attempt to replace the 12 V lithium battery yourself. The 12 V lithium battery of this vehicle must only be replaced with a 12 V lithium battery explicitly specified by Porsche for this vehicle. The use of other 12 V lithium or lead-acid batteries will result in considerable malfunctions, including total failure of the electrical system.

Always have the 12 V lithium battery replaced by a qualified specialist workshop. Porsche recommends a Porsche partner as they have trained workshop personnel and the necessary parts and tools.

12 V lithium battery

What do I want to do?	What do I have to do?
Avoid running down the battery	<ul style="list-style-type: none"> ▶ Switch off unneeded electrical loads on short trips.
Prepare for winter driving	<ul style="list-style-type: none"> ▶ Have the 12 V lithium battery checked before the start of winter.

What do I want to do?	What do I have to do?
Charging the 12 V lithium battery	<ul style="list-style-type: none"> ▶ Never charge a damaged 12 V lithium battery.
Lay up the vehicle	<ul style="list-style-type: none"> ▶ If the vehicle is left for long periods in the garage or workshop, the doors and lids of the vehicle should be closed. ▶ Turn off the vehicle.

i Information

The 12 V lithium battery still discharges even when your vehicle is not in use.

- ▶ To maintain its function, charge the 12 V lithium battery approximately every 6 weeks or connect it to a trickle charger suitable for lithium batteries with a CC/CV or pure CV characteristic. Porsche recommends Porsche Tequipment chargers and trickle chargers.

Charging the 12 V battery using the charger

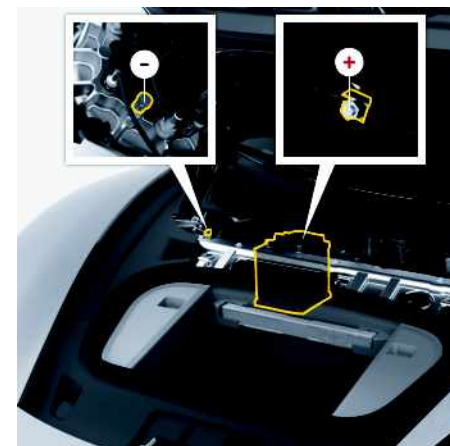

Fig. 225: 12 V lithium battery terminals

⚠ CAUTION

Escaping irritating gases due to a damaged 12 V lithium battery

The use of non-approved chargers or boosters can result in the 12 V lithium battery being charged with excessive charging voltage and excessive charging current. This can damage the 12 V lithium battery, and irritating gases can escape. This can cause considerable damage to the vehicle and burns.

- ▶ Only use chargers or boosters that have been approved by the equipment manufacturer for LiFePO₄ batteries with integrated electronic protection circuits.
- ▶ The following maximum values must never be exceeded:

A
B
C
D
E
F
G
H
I
J
K
L
M
N
O
P
Q
R
S
T
U
V
W
X
Y
Z

- Max. charging voltage: 14.8 V (even in the event of a fault with the 12 V lithium battery disconnected; no voltage peaks permitted)
- Max. charging current: 90 A

- ▶ If in doubt, contact your Porsche partner.
-
- ▶ Observe the instructions of the charger manufacturer.
 - ▶ Ensure adequate ventilation when charging the 12 V lithium battery.
1. Open the bonnet.
 - ▷ Please refer to chapter "Opening and closing the bonnet and tailgate" on page 153.
 2. Remove the plastic cover. Please refer to chapter "Installing and removing the plastic cover in the front luggage compartment" on page 155.
 3. Fold open the cap on the positive terminal for jump-lead starting +.
 4. Connect the red positive cable of the charger to the positive terminal for jump-lead starting +.
 5. Connect the black **negative cable** of the charger to the ground point -.
 6. Switch on the charger.
 7. After charging the battery, first switch off the charger and then disconnect it.
 8. Close the cap on the positive terminal for jump-lead starting +.
 9. Install the plastic cover. Please refer to chapter "Installing and removing the plastic cover in the front luggage compartment" on page 155.

For recommendations on a suitable charger:

- ▶ Contact your Porsche partner.

Supplying external power from another vehicle

WARNING Unsuitable jump leads and incorrect procedures

Supplying external power using unsuitable jump leads or following incorrect procedures can cause short circuits. Short circuits can cause fires.

- ▶ Use only standard jump leads with sufficient cross section and completely insulated terminal clamps. Follow the instructions provided by the jump lead manufacturer.
- ▶ The vehicles must not touch, otherwise current may flow as soon as the positive terminals are connected.
- ▶ Ensure that conductive jewellery (e.g. rings, chains, watch straps) does not come into contact with live parts of the vehicle.
- ▶ Never connect jump leads directly to the 12 V lithium battery or other electrical components. Only connect jump leads to the jump-lead starting terminals.

NOTICE Exhaustively discharged 12 V lithium battery

Risk of damage when supplying external power to an exhaustively discharged 12 V lithium battery.

- ▶ If you suspect that the 12 V lithium battery is exhaustively discharged, do not supply power from an external source.

NOTICE

External power supply or emergency starting

Emergency starting and supplying external power can severely damage the vehicle electronics.

- ▶ Do not supply external power or initiate emergency starting.
- ▶ Contact a qualified specialist workshop. Porsche recommends a Porsche partner as they have trained workshop personnel and the necessary parts and tools.

1. Open the bonnet. Please refer to chapter "Perform emergency unlocking of the bonnet" on page 58.
2. Remove the plastic cover. Please refer to chapter "Installing and removing the plastic cover in the front luggage compartment" on page 155.

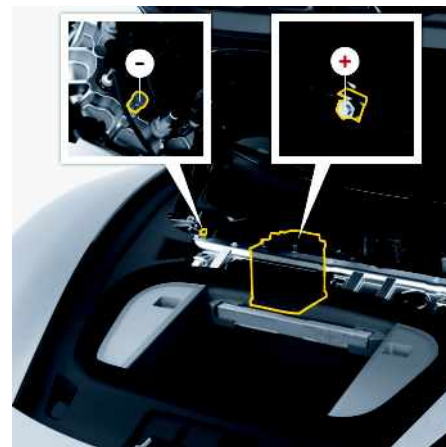

Fig. 226: 12 V lithium battery terminals

3. Fold open the cap on the positive terminal for jump-lead starting +.
4. Connect the red positive cable to the positive terminal for jump-lead starting +.
5. Connect the red positive cable to the positive terminal of the donor battery.
6. Connect the black **negative cable** to the negative terminal of the donor battery.
7. Connect the black negative cable to the ground point–.
8. Allow the engine of the donor vehicle to run at a higher engine speed.
9. Charge the 12 V lithium battery from the external power supply (min. 5 minutes).
The electrical system is reactivated automatically.
10. Ready for operation:
First, disconnect the black negative cable from the ground point – then from the negative terminal of the donor battery.
11. Ready for operation:
Disconnect the red positive cable from the positive terminal of the donor battery first, then from the positive terminal for jump-lead starting +.
12. Close the cap on the positive terminal for jump-lead starting +.
13. Install the plastic cover. Please refer to chapter "Installing and removing the plastic cover in the front luggage compartment" on page 155.
14. To continue charging the 12 V lithium battery:
Charge the 12 V lithium battery using the charger. Please refer to chapter "Charging the 12 V battery using the charger" on page 283.
– or –
Establish operational readiness. Please refer to chapter "Starting, driving and stopping the vehicle" on page 236.

Replacing the 12 V lithium battery



WARNING

Danger of fire due to unsuitable 12 V lithium battery

In addition to significant malfunctions of the vehicle electrical system, use of an unsuitable 12 V lithium battery or its incorrect installation may in exceptional cases cause a fire (e.g. during charging).

- ▶ Never attempt to replace the 12 V lithium battery yourself. Only have the 12 V lithium battery of this vehicle replaced with a 12 V lithium battery explicitly specified by Porsche for this vehicle. The use of other lithium or lead-acid batteries results in significant malfunctions including total failure of the electrical system.
- ▶ Always have the 12 V lithium battery replaced by a qualified specialist workshop. Porsche recommends a Porsche partner as they have trained workshop personnel and the necessary parts and tools.
- ▶ Observe the disposal instructions for lithium batteries.

Power interruption

Following a temporary power interruption, some equipment has to be reinitialised.

1. Store the end position for the power windows.
 - ▷ Please refer to chapter "Windows" on page 277.
2. Registering wheels and tyres in Tyre Pressure Monitoring (TPM).
 - ▷ Please refer to chapter "Tyres and Wheels" on page 249.

Technical Data

On the following pages, you will find the technical data for your vehicle.

Software licences

Declaration on open source software for the instrument cluster - list of OSS components

The instrument cluster contains components that are licensed as open source software. The affected components and the associated licence conditions are listed below. The licensee receives a non-exclusive right of use for the open source software from the respective copyright holders under the conditions that provide for the relevant valid licence conditions. The liability and warranty provisions of open source licences are only valid in relation to the respective copyright holders. This list of open source program codes was compiled by reference to the third-party software that was integrated into the services at the time the list was created.

Open Source	Licence	Copyright
AArch64 UEFI bootstraps	BSD-3-Clause	Copyright (c) 2011-2013 ARM Limited
aarongifford-sha2 1.1	BSD-3-Clause	Copyright (c) 2000-2001, Aaron D. Gifford
Boost 1.64.0	BSL-1.0	Copyright (c) 2003-2017 Christopher M. Kohlhoff. Copyright (c) 2013-2017 Louis Dionne. Copyright (c) 2001-2011 Joel de Guzman.
colorama 0.3.3	BSD-3-Clause	Copyright (c) 2010 Jonathan Hartley.
Crypto++	BSL-1.0	Copyright (c) 1995-2013 by Wei Dai.
CVTUTF	Unicode-TOU	Copyright 2001-2004 Unicode, Inc.
DejaVu fonts	DejaVu Fonts Licence	
Dinkum C++ 11 Libraries	MIT-like Licence (Dinkum C++ 11 Libraries)	Dinkum C++ Library developed by P.J. Plauger. Dinkum C++ Library Reference developed by P.J. Plauger.
dtc-libfdt	BSD-2-Clause	Copyright (C) 2006 David Gibson, IBM Corporation.
edk2	BSD-2-Clause	Copyright (c) 2004 - 2016, Intel Corporation. Copyright (c) 2008 - 2010, Apple Inc. Copyright (c) 2011 - 2015, ARM Limited.

Open Source	Licence	Copyright
		Copyright (c) 2014 - 2015, Linaro Limited. Copyright (c) 2013 - 2015, Red Hat, Inc.
edk2-FatPkg	BSD-like licence (EFI/UEFI)	Copyright (c) 2006, Intel Corporation.
freetype 2.6	FTL	Copyright (c) 2006-2015 by David Turner, Robert Wilhelm and Werner Lemberg.
HarfBuzz 0.9.35	MIT-like Licence (HarfBuzz)	Copyright (c) 2010, 2011, 2012, Google, Inc. Copyright (c) 2012, Mozilla Foundation. Copyright (c) 2011, Codethink Limited. Copyright (c) 2008, 2010, Nokia Corporation and/or its subsidiary/subsidiaries. Copyright (c) 2009, Keith Stribley. Copyright (c) 2009, Martin Hosken and SIL International. Copyright (c) 2007, Chris Wilson. Copyright (c) 2006, Behdad Esfahbod. Copyright (c) 2005, David Turner. Copyright (c) 2004, 2007, 2008, 2009, 2010, Red Hat, Inc. Copyright (c) 1998-2004, David Turner and Werner Lemberg.
icu 52.1	ICU	Copyright (c) 1995-2010 International Business Machines Corporation and others
jpeg 9a	IJG	Copyright (c) 1991-1994, Thomas G. Lane. Copyright (c) 1989, 2000 Aladdin Enterprises.
Json.NET	MIT	Copyright (c) 2007 James Newton-King.
libGD	MIT-like Licence (libgd)	
libpng 1.6.21	Libpng	Copyright (c) 1998-2002, 2004, 2006-2016 Glenn Randers-Pehrson.

Open Source	Licence	Copyright
libpng 1.6.12	Libpng	Copyright (c) 2004, 2006-2009 Glenn Randers-Pehrson.
libunibreak 4.0	Zlib	Copyright (c) 2008-2016 Wu Yongwei. Copyright (c) 2012-2016 Tom Hacoen. Copyright (c) 2013 Petr Filipisky. Copyright (c) 2016 Andreas Röver.
LK	MIT	Copyright (c) 2008-2015 Travis Geiselbrecht.
musl-libc 1.1.5	BSD-2-Clause BSD-like Licence (musl)	Copyright (c) 2005-2014 Rich Felker, et al. Copyright (c) 2005 Bruce D. Evans and Steven G. Kargl. Copyright (c) 2001-2009 Ville Laurikari. Copyright (C) 1993 by Sun Microsystems, Inc.
OpenGL	MIT	Copyright (c) 2013-2017 The Khronos Group Inc.
OpenGL-ES 2.0	MIT SGI-B-2.0	Copyright (c) 2013-2017 The Khronos Group Inc.
OpenMAX IL 1.1.2	MIT	
openssl	OpenSSL	Copyright (c) 1998-2017 The OpenSSL Project. Copyright (C) 1995-1998 Eric Young.
PCCTS 1.33	MIT-like Licence (PCCTS)	
QNX BSP	Apache-2.0	Copyright (c) 2007, QNX Software Systems.
RFC 1321	RSA-MD	Copyright (C) 1991-2, RSA Data Security, Inc. Created 1991.
SCons 2.0.0.	MIT	Copyright (c) 2001, 2002, 2003, 2004, 2005, 2006, 2007, 2008, 2009, 2010 The SCons Foundation.

Open Source	Licence	Copyright
Synopsys DWC ETHER QOS Software Driver	MIT-like Licence (Synopsys DWC ETHER QOS Software Driver)	
Uthash	BSD-like Licence (Uthash)	Copyright (c) 2005-2016, Troy D. Hanson http://troydhanson.github.com/uthash/
v8 3.28.35	BSD-3-Clause	Copyright (c) 2006-2011, the V8 project authors.
xmltodict	MIT	Copyright (c) 2012 Martin Blech and individual contributors.
zlib 1.2.8	Zlib	Copyright (c) 1995-2013 Jean-loup Gailly and Mark Adler.
—	BSD-3-Clause	Copyright (c) 2012-2015, The Linux Foundation.

FAT 32 File System Driver과 관련하여 인텔의 EFI Specification과 UEFI Forum의 UEFI Specification의 implementation을 emulate 하는 경우, firmware, application, utility, driver 작성 등에서만 사용할 수 있음

The code is conditioned upon the FAT 32 File System Driver and only as necessary to emulate an implementation of the UEFI Specifications; and to create firmware, applications, utilities and/or drivers. This software is based in part on the work of the Independent JPEG Group.

This product includes software developed by the OpenSSL Project for use in the OpenSSL Toolkit. (<http://www.openssl.org/>).

Apache-2.0

Copyright [yyyy] [name of copyright owner]
Licensed under the Apache Licence, Version 2.0 (the "Licence"); you may not use this file except in compliance with the Licence. You may obtain a copy of the Licence at <http://www.apache.org/licenses/>

LICENSE-2.0. Unless required by applicable law or agreed to in writing, software distributed under the Licence is distributed on an "AS IS" BASIS, WITHOUT WARRANTIES OR CONDITIONS OF ANY KIND, either express or implied. See the Licence for the specific language governing permissions and limitations under the Licence.

BSD-2-Clause

Redistribution and use in source and binary forms, with or without modification, are permitted provided that the following conditions are met:

1. Redistributions of source code must retain the above copyright notice, this list of conditions and the following disclaimer.
2. Redistributions in binary form must reproduce the above copyright notice, this list of conditions and the following disclaimer in the documentation and/or other materials provided with the distribution.

THIS SOFTWARE IS PROVIDED BY THE COPYRIGHT HOLDERS AND CONTRIBUTORS "AS IS", AND ANY

EXPRESS OR IMPLIED WARRANTIES, INCLUDING, BUT NOT LIMITED TO, THE IMPLIED WARRANTIES OF MERCHANTABILITY AND FITNESS FOR A PARTICULAR PURPOSE ARE DISCLAIMED. UNDER NO CIRCUMSTANCES SHALL THE COPYRIGHT HOLDER OR CONTRIBUTORS BE LIABLE FOR ANY DIRECT, INDIRECT, INCIDENTAL, SPECIAL, EXEMPLARY OR CONSEQUENTIAL DAMAGES (INCLUDING, BUT NOT LIMITED TO, PROCUREMENT OF SUBSTITUTE GOODS OR SERVICES; LOSS OF USE, DATA OR PROFITS; OR BUSINESS INTERRUPTION) HOWEVER CAUSED AND ON ANY THEORY OF LIABILITY, WHETHER IN CONTRACT, STRICT LIABILITY OR TORT (INCLUDING NEGLIGENCE OR OTHERWISE) ARISING IN ANY WAY OUT OF THE USE OF THIS SOFTWARE, EVEN IF ADVISED OF THE POSSIBILITY OF SUCH DAMAGE.

BSD-3-Clause

Redistribution and use in source and binary forms, with or without modification, are permitted provided that the following conditions are met:

1. Redistributions of source code must retain the above copyright notice, this list of conditions and the following disclaimer.
2. Redistributions in binary form must reproduce the above copyright notice, this list of conditions and the following disclaimer in the documentation and/or other materials provided with the distribution.
3. Neither the name of the copyright holder nor the names of its contributors may be used to endorse or promote products derived from this software without specific prior written permission.

THIS SOFTWARE IS PROVIDED BY THE COPYRIGHT HOLDERS AND CONTRIBUTORS "AS IS", AND ANY EXPRESS OR IMPLIED WARRANTIES, INCLUDING, BUT NOT LIMITED TO, THE IMPLIED WARRANTIES OF MERCHANTABILITY AND FITNESS FOR A PARTICULAR PURPOSE ARE DISCLAIMED. UNDER NO CIRCUMSTANCES SHALL THE COPYRIGHT HOLDER OR CONTRIBUTORS BE LIABLE FOR ANY DIRECT, INDIRECT, INCIDENTAL, SPECIAL, EXEMPLARY OR CONSEQUENTIAL DAMAGES (INCLUDING, BUT NOT LIMITED TO, PROCUREMENT OF SUBSTITUTE GOODS OR SERVICES; LOSS OF USE, DATA OR PROFITS; OR BUSINESS INTERRUPTION) HOWEVER CAUSED AND ON ANY THEORY OF LIABILITY, WHETHER IN CONTRACT, STRICT LIABILITY OR TORT (INCLUDING NEGLIGENCE OR OTHERWISE) ARISING IN ANY WAY OUT OF THE USE OF THIS SOFTWARE, EVEN IF ADVISED OF THE POSSIBILITY OF SUCH DAMAGE.

BSD-like Licence (Uthash)

Redistribution and use in source and binary forms, with or without modification, are permitted provided that the following conditions are met:

* Redistributions of source code must retain the above copyright notice, this list of conditions and the following disclaimer.

THIS SOFTWARE IS PROVIDED BY THE COPYRIGHT HOLDERS AND CONTRIBUTORS "AS IS", AND ANY EXPRESS OR IMPLIED WARRANTIES, INCLUDING, BUT NOT LIMITED TO, THE IMPLIED WARRANTIES OF MERCHANTABILITY AND FITNESS FOR A PARTICULAR PURPOSE ARE DISCLAIMED. UNDER NO CIRCUMSTANCES SHALL THE COPYRIGHT OWNER OR CONTRIBUTORS BE LIABLE FOR ANY DIRECT, INDIRECT, INCIDENTAL, SPECIAL, EXEMPLARY OR CONSEQUENTIAL DAMAGES (INCLUDING, BUT NOT LIMITED TO, PROCUREMENT OF SUBSTITUTE GOODS OR SERVICES; LOSS OF USE, DATA OR PROFITS; OR BUSINESS INTERRUPTION) HOWEVER CAUSED AND ON ANY THEORY OF LIABILITY, WHETHER IN CONTRACT, STRICT LIABILITY OR TORT (INCLUDING NEGLIGENCE OR OTHERWISE) ARISING IN ANY WAY OUT OF THE USE OF THIS SOFTWARE, EVEN IF ADVISED OF THE POSSIBILITY OF SUCH DAMAGE.

BSD-like Licence (musl)

Copyright (C) 1993 by Sun Microsystems, Inc. All rights reserved.

Developed at SunPro, a Sun Microsystems, Inc. business. Permission to use, copy, Pehrson andri-
bute this software is freely granted, provided that this notice is preserved.

BSD-like licence (EFI/UEFI)

Redistribution and use in source and binary forms, with or without modification, are permitted provided that the following conditions are met:

. Redistributions of source code must retain the above copyright notice, this list of conditions and the following disclaimer.

. Redistributions in binary form must reproduce the above copyright notice, this list of conditions and the following disclaimer in the documentation and/or other materials provided with the distribution.

. Redistributions in binary form must reproduce the above copyright notice, this list of conditions and the following disclaimer in the documentation and/or other materials provided with the distribution.

THIS SOFTWARE IS PROVIDED BY THE COPYRIGHT HOLDERS AND CONTRIBUTORS "AS IS", AND ANY EXPRESS OR IMPLIED WARRANTIES, INCLUDING, BUT NOT LIMITED TO, THE IMPLIED WARRANTIES OF MERCHANTABILITY AND FITNESS FOR A PARTICULAR PURPOSE ARE DISCLAIMED. UNDER NO CIRCUMSTANCES SHALL THE COPYRIGHT OWNER OR CONTRIBUTORS BE LIABLE FOR ANY DIRECT, INDIRECT, INCIDENTAL, SPECIAL, EXEMPLARY OR CONSEQUENTIAL DAMAGES (INCLUDING, BUT NOT LIMITED TO, PROCUREMENT OF SUBSTITUTE GOODS OR SERVICES; LOSS OF USE, DATA OR PROFITS; OR BUSINESS INTERRUPTION) HOWEVER CAUSED AND ON ANY THEORY OF LIABILITY, WHETHER IN CONTRACT, STRICT LIABILITY OR TORT (INCLUDING NEGLIGENCE OR OTHERWISE) ARISING IN ANY WAY OUT OF THE USE OF THIS SOFTWARE, EVEN IF ADVISED OF THE POSSIBILITY OF SUCH DAMAGE.

Additional terms: In addition to the forgoing, redistribution and use of the code is conditioned upon the FAT 32 File System Driver and all derivative works thereof being used for and designed only to read and/or write to a file system that is directly managed by Intel's Extensible Firmware Initiative (EFI) Specification v. 1.0 and later and/or the Unified Extensible Firmware Interface (UEFI) Forum's UEFI Specifications v.2.0 and later (together the "UEFI Specifications"); only as necessary to emulate an implementation of the UEFI Specifications; and to create firmware, applications, utilities and/or drivers.

BSL-1.0

Boost Software Licence - Version 1.0 - 17th August, 2003

Permission is hereby granted, free of charge, to any person or organisation obtaining a copy of the software and accompanying documentation covered by this licence (the "Software") to use, reproduce, display, distribute, execute and transmit the Software, and to prepare derivative works of the Software, and to permit third-parties to whom the Software is furnished to do so, all subject to the following:

The copyright notices in the Software and this entire statement, including the above licence grant, this restriction and the following disclaimer, must be included in all copies of the Software, in whole or in part, and all derivative works of the Software, unless such copies or derivative works are solely in the form of machine-executable object code generated by a source language processor. THE SOFTWARE IS PROVIDED "AS IS", WITHOUT WARRANTY OF ANY KIND, EXPRESS OR IMPLIED, INCLUDING BUT NOT LIMITED TO THE WARRANTIES OF MERCHANTABILITY, FITNESS FOR A PARTICULAR PURPOSE, TITLE AND NON-INFRINGEMENT. UNDER NO CIRCUMSTANCES SHALL THE COPYRIGHT HOLDERS OR ANYONE DISTRIBUTING THE SOFTWARE BE LIABLE FOR ANY DAMAGES OR OTHER LIABILITY, WHETHER IN CONTRACT, TORT OR OTHERWISE, ARISING FROM, OUT OF OR IN CONNECTION WITH THE SOFTWARE OR THE USE THEREOF OR OTHER DEALINGS IN THE SOFTWARE.

DejaVu Fonts Licence

Fonts are © Bitstream (see below). DejaVu changes are in public domain. Explanation of copyright is on Gnome page on Bitstream Vera fonts. Glyphs imported from Arev fonts are © Tavmjong Bah (see below)

Bitstream Vera Fonts Copyright

Copyright (c) 2003 by Bitstream, Inc. All Rights Reserved. Bitstream Vera is a trademark of Bitstream, Inc.

Permission is hereby granted, free of charge, to any person obtaining a copy of the fonts accompanying this licence ("Fonts") and associated documentation files (the "Font Software"), to reproduce and distribute the Font Software, including without limitation the rights to use, copy, merge, publish, distribute and/or sell copies of the Font Software, and to permit persons to whom the Font Software is furnished to do so, subject to the following conditions:

The above copyright and trademark notices and this permission notice shall be included in all copies of one or more of the Font Software typefaces.

The Font Software may be modified, altered or supplemented, and in particular the designs of glyphs or characters in the Fonts may be modified and additional glyphs or characters may be added to the Fonts, only if the fonts are renamed to names not containing either the words "Bitstream" or the word "Vera".

This Licence becomes null and void to the extent applicable to Fonts or Font Software that has been modified and is distributed under the "Bitstream Vera" names.

The Font Software may be sold as part of a larger software package, but no copy of one or more of the Font Software typefaces may be sold by itself.

THE FONT SOFTWARE IS PROVIDED "AS IS", WITHOUT WARRANTY OF ANY KIND, EXPRESS OR IMPLIED, INCLUDING BUT NOT LIMITED TO ANY WARRANTIES OF MERCHANTABILITY, FITNESS FOR A PARTICULAR PURPOSE AND NON-INFRINGEMENT OF COPYRIGHT, PATENT, TRADE-MARK OR OTHER RIGHT. UNDER NO CIRCUMSTANCES SHALL BITSTREAM OR THE GNOME FOUNDATION BE LIABLE FOR ANY CLAIM, DAMAGES OR OTHER LIABILITY, INCLUDING ANY

GENERAL, SPECIAL, INDIRECT, INCIDENTAL OR CONSEQUENTIAL DAMAGES, WHETHER IN AN ACTION OF CONTRACT, TORT OR OTHERWISE, ARISING FROM, OUT OF THE USE OR INABILITY TO USE THE FONT SOFTWARE OR FROM OTHER DEALINGS IN THE FONT SOFTWARE.

Except as contained in this notice, the names of Gnome, the Gnome Foundation and Bitstream Inc., shall not be used in advertising or otherwise to promote the sale, use or other dealings in this Font Software without prior written authorisation from the Gnome Foundation or Bitstream Inc., respectively. For more information, contact: fonts@gnome.org.

Arev Fonts Copyright

Original text

Copyright (c) 2006 by Tavmjong Bah. All Rights Reserved.

Permission is hereby granted, free of charge, to any person obtaining a copy of the fonts accompanying this licence ("Fonts") and associated documentation files (the "Font Software"), to reproduce and distribute the modifications to the Bitstream Vera Font Software, including without limitation the rights to use, copy, merge, publish, distribute and/or sell copies of the Font Software, and to permit persons to whom the Font Software is furnished to do so, subject to the following conditions:

The above copyright and trademark notices and this permission notice shall be included in all copies of one or more of the Font Software typefaces.

The Font Software may be modified, altered or supplemented, and in particular the designs of glyphs or characters in the Fonts may be modified and additional glyphs or characters may be added to the Fonts, only if the fonts are renamed to names not containing either the words "Tavmjong Bah" or the word "Arev".

This Licence becomes null and void to the extent applicable to Fonts or Font Software that has been modified and is distributed under the "Tavmjong Bah Arev" names.

The Font Software may be sold as part of a larger software package, but no copy of one or more of the Font Software typefaces may be sold by itself.

THE FONT SOFTWARE IS PROVIDED "AS IS", WITHOUT WARRANTY OF ANY KIND, EXPRESS OR IMPLIED, INCLUDING BUT NOT LIMITED TO ANY WARRANTIES OF MERCHANTABILITY, FITNESS FOR A PARTICULAR PURPOSE AND NON-INFRINGEMENT OF COPYRIGHT, PATENT, TRADE-MARK OR OTHER RIGHT. UNDER NO CIRCUMSTANCES SHALL TAVMJONG BAH BE LIABLE FOR ANY CLAIM, DAMAGES OR OTHER LIABILITY, INCLUDING ANY GENERAL, SPECIAL, INDIRECT, INCIDENTAL OR CONSEQUENTIAL DAMAGES, WHETHER IN AN ACTION OF CONTRACT, TORT OR OTHERWISE, ARISING FROM, OUT OF THE USE OR INABILITY TO USE THE FONT SOFTWARE OR FROM OTHER DEALINGS IN THE FONT SOFTWARE.

Except as contained in this notice, the name of Tavmjong Bah shall not be used in advertising or otherwise to promote the sale, use or other dealings in this Font Software without prior written authorisation from Tavmjong Bah. For more information, contact: tavmjong@free.fr.

FTL

The FreeType Project LICENCE
2006-Jan-27

Copyright 1996-2002, 2006 by David Turner, Robert Wilhelm and Werner Lemberg

Introduction

The FreeType Project is distributed in several archive packages; some of them may contain, in addition to the FreeType font engine, various tools and

contributions which rely on, or relate to, the FreeType Project.

This licence applies to all files found in such packages, and which do not fall under their own explicit licence. The licence affects thus the FreeType font engine, the test programs, documentation and makefiles, at the very least.

This licence was inspired by the BSD, Artistic, and IJG (Independent JPEG Group) licences, which all encourage inclusion and use of free software in commercial and freeware products alike. As a consequence, its main points are that:

- o We do not promise that this software works. However, we will be interested in any kind of bug reports. ('as is' distribution)
- o You can use this software for whatever you want, in part or full, without having to pay us. ('royalty-free usage')
- o You cannot claim to be the author of this software. If you use it, or only parts of it, in a program, you must acknowledge somewhere in your documentation that you have used the FreeType code. ('credits')

We specifically permit and encourage the inclusion of this software, with or without modifications, in commercial products. We disclaim all warranties covering The FreeType Project and assume no liability related to The FreeType Project.

Finally, many people asked us for a preferred form for a credit/disclaimer to use in compliance with this licence. We thus encourage you to use the following text:

"Portions of this software are copyright © year The FreeType Project (www.freetype.org). All rights reserved."

Please replace year with the value from the FreeType version you actually use.

Legal Terms

0. Definitions

Throughout this licence, the terms 'package', 'FreeType Project' and 'FreeType archive' refer to the set of files originally distributed by the authors (David Turner, Robert Wilhelm and Werner Lemberg) as the 'FreeType Project', be they named as alpha, beta or final release.

'You' refers to the licensee or person using the project, where 'using' is a generic term including compiling the project's source code as well as linking it to form a 'program' or 'executable'. This program is referred to as 'a program using the FreeType engine'.

This licence applies to all files distributed in the original FreeType Project, including all source code, binaries and documentation, unless otherwise stated in the file in its original, unmodified form as distributed in the original archive. If you are unsure whether or not a particular file is covered by this licence, you must contact us to verify this.

The FreeType Project is copyright (C) 1996-2000 by David Turner, Robert Wilhelm and Werner Lemberg. All rights reserved except as specified below.

1. No Warranty

THE FREETYPE PROJECT IS PROVIDED 'AS IS' WITHOUT WARRANTY OF ANY KIND, EITHER EXPRESS OR IMPLIED, INCLUDING, BUT NOT LIMITED TO, WARRANTIES OF MERCHANTABILITY AND FITNESS FOR A PARTICULAR PURPOSE. UNDER NO CIRCUMSTANCES WILL ANY OF THE AUTHORS OR COPYRIGHT HOLDERS BE LIABLE FOR ANY DAMAGES CAUSED BY THE USE OR THE INABILITY TO USE THE FREETYPE PROJECT.

2. Redistribution

This licence grants a worldwide, royalty-free, perpetual and irrevocable right and licence to use, execute, perform, compile, display, copy, create derivative works of, distribute and sublicense the FreeType Project (in both source and object code forms) and derivative works thereof for any purpose; and to authorise others to exercise some or all of the

rights granted herein, subject to the following conditions:

- o If the source code is redistributed, this licence file ('FTL.TXT') must remain unaltered; any additions, deletions or changes to the original files must be clearly indicated in accompanying documentation. The copyright notices of the unaltered original files must be preserved in all copies of source files.

- o Redistribution in binary form must provide a disclaimer that states that the software is based in part of the work of the FreeType Team, in the distribution documentation. We also encourage you to put an URL to the FreeType web page in your documentation, though this is not mandatory.

These conditions apply to any software derived from or based on the FreeType Project, not just the unmodified files. If you use our work, you must acknowledge us. However, you do not need to pay us any fee.

3. Advertising

Neither the FreeType authors and contributors nor you shall use the name of the other for commercial, advertising or promotional purposes without specific prior written permission.

We suggest, but do not require, that you use one or more of the following phrases to refer to this software in your documentation or advertising materials: 'FreeType Project', 'FreeType Engine', 'FreeType library' or 'FreeType Distribution'.

As you have not signed this licence, you are not required to accept it. However, as the FreeType Project is copyrighted material, only this licence, or another one contracted with the authors, grants you the right to use, distribute and modify it. Therefore, by using, distributing or modifying the FreeType Project, you indicate that you understand and accept all the terms of this licence.

4. Contacts

There are two mailing lists related to FreeType:

o freetype@nongnu.org

Discusses general use and applications of FreeType, as well as future and planned additions to the library and distribution. If you are looking for support, start in this list if you have not found anything in the documentation to help you.

o freetype-devel@nongnu.org

Discusses bugs, as well as engine internals, design issues, specific licences, porting, etc.

Our home page can be found at

<http://www.freetype.org>

— end of FTL.TXT —

ICU

Permission is hereby granted, free of charge, to any person obtaining a copy of this software and associated documentation files (the "Software") to deal in the Software without restriction, including without limitation the rights to use, copy, modify, merge, publish, distribute and/or sell copies of the Software, and to permit persons to whom the Software is furnished to do so, provided that the above copyright notice(s) and this permission notice appear in all copies of the Software and that both the above copyright notice(s) and this permission notice appear in supporting documentation. THE SOFTWARE IS PROVIDED "AS IS", WITHOUT WARRANTY OF ANY KIND, EXPRESS OR IMPLIED, INCLUDING BUT NOT LIMITED TO THE WARRANTIES OF MERCHANTABILITY, FITNESS FOR A PARTICULAR PURPOSE AND NON-INFRINGEMENT OF THIRD PARTY RIGHTS. UNDER NO CIRCUMSTANCES SHALL THE COPYRIGHT HOLDER OR HOLDERS INCLUDED IN THIS NOTICE BE LIABLE FOR ANY CLAIM OR ANY SPECIAL INDIRECT OR CONSEQUENTIAL DAMAGES OR ANY DAMAGES WHATSOEVER RESULTING FROM LOSS OF USE, DATA OR PROFITS, WHETHER IN AN ACTION OF CONTRACT, NEGLIGENCE OR OTHER TORTIOUS ACTION, ARISING OUT OF OR IN

CONNECTION WITH THE USE OR PERFORMANCE OF THIS SOFTWARE.

Except as contained in this notice, the name of a copyright holder shall not be used in advertising or otherwise to promote the sale, use or other dealings in this Software without prior written authorisation of the copyright holder.

IJG

Independent JPEG Group Licence

LEGAL ISSUES

In plain English:

1. We do not promise that this software works. (But if you find any bugs, please let us know!)
2. You can use this software for whatever you want. You do not have to pay us.
3. You cannot claim to be the author of this software. If you use it in a program, you must acknowledge somewhere in your documentation that you have used the IJG code.

In legalese:

The authors make NO WARRANTY or representation, either express or implied, with respect to this software, its quality, accuracy, merchantability or fitness for a particular purpose. This software is provided "AS IS", and you, its user, assume the entire risk as to its quality and accuracy.

This software is copyright (C) 1991-1998, Thomas G. Lane. All Rights Reserved except as specified below.

Permission is hereby granted to use, copy, modify and distribute this software (or portions thereof) for any purpose, without a fee, subject to these conditions:

- (1) If any part of the source code for this software is distributed, then this README file must be included, with this copyright and no-warranty notice unaltered; and any additions, deletions or changes to the

original files must be clearly indicated in accompanying documentation.

(2) If only executable code is distributed, then the accompanying documentation must state that "this software is based in part on the work of the Independent JPEG Group".

(3) Permission for use of this software is granted only if the user accepts full responsibility for any undesirable consequences; the authors accept NO LIABILITY for damages of any kind.

These conditions apply to any software derived from or based on the IJG code, not just to the unmodified library. If you use our work, you should acknowledge us.

Permission is NOT granted for the use of any IJG author's name or company name in advertising or publicity relating to this software or products derived from it. This software may be referred to only as "the Independent JPEG Group's software".

We specifically permit and encourage the use of this software as the basis of commercial products, provided that all warranty or liability claims are assumed by the product vendor.

ansi2knr.c is included in this distribution by permission of L. Peter Deutsch, sole proprietor of its copyright holder, Aladdin Enterprises of Menlo Park, CA. ansi2knr.c is NOT covered by the above copyright and conditions, but instead by the usual distribution terms of the Free Software Foundation; principally, that you must include source code if you redistribute it. (See the file ansi2knr.c for full details.) However, since ansi2knr.c is not needed as part of any program generated from the IJG code, this does not limit you more than the foregoing paragraphs do.

The Unix configuration script "configure" was produced with GNU Autoconf. It is copyright by the Free Software Foundation but is freely distributable. The same holds for its supporting scripts (config.guess, config.sub, ltconfig, ltmain.sh). Another support

script, install-sh, is copyright by M.I.T. but is also freely distributable.

It appears that the arithmetic coding option of the JPEG spec is covered by patents owned by IBM, AT and Mitsubishi. Hence arithmetic coding cannot legally be used without obtaining one or more licences. For this reason, support for arithmetic coding has been removed from the free JPEG software. (Since arithmetic coding provides only a marginal gain over the unpatented Huffman mode, it is unlikely that a large number of implementations will support it.) As far as we are aware, there are no patent restrictions on the remaining code.

The IJG distribution formerly included code to read and write GIF files. To avoid entanglement with the Unisys LZW patent, GIF reading support has been removed altogether, and the GIF writer has been simplified to produce "uncompressed GIFs". This technique does not use the LZW algorithm; the resulting GIF files are larger than usual but readable by all standard GIF decoders.

We are required to state that "The Graphics Interchange Format(c) is the Copyright property of CompuServe Incorporated. GIF(sm) is a Service Mark property of CompuServe Incorporated."

Libpng

This copy of the libpng notices is provided for your convenience. In case of any discrepancy between this copy and the notices in the file png.h that is included in the libpng distribution, the latter shall prevail.

COPYRIGHT NOTICE, DISCLAIMER and LICENCE: If you modify libpng you may insert additional notices immediately following this sentence.

This code is released under the libpng licence. libpng versions 1.2.6, 15 August 2004 to 1.4.5, 9 December 2010, are copyrighted (c) 2004, 2006-2010 Glenn Randers-Pehrson and are distributed

according to the same disclaimer and licence as libpng-1.2.5 with the following individual added to the list of Contributing Authors

Cosmin Truta

libpng versions 1.0.7, 1 July 2000 to 1.2.5, 3 October 2002, are Copyrighted (c) 2000-2002 Glenn Randers-Pehrson and are distributed according to the same disclaimer and licence as libpng-1.0.6 with the following individuals added to the list of Contributing Authors

Simon-Pierre Cadieux

Eric S. Raymond

Gilles Vollant

and with the following additions to the disclaimer:

There is no warranty against interference with your enjoyment of the library or against infringement. There is no warranty that our efforts or the library will fulfil any of your particular purposes or needs. This library is provided with all errors, and the entire risk of satisfactory quality, performance, accuracy and effort is borne by the user.

libpng versions 0.97, January 1998 to 1.0.6, 20 March 2000, are Copyrighted (c) 1998, 1999 Glenn Randers-Pehrson and are distributed according to the same disclaimer and licence as libpng-0.96, with the following individuals added to the list of Contributing Authors:

Tom Lane

Glenn Randers-Pehrson

Willem van Schaik

libpng versions 0.89, June 1996, through 0.96, May 1997, are Copyrighted (c) 1996, 1997 Andreas Digger Distributed according to the same disclaimer and licence as libpng-0.88, with the following individuals added to the list of Contributing Authors:

John Bowler

Kevin Bracey

Sam Bushell

Magnus Holmgren

Greg Roelofs
Tom Tanner

libpng versions 0.5, May 1995 to 0.88, January 1996, are Copyrighted (c) 1995, 1996 Guy Eric Schalnat, Group 42, Inc.

For the purposes of this copyright and licence, "Contributing Authors" is defined as the following set of individuals:

Andreas Dilger
Dave Martindale
Guy Eric Schalnat
Paul Schmidt
Tim Wegner

The PNG Reference Library is supplied "AS IS". The Contributing Authors and Group 42, Inc. disclaim all warranties, expressed or implied, including, without limitation, the warranties of merchantability and of fitness for any purpose. The Contributing Authors and Group 42, Inc. assume no liability for direct, indirect, incidental, special, exemplary, or consequential damages, which may result from the use of the PNG Reference Library, even if advised of the possibility of such damage.

Permission is hereby granted to use, copy, Pehrson andribute this source code, or portions hereof, for any purpose, without a fee, subject to the following restrictions:

1. The origin of this source code must not be misrepresented.
2. Altered versions must be plainly marked as such and must not be misrepresented as being the original source.
3. This Copyright notice may not be removed or altered from any source or altered source distribution.

The Contributing Authors and Group 42, Inc. specifically permit, without a fee, and encourage the use of this source code as a component to supporting the PNG file format in commercial products. If you use

this source code in a product, acknowledgement is not required but would be appreciated.

MIT

Permission is hereby granted, free of charge, to any person obtaining a copy of this software and associated documentation files (the "Software") to deal in the Software without restriction, including without limitation the rights to use, copy, modify, merge, publish, distribute, sublicense and/or sell copies of the Software, and to permit persons to whom the Software is furnished to do so, subject to the following conditions:

The above copyright notice and this permission notice shall be included in all copies or substantial portions of the Software.

THE SOFTWARE IS PROVIDED "AS IS", WITHOUT WARRANTY OF ANY KIND, EXPRESS OR IMPLIED, INCLUDING BUT NOT LIMITED TO THE WARRANTIES OF MERCHANTABILITY, FITNESS FOR A PARTICULAR PURPOSE AND NON-INFRINGEMENT. UNDER NO CIRCUMSTANCES SHALL THE AUTHORS OR COPYRIGHT HOLDERS BE LIABLE FOR ANY CLAIM, DAMAGES OR OTHER LIABILITY, WHETHER IN AN ACTION OF CONTRACT, TORT OR OTHERWISE, ARISING FROM, OUT OF OR IN CONNECTION WITH THE SOFTWARE OR THE USE THEREOF OR OTHER DEALINGS IN THE SOFTWARE.

MIT-like Licence (Dinkum C++ 11 Libraries)

The Dinkum C++ Library in machine-readable or printed form ("Dinkum Library") and the Dinkum C++ Library Reference in machine-readable or printed form ("Dinkum Reference"), hereafter in whole or in part the "Product," are all copyrighted © 1989-2001 by P.J. Plauger. ALL RIGHTS RESERVED. The Product is derived in part from books copyrighted © 1992-1995 by P.J. Plauger.

Dinkumware, Ltd. and P.J. Plauger ("Licensor") retain exclusive ownership of this Product. It is licensed to you ("Licensee") in accordance with the terms specifically stated in this Notice. If you have obtained this Product from a third party or under a special licence from Dinkumware, Ltd., additional restrictions may also apply. You must otherwise treat the Product the same as other copyrighted material, such as a book or recording. You may also exercise certain rights particular to computer software under copyright law. In particular:

You may use the Library portion of the Product (if present) to compile and link with C/C++ code to produce executable files.

You may freely distribute such executable files for no additional licence fee to the Licensor.

You may make one or more backup copies of the Product for archival purposes.

You may permanently transfer ownership of the Product to another party only if the other party agrees to the terms stated in this Notice and you transfer or destroy all copies of the Product that are in your possession.

You must preserve this Notice and all copyright notices with any copy you make of the Product.

You may not loan, rent or sublicense the Product.

You may not copy or distribute, in any form, any part of this Product for any purpose not specifically permitted by this Notice.

This copy of the Product is licensed for use by a limited number of developers, which is specified as part of the packaging for this Product.

A licence for up to ten users, for example, limits to ten the number of developers reasonably able to use the Product at any instant of time.

Thus, ten is the maximum number of possible concurrent users, not the number of actual concurrent users.

A single-user licence is for use by just one developer.

Anyone who accesses this software has a moral responsibility not to aid or abet illegal copying by others.

The Licensor recognises that the machine-readable format of the Product makes it particularly conducive to sharing within multi-user systems and across networks.

Such use is permitted only so long as Licensee does not exceed the maximum number of possible concurrent users and takes reasonable precautions to protect the Product against unauthorised copying and against public access.

In particular, please note that the ability to access this copy does not imply permission to use it or to copy it.

Please note also that the Licensor has expended considerable professional effort in the production of this Product and continues to do so to keep it current.

The Licensor warrants that the Product as shipped performs substantially in accordance with its documented purpose and that the medium on which the Product is provided is free from defects in material and workmanship. To the extent permitted by law, any implied warranties on the Product are limited to 90 days.

The Licensor's entire liability under this warranty shall be, at the Licensor's option, either to refund the licence fee paid by the Licensee or to replace the medium on which the Product is provided. This is also the Licensee's exclusive remedy. To qualify for this remedy, the Licensee must demonstrate satisfactory proof of purchase to the Licensor and return the Product in reasonably good condition to the Licensor. THE LICENSOR OTHERWISE MAKES NO REPRESENTATIONS OR WARRANTIES ABOUT THE SUITABILITY OF THIS PRODUCT, EITHER EXPRESS OR IMPLIED, INCLUDING BUT NOT LIMITED TO THE IMPLIED WARRANTIES OF MERCHANTABILITY, FITNESS FOR A PARTICULAR PURPOSE OR NON-

INFRINGEMENT. THE LICENSOR SHALL NOT BE LIABLE FOR ANY DAMAGES SUFFERED BY LICENSEE AS A RESULT OF USING THIS PRODUCT, EVEN IF THE LICENSOR HAS BEEN ADVISED OF THE POSSIBILITY OF SUCH DAMAGES. TO THE EXTENT PERMITTED BY LAW, THE LICENSOR SHALL NOT BE LIABLE FOR CONSEQUENTIAL OR INCIDENTAL DAMAGES.

By using this Product, you agree to abide by the intellectual property laws and all other applicable laws of the USA, and the terms described above. You may be held legally responsible for any infringement that is caused or encouraged by your failure to abide by the terms of this Notice.

RESTRICTED RIGHTS: Use, duplication or disclosure by the government is subject to the restrictions as set forth in subparagraph (c)(1)(ii) of the Rights in Technical Data and Computer Software Clause as DFARS 52.227-7013 and FAR 52.227-19. Unpublished rights are reserved under the Copyright Laws of the USA. Contractor/ Manufacturer is DINKUMWARE, LTD., 398 Main Street, Concord, MA 01742. The terms of this notice shall be governed by the laws of the Commonwealth of Massachusetts. THE RIGHTS AND OBLIGATIONS OF THE PARTIES SHALL NOT BE GOVERNED BY THE PROVISIONS OF THE U. N. CONVENTION FOR THE INTERNATIONAL SALE OF GOODS, 1980.

This Copyright and Licence Notice is the entire agreement of the parties with respect to the matters set forth herein, and supersedes any other verbal or written agreements or communications relating thereto and shall alone be binding. No provision appearing on any purchase order, quotation form or other form originated by either party shall be applicable.

Dinkumware and Dinkum are registered trademarks of Dinkumware, Ltd.

MIT-like Licence (HarfBuzz)

HarfBuzz is licensed under the so-called "Old MIT" licence. Details follow. For parts of HarfBuzz that are licensed under different licences, see individual files names COPYING in subdirectories where applicable. Copyright (c) 2010, 2011, 2012 Google, Inc. Copyright (c) 2012 Mozilla Foundation. Copyright (c) 2011 Codethink Limited Copyright (c) 2008, 2010 Nokia Corporation and/or its subsidiary/subsidiaries Copyright (c) 2009 Keith Stribley Copyright (c) 2009 Martin Hosken and SIL International Copyright (c) 2007 Chris Wilson Copyright (c) 2006 Behdad Esfahbod Copyright (c) 2005 David Turner Copyright (c) 2004, 2007, 2008, 2009, 2010 Red Hat, Inc. Copyright (c) 1998-2004 David Turner and Werner Lemberg
For full copyright notices, consult the individual files in the package.

Permission is hereby granted, without written agreement and without licence or royalty fees, to use, copy, Pehrson andribute this software and its documentation for any purpose, provided that the above copyright notice and the following two paragraphs appear in all copies of this software.

UNDER NO CIRCUMSTANCES SHALL THE COPYRIGHT HOLDER BE LIABLE TO ANY PARTY FOR DIRECT, INDIRECT, SPECIAL, INCIDENTAL OR CONSEQUENTIAL DAMAGES ARISING OUT OF THE USE OF THIS SOFTWARE AND ITS DOCUMENTATION, EVEN IF THE COPYRIGHT HOLDER HAS BEEN ADVISED OF THE POSSIBILITY OF SUCH DAMAGE. THE COPYRIGHT HOLDER SPECIFICALLY DISCLAIMS ANY WARRANTIES, INCLUDING, BUT NOT LIMITED TO, THE IMPLIED WARRANTIES OF MERCHANTABILITY AND FITNESS FOR A PARTICULAR

PURPOSE. THE SOFTWARE PROVIDED HEREUNDER IS ON AN "AS IS" BASIS, AND THE COPYRIGHT HOLDER HAS NO OBLIGATION TO PROVIDE MAINTENANCE, SUPPORT, UPDATES, ENHANCEMENTS OR MODIFICATIONS.

MIT-like Licence (PCCTS)

SOFTWARE RIGHTS

We reserve no LEGAL rights to the Purdue Compiler Construction Tool Set (PCCTS) – PCCTS is in the public domain. An individual or company may do whatever they wish with source code distributed with PCCTS or the code generated by PCCTS, including the incorporation of PCCTS, or its output, into commercial software.

We encourage users to develop software with PCCTS. However, we do ask that credit is given to us for developing PCCTS. By "credit", we mean that if you incorporate our source code into one of your programs (commercial product, research project or otherwise) that you acknowledge this fact somewhere in the documentation, research report, etc. If you like PCCTS and have developed a useful tool with the output, please mention that you developed it using PCCTS. In addition, we ask that this header remain intact in our source code. As long as these guidelines are kept, we expect to continue enhancing this system and expect to make other tools available as they are completed.

ANTLR 1.33

Terence Parr

Parr Research Corporation

with Purdue University and AHPARC, University of Minnesota

1989-1995

MIT-like Licence (Synopsys DWC ETHER QOS Software Driver)

The Synopsys DWC ETHER QOS Software Driver and documentation (hereinafter "Software") is an unsupported proprietary work of Synopsys, Inc. unless otherwise expressly agreed to in writing between Synopsys and you.

The Software IS NOT an item of Licensed Software or Licensed Product under any End User Software Licence Agreement or Agreement for Licensed Product with Synopsys or any supplement thereto. Permission is hereby granted, free of charge, to any person obtaining a copy of this software annotated with this licence and the Software, to deal in the Software without restriction, including without limitation the rights to use, copy, modify, merge, publish, distribute, sublicense and/or sell copies of the Software, and to permit persons to whom the Software is furnished to do so, subject to the following conditions:

The above copyright notice and this permission notice shall be included in all copies or substantial portions of the Software.

THIS SOFTWARE IS BEING DISTRIBUTED BY SYNOPSYS SOLELY ON AN "AS IS" BASIS AND ANY EXPRESS OR IMPLIED WARRANTIES, INCLUDING, BUT NOT LIMITED TO, THE IMPLIED WARRANTIES OF MERCHANTABILITY AND FITNESS FOR A PARTICULAR PURPOSE ARE HEREBY DISCLAIMED. UNDER NO CIRCUMSTANCES SHALL SYNOPSYS BE LIABLE FOR ANY DIRECT, INDIRECT, INCIDENTAL, SPECIAL, EXEMPLARY OR CONSEQUENTIAL DAMAGES (INCLUDING, BUT NOT LIMITED TO, PROCUREMENT OF SUBSTITUTE GOODS OR SERVICES; LOSS OF USE, DATA OR PROFITS; OR BUSINESS INTERRUPTION) HOWEVER CAUSED AND ON ANY THEORY OF LIABILITY, WHETHER IN CONTRACT, STRICT LIABILITY OR TORT (INCLUDING NEGLIGENCE OR OTHERWISE) ARISING IN ANY WAY OUT OF THE

USE OF THIS SOFTWARE, EVEN IF ADVISED OF THE POSSIBILITY OF SUCH DAMAGE.

MIT-like Licence (libgd)

In order to resolve any possible confusion regarding the authorship of gd, the following copyright statement covers all of the authors who have required such a statement. If you are aware of any oversights in this copyright notice, please contact Pierre-A. Joye, who will be pleased to correct them.

* Portions copyrighted 1994, 1995, 1996, 1997, 1998, 1999, 2000, 2001, 2002, 2003, 2004 by Cold Spring Harbor Laboratory. Funded under Grant P41-RR02188 by the National Institutes of Health.

* Portions copyrighted 1996, 1997, 1998, 1999, 2000, 2001, 2002, 2003, 2004 by Boutell.Com, Inc.

* Portions relating to GD2 format copyrighted 1999, 2000, 2001, 2002, 2003, 2004 Philip Warner.

* Portions relating to PNG copyrighted 1999, 2000, 2001, 2002, 2003, 2004 Greg Roelofs.

* Portions relating to gdttf.c copyrighted 1999, 2000, 2001, 2002, 2003, 2004 John Ellson (ellson@graphviz.org).

* Portions relating to gdft.c copyrighted 2001, 2002, 2003, 2004 John Ellson (ellson@graphviz.org).

* Portions copyrighted 2000, 2001, 2002, 2003, 2004, 2005, 2006, 2007 Pierre-Alain Joye (pierre@libgd.org).

* Portions relating to JPEG and to colour quantisation copyrighted 2000, 2001, 2002, 2003, 2004, Doug Becker and copyrighted (C) 1994, 1995, 1996, 1997, 1998, 1999, 2000, 2001, 2002, 2003, 2004 Thomas G. Lane. This software is based in part on the work of the Independent JPEG Group. See the file README-JPEG.TXT for more information.

* Portions relating to GIF compression copyrighted 1989 by Jef Poskanzer and David Rowley, with modifications for thread safety by Thomas Boutell.

* Portions relating to GIF decompression copyrighted 1990, 1991, 1993 by David Koblas, with modifications for thread safety by Thomas Boutell.

* Portions relating to WBMP copyrighted 2000, 2001, 2002, 2003, 2004 Maurice Szmurlo and Johan Van den Brande.

* Portions relating to GIF animations copyrighted 2004 Jaakko Hyvätti (jaakko.hyvatti@iki.fi)

Permission has been granted to copy, distribute and modify gd in any context without a fee, including a commercial application, provided that this notice is present in user-accessible supporting documentation.

This does not affect your ownership of the derived work itself, and the intent is to assure proper credit for the authors of gd, not to interfere with your productive use of gd. If you have questions, please do not hesitate to ask. "Derived works" includes all programs that utilise the library. Credit must be given in user-accessible documentation.

This software is provided "AS IS." The copyright holders disclaim all warranties, either express or implied, including but not limited to implied warranties of merchantability and fitness for a particular purpose, with respect to this code and accompanying documentation.

Although their code does not appear in the current release, the authors wish to thank David Koblas, David Rowley and Hutchison Avenue Software Corporation for their prior contributions.

OpenSSL

OpenSSL Licence

Copyright (c) 1998-2008 The OpenSSL Project. All rights reserved.

Redistribution and use in source and binary forms, with or without modification, are permitted provided that the following conditions are met:

1. Redistributions of source code must retain the above copyright notice, this list of conditions and the following disclaimer.

2. Redistributions in binary form must reproduce the above copyright notice, this list of conditions and the following disclaimer in the documentation and/or other materials provided with the distribution.

3. All advertising materials mentioning features or use of this software must display the following acknowledgement: "This product includes software developed by the OpenSSL Project for use in the OpenSSL Toolkit. (<http://www.openssl.org/>)"

4. The names "OpenSSL Toolkit" and "OpenSSL Project" must not be used to endorse or promote products derived from this software without prior written permission. For written permission, please contact openssl-core@openssl.org.

5. Products derived from this software may not be called "OpenSSL", nor may "OpenSSL" appear in their names without prior written permission of the OpenSSL Project.

6. Redistributions of any form whatsoever must retain the following acknowledgement: "This product includes software developed by the OpenSSL Project for use in the OpenSSL Toolkit (<http://www.openssl.org/>)"

THIS SOFTWARE IS PROVIDED BY THE OpenSSL PROJECT "AS IS" AND ANY EXPRESSED OR IMPLIED WARRANTIES, INCLUDING, BUT NOT LIMITED TO, THE IMPLIED WARRANTIES OF MERCHANTABILITY AND FITNESS FOR A PARTICULAR PURPOSE ARE DISCLAIMED. UNDER NO CIRCUMSTANCES SHALL THE OpenSSL PROJECT OR ITS CONTRIBUTORS BE LIABLE FOR ANY DIRECT, INDIRECT, INCIDENTAL, SPECIAL, EXEMPLARY OR CONSEQUENTIAL DAMAGES (INCLUDING, BUT NOT LIMITED TO,

PROCUREMENT OF SUBSTITUTE GOODS OR SERVICES; LOSS OF USE, DATA OR PROFITS; OR BUSINESS INTERRUPTION) HOWEVER CAUSED AND ON ANY THEORY OF LIABILITY, WHETHER IN CONTRACT, STRICT LIABILITY OR TORT (INCLUDING NEGLIGENCE OR OTHERWISE) ARISING IN ANY WAY OUT OF THE USE OF THIS SOFTWARE, EVEN IF ADVISED OF THE POSSIBILITY OF SUCH DAMAGE.

This product includes cryptographic software written by Eric Young (eay@cryptsoft.com). This product includes software written by Tim Hudson (tjh@cryptsoft.com).

Original SSLeay Licence

Copyright (C) 1995-1998 Eric Young (eay@cryptsoft.com) All rights reserved.

This package is an SSL implementation written by Eric Young (eay@cryptsoft.com). The implementation was written so as to conform with Netscapes SSL.

This library is free for commercial and non-commercial use as long as the following conditions are observed. The following conditions apply to all code found in this distribution, whether it be the RC4, RSA, Ihash, DES, etc., code; not just the SSL code. The SSL documentation included with this distribution is covered by the same copyright terms except that the holder is Tim Hudson (tjh@cryptsoft.com).

Copyright remains Eric Young's, and as such any Copyright notices in the code must not be removed. If this package is used in a product, Eric Young should be given credit as the author of the parts of the library used. This can be in the form of a textual message at program startup or in documentation (online or textual) provided with the package.

Redistribution and use in source and binary forms, with or without modification, are permitted provided that the following conditions are met:

1. Redistributions of source code must retain the copyright notice, this list of conditions and the following disclaimer.
2. Redistributions in binary form must reproduce the above copyright notice, this list of conditions and the following disclaimer in the documentation and/or other materials provided with the distribution.
3. All advertising materials mentioning features or use of this software must display the following acknowledgement: "This product includes cryptographic software written by Eric Young (eay@cryptsoft.com)". The word 'cryptographic' can be omitted if the routines used from the library are not cryptographic :-).
4. If you include any Windows-specific code (or a derivative thereof) from the apps directory (application code) you must include an acknowledgement: "This product includes software written by Tim Hudson (tjh@cryptsoft.com)".

THIS SOFTWARE IS PROVIDED BY ERIC YOUNG "AS IS" AND ANY EXPRESS OR IMPLIED WARRANTIES, INCLUDING, BUT NOT LIMITED TO, THE IMPLIED WARRANTIES OF MERCHANTABILITY AND FITNESS FOR A PARTICULAR PURPOSE ARE DISCLAIMED. UNDER NO CIRCUMSTANCES SHALL THE AUTHOR OR CONTRIBUTORS BE LIABLE FOR ANY DIRECT, INDIRECT, INCIDENTAL, SPECIAL, EXEMPLARY OR CONSEQUENTIAL DAMAGES (INCLUDING, BUT NOT LIMITED TO, PROCUREMENT OF SUBSTITUTE GOODS OR SERVICES; LOSS OF USE, DATA OR PROFITS; OR BUSINESS INTERRUPTION) HOWEVER CAUSED AND ON ANY THEORY OF LIABILITY, WHETHER IN CONTRACT, STRICT LIABILITY OR TORT (INCLUDING NEGLIGENCE OR OTHERWISE) ARISING IN ANY WAY OUT OF THE USE OF THIS SOFTWARE, EVEN IF ADVISED OF THE POSSIBILITY OF SUCH DAMAGE.

The licence and distribution terms for any publicly available version or derivative of this code cannot be

changed, i.e. this code cannot simply be copied and put under another distribution licence [including the GNU Public Licence.]

RSA-MD

Copyright (C) 1991-2, RSA Data Security, Inc. Created 1991. All rights reserved.

License to copy and use this software is granted provided that it is identified as the "RSA Data Security, Inc. MD5 Message-Digest Algorithm" in all material mentioning or referencing this software or this function.

License is also granted to make and use derivative works provided that such works are identified as "derived from the RSA Data Security, Inc. MD5 Message-Digest Algorithm" in all material mentioning or referencing the derived work.

RSA Data Security, Inc. makes no representations concerning either the merchantability of this software or the suitability of this software for any particular purpose. It is provided "as is" without express or implied warranty of any kind.

These notices must be retained in any copies of any part of this documentation and/or software.

SGI-B-2.0

SGI FREE SOFTWARE LICENCE B (Version 2.0, Sept. 18, 2008)

Copyright (C) [dates of first publication] Silicon Graphics, Inc. All Rights Reserved.

Permission is hereby granted, free of charge, to any person obtaining a copy of this software and associated documentation files (the "Software") to deal in the Software without restriction, including without limitation the rights to use, copy, modify, merge, publish, distribute, sublicense and/or sell copies of the Software, and to permit persons to whom the Software is furnished to do so, subject to the following conditions:

The above copyright notice including the dates of first publication and either this permission notice or a reference to <http://oss.sgi.com/projects/FreeB/> shall be included in all copies or substantial portions of the Software.

THE SOFTWARE IS PROVIDED "AS IS", WITHOUT WARRANTY OF ANY KIND, EXPRESS OR IMPLIED, INCLUDING BUT NOT LIMITED TO THE WARRANTIES OF MERCHANTABILITY, FITNESS FOR A PARTICULAR PURPOSE AND NON-INFRINGEMENT. UNDER NO CIRCUMSTANCES SHALL SILICON GRAPHICS, INC. BE LIABLE FOR ANY CLAIM, DAMAGES OR OTHER LIABILITY, WHETHER IN AN ACTION OF CONTRACT, TORT OR OTHERWISE, ARISING FROM, OUT OF OR IN CONNECTION WITH THE SOFTWARE OR THE USE THEREOF OR OTHER DEALINGS IN THE SOFTWARE.

Except as contained in this notice, the name of Silicon Graphics, Inc. shall not be used in advertising or otherwise to promote the sale, use or other dealings in this Software without prior written authorisation from Silicon Graphics, Inc.

Unicode-TOU

Unicode Terms of Use

For the general privacy policy governing access to this site, see the Unicode Privacy Policy. For trademark usage, see the Unicode® Consortium Name and Trademark Usage Policy.

A. Unicode Copyright.

1. Copyright © 1991-2014 Unicode, Inc. All rights reserved.
2. Certain documents and files on this website contain a legend indicating that "Modification is permitted." Any person is hereby authorised, without a fee, to modify such documents and files to create derivative works conforming to the Unicode® Standard, subject to Terms and Conditions herein.

3. Any person is hereby authorised, without a fee, to view, use, reproduce and distribute all documents and files solely for informational purposes in the creation of products supporting the Unicode Standard, subject to the Terms and Conditions herein.

4. Further specifications of rights and restrictions pertaining to the use of the particular set of data files known as the "Unicode Character Database" can be found in Exhibit 1.

5. Each version of the Unicode Standard has additional specifications of rights and restrictions of use. For the book editions (Unicode 5.0 and earlier), these are found on the back of the title page. The online code charts carry specific restrictions. All other files, including online documentation of the core specification for Unicode 6.0 and later, are covered under these general Terms of Use. 6.

6. No licence is granted to "mirror" the Unicode website where a fee is charged for access to the "mirror" site.

7. Modification is not permitted with respect to this document. All copies of this document must be verbatim.

B. Restricted Rights Legend. Any technical data or software licensed to the United States of America, its agencies and/or instrumentalities under this Agreement is commercial technical data or commercial computer software developed exclusively at private expense as defined in FAR 2.101, or DFARS 252.227-7014 (June 1995), as applicable. For technical data, use, duplication or disclosure by the Government is subject to restrictions as set forth in DFARS 202.227-7015 Technical Data, Commercial and Items (Nov 1995) and this Agreement. For Software, in accordance with FAR 12-212 or DFARS 227-7202, whichever applies use, duplication or disclosure by the Government is subject to the restrictions set forth in this Agreement.

C. Warranties and Disclaimers.

1. This publication and/or website may include technical or typographical errors or other inaccuracies. Changes are periodically added to the information herein; these changes will be incorporated in new editions of the publication and/or website. Unicode may make improvements and/or changes in the product(s) and/or program(s) described in this publication and/or website at any time.

2. If this file has been purchased on magnetic or optical media from Unicode, Inc. the sole and exclusive remedy for any claim will be the exchange of the defective media within ninety (90) days of original purchase.

3. EXCEPT AS PROVIDED IN SECTION C.2, THIS PUBLICATION AND/OR SOFTWARE IS PROVIDED "AS IS" WITHOUT WARRANTY OF ANY KIND, EITHER EXPRESS, IMPLIED OR STATUTORY, INCLUDING, BUT NOT LIMITED TO, ANY WARRANTIES OF MERCHANTABILITY, FITNESS FOR A PARTICULAR PURPOSE OR NON-INFRINGEMENT. UNICODE AND ITS LICENSORS ASSUME NO RESPONSIBILITY FOR ERRORS OR OMISSIONS IN THIS PUBLICATION AND/OR SOFTWARE OR OTHER DOCUMENTS REFERENCED BY OR LINKED TO THIS PUBLICATION OR THE UNICODE WEBSITE.

D. Waiver of Damages. Under no circumstances shall Unicode or its licensors be liable for any special, incidental, indirect or consequential damages of any kind or any damages whatsoever, whether or not Unicode was advised of the possibility of the damage, including, without limitation, those resulting from the following: loss of use, data or profits, in connection with the use, modification or distribution of this information or its derivatives.

E. Trademarks & Logos.

1. The Unicode Word Mark and the Unicode Logo are trademarks of Unicode, Inc. "The Unicode Consortium" and "Unicode, Inc." are trade names of Unicode, Inc. Use of the information and materials found on

this website indicates your acknowledgement of Unicode, Inc.'s exclusive worldwide rights in the Unicode Word Mark, the Unicode Logo and the Unicode trade names.

2. The Unicode Consortium Name and Trademark Usage Policy ("Trademark Policy") are incorporated herein by reference and you agree to abide by the provisions of the Trademark Policy, which may be changed from time to time at the sole discretion of Unicode, Inc.

3. All third party trademarks referenced herein are the property of their respective owners.

F. Miscellaneous.

1. Jurisdiction and Venue. This server is operated from a location in the State of California, United States of America. Unicode makes no representation that the materials are appropriate for use in other locations. If you access this server from other locations, you are responsible for compliance with local laws. This Agreement, all use of this site and any claims and damages resulting from use of this site are governed solely by the laws of the State of California without regard to any principles that would apply the laws of a different jurisdiction. The user agrees that any disputes regarding this site shall be resolved solely in the courts located in Santa Clara County, California. The user agrees said courts have personal jurisdiction and agrees to waive any right to transfer the dispute to any other forum.

2. Modification by Unicode Unicode shall have the right to modify this Agreement at any time by posting it to this site. The user may not assign any part of this Agreement without Unicode's prior written consent.

3. Taxes. The user agrees to pay any taxes arising from access to this website or use of the information herein, except for those based on Unicode's net income.

4. Severability. If any provision of this Agreement is declared invalid or unenforceable, the remaining provisions of this Agreement shall remain in effect.

5. Entire Agreement. This Agreement constitutes the entire agreement between the parties.

Zlib

zlib Licence

This software is provided 'as-is', without any express or implied warranty. Under no circumstances will the authors be held liable for any damages arising from the use of this software.

Permission is granted to anyone to use this software for any purpose, including commercial applications, and to alter it and redistribute it freely, subject to the following restrictions:

1. The origin of this software must not be misrepresented; you cannot claim to be the author of the original software. If you use this software in a product, an acknowledgement in the product documentation would be appreciated but is not required.
2. Altered source versions must be plainly marked as such and must not be misrepresented as being the original software.
3. This notice may not be removed or altered from any source distribution.

This product includes third party software provided by QNX Software Systems Limited ("QNX").

To find the QNX open source information used, visit the LGE Open Source Distribution Site. (<http://opensource.lge.com>)

Radio equipment outside European countries

Inspection marks and declarations of conformity

Albania, Bahrain, Bosnia and Herzegovina, French Guyana, Georgia, Gibraltar, Guadeloupe, Iceland, Israel, Ivory Coast, Kuwait, Macedonia, Martinique, Monaco, Montenegro, New Caledonia, Norway, Reunion, Sri Lanka, St. Lucia, Switzerland, Trinidad & Tobago, Turkey.



Argentina



CNC ID: H-21037

CNC ID: C-18053

Australia



Belarus



Brazil



Modelo BCMevo5: 02393-19-05364

Modelo PK3: 00971-18-02930

2294-15-3616

00716-15-03745

05674-16-06830

00598-18-05298

"Este equipamento opera em caráter secundário, isto é, não tem direito à proteção contra interferência prejudicial, mesmo de estações do mesmo tipo, e não pode causar interferência a sistemas operando em caráter primário."

Este equipamento não tem direito à proteção contra interferência prejudicial e não pode causar interferência em sistemas devidamente autorizados.

Este produto está homologado pela ANATEL, de acordo com os procedimentos regulamentados pela Resolução 242/2000, e atende aos requisitos requisitos técnicos aplicados.

Para maiores informações, consulte o site da ANATEL www.anatel.gov.br

Brunei

DTA-002281

Canada

This device complies with Part 15 of the FCC Rules. Operation is subject to the following two conditions:

1. This device may Not cause harmful interference, and
2. This device must accept any interference received including interference that may cause undesired operation.

Cet appareil est conforme à la Partie 15 des réglementations de la FCC et avec la norme RSS-210 de l'Industrie Canadienne. Son fonctionnement est soumis aux deux conditions suivantes:

1. Cet appareil ne doit pas causer d'interférences nuisibles et
2. Cet appareil doit accepter toute interférence reçue, y compris les interférences pouvant entraîner un fonctionnement.

Customs Union (including Armenia, Belarus, Kazakhstan, Russia)



Модель: LTE-MBC-EU2

Изготовитель: Molex CVS Dabendorf GmbH

Сделано в Германии

Электропитание : 12 V=, 400 mA

Costa Rica

SUTEL 00770-2018

Ghana

NCA APPROVED: 1R3-1M-7E0-14B

NCA APPROVED: 6X6-4H-7E0-0F3

Hong Kong

HKCA 1035: Automotive radar: radio equipment exempted from licensing.

India

ETA - 1736/18-RL0(NE)

Indonesia



55538/SDPPI/2018

2208

53856/SDPPI/2017
47817/SDPPI/2016
55747/SDPPI/2018

Israel

Model Name: TSSRE4Dg
Manufacturer: Huf Electronics Bretten
Model Name: LRR4
Manufacturer: Bosch

Japan

204-560001
202-LSC054
202-JN0638
202-SMF114

Japanese Radio Law Compliance. This device is granted pursuant to the Japanese Radio Law. This device should not be modified (otherwise the granted designation number will become invalid).

Jamaica

This product has been Type Approved by Jamaica: SMA - PK3.
This product has been Type Approved by Jamaica: SMA - BCMevo5.

Jordan

TRC/LPD/2014/212
TRC/LPD/2017/615
TRC/LPD/2016/584
TRC/LPD/2018/66

Malaysia



CIDF15000490
CIDF19000029

CIDF17000143
CIDF18000015

Mexico

IFETEL: RLVPOPK17-1947
IFETEL: RLVBOLR14-1873
IFETEL: RLVDER316-1666
IFT: RCPKATR18-0034
Marca: KATHREIN AUTOMOTIVE
Modelo (s): TRANSCVRP01

La operación de este equipo está sujeta a las siguientes dos condiciones:
(1) es posible que este equipo o dispositivo no cause interferencia perjudicial y
(2) este equipo o dispositivo debe aceptar cualquier interferencia, incluyendo la que pueda causar su operación no deseada.

Moldova



MD OC TIP 024 A6116-18

Mongolia



APPROVED
IN MONGOLIA
ID: A18000286



APPROVED
IN MONGOLIA
ID: A17000167

Morocco

AGREE PAR L'ANRT MAROC

Numéro d'agrément :
MR 17800 ANRT 2018
Date d'agrément : 24/10/2018

Numéro d'agrément :
MR 15019 ANRT 2017
Date d'agrément : 26/10/2017

Numéro d'agrément :
MR 9668 ANRT 2014
Date d'agrément : 30/09/2014

Numéro d'agrément :
MR 12623 ANRT 2016
Date d'agrément : 11/10/2016

Numéro d'agrément :
MR 15845 ANRT 2018
Date d'agrément : 19/02/2018

Numéro d'agrément :
MR 13255 ANRT 2017
Date d'agrément : 09/02/2017

Numéro d'agrément: MR 19520 ANRT 2019
Date d'agrément: 13/04/2019

Oman

OMAN - TRA
D172249
TA056891
OMAN - TRA
TA044715
D100428
OMAN - TRA/TA-R/4813/17
D100428
OMAN - TRA/TA-R/2609/15
D080134
OMAN - TRA/TA-R/2160/14
OMAN - TRA/R/3848/17
D080134

Pakistan**Paraguay**

NR: 2017-12-I-0000410

Fig. 227:

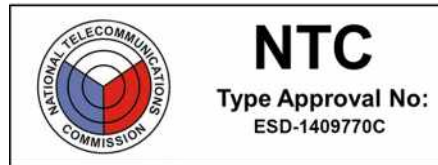
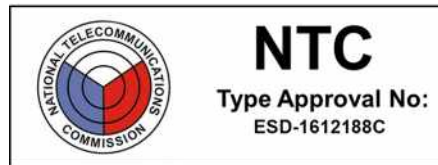
Philippines**Qatar**

Approval Ref.: CRA/SA/2015/R-4714
Approval Ref.: CRA/SA/2014/R-4315

Russia

Модель: LTE-MBC-EU
Изготовитель: Molex CVS Dabendorf GmbH
Сделано в Германии
Электропитание : 12 V=, 400 mA
Модель: WCH-193
Изготовитель: Molex CVS Dabendorf GmbH
Сделано в Германии
Электропитание : 12 V=, 400 mA

Serbia

34540-1313/16-3
34540-1020/17-3

Singapore

Complies with IDMA Standard DA 103787.
Complies with IDMA Standards N0644-18.
Complies with IDMA Standards DB 106879.
Registration Number N3078-18
Complies with IDMA Standards N2853-18.

South Africa

TA-2014/2597
APPROVED



TA-2014/1784
APPROVED



TA-2017/2491
APPROVED



TA-2016/2759
APPROVED



TA-2017/3465
APPROVED



TA-2016/3539
APPROVED



TA-2017/209
APPROVED



TA-2019/5064
APPROVED



TA-2016/2568
APPROVED



TA-2019/5116
APPROVED

South Korea



MSIP-REM-HEB-TSSSG4G5
MSIP-CRM-HEB-TSSRE4DG
MSIP-CMM-BO2-LRR4
MCIP-CRM-DDG-R3TR
R-C-MQU-PK3

송신기 주파수 21.85 kHz
B급 기기(가정용 방송통신기자재)
이 기기는 가정용(B급) 전자파적합기기로서 주
로 가정에서 사용하는 것을 목적으로 하며,
모든 지역에서 사용할 수 있습니다.
해당 무선 설비는 전파혼신 가능성이 있으므로
인명안전과 관련된 서비스는 할 수 없음
송신기 주파수 433.92 MHz
B급 기기(가정용 방송통신기자재)

이 기기는 가정용(B급) 전자파적합기기로서 주
로 가정에서 사용하는 것을 목적으로 하며,
모든 지역에서 사용할 수 있습니다.
해당 무선 설비는 전파혼신 가능성이 있으므로
인명안전과 관련된 서비스는 할 수 없음
인증 받은 자의 상호 Molex CVS Dabendorf GmbH
/
제조사/제조국가 Germany /
기자재의 명칭/ 모델명 LTE-MBC-CN /
기자재의 명칭/ 모델명 MSIP-RMM-N7V-LTE-
MBC-CN
인증 받은 자의 상호 Molex CVS Dabendorf GmbH
/
제조사/제조국가 Germany /
기자재의 명칭/ 모델명 WCH-193 /
기자재의 명칭/ 모델명 R-CMM-N7V-WCH-193

Taiwan

CCAK15LP0801T1
CCAE15LP0190T0
CCAF16LP2450T2
CCAE18LP0110T0
해당 무선 설비는 운용 중 전파혼신 가능성이 있
음
低功率電波輻射性電機管理辦法
第十二條: 經型式認證合格之低功率射頻電機,
非經許可, 公司、商號或使用者均不得擅自變
更頻率、加大功率或變更原設計之特性及功
能。
第十四條: 低功率射頻電機之使用不得影響飛航
安全及干擾合法通信; 經發現有干擾現象時,
應立即停用, 並改善至無干擾時方得繼續使
用。
前項合法通信, 指依電信法規定作業之無線電
信。
低功率射頻電機需忍受合法通信或工業、科學
及醫療用電波輻射性電機設備之干擾。
低功率電波輻射性電機管理辦法

第十二條經型式認證合格之低功率射頻電機,
非經許可, 公司、商號或使用者均不得擅自變
更頻率、加大功率或變更原設計之特性及功
能。
第十四條低功率射頻電機之使用不得影響飛航
安全及干擾合法通信; 經發現有干擾現象時,
應改善至無干擾時方得繼續使用。前項合法通
信, 指依電信法規定作業之無線電通信。低功
率射頻電機須忍受合法通信或工業、科學及醫
療用電波輻射性電機設備之干擾。
本器材須經專業工程人員安裝及設定, 始得設
置使用, 且不得直接販售給一般消費者
電磁波警語標示: 「減少電磁波影響, 請妥適
使用
輸入電源需使用所附的5A保險絲於產品前端做
保護

Thailand

This telecommunication equipment conforms to
NTC technical requirements.

Ukraine

001



109

**United Arab Emirates**

TRA REGISTERED No: ER58762/17,
DEALER No: 0018994/09

TRA REGISTERED No: ER66073/18,
DEALER No: 0018994/09

TRA REGISTERED No: ER38964/15,
DEALER: HUF ELECTRONICS GmbH

TRA REGISTERED No: ER36213/14,
DEALER No: DA36785/14

TRA REGISTERED No: ER497919/16,
DEALER No: DA0062437/11

TRA REGISTERED No: ER61595/18,
DEALER No: DA65993/17

TRA REGISTERED No: ER54754/17,
DEALER No: 0043253/10

TRA REGISTERED No: ER71148/19
DEALER No: DA0043253/10

TRA REGISTERED No: ER54754/17, DEALER No:
DA0043253/10

TRA REGISTERED No: ERXXXX/XX,

DEALER No: 0043253/10

United States of America**NOTICE:**

This device complies with Part 15 of the FCC Rules.
Operation is subject to the following two conditions:

- (1) This device may not cause harmful interference, and
- (2) this device must accept any interference received, including interference that may cause undesired operation.

Changes or modifications made to this equipment not expressly approved by the manufacturer may void the FCC authorization to operate this equipment.

Radiofrequency radiation exposure Information:

The radiated output power of the device is far below the FCC radio frequency exposure limits.

Nevertheless, the device shall be used in such a manner that the potential for human contact during normal operation is minimized.

Vietnam

Technical Data

The information contained in this Manual may differ from the vehicle-specific data due to differing items of equipment or for country-specific reasons. Unless specified separately, it applies for all body variants. For the vehicle-specific data, please refer to the official vehicle documentation and vehicle registration documents and the information plates (e.g. identification plate) in the vehicle.

The information in the official vehicle documentation and vehicle registration documents always takes priority over the information in this Manual.

Vehicle identification number

The vehicle identification number is located at the bottom left behind the windscreen and under the passenger seat.

- ▶ When ordering spare parts, always quote the vehicle identification number.

Identification plate (country-dependent)



Fig. 228: Identification plate fixing point

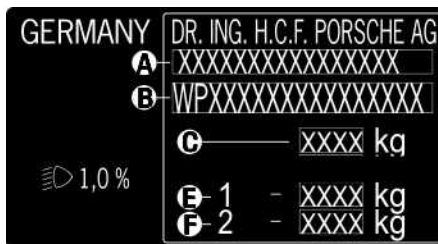

Fig. 229: Example of identification plate

- A EC type approval number (country-dependent)
- B Vehicle identification number
- C Permissible gross weight
- E Maximum axle load, front
- F Maximum axle load, rear

Tyre-pressure plate



Fig. 230: Tyre-pressure plate fixing point

The tyre pressure plate is attached to the door sill area at the driver's door.

Vehicle data carrier

The vehicle data carrier is located in the "Warranty and Maintenance" booklet. It contains all important data about your vehicle. This data carrier cannot be re-ordered if it is lost or damaged.

dimensions

Length (depending on equipment)	4.963 mm
Width (depending on equipment)	1.966 mm
Width with exterior mirrors	2.144 mm
Height at DIN kerb weight depending on chassis version	1.356 mm-1.401 mm
Ground clearance at DIN kerb weight depending on chassis version	106 mm-149 mm

Filling capacities

Washer fluid	approx. 2.5 litres (vehicles with Night View Assist or reversing camera: approx. 5.5 litres)
---------------------	--

Weight



Fig. 231: Example of identification plate

- A EC type approval number (country-dependent)
- B Vehicle identification number
- C Permissible gross weight
- E Maximum axle load, front
- F Maximum axle load, rear

Payload (includes 75 kg for driver and luggage)

Depending on model and equipment

385 kg – 740 kg

- ▶ The vehicle-specific weights such as **permissible total weight and permissible axle loads** must be taken from the identification plate or the official vehicle documents and registration documents (country-specific, e.g. "Certificate of Conformity") provided during delivery of the vehicle.
- ▶ Do not exceed the maximum gross weight and maximum axle loads. If additional accessories are installed, the maximum permissible load will be reduced.

Roof load

- ▶ Only use roof transport systems from the Porsche Tequipment product line or products that have been tested and approved for this vehicle by Porsche.
- ▶ Observe the individual weights of the roof transport system and the attachment parts.
- ▶ Do not drive at a speed of more than 130 km/h (81 mph) when the roof transport system is loaded.
- ▶ Please refer to chapter "Roof Transport System" on page 214.

Maximum roof load

All models

75 kg

Tyres and wheels

Wheel and tyre sizes

Tyres approved by Porsche are the best possible tyres for your vehicle. The load capacity index (e.g. "105") and classification letter for the maximum permitted speed (e.g. "Y") are minimum requirements. When fitting new tyres or changing tyres:

- ▶ Please refer to chapter "Tyres and Wheels" on page 249.
- ▶ Snow chains must only be fitted to the appropriately marked wheel and tyre sizes. Observe the applicable national regulations regarding maximum speeds when snow chains are fitted. Only use snow chains approved by Porsche.
- ▶ Before fitting different wheels and tyres, check the EU declaration of conformity to see if the desired wheel/tyre combination is permitted for your particular vehicle. For more information, please contact your Porsche partner.

Tyre type	Tyre size	Wheel size	Fitting snow chains
Summer tyres	FA: 225/55 R 19 103Y XL	FA: 8,0J x 19, RO 50	no
	RA: 275/45 R 19 108Y XL	RA: 10,0J x 19, RO 47	
	FA: 245/45 R 20 103Y XL	FA: 9,0J x 20, RO 54	no
	RA: 285/40 R 20 108Y XL	RA: 11,0J x 20, RO 60	

Tyre type	Tyre size	Wheel size	Fitting snow chains
All-season tyres	FA: 255/40 ZR 20 (103Y) XL RA: 295/35 ZR 20 (108Y) XL	FA: 9.0J x 20, RO 54 RA: 11,0J x 20, RO 60	no
	FA: 265/35 ZR 21 (101Y) XL RA: 305/30 ZR 21 (104Y) XL	FA: 9,5J x 21, RO 60 RA: 11,5J x 21, RO 66	no
	FA: 225/55 R19 103H XL M+S RA: 275/45 R19 108H XL M+S	FA: 8,0J x 19, RO 50 RA: 10,0J x 19, RO 47	no
	FA: 245/45 R 20 103H XL M+S RA: 285/40 R 20 108H XL M+S	FA: 9.0J x 20, RO 54 RA: 11,0J x 20, RO 60	no
	FA: 265/35 R 21 101H XL M+S RA: 305/30 R 21 104H XL M+S	FA: 9,5J x 21, RO 60 RA: 11,5J x 21, RO 66	no
	FA: 225/55 R19 103V XL M+S RA: 275/45 R19 108V XL M+S	FA: 8,0J x 19, RO 50 RA: 10,0J x 19, RO 47	On rear axle only
	FA: 245/45 R 20 103V XL M+S RA: 285/40 R 20 108V XL M+S	FA: 9.0J x 20, RO 54 RA: 11,0J x 20, RO 60	On rear axle only



19-inch wheels not suitable for vehicles with a Porsche Surface Coated Brake (PSCB) or Porsche Ceramic Composite Brake (PCCB).

FA = front axle, RA = rear axle, RO = rim offset

tyre pressure

All tyre pressures apply only to the tyre makes and types approved by Porsche for cold tyres (20 °C).

The correct tyre pressures for factory-fitted tyres can be found on the tyre pressure plate. The specified tyre pressures for all other tyre options can be found on the Tyre Pressure Monitoring (TPM) display in the central display.

- ▶ Set the tyre type, tyre size and loading condition of the vehicle in the Tyre Pressure Monitoring (TPM) system.
 - ▷ Please refer to chapter "Tyre Pressure Monitoring (TPM)" on page 249.
- ▶ Refer to the tyre pressure plate and the Tyre Pressure Monitoring (TPM) display in the central display.
 -  ▶ **Setting**  ▶ **Vehicle settings** ▶ **Tyre pressure monitoring** **Tyre Pressure Monitoring** ▶ **Pressure deviation**
- ▶ Adapt the tyre pressure according to specifications.

Spare wheel

▷ Please refer to chapter "Using the spare wheel" on page 115.

Wheel and tyre size

Tyre size	Wheel size	Fitting snow chains
T 155/70 R20 115M	4,5B x 20, RO 7	no

FA = front axle, RA = rear axle, RO = rim offset

Tyre pressure

All tyre pressures apply only to the tyre makes and types approved by Porsche for cold tyres (20 °C).

FA	RA
4.2 bar / 420 kPa / 61 psi	4.2 bar / 420 kPa / 61 psi

Radio equipment in accordance with 2014/53/EU

Declaration of Conformity

Your vehicle features a variety of radio equipment. The manufacturers of this radio equipment declare that it complies with the specifications for their use in accordance with Directive 2014/53/EU. The full text of the relevant EU Declaration of Conformity is available at the following Internet address:

<http://www.porsche.com/international/accessoriesandservice/porscheservice/vehicleinformation/documents/>



Mapping tables

The mapping tables help to make a connection between the device designation in a declaration of conformity, and the vehicle equipment and terminology in his driver's manual.

Security

Driver's key

- PK3

Porsche vehicle tracking system – driver card

- PD2

Garage door opener (HomeLink®)

- Universal Garage Door Opener HomeLink® ADHL5D

Control units

Central control unit

- BCMevo 5

tyre

Tyre Pressure Monitoring (TPM) system – gen. 3 control unit

- TPMS ECU G5 compact 433.92 MHz TSSS G4G5

Tyre Pressure Monitoring (TPM) system – gen. 3 wheel electronics

- TPMS Sensor G3.8 433.92 MHz TSSRE4Dg

Infotainment

Smartphone tray

- LTE-MBC-EU2 Multi Band Compensor

Wireless charging

- WCH-193c

Driver assistance

Adaptive Cruise Control (ACC)

- LRR4 automotive radar sensor

ParkAssist

- TRANSCVRP01

Lane Change Assist (LCA), Intersection Assist (IA)

- R3TR Short Range Radar

Antennas

- Kommunikationsbox C-Box: CONBOX-HIGH

- 992.035.504.A
- VAG_724791001
- 920286352
- VAG_724791007

Other

- Ladekabel

Radio system, frequency band, maximum transmission power

Unless stated otherwise, the details apply to all models or vehicles that are equipped with the relevant radio¹ system. Deviations are marked in the footnotes.

Security

Driver's key	
21.85 kHz	< 40 dBµA/m @ 10m
433,47 – 434,37 MHz	10.00 mW
Porsche vehicle tracking system – driver card	
21.85 kHz	< 40 dBµA/m @ 10m
433,47 – 434,37 MHz	10.00 mW
Garage door opener (HomeLink®)	
433,05 – 434,79 MHz	10.00 mW
868,00 – 868,60 MHz	25.00 mW
868,70 – 869,20 MHz	
869,40 – 869,65 MHz	
869,70 – 870,00 MHz	

Control units

Central control unit	
21.85 kHz	< 40dBµA/m @ 10m
433,05 – 434,79 MHz	Receiver only

Tyres

Tyre Pressure Monitoring (TPM) system – gen. 3 wheel electronics	
433.92 MHz	81 dBµV/m
Tyre Pressure Monitoring – gen. 3 control unit	
433.92 MHz	Receiver only

Infotainment

Smartphone tray	
GSM 900 (880 – 915 MHz)	2000.00 mW
GSM 1800 (1710 – 1785 MHz)	1000.00 mW
WCDMA I (1920 – 1980 MHz)	125.00 mW
WCDMA III (1710 – 1785 MHz)	125.00 mW

Smartphone tray

WCDMA VIII (880 – 915 MHz)	125.00 mW
LTE FDD1 (1920 – 1980 MHz)	200.00 mW
LTE FDD3 (1710 – 1785 MHz)	200.00 mW
LTE FDD7 (2500 – 2570 MHz)	200.00 mW
LTE FDD8 (880 – 915 MHz)	200.00 mW
LTE FDD20 (832 – 862 MHz)	200.00 mW

Wireless charging

111.00 kHz	42 dBµA/m
------------	-----------

Driver assistance

Adaptive Cruise Control (ACC)

76 – 77 GHz	981.75 mW
-------------	-----------

Lane Change Assist (LCA), Intersection Assist (IA)

76 – 77 GHz	1000.00 mW
-------------	------------

1. In some countries, commissioning or approval for use of the radio technology may be restricted, not permitted or permitted with additional requirements.

ParkAssist

Bluetooth® (2402 – 2480 MHz)	2.51 mW
---------------------------------	---------

Antennas**Communication box C-Box**

WiFi (2400 – 2484 MHz)	31.62 mW
---------------------------	----------

Bluetooth® 2400 - 2480 MHz)	10.00 mW
--------------------------------	----------

GSM 900 (880 – 915 MHz)	501.19 mW
----------------------------	-----------

GSM 1800 (1710 – 1785 MHz)	1000.00 mW
-------------------------------	------------

WCDMA I (1920 – 1980 MHz)	251.19 mW
------------------------------	-----------

WCDMA III (1710 – 1785 MHz)	251.19 mW
--------------------------------	-----------

WCDMA VIII (880 – 915 MHz)	251.19 mW
-------------------------------	-----------

LTE FDD1 (1920 – 1980 MHz)	199.53 mW
-------------------------------	-----------

LTE FDD3 (1710 – 1785 MHz)	199.53 mW
-------------------------------	-----------

LTE FDD7 (2500 – 2570 MHz)	199.53 mW
-------------------------------	-----------

Communication box C-Box

LTE FDD8 (880 – 915 MHz)	199.53 mW
-----------------------------	-----------

LTE FDD20 (832 – 862 MHz)	199.53 mW
------------------------------	-----------

LTE FDD28 (758 – 803 MHz)	199.53 mW
------------------------------	-----------

LTE FDD32 (1452 - 1496 MHz)	199.53 mW
--------------------------------	-----------

LTE FDD38 (2570 – 2620 MHz)	199.53 mW
--------------------------------	-----------

Other**Charging cable**

WiFi 2.4 GHz (2400 – 2483.5 MHz)	100 mW
-------------------------------------	--------

WiFi 5 GHz (5150 – 5250 MHz)	100 mW
---------------------------------	--------

Index

Symbols

12 V lithium battery	
External power supply	284
Jump starting	284

A

ABS (Anti-lock brake system)	207
Accepting/rejecting a call	182
Account	180
Active Lane Keeping	30
Display elements	31
General safety instructions	30
Switching on and off	32
Adaptive cruise control (ACC)	
Changing the desired speed	37
Interrupting and resuming control	38
Operating states	37
Overriding control	38
Adaptive Cruise Control (ACC)	
Braking to a standstill and driving off again	39
Changing the desired distance	37
Controls	36
Display elements	36
Operating principle	36
Switching on and off	37
Adjusting the seat position	223
Advanced Climate Control	46
Air distribution	
Setting	47
Air suspension (PASM)	187
Air-conditioning system	
Adjusting air distribution	47
Defrosting windscreen	51
Setting automatic air-recirculation mode	50
Setting the air flow	48
Setting the footwell temperature	48
Setting the temperature	48
Storing and retrieving personal settings	180
Switching A/C MAX mode on/off	48
Switching air-recirculation mode on and off	50
Switching cooling function on/off	48
Switching Eco mode on/off	49
Switching maximum cooling output on/off	48
Switching on automatic climate control	46
Switching on/off	46

Switching the ioniser on/off	50
Upper ventilation panel	47
Air-recirculation mode	
Switching on/off	50
Airbag	
Care instructions	67
Switching passenger airbag on and off	93
Warning light	40
Alarm system	
Deactivating interior surveillance and inclination sensor	54
Function indication	54
Functional description	54
Switching on and off	54
All-wheel drive	
Torque distribution display	131
Alloy wheels	
Care instructions	66
Aluminium rims	
Care instructions	66
Ambient lighting	134
Adjusting brightness	263
Set colour	263
Anti-lock brake system (ABS)	207
Antifreeze	
In coolant	97
In washer fluid	219
Apple CarPlay	
Siri	55
Apple CarPlay	55
Apps	56
Charging app	56
Porsche "Good to know" app	56
Porsche 360+ app	56
Porsche Connect App	56
Porsche Road Trip app	56
Armrest	
Front storage compartment	243
Arrival	
Displaying	126
Ashtray	
Emptying	228
Opening	228
Assistance systems	
Adjusting settings	260
Automatic Coming Home lights	149
Automatic dimming function	
Mirror	163

Automatic headlights	
Setting	147

B

Baby carrier	93
Baby seat	93
Switching passenger airbag on and off	93
Battery	283
Charging (lithium battery)	282-283
External power supply	284
Installation position (lithium battery)	282
Instructions (lithium battery)	282
Jump starting	284
Lithium battery	282-283
Procedure after connection (lithium battery)	282-283
Replacing (lithium battery)	282-283
Vehicle electrical system warning (lithium battery)	282-283
Warnings on the battery (lithium battery)	282
Battery charge level	
Displaying	126
Battery temperature	
Displaying	126
Belts	
Care instructions	67
Fastening	221
Notes	220
Opening seat-belt buckle and removing seat belt	222
Seat-belt pre-tensioners	220
Warning light on the instrument cluster	220
Warning message	220
Bend ahead warning	247
Bluetooth®	
Connecting a mobile phone	183
Device Manager	102
Bonnet	
Closing	58
Emergency unlocking	58
Opening	57
Bottle holders	100
Brake assistance	268
Brake fluid	60
Changing brake fluid	60
Checking the brake fluid level	60
Brakes	
Bedding in and cleaning	61
Brake pad warning message	62
Brake pads and brake discs	61

General safety instructions	61	Notes on leaving the vehicle unused for long periods	63	Inserting the vehicle plug and starting the charging process	81
Porsche Ceramic Composite Brake (PCCB)	61	Paint	64	Profile function	83
Porsche Surface Coated Brake (PSCB)	61	PCM	68	Safety instructions	79
Braking		Race-Tex	67	Timer function	83
Emergency braking function	62	Screens	68	Charging app	56
Breakdown Call		Seals	66	Charging Planner	169
Data transmission	175	Seat belts	67	Chassis number	308
Online measures	175	Touch displays	68	Child lock	74
Triggering	175	Underbody protection	65	Rear seats	278
Vehicle access	175	Wheel bolts	255	Child protection	
Buttons on the multi-function steering wheel	129	Windows	65	Disabling the controls in the rear	278
C		Care of wheels	66	Child restraint system	
Cameras		Carpet	67	Ensuring correct installation position	91
Overview	19	Care instructions	67	Installing	93
Car care		Central display	190, 193	Installing with i-Size system	95
Airbags	63	Configuring Home screen	124	Installing with ISOFIX system	95
Alloy wheels	67	Configuring homepage	124	Switching passenger airbag on and off	93
Car washing	64	Configuring MyScreen	124	Using correct weight and size class	88
Decorative films	66	MyScreen	124	Using correctly	87
Dinamica	67	Notifications	173	Child seat	
Fabric lining	67	Start menu	124	Ensuring correct installation position	91
Headlights	66	Central locking	69	Installing	93
Laying up a vehicle	68	Locking vehicle with Comfort Access	73	Installing with i-Size system	95
Leather	66	Locking vehicle with driver's key	72	Installing with ISOFIX system	95
Paint	64	Opening and locking vehicle from inside	73	Switching passenger airbag on and off	93
Plastic parts	66	Storing and retrieving personal settings	180	Top tether	95
Seals	66	Unlocking vehicle with Comfort Access	71	Using correct weight and size class	88
Seat belts	67	Unlocking vehicle with driver's key	71	Using correctly	87
Underbody protection	65	Centre armrest		Closing the profile trim	218
Use of high-pressure cleaning equipment	63	Front storage compartment	243	Coasting mode	238
Warnings	63	Centre console control panel		Cockpit	
Wheel bolts	255	Freehand entry	195	Adjusting lighting	134
Windows	65	Operating	78	Car & Info display	126
Car Care		Quick filter	76	Odometer	131
Rear spoiler	233	Remote control	76	Power meter	125
Car washing	64	Changing battery		Speed & Assist display	125
Care instructions	63	Driver's key	105	Trip counter	131
Airbags	67	Charge port door		Warning and indicator lights	126
Alloy wheels	66	Emergency operation	85	Collision warning	268
Car washing	64	Identification of location	126	Setting the warning time	269
Carpet	67	Opening the charge port door	80	Switching on and off	269
Decorative films	66	Charging		Comfort Access	
Displays	68	Identification for location of charge port door	126	Lock vehicle	73
Fabric lining	67	Charging (high-voltage battery)		Operating principle	70
Floor mats	67	Emergency operation of vehicle plug	86	Unlocking vehicle	71
Floor mats	67	Finishing the charging process and removing the vehicle plug	82	Comfort Entry function	
High-voltage battery	63	High-voltage battery charge and locking status display on vehicle charge port	82	Switching on	263
Laying up a vehicle	68			Comfort memory package	180
Leather	66				

Compass			
Displaying	126		
Configuring the capacitive button	259		
Configuring the quick access button on the steering wheel	259		
Congestion updates (Navigation)	168		
Connect			
Using Porsche Connect services	196		
Connecting an external device via USB	103		
Connection manager	102		
Connection status	184		
Connectivity			
Connection status	184		
Establishing data connection	196		
Using Porsche Connect services	196		
Contacts (phone)	182		
Coolant	97		
Cruise control			
Controls	98		
Cruise control (CC)	98		
Cruise control (CC)	98		
Activating	99		
Changing the desired speed	99		
Display elements	98		
General safety instructions	98		
Interrupting control	99		
Operating principle	98		
Resuming control	99		
Switching on and off	98		
Warning messages	98		
Cupholder	100		
D			
DAB			
Setting frequency range	157		
Data connection			
Device Manager	102		
Establishing (embedded SIM card)	196		
External WiFi hotspot	196		
Using vehicle WiFi hotspot	196		
Date			
Displaying	126		
Date and time			
Setting	258		
Deceleration			
Displaying	126		
Decorative films			
Care instructions	66		
Device Manager	102		
Diagnostic socket	7		
Digital Driver's Manual			
App	3		
On-board	3		
Dipped beams	147		
Direction indicator	150		
Actuate	150		
Comfort direction indication	150		
Display			
Car & Info	126		
Speed & Assist	125		
Displaying and resetting odometer	131		
Displaying and resetting trip counter	131		
Displaying/editing e-mails	160		
Displaying/editing messages (text messages/e-mails)	160		
Displaying/editing text messages	160		
Displays			
Care instructions	68		
Distance warning	268		
Setting the warning time	269		
Switching on and off	269		
Door			
Emergency locking	74		
Emergency unlocking	74		
Locking with Comfort Access	73		
Locking with the driver's key	72		
Opening and locking from inside	73		
Drive mode			
Configuring RANGE	106		
Range	107		
Drive positions	236		
Driver memory package	180		
Driver's key	104		
Driver's key			
Changing battery	105		
Lock vehicle	72		
Unlocking vehicle	71		
Driver's key (remote control)			
Opening/closing side windows (without Comfort Access)	278		
Driving mode	106		
Configuring INDIVIDUAL	106		
INDIVIDUAL	106		
NORMAL	106		
RANGE	106		
Select	106		
SPORT	106		
SPORT PLUS	106		
Vehicle setup	107		
Warning messages	107		
Driving time and distance			
Displaying	126		
Dynamic high beam			
Activating	259		
E			
Electric parking brake			
Actuate	259		
Electrical system voltage			
Displaying	126		
Embedded SIM card			
Establishing data connection	196		
Emergency Assist	112		
Emergency braking function			
Activating	62		
Emergency call	108		
Emergency key	104		
Emergency locking of doors	74		
Emergency operation			
Charge port door	85		
Vehicle plug	86		
Emergency stop function	112		
General safety instructions	112		
Operating principle	112		
Override	113		
Switching on and off	113		
System limitations	112		
Warning messages	112		
Emergency unlocking			
Front lid	58		
Emergency unlocking of doors	74		
Entering a stopover (Navigation)	167		
Entering characters	78		
Entering/searching for a destination	165		
Establishing readiness for operation	236-237		
Examples of commands	266		
Exterior lights			
Setting the fade-out duration	259		
Exterior mirror			
Adjusting as a parking aid	162		
Folding in/out	162		
Setting	161		
Storing settings (memory)	162		
External power supply	284		

External WiFi hotspot	196
F	
Fabric lining (care instructions)	67
Factory settings	
Resetting vehicle settings	258
Faults	
Driver's key battery	105
Power windows	278
Filling capacities	309
Washer fluid	309
Finishing the charging process and removing the vehicle plug	82
Fire extinguisher	13
First aid kit	154
Fitting carrier	214
Fitting mounting components	218
Floor mats	
Care instructions	67
Fluids and fuels	309
Washer fluid	309
FM	
Setting frequency range	157
Folding in mirrors	259
Folding rear seat backrest forward	226
Footwell temperature	
Setting	48
Four-wheel drive	
All-wheel display	131
Freehand entry	78
Front seat	
Setting	223
Full load	
Setting	251
Function buttons on the multi-function steering wheel	129
Function on Demand (FoD)	
Activating	174
Deactivating	174
Fuse	117
Changing electric fuses	117
Fuse assignment	117
Fuse assignment for the right footwell	120
Fuse assignment left dashboard	118
Fuse assignment right dashboard	118
Fuse box	117
Left footwell fuse assignment	119

G

G-force display	131
Garage door opener	
HomeLink®	121
Programming	121
Using	121
Gestures	78
Glove box	
Storage	243
Good to know app	56
GPS altitude	
Displaying	126
H	
Handwriting panel	78
Headlights	151
Care instructions	66
Changing bulbs	151
Overseas mode	151
Setting	151
High beam	
High beam stalk	150
High-pressure cleaning device	
Instructions for use	63
High-voltage battery care	63
High-voltage battery charge and locking status display on vehicle charge port	82
High-voltage battery charge and locking status on vehicle charge port	82
HOLD function	123
Activating	123
General Safety Instructions	123
Operating principle	123
Warning messages	123
HomeLink®	
Garage door opener	121
HomeLink® Garage door opener	
Programming	121
Using	121
Hotspot	
Using an external WiFi hotspot	196
Using PCM WiFi hotspot	196

I

i-Size system	
Installing child restraint system with i-Size system	95
Top tether	95

Ice cover	280
Identification number	308
Identification plate	308
Immobiliser	54
Indicator lights	126
Information area	
Configuring	126
Inserting the vehicle plug and starting the charging process	81
Instrument cluster	125
Adjusting lighting	134
Car & Info display	126
Configuring the capacitive instrument cluster button	259
Menu overview	131
Modifying the display	258
Odometer	131
Operating	129
Overview	125
Power meter	125
Selecting options and activating functions	130
Speed & Assist display	125
Sport Chrono stopwatch	234
Trip counter	131
Tyre Pressure Monitoring	249
Warning and indicator lights	126
Instrument lighting	
Adjusting brightness	134
Instrument panel	
Adjusting lighting	134
Car & Info display	126
Overview	125
Power meter	125
Speed & Assist display	125
Warning and indicator lights	126
Intelligent detour	168
Interfaces in the armrest	
USB	102
Interior lighting	
Ambient lighting	134
Dimming	134
Setting the fade-out duration and brightness	259
Switching on and off	134
Interior mirror	
Dimming	163
Setting	163
Internet	
Establishing data connection	196

- Intersection Assist 136
 - Display elements 136
 - General safety instructions 136
 - Operating principle 136
 - Switching on and off 137
 - System limitations 136
 - Warning messages 136
- Ioniser
 - Switching on/off 50
- ISOFIX system 91
 - Installing child restraint system with ISOFIX system 95
 - Top tether 95
- J**
- Jack
 - Information on raising vehicles with air suspension 188
 - Lifting the vehicle 138
- Jump starting 284
- Jump-lead starting
 - External power supply 284
- K**
- Key
 - Locking vehicle 72
 - Removing emergency key 104
 - Storing and retrieving personal settings 180
 - Unlocking vehicle 71
- Keyboard 194
 - Setting 258
- L**
- Lane Change Assist (LCA) 139
 - Display elements 141
 - Driving situations 141
 - General safety instructions 139
 - Information and warning stage 141
 - Operating principle 140
 - Rear collision warning 140
 - Rear Turn Assist 139
 - Setting display brightness 141
 - Switching on and off 141
 - System limitations 140
 - Warning messages 140
- Lane Keep Assist 144
 - Operating principle 145
 - Switching on and off 146
- Language
 - Setting 258
- Lateral acceleration forces
 - Display 131
- Launch Control 237
- Laying up a vehicle 68
- Leather
 - Care instructions 66
- Leaving the vehicle unused 63
- Light bulbs 151
- Lighting
 - Interior lighting 134
- Lights
 - Adverse weather lights 149
 - Ambient lighting 134
 - Automatic Coming Home lights 149
 - Automatic headlight calibration 149
 - Automatic headlights 147
 - Brief overview 147
 - Care instructions 66
 - Changing bulbs 151
 - Dipped beams 147
 - Direction indicator 150
 - Dynamic cornering lights 149
 - Dynamic high beam 149
 - Encounter lights 149
 - Entry function/Exit function 149
 - Exterior lights 147
 - Fog function 149
 - General safety instructions 148
 - Hazard warning lights 151
 - Headlight flasher 150
 - Interior lighting 134
 - Motorway lights 149
 - Overseas mode 151
 - Passing lights 149
 - PDLS Plus with LED headlights 149
 - PDLS Plus with LED matrix headlights 149
 - Rear fog light 147
 - Setting the off delay 149
 - Setting travel mode 259
 - Side lights 147
 - Signage glare reduction 149
 - Situational lighting distribution 149
 - Switching dynamic high beam on and off 150
 - Switching high beam on and off 150
 - Switching off 148
 - Switching parking lights on and off 150
 - Warning messages 148
- LIM (speed limiter) 230
- Listening to the mailbox 182
- Load
 - On the roof 214
- Locking
 - Emergency locking of vehicle 74
 - Locking vehicle from inside 73
 - Locking vehicle with Comfort Access 73
 - Locking vehicle with driver's key 72
 - SAFELOCK 72
- Locking options
 - Setting 259
- Longitudinal acceleration
 - Displaying 126
- Longitudinal acceleration forces
 - Display 131
- Luggage compartment 153
 - Closing 58
 - Emergency unlocking 58
 - Opening 57, 211
- M**
- Maintenance work
 - Adding washer fluid 219
- Malfunctions
 - Storing the side window end positions 278
- Map (Navigation)
 - Calling up 165
 - Configure 167
- Massage programme
 - Setting 263
- Massage strength
 - Setting 263
- Media 157
 - Browsing 157
 - Connecting an external device via USB 103
 - Interfaces in the armrest 102
 - Making settings 159
 - Playing 157
 - Selecting a source 157
 - Storing/editing a favourite 158
 - Tuning/storing stations 157
- Memory package 180
- Messages 160
- Minor repairs
 - In the event of a flat tyre 114
 - Securing vehicle to prevent it from rolling away 114
 - Towing the vehicle 245
- Mirror
 - Adjusting exterior mirrors 161

- Adjusting exterior mirrors as a parking aid 162
- Automatic dimming function 163
- Exterior mirror heating 51
- Folding exterior mirrors in/out 162
- Storing exterior mirror settings (memory) 162
- Vanity mirror 244
- Mobile data (connectivity) 196
- Mobile phone
 - Connecting a mobile phone 183
 - Connecting via Bluetooth® (known mobile phone) 184
 - Connecting via Bluetooth® (new mobile phone) 183
 - Connecting via Bluetooth® (second mobile phone) 184
 - Connecting via Bluetooth® (Windows® and iOS operating system) 184
 - Stowing 185
 - Wireless charging 185
- Mode switch 106
- Multi-collision braking 207
- Multi-function steering wheel
 - Buttons 129
 - Recuperation button 130
- Music
 - Connecting an external device via USB 103
 - Interfaces in the armrest 102
 - Playing 157
 - Storing/editing a favourite 158
- MyScreen 124
- N**
 - Navigation 165
 - Avoiding traffic disruptions 168
 - Charging Planner 169
 - Configuring map content 167
 - Displaying traffic notices 168
 - Displaying/configuring the map display 169
 - Entering a stopover 167
 - Entering GPS coordinates 165
 - Entering/searching for a destination 165
 - Map view and navigation information on the instrument cluster 169
 - Planning a tour 167
 - Porsche Intelligent Range Manager (PIRM) 169
 - Settings 170
 - Toll devices 170
 - Trip overview 168
 - Night View Assist 171
 - Animal warning 171
 - Cleaning the camera 172
 - Display elements 172
 - General safety instructions 171
 - Operating principle 171
 - Pedestrian warning 171
 - Setting the picture contrast 172
 - Setting the warning time 172
 - Switching on and off 172
 - System limitations 171
 - Warning messages 171
- Notification centre 173
- Notifications 173
 - Filtering 173
 - Opening 173
- O**
 - On-board computer
 - Menu overview 131
 - Tyre Pressure Monitoring 249
 - Online navigation 165
 - Online Services
 - Establishing data connection 196
 - Opening and locking 69
 - Side windows 277
 - Storing and retrieving personal settings 180
 - Vehicle 69
 - Opening Driver's Manual in vehicle 195
 - Opening Driver's Manual in Zentraldisplay 195
 - Opening playlist 157
 - OTA functions
 - Breakdown Call 175
 - Error 175
 - Function on Demand (FoD) 174
 - Update 174
 - Overrun recuperation 238
 - Overseas mode
 - Lights 151
- P**
 - Paint 64
 - Care 64
 - Care instructions 64
 - Polishing 64
 - Preserving 64
 - Removing marks 64
 - Repairing damage 64
 - ParkAssist 176
 - Reversing camera 177
 - Surround View 178
 - Parking
 - ParkAssist 176
 - Reversing camera 177
 - Surround View 178
 - Parking aid
 - Swivelling down mirror glass 162
 - Partial load
 - Setting 251
 - PASM (Porsche Active Suspension Management) 187
 - PASSENGER AIR BAG OFF/ON indicator 41
 - Passenger mirror
 - Adjusting as a parking aid 162
 - Folding in/out 162
 - Setting 161
 - Passenger seat
 - Adjust from the driver's seat 263
 - PCM 197
 - Care instructions 68
 - Central display 190, 193
 - Configuring Home screen 124
 - Configuring homepage 124
 - Configuring MyScreen 124
 - Entering text and characters 194
 - Keyboard 194
 - Modifying the display 258
 - MyScreen 124
 - Notifications 173
 - Opening menus 194
 - Setting time or temperature display 194
 - Start menu 124
 - Using an external WiFi hotspot 196
 - Using PCM WiFi hotspot 196
 - PCM hotspot 196
 - PCM set-up wizard
 - Calling up 261
 - Phone 182
 - Connecting via Bluetooth® 183
 - Connecting via Bluetooth® (known mobile phone) 184
 - Connecting via Bluetooth® (new mobile phone) 183
 - Connecting via Bluetooth® (second mobile phone) 184
 - Connecting via Bluetooth® (Windows® and iOS operating system) 184
 - Connection status 184
 - Device Manager 102
 - Dialling a number 182
 - Functions during a phone call 185
 - Making settings 186
 - Managing contacts 186
 - Phone information in the instrument cluster 185

Storing/editing a favourite	184
Stowing	185
Wireless charging	185
PID (Porsche InnoDrive)	199
Planning a tour (Navigation)	167
Playing media	158
Plug socket (12 V)	229
Porsche 360+ Lifestyle Assistant	56
Porsche Active Suspension Management (PASM)	187
Selecting chassis setup	187
Selecting the chassis height	187
Switching off the levelling system (car jack mode)	188
Porsche Ceramic Composite Brake (PCCB)	61
Porsche Communication Management (PCM)	
Central display	190, 193
Opening manual in vehicle	195
Operating	190
Porsche Connect	197
Adjusting settings	261
Displaying data privacy information	261
Displaying the Legal Notice	261
Establishing data connection	196
Logging in user (Porsche ID)	197
Managing user (Porsche ID)	197
Private mode	197
Settings	197
Using services	196
Porsche Connect App	56
Connecting to PCM via WiFi	56
Porsche Dynamic Light System Plus (PDLS Plus) with LED headlights	149
Porsche Dynamic Light System Plus (PDLS Plus) with LED-Matrix headlights	149
Porsche InnoDrive (PID)	199
Braking to a standstill and driving off again	204
Changing the desired speed	204
Controls	202
Example of how it works	204
Interrupting and resuming control	204
Operating principle	201
Operating states	203
Overriding control	204
Setting the desired distance	204
Setting the maximum speed	204
Switching on and off	203
Porsche Intelligent Range Manager (PIRM)	169
Porsche Road Trip app	56
Porsche Stability Management (PSM)	206
Activating PSM Sport	206
Operating principle	206
Porsche Surface Coated Brake (PSCB)	61
Porsche Vehicle Tracking System (PVTS)	208
Operation	209
Service	209
Transport	209
Porsche Vehicle Tracking System Plus (PVTS Plus)	208
Changing the Driver Card battery	210
Driver Card emergency deactivation	209
Driver Card malfunction	209
Operation	209
Service	209
Transport	209
Ports in the armrest	103
Power meter	125
Power windows	
Closing side windows using the proximity sensor in the door handle (vehicles with Comfort Access)	278
Opening/closing side windows	277
Opening/closing side windows with the driver's key (remote control)	278
Storing the end position	278
Preventive occupant protection function	269
Privacy Mode	
Adjusting settings	261
Private mode	197
Profile function	83
PSM (Porsche Stability Management)	206
Q	
Quick access bar	
Quick filter	76
R	
Race-Text	
Care instructions	67
Radio	157
Online radio	157
Setting frequency range	157
Storing/editing a favourite	158
Tuning/storing stations	157
Reading lights	134
Rear fog light	147
Adaptation of light distribution	149
Rear lid	
Adjusting opening height	212
Opening	211
Rear seat	
Child lock	278
Rear seat storage space	226
Rear spoiler	233
Moving to cleaning position	233
Operating principle	233
Rear Turn Assist	139
Rear window	
Switching heating on/off	51
Recuperation	237
Recuperation button	130
Remote control	104
Lock vehicle	72
Unlocking vehicle	71
Retrieving personal settings	180
Reversing camera	177
Roof transport system	
Closing the profile trim	218
Fitting carrier	214
Fitting mounting components	218
Transporting a load on the roof	214
S	
SAFELOCK	72
Deactivating with proximity sensor on door handle	73
Deactivating with the driver's key	72
Saving	
Personal settings	180
Saying voice commands	265
Screens	
Care instructions	68
Sealant/sealing set	
For defective tyres	114
Seals	
Care instructions	66
Seat belts	
Care instructions	67
Fastening	221
Notes	220
Opening seat-belt buckle and removing seat belt	222
Seat-belt pre-tensioners	220
Warning light on the instrument cluster	220
Warning message	220
Seat heating balance	
Setting	263
Seat memory	180

Seat ventilation balance			
Setting	263		
Seats			
Adjusting the front seat	223		
Adjusting the seat position	223		
Baby carrier	93		
Folding rear seat backrest forward or back	226		
Storing and retrieving the seat position	180		
Selecting a source (media)	157		
Selecting chassis setup	187		
Selecting the chassis height	187		
Sensors			
Overview	19		
Service position	280		
Setting and activating speed limit warning	248		
Setting automatic air-recirculation mode			
Air-conditioning system	50		
Setting the air flow	48		
Setting the fan			
Air-conditioning system	48		
Setting the off delay	149		
Settings			
Storing and retrieving personal settings	180		
Vehicle	257		
Side lights	147		
Side windows			
Opening/closing	277		
Opening/closing with the driver's key (remote control)	278		
Storing the end position	278		
SIM card			
Using the phone	182		
Siri	55		
Ski bag			
Stowing skis/snowboard	155		
Smartphone			
Connecting via Bluetooth®	183		
Stowing	185		
Wireless charging	185		
Smoker's package	228		
Snow chains			
General information	253		
Software information			
Displaying software components	261		
Displaying version information	261		
Sound settings			
Balance and fader	259		
Setting treble and bass	259		
Spare wheel	115		
Speed limiter (LIM)			
Activating	231		
Adaptive speed limiter	232		
Controls	230		
Display elements	231		
General safety instructions	230		
Operating principle	230		
Overriding temporarily	232		
Setting the maximum speed	232		
System limitations	230		
Speed Limiter (LIM)	230		
Changing the maximum speed	231		
Interrupt and resume	232		
Switching on and off	231		
Spoiler	233		
Cleaning position	233		
General Safety Instructions	233		
Operating principle	233		
Rear spoiler	233		
Setting the manual cleaning position	259		
Warning messages	233		
Sport Chrono mode switch	106		
Sport Chrono stopwatch	234		
Start menu	124		
Station/track			
Displaying	126		
Steering wheel			
Configuring the quick access button	259		
Setting	241		
Switching heating on/off	241		
Stopwatch	234		
Storage compartment			
Opening in the front armrest	243		
Storage options	243		
Storage options	243		
Glove box	243		
Storage compartment in front armrest	243		
Storing the end position of power windows	278		
Storing/editing a favourite			
Media	158		
Phone	184		
Stowing mobile phone	185		
Summer tyre			
Storage	254		
Sun cover	280		
Sun visor	244		
Swerve Assist	268		
Switching on and off	270		
Switching exterior mirror heating on/off	51		
Switching hazard warning lights on and off	151		
Switching seat heating on/off	224		
Switching seat ventilation on/off	224		
Switching steering wheel heating on/off	241		
T			
Technical data			
Filling capacities	309		
Tyre pressure tables	310		
Weight	309		
Wheel and tyre sizes	310		
Telephone			
Emergency call	108		
Tether			
Installing child restraint systems with ISOFIX tether	95		
Theft protection	54		
Tie-down rings			
Using	156		
Tightening torque			
Wheel bolts	255		
Timer function	83		
Toll devices	170		
Tool kit			
Removing and stowing	154		
Tools	154		
Top tether			
Installing child restraint system with top tether	95		
Torque			
Tightening torque for wheel bolts	255		
Touch display			
Care instructions	68		
Modifying the display	258		
Towing	245		
General information	245		
Towing lug	245		
Using a towing rope or towing bar	245		
Towing lug			
In tool kit	154		
TPM (Tyre Pressure Monitoring)	249		
Traffic notices	168		
Traffic sign detection	247		
Activating speed limit warning	248		
Bend ahead warning	247		
Display elements	247		

Setting speed limit warning	248	Tyres	249	Vehicle door	
Speed limit display	247	Fixing a flat tyre	114	Opening and locking from inside	73
Speed limit warning display	247	Sealant	114	Unlocking from inside	72
System limitations	247	Tyre-pressure plate	308	Vehicle hotspot	196
Warning messages	247			Vehicle identification number	308
Traffic sign recognition		U		Vehicle plug (emergency operation)	86
General Safety Instructions	247	Underbody protection	65	Vehicle settings	250
Operating principle	247	Care instructions	65	Adjusting the volume of navigation announcements	258
Transport (on car trains, ferries, etc.)		Unlocking		Adjusting the volume of warning signals and	
Securing the vehicle	246	Emergency unlocking of vehicle	74	ParkAssist	258
Transverse acceleration		Unlocking and opening the bonnet	57	Configure Range drive mode	262
Displaying	126	Unlocking and opening the tailgate	211	Configuring	257
Tray (phone)	185	Unlocking vehicle from inside	72	Configuring Individual driving mode	262
Tread depth		Unlocking vehicle with Comfort Access	71	Configuring keyboard settings	258
Tyre	253	Unlocking vehicle with driver's key	71	Configuring the capacitive button	259
Tuning/storing stations	157	Unlocking options		Configuring the quick access button on the steering	
Turn Assist	269	Setting	259	wheel	259
Switching on and off	270	Unlocking when approaching the vehicle	259	Display ParkAssist	262
Tyre	250	Update		Displaying pressure difference	251
Check tyre pressure	249	Download	174	Displaying trip data	263
Displaying pressure difference	251	Failed	175	Modify the touch display settings	258
Inscription on tyres	252	Install	174	Modifying the instrument cluster display	258
Replacing tyres (general information)	252	Upper ventilation panel	47	Modifying the PCM display	258
Setting full load or partial load	251	Urgent warning (warning jolt)	268	Resetting to factory settings	258
Setting tyre type and tyre size	251	USB connection	102-103	Resetting trip data	263
Snow chains (general information)	253	Using lists by voice control	266	Set chassis tuning	262
Storage	254	Using voice control	264	Set drive mode	262
Teaching in new tyres in Tyre Pressure Monitoring				Set E-sound	262
(TPM)	251			Set recuperation	262
Tread depth	253	V		Setting chassis height	262
Valves	253	Valves		Setting date and time	258
Winter tyres (general information)	253	Tyre	253	Setting door locking options	259
Tyre pressure		Vanity mirror	244	Setting language	258
Check	249	Vehicle		Setting locking and unlocking options	259
Displaying in instrument cluster	249	Driving	236	Setting tyre type and tyre size	251
System is learning	251	Driving off	237	Setting units	258
Tyre Pressure Monitoring (TPM)	249	Emergency locking	74	Setting unlocking options	259
Displaying	250	Emergency unlocking	74	Setting voice control system	259
Teaching-in	251	Exit	238	Storing on person buttons	180
Tyre pressure tables	310	Locking from inside	73	Switch assistance systems on	262
Tyre pressure warning light	126	Locking with Comfort Access	73	Tyre Pressure Monitoring (TPM)	250
Tyre sealant		Locking with the driver's key	72	Voice control	264
Removing and stowing	154	Starting	236	Examples of commands	266
Tyre sealant/sealing set		Stop	238	Saying natural voice commands	265
For defective tyres	114	Stopping	238	Saying voice commands	265
Tyre selection	259	Unlocking with Comfort Access	71	Setting	259
Tyre-pressure plate	308	Unlocking with driver's key	71	Settings	266
		Vehicle data carrier	308	Siri	55
				Using voice control	264
				Voice Control Help	266

Voice control settings	266	Windows	
W		Care instructions	65
Warn and Brake Assist (WBA)	267	Defrosting windscreen	51
Activating and deactivating the distance warning	269	Switching heated rear window on/off	51
Brake assistance	268	Windscreen	
Collision warning	268	Defrosting	51
Distance warning	268	Windscreen washer system	
General Safety Instructions	267	Adding washer fluid	219
Operating principle	267	Antifreeze	219
Preventive occupant protection function	269	Filling capacity	309
Setting the warning time for the collision warning	269	Windscreen wiper	279
Setting the warning time for the distance warning	269	Care instructions	65
Swerve Assist	268	Cleaning Night View Assist camera	280
Switching on and off	269	Cleaning the reversing camera	280
Switching Serve Assist on and off	270	Controls	279
Switching the collision warning on and off	269	Ice and sun cover	280
Switching Turn Assist on and off	270	Replacing wiper blades	280
System limitations	267	Spraying and wiping	280
Turn Assist	269	Switching on continuous wiping	279
Urgent warning (warning jolt)	268	Wiping with one-touch function	280
Warning messages	267	Windscreen wipers	
Warning lights	126	Care instructions	65
Warning triangle	154	One-touch function	279
Washer fluid		Setting the rain sensor sensitivity	279
Adding	219	Switching on rain sensor	279
Antifreeze	219	Winter tyres	
Filling capacity	309	General information	253
Weight	309	Wireless Internet Access	196
Wheel and tyre sizes	310	Wireless mobile phone charging	185
Wheel bolts	255		
Wheels	249		
Changing	254		
Fixing a flat tyre	114		
Inscription on tyres	252		
Replacing tyres (general information)	252		
Security wheel bolt (wrench socket)	255		
Snow chains (general information)	253		
Storage	254		
Tightening torque	255		
Tyre sealant	114		
Tyre-pressure plate	308		
Valves	253		
Wheel bolts (care instructions)	255		
Winter tyres (general information)	253		
WiFi			
Device Manager	102		
Using an external WiFi hotspot	196		
Using PCM WiFi hotspot	196		