

2023

Niro EV

Owner's Manual

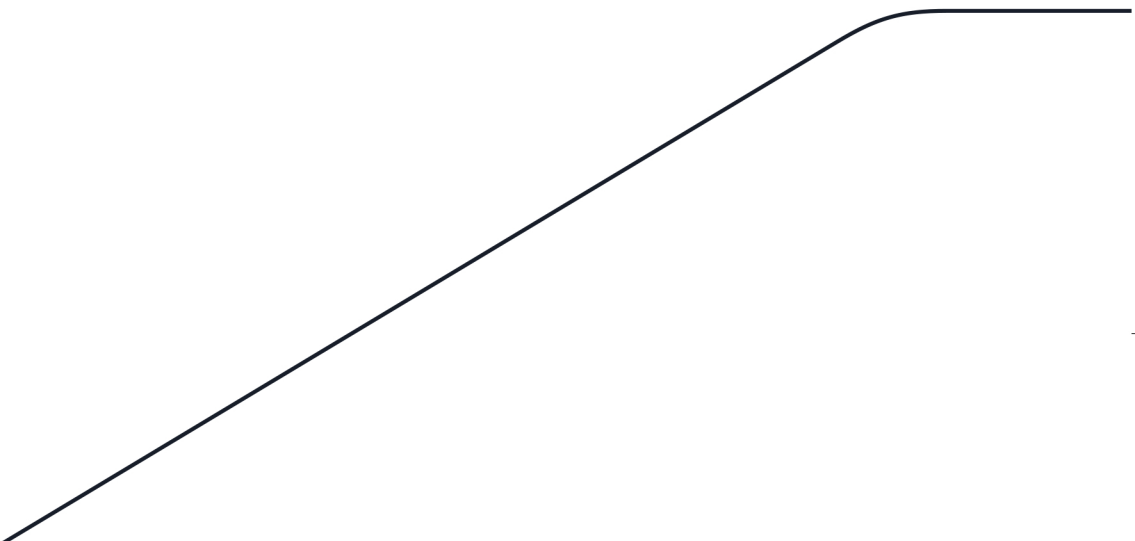

Movement that inspires

FOREWORD

Dear Customer,

Thank you for selecting your new Kia vehicle.

As a global car manufacturer focused on building high-quality vehicles with exceptional value, Kia is dedicated to providing you with a customer service experience that exceeds your expectations.

This Owner's Manual will acquaint you with the operation of features and equipment that are either standard or optional on this vehicle, along with the maintenance needs of this vehicle. Therefore, you may find certain descriptions and illustrations not applicable to your vehicle. You are advised to read this publication carefully and follow the instructions and recommendations. Please always keep this manual in the vehicle for your and any subsequent owner's reference.

Authorized Kia Dealerships provide factory-trained technicians, utilized recommended special service tools, and supply genuine Kia replacement parts to help you maintain and service your vehicle during your ownership.

All information contained in this Owner's Manual was accurate at the time of publication. However, as Kia continues to make improvements to its products, the company reserves the right to make changes to this manual or any of its vehicles at any time without notice and without incurring any obligations.

Please drive safely, and enjoy your Kia vehicle!

© 2022 Kia America, Inc.

All rights reserved. May not be reproduced or translated in whole or in part without the written consent of Kia America, Inc.

Printed in Korea

How to use this manual

We want to help you get the greatest possible driving pleasure from your vehicle. Your Owner's Manual can assist you in many ways.

We strongly recommend that you read the entire manual. In order to minimize the chance of death or injury, you must read the WARNING and CAUTION sections in the manual.

Illustrations complement the words in this manual to best explain how to enjoy your vehicle. By reading your manual, you learn about features, important safety information, and driving tips under various road conditions.

The general layout of the manual is provided in the Table of Contents. Use the index when looking for a specific area or subject, it has an alphabetical listing of all information in your manual.

Chapters: This manual has nine chapters plus an index. Each chapter begins with a brief list of contents so you can tell at a glance if that chapter has the information you want.

You will find various WARNINGS, CAUTIONS, and NOTICES in this manual. These WARNINGS were prepared to enhance your personal safety. You should carefully read and follow ALL procedures and recommendations provided in these WARNINGS, CAUTIONS and NOTICES.

WARNING

A WARNING indicates a situation in which harm, serious bodily injury or death could result if the warning is ignored.

CAUTION

A CAUTION indicates a situation in which damage to your vehicle could result if the caution is ignored.

NOTICE

A NOTICE indicates interesting or helpful information is being provided.

Table of Contents

Electric vehicle guide	①
Introduction	②
Your vehicle at a glance	③
Safety features of your vehicle	④
Features of your vehicle	⑤
Driving your vehicle	⑥
What to do in an emergency	⑦
Maintenance	⑧
Specifications, Consumer information and Reporting safety defects	⑨
Abbreviation	Ⓐ
Index	Ⓛ

Overview of electric vehicle	1-3
• Characteristics of electric vehicles	1-3
• Battery information	1-3
Main components of electric vehicle	1-4
• High voltage (HV) battery (lithium-ion).....	1-4
• High voltage battery warmer system	1-5
EV menu	1-6
• EV mode screen.....	1-7
• Next departure.....	1-8
• Charging and climate.....	1-8
• Vehicle to load (V2L).....	1-9
• Nearby stations.....	1-14
• EV settings	1-14
Charge types for electric vehicle	1-17
• Charging information.....	1-17
• Charging time information	1-17
• Charging types.....	1-18
Charge indicator lamp for electric vehicle	1-19
• Charging status.....	1-19
Charging connector lock	1-19
• Locking charging cable	1-19
Scheduled charging	1-20
Charging electric vehicle	1-21
• Charging door	1-21
• Precautions for charging electric vehicle	1-21
• AC charge.....	1-23
• DC charge.....	1-25
• Portable charge	1-27
Charging electric vehicle (Abrupt stop)	1-35
• Actions to be taken when charging stops abruptly.....	1-35

1 Electric vehicle guide

Driving electric vehicle.....	1-36
• How to start the vehicle.....	1-36
• How to stop the vehicle.....	1-36
• Virtual vehicle Sound System (VESS).....	1-36
• Distance to empty.....	1-37
• ECO Driving.....	1-38
• Electricity Use	1-38
• Power/Charge gauge.....	1-39
• State of Charge (SOC) gauge for high voltage battery	1-39
• Warning and indicator lights (Related to electric vehicle)	1-40
• LCD display messages (Related to electric vehicle)	1-41
Safety precautions for electric vehicle	1-47

Electric vehicle guide

Overview of electric vehicle

An electric vehicle is driven using a battery and an electric motor. While general vehicles use an internal combustion engine and gasoline as fuel, electric vehicles use electrical energy that is charged & stored inside the high voltage battery.

As a result, battery electric vehicles do not require gasoline and do not give off tailpipe emissions.

Characteristics of electric vehicles

It is driven using the electrical energy that is charged & stored inside the high voltage battery. This method of propulsion eliminates tailpipe emissions from the vehicle.

A high performance electric motor is used in the vehicle as well. Compared to many internal combustion engine vehicles, vehicle noise and vibrations are much more minimal when driving.

When decelerating or driving downhill, regenerative braking is utilized to charge the high voltage battery. This reduces energy loss and can increase the distance to empty.

When the battery charge is not sufficient, AC charge (L2-Normal), DC charge and Trickle charge (L1-Trickle) are available. (Refer to "Charge types for electric vehicle" on page 1-17.)

* NOTICE

What Does Regenerative Braking Do?

It uses the electric motor when decelerating and braking and recaptures & transforms kinetic to electrical energy in order to charge the high voltage battery. (Torque is applied in the opposite direc-

tion when decelerating to generate braking force and electric energy.)

Battery information

The vehicle is composed of a high voltage battery that drives the motor, air conditioner, and charges an auxiliary battery (12V) that drives all other 12V systems.

The auxiliary battery is automatically charged when the vehicle is in the **READY** mode or the high voltage battery is being charged.

Main components of electric vehicle

- **On-Board Charger (OBC):** Transforms (inverts) AC power charge power, to DC power, to charge the high voltage battery.
- **Inverter:** Transforms direct current into alternating current to supply power to the motor, and transforms alternating current into direct current to charge the high voltage battery.
- **LDC:** Transforms (converts) power from the high voltage battery to low voltage (12V) to supply power to the vehicle (DC-DC).
- **VCU:** Functions as a supervisory controller of electric vehicle
- **Motor:** Uses electrical energy stored inside the high voltage battery to drive the vehicle (functions like an vehicle in a standard vehicle).
- **Reduction gear:** Delivers rotational force of the motor to the tires at appropriate speeds and torque.
- **High voltage battery (lithium-ion):** Stores and supplies power necessary for the electric vehicle to operate (12V auxiliary battery provides power to the vehicle features such as lights and wipers).

* OBC: On-Board Charger

* LDC: Low Voltage DC-DC Converter

* VCU: Vehicle Control Unit

WARNING

- Do not remove or disassemble high voltage components and high voltage battery connectors and/or wiring (orange cabling). Also, be careful not to damage high voltage components and the high voltage battery. It may cause serious injury and significantly

impact the performance and durability of the vehicle.

- When inspection and maintenance is required for high voltage components and the high voltage battery, have the vehicle inspected by an authorized Kia dealer.

High voltage (HV) battery (lithium-ion)

- The charge amount of the high voltage battery may gradually decrease when the vehicle is not driven or charged.
- The battery capacity of the high voltage battery may decrease over time when the vehicle is stored in high or low temperatures.
- Distance to empty may vary depending on the driving conditions (cargo, rain, snow, wind, road surfaces), even if the charge amount is the same. The high voltage battery may expend more energy when driving a fast pace or uphill. These actions may reduce the distance to empty.
- The high voltage battery is used when using the air conditioner/heater. This may reduce the distance to empty. Make sure to set moderate temperatures when using the air conditioner/heater and/or use the pre-conditioning feature prior to departures.
- Natural degradation may occur with the high voltage battery depending on the number of years the vehicle was used and/or the number of charging cycles. This will reduce the distance to empty over time.
- When the charge capacity and distance to empty suddenly or dramatically drops, contact an authorized Kia

dealer for inspection and maintenance.

- If the vehicle will not be in use for an extended period of time, charge the high voltage battery once every three months to prevent it from discharging. Also, if the vehicle battery charge is insufficient, immediately charge the vehicle to full capacity and store the vehicle.
- AC charging is recommended to keep the high voltage battery in optimal condition.
- If the high voltage battery charge amount is below 20%, you can keep the high voltage battery performance in optimal condition if you charge the high voltage battery to 100%. (Once a month or more is recommended.)
- The value of the high voltage battery charge level may vary according to the charging conditions (state of charger, outside temperature, battery temperature, etc.). In order to fully charge the battery, the current of the high voltage battery will be gradually decreased, so that the longevity and safety of the battery can be secured.

⚠ CAUTION

- Make sure to use a designated charger when charging the high voltage battery. Using non-approved or inappropriate type of chargers may have a serious impact on vehicle durability.
- If the vehicle is kept with insufficient charge for a long period, it may damage the high voltage battery and the high voltage battery may have to be replaced depending on the level of degradation.
- If the vehicle is in a collision, contact an authorized Kia dealer to inspect

whether the high voltage battery is still connected.

- Using the V2L function may reduce the mileage due to the use of high voltage battery energy, and repeated use of the V2L function may cause a decrease in the life of the high voltage battery.

High voltage battery warmer system (if equipped)

The high voltage battery warmer system prevents reduction of battery output when battery temperature is low. If the charging connector is connected, the warmer system automatically operates according to the battery temperature. Charging time may shorten compare to vehicles without the high voltage battery warmer system. But, the use of electricity charge may increase because of high voltage battery warmer system operation.

⚠ CAUTION

The high voltage battery warmer system operates when the charging connector is connected to the vehicle. However, the high voltage warmer system may not operate when battery temperature drops below -31 °F (-35 °C).

EV menu

If you select the **EV** menu at the multi-media system home screen, you can enter **EV** menu.



* The image of **EV** menu screen in this manual may differ from the actual screen depending on the vehicle specification and the version of the multi-media system software.

* INFORMATION

The infotainment system may change after software updates. For more information, refer to the manual provided in the infotainment system and the quick reference guide.

EV mode screen

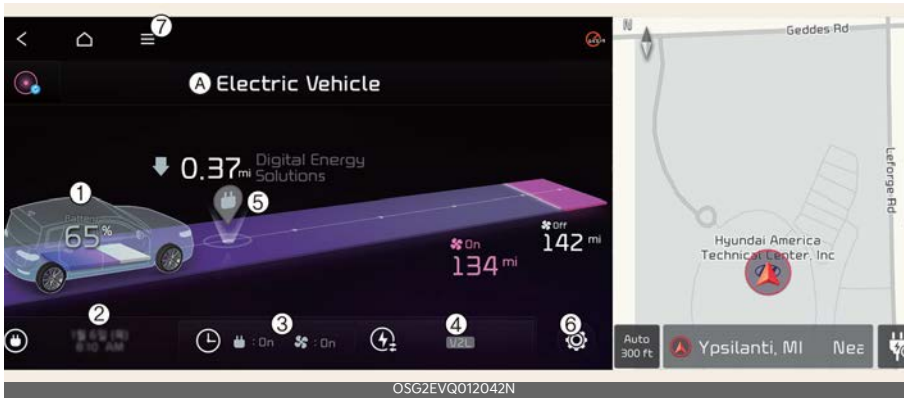

A. Electric Vehicle

- 1 Energy Information
- 2 Next Departure
- 3 Charging and Climate
- 4 Vehicle to Load (V2L)
- 5 Nearby Stations
- 6 EV Settings
- 7 Menu

Next departure



- A: Electric vehicle
- 1 Next departure

Select **EV** → **Next departure** on the screen. You can set the date and time of when to charge the battery, climate control temperature, and other various functions.

Departure time



- A: Next departure
- 1 Departure 1
- 2 Departure 2

1. Set anticipated departure time for scheduled charging and target temperature.
2. Select the day of the week to activate scheduled charging and target temperature for departure time.

* INFORMATION

The infotainment system may change after software updates. For more information, refer to the manual provided in the infotainment system and the quick reference guide.

Charging and climate



- A: Electric Vehicle
- 1 Scheduled charging and target temperature

Select **EV** → **Scheduled charging and target temperature** on the screen.

* NOTICE

Vehicle must be connected with the charging connector at the time pre-scheduled time for the scheduled charging.



- A: Scheduled charging and target temperature
- 1 Scheduled charging
- 2 Target temperature

You can set the date and time of when to charge the battery and the climate control temperature. Also, you may select the time to start charging using the Off-peak time settings.

Off-peak time settings



A: Off-peak Hours Settings

1 Start Time

2 End Time

- If selected, starts charging only on the designated off-peak time. If deselected, starts charging only on the scheduled time.
- Set the most inexpensive time to complete charging.

- **Off-peak tariffs prioritised:** If selected, starts charging at off-peak time (may keep on charging pass off-peak time to charge 100%).
- **Off-peak tariffs only:** If selected, charges only within off-peak time (may not charge 100%).

Scheduled Climate Settings

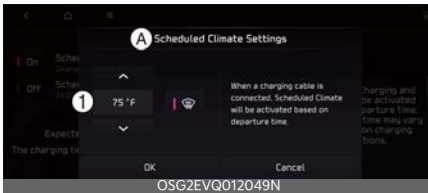

A: Scheduled Climate Settings

1 Target temperature

If the target temperature (1) is set with the cable connected, the cabin temperature will be adjusted to the target temperature at departure time. In cold weather, pre-scheduled heating helps enhance electric vehicle performance by heating the vehicle in advance.

* INFORMATION

The infotainment system may change after software updates. For more information, refer to the manual provided in the infotainment system and the quick reference guide.

Vehicle to load (V2L)

V2L is the system that provides AC power using the high voltage battery for driving to operate several electrical products.



A: Electric Vehicle

1 EV Charge Transfer

Select **EV** → **EV Charge Transfer** on the screen.

You can set the battery discharging limit for high voltage battery for driving.

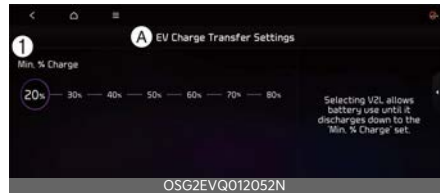

A: EV charge transfer settings

1 Min% Charge

If the vehicle reaches to the limit, it automatically cut supply of electricity.

* INFORMATION

The infotainment system may change after software updates. For more information, refer to the manual provided in

the infotainment system and the quick reference guide.

Energy information

Select **EV** and see the vehicle image from the infotainment system screen. You can check battery discharging level.

How to connect

Outdoor (if equipped)

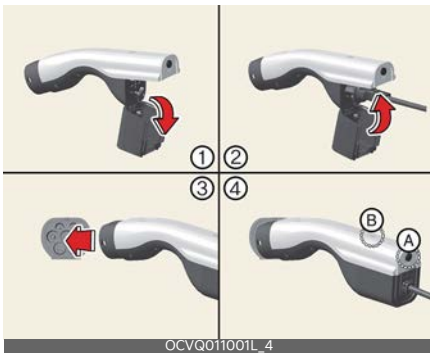

1. Open the cover of the V2L connector.
2. Close the cover after connecting home appliances and electronic products to the power outlet.
3. Connect the V2L connector to the charging hole on the vehicle.
4. Press the switch (A) of the V2L connector and check whether the light (B) is on or off. The light (B) may not turn on normally when:
 - See the battery discharging limit for high voltage battery for driving in **Energy consumption** menu on the screen. If it is higher than the current amounts of high voltage battery, the light (B) does not turn on.
 - Check whether the light of V2L connector or indoor power outlet turns on or not.

- If the warning message for V2L appears on the cluster, refer to "LCD display messages" on page 1-11.
 - If V2L does not operate previously when you connects another home appliances, visit an authorized Kia dealer.
5. Press the switch (A) to turn off the light (B) the V2L will be off. You can disconnect the V2 connector when the light (B) turns off or the charging door lock is deactivated pressing the door unlock button on the smart key.

Indoor (if equipped)

1. Connect to the power outlet located in bottom of the rear seat with the EV button in the ON (**READY**) position.
2. Use the mechanical key to unlock the power outlet cover.



3. Check the operation status through the front indicator of the power outlet.



- Blue: Standby
- Red: No power supply even the power outlet is connected
- Green: Normal power supply through the normal connection of the power outlet.

LCD display messages

V2L has ended. Battery level has reached the set value



A: V2L has ended. Battery level has reached the set value

When the high voltage battery level reaches the discharging limit set level, the V2L will stop and the warning will be displayed. If you want to use the V2L continuously, make the discharging limit set level lower than the present battery level.

V2L stopped due to excessive power use



A: V2L stopped due to excessive power use

If you use an electrical appliance that exceeds the maximum power output the vehicle can supply, it will stop working and display a warning message. Make sure that the total power consumption of your electrical appliance exceeds the V2L maximum power output.

V2L conditions not met



A: V2L conditions not met

If V2L is interrupted for any of the following reasons, a warning message is displayed.

- V2L connector switch off
- V2L connector overheating
- Opening the charging door while using the V2L indoor outlet

Make sure there are no problems with the V2L connector and the vehicle indoor outlet.

⚠ WARNING

- Do not touch the V2L connector of the terminal of the vehicle charging hole.
- Do not put metal objects to the V2L connector or charging hole. It might be a cause of electric shock.
- Do not touch the V2L connector, charging hole or power plug with a wet hand. It might be a cause of electric shock. Please handle with a dry hand all the time.
- Confirm whether there is foreign substance such as water or dust on the V2L connector, charging hole or power plug before connecting. If you connect it with foreign substances, it may be a cause of fire or electric shock.
- Do not remodel or disassemble the V2L connector. There is a risk of fire, electric shock or injury.

- When the power plug is connected or disconnected to the V2L connector or open or close the connector cover of the V2L, be careful not to be scratched on the hand.
- Do not charge in the following conditions. The accident might occur.
 - The V2L connector, charging hole, power plug or cable is damaged, corroded or rusted.
 - The connection part is loose.
- Do not use if the sheath of home appliance cables is damaged or broken. There is a risk of fire, electric shock or injury.
- Never use an electric heating appliance like iron, coffee pot, and toaster in the vehicle. It may cause a fire and injury.
- Be sure to disconnect the V2L connector from the vehicle when you are finished using V2L.
- When the high voltage battery charge reaches the set discharging limit(%), the operation stops, and a warning message is displayed on the instrument cluster. If you want V2L operation, set the discharging limit(%) lower than the current battery charge.
- When using various electric products, use them below the maximum power capacity that can be supplied by the vehicle.
- If you use an electrical appliance that exceeds the maximum power capacity that the vehicle can supply, the operation will stop and a warning message will be displayed on the instrument cluster. Make sure the total power consumption of the electrical appliance you use does not exceed the V2L maximum power capacity.

CAUTION

- Be well-informed of the manual to prevent accidents.
- The V2L discharging mode is blocked automatically in case of overheating. (When the discharging mode is blocked, check whether the V2L connector or power plug is contaminated, worn, corroded or broken or the home appliance capacity is over 16 A. If the temperature falls to proper level after it is left unattended, you can use it again. Use proper home appliances.)
- Do not remodel or disassemble the provided V2L connector. The failure caused by remodeling or disassembling is not covered by the warrant.
- Do not drop the V2L connector or give a strong impact to it.
- Do not place objects on the V2L connector.
- Some of the electric products may not operate normally even if the product has power consumption less than the maximum power capacity provided by the vehicle.
 - Electrical products that require high power during initial operation.
 - Measuring devices that need to process accurate data.
 - Electric products sensitive to inverter type AC power supply. (Inverter: A device that converts DC power into AC power)
- Do not use products that require a continuous power supply, such as medical equipment. The power supply may be interrupted depending on the vehicle's condition.

- Only use home appliances under 16 ampere.
- Put the power plug fully and use the qualified plug that meets the standard. If you use worn, corroded or broken plug or improper plug, it might be a cause of malfunction.
- Use the power plug with ground connection.
- Do not use high power home appliances such as air conditioner, washing machine or dryer.
- Do not hang home appliances on to the wire.
- For various devices connected to a power outlet, use only products that have obtained national safety certification. For usage and precautions, refer to the manual of the device. (Electrical appliances, multi-outlets, cord extension cables, etc.)
- For electronic devices that are used outdoors in a vehicle, use a product with a waterproof function or use it in a waterproof environment. Do not use in environments with rain or high humidity. (Electrical appliances, multi-outlets, cord extension cables, etc.)
- If there is a risk of lightning, do not use the V2L function outside the vehicle.
- Do not connect multiple portable multi-outlets.
- When using an extension cable, if the cable is twisted or overlapped by itself may cause a fire. Be sure to use the cable without twisting it.
- When using the vehicle's outdoor V2L connector, power is also supplied to the vehicle's indoor power outlet. Unplug electrical appliances that are not in use from the indoor power outlet.
- When using the V2L, the cooling fan in the vehicle motor compartment can operate automatically even if the vehicle is turned off. Do not put your hand near the cooling fan in the V2L operating state.

* NOTICE

- Please connect the V2L connector to the charging hole within 60 seconds after the charging cover opens. To prevent theft after connecting, it is changed to auto lock automatically so that it is impossible to separate.
 - When using V2L, cancel the scheduled air conditioning setting. V2L may not be available to operate if the scheduled air conditioning is being activated.
 - V2L discharging mode will shut off if the vehicle is turned off using indoor V2L.
 - Opening the charging door or connecting the V2L connector to the charging inlet, the V2L discharging mode will shut off. If you want to use the indoor and outdoor V2L simultaneously, firstly connect the V2L connector to the charging inlet and use the indoor V2L.
-

Nearby stations



A: Electric Vehicle

Select **EV** and see the map from the infotainment system screen. Stations around the current location are searched.



A: Electric Vehicle

Select the icon on the screen. Around the course, around the current site, around the selected destination or charging stations of interest will be searched. If you choose the charging station, the detailed information will be provided.

* INFORMATION

The infotainment system may change after software updates. For more information, refer to the manual provided in the infotainment system and the quick reference guide.

EV settings



A: Electric Vehicle

Select the icon on the screen. You can set the charging limit, charging current, battery conditioning mode and utility mode functions.

Charging limit

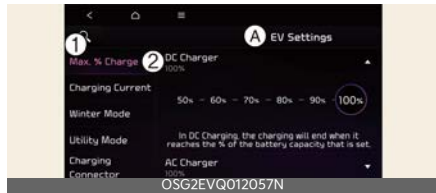

A: EV Settings

1 Max% Charge

2 DC Charger

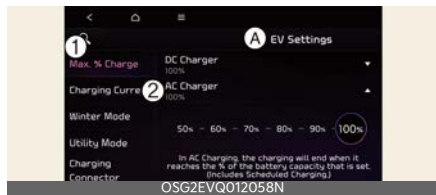

A: EV Settings

1 Max% Charge

2 AC Charger

- The target battery charge level can be selected when charged with AC charger or DC charger.
- The charging level can be changed by 10%.
- If the target battery charge level is lower than the high voltage battery

charge level, the battery will not be charged.

* INFORMATION

The infotainment system may change after software updates. For more information, refer to the manual provided in the infotainment system and the quick reference guide.

Charging current

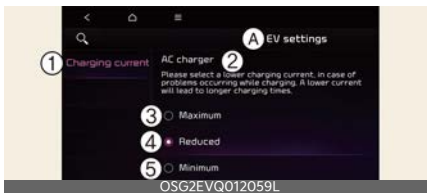

A: EV Settings

1 Charging current

2 AC Charger

3 Maximum

4 Reduced

5 Minimum

- You can adjust the charging current for an AC charger. Select an appropriate charging current.
- If the charging process does not start or abruptly stops in the middle, reselect another proper current and re-try charging the vehicle.
- Charging time varies depending on which charging current is selected.

* INFORMATION

The infotainment system may change after software updates. For more information, refer to the manual provided in the infotainment system and the quick reference guide.

Battery conditioning mode (if equipped)

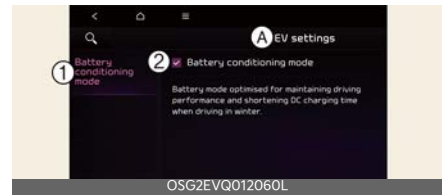

A: EV Settings

1 Battery conditioning mode

2 Battery conditioning mode

- The Battery conditioning mode is efficient during the winter time when the high voltage battery temperature is low. This mode is recommended to improve driving and DC charging performances during winter. However, the driving distance may be reduced as the energy is required to increase battery temperature.
- If the battery temperature is low during driving, Battery conditioning mode raises the battery temperature to an adequate level. Also, if the battery temperature is low when scheduled air conditioner/heater is activated, this mode is operated to improve driving and charging performance. However, the mode is not operated to ensure driving distance when the battery level is low.
- If you set the DC charging station as a destination in battery conditioning mode, you can reduce the charging time by raising the battery temperature to an adequate level when you arrive.
- Battery conditioning mode indicator light illuminates while battery conditioning mode is operating.

*** NOTICE**

This mode is available for the vehicles equipped with the battery heater.

*** INFORMATION**

The infotainment system may change after software updates. For more information, refer to the manual provided in the infotainment system and the quick reference guide.

Utility mode

The high voltage battery is used instead of the 12V auxiliary battery for operating the convenient features of the vehicle. When driving is not necessary such as while camping or when stopping the vehicle for a long time, it is possible to use the electrical devices (audio, lights, air conditioner, heater, etc.) for long hours.

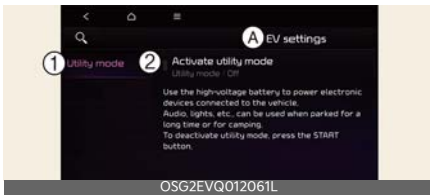

A: EV Settings

1 Utility mode

2 Activate utility mode

System setting and activation

System setting

The driver can activate the Utility mode function when the following conditions are satisfied.

- The vehicle is in **READY** mode and the gear is shifted to P (Park).

- The EPB (Electronic Parking Brake) is not a malfunction.
- **EV settings** → **Utility mode** is selected on the infotainment system screen.

System activation

When the system is activated:

- The **READY** indicator will turn off, and the **UTIL** indicator will appear on the cluster and the EPB is applied.
- All electric devices are usable but the vehicle cannot be driven.
- The EPB can be canceled by pressing the EPB switch.

Gear cannot be shifted out of P (Park). If a shift attempt is made, a warning message will be displayed on the infotainment system screen.

System deactivation

The Utility mode can be deactivated by pressing the EV button to the OFF position. The function cannot be deactivated from the **EV settings**.

*** INFORMATION**

The infotainment system may change after software updates. For more information, refer to the manual provided in the infotainment system and the quick reference guide.

Charge types for electric vehicle

Charging information

AC charge

The electric vehicle is charged by plugging into a AC charger installed at your home or a public charging station. (For further details, refer to "AC charge" on page 1-23.)

DC charge

You can charge at high speeds at public charging stations. Refer to the respective company's manual that is provided for each DC charger type.

Battery performance and durability can deteriorate if the DC charger is used constantly.

Use of DC charge should be minimized in order to help prolong high voltage battery life.

Portable charge

The Electric vehicle can be charged by using household electricity. The electrical outlet at your home must comply with regulations and can safely accommodate the Voltage/Current (Amps)/Power (Watts) ratings specified on the portable charge. (Portable charging cable: Sold separately)









Charging time information

Charging type		Charging time
AC charge	7 kW or equivalent	Takes approx. 9 hours 5 minutes at room temperature when charged from 10% to 100%.
	11 kW or equivalent	Takes approx. 6 hours 5 minutes at room temperature when charged from 10% to 100%.
DC charge	350 kW charger	Takes about 43 minutes at room temperature when charged from 10% to 80%. Can be charged to 100%.
	100 kW charger	Takes about 45 minutes at room temperature when charged from 10% to 80%. Can be charged to 100%.
	50 kW charger	Takes about 65 minutes at room temperature when charged from 10% to 80%. Can be charged to 100%.
Portable charge		Takes approx. 57 hours 5 minutes at room temperature when charged from 10% to 100%.

* NOTICE

Depending on the condition and durability of the high voltage battery, charger specifications, and ambient temperature, the time required for charging the high voltage battery may vary.

Charging types

Category	AC Charge	DC Charge	Portable Charge
Charging Inlet (Vehicle)	 OSG2EVQ011001	 OSG2EVQ011002	 OSG2EVQ011001
Charging Connector	 OCVQ011060	 OCVQ011061	 OCVQ011060
Charging Outlet	 OCVQ011007L	 OCVQ011008L	 OCVQ011009L
How to Charge	Use AC charger installed at home or public charging station	Use the DC charger at public charging station	Use household current

- * Depending on the condition and durability of the high voltage battery, charger specifications, and ambient temperature, the time required for charging the high voltage battery may vary.
- * Actual charger appearance and charging method may vary in accordance with the charger manufacturer.
- * A maximum diagnosis time of 3 minutes may be added to check the battery condition during the battery charging process.
- * Portable charging cable is sold separately.

⚠ CAUTION

- Risk of Electric Shock, Do Not Disconnect Under Load.
- Suitable For Use On A Circuit Capable Of Delivering Not More Than 30,000 rms Symmetrical Amperes, 1,000 Volts Maximum.

Charge indicator lamp for electric vehicle

Charging status

When charging the high voltage battery, the charge level can be checked from outside the vehicle.

Electric charging door



Lamp status	Color	Battery SOC [%]
	Yellow	0~19
	Green	20~34
	Green	35~64
	Green	65~
	Red	Fail to charge

* When charging, the indicator lamp blinks according to each level of the battery.

* When charging fails, the indicator lamp blinks in red.

Charging connector lock

Locking charging cable

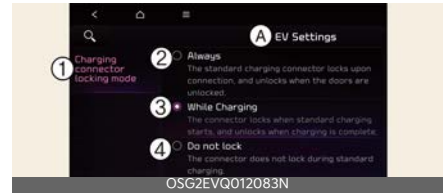

A: ECO Vehicle

1 Charging Connector Locking Mode

2 Always

3 While Charging

4 Do Not Lock

You may select when the charging connector can be locked and unlocked in the charging inlet.

Select **Setup** → **Vehicle** → **ECO Vehicle** → **Charging Connector Lock** in the infotainment system.

* INFORMATION

The infotainment system may change after software updates. For more information, refer to the user's manual provided in the infotainment system and the quick reference guide.

When the charging connector is locked

Category	Lock while charging	Always lock	Do not lock
Before charging	X	O	X
While charging	O	O	X
Finished charging	X	O	X

Always Lock mode

The connector locks when the charging connector is plugged into the charging inlet. The connector is locked until all

doors are unlocked by the driver. This mode can be used to prevent charging cable theft.

- If the charging connector is unlocked when all doors are unlocked, but the charging cable is not disconnected within 15 seconds, the connector will be automatically locked again.
- If the charging connector is unlocked when all doors are unlocked, but all doors are locked again, immediately, the connector will be automatically locked again.

Lock While Charging mode

The connector locks when charging starts. The connector unlocks when charging is complete. This mode can be used when charging in a public charging station.

Do Not Lock mode

The connector unlocks regardless of the state of charging. Press the charging connector release button, disconnect the connector. Be careful to theft of the charging cable.

Scheduled charging

You can set-up a charging schedule for your vehicle using the Infotainment system or Kia Connect application. Refer to the manual provided in the infotainment system and the quick reference guide for detailed information about setting scheduled charging.

Scheduled charging can only be done when using a AC charger or the portable charger (ICCB: In-Cable Control Box).

When scheduled charging is set and the AC charger or the portable charger (ICCB: In-Cable Control Box) is connected for charging, the indicator lamp blinks from the first level to the last for about 3 minutes to indicate that scheduled charging is set.



When scheduled charging is set, charging is not initiated immediately when the AC charger or portable charger (ICCB: In-Cable Control Box) is connected.

When immediate charging is required, press and hold the charging button on the charging door for 2 seconds or deactivate the scheduled charge setting with the infotainment system or Kia Connect application.



Refer to "AC charge" on page 1-23 or "Portable charge" on page 1-27 for details about connecting the AC charger and the portable charger (ICCB; In-Cable Control Box).

Charging electric vehicle

Charging door

Opening the charging door



Operation

- Press the right center edge of the charging door.
- The charging door cannot be opened when the vehicle is locked.

Closing the charging door



Operation

- Close the charging door by pressing rear center edge of the charging door.

Precautions for charging electric vehicle

AC charger



AC charging cable (if equipped)



OCVQ011063N

DC charger



OCVQ011008L

* Actual charger image and charging method may vary in accordance with the charger manufacturer.

Unlock charging connector in emergency



OSG2EVQ011010

If the charging cable does not detach due to battery discharge and failure of the electric wires, open the hood and slightly pull the emergency cable as shown above. The charging connector will then unlock.

⚠ WARNING

- Electromagnetic waves that are generated from the charger can seriously

impact medical electric devices, such as an implantable cardiac pacemaker. When using electronic medical devices, such as an implantable cardiac pacemaker, make sure to ask the medical team and manufacturer whether charging your electric vehicle will impact the operation of the medical electric devices, such as an implantable cardiac pacemaker.

- Check to make sure there is no water or dust on the charging cable connector and plug before connecting to the charger and charging inlet. Connecting while there is water or dust on the charging cable connector and plug may cause a fire or electric shock.
- Be careful not to touch the charging connector, charging plug, and the charging inlet when connecting the charger connector cable to the charging outlet and the charging inlet on the vehicle.
- Comply with the following in order to prevent electrical shock when charging:
 - Use a waterproof charger.
 - Do not touch the charging connector and charging plug with your hands wet, or do not stand in water or snow while connecting the charging cable.
 - Be careful when there is lightning.
 - Be careful when the charging connector and plug are wet.
- Immediately stop charging when you discover abnormal symptoms (e.g., smell, smoke, etc.)
- Replace the charging cable if the cable coating is damaged to prevent electrical shock.
- Only use the charging cable (if equipped) certified by Kia. If you use a

separate extension cable such as a reel or use an uncertified cable, it may cause abnormalities of electrical outlets, leading to fire or explosion.

- When connecting or removing the charging cable, make sure to hold the charging connector handle.

If you pull the cable itself (without using the handle), the internal wires may be disconnected or get damaged. This may lead to electric shock or fire.

Charging connector (Vehicle)//Charging plug (Charger)



- Do not leave the vehicle with the charging door open. An open charging door may indicate that the vehicle door has been unlocked and may be subject to vehicle theft.

⚠ CAUTION

- Always keep the charging connector and charging plug in clean and dry condition. Be sure to keep the charging cable in a condition where there is no water or moisture.
- Make sure to use the designated charger for charging the electric vehicle. Using any other charger may cause failure.

- Before charging the battery, turn the vehicle [OFF].
- When the vehicle is switched [OFF] while charging, the cooling fan inside the motor compartment may automatically operate. Do not touch the cooling fan while charging.
- Be careful not to drop the charging connector. The charging connector can be damaged.
- Do NOT use a extension cord, when using the L1-Trickle charger, as this may overheat and/or cause damage.

*** NOTICE**

When charging or right after charging the high voltage battery, the cooling will be made using air conditioner system in order to control the high voltage battery temperature.

At this time, the noise might occur by the air conditioner compressor and cooling fan, but this is due to normal operation.

AC charge



* Actual charger image and charging method may vary in accordance with the charger manufacturer.

How to connect AC charger

1. Depress the brake pedal and apply the parking brake.
2. Turn OFF all switches, shift to P (Park), and turn OFF the vehicle. If charging is initiated without the gear in P (Park), the charging will start after

the gear is automatically shifted to P (Park).

3. Open the charging door.



For more details, refer to "Charging door" on page 1-21.

4. Check if there is dust on the charging connector and charging inlet.
5. Hold the charging connector handle and connect it to the vehicle charging inlet. Push the connector all the way in. If the charging connector and charging terminal are not connected properly, this may cause a fire.
For more details, refer to "Charging status" on page 1-19.
6. Connect the charging plug to the electric outlet at a AC charging station to start charging.

7. Check if the charging indicator light (🔌) of the high voltage battery in the instrument cluster is turned ON. Charging is not active when the charging indicator light (🔌) is OFF. When the charging connector and charging plug are not connected properly, reconnect the charging cable to charge.

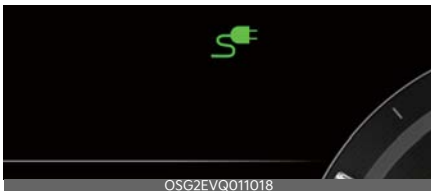

8. After charging has started, the estimated charging time is displayed on

the instrument cluster for about 1 minute.

If you open the driver seat door while charging, the estimated charging time is also displayed on the instrument cluster for about 1 minute. When scheduled charging or scheduled air conditioner/heater is set, the estimated charging time is displayed as "-".



A: Remaining Time

Checking charging status

When charging the high voltage battery, the charge level can be checked from outside the vehicle.

For more details, refer to "Charge indicator lamp for electric vehicle" on page 1-19.

How to disconnect AC charger

1. When charging is complete, remove the charging plug from the electrical outlet of the AC charging station.



2. Hold the charging connector handle and pull it out.

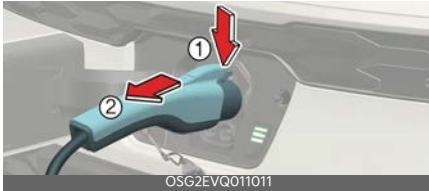

3. Make sure to completely close the charging door.
4. Close the protection caps of the charging connector and the charging plug to protect them from foreign substances.
5. If the personal charging connector is used, store the connector in the cable compartment.

* NOTICE

- If you cannot open the charging door due to freezing weather, tap lightly or remove any ice near the charging door. Do not try to forcibly open the charging door. If you open it by force, the charging door may be damaged.
- Select **EV** → setting icon on the screen → **Charging connector locking mode** in the infotainment. The charging connector is locked in the inlet at a different period according to which mode is selected.
 - **Always lock** mode: The connector locks when the charging connector is plugged into the charging inlet.
 - **Lock while charging** mode: The connector locks when charging starts.

The infotainment system may change after software updates. For more information, refer to the manual provided in the infotainment system and the quick reference guide.

- Even though charging is possible with the EV button in the ON/START position, for your safety, start charging when the EV button is in the OFF position and the vehicle shifted to P (Park). After charging has started, you can use electrical components such as the radio by pressing the EV button to the ACC or ON position.
- During AC charging, the radio reception may be bad.
- During charging, the gear cannot be shifted from P (Park) to any other gear.
- Depending on the condition and durability of the high voltage battery, charger specifications, and ambient temperature, the time required for charging the battery may vary.

DC charge



You can charge at high speeds at public charging stations. Refer to the respective company's manual that is provided for each DC charger type.

Battery performance and durability can deteriorate if the DC charger is used constantly.

Use of DC charge should be minimized in order to help prolong high voltage battery life.

Actual charger image and charging method may vary in accordance with the charger manufacturer.

How to connect DC charger

1. Depress the brake pedal and apply the parking brake.
2. Turn OFF all switches, shift to P (Park), and turn OFF the vehicle.
3. Open the charging door.
For more details, refer to "Charging door" on page 1-21.

4. Check whether there is dust or foreign substances inside the charging connector and charging inlet.
5. Hold the charging connector handle and connect it to the vehicle charging inlet. Push the connector all the way in. If the charging connector and charging terminal are not connected properly, this may cause a fire. Refer to the manual for each type of DC charger for how to charge and remove the charger.

6. Check if the charging indicator light (S) of the high voltage battery in the instrument cluster is turned ON. Charging is not active when the charging indicator light (S) is OFF. When the charging connector is not connected properly, reconnect the charging cable to charge it again.

During cold weather, DC charging may not be available to prevent high voltage battery degradation.



7. After charging has started, the estimated charging time is displayed on the instrument cluster for about 1 minute. If you open the driver seat door while charging, the estimated

charging time is also displayed on the instrument cluster for about 1 minute.



A: Remaining Time

Checking charging status

When charging the high voltage battery, the charge level can be checked from outside the vehicle.

For more details, refer to "Charge indicator lamp for electric vehicle" on page 1-19.

How to disconnect DC charger

1. Remove the charging connector when DC charging is completed, or after you stop charging using the DC charger. Refer to each respective DC charger manual for details about how to disconnect the charging connector.
2. Make sure to completely close the charging door.

* NOTICE

- If you use a DC charger when the vehicle is already fully charged, some DC chargers will send out an error message. When the vehicle is fully charged, do not charge the vehicle.
- If you cannot open the charging door due to freezing weather, tap lightly or remove any ice near the charging door. Do not try to forcibly open the charging door.
- To control the temperature of the high voltage battery while charging, the air conditioner is used to cool down the battery which may generate noise

from operation of the air conditioner compressor and cooling fan.

Also, the air conditioner's performance may be degraded during summer due to operation of the cooling system for the high voltage battery.

- Even though charging is possible with the EV button in the ON/START position, for your safety, start charging when the EV button is in the OFF position and the vehicle shifted to P (Park). After charging has started, you can use electrical components such as the radio by pressing the EV button to the ACC or ON position.

During charging, the gear cannot be shifted from P (Park) to any other gear.

- Depending on the condition and durability of the high voltage battery, charger specifications, and ambient temperature, the time required for charging the battery may vary.

Portable charge



- 1 Code and Plug (Code set)
- 2 Control Box
- 3 Charging Cable and Charging Connector

Portable Charge can be used when AC Charge or DC Charge is not available by using household electricity.

Setting the charge level of the portable charger



- A: Plug
 - B: Electric Outlet
1. Check the rated current of the electric outlet prior to connecting the plug to the outlet.
 2. Connect the plug to a household electric outlet.
 3. Check the display window on the control box.
 4. Press the button (1) on the back of the control box for 2 to 8 seconds to adjust the charge level. (Refer to charging cable type and example for setting the charge level.)



5. The charge level on the display window of the control box changes every time you press the button (1).
6. When setting the charge level is complete, start charging according to the portable charge procedure.

* Example for setting the ICCB charge level

* The example is only for reference and may vary according to the surrounding environment.

Outlet current	ICCB charge level	Control box display window
14-16A	12A	
13-12A	10A	
11-10A	8A	
9-8A	6A	

CAUTION

Please make sure that charge level selection matches the capacity of your circuit breaker to avoid blown fuse.

How to connect portable charger (ICCB: In-Cable Control Box)

1. Connect the plug to a household electric outlet.

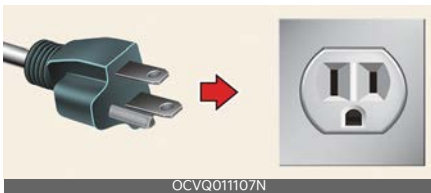

- A: Plug
- B: Electric Outlet

2. Check if the power lamp (green) appears on the control box.



3. Depress the brake pedal and apply the parking brake.
4. Turn OFF all switches, shift to P (Park), and turn OFF the vehicle. If charging is initiated without the gear

in P (Park), the charging will start after the gear is automatically shifted to P (Park).

5. Open the charging door.
For more details, refer to "Charging door" on page 1-21.
6. Open the protection caps of the charging connector and the charging plug. Check if there are any foreign substances or dust.
7. Hold the charging connector handle and connect it to the vehicle charging inlet. Push the connector all the way in. If the charging connector and charging terminal are not connected properly, this may cause a fire.
8. Charging starts automatically (charging lamp appears).



9. Check if the charging indicator light (⚡) of the high voltage battery in the instrument cluster is turned ON. Charging is not active when the charging indicator light (⚡) is OFF. When the charging connector is not connected properly, reconnect the charging cable to charge it again.



10. After charging has started, the estimated charging time is displayed on the instrument cluster for about 1 minute.



A: Remaining Time

If you open the driver seat door while charging, the estimated charging time is also displayed on the instrument cluster for about 1 minute. When scheduled charging or scheduled air conditioner/heater is set, the estimated charging time is displayed as "-".

Checking charging status

When charging the high voltage battery, the charge level can be checked from outside the vehicle.

For more details, refer to "Charge indicator lamp for electric vehicle" on page 1-19.

* NOTICE

- If you cannot open the charging door due to freezing weather, tap lightly or remove any ice near the charging door. Do not try to forcibly open the charging door.
- Select **EV** → setting icon on the screen → **Charging connector lock-**

ing mode in the infotainment system. The charging connector is locked in the inlet at a different period according to which mode is selected.

- **Always lock** mode: The connector locks when the charging connector is plugged into the charging inlet.
- **Lock while charging** mode: The connector locks when charging starts.

For more details, refer to "Charging connector lock" on page 1-19.

- Even though charging is possible with the EV button in the ON/START position, for you safety, start charging when the EV button is in the OFF position and the vehicle shifted to P (Park). After charging has started, you can use electrical components such as the radio by pressing the EV button to the START or ON position.

During charging, the gear cannot be shifted from P (Park) to any other gear.

- Depending on the condition and durability of the high voltage battery, charger specifications, and ambient temperature, the time required for charging the battery may vary.

* INFORMATION

The infotainment system may change after software updates. For more information, refer to the manual provided in the infotainment system and the quick reference guide.

How to Set the Charge Level of the Portable Charger

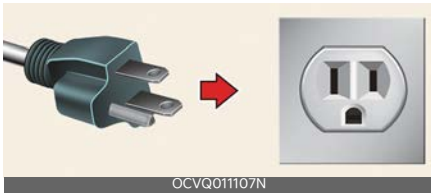

1. Check the rated current of the electric outlet prior to connecting the plug to the outlet.
2. Connect the plug to a household electric outlet.
3. Check the display window on the control box.
4. Press the button (1) on the front of the control box for 2 to 8 seconds to adjust the charge level. (Refer to charging cable type and example for setting the ICCB charge level.)



5. The charge level on the display window of the control box changes every time you press the button (1).
6. When setting the charge level is complete, start charging according to the portable charge procedure.

Example for setting the ICCB charge level

The example is only for reference and may vary according to the surrounding environment.



Outlet current	ICCB charge level
14~16 A	12 A
12~13 A	10 A
10~11 A	8 A
8~9 A	6 A

CAUTION

Please make sure that charge level selection matches the capacity of your circuit breaker to avoid blown fuse.

Charging status indicator lamp for portable charger



Indicator		Details
POWER		On: Power on
CHARGE		On: Charge Blink: Current limit due to high plug temperature or high internal temperature
FAULT		Blink: Charging interrupted
CHARGE LEVEL	12	12 A
	10	10 A
	08	8 A
	06	6 A
	The charging current changes whenever the button (1) is pressed for less than 1 sec with the charger plugged into an electrical outlet but not the vehicle.	
<p>Control box</p> <p>OCVQ011021L</p>		

1

Status/Diagnosis/Countermeasure



- Charging connector plugged into vehicle (**POWER** Green ON)
- Plug connected to an electric outlet (**POWER** Green ON)

While charging



- Charge indicator (**POWER** Green ON/**CHARGE** Blue ON)
- Charging current

Before plugging charging connector into vehicle (POWER Green ON, FAULT Red blink)



- Abnormal temperature
- ICCB (In-Cable Control Box) failure

Plugged into vehicle (POWER Green ON, FAULT Red Blink)



- Diagnostic device failure
- Current leakage
- Abnormal temperature

Leakage current failure (POWER Green ON, FAULT Red Blink)



- Disconnect and reconnect the power plug to clear the error.

Power saving mode



- Charge level indicator is turned off if there is no status change for more than 1 minute.

How to disconnect portable charger (ICCB: In-Cable Control Box)

1. Hold the charging connector handle and pull it out.



2. Make sure to completely close the charging door.
3. Disconnect the plug from the household electric outlet. Do not pull the cable when disconnecting the plug.



A: Plug

B: Electric Outlet

4. Close the protection caps of the charging connector and the charging plug to protect them from foreign substances.
5. If the personal charging connector is used, store the connector in the cable compartment.

Precautions for portable charger (ICCB: In-Cable Control Box)

- Do not touch the plug and charging connector with wet hands.
- Do not touch the terminal part of the AC charging connector and the AC charging inlet on the vehicle.
- Do not connect the charging connector to voltage that does not comply with regulations.
- Do not use the portable charger if it is worn out, exposed, or there exists any type of damage on the portable charger.
- If the ICCB case and AC charging connector is damaged, cracked, or the wires are exposed in any way, do not use the portable charger.
- Do not let children operate or touch the portable charger.
- Keep the control box free of water.
- Keep the normal charging connector or plug terminal free of foreign substances.
- Do not step on the cable or cord. Do not pull the cable or cord and do not twist or bend it.
- Do not charge when there is lightning.
- Do not drop the control box or place a heavy object on the control box.
- Do not place an object that can generate high temperatures near the charger when charging.
- Charging with the worn out or damaged household electric outlet can result in a risk of electric shock. If you are in doubt to the household electric outlet condition, have it checked by a licensed electrician.
- Stop using the portable charger immediately if the household electric outlet or any components is overheated or you notice burnt odors.

*** NOTICE**

To prevent charging cable theft, the charging connector cannot be disconnected from the inlet when the doors are locked or the charging connector is in the **Always lock** mode. Unlock all doors to disconnect the charging connector from the inlet.

However, if the vehicle is in the charging connector **Lock while charging** mode, the charging connector automatically unlocks from the inlet when charging is completed.

If the charging connector is disconnected while the release button is not pressed, the connector and the inlet may be damaged.

For more details, refer to "Charging connector lock" on page 1-19.

If the release button does not work even after the all doors are unlocked, pull the emergency lift cable in the motor room and press the release button in the connector to disconnect it from the vehicle. If the release button still does not work, visit an authorized Kia dealer.

Charging electric vehicle (Abrupt stop)

Actions to be taken when charging stops abruptly

When you cannot charge the high voltage battery after connecting the charger, check the following:

1. Check the charging setting for the vehicle. Refer to "EV settings" on page 1-14. (e.g. When scheduled charging is set, charging is not initiated immediately when the AC charger or portable charger (ICCB: In-Cable Control Box) is connected.)
2. Check the operation status of AC charger, portable charger and DC charger. (Refer to "Charging status" on page 1-19.)
* Actual method for indicating the charging status may vary in accordance with the charger manufacturer.
3. When the vehicle does not charge and a warning message appears on the cluster, check the corresponding message. Refer to "LCD display messages (Related to electric vehicle)" on page 1-41.
4. If the vehicle is properly charged when charged with another normally working charger, contact the charger manufacturer.
5. If the vehicle does not charge when charged with another normally working charger, contact an authorized Kia dealer for inspection.
6. If charging fails and the service warning light () is lit in the cluster, contact an authorized Kia dealer.

Driving electric vehicle

How to start the vehicle

1. With the smart key in the vehicle, sit in the driver's seat.
2. Fasten the seat belt before starting the vehicle.
3. Make sure to engage the parking brake.
4. Make sure to depress and hold the brake pedal.
5. Make sure the vehicle is in P (Park).
6. Depress and hold the brake pedal while pressing the EV button.
7. When the **READY** indicator is ON, you can drive the vehicle. When the **READY** indicator is OFF, you cannot drive the vehicle. Start the vehicle again.

Vehicle ON → **READY** (Green)



8. Press and hold the brake pedal and shift to the desired position.
9. Release the parking brake and slowly release the brake pedal. Check if the vehicle slowly moves forward, then depress the accelerator pedal.

* NOTICE

While the charging cable is connected, the gear cannot be shift from P (Park) to any other gear for safety reasons.

How to stop the vehicle

1. Hold down the brake pedal while the vehicle is parked.

2. Shift to P (Park).
3. Engage the parking brake.
4. Press the EV button and turn off the vehicle.
5. Check if the **READY** indicator is turned OFF in the instrument cluster.

Vehicle OFF



⚠ WARNING

When the **READY** indicator in ON and the gear is in a position other than P (Park), the driver can accidentally depress the accelerator pedal, causing the vehicle to move unexpectedly.

Virtual vehicle Sound System (VESS)

Virtual vehicle Sound System (VESS) generates an vehicle sound for pedestrians to hear the vehicle because there is no sound while the Electric Vehicle (EV) is operating.

If the vehicle is in the **READY** mode and the gear is not in P (Park), the VESS will operate.

When the gear is shifted to R (Reverse), an additional warning sound will be heard.

⚠ WARNING

The sound system only plays a supplementary role. The system is not designed to and does not replace the care of drivers. Drivers should always

pay attention to their surroundings while driving.

⚠ CAUTION

- The vehicle is much quieter while driving than a conventional gasoline-powered vehicle. Be aware of your surroundings and always drive safely.
- After you park the vehicle or while you are waiting at a traffic light, check whether there are children or obstacles around the vehicle.
- Check if there is something behind the vehicle when driving in reverse. Pedestrians may not hear the sound of the vehicle.

Distance to empty



The distance to empty is displayed differently according to the selected drive mode in the drive mode integrated control system.

- On average, a vehicle can drive approximately 253 mile (407 km).
 - * Estimated range based on manufacturer testing.

* NOTICE

Your mileage will vary depending on a number of factors, including battery age, ambient temperature, driving habits, options, cargo, and others. EPA estimates, when available, can be found at fuelconomy.gov.

- Under certain circumstances where the air conditioner/heater is ON, the distance to empty is impacted, resulting in a possible distance range from 150~350 mile (241~563 km). When using the heater during cold weather or driving at high speed, the high voltage battery consumes a lot more electricity. This may reduce the distance to empty significantly.
- After '0 km' has been displayed, charge the vehicle immediately. The vehicle can drive an additional 2~5 miles (3~8 km) depending on driving speed, heater/air conditioner, weather, driving style, and other factors. Drive your vehicle at approximately 30 mph (50 km/h) to the nearest charging station.

- Distance to empty that is displayed on the instrument cluster after completing a recharge may vary significantly depending on previous operating patterns.

When previous driving patterns include high speed driving, resulting in the high voltage battery using more electricity than usual, the estimated distance to empty is reduced. When the high voltage battery uses little electricity in **ECO** mode, the estimated distance to empty increases.

- Distance to empty may depend on many factors such as the charge amount of the high voltage battery, weather, temperature, durability of the battery, geographical features, and driving style.

When the outside temperature drops, such as in winter, the distance to empty may decrease due to battery performance degradation.

- Natural degradation may occur with the high voltage battery depending on the number of years the vehicle is used. This may reduce the distance to empty.

Tips for improving distance to empty

- If you operate the air conditioner/ heater frequently, the driving battery uses more electricity. This may reduce the distance to empty. Therefore, it is recommended that you set the cabin temperature to 72 °F (22 °C) AUTO. Turn OFF the heater and air conditioner if you do not need them. Also, repeatedly turning the heater and air conditioning on and off is not recommended.
- When the heater or air conditioning system is on the energy consumption is reduced if recirculation mode is selected instead of selecting the fresh mode. The fresh mode requires large amount of energy consumption as the outside air has to be re-heated or cooled.
- When using the heater or air conditioning system, use the DRIVER ONLY or scheduled air conditioner/heater function.
- Gradually depress and release the accelerator pedal when accelerating or decelerating.
- Always maintain specified tire pressures.
- Do not use unnecessary electrical components while driving.
- Do not load unnecessary items in the vehicle.
- Do not mount parts that may increase air resistance.

ECO Driving



A: Electric Vehicle

1 Energy information

Select **Menu** → **Energy information** on the screen. You can check ECO level information and ECO driving history.

Electric Energy Economy History

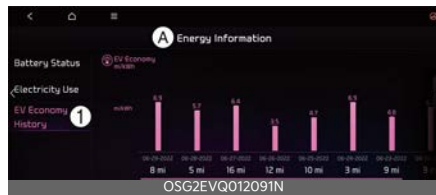

A: Energy information

1 EV Economy History

You can check the driving date, driving distance, and the average energy consumption rating for the last 30 driving trips.

Electricity Use

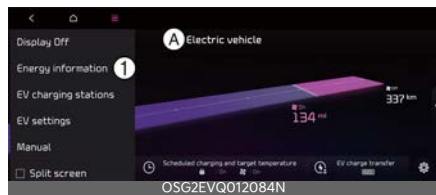

A: Electric Vehicle

1 Energy information

Select **Menu** → **Energy information** on the screen. You can check the current energy consumption for each system of the vehicle.



A: Electricity Use

- 1 Drivetrain:** Shows the total power and energy consumption of the driving motor's driving energy and regenerative energy.
- 2 Climate:** Shows the power and energy consumption which are used by the heater or air conditioner.
- 3 Electronics:** Shows the power and energy consumption which are used by the vehicle systems including the cluster, infotainment system (speaker and navigation), headlamp, vehicle control unit, etc.
- 4 Battery Care:** Shows the momentary power and energy consumption which are used to:
 - Operate the battery conditioning mode to increase the battery temperature during winter to improve the driving performance.
 - Cool down the battery temperature during summer to prevent overheating of the battery.

Power/Charge gauge



The Power/Charge Gauge shows the energy consumption rate of the vehicle and the charge/discharge status of the regenerative brakes.

- **Power:** It shows the energy consumption rate of the vehicle when driving uphill or accelerating. The more electric energy is used, the higher the gauge level.
- **Charge:** It shows the charging status of the battery when it is being charged by the regenerative brakes (decelerating or driving on a downhill road). The more electric energy is charged, the lower the gauge level.

State of Charge (SOC) gauge for high voltage battery



The SOC gauge shows the charging status of the high voltage battery.

The low percentage number on the indicator indicates that there is a limited amount of driving range in the high voltage battery. 100% indicates that the driving battery is fully charged.

When driving on highways or motorways, make sure to check in advance if the driving battery is charged enough.

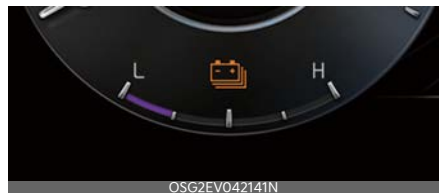

When the remaining battery is lower than 10% on the SOC gauge, the warning light (battery icon with lightning bolt) turns ON to alert you of the battery level.

When the warning light (battery icon with lightning bolt) turns ON, the vehicle can drive approximately an

additional 18~25 miles (30~40 km) depending on the driving speed, heater/ air conditioner, weather, driving style, and other factors. Charging is required.

*** NOTICE**

When the high voltage battery range is 25~30 miles (40~50 km), the vehicle speed is limited, and then eventually the vehicle will turn OFF. Charge the vehicle immediately.

Warning and indicator lights (Related to electric vehicle)

The warning light and indicator light indicate the situation where the driver should be careful and whether the various functions are activated.

Ready indicator READY

This indicator appears:

When the vehicle is ready to be driven.

- ON: Normal driving is possible.
- OFF: Normal driving is not possible, or a problem has occurred.
- Blinking: Emergency driving.

When the ready indicator goes OFF or blinks, there is a problem with the system. In this case, have your vehicle inspected by an authorized Kia dealer.

Service warning light 

This warning light appears:

- When the EV button is in the ON position.
 - It appears for approximately 3 seconds and then goes off.

- When there is a problem with related parts of the electric vehicle control system, such as sensors, etc.

When the warning light appears while driving, or does not go OFF after starting the vehicle, have your vehicle inspected by an authorized Kia dealer.

Power down indicator light 

This indicator appears:

- When the EV button is in the ON position.
 - It appears for approximately 3 seconds and then goes off.
- When the power is limited for the safety of the high-powered parts of an electric vehicle. The power is limited for the following reasons.(Unless both Service Warning Light and Power Down Indicator Light appear at the same time, it is not a failure.)
 - The high voltage battery level is too low or voltage is decreasing
 - The temperature of the high voltage battery is too high or too low
 - The temperature of the motor is high

*** NOTICE**

Do not accelerate or start the vehicle suddenly when the Power Down Indicator Light is ON.

Charge the battery immediately when the high voltage battery level is not enough.

*** NOTICE**

When the power is limited for the safety of the high-powered parts of an electric vehicle, the power down indicator light illuminates. Your vehicle may not be

driven, or may roll back on a slope with the indicator light ON due to the limitation of the vehicle power.

Charging cable connection indicator light

This indicator appears:

This indicator appears when the charging cable is connected.

Regenerative brake warning light (Red color) (Yellow color)

This warning light appears:

When the regenerative brake does not operate and the brake does not perform well. This causes the Brake Warning light (red) and Regenerative Brake Warning Light (yellow) to appear simultaneously.

In this case, drive safely and have the vehicle inspected by an authorized Kia dealer.

The operation of the brake pedal may be more difficult than normal, and the braking distance can increase, as it may default to manual hydraulic mode.

High voltage battery low level warning light

This warning light appears:

When the high voltage battery level is low.

When the warning light turns ON, charge the battery immediately.

LCD display messages (Related to electric vehicle)

Shift to P to charge

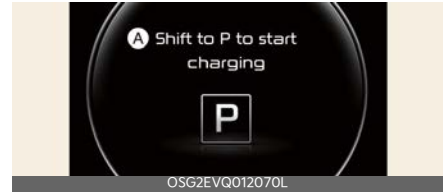

A: Shift to P to charging

This message is displayed if you connect the charging cable without the gear in the P (Park) position.

Shift to P (Park) before connecting the charging cable.

Low EV battery

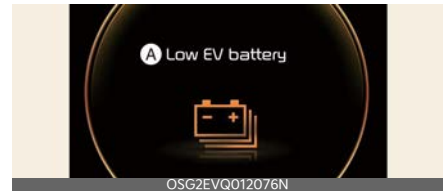

A: Low EV battery

When the high voltage battery level reaches around 15% or less, this warning message is displayed.

The warning light on the instrument cluster () will turn on simultaneously. Charge the battery immediately.

Charge immediately. Power limited



A: Charge immediately. Power limited

When the high voltage battery level reaches around 5% or less, this warning message is displayed.

The warning light on the instrument cluster (A) will turn on simultaneously. The vehicle's power will be reduced to minimize the energy consumption of the high voltage battery. Charge the battery immediately.

Check electric vehicle system



A: Check electric vehicle system

This warning message is displayed when there is a problem with the electric vehicle control system.

⚠ WARNING

Refrain from driving when the warning message is displayed. If this occurs, park the vehicle in a safe location and have your vehicle towed to the nearest authorized Kia dealer and have the vehicle inspected.

Power limited

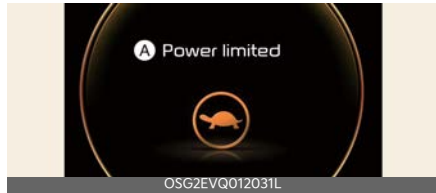

A: Power limited

In the following cases, this warning message is displayed when the vehicle's power is limited for safety.

- When the power is limited for the safety of the high-powered parts of an electric vehicle. The power is limited for the following reasons (Unless both Service Warning Light and Power Down Indicator Light appear at the same time, it is not a failure.):
- The high voltage battery level is too low or voltage is decreasing.
- The temperature of the high voltage battery is too high or too low.
- The temperature of the motor is high.

⚠ WARNING

When this warning message is displayed, do not accelerate or start the vehicle suddenly. Charge the battery immediately when the high voltage battery level is not enough.

*** NOTICE**

When the power is limited for the safety of the high-powered parts of an electric vehicle, the power down indicator light appears. Your vehicle may not be driven, or may roll back on a slope with the indicator light ON.

Power limited due to low EV battery temperature. Charge battery



A: Power limited due to low EV battery temperature. Charge battery

The warning message is displayed to protect the electric vehicle system when you turn off the vehicle while outside temperature is low. If the high voltage battery charging level is low and parked outside in low temperature for a long time, vehicle power could be limited. Charging the battery before driving, increases the battery temperature, and helps increase power.

⚠ CAUTION

- If this warning message is still displayed even when the ambient temperature is sufficiently high, have the vehicle inspected by an authorized Kia dealer.
- When the battery temperature is extremely low in winter, the battery temperature optimization is conducted for normal driving conditions. The optimization time may vary depending on the battery temperature and charging conditions.
- If the high voltage battery level and temperature is too low, the power may be limited. When the warning message is displayed, please charge the vehicle immediately.



A: Charge immediately. Power limited



A: Low EV battery temp. Power limited

Battery conditioning activated. Park safely. This may take up to 30 min. / Battery conditioning complete. Ready to drive.



A: Battery conditioning activated. Park safely. This may take up to 30 min.

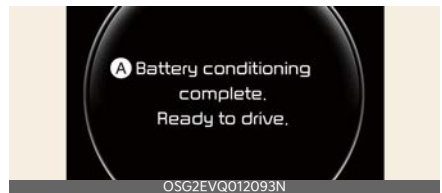

A: Battery conditioning complete. Ready to drive.

When the battery temperature and the high voltage battery level are too low, this warning message is displayed. If you can charge the vehicle immediately, please drive after charging enough. If you can't, please drive after waiting for the battery temperature optimization to finish.

Battery Overheated! Pull over safely and leave the vehicle



A: Battery Overheated! Pull over safely and leave the vehicle

This warning message is displayed to protect battery and electric vehicle system when the high voltage battery temperature is too high.

Turn off the EV button and stop the vehicle so that the battery temperature decreases.

⚠ WARNING

If this warning is still displayed even after the EV button has been turned off for sufficient time, refrain from driving and have the vehicle inspected by an authorized Kia dealer.

Stop vehicle and check power supply



A: Stop vehicle and check power supply

This warning message is displayed when a failure occurs in the 12 V power supply system.

If this occurs, park the vehicle in a safe location, tow your vehicle to the nearest authorized Kia dealer and have the vehicle inspected.

Unplug vehicle to start

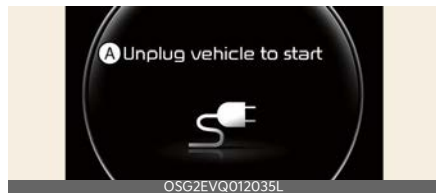

A: Unplug vehicle to start

This message is displayed when you start the vehicle, without unplugging the charging cable, and will not shift out of park. Unplug the charging cable, and then turn on the vehicle.

Charging Door Open

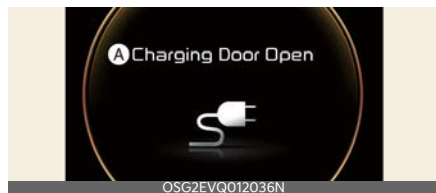

A: Charging Door Open

This message is displayed when the vehicle is driven with the charging door opened. Close the charging door and then start driving.

Remaining Time



A: Remaining Time

* The remaining charging time in the LCD image may differ from actual charging time.

This message is displayed to notify the remaining time to charge the battery, to the selected target battery charge level, and the charge voltage level.

Charging Stopped. Check the charger

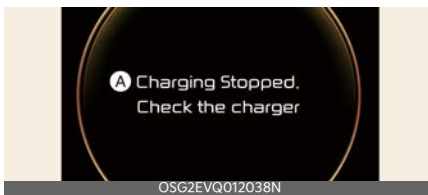

A: Charging Stopped. Check the charger

This warning message is displayed when charging is stopped for the reasons below:

- There is a problem with the external AC charger or DC charger.
- The external AC charger stopped charging
- The charging cable is damaged.

If this occurs, check whether there is any problem with the external AC or DC charger and charging cable.

If the same problem occurs when charging the vehicle with a well-functioning external charger or genuine Kia portable charger, have your vehicle inspected by an authorized Kia dealer.

Charging Stopped. Check the cable connection



A: Charging Stopped. Check the cable connection

This warning message is displayed for the reasons below:

- The charging connector is not correctly connected to the charging inlet.
- The charging connector lock release button is pressed.

If this occurs, separate the charging connector and re-connect it.

Check whether there is any problem (external damage, foreign substances, etc.) with the charging connector and charging inlet.

If the same problem occurs when charging the vehicle with a replaced charging cable or genuine Kia portable charger, have your vehicle inspected by an authorized Kia dealer.

Check regenerative brakes



A: Check regenerative brakes

This warning message is displayed when the regenerative brake system does not work properly.

In this case, have your vehicle inspected by an authorized Kia dealer.

Check Virtual vehicle Sound System

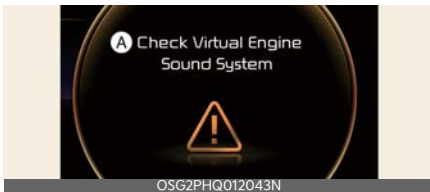

A: Check Virtual vehicle Sound System

This message is displayed when there is a problem with the Virtual vehicle Sound System (VSS).

In this case, have your vehicle inspected by an authorized Kia dealer.

Check Active Air Flap System

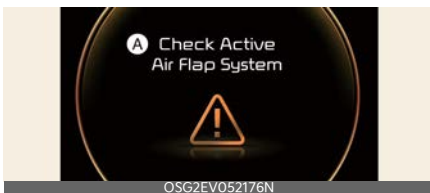

A: Check Active Air Flap System

This warning message is displayed in the following situations:

- There is a malfunction with the actuator flap
- There is a malfunction with the actuator air flap controller
- The air flap does not open

When all of the above conditions are fixed, the warning will disappear.

In this case, have your vehicle inspected by an authorized Kia dealer.

Refill coolant



A: Refill coolant

This message is displayed when the coolant is low. If the warning message is displayed, stop driving and check the amount of coolant. Driving without sufficient amount of coolant for a prolonged period of time can cause serious problems with the vehicle's electrical equipment and make normal driving impossible.

Safety precautions for electric vehicle

If an accident occurs

If towing is required, tow the vehicle with a flatbed equipment or dollies with all wheels off the ground.

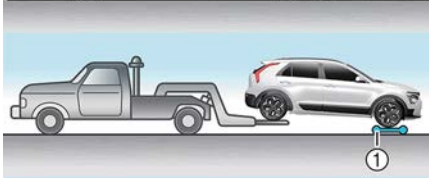

OSG2EV061005



OSG2EV061006



OSG2EV061007

1 Dollies

If you must tow the vehicle using only two wheels, lift the rear wheels off the ground and tow the vehicle.

If necessary to roll the vehicle so that it can be rolled onto a flatbed tow truck perform the following:

- First, depress the brake pedal and release the parking brake.
- Wait 3 minutes or more before opening the driver door and the vehicle will remain in ACC mode and in N (Neutral).
- If the driver door is opened within the 3 minute period, the vehicle will automatically shift to P (Park), the vehicle will turn OFF and the front wheels will be remained locked.

High voltage cut-off switch



OSG2EVQ011013

In case of emergency, pull the yellow lever in the high voltage cut-off switch to shut down high voltage battery.

Other precautions for electric vehicle

- When you paint, apply heat treatment to the vehicle as a result of an accident, and/or weld on the vehicle, the performance of the high voltage battery can be reduced. If heat treatment is required, have the vehicle serviced by an authorized Kia dealer and have the HV battery removed, prior to any repairs.

⚠ WARNING

- When a vehicle accident occurs, move the vehicle to a safe place, turn OFF the vehicle and remove the auxiliary battery (12 V) terminal to prevent high voltage electricity from flowing.

- If electric wires are exposed from inside or outside the vehicle, do not touch the wires. Also, do not touch the high voltage electric wire (orange), connector, or any of the electric components and devices. This may cause electric shock and lead to injuries.
- When a vehicle accident occurs and the high voltage battery is damaged, harmful gas and electrolytes may leak. Be careful not to touch the leaked liquid.

When you suspect leakage of inflammable gas and other harmful gases, open the windows and evacuate to a safe place. If any leaked fluid comes in contact with your eyes or skin, immediately clean the affected area thoroughly with tap water or saline solution and have doctors inspect it as soon as possible.

- If a small scale fire occurs, use a fire extinguisher (ABC, BC) that is meant for electrical fires. If it is impossible to extinguish the fire in the early stage, maintain a safe distance away from the vehicle and immediately call your local fire emergency responders. Also, advise them that an electric vehicle is involved.
If the fire spreads to the high voltage battery, large amounts of water is needed to put out the fire. Using small amounts of water or fire extinguishers not meant for electrical fires could cause serious injury or death from electrical shocks.
- If you cannot put out the fire immediately, the high voltage battery may explode. Evacuate to a safe place and do not let other people approach the site.

Contact the fire department and notify them of an electric vehicle fire. If the vehicle is flooded with water, immediately turn OFF the vehicle and evacuate to a safe place. Contact the fire department or an authorized Kia dealer.

- If you tow the vehicle while the front wheels are touching the ground, the vehicle motor may generate electricity and the motor components may be damaged or a fire may occur.



- When a vehicle fire occurs due to the battery, there is a risk of a second fire. Contact your local fire emergency responders when towing the vehicle.
- When you clean the motor compartment, do not use high pressure water to wash. This may cause an electric shock due to a discharge in high voltage electricity, or damage the vehicle's electric system.
- Never disconnect the high voltage cut-off switch except in an emergency situation. Serious problems may occur, such as the vehicle will not start.

⚠ CAUTION

Use, remodel, or install only Kia Genuine Parts or those of an equivalent standard. If not, this may damage the electric power system.

*** NOTICE**

Putting the excessive force to the switch lever while shutting down the high voltage battery may severely damage the high voltage cut-off switch.

Vehicle data collection and event data recorders	2-2
Vehicle handling instructions	2-3
Vehicle modifications.....	2-3
Open Source Software Notice	2-4

Introduction

Vehicle data collection and event data recorders

This vehicle is equipped with an event data recorder (EDR). The main purpose of an EDR is to record, in certain crash or near crash-like situations, such as an air bag deployment or hitting a road obstacle, data that will assist in understanding how a vehicle's systems performed. The EDR is designed to record data related to vehicle dynamics and safety systems for a short period of time, typically 30 seconds or less. The EDR in this vehicle is designed to record such data as:

- How various systems in your vehicle were operating;
- Whether or not the driver and passenger safety belts were buckled/fastened;
- How far (if at all) the driver was depressing the accelerator and/or brake pedal; and,
- How fast the vehicle was traveling.

These data can help provide a better understanding of the circumstances in which crashes and injuries occur.

NOTE: EDR data are recorded by your vehicle only if a non-trivial crash situation occurs; no data are recorded by the EDR under normal driving conditions and no personal data (e.g., name, gender, age, and crash location) are recorded. However, other parties, such as law enforcement, could combine the EDR data with the type of personally identifying data routinely acquired during a crash investigation.

To read data recorded by an EDR, special equipment is required, and access to the vehicle or the EDR is needed. In addition to the vehicle manufacturer, other

parties, such as law enforcement, that have the special equipment, can read the information if they have access to the vehicle or the EDR.

Vehicle handling instructions

As with other vehicles of this type, failure to operate this vehicle correctly may result in loss of control, an accident or vehicle rollover.

Specific design characteristics (higher ground clearance, track, etc.) give this vehicle a higher center of gravity than other types of vehicles. In other words they are not designed for cornering at the same speeds as conventional 2-wheel drive vehicles. Avoid sharp turns or abrupt maneuvers. Again, failure to operate this vehicle correctly may result in loss of control, an accident or vehicle rollover. Be sure to read the "Reducing the risk of a rollover" driving guidelines, in chapter 6 of this manual.

Vehicle modifications

This vehicle should not be modified. Modification of your vehicle could affect its performance, safety or durability and may even violate governmental safety and emissions regulations.

* NOTICE

Damage or performance problems resulting from any modification may not be covered under warranty.

⚠ CAUTION

If you use unauthorized electronic devices, it may cause the vehicle to operate abnormally, wire damage, battery discharge and fire. For your safety, do not use unauthorized electronic devices.

Open Source Software Notice

This vehicle contains software with open source licenses.

Open source software information including the source code, copyright notices and referred license terms may be obtained on the website <http://world-wide.kia.com/int/opensource>.

Kia Corporation will provide the open source code to you in storage medium such as CD-ROM for minimum charge covering the cost of performing source distribution upon email request to open-source@kia.com within a period of 3 years from the date of product purchase.

Your vehicle at a glance **3**

Exterior overview	3-2
Interior overview	3-4
Instrument panel overview	3-6
Motor room compartment.....	3-8

Your vehicle at a glance

Exterior overview

Front view



OSG2EV011001

* The actual features in your vehicle may not necessarily be available due to the selected options or regions.

1. Hood	5-46
2. Head lamp	5-95, 8-41
3. Wheel and tire	8-19, 9-7
4. Outside rear view mirror	5-57
5. Sunroof	5-50
6. Front windshield wiper blades	5-101, 8-14
7. Window	5-42
8. Front ultrasonic sensor	6-142, 6-153
9. Front radar	6-39
10. Front view camera	6-39

11. Front fog lamp	5-95, 8-41
12. Roof rack	5-135
13. Charging door	5-49

Rear view



OSG2EV011002

* The actual features in your vehicle may not necessarily be available due to the selected options or regions.

1. Doors	5-13
2. Rear combination lamp	8-42
3. High mounted stop lamp	8-42
4. Liftgate	5-32
5. Antenna	5-137
6. Wide-rear view camera	6-128
7. Rear ultrasonic sensor	6-139, 6-153
8. Rear wiper	5-101, 8-15
9. Rear lower combination lamp	8-42

Interior overview



* The actual features in your vehicle may not necessarily be available due to the selected options or regions.

- | | |
|--|------------|
| 1. Inside door handle | 5-15 |
| 2. Driver position memory system | 5-30 |
| 3. Outside rearview mirror folding switch | 5-65 |
| 4. Outside rearview mirror control switch | 5-65 |
| 5. Central door lock/unlock switch | 5-16 |
| 6. Power window switches | 5-43 |
| 7. Power window lock/Electronic power child safety lock button | 5-43, 5-45 |
| 8. Steering wheel tilt/telescopic lever | 5-55 |
| 9. Steering wheel | 5-54 |
| 10. Instrument cluster illumination control | 5-71 |
| 11. Power tailgate open/close button | 5-34 |
| 12. ESC OFF button | 6-31 |
| 13. Hood release lever | 5-46 |

14.Instrument panel fuse	8-36
15.Seat	4-5
16.Reduction gear (shifter dial)	6-9

Instrument panel overview

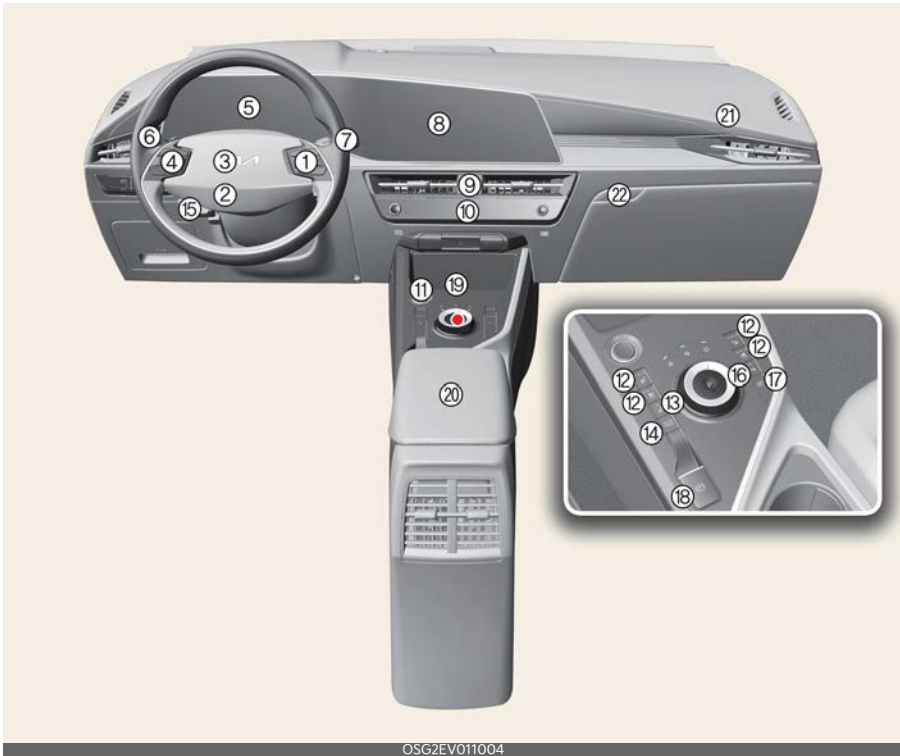

OSG2EV011004

* The actual features in your vehicle may not necessarily be available due to the selected options or regions.

- | | |
|---|--------------|
| 1. Audio remote control button | 5-75 |
| 2. Driver's front air bag | 4-32 |
| 3. Horn | 5-56 |
| 4. Driving Assist button | 6-95 |
| 5. Instrument cluster | 5-68 |
| 6. Light control/turn signals lever | 5-95 |
| 7. Wiper and washer control lever | 5-101 |
| 8. Infotainment system | 5-136 |
| 9. Hazard warning flasher switch | 7-2 |
| 10. Infotainment/climate switchable controller | 5-136 |
| 11. EV button | 6-6 |
| 12. Front seat warmer and air ventilation seat button | 5-125, 5-126 |
| 13. Steering wheel heater button | 5-55 |

14.AUTO HOLD button	6-27
15.Drive mode button	6-36
16.Parking Safety button	6-142
17.Parking/View button	6-130
18.EPB switch	6-23
19.Wireless charging system	5-129
20.Center console storage box	5-123
21.Passenger's front air bag	4-32
22.Glove box	5-124

Motor room compartment

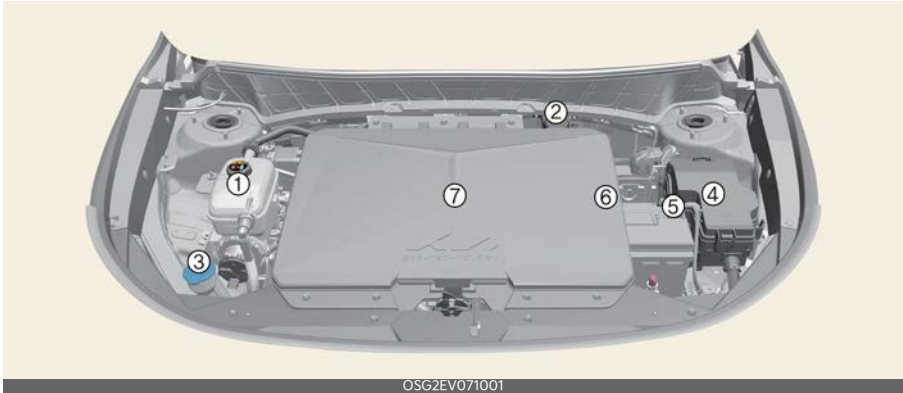

OSG2EV071001

* The actual motor compartment in the vehicle may differ from the illustration.

- | | |
|--------------------------------------|------|
| 1. Coolant reservoir | 8-11 |
| 2. Brake fluid reservoir | 8-12 |
| 3. Windshield washer fluid reservoir | 8-13 |
| 4. Fuse box | 8-32 |
| 5. Negative battery terminal (-) | 8-16 |
| 6. Positive battery terminal (+) | 8-16 |
| 7. Front trunk | 5-48 |

Safety features of your vehicle

Important safety precautions	4-3
Seat	4-5
• Feature of Seat Leather.....	4-7
• Infotainment system (if equipped).....	4-8
• Front seat adjustment for manual seat.....	4-8
• Front seat adjustment for power seat	4-9
• Headrest for front seat	4-11
• Seatback pocket.....	4-13
• Headrest for rear seat.....	4-13
• Armrest.....	4-14
• Folding the rear seat.....	4-14
Seat belts	4-17
• Seat belt restraint system.....	4-17
• Seat belt warning light.....	4-18
• Seat belt - driver's 3-point system with emergency locking retractor	4-18
• Seat belts - front passenger and rear seat 3-point system with combination locking retractor	4-20
• Pre-tensioner seat belt	4-21
• Seat belt precautions.....	4-22
• Care of seat belts	4-24
Child Restraint System (CRS).....	4-25
• Children always in the rear.....	4-25
• Selecting a Child Restraint System (CRS)	4-26
• Installing a Child Restraint System (CRS).....	4-27
Air bag - advanced supplemental restraint system.....	4-32
• How does the air bag system operate?.....	4-33
• Do not install a child restraint on the front passenger's seat....	4-34
• Air bag warning light	4-34
• Supplemental Restraint System (SRS) components and functions.....	4-35

4 Safety features of your vehicle

- Occupant Detection System (ODS).....4-36
- Driver's and passenger's front air bag4-42
- Side air bag.....4-44
- Curtain air bag4-45
- Air bag collision sensors4-47
- Why didn't my air bag go off in a collision? (Inflation and non-inflation conditions of the air bag).....4-48
- Supplemental Restraint System (SRS) care4-50
- Adding equipment to or modifying your air bag-equipped vehicle.....4-51
- Air bag warning label4-51

Safety features of your vehicle

Important safety precautions

You will find many safety precautions and recommendations throughout this section, and throughout this manual.

The safety precautions in this section are among the most important.

Always wear your seat belt

A seat belt is your best protection in all types of accidents. Air bags are designed to supplement seat belts, not replace them. So even though your vehicle is equipped with air bags, ALWAYS make sure you and your passengers always wear their seat belts, and wear them properly.

Restrain all children

All children under age 13 should ride in your vehicle properly restrained in a rear seat, not the front seat. Infants and small children should be restrained in an appropriate child restraint. Larger children should use a booster seat with the lap/shoulder belt until they can use the seat belt properly without a booster seat.

Air bag hazards

While air bags can save lives, they can also cause serious or fatal injuries to occupants who sit too close to them, or who are not properly restrained. Infants, young children, and shorter adults are at the greatest risk of being injured by an inflating air bag. Follow all instructions and warnings in this manual.

Driver distraction

Driver distraction presents a serious and potentially deadly danger, especially for inexperienced drivers. Safety should be the first concern when behind the wheel and drivers need to be aware of the wide array of potential distractions, such as drowsiness, reaching for objects, eating, personal grooming, other passengers, and using cellular phones.

Drivers can become distracted when they take their eyes and attention off the road or their hands off the wheel to focus on activities other than driving. To reduce your risk of distraction or getting into an accident:

- ALWAYS set up your mobile devices (i.e., MP3 players, phones, navigation units, etc.) when your vehicle is parked or safely stopped.
- ONLY use your mobile device when allowed by laws and when conditions permit safe use. NEVER text or email while driving. Most states have laws prohibiting drivers from texting. Some states and cities also prohibit drivers from using handheld phones.
- NEVER let the use of a mobile device distract you from driving. You have a responsibility to your passengers and others on the road to always drive safely, with your hands on the wheel as well as your eyes and attention on the road.

Control your speed

Excessive speed is a major factor in crash injuries and deaths. Generally, the higher the speed, the greater the risk, but serious injuries can also occur at lower speeds. Never drive faster than is safe for current conditions, regardless of the maximum speed posted.

Keep your vehicle in safe condition

Having a tire blowout or a mechanical failure can be extremely hazardous. To reduce the possibility of such problems, check your tire pressures and condition frequently, and perform all regularly scheduled maintenance.

Seat



OSG2PH032024N_6

Front seat

1. Forward and Backward
2. Seatback angle
3. Seat cushion height
4. Seat cushion tilt
5. Lumbar support
6. Driver position memory system
7. Headrest

Rear seat

8. Seat back folding
9. Armrest
10. Headrest

⚠ WARNING**Loose objects**

Loose objects in the driver's foot area could interfere with the operation of the foot pedals, possibly causing an accident. Do not place anything under the front seats.

⚠ WARNING**Uprighting seat**

Do not press the release lever on a manual seatback without holding and controlling the seatback. The seatback will spring upright, possibly impacting you or other passengers.

⚠ WARNING**Driver responsibility for passengers**

The driver must advise the passengers to keep the seatback in an upright position whenever the vehicle is in motion. If a seat is reclined during an accident, the restraint system's ability to restrain the passenger will be greatly reduced.

⚠ WARNING**Seat cushion**

Occupants should never sit on aftermarket seat cushions or sitting cushions. The Passenger Occupant Detection System may not operate properly, or the passenger's hips may slide under the lap

portion of the seat belt during an accident or a sudden stop.

⚠ WARNING**Driver's seat**

- Never attempt to adjust the seat while the vehicle is moving. This could result in loss of control of your vehicle.
- Do not allow anything to interfere with the normal position of the seatback. For example, storing items against the seatback could result in serious or fatal injury in a sudden stop or collision.
- Sit as far back as possible from the steering wheel while still maintaining comfortable control of the your vehicle. A distance of at least 10 inches (25 cm) from your chest to the steering wheel is recommended. Failure to do so can result in air bag inflation injuries to the driver.

⚠ WARNING**Rear seatbacks**

Always lock the rear seatback before driving. Failure to do so could result in passengers or objects being thrown forward, injuring vehicle occupants.

⚠ WARNING**Unexpected Seat Movement**

After adjusting a manual seat, always check that it is locked by shifting your weight to the front and to the back. Sudden or unexpected movement of the driver's seat could cause you to lose control of the vehicle.

⚠ WARNING**Seat adjustment**

- Do not adjust the seat while wearing seat belts. Moving the seat forward will cause strong pressure on the abdomen.
- Do not place your hand near the seat bottom or seat track while adjusting the seat. Your hand could get caught in the seat mechanism.

⚠ WARNING**Luggage and Cargo**

Do not stock pile or stack luggage or cargo higher than the seatback in the cargo area. In an accident the cargo could strike and injure a passenger. If objects are large, heavy or must be piled, they must be secured in the cargo area.

⚠ WARNING**Cargo Area**

Do not allow passengers to ride in the cargo area under any circumstance. The cargo area is solely for the purpose of transporting luggage or cargo.

⚠ WARNING**Small Objects**

Use extreme caution when picking up small objects trapped under the seats or between the seat and the center console. Your hands might be cut or injured by the sharp edges of the seats mechanism.

⚠ CAUTION**Precautions with seat covers**

Use caution when working on the seat cover. A short circuit or disconnection may occur, which could lead to noise, damage the ventilation system.

⚠ WARNING**Seat short circuit risk**

Be aware of wires or air vents when placing a seat cover or covering the seat with plastic cover. A short circuit may occur, which could lead to fire.

Feature of Seat Leather (if equipped)

- Our car seats are upholstered with a combination of artificial and genuine leather. The genuine leather is made from the outer skin of an animal, which goes through a special process to be available for use. Since it is a natural substance, each part differs in thickness or density. Also, wrinkles could appear depending on the temperature and humidity.
- The seat cover is made of stretchable material to improve comfort of passengers.
- The parts contacting the body are curved and the side supporting area is high which provides driving comfort and stability.
- Wrinkles may appear naturally from usage. It is not a fault of the product.

⚠ CAUTION

- Belts with metallic accessories, zippers or keys inside the back pocket may damage the seat fabric.
- Make sure not to wet the seat. It may change the leather.

- Jeans or clothes which could bleach may contaminate the surface of the seat covering fabric.

⚠ CAUTION

- Wrinkles or abrasions which appear naturally from usage are not covered by warranty.
- Belts with metallic accessories, zippers or keys inside the back pocket may damage the seat fabric.
- Make sure not to wet the seat. It may change the leather.
- Jeans or clothes which could bleach may contaminate the surface of the seat covering fabric.

Infotainment system (if equipped)



A: Vehicle settings

- 1 Seat**
- 2 Seat change alert**
- 3 Seating Easy Access**

Select **Setting** → **Vehicle** → **Seat** from the Settings menu in the infotainment system screen, you may use various convenience functions.

- **Seat Position Change Alert:** When the seat position changes, details of the change are shown with a seat image.
- **Seating Easy Access**
 - **Seat Slide Easy Access (Normal/Extended/Off)** the seat automati-

cally moves when the driver enters or leaves the vehicle may be selected.

The information provided may differ according to which functions are applicable to your vehicle.

*** INFORMATION**

The infotainment system may change after software updates. For more information, refer to the user's manual provided in the infotainment system and the quick reference guide.

Front seat adjustment for manual seat

The front seat can be adjusted by using the control levers located on the outside of the seat cushion.

Moving forward and backward



Adjust the seat before driving, and make sure the seat is locked securely by trying to move forward and backward without using the lever. If the seat moves, it is not locked properly.

To move the seat forward or backward:

1. Pull the seat slide adjustment lever up and hold it.

- Slide the seat to the position you desire.
- Release the lever and make sure the seat is locked in place.

Reclining seatback



To recline the seatback:

- Lean forward slightly and lift up the seatback recline lever.
- Carefully lean back on the seat and adjust the seatback of the seat to the position you desire.
- Release the lever and make sure the seatback is locked in place. (The lever MUST return to its original position for the seatback to lock.)

⚠ WARNING

Reclining seatback

Sitting in a reclined position when the vehicle is in motion can be dangerous. Even when buckled up, the protections of your restraint system (seat belts and/or air bags) are greatly reduced by reclining your seatback.

Seat belts must be snug against your hips and chest to work properly. When the seatback is reclined, the shoulder belt cannot do its job because it will not be snug against your chest. Instead, it will be in front of you. During an acci-

dent, you could be thrown into the seat belt, causing neck or other injuries.

The more the seatback is reclined, the greater chance the passenger's hips will slide under the lap belt or the passenger's neck will strike or become entangled in the shoulder belt.

Changing seat cushion height (if equipped)



To change the height of the seat cushion, push the lever upwards or downwards.

- To lower the seat cushion, push down the lever several times.
- To raise the seat cushion, pull up the lever several times.

Front seat adjustment for power seat (if equipped)

The front seat can be adjusted by using the control switches located on the outside of the seat cushion.

Before driving, adjust the seat to the proper position so you can easily control the steering wheel, pedals and switches on the instrument panel.

⚠ WARNING

Unattended children

Never leave children unattended in a vehicle. Children might operate features of the vehicle that could injure them.

⚠ CAUTION

Power seating adjustments

- The power seating controls function by electronic motor. Excessive operation may cause damage to the electrical equipment.
- Do not operate two or more power seat control switches at the same time. Doing so may damage the power seat motor or electrical components.

Moving forward and backward



OSG2PH032033N_2

To move the seat forward or backward:

1. Push the control switch forward or backward to move the seat to the desired position.
2. Release the switch once the seat reaches the desired position.

Reclining seatback



OSG2PH032034N_2

To recline the seatback:

1. Push the control switch forward or backward to move the seatback to the desired angle
2. Release the switch once the seat reaches the desired position.

Changing seat cushion tilt and height (if equipped)

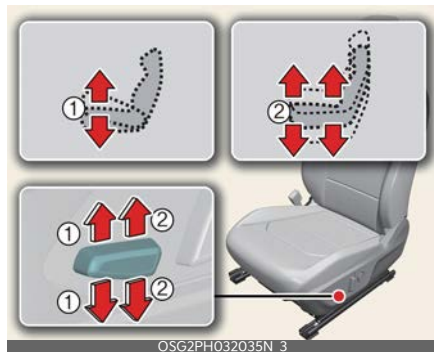

OSG2PH032035N_3

To change the height of the seat:

1. Pull the front portion (1) of the control switch up to raise or press down to lower the front part of the seat cushion.
2. Pull the rear portion (2) of the control switch up to raise or press down to lower the back part of the seat cushion.

3. Release the switch once the seat reaches the desired position.

Adjusting lumbar support for driver's seat (if equipped)



The lumbar support can be adjusted by pressing the lumbar support switch on the side of the seat.

1. Press the front portion (1) of the switch to increase support or the rear portion (2) of the switch to decrease support.
2. Release the switch once it reaches the desired position.

Headrest for front seat

The driver's and front passenger's seats are equipped with a headrest for the occupant's safety and comfort.



The headrest not only provides comfort for the driver and front passenger, but also helps protect the head and neck in the event of a rear collision.

For maximum effectiveness in case of an accident, the headrest should be

adjusted so the middle of the headrest is as high as the center of gravity of an occupant's head. Generally, the center of gravity of most people's head is similar with the height of the top of their eyes. Also, adjust the headrest as close to your head as possible. For this reason, the use of a cushion that holds the body away from the seatback is not recommended.

⚠ WARNING

Headrest removal/adjustment

- Do not operate the vehicle with the headrests removed. Headrests can provide critical neck and head support in a crash.
- Do not adjust the headrest height while the vehicle is in motion. Driver may lose control of the vehicle.

⚠ CAUTION

Excessive pulling or pushing may damage the headrest.

Adjusting the height up and down



To raise the headrest:

- Pull it up to the desired position (1).
- To lower the headrest, push and hold the release button (2) on the headrest support.
- Lower the headrest to the desired position (3).

*** NOTICE**

If you recline the seatback towards the front with the headrest and seat cushion raised, the headrest may come in contact with the sun visor or other parts of the vehicle.



Forward and backward adjustment (for front seats)



The headrest may be adjusted forward to 3 different positions by pulling the headrest forward to the desired position. To adjust the headrest to it's furthest backwards position, pull it fully forward to the farthest position and release it. Adjust the headrest so that it properly supports the head and neck.

Removing headrest

Type A

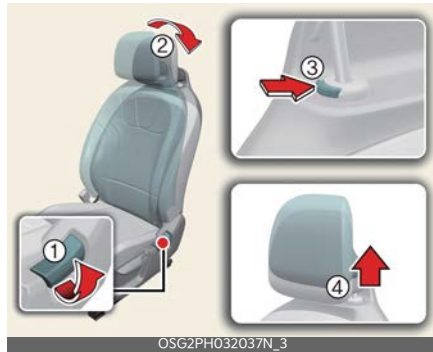

Type B



To remove the headrest:

1. Recline the seatback (2) with the recline lever or switch (1).
2. Raise headrest as far as it can go.
3. Press the headrest release button (3) while pulling the headrest up (4).

⚠ WARNING

Removing headrest

NEVER allow anyone to ride in a seat with the headrest removed or reversed. Headrests can provide critical neck and head support in a crash.

Reinstalling headrest

Type A

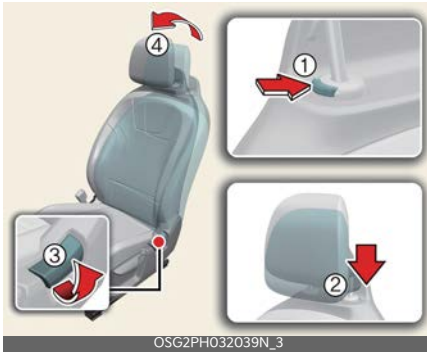

Type B



To reinstall the headrest:

1. Put the headrest poles (2) into the holes while pressing the release button (1).
2. Recline the seatback (4) with the recline lever or switch (3).
3. Adjust the headrest to the appropriate height.

⚠ WARNING

Headrest Reinstallation

To reduce the risk of injury to the head or neck, always make sure the headrest

is locked into position and adjusted properly after reinstalling.

Seatback pocket (if equipped)

There is a pocket (1) in the front seat back for storing simple books or atlases, and USB charger (2) (if equipped) for rear passengers.



⚠ WARNING

Seatback pockets

Do not put heavy or sharp objects in the seatback pockets. In an accident they could come loose from the pocket and injure vehicle occupants.

Headrest for rear seat

The rear seat is equipped with headrests in all the seating positions for the occupant's safety and comfort.



The headrest not only provides comfort for passengers, but also helps protect the head and neck in the event of a collision.

To maximize the effectiveness in case of accidents, the headrest should be adjusted so the middle of the headrest is as high as the center of gravity of an occupant's head. Generally, the center of

gravity of most people's heads is similar with the height as the top of their eyes. Also, adjust the headrest as close to your head as possible. For this reason, the use of a cushion that holds the body away from the seatback is not recommended.

Adjusting the height up and down



- To raise the headrest, pull it up to the desired position (1).
- To lower the headrest, push and hold the release button (2) on the headrest support and lower the headrest to the desired position (3).

Removal and reinstallation



- To remove the headrest, raise it as far as it can go then press the release button (1) while pulling the headrest upward (2).
- To reinstall the headrest, put the headrest poles (3) into the holes while pressing the release button (1).

Then adjust it to the appropriate height and ensure that it locks in position.

Armrest



To use the armrest, pull it forward from the seatback.

Folding the rear seat

The rear seatbacks may be folded to facilitate carrying long items or to increase the luggage capacity of the vehicle.

Folding down the rear seatback

1. Set the front seatback to the upright position and, if necessary, slide the front seat forward.
2. Lower the rear headrests to the lowest position.

⚠ WARNING

Objects

Objects carried on the folded down seatback should not extend higher than the top of the front seatbacks. Otherwise, cargo may slide forward and cause injury or damage during sudden stops.

3. When folding the seatback, insert the rear seat belt buckle in the pocket between the rear seatback and cushion. Make sure both seat belts do not interfere with stowed luggage and cargo. Then, the seat belt webbing should be placed in the webbing guide to prevent the seat belt from being damaged by loaded cargo, etc. If the seat belt is loose, it may cause damage or noise. In that case, return the seatback to the upright position

and put the webbing out from the guide to realign it.

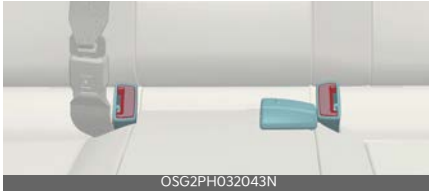

4. Pull on the seatback folding lever, then fold the seat toward the front of the vehicle.



Unfolding the rear seat



1. To use the rear seat, lift and pull the seatback backward while pulling on the seatback folding lever. Pull the seatback firmly until it clicks into

place. Make sure the seatback is locked in place. When you return the seatback to its upright position, always be sure it has locked into position by pushing on the top of the seatback.

2. Return the rear seat belt to the proper position.
3. When the seatback is completely installed, check the seatback folding lever again.

⚠ WARNING

Uprighting seat

When you return the seatback to its upright position, hold the seatback and return it slowly. If the seatback is returned without holding it, the back of the seat could spring forward, resulting in injury caused by being struck by the seatback.

⚠ WARNING

Rear seatback

To ensure maximum protection in the event of an accident or sudden stop, when returning the rear seat to the upright position:

- Be careful not to damage the seat belt webbing or buckle.
- Do not allow the seat belt webbing or buckle to become pinched or caught in the rear seat.
- Ensure the seatback is completely locked into its upright position by pushing on the top of the seatback. Failure to adhere to any of these instructions could result in serious injury or death in the event of a crash.

⚠ CAUTION

Damaging rear seat belt buckles

When you fold the rear seatback, insert the buckle between the rear seatback and cushion. Doing so can prevent the buckle from being damaged by the rear seatback.

unloading cargo. Failure to take these steps may allow the vehicle to move if the shifter dial is inadvertently moved to another position.

⚠ CAUTION

Rear seat belts

When returning the rear seatbacks to the upright position, remember to return the rear shoulder belts to their proper position.

⚠ WARNING

Unless the driver's position is properly set according to the driver's physical figure, do not fold the rear seat. It may increase bodily injuries in a sudden stop or collision.

⚠ CAUTION

Be careful when loading cargo through the rear passenger seats to prevent damage to the vehicle interior.

⚠ WARNING

Cargo

Cargo should always be secured to prevent it from being thrown about the vehicle in a collision and causing injury to the vehicle occupants. Do not place objects in the rear seats, since they cannot be properly secured and may hit the front seat occupants in a collision.

Cargo loading

Make sure the vehicle is off, the gear is in P (Park) and the parking brake is securely applied whenever loading or

Seat belts

The following explains seat belts precautions and how to fasten seat belts.

Seat belt restraint system

For maximum restraint system protection, the seat belts must always be used whenever the vehicle is moving.

- A properly positioned shoulder belt should be positioned midway over your shoulder across your collarbone.
- Never allow children to ride in the front passenger seat. See "Child Restraint System (CRS)" on page 4-25 for further discussion.

WARNING

Twisted Seat Belt

Make sure your seat belt is not twisted when worn. A twisted seat belt may not properly protect you in an accident and could even cut into your body.

WARNING

Shoulder Belt

- Never wear the shoulder belt under your arm or behind your back. An improperly positioned shoulder belt cannot protect the occupant in a crash.
- Always wear both the shoulder portion and lap portion of the lap/shoulder belt.

WARNING

Damaged Seat Belt

Replace the entire seat belt assembly if any part of the webbing or hardware is damaged, as you can no longer be sure that a damaged seat belt will provide protection in a crash.

Seat belts are designed to bear upon the bony structure of the body, and should be worn low across the front of the pelvis, chest and shoulders, as applicable; wearing the lap section of the belt across the abdominal area must be avoided.

Seat belts should be adjusted as firmly as possible, consistent with comfort, to provide the protection for which they have been designed.

A slack belt will greatly reduce the protection afforded to the wearer.

Care should be taken to avoid contamination of the webbing with polishes, oils and chemicals, and particularly battery acid. Cleaning may safely be carried out using mild soap and water. The belt should be replaced if webbing becomes frayed, contaminated or damaged.

- No modifications or additions should be made by the user which would either prevent the seat belt adjusting devices from operating to remove slack, or prevent the seat belt assembly from being adjusted to remove slack.
- When you fasten the seat belt, be careful not to latch the seat belt in buckles of other seats. It is very dangerous and you may not be protected by the seat belt properly.
- Do not unfasten the seat belt and do not fasten and unfasten the seat belt repeatedly while driving. This could result in loss of control, and an accident causing death, serious injury, or property damage.
- When fastening the seat belt, make sure that the seat belt does not pass over objects that are hard or can break easily.

⚠ WARNING**Seat Belt Buckle**

Do not allow foreign material (gum, crumbs, coins, liquids, etc.) to obstruct the seat belt buckle. This may prevent the seat belt from fastening securely.

Seat belt warning light**Driver's seat belt warning**

As a reminder to the driver, the seat belt warning light will appear for approximately 6 seconds each time the EV button is in ON regardless of belt fastening.



If the driver continues not to fasten the seat belt, the warning light will stay illuminated and the warning chime will sound for approximately 6 seconds until the belt is fastened each time the EV button is in ON. This will happen every time the EV button is in ON.

If a driver continues not to fasten the seat belt and drives 6 mph (9 km/h) or more but less than 12 mph (20 km/h), the warning light will stay illuminated. If a driver unfastens the seat belt while driving below 12 mph (20 km/h), the warning light will stay illuminated.

If a driver continues not to fasten the seat belt while driving over 12 mph (20 km/h), the seat belt warning chime will sound for approximately 100 seconds and the corresponding warning light will blink.

Front passenger's seat belt warning

As a reminder to the front passenger, the seat belt warning light will appear for approximately 6 seconds each time you turn the EV button ON regardless of belt fastening. If you start to drive without the passenger seat belt fastened when you drive over approximately 5 mph (9 km/h) and less than approximately 12 mph (20 km/h), the corresponding warning light will appear. The warning light will turn off when the vehicle speed drops approximately below 5 mph (9 km/h).

If you start to drive without the passenger seat belt fastened or you unfasten the seat belt when you drive approximately 12 mph (20 km/h) and faster, the warning light will blink and warning chime will sound for approximately 100 seconds. When the passenger seat belt is unfastened during driving, the warning light will appear when the speed is approximately under 12 mph (20 km/h). When the speed is approximately 12 mph (20 km/h) and faster, the warning light will blink and warning chime will sound for approximately 100 seconds.

*** NOTICE**

- Even if the front passenger seat is not occupied, the seat belt warning light will appear for approximately 6 seconds.
- The front passenger's seat belt warning may operate when luggage is placed on the front passenger seat.

Seat belt - driver's 3-point system with emergency locking retractor

The following explains how to fasten and adjust the driver's seat belt.

Fastening the seat belt



- Pull it out of the retractor and insert the metal tab (1) into the buckle (2). There will be an audible "click" when the tab locks into the buckle.



You should place the lap belt portion as low as possible and snugly across your hips. If the lap belt is located too high on your waist, it may increase the chance of injury in the event of a collision.

The arm closest to the seat belt buckle should be over the belt while the other arm should be under the belt as shown in the illustration. Never wear the seat belt under the arm closest to the door.

The seat belt automatically adjusts to the proper length only after the lap belt portion is adjusted manually so that it fits snugly around your hips. If you lean forward in a slow, easy motion, the belt will extend and let you move around. If there is a sudden stop or impact, however, the belt will lock into position. It will also lock if you try to lean forward too quickly.

* NOTICE

If you are not able to pull out the seat belt from the retractor, firmly pull the

belt out and release it. Then you will be able to pull the belt out smoothly.

Height adjustment

You can adjust the height of the shoulder belt anchor to one of the 4 positions for maximum comfort and safety.



The height of the adjusting seat belt should not be too close to your neck. The shoulder portion should be adjusted so that it lies across your chest and mid-way over your shoulder near the door and not your neck.

To adjust the height of the seat belt anchor, lower or raise the height adjuster into an appropriate position.

- To raise the height adjuster, pull it up (1).
- To lower it, push it down (2) while pressing the height adjuster button (3).

Release the button to lock the anchor into position. Try sliding the height adjuster to make sure that it has locked into position.

Improperly positioned seat belts can cause serious injuries in an accident.

⚠ WARNING

Shoulder Belt Positioning

Verify the shoulder belt anchor is locked into position at the appropriate height. Never position the shoulder belt across your neck or face. Improperly positioned

seat belts can cause serious injuries in an accident.

WARNING

Seat Belt Replacement

After a collision, the seat belt system should be inspected to ensure it is operating normally. Replace any belts that are not functioning appropriately.

Seat belts - front passenger and rear seat 3-point system with combination locking retractor

The following explains how to fasten the passenger's and rear seat belt.

Fastening the seat belt

Combination retractor type seat belts are installed in the rear seat positions to help accommodate the installation of child restraint systems. Although a combination retractor is also installed in the front passenger seat position, it is strongly recommended that children always be seated in the rear seat. NEVER place any infant restraint system in the front seat of the vehicle.

This type of seat belt combines the features of both an emergency locking retractor seat belt and an automatic locking retractor seat belt.

- Pull it out of the retractor and insert the metal tab into the buckle. There will be an audible "click" when the tab locks into the buckle. When not securing a child restraint, the seat belt operates in the same way as the driver's seat belt (emergency locking retractor type).

It automatically adjusts to the proper length only after the lap belt portion of the seat belt is adjusted manually so that it fits snugly around your hips.

When the seat belt is fully extended from the retractor to allow the installation of a child restraint system, the seat belt operation changes to allow the belt to retract, but not to extend (automatic locking retractor type). Refer to "Securing a child restraint with a lap/shoulder belt" on page 4-30.

CAUTION

Do NOT fold down the left portion of the rear seatback when the rear center seat belt is buckled. ALWAYS UNBUCKLE the rear center seat belt before folding down the left portion of the rear seatback. If the rear center seat belt is buckled when the left portion of the rear seatback is folded down, distortion and damage to the top portion of the seatback and seat belt garnish may result, causing the seatback to lock into the folded down position.

NOTICE

Although the combination retractor provides the same level of protection for seated passengers in either emergency or automatic locking modes, have the seated passengers use the emergency locking feature for improved convenience. The automatic locking function is intended to facilitate child restraint installation. To convert from the automatic locking feature to the emergency locking operation mode, allow the unbuckled seat belt to fully retract.

The seat belt should be locked into the buckle on each seat cushion to be properly fastened.



- 1 Rear right seat belt fastening buckle
- 2 Rear center seat belt fastening buckle
- 3 Rear left seat belt fastening buckle

⚠ WARNING

Prior to fastening the rear seat belts, ensure the latch matches the seat belt buckle. Forcefully fastening the left or right seat belt to the center buckle can result in an improper fastening scenario that will not protect you in an accident.

When using the rear center seat belt, the buckle with the "CENTER" mark must be used.

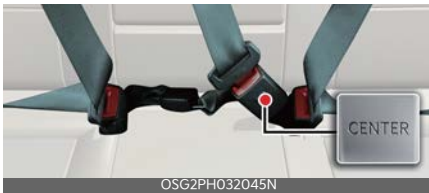

Releasing the seat belt



The seat belt is released by pressing the release button (1) on the locking buckle. When it is released, the belt should automatically draw back into the retractor.

If this does not happen, check the belt to make sure it is not twisted, then try again.

Pre-tensioner seat belt

Your vehicle is equipped with driver's and front passenger's pre-tensioner seat belts.



The pre-tensioner seat belts may be activated, when a frontal collision is severe enough, together with the air bags.

When the vehicle stops suddenly, or if the occupant tries to lean forward too quickly, the seat belt retractor may lock into position. In certain frontal collisions, the pre-tensioner will activate and pull the seat belt into tighter contact against the occupant's body.

1 Retractor pre-tensioner

The purpose of the retractor pre-tensioner is to make sure that the shoulder belts fit in tightly against the occupant's upper body in certain frontal collisions.

If the system senses excessive tension on the driver or passenger's seat belt when the pre-tensioner system activates, the load limiter inside the retractor pre-tensioner will release some of the pressure on the affected seat belt.

*** NOTICE**

When the pre-tensioner seat belts are activated, a loud noise may be heard and fine dust, which may appear to be smoke, may be visible in the passenger

compartment. These are normal operating conditions and are not hazardous.

The seat belt pre-tensioner system consists mainly of the following components. Their locations are shown in the illustration:



* The actual position of seat belt pre-tensioner system components may differ from the illustration.

- 1 SRS air bag warning light
- 2 Retractor pre-tensioner assembly
- 3 SRS control module

⚠ WARNING

Skin Irritation

Wash all exposed skin areas thoroughly after an accident in which the pre-tensioner seat belts were activated. The fine dust from the pre-tensioner activation may cause skin irritation and should not be inhaled for prolonged periods.

*** NOTICE**

- Both the driver's and front passenger's seat belt pre-tensioner systems may be activated, not only in certain frontal collisions, but also in certain side collisions or rollovers, if the vehicle is equipped with a side or curtain air bag.
- Because the sensor that activates the SRS air bag is connected with the pre-tensioner seat belt, the SRS air bag warning light (🚗) on the instrument panel will appear for approximately 6

seconds after the EV button has been changed to the ON position, and then it should turn off.

If the pre-tensioner seat belt system is not working properly, this warning light will appear even if there is not a malfunction with the SRS air bag. If the SRS air bag warning light does not appear when EV button has been changed to ON, or if it remains illuminated after appearing for approximately 6 seconds, or if it appears while the vehicle is being driven, have an authorized Kia dealer inspect the pre-tensioner seat belt and SRS air bag system as soon as possible.

⚠ WARNING

Hot Pre-tensioner

Do not touch the pre-tensioner seat belt assemblies for several minutes after they have been activated. When the pre-tensioner seat belt mechanism fires during a collision, the pre-tensioner becomes hot and can burn you.

*** NOTICE**

Do not attempt to service or repair the pre-tensioner seat belt system in any manner. Do not attempt to inspect or replace the pre-tensioner seat belts yourself. This must be done by an authorized Kia dealer.

Pre-tensioners are designed to operate only one time. After activation, pre-tensioner seat belts must be replaced. If the pre-tensioner must be replaced, contact an authorized Kia dealer.

Seat belt precautions

Take the following precautions when using seat belts.

Infant or small child

All 50 states have child restraint laws. You should be aware of the specific requirements in your state. Child and/or infant seats must be properly placed and installed in the rear seat. For more information about the use of these restraints, refer to "Child Restraint System (CRS)" on page 4-25.

* NOTICE

Small children are best protected from injury in an accident when properly restrained in the rear seat by a child restraint system that meets the requirements of the Federal Motor Vehicle Safety Standards. Before buying any child restraint system, make sure that it has a label certifying that it meets Federal Motor Vehicle Safety Standard 213. The restraint must be appropriate for your child's height and weight. Check the label on the child restraint for this information. Refer to "Child Restraint System (CRS)" on page 4-25.

Larger children

Children who are too large for child restraint systems should always occupy the rear seat and use the available lap/shoulder belts. The lap portion should be fastened and snug on the hips as low as possible. Check periodically to insure that the belt fits. A child's squirming could put the belt out of position. Children are given the most safety in the event of an accident when they are restrained by a proper restraint system in the rear seat. If a larger child (over age 13) must be seated in the front seat, the child should be securely restrained by the available lap/shoulder belt and the seat should be placed in the rearmost

position. Children age 13 and under should be restrained securely in the rear seat. NEVER place a child age 13 and under in the front seat. NEVER place a rear facing child seat in the front seat of a vehicle.

If the shoulder belt portion slightly touches the child's neck or face, try placing the child closer to the center of the vehicle. If the shoulder belt still touches their face or neck they need to be returned to a child restraint system.

⚠ WARNING

Small Children

Do not allow small children to ride in the vehicle without an appropriate child restraint system. If the shoulder belt comes in contact with your child's neck or face, your child is too small to ride in the vehicle. In a crash the seat belt will inflict injury to your child's neck, throat and face.

Restraint of pregnant women

Pregnant women should wear lap/shoulder belt assemblies whenever possible according to specific recommendations by their doctors. The lap portion of the belt should be worn AS SECURELY AND LOW AS POSSIBLE.

⚠ WARNING

Pregnant Women

Pregnant women must never place the lap portion of the seat belt above or on the abdomen where the fetus is located. The force of the seat belt during a collision will crush the fetus.

Injured person

A seat belt should be used when an injured person is being transported. When this is necessary, you should consult a physician for recommendations.

One person per belt

Two people (including children) should never attempt to use a single seat belt. This could increase the severity of injuries in case of an accident.

Do not lie down

To reduce the chance of injuries in the event of an accident and to achieve maximum effectiveness of the restraint system, all passengers should be sitting up and the front and rear seats should be in an upright position when the vehicle is moving. A seat belt cannot provide proper protection if the person is lying down in the rear seat or if the front and rear seats are in a reclined position.

Care of seat belts

Seat belt systems should never be disassembled or modified. In addition, care should be taken to assure that seat belts and belt hardware are not damaged by seat hinges, doors or other abuse.

WARNING

Pinched Seat Belt

Make sure that the webbing and/or buckle does not get caught or pinched in the rear seat when returning the rear seatback to its upright position. A caught or pinched webbing/buckle may become damaged and could fail during a collision or sudden stop.

WARNING

Seatbelts can become hot in a vehicle that has been closed up in sunny weather. They could burn infants and children.

Periodic inspection

All seat belts should be inspected periodically for wear or damage of any kind. Any damaged parts should be replaced as soon as possible.

Keep belts clean and dry

Seat belts should be kept clean and dry. If belts become dirty, they can be cleaned by using a mild soap solution and warm water. Bleach, dye, strong detergents or abrasives should not be used because they may damage and weaken the fabric.

When to replace seat belts

The entire in-use seat belt assembly or assemblies should be replaced if the vehicle has been involved in an accident. This should be done even if no damage is visible. Additional questions concerning seat belt operation should be directed to an authorized Kia dealer.

Child Restraint System (CRS)

Infants and younger children must be restrained in an appropriate rear-facing or forward-facing CRS that has first been properly secured to the rear seat of the vehicle.

Children always in the rear

Children under age 13 must always ride in the rear seats and must always be properly restrained to minimize the risk of injury in an accident, sudden stop or sudden maneuver.

WARNING

Restraint Location

Never install a child or infant seat in the front passenger's seat. A child riding in the front passenger seat can be forcefully struck by an inflating airbag and get seriously injured.

WARNING

Hot Child Restraint

A child restraint system can become very hot if it is left in a closed vehicle on a sunny day. Be sure to check the seat cover, buckles and latches before placing a child in the restraint system.

According to accident statistics, children are safer when properly restrained in the rear seats than in the front seat. Even with air bags, children can be seriously injured or killed. Children too large for a child restraint must use the seat belts provided.

All 50 states have child restraint laws which require children to travel in approved child restraint devices. The laws governing the age or height/weight restrictions at which seat belts can be used instead of child restraints differs

among states, so you should be aware of the specific requirements in your state, and where you are traveling.

Child restraint systems must be properly placed and installed in the rear seat. You must use a commercially available child restraint system that meets the requirements of the Federal Motor Vehicle Safety Standards (FMVSS).

Child restraint systems are generally designed to be secured in a vehicle seat by lap belt portion of a lap/shoulder belt, or by a LATCH system in the rear seats of the vehicle.

Child restraint system (CRS)

Infants and younger children must be restrained in an appropriate rear-facing or forward-facing CRS that has first been properly secured to the rear seat of the vehicle. Read and comply with the instructions for installation and use provided by the manufacturer of the CRS.

WARNING

Child Restraint Installation

An improperly secured child restraint system can increase the risk of serious injury or death in an accident. Always take the following precautions when using a child restraint system:

- Always follow the child restraint system manufacturer's instructions for installation and use.
- Always properly restrain your child in the child restraint system.
- If the vehicle head restraint prevents proper installation of a child seat (as described in the child restraint system manual), the head restraint of the respective seating position should be readjusted or entirely removed.

- Do not use an infant carrier or a child safety seat that "hooks" over a seat-back, as it may not provide adequate protection in an accident.

*** NOTICE**

After an accident, have a Kia dealer check the child restraint system, seat belts, tether anchors and lower anchors.

Selecting a Child Restraint System (CRS)

When selecting a CRS for your child, always:

- Make sure the CRS has a label certifying that it meets applicable Federal Motor Vehicle Safety Standards (FMVSS 213).
- Select a child restraint based on your child's height and weight. The required label or the instructions for use typically provide this information.
- Select a child restraint that fits the vehicle seating position where it will be used.
- Read and comply with the warnings and instructions for installation and use provided with the child restraint system.

⚠ WARNING

Holding Children

Never hold a child in your arms or lap when riding in a vehicle. The violent forces created during a crash will tear the child from your arms and throw the child against the car's interior. Always use a child restraint system, which is appropriate for your child's height and weight.

⚠ WARNING

Unattended Children

Never leave children unattended in a vehicle. The car can heat up very quickly, resulting in injuries to the child in the vehicle.

⚠ WARNING

Seat Belt Use

Do not use one seat belt for two occupants at the same time. This will eliminate any safety benefit provided by the seat belt to the occupants.

Child restraint system types

There are three main types of child restraint systems: rear-facing seats, forward-facing seats, and booster seats. They are classified according to the child's age, height and weight.

Rear-facing child seats



A rear-facing child seat provides restraint with the seating surface against the back of the child. The harness system holds the child in place, and in an accident, acts to keep the child positioned in the seat and reduces the stress to the neck and spinal cord.

All children under age one must always ride in a rear-facing infant child restraint. Convertible and 3-in-1 child seats typically have higher height and weight limits for the rear-facing position, allowing

you to keep your child rear-facing for a longer period of time.

Continue to use a rear-facing child seat for as long as your child will fit within the height and weight limits allowed by the child seat manufacturer. It's the best way to keep them safe. Once your child has outgrown the rear-facing child restraint, your child is ready for a forward-facing child restraint with a harness.

Forward-facing child restraints



A forward-facing child seat provides restraint for the child's body with a harness. Keep children in a forward-facing child seat with a harness until they reach the top height or weight limit allowed by your child restraint's manufacturer.

Once your child outgrows the forward-facing child restraint, your child is ready for a booster seat.

Booster seats

A booster seat is a restraint designed to improve the fit of the vehicle's seat belt system. A booster seat positions the seat belt so that it fits properly over the lap of your child.

Keep your child in a booster seat until they are big enough to sit in the seat without a booster and still have the seat belt fit properly. For a seat belt to fit properly, the lap belt must lie snugly across the upper thighs, not the stomach. The shoulder belt should lie snug across the shoulder and chest and not

across the neck or face. Children under age 13 must always ride in the rear seats and must always be properly restrained to minimize the risk of injury.

Installing a Child Restraint System (CRS)

After selecting a proper child seat for your child, check to make sure it fits properly in your vehicle.

Follow the instructions provided by the manufacturer when installing the child seat. Note these general steps when installing the seat to your vehicle:

- **Properly secure the child restraint to the vehicle.** All child restraints must be secured to the vehicle with the lap part of a lap/shoulder belt or with the LATCH system.
- **Make sure the child restraint is firmly secured.** After installing a child restraint to the vehicle, push and pull the seat forward and from side-to-side to verify that it is securely attached to the seat. A child restraint secured with a seat belt should be installed as firmly as possible. However, some side-to-side movement can be expected.
- **Secure the child in the child restraint.** Make sure the child is properly strapped in the child restraint according to the manufacturer instructions.

Lower Anchors and Tether for Children (LATCH) System

The LATCH system holds a child restraint during driving and in an accident. This system is designed to make installation of the child restraint easier and reduce the possibility of improperly installing your child restraint. The LATCH

system uses anchors in the vehicle and attachments on the child restraint. The LATCH system eliminates the need to use seat belts to secure the child restraint to the rear seats.

Lower anchors are metal bars built into the vehicle. There are two lower anchors for each LATCH seating position that will accommodate a child restraint with lower attachments.

To use the LATCH system in your vehicle, you must have a child restraint with LATCH attachments.

The child seat manufacturer will provide you with instructions on how to use the child seat with its attachments for the LATCH lower anchors.



OSG2H031012

LATCH anchors have been provided in the left and right outboard rear seating positions. Their locations are shown in the illustration. There are no LATCH anchors provided for the center rear seating position.

⚠ WARNING

LATCH Lower Anchors

Never attempt to attach a LATCH equipped seat in the center seating position. LATCH lower anchors are only to be used in the left and right rear outboard seating positions. You may damage the anchors or the anchors may fail and break in a collision if the seat is in the center seating position.

The lower anchor position indicator symbols are located on the left and right rear

seatbacks to identify the position of the lower anchors in your vehicle (see arrows in illustration).



OSG2PH032050N_3

- 1 Lower Anchor position indicator
- 2 Lower Anchor

The LATCH anchors are located between the seatback and the seat cushion of the rear seat left and right outboard seating positions.

To use the lower anchor, push the upper portion of the lower anchor cover.

Securing a child restraint with the LATCH anchors system

To install a LATCH-compatible child restraint in either of the rear outboard seating positions:

1. Move the seat belt buckle away from the lower anchors.
2. Move any other objects away from the anchors that could prevent a secure connection between the child restraint and the lower anchors.
3. Place the child restraint on the vehicle seat, then attach the seat to the lower anchors according to the instructions provided by the child restraint manufacturer.
4. Follow the child restraint instructions for properly adjusting and tightening

the lower attachments on the child restraint to the lower anchors.

⚠ WARNING

Take the following precautions when using the LATCH system:

- Read and follow all installation instructions provided with your child restraint system.
- To prevent the child from reaching and taking hold of the unused seat belts, buckle all unused rear seat belts before the child is placed into the vehicle. Lock each unused seatbelt following the instructions in the "automatic locking mode" subsection, and place the webbing behind the child seat or against an unused seatback. Children can be strangled if a shoulder belt becomes wrapped around their neck and the seat belt tightens.
- NEVER attach more than one child restraint to a single anchor. This could cause the anchor or attachment to come loose or break.
- Always have the LATCH system inspected by your authorized Kia dealer after an accident. An accident can damage the LATCH system and may not properly secure the child restraint.

*** NOTICE**

The recommended maximum weight for the LATCH system is 65 lbs. (30 kg). When selecting a proper child restraint system, consider that the maximum total weight of the child plus the child restraint should be less than 65 lbs. (30 kg).

As a guide, the MAX child restraint weight should be determined by the following calculation:

Child Restraint system Weight = 65 - (child's total weight in lbs.)

Securing a child restraint seat with "Tether Anchor" system



First secure the child restraint with the LATCH lower anchors or the seat belt. If the child restraint manufacturer recommends that the top tether strap be attached, attach and tighten the top tether strap to the top tether strap anchor.

Child restraint hook holders are located on the shelf behind the rear seats.

⚠ WARNING

Take the following precautions when installing the tether strap:

- Read and follow all installation instructions provided with your child restraint system.
- NEVER attach more than one child restraint to a single tether anchor. This could cause the anchor or attachment to come loose or break.
- Do not attach the tether strap to anything other than the correct tether anchor. It may not work properly if attached to something else.
- Do not use the tether anchors for adult seat belts or harnesses, or for attaching other items or equipment to the vehicle.
- Always fasten the seat belts behind the child restraint seat when they are not used to secure the child seat. Fail-

ure to do so may result in child strangulation.

To install the tether anchor:



1. Route the child restraint tether strap over the child restraint seatback. Route the tether strap under the head restraint and between the head restraint posts, or route the tether strap over the top of the vehicle seatback. Make sure the strap is not twisted.
2. Connect the tether strap hook to the tether anchor, then tighten the tether strap according to the child seat manufacturer's instructions to firmly secure the child restraint to the seat.
3. Check that the child restraint is securely attached to the seat by pushing and pulling the seat forward and from side-to-side.

Securing a child restraint with a lap/shoulder belt

When not using the LATCH system, all child restraints must be secured to a vehicle rear seat with the lap part of a lap/shoulder belt.

Automatic locking mode



Since all passenger seat belts move freely under normal conditions and only lock under extreme or emergency conditions (emergency locking mode), you must manually pull the seat belt all the way out to shift the retractor to the "automatic locking" mode to secure a child restraint.

The "automatic locking" mode will help prevent the normal movement of the child in the vehicle from causing the seat belt to loosen and compromise the child restraint system.

To install a child restraint system on the rear seats, do the following:

1. Place the child restraint system on a rear seat and route the lap/shoulder belt around or through the child restraint, following the restraint manufacturer's instructions.

Be sure the seat belt webbing is not twisted.

2. Fasten the lap/shoulder belt latch into the buckle. Listen for the distinct "click" sound.

Position the release button so that it is easy to access in case of an emergency.



3. Pull the shoulder portion of the seat belt all the way out. When the shoulder portion of the seat belt is fully extended, it will shift the retractor to the "automatic locking" (child restraint) mode.



4. Slowly allow the shoulder portion of the seat belt to retract and listen for an audible "clicking" or "ratcheting" sound. This indicates that the retractor is in the "automatic locking" mode. If no distinct sound is heard, repeat steps 3 and 4.



5. Remove as much slack from the belt as possible by pushing down on the child restraint system while feeding the shoulder belt back into the retractor.
6. Push and pull on the child restraint system to confirm that the seat belt is holding it firmly in place. If it is not, release the seat belt and repeat steps 2 through 5.
7. Double check that the retractor is in the "automatic locking" mode by attempting to pull more of the seat belt out of the retractor. If you cannot, the retractor is in the "automatic locking" mode.

If your CRS manufacturer instructs or recommends you to use a tether anchor with the lap/shoulder belt, refer to "Securing a child restraint with the LATCH anchors system" on page 4-28 for more information.

⚠ WARNING

Auto Lock Mode

Set the retractor to Automatic Lock mode when installing any child restraint system. If the retractor is not in the automatic locking mode, the child restraint can move when your vehicle turns or stops suddenly. A child can be seriously injured or killed if the child restraint is not properly anchored in the car, including manually pulling the seat belt all the way out to shift the retractor to the "Auto Lock" mode.

*** NOTICE**

When the seat belt is allowed to retract to its fully stowed position, the retractor will automatically switch from the "automatic locking" mode to the emergency lock mode for normal adult usage.

To remove the child restraint, press the release button on the buckle and then pull the lap/shoulder belt out of the restraint and allow the seat belt to retract fully.

Air bag - advanced supplemental restraint system

The appropriate air bags inflate instantly in the event of a serious frontal collision or side collision in order to help protect the occupants from serious physical injury.

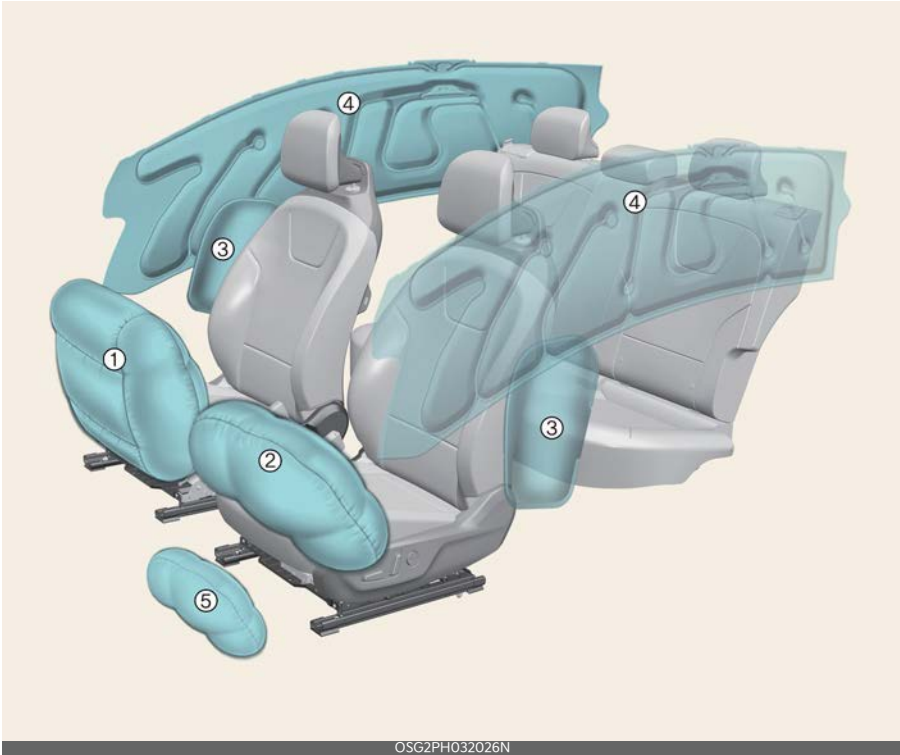

OSC2PH032026N

* The actual air bags in the vehicle may differ from the illustration.

- 1 Passenger's front air bag
- 2 Driver's front air bag
- 3 Side air bag
- 4 Curtain air bag
- 5 Driver's knee air bag

Even in vehicles with air bags, you and your passengers must always wear the safety belts provided in order to minimize the risk and severity of injury in the event of a collision or rollover.

How does the air bag system operate?

- Air bags are activated (able to inflate if necessary) only when the EV button has been changed to ON position or the vehicle is in the ready mode.
- The appropriate air bags inflate instantly in the event of a serious frontal collision or side collision in order to help protect the occupants from serious physical injury.
- Generally, air bags are designed to inflate based upon the severity of a collision and its direction. These two factors determine whether the sensors produce an electronic deployment/inflation signal.
- Air bags will inflate based upon the severity of a collision and its direction, etc. But air bags will not inflate in every crash or collision situation.
- The front air bags will completely inflate and deflate in an instant. It is virtually impossible for you to see the air bags inflate during an accident. It is much more likely that you will simply see the deflated air bags hanging out of their storage compartments after the collision.
- In addition to inflating in serious side collisions, side and/or curtain air bags will inflate if the sensing system detects a rollover.
- When a rollover is detected, side and/or curtain air bags will remain inflated longer to help provide protection from ejection, especially when used in conjunction with the seat belts.
- In order to help provide protection, the air bags must inflate rapidly. The speed of the air bag inflation is a consequence of extremely short time in which to inflate the air bag between

the occupant and the vehicle structures before the occupant impacts those structures. This speed of inflation reduces the risk of serious or life-threatening injuries and is thus a necessary part of the air bag design. However, air bag inflation can also cause injuries which can include facial abrasions, bruises and broken bones because the inflation speed also causes the air bags to expand with a great deal of force.

- **There are even circumstances under which contact with the steering wheel or passenger air bag can cause fatal injuries, especially if the occupant is positioned excessively close to the steering wheel or passenger air bag.**

WARNING

Airbag Inflation

Sit as far back as possible from the steering wheel while still maintaining comfortable control of the vehicle. A distance of at least 10" from your chest to the steering wheel is recommended. Failure to do so can result in airbag inflation injuries to the driver.

Noise and smoke

When inflated, the air bags make a loud noise and leave smoke and powder in the air inside the vehicle. This is normal and is a result of the ignition of the air bag inflator. After the air bag inflates, you may feel substantial discomfort in breathing due to the contact of your chest with both the seat belt and the air bag, as well as from breathing the smoke and powder. **Open your doors and/or windows as soon as possible after impact in order to reduce dis-**

comfort and prevent prolonged exposure to the smoke and powder.

Though smoke and powder are non-toxic, it may cause irritation to the skin (eyes, nose and throat, etc). If this is the case, wash and rinse with cold water immediately and consult a doctor if the symptom persists.

WARNING

Hot Components

Do not touch the air bag storage area's internal components immediately after airbag inflation. The air bag related parts in the steering wheel, instrument panel and the roof rails above the front and rear doors are very hot. Hot components can result in burn injuries.

WARNING

Do not install or place any accessories near air bag deployment areas, such as the instrument panel, windows, pillars, and roof rails.

Do not install a child restraint on the front passenger's seat

Never place a rear-facing child restraint in the front passenger's seat.



If the air bag deploys, it would impact the rear-facing child restraint, causing serious or fatal injury.

In addition, do not place front-facing child restraints in the front passenger's seat. If the front passenger air bag

inflates, it could cause serious or fatal injuries to the child.

WARNING

Air Bag Deployment

When children are seated in the rear outboard seats of a vehicle equipped with side and/or curtain air bags, install the child restraint system as far away from the door side as possible. Inflation of the side and/or curtain air bags could impact the child.

Air bag warning light

The purpose of air bag warning light in your instrument panel is to alert you of a potential problem with your air bag system, which could include your side and/or curtain air bags used for rollover protection.

If the air bag warning light appears for more than 6 seconds after EV button has been changed to ON, or if appears during vehicle operation, an SRS component may not be functioning properly and you should have your vehicle checked by an authorized Kia dealer.



If any of the following conditions occur, this indicates a malfunction in the air bag system. Have an authorized Kia dealer inspect the air bag system as soon as possible.

- The light does not turn on briefly when you change EV button to ON.
- The light stays on after appearing for approximately 6 seconds.
- The light comes on while the vehicle is in motion.

- The light blinks when EV button is in the ON position.

Supplemental Restraint System (SRS) components and functions

The SRS consists of multiple elements and sensors.

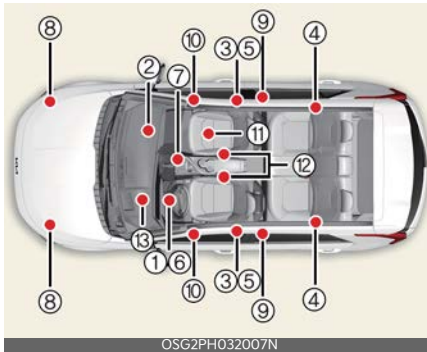

* The actual position of SRS components may differ from the illustration.

The SRS consists of the following components:

- 1 Driver's front air bag module
- 2 Passenger's front air bag module
- 3 Side air bag modules
- 4 Curtain air bag modules
- 5 Retractor pre-tensioner assemblies
- 6 Air bag warning light
- 7 SRS control module (SRSCM)/rollover sensor
- 8 Front impact sensors
- 9 Side impact sensors
- 10 Side pressure sensors
- 11 Occupant detection system
- 12 Front driver/passenger's seat belt buckle sensor
- 13 Driver's knee air bag module

Driver's front air bag (1)



The front air bag modules are located both in the center of the steering wheel and in the front passenger's panel above the glove box. When the SRSCM detects a sufficiently severe impact to the front of the vehicle, it will automatically deploy the front air bags.

Driver's front air bag (2)



Upon deployment, tear seams molded directly into the pad covers will separate under pressure from the expansion of the air bags. Further opening of the covers then allows full inflation of the air bags.

Driver's front air bag (3)



A fully inflated air bag, in combination with a properly worn seat belt, slows the driver's or the passenger's forward motion, reducing the risk of head and chest injury.

After complete inflation, the air bag immediately starts deflating, enabling the driver to maintain forward visibility and the ability to steer or operate other controls.

Passenger's front air bag



WARNING

Air Bag Obstructions

Do not install or place any accessories on the steering wheel, instrument panel, or on the front passenger's panel above the glove box in a vehicle. Such objects may become dangerous projectiles if the air bag deploys.

WARNING

Flying Objects

Do not place any objects (an umbrella, bag, etc.) between the front door and the front seat. Such objects may become dangerous projectiles if the side airbag inflates.

- If an air bag deploys, there may be a loud noise followed by a fine dust released in the vehicle. These conditions are normal and are not hazardous - the air bags are packed in this fine powder. The dust generated during air bag deployment may cause skin or eye irritation as well as aggravate asthma for some persons. Always wash all exposed skin areas thoroughly with cold water and a mild

soap after an accident in which the air bags were deployed.

- The SRS can function only when EV button is in the ON position. If the SRS air bag warning light does not appear, or continuously remains on after appearing for about 3~6 seconds when EV button is in the ON position after the vehicle is in the **READY** mode, or comes on while driving, the SRS is not working properly. If this occurs, have your vehicle immediately inspected by an authorized Kia dealer.

*** NOTICE**

Before you replace a fuse or disconnect a battery terminal, change the EV button to the OFF position. Never remove or replace the air bag related fuse(s) when the EV button is in the ON position. Failure to heed this warning will cause the SRS air bag warning light to appear.

Never remove or replace the air bag related fuse(s) when the EV button is ON position. Failure to heed this warning will cause the SRS air bag warning light to appear.

Occupant Detection System (ODS)

Your vehicle is equipped with an occupant detection system in the front passenger's seat.



The occupant detection system is designed to detect the presence of a properly-seated front passenger and determine if the passenger's front air

bag should be enabled (may inflate) or not. Only the front passenger front air bag is controlled by the Occupant Detection System.

Do not put anything in front of the passenger air bag OFF indicator.

Main components of the occupant detection system

- An detection device located within the front passenger seat cushion.
- An electronic system which determines whether the passenger air bag systems should be activated or deactivated.
- An indicator light located on the instrument panel which appears the words PASSENGER AIR BAG OFF indicates the front passenger air bag system is deactivated.
- The instrument panel air bag warning light is interconnected with the occupant detection system.

If the front passenger seat is occupied by a person that the system determines to be of appropriate size, and he/she sits properly (sitting upright with the seatback in an upright position, centered on the seat cushion with their seat belt on, legs comfortably extended and their feet on the floor), the PASSENGER AIR BAG OFF indicator will turn off and the front passenger's air bag will be able to inflate, if necessary, in frontal crashes.

You will find the PASSENGER AIR BAG OFF indicator on the map lamp. This system detects the conditions 1~4 in the following table and activates or deactivates the front passenger air bag based on these conditions.

Always be sure that you and all vehicle occupants are seated and restrained properly (sitting upright with the seat in

an upright position, centered on the seat cushion, with the person's legs comfortably extended, feet on the floor, and wearing the safety belt properly) for the most effective protection by the air bag and the safety belt.

- The ODS (Occupant Detection System) may not function properly if the passenger takes actions which can defeat the detection system. These include:
 1. Failing to sit in an upright position.
 2. Leaning against the door or center console.
 3. Sitting towards the sides or the front of the seat.
 4. Putting legs on the dashboard or resting them on other locations which reduce the passenger weight on the front seat.
 5. Improperly wearing the safety belt.
 6. Reclining the seatback.

Condition and operation in the front passenger occupant detection system

Condition detected by the occupant classification system	Indicator/Warning light		Devices
	"PASSENGER AIR BAG OFF" indicator light	SRS warning light	Front passenger air bag
1. Adult ¹	Off	Off	Activated
2. Child restraint system with child under 12 months old ^{2,3,4}	On	Off	Deactivated
3. Unoccupied	On	Off	Deactivated
4. Malfunction in the system	Off	On	Activated

- * 1. The system judges a person of adult size as an adult. When a smaller adult sits in the front passenger seat, the system may recognize him/her as a child depending on his/her physique and posture.
- * 2. Do not allow children to ride in the front passenger seat. When a larger child who has outgrown a child restraint system sits in the front passenger seat, the system may recognize him/her as an adult depending upon his/her physique or sitting position.
- * 3. Never install a child restraint system on the front passenger seat.
- * 4. The PASSENGER AIR BAG OFF indicator may turn on or off when a child above 12 months to 12 years old (with or without child restraint system) sits in the front passenger seat. This is a normal condition.

⚠ WARNING

- Do not install a child restraint system in the passenger seat when the seat is heavily soaked with any type of liquid.
- Do not alter or remodel the ODS (Occupant Detection System). This may damage the system and prevent its proper function in a collision.

*** NOTICE**

- Do not use car seat cushions that cover up the surface of the seat and aftermarket manufactured passenger seat heaters.
- After conducting car interior cleaning using steam or detergent, the seat should be dried properly. Afterward, check for normal operation of the PASSENGER AIR BAG OFF and air bag warning lights.
- Any service related to the passenger seat and the ODS must be done at an authorized Kia service center.
- After the passenger seat has been removed or installed for repair purposes, check for normal operation of the PASSENGER AIR BAG OFF and air bag warning lights with a person seated or not seated in the passenger seat.

⚠ WARNING

When the PASSENGER AIR BAG OFF symbol appears, the passenger air bag system will not operate. The passenger air bag system will operate when necessary if the symbol does not appear.

*** NOTICE**

Do not modify or replace the front passenger seat. Do not place anything on or

attach anything, such as a blanket, front seat cover or after market seat heater, to the front passenger seat. This can adversely affect the occupant detection system.

⚠ WARNING

ODS System

Riding in an improper position adversely affects the Occupant Detection System and may result in the deactivation of the front passenger airbag. It is important for the driver to instruct the passenger as to the proper seating instructions as contained in this manual.

- Do not place a heavy load in the front passenger seatback pocket or on the front passenger seat.



- Do not place feet on the front passenger seatback.



- Do not move your hips too forward in the seat.



Safety features of your vehicle

- Never excessively recline the front passenger seatback.



- Never place feet on the dashboard.



- Never lean on the door or center console.
- Do not sit with your weight excessively skewing to the left or right on the front passenger seat.



- Do not use car seat accessories, such as thick blankets and cushions, that cover up the car seat surface.
- Do not sit on the passenger seat wearing heavily padded clothes, such as ski wear and hip protector.



- Do not place electronic devices, such as laptops and DVD player, or con-

Air bag - advanced supplemental restraint system

ductive materials such as water bottles, on the passenger seat.

- Do not use electronic devices, such as laptops and satellite radios, that use inverter chargers.

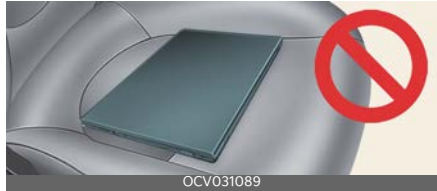

- Wet Passenger Seat

Do not spill liquid in the passenger seat. Spilled liquid on the passenger seat may cause the air bag warning light to appear or malfunction. If any liquid is spilled, make sure the seat has been completely dried before driving the vehicle.

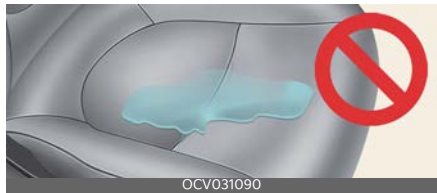

Proper position



When an adult is seated in the front passenger seat, if the PASSENGER AIR BAG OFF indicator is on, change EV button to the OFF position and ask the passenger to sit properly (sitting upright with the seatback in an upright position, centered on the seat cushion with their seat belt

on, legs comfortably extended and their feet on the floor). Restart the vehicle and have the person remain in that position. This will allow the system to detect the person and to enable the passenger air bag.

If the PASSENGER AIR BAG OFF indicator is still on, ask the passenger to move to the rear seat.

WARNING

PASSENGER AIR BAG OFF Light

Do not allow an adult passenger to ride in the front seat when the PASSENGER AIR BAG OFF indicator appears because the air bag will not deploy in the event of a crash. The driver must instruct the passenger to reposition himself in the seat. Failure to properly position himself may lead to air bag deactivation, resulting in air bag non-deployment in a collision. If the PASSENGER AIR BAG OFF indicator remains illuminated after the passenger repositions themselves properly and the car is restarted, it is recommended that the passenger move to the rear seat because the passenger's front air bag will not deploy.

NOTICE

The PASSENGER AIR BAG OFF indicator appears for about Max 4seconds after EV button is turned to the ON position after the vehicle is started. If the front passenger seat is occupied, the occupant detection sensor will then classify the front passenger after several more seconds.

- Even though your vehicle is equipped with the occupant detection system, never install a child restraint system in the front passenger's seat. A deploy-

ing air bag can forcefully strike a child resulting in serious injuries or death.

Any child age 13 and under should ride in the rear seat. Children too large for child restraints should use the available lap/shoulder belts. No matter what type of crash, children of all ages are safer when restrained in the rear seat.

If the occupant detection system is not working properly, the SRS air bag warning light on the instrument panel will appear because the passenger's front air bag is connected with the occupant detection system. If there is a malfunction of the occupant detection system, the PASSENGER AIR BAG OFF indicator will not appear and the passenger's front air bag will inflate in frontal impact crashes even if there is no occupant in the front passenger's seat.

Driver's and passenger's front air bag

Your vehicle is equipped with an Advanced Supplemental Restraint (Air Bag) System and lap/shoulder belts at both the driver and passenger seating position.

Driver's and Passenger's front air bag



Driver's knee air bag



The indication of the system's presence are the letters "AIR BAG" located on the air bag pad cover on the steering wheel and the passenger's side front panel pad above the glove box.

The SRS consists of air bags installed under the pad covers in the center of the steering wheel and the passenger's side front panel above the glove box.

The purpose of the SRS is to provide the vehicle's driver and/or the front passenger with additional protection than that offered by the seat belt system alone in case of a frontal impact of sufficient severity. The SRS uses sensors to gather information about the driver's and front passenger's seat belt usage and impact severity.

The seat belt buckle sensor determines if the front passenger's seat belt is fastened.

These sensors provide the ability to control the SRS deployment based on whether or not the seat belts are fastened, and how severe the impact is.

The advanced SRS offers the ability to control the air bag inflation with two levels. A first stage level is provided for moderate-severity impacts. A second stage level is provided for more severe impacts.

The passenger's front air bag is designed to help reduce the injury of children sitting close to the instrument panel in low speed collisions. However, children are safer if they are restrained in the rear seat.

According to the impact severity and seat belt usage, the SRSCM (SRS Control Module) controls the air bag inflation. Failure to properly wear seat belts can increase the risk or severity of injury in an accident.

Additionally, your vehicle is equipped with an occupant detection system in the front passenger's seat. The occupant detection system detects the presence of a passenger in the front passenger's seat and will turn off the front passenger's air bag under certain conditions. For more detail, see "Occupant Detection System (ODS)" on page 4-36.

WARNING

Modification

Modification to the seat structure can cause the air bag to deploy at a different level than should be provided.

Manufacturers are required by government regulations to provide a contact point concerning modifications to the

vehicle for persons with disabilities, which modifications may affect the vehicle's advanced air bag system. That contact is Kia's toll-free Customer Assistance center at 1-800-333-4Kia. However, Kia does not endorse nor will it support any changes to any part or structure of the vehicle that could affect the advanced air bag system, including the occupant detection system.

⚠ WARNING

Replacement/Modifications

The front passenger seat, dashboard or door should not be replaced except by an authorized Kia dealer using original Kia parts designed for this vehicle and model. Any other such replacement or modification could adversely affect the operation of the occupant detection system and your advanced air bags.

⚠ WARNING

Modification

Modification to the seat structure can cause the air bag to deploy at a different level than should be provided.

Advanced air bags are combined with pre-tensioner seat belts to help provide enhanced occupant protection in frontal crashes. Front air bags are not intended to deploy in collisions in which sufficient protection can be provided by the seat belt.

*** NOTICE**

Air bags can only be used once - have an authorized Kia dealer replace the air bag immediately after deployment.

Front air bags are not intended to deploy in side-impact, rear-impact or rollover crashes. However, when frontal

deployment threshold is satisfied at side-impact, front air bags may deploy. In addition, front air bags will not deploy in frontal crashes below the deployment threshold.

⚠ WARNING

SRS Wiring

Do not tamper with or disconnect SRS wiring or other components of the SRS system. Doing so could result in injury, due to accidental deployment of the air bags or by rendering the SRS inoperative.

⚠ WARNING

No Attaching Objects

No objects (such as crash pad cover, cellular phone holder, cup holder, perfume or stickers) should be placed over or near the air bag modules on the steering wheel, instrument panel, windshield glass, and the front passenger's panel above the glove box. Such objects could cause harm if the vehicle is in a crash severe enough to cause the air bags to deploy.

Do not place any objects over the air bag or between the air bag and yourself.

Side air bag

Your vehicle is equipped with a side air bag in each front seat.

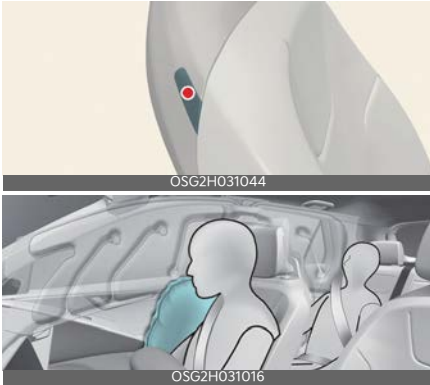

* The actual air bags in the vehicle may differ from the illustration.

The purpose of the air bag is to provide the vehicle's driver and/or the front passenger with additional protection than that offered by the seat belt alone.

- The side air bags are designed to deploy during certain side-impact collisions, depending on the crash severity of impact.
- The side air bags may deploy on the side of the impact or on both sides.
- The side and/or curtain air bags on both sides of the vehicle will deploy if a rollover or possible rollover is detected.
- The side air bags are not designed to deploy in all side impact or rollover situations.

⚠ WARNING

Unexpected Deployment

Avoid impact to the side impact airbag sensor when the EV button is ON to prevent unexpected deployment of the side air bag.

- The side air bag is supplemental to the driver's and the passenger's seat belt systems and is not a substitute for them. Therefore your seat belts must be worn at all times while the vehicle is in operation.
- For best protection from the side air bag system and to avoid being injured by the deploying side air bag, both front seat occupants should sit in an upright position with the seat belt properly fastened. The driver's hands should be placed on the steering wheel at the 9:00 and 3:00 positions. The passenger's arms and hands should be placed on their laps.

⚠ WARNING

Deployment

Do not install any accessories including seat covers, on the side or near the side air bag, as this may adversely affect the deployment of the side air bags.

- If seat or seat cover is damaged, have the vehicle checked and repaired by an authorized Kia dealer. Inform the dealer that your vehicle is equipped with side air bags and an occupant detection system.

⚠ WARNING**Flying Objects**

Do not place any objects (an umbrella, bag, etc.) between the front door and the front seat. Such objects may become dangerous projectiles if the side airbag inflates.

⚠ WARNING**No Attaching Objects**

- Do not place any objects over the air bag or between the air bag and yourself. Also, do not attach any objects around the area in which the air bag inflates, such as the door, side door glass, front and rear pillar.
- Do not put any objects between the side airbag label and seat cushion. It could cause harm if the vehicle is in a crash severe enough to cause the air bags to deploy.
- Never place or insert any object into any small opening near the side air-bag labels attached to the vehicle seats. When the air bag deploys, the object may adversely affect the deployment and result in an unexpected accident or bodily harm.
- Do not install any accessories on the side or near the side air bags.

Curtain air bag

Curtain air bags are located along both sides of the roof rails above the front and rear doors.

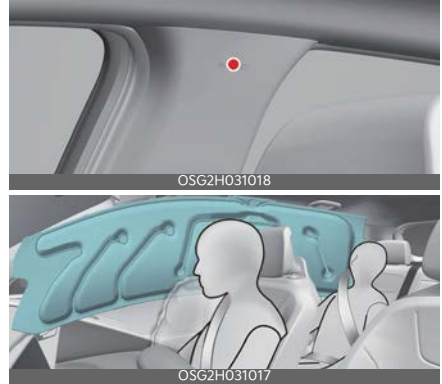

* The actual air bags in the vehicle may differ from the illustration.

They are designed to help protect occupants in certain side impacts and to help prevent them from ejecting out of the vehicle as a result of a rollover, especially when the seatbelts are also in use.

- The curtain air bags are designed to deploy during certain side impact collisions, depending on the severity of impact. However, when side deployment threshold is satisfied at front-impact, side air bags may deploy.
- The curtain air bags may deploy on the side of the impact or on both sides.
- Also, the curtain air bags on both sides of the vehicle will deploy in certain rollover situations.
- The curtain air bags are not designed to deploy in all side impact or rollover situations.

Do not allow the passengers to lean their heads or bodies against the doors, put their arms on the doors, stretch their

arms out of the window or place objects between the doors and passengers when they are seated on seats equipped with side impact and/or curtain air bags.

*** NOTICE**

Never try to open or repair any components of the side and curtain air bag system. This should only be done by an authorized Kia dealer.

⚠ WARNING

No Attaching Objects

- Do not place any objects over the air bag. Also, do not attach any objects around the area in which the air bag inflates, such as the door, side door glass, front and rear pillar, roof side rail.
 - Do not hang hard, breakable, or heavy objects on the coat hooks for safety reasons.
-

Air bag collision sensors

The air bag collision sensors are located in the following positions.



OSG2EV031001

1



2



3



4



* The actual features in your vehicle may not necessarily be available due to the selected options or regions.

- 1 Supplemental Restraint System (SRS) control module/rollover sensor
- 2 Front impact sensor
- 3 Side pressure sensors (front door)
- 4 Side impact sensor (B-pillar)

⚠ WARNING

Air Bag Sensors

- Do not hit or allow any objects to impact the locations where air bags or sensors are installed.

This may cause unexpected air bag deployment, which could result in serious personal injury or death.

- If the installation location or angle of the sensors is altered in any way, the air bags may deploy when they should not or they may not deploy when they should.

Therefore, do not try to perform maintenance on or around the air bag sensors. Have the vehicle checked and repaired by an authorized Kia dealer.

Problems may arise if the sensor installation angles are changed due to the deformation of the front bumper, front end module, body or front doors where side collision sensors are installed. Have the vehicle checked and repaired by an authorized Kia dealer.

Installing bumper guards (or side step or running board) or replacing a bumper (or front door module) with non-genuine parts may adversely affect your vehicle's collision and air bag deployment performance. Kia Genuine bumper guards/ bumpers are parts we guarantee for quality and performance.

Why didn't my air bag go off in a collision? (Inflation and non-inflation conditions of the air bag)

There are many types of accidents in which the air bag would not be expected to provide additional protection.

These include rear impacts, second or third collisions in multiple impact accidents, as well as low speed impacts.

Air bag inflation conditions

Front air bags



Front air bags are designed to inflate in a frontal collision depending on the severity of impact of the front collision.

Side and/or curtain air bags



Side and/or curtain air bags are designed to inflate when an impact is detected by side collision sensors depending on the severity of impact resulting from a side impact collision.

Also, the side and curtain air bags are designed to inflate when a rollover is detected by a rollover sensor.

Although the front air bags (driver's and front passenger's air bags) are primarily designed to inflate in frontal collisions, they may inflate in other types of collisions if the front impact sensors detect a sufficient frontal force in another type of impact.

Similarly, although side and curtain air bags are designed to inflate in certain side impact collisions, they may inflate in other types of collisions where a side force is detected by the sensors. For instance, side air bag and/or curtain air bags may inflate if rollover sensors indicate the possibility of a rollover occurring (even if none actually occurs) or in other situations, including when the vehicle is tilted while being towed.

Even if side and/or curtain air bags do not provide impact protection in a rollover, they will deploy to prevent ejection of occupants, especially those who are restrained with seat belts.

If the vehicle chassis is impacted by bumps or objects on unimproved roads, the air bags may deploy. Drive carefully on unimproved roads or on surfaces not designed for vehicle traffic to prevent unintended air bag deployment.

Air bag non-inflation conditions

- In certain low-speed collisions the air bags may not deploy. The air bags are designed not to deploy in such cases because they may not provide benefits beyond the protection of the seat belts in such collisions.



- Air bags are not designed to inflate in rear collisions, because occupants are moved backward by the force of the impact. In this case, inflated air bags would not be able to provide any additional benefit.



- Front air bags may not inflate in side impact collisions, because occupants move to the direction of the collision, and thus in side impacts, frontal air bag deployment would not provide additional occupant protection.



- In an angled collision, the force of impact may direct the occupants in a direction where the air bags would not be able to provide any additional benefit, and thus the sensors may not deploy any air bags.



- Just before impact, drivers often brake heavily. Such heavy braking lowers the front portion of the vehicle causing it to "under-ride" under a vehicle with a higher ground clearance. Air bags may not inflate in this "under-ride" situation because deceleration forces that are detected by sensors may be significantly reduced by such "under-ride" collisions.



- Front air bags may not inflate in all rollover accidents when the SRSCM indicates that the front air bag deployment would not provide additional occupant protection.



- Air bags may not inflate if the vehicle collides with objects such as utility poles or trees, where the point of impact is concentrated to one area and the full force of the impact is not delivered to the sensors.



Supplemental Restraint System (SRS) care

The SRS is virtually maintenance-free and so there are no parts you can safely service by yourself.

If the SRS air bag warning light does not appear, or continuously remains on, have your vehicle immediately inspected by an authorized Kia dealer.

Any work on the SRS system, such as removing, installing, repairing, or any work on the steering wheel, the front

passenger's panel, front seats and roof rails must be performed by an authorized Kia dealer. Improper handling of the SRS system may result in serious personal injury.

For cleaning the air bag pad covers, use only a soft, dry cloth or one which has been moistened with plain water. Solvents or cleaners could adversely affect the air bag covers and proper deployment of the system.

If components of the air bag system must be discarded, or if the vehicle must be scrapped, certain safety precautions must be observed. An authorized Kia dealer knows these precautions and can give you the necessary information. Failure to follow these precautions and procedures could increase the risk of personal injury.

⚠ WARNING

Tampering with SRS

Do not tamper with or disconnect SRS wiring, or other components of the SRS system. Doing so could result in the accidental inflation of the air bags or render the SRS inoperative.

⚠ WARNING

Towing Vehicle

Always have the vehicle in OFF position when your vehicle is being towed. The side air bags may inflate if the vehicle is tilted, such as when being towed, because of the rollover sensors in the vehicle.

Adding equipment to or modifying your air bag-equipped vehicle

If you modify your vehicle by changing your vehicle's frame, bumper system, front end or side sheet metal or ride height, this may affect the operation of your vehicle's air bag system.

Air bag warning label

Air bag warning labels, some required by the U.S. National Highway Traffic Safety Administration (NHTSA), are attached to the sun visor to alert the driver and passengers of potential risks of the air bag system.



Features of your vehicle **5**

Keys	5-6
• Smart key.....	5-6
• Battery replacement.....	5-9
Immobilizer system	5-10
Theft-alarm system	5-11
• Armed stage.....	5-11
• Theft-alarm stage.....	5-12
• Disarmed stage.....	5-12
Door locks	5-13
• With the smart key.....	5-13
• With the mechanical key.....	5-14
• Operating door locks from inside the vehicle.....	5-15
• Door lock/unlock features.....	5-17
• Manual door lock switch.....	5-17
• Child-protector rear door lock.....	5-17
• Electronic child safety lock system.....	5-18
• Rear Occupant Alert (ROA) System.....	5-19
Digital Key 2 Touch	5-20
• Digital Key 2 Touch (Smart Phone).....	5-20
• Digital Key 2 Touch (Card Key).....	5-23
• Personalized Profile and Vehicle Settings.....	5-26
• Used Vehicle/Digital Key 2 Touch Maintenance.....	5-29
• Limitations of the System.....	5-29
Driver Position Memory System	5-30
• Storing memory positions.....	5-30
• Recalling memory positions.....	5-30
• Resetting memory positions.....	5-30
• Seat easy access.....	5-31
Liftgate	5-32
• Opening the liftgate.....	5-32

5 Features of your vehicle

- Closing the liftgate 5-32
- Emergency liftgate safety release 5-32
- Power liftgate..... 5-34**
- Operating the power liftgate 5-35
- Setting the power liftgate..... 5-36
- Resetting the power liftgate..... 5-37
- Emergency liftgate safety release..... 5-38
- Smart Liftgate with Auto Open 5-39**
- How to use the Smart Liftgate with Auto Open 5-39
- How to deactivate the Smart Liftgate with Auto Open function using the smart key..... 5-40
- Detecting area 5-40
- Windows 5-42**
- Window opening and closing 5-43
- Power window lock button 5-45
- Hood 5-46**
- Opening the hood..... 5-46
- Hood open warning 5-46
- Closing the hood 5-47
- Front trunk..... 5-48**
- Opening the front trunk..... 5-48
- Closing the front trunk 5-48
- Charging door 5-49**
- Opening and closing the charging door 5-49
- Sunroof..... 5-50**
- Sunshade 5-51
- Tilt open/close 5-51
- Slide open/close 5-51
- Automatic reversal 5-52
- Resetting the sunroof..... 5-52
- Sunroof open warning..... 5-53

Steering wheel	5-54
• Electric Power Steering (EPS)	5-54
• Tilt and telescopic steering wheel	5-55
• Heated steering wheel.....	5-55
• Horn	5-56
Mirrors.....	5-57
• Inside rear view mirror.....	5-57
• Outside rear view mirror	5-65
Instrument cluster	5-68
• Cluster themes	5-70
• Instrument panel illumination control.....	5-71
• Gauges.....	5-72
LCD display.....	5-75
• Changing LCD display modes.....	5-75
• LCD display modes.....	5-75
• LCD display messages.....	5-80
Warning and indicator lights	5-85
• Warning lights.....	5-85
• Indicator lights	5-91
Head-Up Display (HUD).....	5-94
• Head Up Display Information	5-94
• Head-Up Display Setting	5-95
Lighting.....	5-95
• Battery saver function.....	5-95
• Headlamp delay function.....	5-95
• Daytime Running Light (DRL).....	5-96
• Lighting control.....	5-96
• Operating high beam	5-97
• Operating turn signals and lane change signals	5-98
• Operating front fog light	5-98
• High Beam Assist (HBA).....	5-99

5 Features of your vehicle

Wipers and washers	5-101
• Auto control.....	5-102
• Operating windshield washers	5-103
• Operating rear window wiper and washer switch	5-103
Interior lights.....	5-104
• Automatic turn off function.....	5-104
• Map lamp.....	5-104
• Room lamp	5-105
• Luggage room lamp	5-105
• Vanity mirror lamp	5-105
• Glove box lamp.....	5-106
Welcome system	5-106
Defroster	5-107
• Operating rear window defroster	5-107
• Outside mirror defroster.....	5-108
Automatic climate control system.....	5-109
• Using the infotainment/climate switchable controller	5-110
• Heating and air conditioning automatically.....	5-110
• Heating and air conditioning manually.....	5-112
• System operation.....	5-116
• Climate control air filter.....	5-118
• Air conditioning refrigerant label.....	5-118
• Checking the amount of air conditioner refrigerant and compressor lubricant.....	5-119
Windshield defrosting and defogging.....	5-120
• Defrosting outside windshield with automatic climate control.....	5-120
• Defogging inside windshield with automatic climate control ..	5-120
• Defogging logic.....	5-121
• Auto Defogging System (ADS)	5-121
• Automatic ventilation	5-122

Features of your vehicle **5**

• Smart ventilation	5-122
• A/C Automatic Drying	5-122
Storage compartment	5-123
• Center console storage	5-123
• Glove box.....	5-124
Interior features.....	5-124
• Ambient lights.....	5-124
• Cup holder.....	5-124
• Seat warmer	5-125
• Air ventilation seat	5-126
• Sun visor.....	5-127
• USB charger	5-127
• AC inverter	5-128
• Power outlet	5-129
• Wireless smart phone charging system.....	5-129
• Coat hook	5-132
• Floor mat anchors.....	5-132
• Luggage board.....	5-133
• Luggage net holder.....	5-133
• Cargo security screen	5-134
Exterior features.....	5-135
• Roof rack.....	5-135
Infotainment system	5-136
• Using the infotainment/climate switchable controller.....	5-136
• Audio system.....	5-137
Declaration of Conformity	5-140

Features of your vehicle

Keys

The mechanical key and various remote functions are integrated into the smart key to provide convenience to the driver.

Record your key number



The key code number is stamped on the key code tag attached to the key set. Should

you lose your keys, this number will enable an authorized Kia dealer to duplicate the keys easily. Remove the key code tag and store it in a safe place. Also, record the key code number and keep it in a safe and handy place, but not in the vehicle.

⚠ WARNING

Aftermarket keys

Use only Kia original parts for the ignition key in your vehicle. If an aftermarket key is used, the ignition switch or EV button may not return to ON after START. If this happens, the starter will continue to operate causing possible fire due to excessive current in the wiring.

⚠ WARNING

Never leave the keys in your vehicle

Leaving children unattended in a vehicle with the keys is dangerous even if the vehicle is ACC or ON position. Unattended children could press the EV button and may operate power windows or other controls, or even make the vehicle move, which could result in serious bodily injury or even death. Never leave the keys in your vehicle with unsuper-

vised children, when the vehicle is running.

Smart key

With a smart key, you can lock or unlock a door and even start the vehicle without inserting the key.

Type A



Type B



Type C



Lock (1)

All doors are locked if the lock button is pressed. If all doors are closed, the hazard warning lights will blink and the chime will sound once to indicate that all doors are locked.

Also, if the lock button is pressed once more within 4 seconds, the hazard warning lights will blink and the chime will sound once to confirm that the door is locked.

However, if any door remains open, the hazard warning lights (and/or the chime) will not operate. But if all doors are closed after the lock button is pressed, the hazard warning lights will blink once.

Unlock (2)

All doors are unlocked if the unlock button is pressed once. The hazard warning lights will blink twice to indicate that all doors are unlocked.

After pressing this button, the doors will lock automatically unless you open any door within 30 seconds.

If you attempt to lock or unlock the door by pressing the door lock/unlock button in any of the following states, the door will not be locked or unlocked.

- When you want to lock or unlock the door in the ACC or ON state.
- When you want to lock a door in a car with one or more doors open.

Depending on the vehicle, the driver can activate or deactivate the 2-press unlock setting function. For more information, refer to "User settings mode" on page 5-78

* NOTICE

If the smart key is inoperative due to exposure to water or liquids, it will not be covered by your manufacturer's vehicle warranty.

Liftgate open/close (3) (if equipped)

The liftgate is unlocked or opened (if equipped) if the button is pressed for more than 1 second.

When the power liftgate is opened, press and hold the power liftgate open/close

button to close the liftgate. If you release the button while the liftgate is closing, power liftgate operation will stop with a warning sound for 5 seconds.

Panic alarm (4)

The horn sounds and the hazard warning lights blink for about 30 seconds if this button is pressed for more than 0.5 seconds. To stop the horn and lights, press any button on the transmitter.

Remote start (5)

You can start the vehicle using the remote start button (5) of the smart key. To start the vehicle remotely:

- Lock the doors by pressing the door lock button (1) within 32 ft (10 m) distance from the vehicle.
- Press the remote start button for over 2 seconds within 4 seconds after locking the doors.

Press the remote start button once to turn off the vehicle.

If no further action for operating/driving the vehicle is taken, the vehicle will be turned off 10 minutes after starting the vehicle remotely.

While remote starting, the hazard warning lights blink 3 times. If you want to stop the vehicle, press the Remote Start button (5) again.

Remote smart parking assist (RSPA) (6, 7) (if equipped)

You can start the vehicle without inserting the key.

- * The Remote smart parking assist (RSPA) helps the drivers park their vehicle by using sensors to measure parking spaces and control the steer-

ing wheel, gear shift and vehicle speed to semi-automatically park the vehicle. With the smart key, the driver can move the vehicle forward or backward using the forward/ backward buttons (6, 7) on the smart key. For more information, refer to "Remote Smart Parking Assist (RSPA) (if equipped)" on page 6-153.

Start-up

You can start the vehicle without inserting the key.

* For more information, refer to "EV button" on page 6-6.

Mechanical key

If the smart key does not operate normally, you can lock or unlock the door by using the mechanical key.



To remove the mechanical key, press and hold the release button (1) and remove the mechanical key (2).

To reinstall the mechanical key, put the key into the hole and push it until a "click" sound is heard.

⚠ WARNING

Smart key

Never leave the keys in your vehicle with unsupervised children. Leaving children unattended in a vehicle with a manual ignition key or a EV button is dangerous. Children copy adults and they could place the key in the ignition switch or press the start button. The key would

enable children to operate power windows or other controls, or even make the vehicle move, which could result in serious bodily injury or death.

Smart key precautions

The smart key may not work if any of the following occur:

- The smart key is close to a radio transmitter such as a radio station or an airport which can interfere with normal operation of the smart key.
- The smart key is near a mobile two-way radio system or a cellular phone.
- Another vehicle's smart key is being operated close to your vehicle.

When the smart key does not work correctly, open and close the door with the mechanical key and contact an authorized Kia dealer.

If the smart key is in close proximity to your cell phone or smart phone, the signal from the smart key could be blocked by normal operation of your cell phone or smart phone. This is especially important when the phone is active, such as when making calls, receiving calls, text messaging, and/or sending/receiving emails. Avoid placing the smart key and your cell phone or smart phone in the same pants or jacket pocket and maintain adequate distance between the two devices.

*** NOTICE**

Loss of the smart key

A maximum of 2 smart keys can be registered to a single vehicle.

If you happen to lose your smart key, you will not be able to start the vehicle. You should immediately take the vehicle and remaining key to your authorized

Kia dealer (tow the vehicle, if necessary) to protect it from potential theft.

⚠ CAUTION

Transmitter

Keep the transmitter away from water or any liquid, as it can become damaged and not function properly.

* NOTICE

If the smart key is inoperative due to exposure to water or liquids, it will not be covered by your manufacturer's vehicle warranty.

* NOTICE

To prevent the electronic key from becoming damaged by magnetic fields, do not leave it near the following electrical appliances:

- TVs
- Personal computers
- Cellular phones, cordless phones and battery chargers
- Table lamps
- Induction cookers

* NOTICE

If you have to leave the vehicle's key with a parking attendant, remove the mechanical key for your own use and provide the attendant with the electronic key only.

* NOTICE

When bringing a smart key onto an airplane, make sure you do not press any button on the key while inside the cabin. If you are carrying the key in your bag etc., make sure that the buttons cannot

be pressed accidentally. If you press a button, the key may emit radio waves that could interfere with the operation of the aircraft.

Battery replacement

The smart key uses a 3 volt lithium battery which will normally last for several years.



If you are unsure how to use or replace the battery, contact an authorized Kia dealer.

1. Detach mechanical key from your smart key.
2. Pry open the key cover.
3. Replace the smart key cover with a new battery. (CR2032) When replacing the battery, make sure the battery position is correct.
4. Install the battery in the reverse order of removal.

For smart key replacement, visit an authorized Kia dealer.

The smart key is designed to give you years of trouble-free use, however it can malfunction if exposed to moisture or static electricity. If you are unsure how to use or replace the battery, contact an authorized Kia dealer.

Using the wrong battery can cause smart key to malfunction. Be sure to use the correct battery.



An inappropriately disposed battery can be harmful to the environment and human

health. Dispose the battery according to your local law(s) or regulation.

⚠ WARNING

THIS PRODUCT CONTAINS A BUT-TON BATTERY

If swallowed, a lithium button battery can cause severe or fatal injuries within 2 hours.

Keep batteries out of reach of children. If you think batteries may have been swallowed or placed inside any part of the body, seek immediate medical attention.

⚠ CAUTION

Smart key damage

The smart key can malfunction if dropped, exposed to moisture, static electricity, heat or direct sunlight.

This device complies with Part 15 of the FCC rules.

Operation is subject to the following two conditions:

1. This device may not cause harmful interference, and
2. This device must accept any interference received, including interference that may cause undesired operation.

*** NOTICE**

Changes or modifications not expressly approved by the party responsible for compliance could void the user's authority to operate the equipment. If the smart key is inoperative due to changes or modifications not expressly approved by the party responsible for compliance, it will not be covered by your manufacturer's vehicle warranty.

Immobilizer system

The immobilizer system protects your vehicle from theft. If an improperly coded key (or other device) is used, the vehicle's power system is disabled.

When the EV button is placed in the ON position, the immobilizer system indicator should come on briefly, then go off. If the indicator starts to blink, the system does not recognize the coding of the key.

Place the EV button to the OFF position, then place the EV button to the ON position again.

In some circumstances, the vehicle may not recognize your smart key if another smart key device is nearby or a metal object such as a key chain is causing interference with the smart key.

If this occurs, your vehicle may not start. Remove any metal objects or additional keys near the smart key before attempting to start the vehicle again.

If the system repeatedly does not recognize the coding of the key, it is recommended that you contact your Kia dealer.

Do not attempt to alter this system or add other devices to it. Electrical problems could result that may make your vehicle inoperable.

*** NOTICE**

When starting the vehicle, do not use the key with other immobilizer keys around. Otherwise the vehicle may not start or may stop soon after it starts. Keep each key separate in order to avoid a starting malfunction.

⚠ WARNING

In order to prevent theft of your vehicle, do not leave spare keys anywhere in your vehicle. Your immobilizer password is a customer unique password and should be kept confidential.

This device complies with Part 15 of the FCC rules.

Operation is subject to the following three conditions:

1. This device may not cause harmful interference, and
2. This device must accept any interference received, including interference that may cause undesired operation.
3. Changes or modifications not expressly approved by the party responsible for compliance could void the user's authority to operate the device.

*** NOTICE**

Changes or modifications not expressly approved by the party responsible for compliance could void the user's authority to operate the equipment. If the smart key is inoperative due to changes or modifications not expressly approved by the party responsible for compliance, it will not be covered by your manufacturer's vehicle warranty.

Theft-alarm system

This system is designed to provide protection from unauthorized entry into the vehicle.

- 1 Armed stage
- 2 Theft-alarm stage
- 3 Disarmed stage

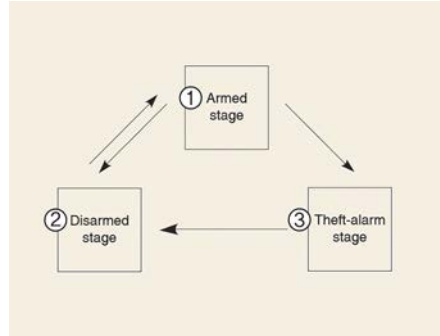

This system is operated in three stages: the first is the "Armed" stage, the second is the "Theft-alarm" stage, and the third is the "Disarmed" stage. If triggered, the system provides an audible alarm with blinking of the hazard warning lights.

Armed stage

Park and stop the vehicle. Arm the system as described below.

Entering the armed stage using the smart key

1. Place the EV button in the OFF position.
2. Make sure that all doors, the hood and liftgate are closed and latched.
3. Lock the doors by pressing the button of the front outside door handle with the smart key in your possession.

After completion of the steps above, the hazard warning lights will operate once to indicate that the system is armed.

If any door (or liftgate) or hood remains open, the hazard warning lights and the chime will not operate and the theft-alarm will not arm. If all doors and liftgate and hood are closed after the lock button is pressed, the hazard warning lights blink once.

The system can also be armed by locking the doors with the key from the front doors; however, the hazard warning lights will not blink using this method.

4. Lock the doors by pressing the lock button on the smart key.

After completion of the steps above, the hazard warning lights will operate once to indicate that the system is armed.

*** NOTICE**

Do not arm the system until all passengers have left the vehicle. If the system is armed while a passenger(s) remains in the vehicle, the alarm may be activated when the remaining passenger(s) leaves the vehicle. If any door (or liftgate) or hood is opened within 30 seconds after the system enters the armed stage, the system will be disarmed to prevent unnecessary alarm.

Theft-alarm stage

The alarm will be activated if any of the following occurs while the system is armed.

- A front or rear door is opened without using the smart key.
- The liftgate is opened without using the smart key.
- The hood is opened.

The horn will sound and the hazard warning lights will blink continuously for

approximately 27 seconds, and repeat the horn 3 times unless the system is disarmed. To turn off the system, unlock the doors with the smart key.

Disarmed stage

The system will be disarmed when:

- The doors (and liftgate) are unlocked with the smart key.

After pressing the unlock button, the hazard warning lights will blink and the chime will sound twice (in smart key) to indicate that the system is disarmed.

After pressing the unlock button, if any door (or liftgate) is not opened within 30 seconds, the system will be rearmed.

*** NOTICE**

- Avoid trying to start the vehicle while the alarm is activated. The vehicle starting motor is disabled during the theft-alarm stage.

If the system is not disarmed with the smart key, open the doors by using the mechanical key and start the vehicle by directly pressing the EV button with the smart key.

- If you lose your keys, consult your authorized Kia dealer.

⚠ CAUTION

Adjusting Alarm System

Do not change, alter or adjust the theft alarm system in your vehicle. Improper installation of the alarm system could damage the vehicle or cause the system to malfunction.

*** NOTICE**

Malfunctions caused by improper alterations, adjustments or modifications to

the theft-alarm system are not covered by your vehicle manufacturer warranty.

Door locks

Know how to use the door lock so that you can lock or unlock the door if necessary.

With the smart key



Carrying the smart key, you may lock and unlock the vehicle doors (and lift-gate). Also, you may start the vehicle. Refer to the following for more details.

Locking

Pressing the button of the front driver side door handles with all doors closed and any door unlocked, locks all the doors. If all doors and hood are closed, the hazard warning lights will blink once to indicate that all doors are locked.

The button will only operate when the smart key is within 28 ~ 40 inches (0.7 ~ 1 m) from the driver side door handle. If you want to make sure that a door has locked or not, you should pull the driver side door handle.

Even though you press the driver side door handle buttons, the doors will not lock and the chime will sound for 3 seconds if any of following occur:

- The smart key is in the vehicle.
- The ignition switch or EV button is in the ACC or ON position.
- Any door except the liftgate is open.

Unlocking

Pressing the button of the front driver side door handles with all doors closed and locked, unlocks all the doors. The hazard warning lights blink twice to indicate that all doors are unlocked.

The button will only operate when the smart key is within 28 ~ 40 inches (0.7 ~ 1 m) from the front driver side door handle.

When the smart key is recognized in the area of 28 ~ 40 inches (0.7 ~ 1 m) from the front driver side door handle, other people can also open the door without possession of the smart key.

After pressing the button, the doors will lock automatically unless you open any door within 30 seconds.

With the mechanical key



1. Pull out the door handle.
 2. Press the lever (1) located inside the bottom part of the cover with a key or flat-head screwdriver.
 3. Push out the cover (2) while pressing the lever (only the driver's door can be locked/unlocked).
 4. Turn the key toward the rear of the vehicle to unlock and toward the front of the vehicle to lock. Only the driver's door can be locked or unlocked.
- Doors can also be locked and unlocked with the transmitter.
 - Once the doors are unlocked, they may be opened by pulling the door handle.

- When closing the door, push the door by hand. Make sure the doors are closed securely.

* NOTICE

- When locking the door with a mechanical key, be aware that only the driver's door can be locked/unlocked.
- To lock all doors, operate the central lock switch inside the vehicle. Open the car door using the inner handle, then close the door and lock the driver's door with a mechanical key.
- Refer to "Operating door locks from inside the vehicle" on page 5-15 to lock from inside the vehicle.

* NOTICE

- Be careful not to lose or scratch the cover when removing it.
- When the key cover freezes and does not open, tap it lightly or indirectly warm (hand temperature, etc.) it up.
- Do not apply excessive force to the door and door handle. It may be damaged.

* NOTICE

- In cold and wet climates, door lock and door mechanisms may not work properly due to freezing conditions.
- If the door is locked/unlocked multiple times in rapid succession with either the vehicle key or door lock switch, the system may stop operating temporarily in order to protect the circuit and prevent damage to system components.

⚠ WARNING

- Securely close your door before you begin driving. Failure to fully close your door may cause it to be opened during vehicle operation.
- Keep your body out of the way of the closing door to prevent injuries.

⚠ WARNING

If any passengers must remain in the vehicle while it is very hot or cold outside, there is risk of injuries or danger to life. Do not lock the vehicle from the outside when there are passengers in the vehicle.

⚠ CAUTION

Do not unnecessarily open and close the door repeatedly or with excessive force. Such action can damage the vehicle door.

*** NOTICE**

Always place the ignition switch or EV button in the OFF position, engage the parking brake, close all windows, and lock all doors when leaving your vehicle unattended.

- If you lock the door with the central door lock button, all vehicle doors will lock automatically.

*** NOTICE**

Always remove the ignition key, engage the parking brake, close all windows, and lock all doors when leaving your vehicle unattended.

Operating door locks from inside the vehicle

You can operate door locks with the door lock handle or central door lock switch.

With the door handle

- Front door
If the inner door handle is pulled when the door is locked, the door will unlock and open.
- Rear door
If the inner door handle is pulled once when the door is locked, the door will unlock.
If the inner door handle is pulled once more, the door will open.

Door lock malfunction

If a power door lock ever fails to function while you are in the vehicle, try one or more of the following techniques to exit:

- Operate the door unlock feature repeatedly (both electronic and manual) while simultaneously pulling on the door handle.
- Operate the other door locks and handles, front and rear.
- Lower a front window and use the key to unlock the door from outside.
- Move to the cargo area and open the liftgate.

⚠ WARNING

Do not pull the inner door handle of driver's (or passenger's) door while the vehicle is moving.

With the central door lock switch

Driver side



Passenger side

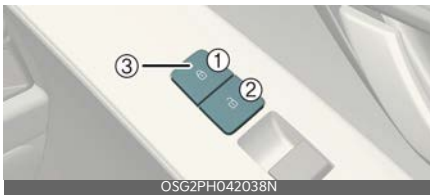

- 1 Door Lock
- 2 Door Unlock
- 3 Doors indicating light

Operate by pressing the central door lock switch.

- To lock all vehicle doors, press the central door lock switch (1) of driver and passenger side.
- To unlock all vehicle doors, press central door unlock switch (2) of driver and passenger side.

When all vehicle doors are locked, the indicating lights (3) on the driver's door and passenger's door will turn on. If any door is unlocked, it would go off.

Any door is opened, the doors will not lock even though the central door lock switch is pressed.

⚠ WARNING

Doors

- The doors should always be fully closed and locked while the vehicle is in motion to prevent accidental opening of the door. Locked doors will also discourage potential intruders when the vehicle stops or slows down.
- Be careful when opening doors and watch out for vehicles, motorcycles, bicycles or pedestrians approaching the vehicle in the path of the door. Opening a door when something is approaching can result in an accident to cause vehicle damage or serious injury.

*** NOTICE**

Unlocked vehicles

Leaving your vehicle unlocked can invite theft or possible harm to you or others from someone hiding in your vehicle while you are gone. Always remove the ignition key, engage the parking brake, close all windows and lock all doors when leaving your vehicle unattended.

⚠ WARNING

Unattended children, the elderly or pets

An enclosed vehicle can become extremely hot, causing death or severe injury such as heatstroke to unattended children, the elderly or pets who cannot escape the vehicle. When left or trapped in a hot vehicle, make sure to stay hydrated and avoid sun exposure through the vehicle's windshield. Furthermore, children might operate features of the vehicle that could injure them, or they could encounter other harm, possibly from someone gaining

entry to the vehicle. Never leave children or animals unattended in your vehicle.

Door lock/unlock features

The vehicle is equipped with door lock/unlock features for the safety and convenience of passengers.

Impact sensing door unlock system

All doors will automatically unlock when an impact causes the air bags to deploy.

Speed sensing door lock system

All doors will automatically lock after the vehicle speed exceeds 10 mph (15 km/h).

You can activate or deactivate the auto door lock/unlock features in the vehicle. Refer to "User settings mode" on page 5-78.

Manual door lock switch

If the electrical power door lock switch is not operating (e.g., dead car battery) the only way to lock the door(s) is with the mechanical key from the outside key hole.

Doors without an outside key hole can be locked as follows:

1. Open the door.
2. Insert the key into the door lock hole and turn the key to the lock position as shown.



3. Close the door securely.

* NOTICE

If the electrical power to door lock switch is not operating (e.g., dead car battery) and the liftgate is closed, you will not be able to open the liftgate until power is restored.

Child-protector rear door lock (if equipped)

The child safety lock is provided to help prevent children from accidentally opening the rear doors from inside the vehicle.

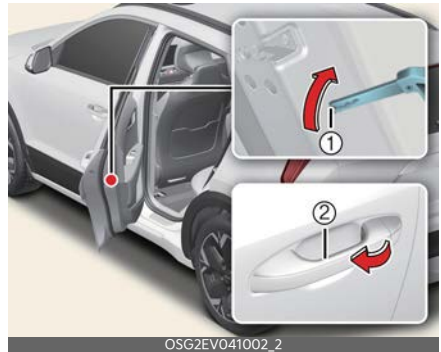

The rear door safety locks should be used whenever children are in the vehicle.

The child safety lock is located on the edge of each rear door. When the child safety lock is in the lock position (1), the rear door will not open if the inner door handle is pulled.

To lock the child safety lock, insert a key (or screwdriver) into the hole and turn it to the lock position.

To allow a rear door to be opened from inside the vehicle, unlock the child safety lock.

To open the rear door, pull the outside door handle (2).

⚠ WARNING**Rear door locks**

If children accidentally open the rear doors while the vehicle is in motion, they could fall out and be severely injured or killed. To prevent children from opening the rear doors from the inside, the rear door safety locks should be used whenever children are in the vehicle.

⚠ WARNING

- The system does not detect every obstacle approaching the vehicle exit.
- The driver and passenger are responsible for the accident occurred while exiting the vehicle. Always check the surrounding before you exit the vehicle.

Electronic child safety lock system (if equipped)**Operation**

- Push the electronic child safety lock button.

*** INFORMATION**

- If you push the electronic child safety lock switch and the indicator appears, rear passengers cannot open the rear door from inside the vehicle.
- Safe Exit Assist (SEA) does not automatically activate the electronic child safety lock system. If your vehicle is equipped with the Electronic child

safety lock, the child-protector rear door locks, which are manually operated, are not provided.

- If 3 minutes passes after the EV button is pressed to the OFF or ACC position, the indicator on the button turns off, and the driver cannot turn off electronic child safety lock by pressing the button. To turn off the function, press the EV button to the ON position, and then press the electronic child safety lock button.

⚠ WARNING

- If children accidentally open the rear doors while the vehicle is in motion, they could fall out and be severely injured or killed. To prevent children from opening the rear doors from the inside, the rear door safety locks should be used whenever children are in the vehicle.
- The system does not detect every obstacle approaching the vehicle exit.
- The driver and passenger are responsible for the accident occurred while exiting the vehicle. Always check the surrounding before you exit the vehicle.

⚠ WARNING

If the electronic child safety lock is not operated when pushing the electronic child safety lock switch, the message is displayed and the alarm will sound.



A: Child safety lock failure

If this occurs, have the system checked by a professional workshop. Visit an authorized Kia dealer.

Rear Occupant Alert (ROA) System

The Rear Occupant Alert (ROA) is provided to help prevent exiting the vehicle with a rear passenger left in the vehicle.

- When you open the front door after opening and closing the rear door and turning off the vehicle, the "Check rear seats" warning message appears on the cluster.

**A: Check rear seat for passengers and belongings**

You can activate or deactivate the ROA from the User Settings mode in the cluster LCD display. If your vehicle is equipped with an infotainment system, you can learn how to setup on the website via QR code in the infotainment quick reference guide.

The option can be found under the following menu:

1. Press the MODE button (📄) several times on the steering wheel until 'User Settings' menu appears on the LCD.
2. Select '**Convenience → Rear Occupant Alert**' with the MOVE switch (↖ / ↘) and the OK button on the steering wheel.

If your vehicle is equipped with the infotainment system, the option can be found under the following menu:

1. Press the SETUP button of the infotainment system.
2. Press '**Vehicle → Convenience → Rear Occupant Alert**' on the infotainment system screen.

⚠ WARNING

The Rear Occupant Alert (ROA) system does not actually detect objects or people in the rear seat. By using a rear door opened and closed history, the system informs the driver that there may be something in the rear seat.

⚠ CAUTION

- The Rear Occupant Alert (ROA) system uses a rear door opened and closed history.
- The history is reset after the vehicle is in OFF position, exits the vehicle and locks the door remotely. So even if a rear door does not reopen, the ROA system alert can occur.
- For example, after the ROA system alert occurs, if the driver does not lock the door, and drives again, the alert can occur.

*** INFORMATION**

The infotainment system may change after software updates. For more information, refer to the user's manual provided in the infotainment system and the quick reference guide.

Digital Key 2 Touch

Digital Key 2 Touch provides convenience to the driver, which the driver can use to lock or unlock the driver and passenger doors or the liftgate and turn on the vehicle.

Digital Key 2 Touch (Smart Phone)

How to register Digital Key 2 Touch (Smart phone)

To use the smart phone as a digital key (smart phone) follow the following procedure.

The driver can confirm supported/compatible devices on our website. As well as the FAQ section in particular within a new Digital Key Section.

Services are expected to be provided according to policy change.

Smart Phone Set Up

In order to use Digital Key 2 Touch (Smart phone) function, install Kia Access app on your smart phone and register your information.

For more details, please refer to Navigation Quick Reference Guide.

Smart Phone Registration

1. Turn the vehicle on with the Smart key and make sure to keep the smart key inside the vehicle during digital key registration.
2. With the vehicle on, touch **Setup** → **Vehicle** → **Digital Key** → **Smartphone Key** → **My Smartphone Key** on the infotainment system.



- 1) **Smartphone Key**
 - 2) **My Smartphone Key**
 - 3) **Save**
3. After pressing **Digital Key Settings** → **Register** on Kia Access app, place the backside of the smart phone on the in-vehicle authentication pad.

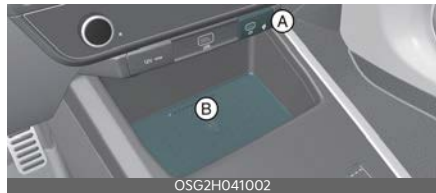

[A]: Indicator, [B]: Charging pad

- As long as the device is supported from additional vehicle services, the Digital Key can be registered wirelessly.
4. Select **Save** menu on the instrument cluster or on the infotainment system screen. The saving process will begin automatically.
 5. When the digital key (smart phone) is saved, a message will appear on the instrument cluster or the infotainment system screen.
 6. Remove the smart phone from the pad and complete the saving process under the guidance of the smart phone screen.

* INFORMATION

- The infotainment system may change after software updates. For more information, refer to the user's manual

provided in the infotainment system and the quick reference guide.

- Vehicle

When there is a digital key (smart phone) already saved in the vehicle, the **Save** menu is disabled. If you want to save a digital key again, refer to "Digital Key 2 Touch" on page 5-20 and follow the deleting procedure first before saving a digital key.

- Smart Phone

The digital key cannot be saved again while the vehicle's digital key is saved in the owner's smart phone. Save the digital key after deleting the digital key from the Kia Access App.

- During the digital key saving process, the process will cancel when:

- The smart phone is removed from the in-vehicle authentication pad (wireless charging pad)
- Changing the infotainment system or instrument cluster screen
- The vehicle is turned off
- The gear is shifted
- There is no smart key (saving process will not begin)

How to Use the Digital Key 2 Touch (Smart Phone)

Smart Phone Touch Control

The driver can lock and unlock the door by touching the smart phone on the door handle without activating the Kia Access App. Also, the vehicle can be started by placing the smart phone on the in-vehicle authentication pad (wireless charging pad).



[A]: Door handle authentication pad

[B]: NFC antenna (Backside of the smart phone) (The antenna position differs depending on models.)

Locking/Unlocking the doors

- If the driver touches the smart phone NFC antenna to the driver's or passenger's door handle authentication pad for more than 2 seconds, the door will lock or unlock.
- If 2 Press Unlock function is set, only the driver's door will be unlocked by touching the smart phone on the driver's door handle. Touch the smart phone once more within 4 seconds to unlock all doors.
- After unlocking the doors, the doors will automatically re-lock after 30 seconds unless a door is opened.
- If the smart phone digital key does not operate, move the smart phone more than 4 inches (0.1 m) from the door handle authentication pad and try it again.

* NOTICE

Note that you cannot lock your vehicle using the smart phone NFC antenna if any of the following occur:

- The Smart Key is in the vehicle

- The EV button is in ACC or ON position
- Attempting to lock the door when more than one door, or hood, tailgate (liftgate) is opened

Starting the vehicle

After placing your registered smart phone on the in-vehicle authentication pad (wireless charging pad), depress the brake pedal and press the EV button.

- Once the vehicle is started, you can remove the smart phone from the pad.

For more details, refer to "EV button" on page 6-6.

⚠ WARNING

The vehicle can be started when the registered smart phone is placed on the in-vehicle authentication pad (wireless charging pad). Therefore, do not leave unsupervised children or people who are not aware of the system since it can result in serious injury or death. In addition, always have the registered smart phone with you to prevent vehicle theft when leaving the vehicle.

*** NOTICE**

The operation time of Digital Key 2 Touch for shared user may extend during first time use.

Approach your Digital Key 2 Touch (smartphone) on the authentication pad located in the outside door handle until the vehicle door lock/unlock function operates.

If the inner authentication pad is used for the first time, 1st vehicle start function may not operate.

How to delete Digital Key (Smart Phone)

Turn the vehicle on with the smart key and make sure to keep the smart key inside the vehicle during the digital key (smart phone) deleting process.

1. Delete All digital Key (Smart Phone)



- 1) **Digital Key**
- 2) **Smartphone Key**
- 3) **Delete All**

With the vehicle on, touch **Setup** → **Vehicle** → **Digital Key** → **Smartphone Key** → **Delete All** on the infotainment system.

- The key of owner and the shared user will be deleted.
- If there is no registered key, the menu cannot be selected.

2. Delete My Smartphone Key



- 1) **Smartphone Key**
- 2) **My Smartphone Key**
- 3) **Delete**

If the owner's smart phone has been changed, the new smart phone can be registered after only deleting the previous Digital Key 2 Touch (Smart Phone).

With the vehicle on, touch **Setup** → **Vehicle** → **Digital Key** → **Smartphone Key** → **My Smartphone Key** → **Delete** on the infotainment system.

- If the shared key is registered in the vehicle, the shared key is not deleted.
- After deleting 'My Smartphone Key', the new smart phone can be registered.

*** NOTICE**

- If digital key (smart phone) is deleted, the digital key saved in the smart-phone is also deleted.
- If digital key (smart phone) is deleted on the smart phone, the digital key saved in the vehicle is also deleted.
- The function to delete shared user's key is not provided from the infotainment system.
- Digital key (smart phone) is not deleted even if Kia Access app is deleted on the smart phone.
- Digital key can be activated or deactivated within the Kia Access app provided from the smart phone manufacturer.

*** INFORMATION**

The infotainment system may change after software updates. For more information, refer to the user's manual provided in the infotainment system and the quick reference guide.

Digital Key 2 Touch (Card Key) (if equipped)

How to register Digital Key 2 Touch (Card Key)

To use the card key as a digital key, follow the following procedure.

1. Get in the vehicle with two smart keys.
2. Check if 'Enable Card Key' menu is activated.

With the vehicle on, touch **Setup** → **Vehicle** → **Digital Key** → **Card Key** → **Enable Card Key** on the infotainment system.

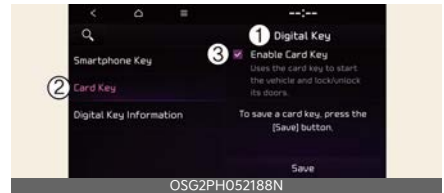

- 1) **Digital Key**
- 2) **Card Key**
- 3) **Enable Card Key**

3. With the vehicle on, place the card key on the in-vehicle authentication pad. The saving process will begin automatically.



[A]: Indicator, [B]: Charging pad

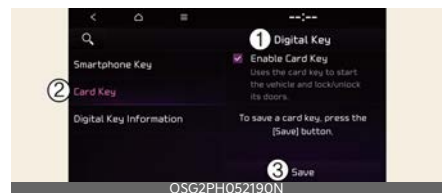

- 1) **Digital Key**
 - 2) **Card Key**
 - 3) **Save**
4. When the digital key (card key) is saved, a message will appear on the infotainment system screen.

*** INFORMATION**

- The infotainment system may change after software updates. For more information, refer to the user's manual provided in the infotainment system and the quick reference guide.
- When there is a digital key (card key) already saved in the vehicle, the **Save** menu is disabled. If you want to save a digital key again, refer to "How to delete Digital Key 2 Touch (Card key)" on page 5-25 and follow the deleting procedure first before saving a digital key.
- To register the digital key (card key), the two smart keys must be in the vehicle.
- The registered digital key (card key) cannot be used for another vehicle.

How to use the Digital Key 2 Touch (Card key)

Card key touch control

The driver can lock and unlock the door by touching the card key on the door handle. Also, the vehicle can be started by placing the card key on the in-vehicle authentication pad (wireless charging pad).



[A]: Door handle authentication pad,
[B]: Card key NFC antenna

Locking/Unlocking the doors

- If the driver touches the card key on the driver's or passenger's door handle authentication pad for more than 2 seconds, the door will lock or unlock.
- If 2 Press Unlock function is set, only the driver's door will be unlocked by touching the card key on the driver's door handle. Touch the card key once more within 4 seconds to unlock all doors.
- After unlocking the doors, the doors will automatically re-lock after 30 seconds unless a door is opened.

*** NOTICE**

When approaching smartphone NFC antenna to the outside door handle authentication pad, the doors will not lock with an audible warning in following conditions:

- The Smart Key is in the vehicle
- The EV button is in ACC or ON position
- Any of the doors are open except for the vehicle hood or liftgate

Starting the vehicle

After placing your registered card key on the in-vehicle authentication pad (wireless charger pad), depress the brake pedal and press the EV button.

- Once the vehicle is started, you can remove the card key from the pad.

For more details, refer to "EV button" on page 6-6.

⚠ WARNING

The vehicle can be started when the registered card key is placed on the in-vehicle authentication pad (wireless charging pad). Therefore, do not leave unsupervised children or people who are not aware of the system since it can result in serious injury or death. In addition, always have the registered card key with you to prevent vehicle theft when leaving the vehicle.

⚠ CAUTION

- The digital key (card key) may not work under the following conditions:
 - The digital key (card key) is not touching the center of the door handle authentication pad or in-vehicle authentication pad (wireless charging pad) correctly.
 - The digital key (card key) is used overlapped with NFC-enabled cards such as credit card or smart phone.
 - If the digital key (card key) does not work, move the card key approximately 4 inches (10 cm) away from the authentication pad and then touch it again.
- The digital key (card key) can be damaged by impacts. If the digital key (card key) is damaged, replace the

digital key (card key) with a new one and register it again.

- Long-time exposure to high temperature may cause the card key to malfunction. Be careful not to expose the key to direct sunlight or high temperature.

How to delete Digital Key 2 Touch (Card key)

1. Turn the vehicle on with the smart key and make sure to keep the smart key inside the vehicle during the digital key (card key) deleting process.
2. With the vehicle on, place the card key on the in-vehicle authentication pad. With the vehicle on, touch **Setup** → **Vehicle** → **Digital Key** → **Card Key**

→ **Delete** on the infotainment system. The **Delete** menu will be disabled if there if no digital key (card key) saved.



- 1) **Digital Key**
 - 2) **Card Key**
 - 3) **Delete**
3. When the digital key (card key) is deleted, a message will appear on the infotainment screen or cluster.

*** INFORMATION**

The infotainment system may change after software updates. For more information, refer to the user's manual pro-

vided in the infotainment system and the quick reference guide.

Personalized Profile and Vehicle Settings (if equipped)

When the registered digital key is linked with user profile, the vehicle will automatically operate (door lock/unlock with digital key, etc.) according to the user profile setting. User profile linking and personalization are available for a total of two drivers.

Linking / Unlinking profile

How to link user profile

1. Select **Setup** → **User Profile** → **Profile Setting** → **Link Digital Key (Smartphone)** on the infotainment system settings menu.
2. If you select **Link**, the registered phone number's digital key and the user profile will link. Select **Link** according to the instruction.
3. When the process is complete, the message 'Digital Key Link Complete.' will appear on the infotainment system screen.

How to unlink user profile

1. Unlink digital key in the User Profile settings. Unlinking is possible only when user profile is linked.
2. When unlinking is complete, the message 'Digital key is unlinked.' will appear on the infotainment system screen.

* INFORMATION

- The infotainment system may change after software updates. For more information, refer to the user's manual

provided in the infotainment system and the quick reference guide.

- Use profile cannot be linked to both Driver 1 and Driver 2 that are connected to a single smart phone. Personalization will operate with the recently linked user profile, and the previously linked user profile will be automatically canceled.
- User profile can be linked when a digital key is registered on the smart phone and the vehicle. The smart phone with another vehicle's digital key cannot be linked.
- If you remove the smart phone from the in-vehicle authentication pad (wireless charging pad) before completing the user profile link, the linking process will not be completed normally.
- Once the user profile linked digital key in the smart phone is deleted, the digital key should be re-registered and personalized by linking the user profile again.
- NFC card key cannot be linked with personalized profile.

Vehicle personalization operation

The personalization function linked with Digital Key 2 Touch works under the following conditions:

- Touch the driver's door handle with the profile linked smart phone to lock or unlock the doors (Personalization does not operate when locking or unlocking the front passenger door.).
- The personalization function using the digital key can be operated after linking the digital key in the infotainment system profile menu.

- The personalization function works only when the vehicle is OFF or when the vehicle is started remotely. If the vehicle is not started remotely, personalization function does not work with the digital key.

*** INFORMATION**

User profile operation according to door lock/unlock system is as follows.

Item	Personalization operation
Initial value	Guest
Profile linked smart phone key	Linked profile
Profile unlinked smart phone key	Recently activated profile
NFC card key	
Smart key	

Vehicle personalization with Digital Key 2 Touch

The available personalization function in the vehicle is as follows.

System	Personalization Item		
User Settings menu	Head Up Display (HUD)	Position adjustment of image, Information display selection	
	Lamp	Blink number of one-touch signal lamps	
	Cluster	Information display on the cluster, Voice volume, We come sound	
	Seat		Seat position
			Smart heating wire ventilation On/Off
	Door	Automatic door lock/unlock, 2 Press Unlock	
	Smart phone wireless charging	Wireless charging On/Off	
Air conditioning	Setting up temperature unit, Block air inflow/ Automatic ventilation Window defroster On/Off		
Infotainment Settings menu	Navigation	Preferred volume of the navigation system	
		Recent destination	
	User preset	My menu list settings, Radio preset	
	Phone connectivity	Bluetooth preferential connection	
CarPlay/Android Auto/MirrorLink On/Off			
Air conditioning	Operating condition	Latest operation setup of the following functions: Temperature (AUTO), air flow direction, air volume, air conditioner, air intake control, SYNC, Front windshield defroster, OFF	

For more information of personalization, refer to the infotainment system manual.

CAUTION

If you leave the digital key in the vehicle after locking or unlocking the doors or starting the vehicle with the smart key, the doors can be locked with the central door lock. Have the digital key with you at all times.

Used Vehicle/Digital Key 2 Touch Maintenance

Purchasing used vehicle

If any of the digital key devices (smart phone key, card key (if equipped)) are registered in the vehicle, the message 'Digital key(s) active' will appear on the instrument cluster once when the vehicle is turned on after unlocking the vehicle door.

When purchasing a used car, be sure to check the message and delete the smart phone key and card key (if equipped) registered by the previous user. Please let us know the purchase of a used vehicle through an authorized Kia dealer. Check whether the card key (if equipped) that came with the used vehicle operates properly. If the digital key (card key) (if equipped) does not work properly, delete the card key (if equipped) and register the smart phone key, and then re-register the card key (if equipped).

Digital Key 2 Touch Maintenance

If you need to have your Digital Key 2 Touch System repaired or replaced, the registered digital key (smart phone)/digital key (card key) (if equipped) can be deleted.

Limitations of the System

- Digital Key 2 Touch may not work if any of the following occurs:
 - Smart phone battery or the vehicle battery is discharged
 - NFC or Bluetooth is turned off in the smart phone settings
 - A credit card is overlapped in the back of your smart phone, or metal or thick smart phone case is used
- Using the card key (if equipped) with other cards, or using it in a wallet or card holder
- There is electronic interference by other vehicles, objects, etc.
- There may be a communication error with Digital Key 2 Touch NFC function if the metallic cover or communication device is attached to the smart phone. If there is a malfunction, remove the cover attached to the smartphone and try again.
- The vehicle may not be controlled by the smart phone if any of the following occurs:
 - Basic and necessary functions of the smart phone are operating (general call, urgent call, audio or NFC payment)
 - Using wireless earphone (general call, urgent call, audio)
 - When Digital Key 2 Touch app function is being limited due to smartphone default settings or app launch priority policy per manufacturer

Driver Position Memory System (if equipped)

The Driver Position Memory System is provided to store and recall the following memory settings with a simple button operation.



- Driver's seat position
- Outside rear view mirror position
- Head Up Display (HUD) display mode, position, AR matching adjustment (if equipped)

⚠ WARNING

Never attempt to operate the driver position memory system while the vehicle is moving.

This could result in loss of control, and an accident causing death, serious injury, or property damage.

*** NOTICE**

- If the battery is disconnected, the memory settings will be erased.
- If the Driver Position Memory System does not operate normally, have the system checked by an authorized Kia dealer.

Storing memory positions

1. Shift to P (Park) while the EV button is in the ON position.
2. Adjust the driver's seat position, outside rearview mirror position, and head-up display height to the desired position.

3. Hold the button (1 or 2). The system will beep once and notify you 'Driver 1 (or 2) settings saved' will appear on the infotainment screen.

Recalling memory positions

1. Shift to P (Park) while the EV button is in the ON position.
2. Press the desired memory button (1 or 2). The system will beep once, and then the driver's seat position, outside rearview mirror position, and head-up display height will automatically adjust to the stored positions.
3. 'Driver 1 (or 2) settings applied' will appear on the infotainment screen.

*** NOTICE**

- In order to adjust the memory button (2) while adjusting the memory button (1), press the memory button (1) to pause the adjustment of (1), then press memory button (2).
- If you adjust the seat, rearview mirror, head-up display while recalling the stored positions, the manually adjusted settings will be applied.

Resetting memory positions

If the Driver position memory system does not work properly, initialize the system as follows.

Resetting integrated memory system

1. Stop the vehicle and open the driver's door with the EV button in the ON position and the vehicle shifted to P (Park).
2. Adjust the driver's seat and seatback to the foremost position.
3. Press the memory button 1 (or 2) and push forward the driver's seat move-

ment switch over 2 seconds simultaneously.

While resetting integrated memory system

1. Resetting starts with a notification sound.
2. The driver's seat and seatback is adjusted to the rearward position with the notification sound.
3. The driver's seat and seatback is re-adjusted to the default position (central position) with the notification sound.

However, in the following cases, the resetting procedure and the notification sound may stop.

- The memory button is pressed.
- The seat control switch is operated.
- The gear is shifted out of P (Park).
- The driving speed exceeds 2 mph (3 km/h).
- The driver's door is closed.

* NOTICE

- While integrated memory system is being reset, if the resetting and notification sound stops incompletely, restart the resetting procedure again.
- Make sure that there is no objects around the driver's seat in advance of resetting the integrated memory system.
- After resetting the integrated memory system, the adjustment for the driver seat must be stored again to recall the memory position.

Seat easy access (if equipped)

The system will move the driver's seat automatically as follows:

Exiting the vehicle

The driver's seat will move as follows when the EV button is in the OFF position with the gear in P (Park) and the driver's door open.

- Driver seat: Moves rearward depending on the distance selected from the Settings menu in the infotainment system.

However, the driver's seat may not move rearward if there is not enough space between the driver's seat and the rear seats.

Entering the vehicle

The driver's seat will move as follows when the EV button is pressed to the ACC, ON or START position or while carrying the smart key, the driver's door is closed with the EV button in the OFF position.

- Driver seat: Moves back to its original position.

You can set the Seat Easy Access function from the Settings menu in the infotainment system screen. Select:

- Driver seat

Setup → Vehicle → Seat → Seat Easy Access → Driver Seat Easy Access → Normal/Extended/Off

* INFORMATION

The infotainment system may change after software updates. For more information, refer to the user's manual provided in the infotainment system and the quick reference guide.

Liftgate

⚠ WARNING

Rear cargo area

Occupants should never ride in the rear cargo area where no restraints are available. To avoid injury in the event of an accident or sudden stops, occupants should always be properly restrained.

Opening the liftgate

The liftgate is locked or unlocked when all doors are locked or unlocked with the key, smart key or central door lock/unlock switch.

⚠ CAUTION

Liftgate lift

Make sure that you close the liftgate before driving your vehicle. Possible damage may occur to the liftgate gas lifters and attached hardware if the liftgate is not closed prior to driving.

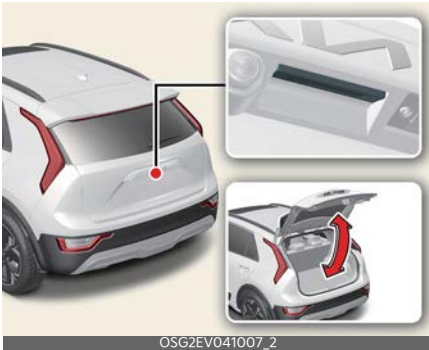

- The liftgate is locked or unlocked when all doors are locked or unlocked with the transmitter (or smart key) or central door lock switch.
- If unlocked, the liftgate can be opened by pressing the handle and pulling it up.

- Once the liftgate is opened and then closed, the liftgate locks automatically. (All doors must be locked.)

*** NOTICE**

In cold and wet climates, door lock and door mechanisms may not work properly due to freezing conditions.

⚠ WARNING

The liftgate swings upward. Make sure no objects or people are near the rear of the vehicle when opening the liftgate.

Closing the liftgate



- To close the liftgate, lower and push down the liftgate firmly. Make sure that the liftgate is securely latched.

⚠ WARNING

Make sure your hands, feet and other parts of your body are safely out of the way before closing the liftgate.

⚠ CAUTION

Make sure nothing is near the liftgate latch and striker while closing the liftgate. It may damage the liftgate's latch.

Emergency liftgate safety release

Your vehicle is equipped with the emergency liftgate safety release lever located on the bottom of the liftgate. When someone is inadvertently locked in the luggage compartment.



OSG2EV041013

The liftgate can be opened by doing as follows:

1. Input the mechanical key into the hole.
2. Push the mechanical key to the right (1).
3. Push up the liftgate.

⚠ WARNING

- You and your passengers must be aware of the location of the Emergency Liftgate Safety Release lever in this vehicle and how to open the liftgate in case you are accidentally locked in the liftgate.
- NEVER allow anyone to occupy the liftgate of the vehicle at any time. If the liftgate is partially or totally latched and the person is unable to get out, serious injury or death could occur due to lack of ventilation, or because of exposure to cold weather conditions. The liftgate is also a highly dangerous location in the event of a crash because it is not a protected occupant space but is a part of the vehicle's crush zone.
- Your vehicle should be kept locked and the Smart Key should be kept out of the reach of children. Parents should teach their children about the dangers of playing in liftgates.
- Use the release lever for emergencies only.

⚠ WARNING

- No one should be allowed to occupy the cargo area of the vehicle at any time. The cargo area is a very dangerous location in the event of a crash.
- Use the release lever for emergencies only. Use with extreme caution, especially while the vehicle is in motion.

⚠ CAUTION

Make sure there are no people or objects around the liftgate before opening or closing the liftgate. Wait until the liftgate is open fully and stopped before loading or unloading cargo from the vehicle.

⚠ WARNING

Do not grasp the part supporting the liftgate (gas lifter), as this may cause serious injury.



OSG2EV041011

Power liftgate (if equipped)

Power liftgate operating conditions

The power liftgate operates when the gear is in P (Park) with the EV button in the ON position. However, the power liftgate will operate regardless of the gear position when the vehicle is off. Also, the liftgate can be opened only when vehicle speed is below 1.8 mph (3 km/h).

For safety, before attempting to open or close the liftgate, make sure the vehicle is in P (Park).

⚠ WARNING

- Never leave children or animals unattended in your vehicle. Children may operate the power liftgate. Doing so can result in injury to themselves or others and can damage the vehicle.
- Make sure that there are no people or objects in the path of the power liftgate or smart liftgate prior to use. Serious injury, damage to the vehicle or damage to surrounding objects (for example, walls, ceilings, vehicles, etc.) may result if contact with the liftgate occurs.



*** NOTICE**

- Do not close or open the liftgate manually. This may cause damage to the power liftgate. If it is necessary to

close or open the liftgate manually when the battery is discharged or disconnected, do not apply excessive force.

- Do not operate the power liftgate more than 10 times continuously when the vehicle is not running. Use the power liftgate with the vehicle running when the power liftgate is used repeatedly to prevent battery discharge.
- Do not leave the power liftgate open for a long period of time. This may drain the battery.
- Do not apply excessive force when the power liftgate is operating. Doing so could result in vehicle damage.
- Do not grab or hold on to the liftgate support struts at any time. Damage to the liftgate support struts could result. Deformation of the liftgate support struts may cause vehicle damage and personal injury may occur.



- Do not modify or repair any part of the power liftgate by yourself. This must be done by an authorized Kia dealer.
- Do not operate the power liftgate under the following conditions. The power liftgate may not operate properly.
 - One side of the vehicle is lifted to inspect the vehicle or change a tire
 - Parking on an uneven road such as a slope, etc.

- Close the liftgate completely and lock all doors and liftgate using the central door lock button before using an automatic car wash.
- Do not spray high pressure water directly on the power liftgate outside open/close button. The liftgate may open unintentionally.

* INFORMATION

- If the liftgate is not fully closed and vehicle speed is at or above 3 km/h (1.8 mph), a warning will sound 10 times. Immediately park the vehicle at a safe place, close the liftgate, and check that the liftgate open warning on the instrument cluster is turned off.
- In cold and wet climates, the outside power liftgate open/close button may not work properly due to freezing conditions. If this occurs, remove the ice before using the outside power liftgate open/close button or use the power liftgate open/close button on the smart key or the instrument panel.
- Operating the power liftgate more than 5 times continuously could cause damage to the operating motor. If this occurs, the power liftgate will not operate to prevent the motor from overheating. If any of the power liftgate buttons are pressed to try to open the liftgate, the chime will sound 3 times, but the liftgate will remain closed. Allow the power liftgate system to cool for about 1 minute before operating the system again.

Operating the power liftgate

Power liftgate open/close button (Smart key, Instrument panel)



When the liftgate is closed, press the power liftgate open/close button for 1 second. The power liftgate opens with a warning sound.

While the liftgate is opening, press the button to stop liftgate operation.

When the power liftgate is opened, press and hold the power liftgate open/close button to close the liftgate. If you release the button while the liftgate is closing, power liftgate operation will stop with a warning sound for 5 seconds.

Also, if the smart key is not within operation range (approximately 10 m) from the vehicle, power liftgate operation will stop with a warning sound for 5 seconds.

Power liftgate open/close button (Outside the power liftgate)



When the liftgate is closed, press the power liftgate open/close button to open the liftgate.

If the vehicle is locked, press the power liftgate open/close button with the smart key in your possession.

If the liftgate is unlocked, the liftgate will open or close with a warning sound when the power liftgate open/close button is pressed without carrying the smart key.

Power liftgate open/close button (Inside the power liftgate)



Press the power liftgate open/close button. The liftgate opens or closes with a warning sound.

Automatic reverse

During power liftgate operation if the power liftgate senses any obstacle, the liftgate will stop or will fully open. The automatic reverse feature may not oper-

ate properly, or it may operate unexpectedly under the following circumstances:

- The automatic reverse feature may not detect the resistance if the detected resistance is below a certain level, or if the liftgate is almost fully closed near the latched position.
- The automatic reverse feature may operate if a strong impact is applied with no obstructions placed.

⚠ WARNING

Never intentionally place any object or part of your body in the path of the power liftgate to make sure the automatic reverse feature operates. Serious injury, or damage to the vehicle or object may occur.

* INFORMATION

The power liftgate may stop operating if the automatic reverse feature operates more than two times while attempting to open or close the liftgate. If this occurs, carefully open or close the liftgate manually, and then after 30 seconds try to operate the power liftgate automatically again.

Setting the power liftgate

To use each feature, you must select the opening speed or opening height from the settings menu. Deselect the settings when you do not want to use the feature.

Power liftgate opening speed

To adjust the power liftgate speed, select 'User Settings → Door/liftgate → Power liftgate Opening Speed → Fast/Slow' in the instrument cluster or 'Setup → Vehicle Settings → Door/liftgate →

Power liftgate Opening Speed → Fast/ Slow' in the infotainment system. (Default setting is 'Fast')

*** INFORMATION**

The infotainment system may change after software updates. For more information, refer to the user's manual provided in the infotainment system and the quick reference guide.

Power liftgate opening height

To adjust the power liftgate opening height, select 'User Settings → Door/liftgate → Power liftgate Opening Height → Full Open/Level 3/Level 2/Level 1/User Height Setting' in the instrument cluster or 'Setup → Vehicle Settings → Door/liftgate → Power liftgate Opening Height → Full Open/Level 3/Level 2/Level 1/User Height Setting' in the infotainment system.

See additional information in supplied Infotainment Manual.

User height setting

1. Position the liftgate manually to the height you prefer.
2. Press the power liftgate open/close button located inside the liftgate for more than 3 seconds.

If 'User Height Setting' is selected for the power liftgate opening height, the power liftgate will automatically open to the height manually set by you.

*** INFORMATION**

- The infotainment system may change after software updates. For more information, refer to the user's manual provided in the infotainment system and the quick reference guide.
- If the power liftgate opening height has not been manually set, the power

liftgate will fully open when 'User Height Setting' from the infotainment system is selected.

- If one of the height setting (Full Open/Level 3/Level 2/Level 1) is selected from the settings menu in the infotainment system, and then 'User Height Setting' is selected, the liftgate will open to the height manually set by you.
- The power liftgate opening speed and opening height settings change according to the linked User Profile. If the User Profile is changed, power liftgate opening speed and opening height settings will change accordingly.

Resetting the power liftgate

In some circumstances resetting the power liftgate operation may need to be performed. Some instances where resetting the power liftgate may be required include:

- When the 12-volt battery is recharged
- When the 12-volt battery is reinstalled after removal or replacement
- When the related fuse is reinstalled after removal or replacement



1. With the vehicle off or running, put the gear in P (Park).

2. Press the power liftgate open/close inner button (A) and outer button (B) simultaneously until a chime sounds.
3. Slowly close the liftgate manually.
4. Press the power liftgate open/close outer button. The power liftgate will open with a chime sound.

Wait until the liftgate fully opens to complete resetting. If the liftgate stops before it is fully open, resetting cannot be completed.

* INFORMATION

If the power liftgate does not operate properly after the above procedure, have the system inspected by an authorized Kia dealer.

- No one, including animals, should be allowed to occupy the luggage compartment of the vehicle at any time. The luggage compartment is a very dangerous location in the event of an accident.
- Use the release latch for emergencies only. Use extreme caution, especially while the vehicle is in motion.

Emergency liftgate safety release



To unlock and open the liftgate manually from inside the luggage compartment, perform the following procedure:

1. Insert a long, flat object, such as a key into the opening at the bottom of the liftgate.
2. Slide the latch in the direction of the arrow to unlock the liftgate.
3. Push the liftgate to open.

⚠ WARNING

- For emergencies, be fully aware of the location of the emergency liftgate safety release latch in the vehicle and how to open the liftgate if you are accidentally locked in the luggage compartment.

Smart Liftgate with Auto Open (if equipped)

On a vehicle equipped with a smart key, the liftgate can be opened using the Smart Liftgate with Auto Open system.



How to use the Smart Liftgate with Auto Open

The liftgate can be opened with no-touch activation satisfying all the conditions below.

- After 15 seconds when all doors are closed and locked
- Positioned in the detecting area for more than 3 seconds.

* NOTICE

The Smart Liftgate with Auto Open does not operate when:

- The smart key is detected within 15 seconds after the doors are closed and locked, and is continuously detected.
- The smart key is detected within 15 seconds after the doors are closed and locked, and 60 inches (1.5 m) from the front door handles.
- A door is not locked or closed.
- The smart key is in the vehicle.

1. Setting

To activate the Smart Liftgate with Auto Open, go to 'Vehicle → Door → Smart Liftgate' on the LCD display.

2. Detect and Alert



If you are positioned in the detecting area (20 ~ 40 inches [50 ~ 100 cm] behind the vehicle) carrying a smart key, the hazard warning lights will blink and chime will sound to alert you the smart key has been detected and the liftgate will open.

* NOTICE

Do not approach the detecting area if you do not want the liftgate to open. If you have unintentionally entered the detecting area and the hazard warning lights and chime starts to operate, leave the detecting area with the smart key. The liftgate will stay closed.

3. Automatic opening



The hazard warning lights will blink and chime 6 times and then the liftgate will open.

⚠ WARNING

- Make sure you close the liftgate before driving your vehicle.
- Make sure there are no people or objects around the liftgate before opening or closing the liftgate.
- Make sure objects in the liftgate do not come out when opening the lift-

gate on a slope. It may cause serious injury.

- Make sure to deactivate the Smart Liftgate with Auto Open when washing your vehicle. Otherwise, the liftgate may open inadvertently.
- The key should be kept out of reach of children. Children may inadvertently open the Smart Liftgate with Auto Open while playing around the rear area of the vehicle.

⚠ CAUTION

Liftgate lift

Make certain that you close the liftgate before driving your vehicle. Possible damage may occur to the liftgate gas lifters and attached hardware if the liftgate is not closed prior to driving.

How to deactivate the Smart Liftgate with Auto Open function using the smart key



ONQ5031066

- 1 Door lock
- 2 Door unlock
- 3 Liftgate open
- 4 Panic button
- 5 Remote start

If you press any button of the smart key during the Detect and Alert stage, the Smart Liftgate with Auto Open function will be deactivated.

Make sure to be aware of how to deactivate the Smart Liftgate with Auto Open function for emergency situations.

*** NOTICE**

- If you press the door unlock button (2), the Smart Liftgate with Auto Open function will be deactivated temporarily. But, if you do not open any door for 30 seconds, the Smart Liftgate with Auto Open function will be activated again.
- If you press the liftgate open button (3) for more than 1 second, the liftgate opens.
- If you press the door lock button (1) or liftgate open button (3) when the Smart Liftgate with Auto Open function is not in the Detect and Alert stage, the Smart Liftgate with Auto Open function will not be deactivated.
- In case you have deactivated the Smart Liftgate with Auto Open function by pressing the smart key button and opened a door, the Smart Liftgate with Auto Open function can be activated again by closing and locking all doors.

Detecting area



OSG2EV042032N

- The Smart Liftgate with Auto Open operates with a welcome alert if the smart key is detected within 20 ~ 40 inches (50 ~ 100 cm) from the liftgate.
- The alert stops at once if the smart key is positioned outside the detecting area during the Detect and Alert stage.

*** NOTICE**

- The Smart Liftgate with Auto Open function will not work if any of the following occurs:
 - The smart key is close to a radio transmitter such as a radio station or an airport which can interfere with normal operation of the transmitter.
 - The smart key is near a mobile two way radio system or a cellular phone.
 - Another vehicle's smart key is being operated close to your vehicle.
 - The detecting range may decrease or increase when:
 - One side of the tire is raised to replace a tire or to inspect the vehicle.
 - The vehicle is slantingly parked on a slope or unpaved road, etc.
-

Windows

The doors of this vehicle are equipped with power windows that can be operated by a switch.

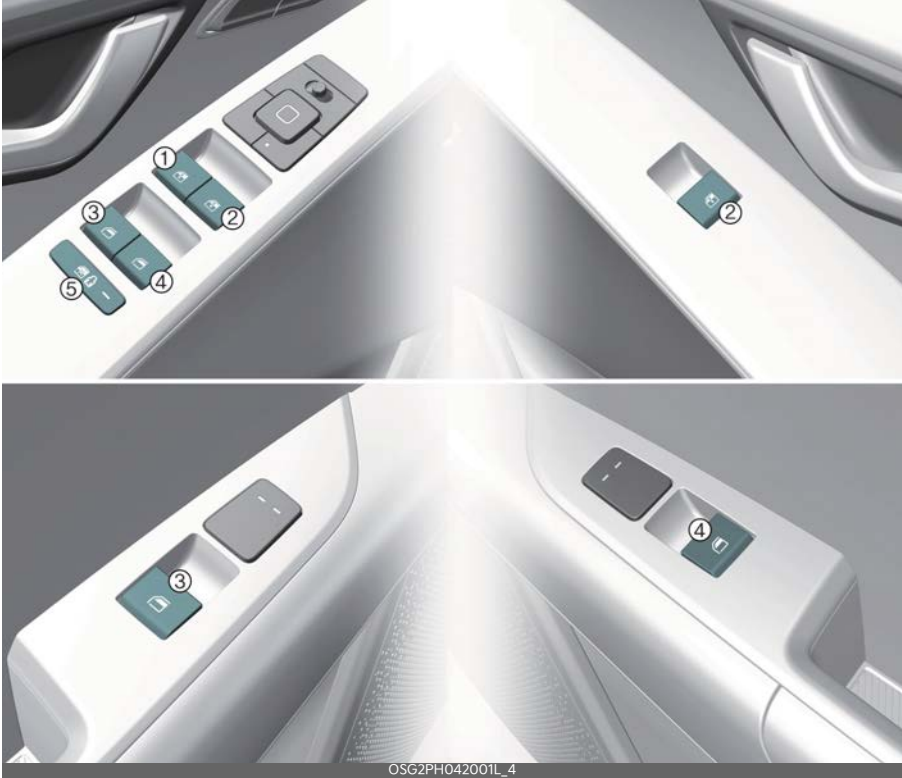

- 1 Driver's door power window switch
- 2 Front passenger's door power window switch
- 3 Rear door (left) power window switch
- 4 Rear door (right) power window switch
- 5 Power window lock switch

*** NOTICE**

In cold and wet climates, power windows may not work properly due to freezing conditions.

The ignition switch or EV button must be in the ON position for power windows to operate.

Each door has a power window switch that controls the door's window. The driver has a power window lock button which can block the operation of rear passenger windows. The power windows can be operated for approximately 3 minutes after ignition switch or EV button turned to the ACC or LOCK position. However, if the front doors are opened, the power windows cannot be operated even within the 3 minutes period.

The driver's door has a master power window switch that controls all the windows in the vehicle.

If the window cannot be closed because it is blocked by objects, remove the objects and close the window.

*** NOTICE**

While driving with the rear windows down or with the sunroof (if equipped) in an open (or partially open position), your vehicle may demonstrate a wind buffeting or pulsation noise. This noise is a normal occurrence and can be reduced or eliminated by taking the following actions. If the noise occurs with one or both of the rear windows down, partially lower both front windows approximately 1 inches (2.5 cm). If you experience the noise with the sunroof open, slightly reduce the size of the sunroof opening.

⚠ CAUTION

Do not install any accessories in the vehicle that extend into the open window area. Such objects will impact the proper function of the Automatic reversal "jam protection" feature.

*** NOTICE**

If you press the one-touch window button for micro adjustment, the glass will go down to a specific location to improve your convenience.

Window opening and closing

You can open and close windows using the power window switch.

Type A



To open or close a window, press down or pull up the front portion of the corresponding switch to the first detent position (1).

Type B - Auto up/down window (if equipped)



Pressing or pulling up the power window switch momentarily to the second detent

position (2) completely lowers or raises the window even when the switch is released. To stop the window at the desired position while the window is in operation, pull up or press down and release the switch.

To reset the power windows

If the power window does not operate normally, the automatic power window system must be reset as follows:

1. Turn the ignition switch or EV button to the ON position.
2. Close the window and continue pulling up the power window switch for at least 1 second after the window is completely closed.

Automatic reversal (if equipped)



If the upward movement of the window is blocked by an object or part of the body, the window will detect the resistance and will stop upward movement. The window will then lower approximately 11.8 inches (30 cm) to allow the object to be cleared.

If the window detects the resistance while the power window switch is pulled up continuously, the window will stop

upward movement then lower approximately 1 inch (2.5 cm).

And if the power window switch is pulled up continuously again within 5 seconds after the window is lowered by the automatic window reversal feature, the automatic window reversal will not operate.

* NOTICE

The automatic reverse feature for the window is only active when the "auto up" feature is used by fully pulling up the switch. The automatic reverse feature will not operate if the window is raised using the halfway position on the power window switch.

⚠ WARNING

Always check for obstructions before raising any window to avoid injuries or vehicle damage. If an object less than 0.16 of an inch (4 mm) in diameter is caught between the window glass and the upper window channel, the automatic reverse window may not detect the resistance and will not stop and reverse direction.

⚠ WARNING

The automatic reverse feature doesn't activate while resetting the power window system. Make sure body parts or other objects are safely out of the way before closing the windows to avoid injuries.

⚠ CAUTION

Do not install any accessories in the vehicle that extend into the open window area. Such objects could prevent

the automatic reverse feature from functioning.

Power window lock button

The driver can disable the power window switches on the rear passengers' doors by pressing the power window lock button to the lock position (pressed).



When the power window lock button is pressed:

- The driver's master control can operate all passengers' power windows.
- The front passenger's control can operate the front passenger's power window.
- The rear passengers' control cannot operate the rear passenger's power window.

CAUTION

- To prevent possible damage to the power window system, do not open or close two windows or more at the same time. This will also ensure the longevity of the fuse.
- Never try to operate the main switch on the driver's door and the individual door window switch in opposite directions at the same time. If this is done, the window will stop and cannot be opened or closed.

WARNING

Windows

- NEVER leave the keys in your vehicle with unsupervised children, when the vehicle is running.
- NEVER leave any child unattended in the vehicle. Even very young children may inadvertently cause the vehicle to move, entangle themselves in the windows, or otherwise injure themselves or others.
- Always double check to make sure all arms, hands, head and other obstructions are safely out of the way before closing a window.
- Do not allow children play with the power windows. Keep the driver's door power window lock button in the LOCK position (pressed). SERIOUS INJURY can result from unintentional window operation by the child.
- Do not extend heads or any limbs outside the window while the vehicle is in motion.

Remote window opening (if equipped)



If Auto window down function (safety window function) is equipped, you can still control the corresponding windows movement with vehicle turned off.

Press the Door Unlock button (1) for more than 3 seconds. The window moves down after the doors are

unlocked, as long as you press the door unlock button (1). The window movement stops, when you release the door unlock button (1).

* Remote window opening requires the automatic power window up/down function equipped for front seat.

⚠ WARNING

If you stay on the function after operating the Remote window opening function, it is likely to cause a theft. In addition, please use caution there might be a malfunction due to the inflow of water while raining.

⚠ CAUTION

- The remote window opening function may abruptly stop, when you move away from your vehicle during operation. Stay in close proximity from your vehicle, while monitoring the window movement.
- One of the windows may stop operating, when the window is interrupted by certain force. However, the other windows will keep operating. Thus, you should make sure that all windows are opened.
- Be careful when using the remote window opening function, as the doors will be unlocked.

Hood

The hood serves as a cover for the motor room and access to the front trunk.

Open the hood if maintenance work needs to be performed in the motor compartment or if you need to look at the compartment.

Opening the hood

1. Pull the release lever(1) to unlatch the hood. The hood should pop open slightly. Go to the front of the vehicle, raise the hood slightly, push the secondary latch (2) to the left.



2. Lift the hood upwards.



Hood open warning

The hood warning message will appear on the LCD display when hood is open.

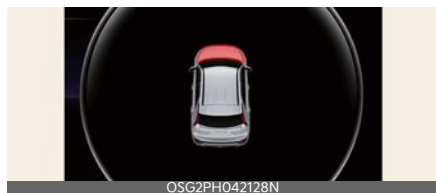

The warning chime will operate when the vehicle is being driven at or above 2 mph (3 km/h) with the hood open.

Closing the hood



1. Before closing the hood, check the following:
 - All filler caps in the motor compartment must be correctly installed.
 - Gloves, rags or any other combustible material must be removed from the motor compartment.
2. Lower the hood until it is about 30 cm above the closed position and let it drop. Make sure that it locks into place.
3. Check that the hood has engaged properly.
 - If the hood can be raised slightly, it is not properly engaged.
 - Open it again and close it with a little more force.

CAUTION

Hood obstruction

Before closing the hood, ensure that all obstructions are removed from the hood opening. Closing the hood with an obstruction present in the hood opening may result in severe personal injury or property damage.

WARNING

Fire risk

Do not leave gloves, rags or any other combustible material in the motor compartment. Doing so may cause a heat-induced fire.

WARNING

Unsecured hood

Always double check to be sure that the hood is firmly latched before driving away. If it is not latched, the hood could fly open while the vehicle is being driven, causing a total loss of visibility, which may result in an accident.

Front trunk

Opening the front trunk



1 Front trunk lever

1. Open the hood.
2. Lift up the front trunk cover while depressing the front trunk lever (1).

Closing the front trunk

Push down the front trunk cover.

* INFORMATION

Available Front Trunk Weight

- 25 lbs. (10 kg)

Available front trunk weight depends on the specifications.

⚠ WARNING

- NEVER make an attempt to get inside the front trunk. It will cause a fatal injury.
- Before closing the hood, ensure all obstructions are removed from around the hood opening. The hood will rise up or move down automatically if the height is not firmly adjusted. Be aware of the damage caused by the unintended hood movements.
- Never store cigarette lighters, propane cylinders, or other flammable/explosive materials in the vehicle. These items may catch fire and/or explode if the vehicle is exposed to

hot temperatures for extended periods.

⚠ CAUTION

- Do not exceed the luggage volume capacity of the front trunk. The overweighted front trunk can be severely damaged.
- Do not store the fragile objects in the front trunk.
- Always keep the front trunk cover closed securely while driving. Items inside your vehicle are moving as fast as the vehicle. If you have to stop or turn quickly, or if there is a crash, the items can be damaged.
- Do not spray water in the front trunk. Vehicle driving system may get damaged since the front trunk is located at the center of motor compartment.
- Be careful when you store any liquid in the front trunk. If liquid leak outside the front trunk, it will cause a damage to the electric devices in the motor compartment.
- Do not press the front trunk cover or place the objects on the front trunk cover. It may be deformed or damaged.
- When closing the front trunk cover, be careful not to touch objects inside the trunk. Loaded objects or the front trunk may be deformed or damaged and the front trunk cover may be opened during driving due to poor closing, resulting in damage.

* NOTICE

- To avoid possible theft, do not leave valuables in the storage compartments.

- Do not put objects that exceeds available front trunk weight to the front trunk, or it may cause damage to the motor room compartment.

Charging door

Opening and closing the charging door



- Press the right center edge of the charging door.
- The charging door is not open when the vehicle is locked.
- Close the charging door by pressing rear center edge of the charging door.

⚠ WARNING

Do not leave the vehicle with the charging door open. An open charging door may indicate that the vehicle door has been unlocked and may be subject to vehicle theft.

⚠ CAUTION

- The charging door opens to the right. Check the surrounding while the charging door is open or close. Be aware of your head or limbs from being hit or stuck to the charging door.
- Do not hold the hinge to prevent damaging the charging door and causing other accidents.

* NOTICE

- If the charging door does not open because ice has formed around it, tap lightly or push on the door to break the ice and release the door. If necessary, use hand temperature to melt down the ice or move the vehicle to a warm place and allow the ice to melt. Do not pry on the charging door or use unauthorized tools to open the charging door.
- After closing the charging door, push the door again to ensure that the charging door is completely closed.
- Make sure that the charging door is closed before driving the vehicle. If the charging door is opened, mechanical parts of the charging door can be damaged.
- After closed the charging door, be sure to check the warning light is off.
- After charging the vehicle, close the charging inlet by the charging inlet cover properly. If the charging inlet cover is closed improperly, the charging inlet and the charging door can be damaged.
- Do not pry on the charging door while the charging door is opening. The charging door may stop moving. Also, the electrical mechanism of the charging door and its related parts can be severely damaged.
- While washing the vehicle, do not spray a high pressure water to the charging door directly. The high pressure can damage the charging door.

Sunroof (if equipped)

If your vehicle is equipped with a sunroof, you can slide or tilt your sunroof with the sunroof switch located on the overhead console.



The sunroof can only be operated when the ignition switch or the EV button is in the ON or START position.

The sunroof can be operated for approximately 3 minutes after the ignition switch or EV button is in the ACC or LOCK/OFF position.

However, if the front door is open, the sunroof cannot be operated even within the 3 minutes period.

⚠ WARNING

- Adjust the sunroof or sunshade when your vehicle stops. This could result in loss of control and an accident that may cause injury, or property damage.
- Do not leave the vehicle running and the key in your vehicle with unsupervised children. Unattended children could operate the sunroof, which could result in serious injury.
- Do not sit on the top of the vehicle. It may cause injury or vehicle damage.

* NOTICE

Do not operate the sunroof when roof bars are installed on the vehicle or when there is luggage on the roof.

Sunshade



Use the sunshade to block direct sunlight coming through the sunroof glass. Open or close the sunshade by hand.

* INFORMATION

The sunshade opens automatically when the sunroof glass is opened, but the sunshade does not close automatically when the sunroof glass is closed. Also, only the sunshade cannot be closed when the sunroof glass is opened.

* NOTICE

Do not pull the sunshade up or down, or apply excessive force as such action may damage the sunshade or cause it to malfunction.

Tilt open/close



- 1 Tilt open
- 2 Tilt close

- Push the sunroof switch upward, the sunroof glass tilts open.

- Push the sunroof switch forward when the sunroof glass is tilt opened, the sunroof glass closes.

The sunroof glass tilts open or closes while the switch is pushed.

* INFORMATION

The sunroof glass cannot slide open and tilt open at the same time. You cannot tilt the sunroof glass open while the sunroof glass is slide open. Also, you cannot slide the sunroof glass open while the sunroof is tilt open. Slide open or tilt open the sunroof glass when the sunroof glass is completely closed.

Slide open/close



- Push the sunroof switch rearward, the sunshade and sunroof glass slide open. Push the sunroof switch forward, only the sunroof glass closes.
- Push the sunroof switch forward or rearward to the first detent position, the sunroof glass moves until the switch is released.
- Push the sunroof switch forward or rearward to the second detent position, the sunroof glass operates automatically (auto slide feature). To stop the sunroof movement at any point, push the sunroof switch in any direction.
- The sunroof glass stops halfway (first detent position) before it is fully opened. To fully open the sunroof

glass, push the sunroof switch rearward once more. At this time, the sunroof glass opens only while the switch is pushed.

*** INFORMATION**

To reduce wind noise while driving, we recommend that you drive at the recommended position (first detent position) before the maximum slide open position.

Automatic reversal



If the sunroof glass senses any obstacle while it is closing automatically, it will reverse direction then stop at a certain position.

The auto reverse function may not work if an object thin or soft is caught between the sliding sunroof glass and sunroof sash.

⚠ WARNING

- Make sure heads, hands, arms or any other body parts or objects are out of the way before operating the sunroof. Body parts or objects may get caught causing injuries or vehicle damage.
- Never deliberately use your body parts to test the automatic reversal function. The sunroof glass may reverse direction, but there is a risk of injury.

*** NOTICE**

- Do not continue to push the sunroof switch after the sunroof is fully

opened, closed, or tilted. Damage to the sunroof motor could occur.

- Continuous operations such as slide open/close, tilt open/close, etc. may cause the motor or sunroof system to malfunction.
- Regularly remove any accumulated dust on the sunroof rail.
- Dust accumulated between the sunroof and roof panel can make noise. Open the sunroof and remove dust regularly using a clean cloth.
- Do not try to open the sunroof when the temperature is below freezing or when the sunroof is covered with snow or ice. The sunroof may not work properly and may break if opened by force.
- Do not open or drive with the sunroof glass open immediately after rain or washing the vehicle. Water may wet the interior of the vehicle.
- Do not extend any luggage outside the sunroof while driving. Vehicle damage may occur if the vehicle suddenly stops.

⚠ WARNING

Do not extend your head, arms, body parts or objects outside the sunroof while driving. Injuries may occur if the vehicle suddenly stops.

Resetting the sunroof



In some circumstances resetting the sunroof operation may need to be performed. Some instances where resetting the sunroof may be required include:

- When the 12-volt battery is either disconnected or discharged
- When the sunroof fuse is replaced
- If the sunroof one-touch AUTO OPEN/CLOSE operation is not functioning properly

Sunroof resetting procedure:

1. It is recommended to perform the reset procedure with the vehicle in the ready mode. Start the vehicle in P (Park).
2. Make sure the sunroof glass is in the fully closed position. If the sunroof glass is open, push the switch forward until the sunroof glass is fully closed.
3. Release the switch when the sunroof glass is fully closed.
4. Push the switch forward until the sunroof glass moves slightly. Then release the switch.
5. Once again push and hold the sunroof switch forward until the sunroof glass slides open and close. Do not release the switch until the operation is completed.

If you release the switch during operation, start the procedure again from step 2.

* INFORMATION

If the sunroof does not reset when the vehicle battery is disconnected or discharged, or the sunroof fuse is blown, the sunroof may not operate normally.

Sunroof open warning



If the driver turns off the vehicle when the sunroof is not fully closed, the warning chime will sound for several seconds and the sunroof open warning will appear on the cluster LCD display.

Close the sunroof securely when leaving your vehicle.

⚠ CAUTION

Make sure the sunroof is closed fully when leaving your vehicle. If the sunroof is left open, rain or snow may wet the interior of the vehicle.

Also, leaving the sunroof open when the vehicle is unattended may invite theft.

Steering wheel

The steering wheel of this vehicle is equipped with Electric Power Steering.

Electric Power Steering (EPS)

Power steering uses an electric motor to assist you in steering the vehicle.

If the vehicle is off or if the power steering system becomes inoperative, the vehicle may still be steered, but it will require increased steering effort.

Electric Power Steering is controlled by the power steering control unit which senses the steering wheel torque and vehicle speed to command the motor.

The steering effort becomes heavier as the vehicle's speed increases and becomes lighter as the vehicle's speed decreases for better control of the steering wheel.

Should you notice any change in the effort required to steer during normal vehicle operation, have the power steering checked by an authorized Kia dealer.

* NOTICE

The following symptoms may occur during normal vehicle operation:

- The EPS warning light does not appear.
- The steering gets heavy immediately after turning the EV button in ON position. This happens as the system performs the EPS system diagnostics. When the diagnostics are completed, the steering wheel will return to its normal condition.
- A click noise may be heard from the EPS relay after turning the EV button in ON or OFF position.
- A motor noise may be heard when the vehicle is at a stop or at a low driving speed.

- When the charging system warning light comes on due to the low voltage (when the alternator or battery does not operate normally or malfunctions), the steering wheel may require increased steering effort.
- If the vehicle needs to be jump started due to battery discharge, the steering wheel may not function normally. This is a temporary situation caused by low battery voltage. It will be solved once the battery is charged. Check for normal steering function by turning the steering wheel slowly before driving the vehicle.
- The steering effort can suddenly increase, if the operation of the EPS system is stopped to prevent serious accidents when EPS control unit detects malfunction of the EPS system by self-diagnosis.
- When the abnormality is detected in the electric power steering system, a deadly accident prevention purposes, steering assist functions will be stopped. At this time, the instrument panel warning light turns on or blinks and the power to manipulate the steering will be off.

Please check immediately after moving the vehicle to a safe zone.

If the Electric Power Steering system does not operate normally, the warning light will appear on the instrument cluster. The steering wheel may become difficult to control or operate abnormally. In this case, have the system inspected by an authorized Kia dealer.

When you operate the steering wheel in low temperature, the steering effort may be high and abnormal noise could occur. If temperature rises, the noise will disappear. This is a normal condition.

When the vehicle is stationary, and the steering wheel is turned all the way to the left or right continuously, the steering wheel becomes harder to turn. The power assist is limited to protect the motor from overheating.

As time passes, the steering wheel will return to its normal condition.

Tilt and telescopic steering wheel

A tilt and telescopic steering wheel allows you to adjust the steering wheel before you drive.

You can also raise it to give your legs more room when you exit and enter the vehicle.

The steering wheel should be positioned so that it is comfortable for you to drive, while permitting you to see the instrument panel warning lights and gauges.

⚠ WARNING

Steering Wheel Adjustment

Never adjust the angle and height of the steering wheel while driving. You may lose steering control.

Adjusting steering wheel angle and height



1. To change the steering wheel angle, pull down the lock release lever (1).

2. Adjust the steering wheel to the desired angle (2) and height (3).
3. Pull up the lock-release lever (4) to lock the steering wheel in place.
4. Be sure to adjust the steering wheel to the desired position before driving.

*** NOTICE**

After adjustment, sometimes the lock-release lever may not lock the steering wheel.

It is not a malfunction. This occurs when two gears engage. In this case, adjust the steering wheel again and then lock the steering wheel.

⚠ WARNING

- After adjusting, push the steering wheel both up and down to be certain it is locked in position.
- While adjusting the steering wheel angle and height, please do not push or pull it hard since the fixture can be damaged.
- Do not press or pull the steering wheel hard while adjusting. The steering wheel column may be damaged.

Heated steering wheel (if equipped)

With the EV button in the ON position, pressing the heated steering wheel button warms the steering wheel. The indicator on the button will appear.



To turn the heated steering wheel off, press the button once again. The indicator on the button will turn off.

⚠ WARNING

If the steering wheel becomes too warm, turn the system off. The heated steering wheel may cause burns even at low temperatures, especially if used for long periods of time.

⚠ CAUTION

- Do not install any type of grip cover for the steering wheel, it may impair the function of the heated steering wheel system.
- When cleaning the heated steering wheel, do not use an organic solvent, such as paint thinner, benzene, alcohol and gasoline. Doing so may damage the surface of the steering wheel.
- If the surface of the steering wheel is damaged by a sharp object, damage to the heated steering wheel components could occur.

* NOTICE

The heated steering wheel will turn off automatically approximately 30 minutes after the heated steering wheel is turned on.

Horn

To sound the horn, press the area indicated by the horn symbol on your steering wheel (see illustration).



The horn will operate only when this area is pressed. Check the horn regularly to be sure it operates properly.

* NOTICE

To sound the horn, press the area indicated by the horn symbol on your steering wheel (see illustration). The horn will operate only when this area is pressed.

Mirrors

This vehicle is equipped with rearview mirrors inside and outside to provide views of objects behind the vehicle.

Inside rear view mirror

Adjust the rear view mirror so that the center view through the rear window is seen. Make this adjustment before you start driving.

Do not place objects in the rear seat or cargo area which would interfere with your vision out the rear window.

⚠ WARNING

Mirror Adjustment

Do not adjust the rear view mirror while the vehicle is moving. This could result in loss of control.

⚠ CAUTION

Cleaning Mirror

When cleaning the mirror, use a paper towel or similar material dampened with glass cleaner. Do not spray glass cleaner directly on the mirror. It may cause the liquid cleaner to enter the mirror housing.

*** NOTICE**

Do not modify the inside mirror in any manner, including installing a wide mirror. Doing so could result in injury during an accident or deployment of the air bag.

Day/night rear view mirror (if equipped)

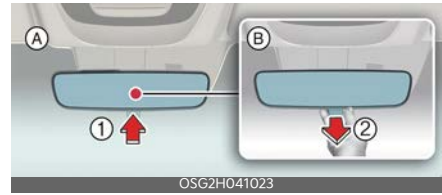

(A): Day, (B): Night

Make this adjustment before you start driving and while the day/night lever is in the day position (1).

Pull the day/night lever toward you (2) to reduce the glare from the headlamps of the vehicles behind you during night driving.

Remember that you lose some rear view clarity in the night position.

For KIA Connect button function: (if equipped)



- 1 Kia Connect button
- 2 Roadside assist button

Electric Chromic Mirror (ECM) (if equipped)

The electric rear view mirror automatically controls the glare from the headlamps of the vehicles behind you in nighttime or low light driving conditions.

The sensor mounted in the mirror senses the light level around the vehicle, and automatically controls the headlamp glare from the vehicles behind you.

When the vehicle is running, the glare is automatically controlled by the sensor mounted in the rear view mirror.

⚠ WARNING

- Do not place objects in the rear seat or cargo area which would interfere with your vision out the rear window.
- Do not adjust the rear view mirror while the vehicle is moving. This could result in loss of control, and an accident which could cause DEATH, SERIOUS INJURY, or property damage.
- Do not modify the inside mirror and don't install a wide mirror. It could result in injury, during an accident or deployment of the air bag.

Electric Chromic mirror (ECM) with HomeLink® system (if equipped)



- 1 HomeLink Channel 1
- 2 HomeLink Channel 2
- 3 HomeLink Channel 3
- 4 Garage Door Opener Status Indicator: Closing or Closed
- 5 HomeLink Operation Indicator
- 6 Garage Door Opener Status Indicator: Opening or Opened
- 7 HomeLink User Interface Indicator

Your vehicle may be equipped with a Gentex Automatic-Dimming Mirror with an Integrated HomeLink® Wireless Control System.

During nighttime driving, this feature will automatically detect and reduce rear view mirror glare. The HomeLink® Universal Transceiver allows you to activate your garage door(s), electric gate, home lighting, etc.

Automatic-Dimming Night Vision Safety™ (NVS®) Mirror

The NVS® Mirror automatically reduces glare by monitoring light levels in the front and the rear of the vehicle. Any objects that obstructs the light sensor will degrade the automatic dimming control feature.

For more information regarding NVS® mirrors and other applications, please refer to the Gentex website: www.gentex.com

Your mirror will automatically dim upon detecting glare from the vehicles traveling behind you.

The mirror defaults to the ON position each time the vehicle is started.

Integrated HomeLink® Wireless Control System

The HomeLink® Wireless Control System provides a convenient way to replace up to three handheld radio-frequency (RF) transmitters used to activate compatible devices such as gate operators, garage door openers, entry door locks, security systems, and home lighting.

*** NOTICE**

Considering the Home Security when the vehicle is parked outside the garage, the HomeLink will ONLY work when the ignition switch is in ACC position or ON position.

CAUTION

Before programming HomeLink to a garage door opener or gate operator, make sure that people and objects are out of the way of the device to prevent potential harm or damage. When programming a garage door opener, it is advised to park outside of the garage.

Do not use HomeLink with any garage door opener that lacks safety stop and reverse features as required by U.S. federal safety standards (this includes any garage door opener model manufactured before April 1, 1982). A garage door that cannot detect an object signaling the door to stop and reverse - does not meet current U.S. federal safety standards. For more information, contact HomeLink at www.homelink.com, or call HomeLink customer support at **1-800-355-3515**.

It is also recommended that a new battery be replaced in the hand-held transmitter of the device being trained to HomeLink for quicker training and accurate transmission of the radio frequency.

1. Programming HomeLink®

The following steps show how to program HomeLink. If you have any questions or are having difficulty programming your HomeLink buttons, refer to the HomeLink website or call the HomeLink customer support toll-free number. Do this, before going back to the dealer who sold you the car.

- Visit the HomeLink website at: www.homelink.com. Then at the top of the page, choose your vehicle make. Then watch the YouTube video, and/or access additional website information.

- If you choose to access the website via your cell phone, scan the QR code.



- Or, call HomeLink customer support at **1-800-355-3515** (Please have the vehicle make/model AND the opener device make/model readily available.)

1) Programming Preparation

1. When programming a garage door opener, it is advised to park the vehicle outside of the garage.
2. It is recommended that a new battery be placed in the hand-held transmitter of the device being programmed to HomeLink for quicker training and accurate transmission of the radio-frequency signal.
3. Place the EV button to the ACC (Accessory) position for programming of HomeLink.



2) Programming a New HomeLink® Button

1. Press and release the HomeLink button (1), (2) or (3), you would like to program. The HomeLink indicator light (7) will flash orange slowly (if not, perform the steps of "Erasing HomeLink Buttons" section, and start over).



2. Position the garage door opener remote 1~3 inches (2~8 cm) away from the HomeLink buttons.



3. While the HomeLink indicator light (7) is flashing orange, press and hold the hand-held remote button. Continue pressing the hand-held remote button until the HomeLink indicator light (7) light changes from orange to green. You may now release the hand-held remote button.

4. Wait until your garage door comes to a complete stop, regardless of position, before proceeding to the next steps.

5. Press and release the HomeLink button you are programming and observe the indicator light.
- If the indicator light remains solid green, your device should operate when the HomeLink button is pressed. At this point, if your device operates, programming is complete.
 - If the indicator light rapidly flashes green, firmly press, hold for two seconds and release the HomeLink button up to three times in a row slowly to complete the programming process. Do not press the

- HomeLink button rapidly. At this point if your device operates, programming is complete. If the device does not operate, continue with step 6.
6. At the garage door opener motor, (security gate motor, etc.) locate the "Learn", "Smart", "Set" or "Program" button. This can usually be found where the hanging antenna wire is attached to the motor-head unit (see the device's manual to identify this button). The name and color of the button may vary by manufacturer.

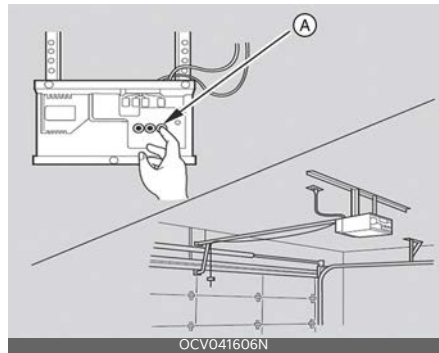

* A ladder and/or second person may simplify the following steps.

7. Firmly press and release the "Learn", "Smart", "Set" or "Program" button. You now have up to 30 seconds in which to complete the next step.
8. Return to the vehicle and firmly press, hold for two seconds and release, the HomeLink button up to three times in a row slowly. Do not press the HomeLink button rapidly. As soon as you see the garage door start to move, stop pressing any buttons until a few seconds after the garage door has come to a complete stop, regardless of position. At this point programming is complete and your device should

operate when the HomeLink button is pressed and released.

3) Two-Way Communication Programming (For select garage door openers)

If your garage door opener has the 'myQ' logo on its side, your opener has Two-Way Communication capability. HomeLink has the capability to establish Two-Way Communication with your garage door opener. HomeLink can receive and display "closing" or "opening" status messages from compatible garage door openers. At any time, HomeLink can also recall and display the last recorded status communicated by the garage door opener to indicate your garage door being "closed" or "opened". To check if your garage door opener is compatible with this feature, refer to www.homelink.com/compatible/Two-way-Communication. If your garage door opener has this functionality, AND the Two-Way Communication indicators (4), (6) in the mirror appear while the garage door is opening/closing, then no further steps are needed. Two-Way Communication Programming is already complete. However, if your garage door opener has this functionality, AND the Two-Way Communication indicators (4), (6) in the mirror DO NOT appear while the garage door is opening/closing, use the following instructions to enable this functionality.

1. In your vehicle, press and hold the programmed HomeLink button for 2 seconds, then release. Confirm that the garage door is moving. AFTER it stops, you will have one minute to complete the following steps:

- * A ladder and/or second person may simplify the following steps.
2. On your garage door opener in your garage, locate the "Learn" button (usually near where the hanging antenna wire is attached to the garage door opener). If there is difficulty locating this button, refer to the device's owner's manual.
3. Press and release the "Learn" button.
4. A light on your garage door opener may flash, and your Two-Way Communication indicators (4), (6) in your vehicle may flash, confirming completion of the process.
5. Return to the vehicle and firmly press and release the programmed HomeLink button to activate your garage door. The Two-Way Communication indicators (4), (6) flash in orange when the door is moving. Do not make any additional button presses until AFTER the garage door has come to a complete stop.
6. Your Two-Way Communication programming is now complete.

* NOTICE

If your garage door opener has Two-Way Communication functionality, it is possible for HomeLink to stop functioning the garage door shortly after initial programming, if the Two-Way Communication Programming wasn't properly completed. This usually happens after the first 10 times a programmed HomeLink button is pressed. If you experience this, completing the "Programming a New HomeLink Button" and "Two-Way Communication Programming" will restore door operation.

4) Canadian Programming

Canadian radio-frequency laws require transmitter remote signals to "time-out" (or quit) after a couple seconds of transmission, which may not be long enough for HomeLink to pick up the signal during programming.

If you live in Canada or you are having difficulties programming a gate operator or garage door opener by using the programming procedures, replace "Programming a New HomeLink Button" step 3 with the following:

While the HomeLink indicator light (7) is flashing orange, press and release ("cycle") your device's hand-held remote every two seconds until the HomeLink indicator light (7) changes from orange to green. You may now release the hand-held remote button. Then proceed with "Programming a New HomeLink Button" step 4.

2. Operating HomeLink®

1) Operating HomeLink®

1. Press and release the desired programmed HomeLink button (1, 2 or 3).



* NOTICE

The HomeLink indicator (7) should light green, solid or flashing, and your programmed device should operate.

If your device does not operate, the HomeLink programming was not suc-

cessful, and you'll need to reprogram the button.

2) Two-Way Communication Display Behavior

1. Press and release one of the programmed HomeLink buttons (1, 2 or 3)



2. The indicator (4) and (6) operates as below, if your garage door opener has Two-Way Communication functionality.



- If the indicator (4) flashes in Orange, it indicates that the garage door is "Closing".
- The indicator (4) turns solid green once the garage door has closed.
- If the indicator (6) flashes in Orange, it indicates that the garage door is "Opening".
- The indicator (6) turns solid green once the garage door has fully opened.
- If the indicator (4) or (6) does not turn to green, it indicates that the last status of garage door was not received properly. The HomeLink mirror tries to receive the last

known status of the garage door for a few seconds.

3) Recalling Garage Door Status

HomeLink mirror with Two-Way Communication provides a way to view the last stored message from the garage door opener. In order to recall the last known status of the last activated device, press the buttons "1 and 2" OR "2 and 3" simultaneously.

- If the indicator (4) appears solid Green, it indicates that the last activated device was "closed" properly.
- If the indicator (6) appears solid Green, it indicates that the last activated device was "open" properly.

3. Erasing HomeLink® Buttons

1) Erasing and Reprogramming a Single HomeLink® Button:

1. Press and hold the desired HomeLink button you want to re-program. DO NOT release the button.
2. The HomeLink indicator light (7) will appear solid green. Release the button as soon as the HomeLink indicator light (7) begins to flash orange, usually about 20 seconds.
3. Proceed with the steps in the "Programming a New HomeLink Button" section.

* NOTICE

If you do not complete the re-programming of a new device to the button, it will revert to the previously stored programming.

2) The following instructions will erase ALL HomeLink® programming from ALL buttons:



1. Press and hold the buttons (1) and (3) simultaneously
2. The HomeLink indicator light (7) will appear solid Orange for about 10 seconds
3. Release the buttons once the HomeLink indicator light (7) changes to Green and flashes rapidly
4. Now all three HomeLink buttons (1), (2) and (3) are cleared of any programming

Information

HomeLink and the HomeLink House logo are registered trademarks of Gen-tex Corporation.

The myQ logo is a registered trademark of The Chamberlain Group, Inc

FCC (USA) and ISED (Canada)

This device complies with FCC rules part 15 and Innovation, Science, and Economic Development Canada RSS-210. Operation is subject to the following two conditions: (1) This device may not cause harmful interference, and (2) This device must accept any interference that may be received including interference that may cause undesired operation. **WARNING:** The transmitter has been tested and complies with FCC and ISED rules. Changes or modifications not expressly approved by the party responsible for

compliance could void the user's authority to operate the device.

This equipment complies with FCC and ISRE radiation exposure limits set forth for an uncontrolled environment. End Users must follow the specific operating

instructions for satisfying RF exposure compliance. This transmitter must be at least 20 cm from the user and must not be co-located or operating in conjunction with any other antenna or transmitter.

HomeLink 5 Programing Flow Chart

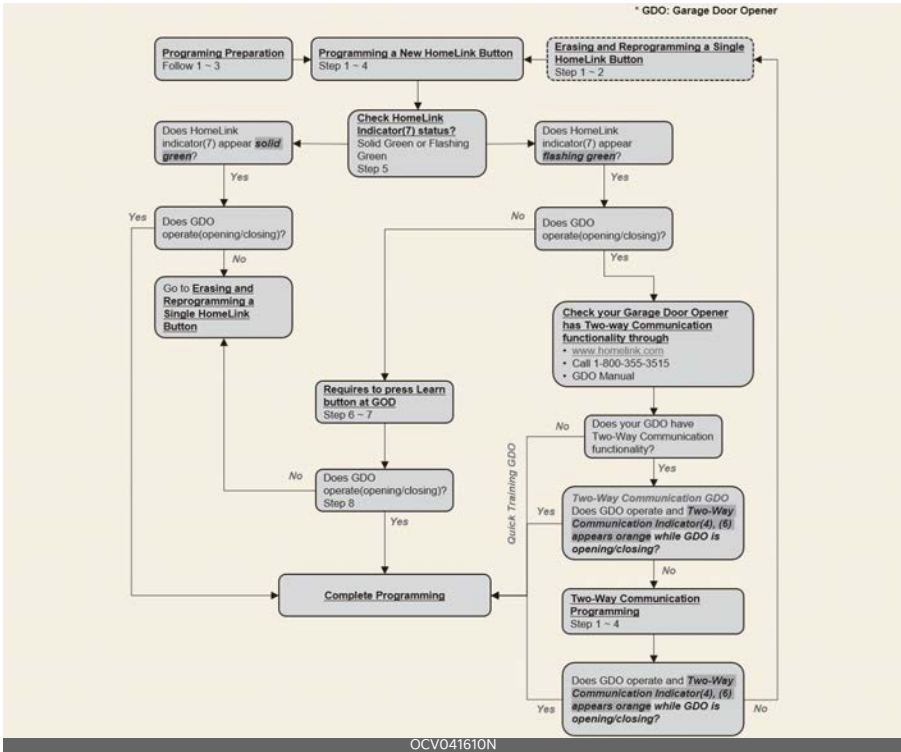

Outside rear view mirror

Your vehicle is equipped with both left-hand and right-hand outside rear view mirrors.

Be sure to adjust the mirror angles before driving.

The mirrors can be adjusted remotely with the remote switch. The mirror heads can be folded back to prevent damage during an automatic car wash or when passing through a narrow street.

⚠ CAUTION

Rear View Mirrors

Do not scrape ice off the mirror face; this may damage the surface of the glass. If ice should restrict the movement of the mirror, do not force the mirror for adjustment. To remove ice, use a de-icer spray, a sponge or soft cloth with very warm water.

If the mirror is jammed with ice, do not adjust the mirror by force. Use an approved spray de-icer (not radiator antifreeze) to release the frozen mechanism or move the vehicle to a warm place and allow the ice to melt.

⚠ WARNING

Mirror Adjustment

Do not adjust or fold the outside rear view mirrors while the vehicle is moving. This could result in loss of control.

Adjusting the outside rear view mirrors



Adjusting the rear view mirrors:

1. Move the R or L switch (1) to select the right side mirror or the left side mirror.
2. Press a corresponding point on the mirror adjustment control (2) to position the selected mirror up, down, left or right.
3. After adjustment, put the button into neutral (center) position to prevent inadvertent adjustment.

⚠ CAUTION

- The mirrors stop moving when they reach the maximum adjusting angles, but the motor continues to operate while the switch is pressed. Do not press the switch longer than necessary, the motor may be damaged.
- Do not attempt to adjust the outside rear view mirror by hand. Doing so may damage the parts.

Folding the outside rear view mirror



The mirror will fold or unfold automatically as follows:

- The mirror will fold or unfold when the door is locked or unlocked by the smart key.
- The mirror will fold or unfold when the door is locked or unlocked by the button on the outside door handle.
- The mirror will unfold when you approach the vehicle (all doors closed and locked) with a smart key in possession. (if equipped)

CAUTION

The electric type outside rear view mirror operates even though the EV button is in OFF position. However, to prevent unnecessary battery discharge, do not adjust the mirrors longer than necessary while the EV button is ON.

Do not fold an electric type outside rear view mirror by hand as this could cause motor failure.

Reverse parking aid function (if equipped)

When you shift the gear to the R (Reverse) position, the outside rear view mirror(s) will rotate downwards to aid with driving in reverse.



OSG2H041025_2

The position of the outside rear view mirror switch (1) determines whether or not the mirrors will move:

Left/Right: When either the L (Left) or R (Right) switch is selected, both outside rear view mirrors will move.

Neutral: When neither switch is selected, the outside rear view mirrors will not move.

The outside rear view mirrors will automatically revert to their original positions if any of the followings occur:

- The ignition switch or EV button is placed to either the LOCK/OFF position or the ACC position.
- The gear is shifted to any position except R (Reverse).
- The remote control outside rear view mirror switch is not selected.

Auto reverse user settings

If you cannot secure enough visibility with the angles provided as factory default conditions, you can readjust and store the angles of outside rear view mirrors.

The factory default angles of the right and left rear view mirrors might be set differently to improve visibility.

1. Set the shifter dial to P (Parking).
Make sure that the vehicle is stopped and the mirrors are not working.
2. Position the lever to L (left) or R (right) depending on the mirror that you want to adjust.
3. Step on the brake pedal and shift the shifter dial to R (Reverse).
4. When the downward movement of the rear view mirror is finished, adjust the mirror to the desired angle by pressing the switches, ▼, ▲, ◀, ▶.
5. If you shift the shifter dial to a position other than R (Reverse), or change the rear view mirror selector lever to the neutral position, and the automatic return of the mirror is finished, the

adjusted angle will be automatically saved.

6. You can adjust the rear view mirror on the other side by following the same procedures (1-5).

How to reset auto reverse user settings

If you want to change the automatic control function of rear view mirrors to factory-default conditions, follow the steps below.

1. Shift the shifter dial to P (Park). Make sure that the vehicle is stopped and the mirror is not working.
2. Choose the mirror to be adjusted by positioning the lever to L (left) or R (right).
3. Step on the brake pedal and shift the shifter dial to R (Reverse).
4. When the downward movement of the rear view mirror is finished, press the switch ▲ to locate the mirror in the position higher than before (P, N or D).

(Adjust the mirror in the higher position compared to its position in the driving mode)

5. It is initialized when the shifter dial is shifted to a position other than R (Reverse), or the rear view mirror selector lever is changed to the neutral position. (Initialized position will be applied from next operation)
6. You can initialize settings for the mirror on the other side by following the same procedures (1-5).

CAUTION

We recommend following the procedures in an orderly manner to change or initialize the auto reversing user settings.

If you move to the next step before completing the previous one, the changed angle may not be changed or initialization may not work properly.

Instrument cluster

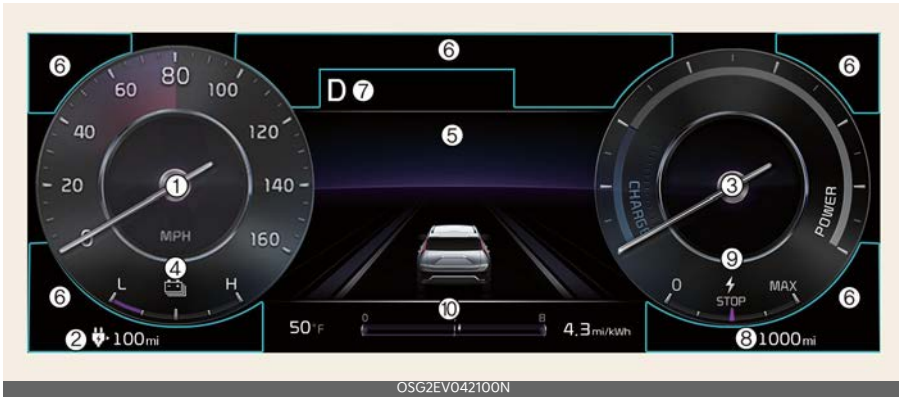

1. Speedometer

- MPH, km/h
- The speed of the vehicle in kilometers per hour (km/h) or miles per hour (mph).

2. Distance to empty

- Estimated distance the vehicle can be driven with the remaining electric energy.

3. Power/Charge gauge

- The energy consumption rate of the vehicle and the charge/discharge status of the regenerative brakes.

4. Battery SOC (State of Charge) gauge

- Charging status of the high voltage battery.

5. LCD display

- Refer to "LCD display" on page 5-75.

6. Warning and indicator lights

- Refer to "Warning and indicator lights" on page 5-85.

7. Reduction gear shift indicator

- The indicator displays which gear is selected.

8. Odometer

- The odometer indicates the total distance that the vehicle has been driven.

9. Regenerative braking level indicator

- Refer to "Regenerative braking system" on page 6-14.

10. Electric energy economy

- Refer to "Trip computer mode" on page 5-76.

⚠ CAUTION

- The information is displayed after getting information from a weather information provider via GPS. Depending on conditions of GPS reception, the information may be different from the current weather in your area.
 - Be careful while driving as dynamic-themed animation effects can distract the driver and lead to unexpected accidents.
-

*** NOTICE**

- When the remaining battery is lower than 10% for the high voltage battery, the vehicle speed is limited and then eventually the vehicle will turn OFF. Charge the vehicle immediately.
 - If the vehicle is not on level ground or the battery power has been interrupted, the distance to empty function may not operate correctly.
 - The distance to empty may differ from the actual driving distance as it is an estimate of the available driving distance.
 - The distance to empty may vary significantly based on driving conditions, driving habits, and condition of the vehicle.
 - Use a clean soft microfiber cloth to gently wipe any finger prints off the touch screen.
 - The instrument cluster for the right-hand drive vehicle may be on the opposite side show differently.
-

Cluster themes (if equipped)

The cluster provides two themes.

Type A

Type A is the basic theme of the full LCD type cluster and provides different graphic styles depending on drive mode.



Type B (Dynamic)

Type B is set by the user and provides digital display. The background screen changes according to the weather and time.



- Weather: sunny, cloudy, rainy, snowy, foggy, lightning (7 types)
- Time: night, day, sunrise and sunset (4 types)

You can change the theme by selecting "Vehicle → Cluster → Cluster theme" on the menu.

⚠ CAUTION

The information is displayed after getting information from a weather information provider via GPS. Depending on conditions of GPS reception, the information may be different from the current weather in your area.

If no information is received via GPS (e.g., not subscribed to Kia Connect service), the weather and time will be displayed as 'sunny' and 'night' on the cluster.

⚠ CAUTION

- For full LCD type cluster (Type B), the information is displayed after getting information from a weather information provider via GPS. Depending on conditions of GPS reception, the information may be different from the current weather in your area. If no information is received via GPS (e.g., not subscribed to Kia Connect service), the weather and time will be displayed as 'sunny' and 'night' on the cluster.
- Be careful while driving as dynamic themed animation effects can distract the driver and lead to unexpected accidents.

*** NOTICE**

- If the vehicle is not on level ground or the battery power has been interrupted, the distance to empty function may not operate correctly.
- The distance to empty may differ from the actual driving distance as it is an estimate of the available driving distance.
- As the period of use of the vehicle or total mileage increases, the vehicle's

mileage may decrease to protect the battery.

- The energy consumption and distance to empty may vary significantly based on driving conditions, driving habits, and condition of the vehicle.
- Use a clean soft microfiber cloth to gently wipe any finger prints off the screen.

Instrument panel illumination control

The brightness of the instrument panel illumination is changed by pressing the illumination control button ("+" or "-") when the vehicle's position lights or headlamps are turned on.



- If you hold the illumination control button ("+" or "-"), the brightness will be changed continuously.



- If the brightness reaches to the maximum or minimum level, an alarm will sound.

⚠ WARNING

Never adjust the instrument cluster while driving. This could result in loss of control and lead to an accident that may

cause death, serious injury, or vehicle damage.

Gauges

The gauges display various information such as the speed of the vehicle, the amount of charge of the battery, and so on.

Speedometer

km/h / mph



ONQ5PO41140N_2

The speedometer indicates the speed of the vehicle and is calibrated in miles per hour (mph) and/or kilometers per hour (km/h).

Power/Charge gauge



OSG2EV042134N

The Power/Charge gauge shows the energy consumption rate of the vehicle and the charge/discharge status of the regenerative brakes.

- **PWR** (Power): It shows the energy consumption rate of the vehicle when driving uphill or accelerating. The more electric energy is used, the higher the gauge level.
- **CHG** (Charge): It shows the charging status of the battery when it is being charged by the regenerative brakes (decelerating or driving on a downhill

road). The more electric energy is charged, the lower the gauge level.

State of Charge (SOC) gauge for high voltage battery



OSG2EV042135N

The SOC gauge shows the charging status of the high voltage battery.

The low percentage number on the indicator indicates that there is not enough energy in the high voltage battery. 100% indicates that the driving battery is fully charged.

When driving on highways or motorways, make sure to check in advance if the driving battery is charged enough.

When the remaining battery is lower than 10% on the SOC gauge, the warning light (⚡) turns ON to alert you of the battery level.

When the warning light (⚡) turns ON, the vehicle can drive approximately an additional 18~25 miles (30~40 km) depending on the driving speed, heater/air conditioner, weather, driving style, and other factors. Charging is required.

* NOTICE

When the high voltage battery range is 25~30 miles (40~50 km), the vehicle speed is limited, and then eventually the vehicle will turn OFF. Charge the vehicle immediately.

Outside temperature gauge



This gauge indicates the current outside air temperatures by 1 °F (1 °C).

The outside temperature on the display may not change immediately like a general thermometer to prevent the driver from being distracted.

You can change the temperature unit from the Settings menu in the infotainment system screen. Select:

General Settings → **Unit** → **Temperature Unit** → °C/°F

Both the temperature unit on the cluster LCD display and climate control screen will change.

* INFORMATION

The infotainment system may change after software updates. For more information, refer to the user's manual provided in the infotainment system and the quick reference guide.

Odometer



The odometer indicates the total distance that the vehicle has been driven and should be used to determine when periodic maintenance should be performed.

Distance to empty



- The distance to empty is the estimated distance the vehicle can be driven with the remaining electric energy.
- The distance to empty varies depending on which drive mode is selected among **ECO/NORMAL/SPORT/SNOW** mode.

* NOTICE

- If the vehicle battery power has been interrupted, the distance to empty function may not operate correctly.
- The distance to empty may differ from the actual driving distance as it is an estimate of the available driving distance.
- The distance to empty may vary significantly based on driving conditions, driving habits, and condition of the vehicle.

Reduction gear shift indicator



This indicator displays which position is selected.

- Park: P
- Reverse: R
- Neutral: N

- Drive: D

Regenerative braking level indicator



The regenerative brake indicates the level of the regenerative braking that you set. And it also indicates Smart regenerative system's operation status.

LCD display

Changing LCD display modes



- 1 : MODE button for changing modes
- 2 : MOVE switch for changing items
- 3 : OK: SELECT/RESET button for setting or resetting the selected item

LCD display modes

Mode					
	 Driving Assist	 Trip Computer	 Turn By Turn (TBT)*	 User Settings*	 Information/Master Warning
^ v Up/ Down	Forward Collision-Avoidance Assist Lane Keeping Assist Blind-Spot Collision-Avoidance Assist* Smart Cruise Control Lane Following Assist Highway Driving Assist	Drive information	Route Guidance	Driver Assistance*	TPMS
		After recharging*	Destination Info	Head-Up Display*	Coolant Temperature
		Accumulated info		Cluster	The Master Warning mode displays warning messages related to the vehicle when one or more systems is not operating normally.
		Energy Flow		Lights*	
		Digital Speedometer		Door*	
				Convenience*	
				Units	
				Language	
			Reset		

* : if equipped

* If you press OK button for more than 1 second when the Driving Assist mode is being displayed, it leads to Driver assistance settings menu on the infotainment system screen.

Trip modes

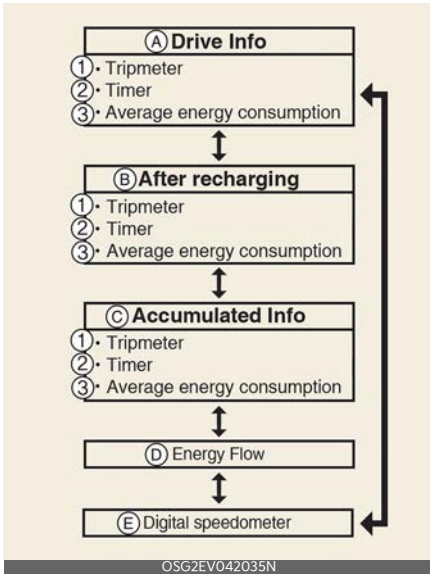

- A: Drive Info
- B: After recharging
- C: Accumulated Info
- D: Energy Flow
- E: Digital speedometer

- 1 Tripmeter
- 2 Timer
- 3 Average energy consumption

To change the trip mode, toggle the switch (∧ / ∨) on the steering wheel.

* : if equipped

Electric energy economy

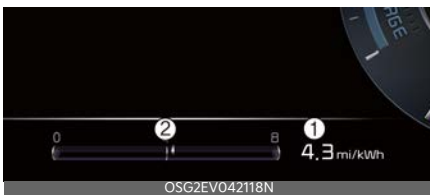

- 1 Average electric energy economy

2 Instant electric energy economy

Average electric energy economy (1)

The average electric energy economy is calculated by the total driving distance and energy consumption since the last average electric energy economy resets.

- **On vehicle start:** The information will automatically reset when the driver's door is opened after the vehicle is turned off, or approximately 3 minutes have passed after the vehicle is turned off.
- **After recharging:** The information will reset to default automatically after recharging.
- **Manually:** Press and hold the OK button on the steering wheel when the average energy consumption is displayed.

Instant electric energy economy (2)

Displays the instant electric energy economy during the last few seconds when the vehicle speed is more than approximately 10 km/h (6 mph).

Driving assist mode

This mode displays the state of:

- Forward Collision-Avoidance Assist
- Lane Keeping Assist
- Blind-Spot Collision-Avoidance Assist
- Smart Cruise Control
- Lane Following Assist
- Highway Driving Assist

Trip computer mode

* You may change through items in the following order.

Drive Info

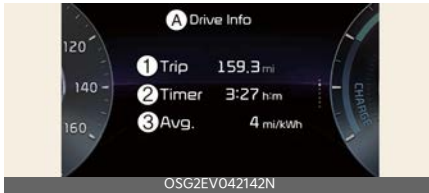

A: Drive information

- 1 Accumulated trip distance
- 2 Total driving time
- 3 Average energy consumption

The driver's door is opened after turning off the vehicle or the vehicle is turned on after 3 minutes have passed, the Drive Info screen will reset.

After recharging



A: After recharging

- 1 Accumulated trip distance
- 2 Total driving time
- 3 Average energy consumption

The information after recharging. To manually reset the information, press and hold the OK button when viewing the **After recharging**.

Accumulated Info

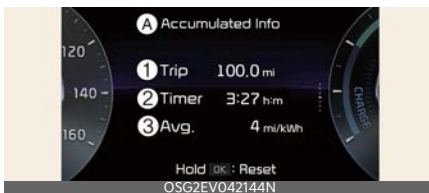

A: Accumulated info

- 1 Accumulated trip distance
- 2 Total driving time
- 3 Average energy consumption

The information is accumulated starting from the last reset.

To manually reset the information, press and hold the OK button when viewing the **Accumulated Info**.

* NOTICE

- The vehicle must be driven for a minimum of 300 meters (0.19 miles) since the last cycle before the accumulated driving information is recalculated.
- The average electric energy economy is not displayed for more accurate calculation if the vehicle does not drive more than 10 seconds or 50 meters (0.03 miles) since the EV button is turned on.

5

Energy flow



A: Idle mode

- The electric vehicle system informs the drivers its energy flow in various operating modes.

Digital speedometer

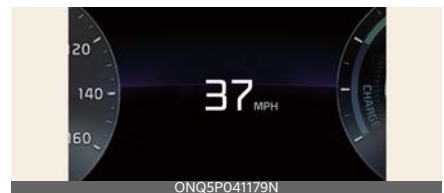

Indicates the speed of the vehicle.

Turn By Turn (TBT) mode

This mode displays the Navigation status.

Information mode

Tire pressure



A: Tire Pressure

- Information related to Tire Pressure. Refer to "Tire Pressure Monitoring System (TPMS)" on page 7-6.

Master warning mode



A: Check headlamp LED



This mode informs you of the following situations:

- Driver assistance system malfunction, limitation or radar/camera blockage
- LED headlamp malfunction
- Lamp malfunction
- TPMS failure, low tire pressure, etc.

At this time, a Master Warning icon () will appear in the lower right corner on the LCD display. If the warning situation is solved, the master warning light will be turned off and the Master Warning icon will disappear.

User settings mode

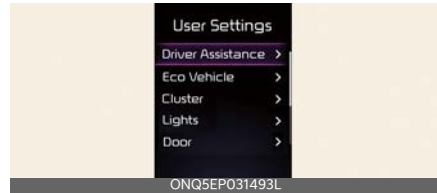

In this mode, you can change the settings of the instrument cluster, doors, lights, etc.

* The information provided may differ depending on which functions are applicable to your vehicle.

1. Driver Assistance (if equipped)

Items	Explanation
Driving Convenience	<ul style="list-style-type: none"> • Smart Cruise Control
Speed Limit	<ul style="list-style-type: none"> • Select Country • Speed Limit Offset • Speed Limit Assist/Speed Assist Warning/Off
Warning Volume	<ul style="list-style-type: none"> • High/Medium/Low
Driver Attention Warning	<ul style="list-style-type: none"> • Leading vehicle departure alert
Driving Safety	<ul style="list-style-type: none"> • Forward Safety • Forward Safety Warning Timing - Standard/Late • Lane Safety • Blind-Spot Safety • Exit Safety
Parking Safety	<ul style="list-style-type: none"> • Parking Distance Warning Auto On • Rear Cross-Traffic Safety

2. Head-Up Display (if equipped)

Items	Explanation
Enable Head-Up Display	Activate/Deactivate
Display Height	• 1~20 Level
Rotation	• -5 ~ +5
Brightness	• 1~20 Level
Content Selection	<ul style="list-style-type: none"> • Turn by Turn • Traffic Signs • Driving Convenience Info • Blind-Spot Safety Info • Radio/Media Info

3. Cluster (if equipped)

Items	Explanation
Theme Selection	<ul style="list-style-type: none"> • Link to Drive Mode • Theme A/Theme B/Theme C
Wiper/Lights Display	Activate/Deactivate
Traffic Signs	Activate/Deactivate
Icy Road Warning	Activate/Deactivate
Cluster Voice Guidance Volume	• 0~3 Level
Welcome Sound	Activate/Deactivate

4. Lights (if equipped)

Items	Explanation
Illumination	• 1~20 Level
One Touch Turn Signal	• Off/3/5/7 Flashes
Ambient Brightness	• Off/1/2/3/4
Ambient Light Color	• 8 colors
Headlight Delay	Activate/Deactivate
High Beam Assist	Activate/Deactivate

5. Door (if equipped)

Items	Explanation
Automatically Lock	• Enable on shift/Enable on speed/Off
Automatically Unlock	• On shift to P/Vehicle Off/On key out (if equipped)/Off

Items	Explanation
Horn Feedback	• If this item is checked, Horn Feedback will be activated.
Power Tailgate	Activate/Deactivate
Power Tailgate Opening Speed	• Fast/Normal
Power Tailgate Opening Height	• Full open/Level 3/Level 2/Level 1/User Height Setting
Smart Tailgate	Activate/Deactivate
Remote Window Control (if equipped)	Activate/Deactivate

* INFORMATION

• Automatically Lock

- **Enable On Shift:** All doors will be automatically unlocked when the vehicle is shifted to P (Park) to R (Reverse), N (Neutral), or D (Drive). (With the vehicle ON, it is activated.)
- **Enable On Speed:** All doors will be automatically locked when the vehicle speed is over 15 km/h (9 mph).

• Automatically Unlock

- **On Shift to P:** All doors will be automatically unlocked if the gear is shifted to the P (Park) position. (With the vehicle ON, it is activated.)
- **Vehicle Off/On key out (if equipped):** All doors will be automatically unlocked when the ignition key is removed from the ignition switch or the EV button is set to the OFF position.

6. Convenience (if equipped)

Items	Explanation
Seat Easy Access	• Off/Normal/Extended
Rear Occupant Alert	Activate/Deactivate

Items	Explanation
Service Interval	<ul style="list-style-type: none"> Enable Service Interval/ Adjust Interval/Reset
Welcome Mirror/Light	<ul style="list-style-type: none"> On door unlock/On door unlock
Wireless Charging System	Activate/Deactivate
Auto rear wiper (in R)	Activate/Deactivate
PASSENGER AIR BAG	Activate/Deactivate

7. Units

Items	Explanation
Speed Unit	<ul style="list-style-type: none"> km/h, MPH
Temperature Unit	<ul style="list-style-type: none"> °C, °F
Consumption Unit	<ul style="list-style-type: none"> km/L, L/100km
Tire Pressure Unit	<ul style="list-style-type: none"> psi/kPa/bar

8. Language

Items	Explanation
Language	Activate

9. Reset

Items	Explanation
Reset	Yes/No

LCD display messages

Door, hood, liftgate open warning display

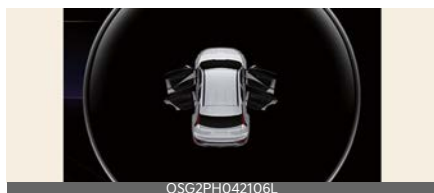

This warning is displayed if any door or the hood or the liftgate is left open. The warning will indicate which door is open in the display.

⚠ CAUTION

Before driving the vehicle, you should confirm that the door/hood/liftgate is fully closed. Also, check that there is no door/hood/liftgate open warning light or message displayed on the instrument cluster.

Sunroof open warning display (if equipped)



This warning is displayed if you turn off the vehicle when the sunroof is open. Close the sunroof securely before leaving your vehicle.

Low tire pressure warning display

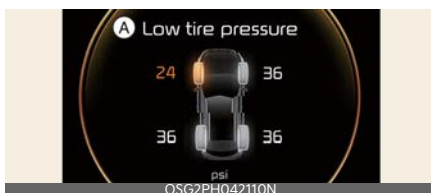

A: Low tire pressure

This warning message is displayed if the tire pressure is low. The corresponding tire on the vehicle will appear.

* For more details, refer to "Tire Pressure Monitoring System (TPMS)" on page 7-6.

Lights mode



A: Lights

- 1  D
- 2  
- 3 AUTO
- 4 OFF

This indicator displays which exterior light is selected using the lighting control.

You can activate or deactivate Wiper/Lights Display function from the infotainment system.

Wiper mode



A: Front Wiper

- 1 OFF
- 2 AUTO
- 3 LO
- 4 HI

This indicator displays which wiper speed is selected using the wiper control.

You can activate or deactivate Wiper/Lights Display function from the infotainment system.

Low key battery

This warning message is displayed if the battery of the smart key is discharged while changing the EV button to the OFF position.

Press brake pedal to start vehicle

This warning message is displayed if the EV button changes to the ACC position twice by pressing the button repeatedly without depressing the brake pedal.

You can start the vehicle by depressing the brake pedal.

Key not in vehicle

This warning message is displayed if the smart key is not in the vehicle when you press the EV button.

When attempting to start the vehicle, always have the smart key with you.

Key not detected

This warning message is displayed if the smart key is not detected when you press the EV button.

Press EV button again

This message is displayed if you were unable to start the vehicle when the EV button was pressed.

If this occurs, attempt to start the vehicle by pressing the EV button again.

If the warning message appears each time you press the EV button, have your vehicle inspected by an authorized Kia dealer.

Press EV button with key

This warning message is displayed if you press the EV button while the warning message **Key not detected** is displayed.

Shift to P to start vehicle

This warning message is displayed if you try to start the vehicle without shifting to the P (Park) position.

Shift to P

This warning message is displayed if you try to turn off the vehicle with the gear in the N (Neutral) position.

At this time, the EV button changes to the ACC position (If you press the EV button once more, it will turn to the ON position).

Battery discharging due to external electrical devices

This message is displayed if the battery voltage is weak due to any non-factory electrical accessories (ex. dashboard camera). Be careful that the battery is not discharged.

If the warning message appears after removing the non-factory electrical accessories, have your vehicle inspected by an authorized Kia dealer.

Low washer fluid

This warning message is displayed if the washer fluid level in the reservoir is nearly empty.

Have the washer fluid reservoir refilled.

Shift to P to charge

This message is displayed if you connect the charging cable without the gear in the P (Park) position.

Shift to P (Park) before connecting the charging cable.

Low EV battery

When the high voltage battery level reaches around 10% or less, this warning message is displayed.

The warning light on the instrument cluster (⚠️) will turn on simultaneously. Charge the battery immediately.

Charge immediately. Power limited

When the high voltage battery level reaches around 5% or less, this warning message is displayed.

The warning light on the instrument cluster (⚠️) and the power down indicator light (🚫) will turn on simultaneously.

The vehicle's power will be reduced to minimize the energy consumption of the high voltage battery. Charge the battery immediately.

Check electric vehicle system

This warning message is displayed when there is a problem with the electric vehicle control system.

WARNING

Refrain from driving when the warning message is displayed.

If this occurs, park the vehicle in a safe location and have your vehicle towed to the nearest authorized Kia dealer and have the vehicle inspected.

Power limited

In the following cases, this warning message is displayed when the vehicle's power is limited for safety.

- When the power is limited for the safety of the high-powered parts of an electric vehicle. The power is limited for the following reasons. (Unless both Service Warning Light and Power Down Indicator Light appear at the same time, it is not a failure.)
- The high voltage battery level is too low or voltage is decreasing.
- The temperature of the high voltage battery is too high or too low.
- The temperature of the motor is high.

* NOTICE

When this warning message is displayed, do not accelerate or start the vehicle suddenly. Charge the battery immediately when the high voltage battery level is not enough.

* NOTICE

When the power is limited for the safety of the high-powered parts of an electric vehicle, the power down indicator light illuminates. Your vehicle may not be driven, or may roll back on a slope with the indicator light ON due to the limitation of the vehicle power.

Power limited due to low EV battery temperature. Charge battery

The warning message is displayed to protect the electric vehicle system when you turn off or turn on the vehicle while outside temperature is low. If the high voltage battery charging level is low and parked outside in low temperature for a

long time, vehicle power could be limited. Charging the battery before driving, increases the battery temperature, and helps increase power.

⚠ CAUTION

If this warning message is still displayed even when the ambient temperature is sufficiently high, have the vehicle inspected by an authorized Kia dealer.

EV Battery Overheated! Stop vehicle

This warning message is displayed to protect battery and electric vehicle system when the high voltage battery temperature is too high.

Turn off the EV button and stop the vehicle so that the battery temperature decreases.

⚠ WARNING

If this warning is still displayed even after the EV button has been turned off for sufficient time, refrain from driving and have the vehicle inspected by an authorized Kia dealer.

Stop vehicle and check power supply

This warning message is displayed when a failure occurs in the 12 V power supply system.

If this occurs, park the vehicle in a safe location, tow your vehicle to the nearest authorized Kia dealer and have the vehicle inspected.

Unplug vehicle to start

This message is displayed when you start the vehicle, without unplugging the

charging cable, and will not shift out of park. Unplug the charging cable, and then turn on the vehicle.

Charging Door Open

This message is displayed when the vehicle is driven with the charging door opened. Close the charging door and then start driving.

Remaining Time

This message is displayed to notify the remaining time to charge the battery, to the selected target battery charge level, and the charge voltage level.

Charging Stopped. Check the charger

This warning message is displayed when charging is stopped for the reasons below:

- There is a problem with the external AC charger or DC charger.
- The external AC charger stopped charging
- The charging cable is damaged.

If this occurs, check whether there is any problem with the external AC or DC charger and charging cable.

If the same problem occurs when charging the vehicle with a well-functioning external charger or genuine Kia portable charger (sold separately), have your vehicle inspected by an authorized Kia dealer.

Charging Stopped. Check the cable connection

This warning message is displayed for the reasons below:

- The charging connector is not correctly connected to the charging inlet.
- The charging connector lock release button is pressed.

If this occurs, separate the charging connector and re-connect it.

Check whether there is any problem (external damage, foreign substances, etc.) with the charging connector and charging inlet.

If the same problem occurs when charging the vehicle with a replaced charging cable or genuine Kia portable charger (sold separately), have your vehicle inspected by an authorized Kia dealer.

Check regenerative brakes

This warning message is displayed when the regenerative brake system does not work properly.

In this case, have your vehicle inspected by an authorized Kia dealer.

Check Virtual vehicle Sound System

This message is displayed when there is a problem with the Virtual vehicle Sound System (VESS).

In this case, have your vehicle inspected by an authorized Kia dealer.

Check Active Air Flap System

This warning message is displayed in the following situations:

- There is a malfunction with the actuator flap
- There is a malfunction with the actuator air flap controller
- The air flap does not open

When all of the above conditions are fixed, the warning will disappear.

Refill coolant

This message is displayed when the coolant is low. If the warning message is displayed, stop driving and check the amount of coolant. Driving without sufficient coolant for a prolonged period of time can cause serious problems with the vehicle's electrical equipment and make normal driving impossible.

Warning and indicator lights

The warning light and indicator light indicate a situation where the driver should be careful and whether the various functions are activated.

Warning lights

The warning light indicates situations that require the driver to pay attention.

* NOTICE

Warning Lights

Make sure that all warning lights are OFF after starting the vehicle. If any light is still ON, this indicates a situation that needs attention.

Service warning light

This warning light appears:

- When the EV button is in the ON position.
 - It appears for approximately 3 seconds and then goes off.
- When there is a problem with related parts of the electric vehicle control system, such as sensors, etc.

When the warning light appears while driving, or does not go OFF after starting the vehicle, have your vehicle inspected by an authorized Kia dealer.

Air bag warning light

This warning light appears:

- Once you set the EV button to the ON position.
 - It appears for approximately 3~6 seconds and then goes off.
- When there is a malfunction with the SRS.

In this case, have the vehicle inspected by an authorized Kia dealer.

Seat belt warning light

This warning light informs the driver that the seat belt is not fastened.

* For more details, refer to "Seat belts" on page 4-17.

Parking brake & brake fluid warning light

This warning light appears:

- Once you set the EV button to the ON position.
 - It appears for approximately 3 seconds
 - It remains on if the parking brake is applied.
- When the parking brake is applied.
- When the brake fluid level in the reservoir is low.
 - If the warning light appears with the parking brake released, it indicates the brake fluid level in reservoir is low.

If the brake fluid level in the reservoir is low:

1. Drive carefully to the nearest safe location and stop your vehicle.
2. With the vehicle stopped, check the brake fluid level immediately and add fluid as required (For more details, refer to "Brake fluid" on page 8-12). Then check all brake components for fluid leaks. If any leak on the brake system is still found, the warning light remains on, or the brakes do not

operate properly, do not drive the vehicle.

In this case, have your vehicle towed to an authorized Kia dealer and inspected.

Dual-diagonal braking system

Your vehicle is equipped with dual-diagonal braking systems. This means you still have braking on two wheels even if one of the dual systems should fail.

With only one of the dual systems working, more than normal pedal travel and greater pedal pressure are required to stop the vehicle.

Also, the vehicle will not stop in as short a distance with only a portion of the brake system working.

WARNING

Parking Brake & Brake Fluid Warning Light

Driving the vehicle with a warning light ON is dangerous. If the parking brake & brake fluid warning light appears with the parking brake released, it indicates that the brake fluid level is low.

In this case, have your vehicle inspected by an authorized Kia dealer.

Anti-lock Brake System (ABS) warning light

This warning light appears:

- When the EV button is in the ON position.
 - It appears for approximately 3 seconds and then goes off.
- When there is a malfunction with the ABS (The normal braking system will

still be operational without the assistance of the anti-lock brake system). In this case, have your vehicle inspected by an authorized Kia dealer.

Electronic Brake force Distribution (EBD) system warning light



These two warning lights appear at the same time while driving:

- When the ABS and regular brake system may not work normally. In this case, have your vehicle inspected by an authorized Kia dealer.



Electronic Brake force Distribution (EBD) System Warning Light

When both ABS and parking brake & brake fluid warning lights are on, the brake system will not work normally and you may experience an unexpected and dangerous situation during sudden braking.

In this case, avoid high speed driving and abrupt braking.

Have your vehicle inspected by an authorized Kia dealer as soon as possible.

Regenerative brake warning light

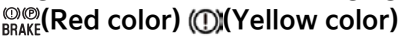

This warning light appears:

When the regenerative brake does not operate and the brake does not perform well. This causes the Brake Warning light (red) and Regenerative Brake Warning Light (yellow) to appear simultaneously.

In this case, drive safely and have the vehicle inspected by an authorized Kia dealer.

The operation of the brake pedal may be more difficult than normal, and the braking distance can increase, as it may default to manual hydraulic mode.

Electric Power Steering (EPS) warning light

This warning light appears:

- When the EV button is in the ON position.
 - It remains on until the vehicle is started.
 - When there is a malfunction with the EPS.
- When there is a malfunction with the EPS. In this case, have your vehicle inspected by an authorized Kia dealer.

Charging system warning light



This warning light appears:

- When the 12-volt battery level is low or a failure occurs on the charging system such as LDC.
- If the warning light turns on while driving, move the vehicle to a safe location, turn off and turn on the vehicle again, and check if the warning light turns off. If the warning light remains on, have your vehicle inspected by an authorized Kia dealer.
- Even if the warning light turns off, have the vehicle inspected by an authorized Kia dealer.

If you drive the vehicle while the warning light is on, vehicle speed may be limited and the 12-volt battery may be discharged.

* LDC: Low voltage DC-DC Converter.

High voltage battery low level warning light

This warning light appears:

- When the high voltage battery level is low.
When the warning light turns ON, charge the battery immediately.

Power down indicator light

This indicator appears:

- When the EV button is in the ON position.
 - It appears for approximately 3 seconds and then goes off.
- When the power is limited for the safety of the high-powered parts of an electric vehicle. The power is limited for the following reasons. (Unless both Service Warning Light and Power Down Indicator Light appear at the same time, it is not a failure.)
 - The high voltage battery level is too low or voltage is decreasing
 - The temperature of the high voltage battery is too high or too low
 - The temperature of the motor is high

* NOTICE

Do not accelerate or start the vehicle suddenly when the Power Down Indicator Light is ON.

Charge the battery immediately when the high voltage battery level is not enough.

* NOTICE

When the remaining battery power is low, the Power Down Indicator Light turns on and the output is limited. In that case, charge the battery immediately; otherwise, it could be difficult to climb hills or the vehicle may move backward.

Low tire pressure warning light



This warning light appears:

- When the EV button is in the ON position.
 - It appears for approximately 3 seconds and then goes off.
 - When one or more of your tires are significantly under inflated.
- * For more details, refer to "Tire Pressure Monitoring System (TPMS)" on page 7-6.

This warning light remains ON after blinking for approximately 60 seconds, or repeats blinking ON and OFF at the intervals of approximately 3 seconds:

- When there is a malfunction with the TPMS.
In this case, have your vehicle inspected by an authorized Kia dealer.
- * For more details, refer to "Tire Pressure Monitoring System (TPMS)" on page 7-6.

⚠ WARNING**Low Tire Pressure**

- Significantly low tire pressure makes the vehicle unstable and can contribute to loss of vehicle control and increased braking distances.
- Continued driving on low pressure tires will cause the tires to overheat and fail.

⚠ WARNING**Safe Stopping**

- The TPMS cannot alert you to severe and sudden tire damage caused by external factors.
- If you notice any vehicle instability, immediately take your foot off the accelerator pedal, apply the brakes gradually with light force, and slowly move to a safe position off the road.

Master warning light **This warning light informs the driver the following situations**

- Forward Collision-Avoidance Assist malfunction
- Forward Collision-Avoidance Assist radar blocked
- Blind-Spot Collision-Avoidance Assist malfunction (if equipped)
- Blind-Spot Collision-Avoidance Assist radar blocked (if equipped)
- Smart Cruise Control malfunction
- Smart Cruise Control radar blocked
- Lamp malfunction
- High Beam Assist malfunction

To identify the details of the warning, look at the LCD display.

Electronic Parking Brake (EPB) warning light **This warning light appears:**

- When the EV button is in the ON position.
 - It appears for approximately 3 seconds and then goes off.
- When there is a malfunction with the EPB.

In this case, have your vehicle inspected by an authorized Kia dealer.

*** NOTICE****Electronic Parking Brake (EPB) Warning Light**

The Electronic Parking Brake (EPB) Warning Light may appear when the Electronic Stability Control (ESC) Indicator Light comes on to indicate that the ESC is not working properly (This does not indicate malfunction of the EPB).

LED headlamp warning light **This warning light appears:**

- When the EV button is in the ON position.
 - It appears for approximately 3 seconds and then goes off.
- When there is a malfunction with the LED headlamp.

In this case, have your vehicle inspected by an authorized Kia dealer.

This warning light blinks:

- When there is a malfunction with a LED headlamp related part.

In this case, have your vehicle inspected by an authorized Kia dealer.

CAUTION

LED Headlamp Warning Light

Continuous driving with the LED Headlamp Warning Light on or blinking can reduce LED headlamp (low beam) life.

Emergency Steering warning light

This warning light appears:

- When the EV button is in the ON position.
 - It appears for approximately 3 seconds and then goes off.
- When Forward Collision-Avoidance Assist is turned off.
- When ESC is turned off by pressing and holding the ESC OFF button
- When the radar sensor or cover is blocked with dirt or snow. Check the sensor and cover and clean them by using a soft cloth.
- When there is a malfunction with Forward Collision-Avoidance Assist. If this occurs, have your vehicle inspected by an authorized Kia dealer.

* For more details, refer to "Forward Collision-Avoidance Assist (FCA) (Sensor Fusion)" on page 6-39.

Forward Safety warning light 

This warning light appears:

- Yellow:
 - When the EV button is in the ON position. It appears for approximately 3 seconds and then goes off.

- When Forward Safety/Forward Cross-Traffic Safety of Forward Collision-Avoidance Assist is Off/Disabled/Malfunction. It appears continuously.

- Red:
 - When Forward safety/Forward Cross-Traffic Safety of Forward Collision-Avoidance Assist is operating. It appears blinking.

* For more details, refer to "Forward Collision-Avoidance Assist (FCA) (Sensor Fusion)" on page 6-39.

Emergency steering warning light  (if equipped)

This warning light appears:

- Yellow:
 - When the EV button is in the ON position. It appears for approximately 3 seconds and then goes off.
 - When Forward/Side Safety of Forward Collision-Avoidance Assist is Off/Disabled/Malfunction. It appears continuously.

- Red:
 - When Forward/Side Safety of Forward Collision-Avoidance Assist is operating. It appears blinking.

* For more details, refer to "Forward Collision-Avoidance Assist (FCA) (Sensor Fusion)" on page 6-39.

Icy road warning light 

This warning light appears:

This warning light is to warn the driver the road may be icy. When the temperature on the outside temperature gauge

is approximately below 39 °F (4 °C) the icy road warning light and outside temperature gauge blinks and then appears. Also, the warning chime sounds 1 time.

* NOTICE

If the icy road warning light appears while driving, you should drive more attentively and safely refraining from over-speeding, rapid acceleration, sudden braking or sharp turning, etc.

Indicator lights

The indicator light indicates whether the various functions are activated.

Ready indicator light (READY)

This indicator appears:

When the vehicle is ready to be driven.

- ON: Normal driving is possible.
- OFF: Normal driving is not possible, or a problem has occurred.
- Blinking: Emergency driving.

When the ready indicator goes OFF or blinks, there is a problem with the system. In this case, have your vehicle inspected by an authorized Kia dealer.

Charging cable connection indicator light

This indicator appears:

This indicator appears when the charging cable is connected.

Electronic Stability Control (ESC) indicator light

This indicator light appears:

- When the EV button is in the ON position.
 - It appears for approximately 3 seconds and then goes off.
- When there is a malfunction with the ESC system.

In this case, have your vehicle inspected by an authorized Kia dealer.

This indicator light blinks:

While the ESC is operating.

* For more details, refer to "Electronic Stability Control (ESC)" on page 6-31.

Electronic Stability Control (ESC) OFF indicator light

This indicator light appears:

- When the EV button is in the ON position.
 - It appears for approximately 3 seconds and then goes off.
- When you deactivate the ESC system by pressing the ESC OFF button.

* For more details, refer to "Electronic Stability Control (ESC)" on page 6-31.

Immobilizer indicator light (with smart key)

This indicator light appears for up to 30 seconds:

- When the vehicle detects the smart key in the vehicle with the EV button in the ACC or ON position.

- Once the smart key is detected, you can start the vehicle (**READY** indicator ON).
- The indicator light goes off after starting the vehicle (**READY** indicator ON).

This indicator light blinks for a few seconds:

- When the smart key is not in the vehicle.
 - At this time, you cannot start the vehicle.

This indicator light appears for 2 seconds and goes off:

- If the smart key is in the vehicle and the EV button is ON, but the vehicle cannot detect the smart key. In this case, have your vehicle inspected by an authorized Kia dealer.

This indicator light blinks:

- When the battery of the smart key is weak.
- When there is a malfunction with the immobilizer system. In this case, have your vehicle inspected by an authorized Kia dealer.

Turn signal indicator light 

This indicator light blinks:

- When you turn the turn signal light on. If any of the following occurs, there may be a malfunction with the turn signal system. In this case, have your vehicle inspected by an authorized Kia dealer.
 - The indicator light does not blink but appears.

- The indicator light blinks more rapidly.
- The indicator light does not appear at all.

Low beam indicator light 

This indicator light appears:

- When the headlights are on.

High beam indicator light 

This indicator light appears:

- When the headlights are on and in the high beam position.
- When the turn signal switch is pulled into the Flash-to-Pass position.

High Beam Assist indicator light



This indicator light appears:

- When High Beam Assist is activated. * For more details, refer to "High Beam Assist (HBA)" on page 5-99.

Light ON indicator light 

This indicator light appears:

- When the tail lights or headlights are on.

AUTO HOLD indicator light (AUTO HOLD)

This indicator light appears:

- White: When you activate the AUTO HOLD system by pressing the AUTO HOLD button.

- Green: When you stop the vehicle completely by depressing the brake pedal with the AUTO HOLD system activated.
- Yellow: When there is a malfunction with the AUTO HOLD system.

In this case, have the vehicle inspected by an authorized Kia dealer.

* For more details, refer to "AUTO HOLD" on page 6-27.

Lane Safety indicator light

This indicator light appears:

The Lane Safety indicator light will appear when you turn Lane Keeping Assist on by pressing and holding the Lane Driving Assist button.

If there is a problem with the function, the yellow Lane Safety indicator will appear.

* For more details, refer to "Lane Keeping Assist (LKA)" on page 6-60.

Lane Following Assist indicator



This indicator light appears:

Lane Following Assist indicator will appear when you turn Lane Following Assist on by pressing Lane Driving Assist button.

If there is a problem with the function, the yellow Lane Following Assist indicator will appear.

* For more details, refer to "Lane Following Assist (LFA)" on page 6-115.

Highway Lane Change Assist indicator light (if equipped)

This indicator light appears:

- Green: When Highway Lane Change Assist is ready for operation.
- Grey: When Highway Lane Change Assist is in standby.

This indicator light blinks:

- Green: When Highway Lane Change Assist is operating.
 - White: When Highway Lane Change Assist is canceled.
- * For more details, refer to "Highway Driving Assist (HDA) (if equipped)" on page 6-118.

Drive mode indicator light (ECO/NORMAL/SPORT/SNOW)

This indicator light appears:

- When you select each mode as drive mode.
- * For more details, refer to "Drive mode integrated control system" on page 6-36.

Head-Up Display (HUD) (if equipped)

The Head-Up Display is a transparent display that projects an image of certain information from the instrument cluster and navigation system on the windshield glass.



- The head up display image on the HUD screen may be invisible when:
 - Sitting posture is bad.
 - Wearing a polarized sunglasses.
 - There is an object on the cover of the head up display.
 - Driving on a wet road.
 - An inadequate lighting is turned on inside the vehicle.
 - Any light comes from the outside.
 - Wearing an inadequate glasses to your eyesight.
- If the head up display image is not shown well, adjust the height, rotation or illumination of the head up display in the LCD display.
- When the head up display needs inspection or repair, Visit an authorized Kia dealer.

⚠ WARNING

Head-Up Display

- Do not make the front windshield glass have window tint or other types of metallic coating. Otherwise, the Head-Up Display image may be invisible.
- Do not place any accessories on the crash pad or attach any objects on the windshield glass.
- As Blind-Spot Collision-Avoidance Assist is a supplemental function for your safe driving, it may be dangerous to rely on only the Blind-Spot Safety information of the Head-Up Display image when changing the lane. Always pay attention to drive safely.

⚠ CAUTION

When replacing the front windshield glass of the vehicles equipped with the Head-Up Display, replace it with a windshield glass designed for the Head-Up Display operation. Otherwise, duplicated images may be displayed on the windshield glass.

Head Up Display Information



- 1 Turn By Turn navigation information (if equipped)
- 2 Road signs
- 3 Speedometer

- 4 SCC set speed information (if equipped)
- 5 SCC vehicle distance information (if equipped)
- 6 Lane Following Assist information (if equipped)
- 7 Lane Safety information (if equipped)
- 8 Blind-Spot Safety information (if equipped)
- 9 Highway Auto Speed Change information (if equipped)
- 10 Highway Driving Assist information (if equipped)
- 11 Surrounding vehicle information

* NOTICE

Road Signs and Turn By Turn navigation information are available depending on the region.

Head-Up Display Setting

On the LCD display, you can change the head up display settings as follows.

1. Display height
2. Rotation
3. Brightness
4. Content selection

* For more details, refer to "LCD display" on page 5-75.

Lighting

This vehicle is equipped with a variety of lights to appear the interior and exterior of the vehicle.

⚠ CAUTION

To prevent the battery from being discharged, do not leave the headlamp and interior light on for a prolonged time while the vehicle is not running.

Battery saver function

The purpose of this feature is to prevent the battery from being discharged if the lights are left in the ON position. The system automatically shuts off the parking lights after the vehicle is turned off and the driver's door is opened.

However, the position lamps stay ON even when the driver-side door is opened if the light switch is operated after the vehicle is turned off.

If necessary, to keep the lamps on turn the position lamps OFF and ON again using the headlamp switch on the steering column after the vehicle is turned off.

Headlamp delay function

If you place the ignition switch or EV button in the ACC or OFF position with the headlamps ON, the headlamps (and/or parking lights) remain on for about 5 minutes. However, with the vehicle is turned off if the driver's door is opened and closed, the headlamps (and/or parking lights) are turned off after 15 seconds.

The headlamps (and/or parking lights) can be turned off by pressing the lock button on the key twice or turning the light switch to the OFF or AUTO position. However, if you turn the light switch to

the AUTO position when it is dark outside, the headlamps will not be turned off.

You can activate or deactivate the Headlamp Delay function from the User Settings Mode in the LCD display. For more details, refer to "User settings mode" on page 5-78. If your vehicle is equipped with additional navigation, please refer to the user's manual provided in the infotainment system and the quick reference guide.

*** NOTICE**

If the driver exits the vehicle through another door besides the driver door, the battery saver function does not operate and the headlamp delay function does not turn OFF automatically. This may cause the battery to discharge. To avoid battery discharge, turn OFF the headlamps manually from the headlamp switch before exiting the vehicle.

Daytime Running Light (DRL)

The Daytime Running Light (DRL) can make it easier for others to see the front of your vehicle during the day.

The DRL can be helpful in many different driving conditions, and it is especially helpful after dawn and before sunset.

The DRL will turn the dedicated lamp OFF when:

- The headlamps are ON.
- The vehicle is off.
- The front fog light is on. (if equipped)
- Engaging the parking brake.

Lighting control

The light switch has a headlamp and a position lamp position.



ONQ5031032

To operate the lights, turn the knob at the end of the control lever to one of the following positions:

- 1 OFF position
- 2 Auto light position
- 3 Position & Taillamp
- 4 Headlamp position

Position & Taillamp



ONQ5031458N

When the light switch is in the position lamp position, the front position lamp, taillamp, and the license plate lamp will turn ON.

Headlamp (Low Beam)



ONQ5031459N

When the light switch is in the headlamp position, headlamp (low beam), tail, license light will turn ON.

*** NOTICE**

The ignition switch or EV button must be in the ON position to turn on the headlamps.

Auto light

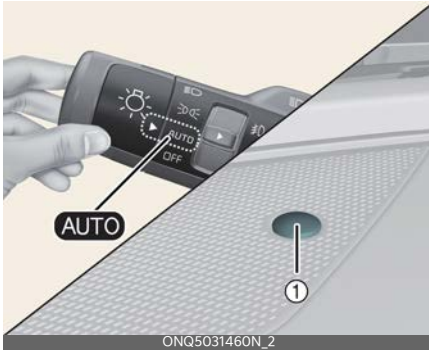

When the light switch is in the AUTO light position, the taillamps and headlamps will turn ON or OFF automatically depending on the amount of light outside the vehicle.

⚠ CAUTION

- Never place anything over the sensor (1) located on the instrument panel as this will ensure better auto-light system control.
- Don't clean the sensor using a window cleaner, the cleaner may leave a light film which could interfere with sensor operation.
- If your vehicle has window tint or other types of metallic coating on the front windshield, the Auto light system may not work properly.

Operating high beam



To turn on the high beam headlamp:

- Push the lever away from you.
The lever will return to its original position.
The high beam indicator will light when the headlamp high beams are switched on.

⚠ WARNING

High beams

Do not use high beam when there are other vehicles in front of or approaching your vehicle. Using high beam could obstruct the other driver's vision.

To flash the headlamps:

- Pull the lever towards you.



It will return to the normal (low beam) position when released. The headlamp switch does not need to be on to use this flashing feature.

Operating turn signals and lane change signals



The ignition switch or EV button must be on for the turn signals to function.

To turn on the turn signals:

- Move the lever up or down (A).
The green arrow indicators on the instrument panel indicate which turn signal is operating.

They will self-cancel after a turn is completed. If the indicator continues to flash after a turn, manually return the lever to the OFF position.

To signal a lane change:

- Move the turn signal lever slightly and hold it in position (B).
The lever will return to the OFF position when released.

If an indicator stays on and does not flash or if it flashes abnormally, one of the turn signal bulbs may be burned out and will require replacement.

One-touch lane change function

To activate a one-touch lane change function, move the turn signal lever slightly and then release it. The lane change signals will blink 3, 5 or 7 times.

You can activate or deactivate the One Touch Turn Signal function or choose the number of blinking (3, 5, or 7) by selecting "Vehicle → Lights → One Touch Turn Signal".

* NOTICE

If an indicator flash is abnormally quick or slow, a bulb may be burned out or have a poor electrical connection in the circuit. The bulb may require replacement.

* INFORMATION

The infotainment system may change after software updates. For more information, refer to the user's manual provided in the infotainment system and the quick reference guide.

Operating front fog light (if equipped)

Fog lights are designed to provide improved visibility when visibility is poor due to fog, rain or snow, etc.



The fog lights will turn on when the fog light switch (1) is turned to the on position after the headlamp is turned on.

To turn off the fog lights:

- Turn the fog light switch (1) to the ON position.

⚠ CAUTION

When in operation, the fog lights consume large amounts of vehicle electrical power. Only use the fog lights when visibility is poor.

High Beam Assist (HBA)



High Beam Assist is a function that automatically adjusts the headlamp range (switches between high beam and low beam) depending on the brightness of detected vehicles and certain road conditions.

Detecting sensor

Front view camera



The front view camera is used as a detecting sensor to detect ambient light and brightness while driving.

Refer to the picture above for the detailed location of the detecting sensor.

* NOTICE

- Always keep the front view camera in good condition to maintain optimal performance of High Beam Assist.
- For more details on the precautions of the front view camera, refer to "Forward Collision-Avoidance Assist (FCA) (Sensor Fusion)" on page 6-39.

High Beam Assist setting

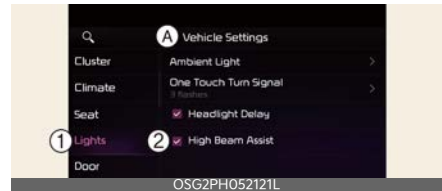
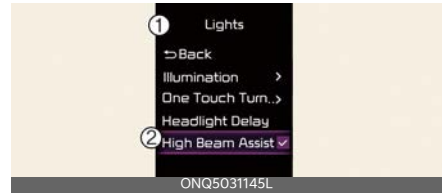

A: Vehicle Settings

1 Lights

2 High Beam Assist

With the ignition switch or EV button in the ON position, select '**Lights** → **High Beam Assist**' from the Settings menu to turn on High Beam Assist and deselect to turn off the function.

⚠ WARNING

For your safety, adjust your high beam settings only after parking the vehicle at a safe location.

High Beam Assist operation

Display and control

- After selecting '**High Beam Assist**' in the Settings menu, High Beam Assist will operate by following the procedure below.
 - Place the headlamp switch in the AUTO position and push the headlamp lever towards the instrument cluster. The High Beam Assist (AUTO) indicator light will appear on the cluster and the function will be enabled.

- When the function is enabled, high beam will turn on when vehicle speed is above 25 mph (40 km/h). When vehicle speed is below 15 mph (25 km/h), high beam will not turn on.
- The High Beam (AUTO) indicator light will appear on the cluster when high beam is on.
- When High Beam Assist is operating, if the headlamp lever or switch is used, the function operates as follows:
 - If the headlamp lever is pulled towards you when the high beam is off, the high beam will turn on without High Beam Assist canceled. When you let go of the headlamp lever, High Beam Assist will turn on again.
 - If you push the light switch towards the instrument cluster, high beam is turned on and High Beam Assist is released.
 - If the headlamp lever is pulled towards you when the high beam is on by High Beam Assist, low beam will be on and the function will turn off.
 - If the headlamp switch is placed from AUTO to another position (headlamp/position/off), High Beam Assist will turn off and the corresponding lamp will turn on.
- When High Beam Assist is operating, high beam switches to low beam if any of the following conditions occur:
 - When the headlamp of an oncoming vehicle is detected.
 - When the taillamp of a vehicle in front is detected.
 - When the headlamp or taillamp of a motorcycle or a bicycle is detected.

- When the surrounding ambient light is bright enough that high beams are not required.
- When streetlights or other lights are detected.

Malfunction and limitations

Malfunction



A: Check High Beam Assist system

When High Beam Assist is not working properly, the 'Check High Beam Assist system' warning message will appear and warning light (⚠) will appear on the cluster. Have the function inspected by an authorized Kia dealer.

Limitations

High Beam Assist may not work properly in the following situations:

- Light from a vehicle is not detected because of lamp damage, or because it is hidden from sight, etc.
- Headlamp of a vehicle is covered with dust, snow or water.
- A vehicle's headlamps are off but the fog lamps are on and etc.
- There is a lamp that has a similar shape as a vehicle's lamp.
- Headlamps have been damaged or not repaired properly.
- Headlamps are not aimed properly.
- Driving on a narrow curved road, rough road, uphill or downhill.
- Vehicle in front is partially visible on a crossroad or curved road.

- There is a traffic light, reflecting sign, flashing sign or mirror ahead.
- There is a temporary reflector or flash ahead (construction area).
- The road conditions are bad such as being wet, iced or covered with snow.
- A vehicle suddenly appears from a curve.
- The vehicle is tilted from a flat tire or is being towed.
- Light from a vehicle is not detected because of smoke, fog, snow, etc.

*** NOTICE**

- Depending on the instrument cluster specification or theme, images or colors may be displayed differently.
- For more details on the limitations of the front view camera, refer to "Forward Collision-Avoidance Assist (FCA) (Sensor Fusion)" on page 6-39.

*** NOTICE**

- At times, High Beam Assist may not work properly. The function is for your convenience only. It is the responsibility of the driver for safe driving practices and always check the road conditions for your safety.
- When High Beam Assist does not operate normally, change the head-lamp position manually between high beam and low beam.

Wipers and washers

The wipers and washers remove foreign substances from the windshield and rear window, helping to maintain visibility.

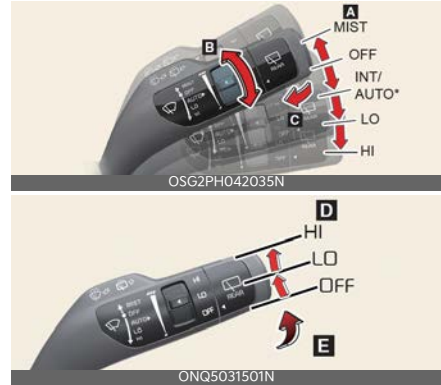

A: Wiper speed control

- MIST - Single wipe
- OFF - Off
- INT/ AUTO*: Intermittent control wipe/ Auto control wipe
- LO - Low wiper speed
- HI - High wiper speed

B: Auto control wipe time adjustment

C: Wash with brief wipes (Pull lever towards you)

D: Rear wiper/washer control

- HI - Continuous wipe
- LO - Intermittent wipe
- OFF - Off

E: Wash with brief wipes (Rear/Push lever away from you)

* : if equipped

Windshield wipers

Operate as follows when the ignition switch or EV button is ON.

- MIST: For a single wiping cycle, move the lever to this position and release it.

The wipers will operate continuously if the lever is held in this position.

- OFF: Wiper is not in operation
- INT: Wiper operates intermittently at the same wiping intervals. Use this mode in light rain or mist. To vary the speed setting, turn the speed control knob.
- LO: Normal wiper speed
- HI: Fast wiper speed

*** NOTICE**

If there is heavy accumulation of snow or ice on the windshield, defrost the windshield for about 10 minutes, or until the snow and/or ice is removed before using the windshield wipers to ensure proper operation. If you do not remove the snow and/or ice before using the wiper and washer, it may damage the wiper and washer system.

⚠ WARNING

Do not use the washer in freezing temperatures without first warming the windshield with the defrosters; the washer solution could freeze on the windshield and obscure your vision.

Auto control (if equipped)



ONQ5031041

The rain sensor (A) located on the upper end of the windshield glass senses the amount of rainfall and controls the wiping cycle for the proper interval. The more it rains, the faster the wiper oper-

ates. When the rain stops, the wiper stops.

To vary the speed setting, turn the speed control knob (B).

If the wiper switch is set in AUTO mode when the ignition switch or EV button is ON, the wiper will operate once to perform a self-check of the system. Set the wiper to OFF position when the wiper is not in use.

⚠ WARNING

When the ignition switch or EV button is ON and the windshield wiper switch is placed in the AUTO mode, use caution in the following situations to avoid any injury to the hands or other parts of the body:

- Do not touch the upper end of the windshield glass facing the rain sensor.
- Do not wipe the upper end of the windshield glass with a damp or wet cloth.
- Do not put pressure on the windshield glass.

⚠ CAUTION

- When washing the vehicle, set the wiper switch in the OFF position to stop the auto wiper operation. The wiper may operate and be damaged if the switch is set in the AUTO mode while washing the vehicle.
- Do not remove the sensor cover located on the upper end of the passenger side windshield glass. Damage to system parts could occur and may not be covered by your vehicle warranty.
- When starting the vehicle in winter, set the wiper switch in the OFF posi-

tion. Otherwise, wipers may operate and ice may damage the windshield wiper blades. Always remove all snow and ice and defrost the windshield properly prior to operating the windshield wipers.

- When tinting the windshield, be careful of any fluid getting into the sensor located in the top center of the front windshield. It may damage the related parts.

Operating windshield washers



1. Move the wiper speed control switch to the OFF position.
2. Pull the lever gently toward you to spray washer fluid on the windshield and to run the wipers 1-3 cycles. Use this function when the windshield is dirty. The spray and wiper operation will continue until you release the lever.

If the washer does not work, check the washer fluid level. If the fluid level is not sufficient, you will need to add appropriate non-abrasive windshield washer fluid to the washer reservoir.

The reservoir filler neck is located in the front of the motor compartment on the passenger side.

CAUTION

To prevent possible damage to the washer pump, do not operate the

washer when the fluid reservoir is empty.

WARNING

Do not use the washer in freezing temperatures without first warming the windshield with the defrosters; the washer solution could freeze on the windshield and obscure your vision.

CAUTION

- To prevent possible damage to the wipers or windshield, do not operate the wipers when the windshield is dry.
- To prevent damage to the wiper blades, do not use gasoline, kerosene, paint thinner, or other solvents on or near them.
- To prevent damage to the wiper arms and other components, do not attempt to move the wipers manually.
- To prevent possible damage to the wipers and washer system, use anti-freezing washer fluids in the winter season or cold weather.

Operating rear window wiper and washer switch

The rear window wiper and washer switch is located at the end of the wiper and washer switch lever.

- Turn the switch to the desired position to operate the rear wiper and washer.



- HI - Normal wiper operation
- LO - Intermittent wiper operation

- OFF - Wiper is not in operation
- Push the lever away from you to spray rear washer fluid and to run the rear wipers several times.



The spray and wiper operation will continue until you release the lever.

When the front wiper is activated and the gear is switched to R (Reverse) position, the rear wiper will be activated once to provide better visibility.

Interior lights

This vehicle is equipped with lights throughout the vehicle to illuminate the interior.

⚠ CAUTION

Do not use the interior lights for extended periods when the vehicle is off. It may cause battery discharge.

⚠ WARNING

Do not use the interior lights when driving in the dark. Accidents could happen because the view may be obscured by interior lights.

Automatic turn off function

The interior lights automatically turn off approximately 20 minutes after the EV button is turned off, if the lights are in the ON position.

If your vehicle is equipped with the theft alarm system, the interior lights automatically turn off approximately 5 seconds after the system is armed.



Map lamp

Type A



Type B



- Press the lens (1) to turn ON the map lamp.
To turn the map lamp OFF press the lens (1) again.
-  (2): DOOR mode
 - The map lamp and room lamp come on when a door is opened. The lamps go out after approximately 30 seconds.
 - The map lamp and room lamp come on for approximately 30 seconds when doors are unlocked with a smart key as long as the doors are not opened.
 - The map lamp and room lamp will stay on for approximately 20 minutes if a door is opened with the EV button in the ACC or OFF position.
 - The map lamp and room lamp will stay on continuously if the door is opened with the EV button in the ON position.
 - The map lamp and room lamp will go out immediately if the EV button is changed to the ON position or all doors are locked.
 - To turn off the DOOR mode, press the DOOR button (2) once again (not pressed).
-  (3): Press this switch to turn the front and rear room lamps on and off.

*** NOTICE**



The DOOR mode and ROOM mode can not be selected at a time.

Room lamp



Press the switch to turn the room lamp on and off.

Luggage room lamp

-  : The lamp will always turn on when the liftgate is opened/closed.
-  : The lamp is on when the liftgate is opened, and off when the liftgate is closed.
-  : The lamp will always turn off when the liftgate is opened/closed.



The luggage room lamp comes on when the liftgate is opened.



⚠ CAUTION

The luggage room lamp comes on as long as the liftgate opens. To prevent unnecessary charging system drain, close the liftgate securely after using the luggage room.

Vanity mirror lamp



Push the switch to turn the light on or off.

- : The lamp will turn on if this button is pressed.
- : The lamp will turn off if this button is pressed.

CAUTION

Vanity mirror lamp

Always close the lid of the vanity mirror in the off position when the vanity mirror lamp is not in use. If the sun visor is closed without the lamp off, it may discharge the battery or damage the sun visor.

Glove box lamp



The glove box lamp comes on when the glove box is opened.

* NOTICE

To prevent unnecessary charging system drain, close the glove box securely after using the glove box.

Welcome system (if equipped)

The welcome system is a function that illuminates the surroundings or the interior when the driver approaches or exits the vehicle.

Door handle lamp (if equipped)



When all the doors (and liftgate) are closed and locked, the door handle lamp will come on for about 15 seconds if any of the below is performed.

- When the door unlock button is pressed on the smart key.
- When the button of the outside door handle is pressed.
- When the vehicle is approached with the smart key in possession.

Headlamp (headlamp) escort function

The headlamps (and/or taillamps) remain on for approximately 5 minutes after the ignition key is removed or turned to the ACC or LOCK position. However, if the driver's door is opened and closed, the headlamps are turned off after 15 seconds.

The headlamps can be turned off by pressing the lock button on the transmitter or smart key twice or turning off the light switch from the headlamp or Auto light position.

Interior light

When the interior light switch is in the DOOR position and all doors (and lift-gate) are locked and closed, the room lamp will come on for 30 seconds if any of the following occurs:

- With the smart key system
 - When the door unlock button is pressed on the smart key.
 - When the button of the outside door handle is pressed.

At this time, if you press the door lock button, the lamps will turn off immediately.

Defroster

The vehicle is equipped with a defroster for removing frost or fog from the rear window.

⚠ CAUTION

Conductors

To prevent damage to the conductors bonded to the inside surface of the rear window, never use sharp instruments or window cleaners containing abrasives to clean the window.

If you want to defrost and defog the front windshield, refer to "Windshield defrosting and defogging" on page 5-120.

Operating rear window defroster

The defroster heats the window to remove frost, fog and thin ice from the rear window, while the vehicle is on.

If there is heavy accumulation of snow on the rear window, brush it off before operating the rear defroster.



To activate the rear window defroster:

- Press the rear window defroster button located in the center fascia switch panel.

The indicator on the rear window defroster button appears when the defroster is ON.

The rear window defroster automatically turns off after approximately 20 minutes or when the EV button is turned off.

To turn off the defroster:

- Press the rear window defroster button again.

Outside mirror defroster (if equipped)

If your vehicle is equipped with the outside rearview mirror defrosters, they will operate at the same time you turn on the rear window defroster.

Automatic climate control system



OCV041312N

- 1 Driver's temperature control knob
- 2 Passenger's temperature control knob
- 3 AUTO (automatic control) button
- 4 OFF button
- 5 Fan speed control button
- 6 Mode selection button
- 7 Front windshield defroster button
- 8 Rear window defroster button
- 9 SYNC button
- 10 Air intake control button
- 11 Air conditioning (A/C) button
- 12 DRIVER ONLY select button
- 13 HEAT button
- 14 Infotainment/climate control mode switching button

* NOTICE

Operating the blower when the EV button is in the OFF position could cause the battery to discharge. Operate the blower when the vehicle is in ON position.

Using the infotainment/climate switchable controller

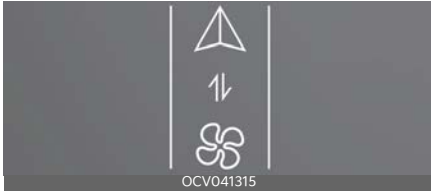

Press the button on the switchable controller to switch between infotainment system or climate control panel.

Press and hold the button to select the default mode for the control panel.

Switching between panels

Infotainment control panel



Climate control panel



Press the button on the switchable controller to select the desired control panel.

The selected control panel icon will appear and the control panel will be changed.

- The knob display will appear according to the selected control panel mode.

- When the vehicle is in the ACC position, only the infotainment system will be activated.

Setting the default mode



Press and hold the button to select the default mode for the control panel.

- After the setting, the control panel will return to the default mode after a certain period of time even if the control panel is switched to the different mode.
- If the mode is set to 'OFF', the control panel will display the mode used recently.

Heating and air conditioning automatically

1. Press the AUTO button.

The modes, fan speeds, air intake and air-conditioning will be controlled automatically by setting the temperature.



- Turn the temperature control switch to the desired temperature.



*** NOTICE**

Do not place anything over the sensor located on the instrument panel to ensure better control of the heating and cooling system.

- To turn the automatic operation off, select any button or switch of the following:
 - Mode selection button
 - Air conditioning button
 - Front windshield defroster button (Press the button one more time to deselect the front windshield defroster function. The 'AUTO' sign will appear on the information display once again.)
 - Air intake control button
 - Fan speed control switch

The selected function will be controlled manually while other functions operate automatically.
- For your convenience and to improve the effectiveness of the climate control, use the AUTO button and set the temperature to 72 °F (22 °C).



Level	Indicator	LCD Display	Air flow
High			2~8
Medium			1~6
Low			1~4

Heating and air conditioning manually

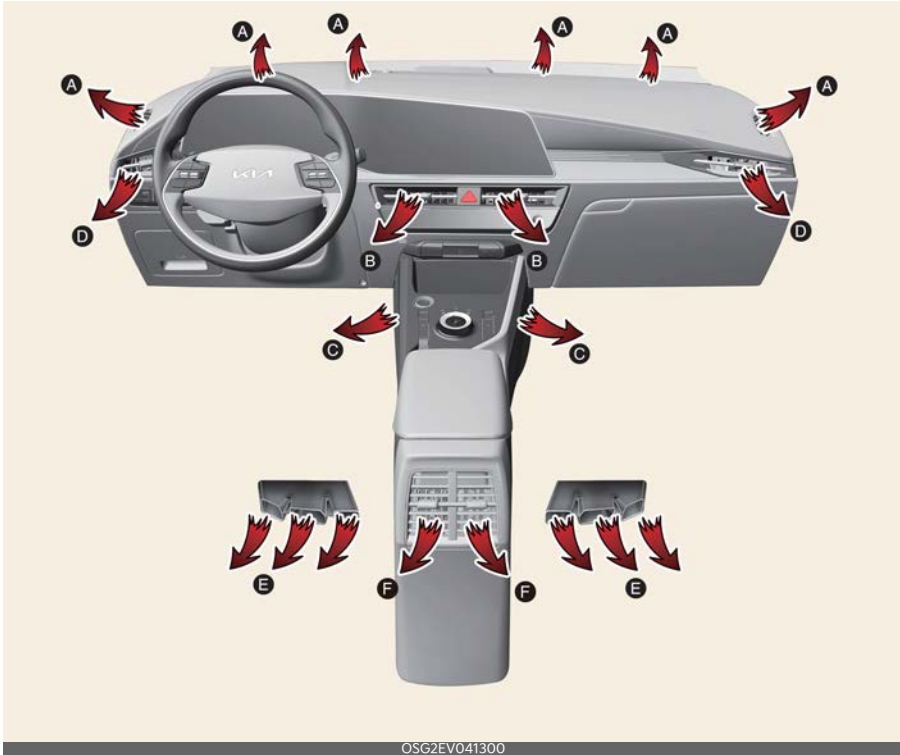
The heating and cooling system can be controlled manually by pressing buttons or turning knob(s) other than the AUTO button.



In this case, the system works sequentially according to the order of buttons or knob(s) selected.

1. Start the vehicle.
2. Set the mode to the desired position.
 - For improving the effectiveness of heating and cooling;
 - Heating: 
 - Cooling: 
3. Set the temperature control to the desired position.
4. Set the air intake control to the outside (fresh) air position.
5. Set the fan speed control to the desired speed.

If air conditioning is desired, turn the air conditioning system on.

Press the AUTO button in order to convert to full automatic control of the system.

Mode selection

The mode selection button controls the direction of the air flow through the ventilation system.



The air flow outlet port is directed as follows:



Face-Level (B, D, F)

Air flow is directed toward the upper body and face. Additionally, each outlet can be controlled to direct the air discharged from the outlet.



Bi-Level (B, C, D, E, F)

Air flow is directed towards the face and the floor.



Floor-Level (A, C, D, E)

Most of the air flow is directed to the floor, with a small amount of the air being directed to the windshield and side window defrosters.



Floor/Defrost-Level (A, C, D, E)

Most of the air flow is directed to the floor and the windshield with a small amount directed to the side window defrosters.

Instrument panel vents

Front/Center (if equipped)

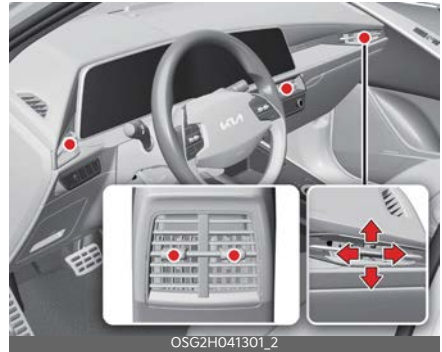

The outlet vents can be opened or closed by moving the vent left or right. Also, you can adjust the direction of air delivery from these vents using the vent control lever as shown.

Temperature control



The temperature will increase to the maximum (HI) by turning the knob to the extreme right.

The temperature will decrease to the minimum (LO) by turning the knob to the extreme left.

When turning the knob, the temperature will increase or decrease by 1 °F/0.5 °C. When set to the lowest temperature setting, the air conditioning will operate continuously.

* NOTICE

When starting the vehicle in cold weather using manual temperature con-

trol, operate the system in the following method to improve heating.

- Turn off or lower the blower, right after starting the vehicle.
- Allow the vehicle to warm up during this time since the air flow from the heater is still cold.
- After a few minutes of vehicle warm up, turn on or set the fan to a higher level and adjust the temperature setting to hot.

Temperature conversion

You can switch the temperature mode from Centigrade to Fahrenheit as follows:

Go to **Setup** → **Units** → **Temperature** on the infotainment system.

* INFORMATION

The infotainment system may change after software updates. For more information, refer to the user's manual provided in the infotainment system and the quick reference guide.

Controlling air intake

This is used to select the outside (fresh) air position or recirculated air position.



To change the air intake control position:

- Push the control button.

Outside (fresh) air position



With the outside (fresh) air position selected, air enters the vehicle from outside and is heated or cooled according to the function selected. The indicator light will turn off.

Recirculated air position



With the recirculated air position selected, air from the passenger compartment will be drawn through the heating system and heated or cooled according to the function selected.

Prolonged operation of the heater in the recirculated air position (without air conditioning selected) may cause fogging of the windshield and side windows and the air within the passenger compartment may become stale.

In addition, prolonged use of the air conditioning with the recirculated air position selected will result in excessively dry air in the passenger compartment.

* NOTICE

Operating the system primarily in Fresh mode is recommended. Use Recirculation mode temporarily only when needed. Prolonged operation of the

heater in Recirculation mode and without the air conditioning ON can cause fogging of the windshield. In addition, prolonged use of the air conditioning ON in Recirculation mode may result in excessively dry, dehumidified air in the cabin and may promote formation of musty vent odor due to stagnant air.

Controlling fan speed

The fan speed can be set to the desired speed by operating the fan speed control switch.

To change the fan speed:

- Press right for higher speed, or press left for lower speed.



- To turn the fan speed control off, press the OFF knob.

Air conditioning



- Press the A/C button to turn the air conditioning system on (indicator light will appear).
- Press the button again to turn the air conditioning system off.

⚠ WARNING

Reduced Visibility

Continuous use of the climate control system in the recirculated air position may allow humidity to increase inside the vehicle, which may fog the glass and obscure visibility.

⚠ WARNING

Recirculated Air

Continued use of the climate control system in the recirculated air position can cause drowsiness or sleepiness, and loss of vehicle control. Set the air intake control to the outside (fresh) air position as much as possible while driving.

⚠ WARNING

Sleeping with A/C on

Do not sleep in a vehicle with the air conditioning or heating on, as this may cause serious harm or death due to a drop in the oxygen level and/or body temperature.

* NOTICE

Operating the fan when the EV button is in the OFF position could cause the battery to discharge. Operate the fan when the vehicle is running.

Turning heating on or off



- Electric vehicle uses a PTC heater to control the heating of the vehicle.

- If you press the button manually to turn off the function, only the ventilation function works.
- To turn on the PTC heater when the HEAT button indicator is OFF, press the HEAT button (indicator ON) and set the desired temperature.

* PTC: Positive Temperature Coefficient

The air conditioner and heater uses energy from the battery. If you use the heater or air conditioner for too long, distance to empty can be reduced due to increased power consumption.

Turn off the heater or air conditioner if not necessary.

Air conditioning for driver only

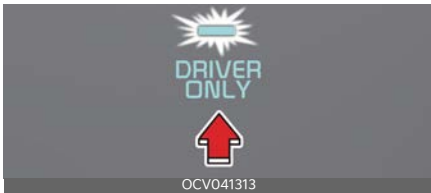

- Press the DRIVER ONLY button and the indicator light appears, cold air mostly blows in the direction of the driver's seat.

However, some of the cold air may come out of other seats' ducts to keep indoor air pleasant.

Turning off the front air climate control



- Press the OFF knob to turn off the front air climate control system.

However, you can still operate the air intake buttons as long as the EV button is in the ON position.

System operation

Ventilation

1. Set the mode to the (☞) position.
2. Set the air intake control to the outside (fresh) air position.
3. Set the temperature control to the desired position.
4. Set the fan speed control to the desired speed.

Heating

1. Set the mode to the (☞) position.
2. Set the air intake control to the outside (fresh) air position.
3. Set the temperature control to the desired position.
4. Set the fan speed control to the desired speed.
5. If dehumidified heating is desired, turn the air conditioning system (if equipped) on.
 - If the windshield fogs up, set the mode to the (☞) or (☞) position.

Heating operation tips

- To keep dust or unpleasant fumes from entering the vehicle through the ventilation system, temporarily set the air intake control to the recirculated air position. Be sure to return the control to the fresh air position when the irritation has passed to keep fresh air in the vehicle. This will help keep the driver alert and comfortable.
- Air for the heating/cooling system is drawn in through the grilles just ahead of the windshield. Care should be taken that these are not blocked

by leaves, snow, ice or other obstructions.

- To prevent interior fog on the windshield, set the air intake control to the fresh air position and fan speed to the desired position, turn on the air conditioning system, and adjust the temperature control to desired temperature.

Air conditioning

All Kia air conditioning systems are filled with R-1234yf refrigerant.

1. Start the vehicle. Press the air conditioning button.
2. Set the mode to the (↺) position.
3. Set the air intake control to the outside-air or recirculated air position.
4. Adjust the fan speed control and temperature control to maintain maximum comfort.
 - When maximum cooling is desired, set the temperature control to the extreme left position, then set the fan speed control to the highest speed.

⚠ CAUTION

- The refrigerant system should only be serviced by trained and certified technicians to insure proper and safe operation.
- The refrigerant system should be serviced in a well-ventilated place.
- The air conditioning evaporator (cooling coil) shall never be repaired or replaced with one removed from a used or salvaged vehicle and new replacement MAC evaporators shall be certified (and labeled) as meeting SAE Standard J2842.

⚠ CAUTION

- When using the air conditioning system, monitor the temperature gauge closely while driving up hills or in heavy traffic when outside temperatures are high. Air conditioning system operation may cause vehicle overheating. Continue to use the blower fan but turn the air conditioning system off if the temperature gauge indicates vehicle overheating.
- When opening the windows in humid weather, air conditioning may create water droplets inside the vehicle. Since excessive water droplets may cause damage to electrical equipment, air conditioning should only be used with the windows closed.

Air conditioning operation tips

- If the vehicle has been parked in direct sunlight during hot weather, open the windows for a short time to let the hot air inside the vehicle escape.
- To help reduce moisture inside of the windows on rainy or humid days, decrease the humidity inside the vehicle by operating the air conditioning system.
- During air conditioning system operation, you may occasionally notice a slight change in vehicle speed as the air conditioning compressor cycles. This is a normal system operation characteristic.
- Use the air conditioning system at least every month only for a few minutes to ensure maximum system performance.
- When using the air conditioning system, you may notice clear water drip-

ping (or even puddling) on the ground under the passenger side of the vehicle. This is a normal system operation characteristic.

- Operating the air conditioning system in the recirculated air position provides maximum cooling; however, continual operation in this mode may cause the air inside the vehicle to become stale.
- During cooling operation, you may occasionally notice a misty air flow because of rapid cooling and humid air intake. This is a normal system operation characteristic.

Climate control air filter

The climate control air filter installed inside the motor room compartment filters the dust or other pollutants that come into the vehicle from the outside through the heating and air conditioning system.

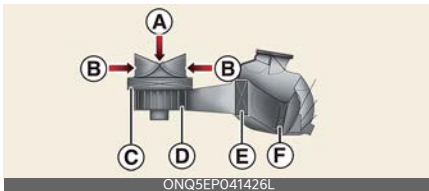

- A: Outside air
- B: Recirculated air
- C: Climate control air filter
- D: Blower
- E: Evaporator core
- F: Heater core

If dust or other pollutants accumulate in the filter over a period of time, the air flow from the air vents may decrease, resulting in moisture accumulation on the inside of the windshield even when the outside (fresh) air position is selected. If this happens, have the cli-

mate control air filter replaced by an authorized Kia dealer.

* NOTICE

- Replace the filter every 15,000 miles (20,000 km) or once a year. If the vehicle is being driven in severe conditions, such as dusty or rough roads, more frequent air conditioner filter inspections and changes are required.
- When the air flow rate suddenly decreases, the system should be checked at an authorized Kia dealer.

Air conditioning refrigerant label

Example



* The actual Air Conditioning refrigerant label in the vehicle may differ from the illustration.

Each symbol and specification on the air conditioning refrigerant label is represented below:

- 1 Classification of refrigerant
- 2 Amount of refrigerant
- 3 Classification of Compressor lubricant
- 4 Caution
- 5 Flammable Refrigerant
- 6 Requires Registered Technician to Service Air Conditioning system

You can find out which air conditioning refrigerant is applied to your vehicle on the label inside of the motor room compartment.

Refer to "Refrigerant label" on page 9-8 for more detail on the location of air conditioning refrigerant label.



⚠ CAUTION

It is important that the correct type and amount of oil and refrigerant is used, otherwise damage to the vehicle may occur. To prevent damage, the air conditioning system in your vehicle should only be serviced by trained and certified technicians.

Checking the amount of air conditioner refrigerant and compressor lubricant

When the amount of refrigerant is low, the performance of the air conditioning is reduced. Overfilling also has a negative impact on the air conditioning system.

Therefore, if abnormal operation is found, have the system inspected by an authorized Kia dealer.

⚠ WARNING

The oil and refrigerant in your vehicle's air conditioning system is under very high pressure. If proper service procedures are not followed an explosion may result. To reduce the risk of serious injury or death, the air conditioning system in your vehicle should only be serviced by trained and certified technicians.

⚠ WARNING

Vehicles equipped with R-1234yf



Since the refrigerant is mildly flammable and operated at high pressure, the air conditioning system should only be serviced by trained and certified technicians. (Refer to the SAE J2845)

It is important that the correct type and amount of oil and refrigerant are used. All refrigerants should be reclaimed with proper equipment. Venting refrigerants directly to the atmosphere is harmful to individuals and environment.

Failure to heed these warnings can lead to serious injuries.

Windshield defrosting and defogging

When the windshield is covered with frost or moisture, the front view is blurred, you should remove the frost and moisture.

⚠ WARNING

Windshield Heating

Do not use the (☀️) or (🌬️) position during cooling operation in extremely humid weather. The difference between the temperature of the outside air and the windshield could cause the outer surface of the windshield to fog up, causing loss of visibility. In this case, set the mode selection to the (🌬️) position and fan speed control to the lower speed.

- For maximum defrosting, set the temperature control to the extreme right/hot position and the fan speed control to the highest speed.
- If warm air to the floor is desired while defrosting or defogging, set the mode to the floor-defrost position.
- Before driving, clear all snow and ice from the windshield, rear window, outside rear view mirrors, and all side windows.
- Clear all snow and ice from the hood and air inlet in the cowl grill to improve heater and defroster efficiency and to reduce the probability of fogging up the inside of the windshield.

Defrosting outside windshield with automatic climate control

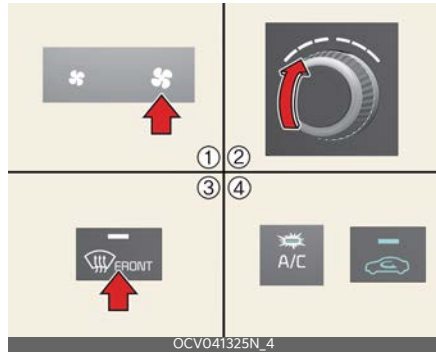

1. Set the fan speed to the highest position.
2. Set the temperature to the extreme hot (HI) position.
3. Press the defroster button (🌬️).
4. The outside (fresh) air position will be selected automatically and the air conditioning will turn on according to the detected ambient temperature.

Defogging inside windshield with automatic climate control

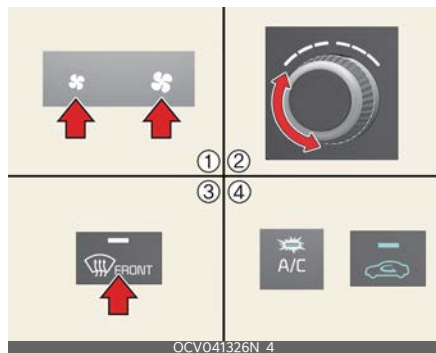

1. Set the fan speed to the desired position.
2. Select desired temperature.
3. Press the defroster button (🌬️).

4. The outside (fresh) air position will be selected automatically and the air conditioning will turn on according to the detected ambient temperature.

If the air conditioning and outside (fresh) air position are not selected automatically, adjust the corresponding button manually. If the (☼) position is selected, lower fan speed is adjusted to a higher fan speed.

Defogging logic (if equipped)

To reduce the possibility of fogging up the inside of the windshield, the air intake or air conditioning is controlled automatically according to certain conditions such as (☼) or (☼) position.

To cancel automatic defogging logic or return to the automatic defogging logic, do the following.

Turning the defogging logic on or off

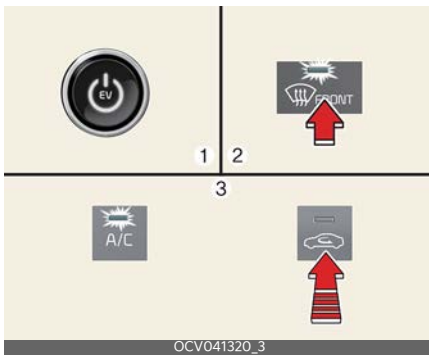

1. Turn the EV button to the ON position.
2. Press the defroster button (☼).
3. While pressing the air conditioning button (A/C), press the air intake control button at least 5 times within 3 seconds.

The recirculation indicator blinks 3 times in 0.5 second of intervals. It indicates

that the defogging logic is canceled or returned to the programmed status. If the battery has been discharged or disconnected, it resets to the defog logic status.

Auto Defogging System (ADS)

Auto defogging reduces the probability of fogging up the inside of the windshield by automatically sensing the moisture of inside the windshield.



The auto defogging system operates when the heater or air conditioning is on.

The indicator appears when the auto defogging system senses the moisture on the inside of the windshield and operates.

Select '**Climate → Defog/Defrost options → Auto defog**' from the Settings menu.

The auto defogging system addresses excess moisture on the inside of the windshield in stages. For example if auto defogging does not defog inside the windshield at step • Outside air position, it tries to defog again at step • Operating the air conditioning.

- Outside air position
- Operating the air conditioning
- Increasing air flow toward the windshield
- Blowing air flow toward the windshield

Turning the auto defogging system on or off

- Press the front windshield defroster button for 3 seconds when the EV button is in the ON position.

When the ADS system is canceled, the defroster button indicator will blink 3 times per 0.5 sec.

When the ADS system is reset, the defroster button indicator will blink 6 times per 0.25 sec.

⚠ CAUTION

Do not remove the sensor cover located on the upper end of the passenger side windshield glass. Damage to the system parts could occur and may not be covered by your vehicle warranty.

Automatic ventilation

The system automatically selects the outside (fresh) air position when the climate control system operates over a certain period of time (5 minutes) in low temperature with the recirculated air position selected.

To cancel or reset the Automatic Ventilation

When the air conditioning system is on, select Face Level (↔) mode and press the recirculated air position button more than five times within 3 seconds while pressing A/C button.

When the automatic ventilation is canceled, the indicator blinks 3 times. When the automatic ventilation is activated, the indicator blinks 6 times.

Smart ventilation (if equipped)

The smart ventilation system maintains pleasant/fresh air conditioning inside the passenger compartment by automati-

cally detecting/controlling the temperature and humidity level, when you drive the vehicle with the climate control system in OFF position. When the smart ventilation system starts to operate, the message appears for approximately 5 seconds.

The smart ventilation system stops when:

- OFF button is selected.
- Any of the buttons of the climate control is selected for operation.

* NOTICE

The smart ventilation system may not operate when the vehicle is driven at low speed.

A/C Automatic Drying (if equipped)

A/C Automatic Drying feature dries the moisture in the air conditioner and reduces air conditioner odor. The blower motor automatically operates after 30 minutes the vehicle is turned off.

Turning A/C Automatic Drying on or off

The A/C Automatic Drying feature can be turned on and off by selecting **Setup** → **Climate** → **Climate Features** → **A/C Automatic Drying** from the infotainment system.

If the operating condition is satisfied, a message **Air Conditioning Automatic Drying will start in 30 minutes** will be displayed on the infotainment/climate switchable controller screen and then the blower motor will automatically operate on schedule.

When the A/C Automatic Drying feature is activated, the air conditioner sets the

fan speed to the third level, selects Fresh mode, and directs the air flow to the floor.

* INFORMATION

The infotainment system may change after software updates. For more information, refer to the user's manual provided in the infotainment system and the quick reference guide.

Operating conditions

The A/C Automatic Drying feature operates under the following conditions:

- The vehicle is turned off after operating the air conditioner for a certain period
- The 12-volt battery level is sufficient
- The outside temperature is above a certain level

Non-operating conditions

The A/C Automatic Drying feature stops operating under the following conditions:

- The A/C Automatic Drying feature has operated for 3 minutes
- The EV button is pressed, or the vehicle is ON
- The climate control system is operated remotely

* NOTICE

- The A/C Automatic Drying feature reduces air conditioner odors but may not remove all odors.
- The A/C Automatic Drying feature does not operate if the remaining battery level is insufficient to prevent battery discharge.

Storage compartment

These compartments can be used to store small items required by the driver or passengers.

- To avoid possible theft, do not leave valuables in the storage compartment.
- Always keep the storage compartment covers closed while driving. Do not attempt to place so many items in the storage compartment that the storage compartment cover cannot close securely.

⚠ WARNING

Flammable materials

Do not store glasses, gas lighter, portable battery, canned beverage, spray can, propane cylinder, cosmetic tube or other flammable/explosive materials in the vehicle. These items may catch fire and/or explode if the vehicle is exposed to hot temperatures for extended periods.

Center console storage



To open the center console storage:

- Pull up the lever.

Glove box



To open the glove box:

- Push the lever and the glove box will automatically open.

Close the glove box after use.

⚠ WARNING

Glove box

To reduce the risk of injury in an accident or sudden stop, always keep the glove box door closed while driving.

An open glove box door can cause serious injury to the passenger in an accident, even if the passenger is wearing a seat belt.

⚠ CAUTION

Do not keep food in the glove box for a long time.

* NOTICE

If the temperature control switch is in the warm or hot position, warm or hot air will flow into the glove box.

Interior features

There are various features inside the vehicle for the convenience of the occupants.

Ambient lights (if equipped)



The ambient lights are applied to the front crash pad and the center console.

When the headlamp light is on, the ambient light is on at the same time could be set in the infotainment menu.

* INFORMATION

The infotainment system may change after software updates. For more information, refer to the user's manual provided in the infotainment system and the quick reference guide.

Cup holder (if equipped)



Cups or small beverage cans may be placed in the cup holders.

⚠ WARNING

Hot liquids

Do not place uncovered cups with hot liquid in the cup holder while the vehicle is in motion. If the hot liquid spills, you may burn yourself. Such a burn to the

driver could lead to loss of control of the vehicle.

⚠ WARNING

Keep cans or bottles out of direct sun light and do not put them in a vehicle that is heated up. It may explode.

⚠ CAUTION

- Keep your drinks sealed while driving to prevent spilling your drink. If liquid spills, it may get into the vehicle's electrical/electronic system and damage electrical/electronic parts.
- When cleaning spilled liquids, do not use heat to dry the cup holders. This may damage the cup holder.

Seat warmer (if equipped)

The seat warmer is provided to warm the front seats during cold weather.



OSG2PH042046N_2

With the ignition switch or EV button in the ON position:

- Push either of the buttons to warm the front and rear seats.

During mild weather or under conditions where the operation of the seat warmer is not needed, keep the buttons in the "OFF" position.

The seat warmer defaults to the OFF position whenever the ignition switch or EV button is turned on.

Temperature control (Manual)

- Each time you press the buttons, the temperature setting of the seat will change as follows:
 - Front seat

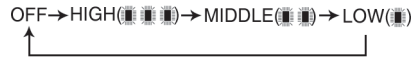

- Rear seat

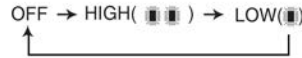

Temperature control (Automatic)

The seat warmer starts to automatically control the seat temperature in order to prevent low-temperature burns after being manually turned ON.

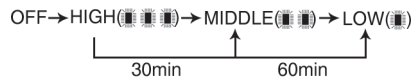

* Rear seats have no middle level.

You may manually press the button to increase the seat temperature. However, it soon returns to the automatic mode again.

- When pressing the buttons for more than 1.5 seconds with the seat warmer operating, the seat warmer will turn OFF.

*** NOTICE**

With the seat warmer buttons in the ON position, the heating system in the seat

turns off or on automatically depending on the seat temperature.

CAUTION

- When cleaning the seats, do not use an organic solvent such as paint thinner, benzene, alcohol and gasoline. Doing so may damage the surface of the heater or seats.
- To prevent overheating the seat warmer, do not place anything on the seats that insulates against heat, such as blankets, cushions or seat covers while the seat warmer is in operation.
- Do not place heavy or sharp objects on seats equipped with seat warmers. Damage to the seat warming components could occur.
- Do not change the seat cover. It may damage the seat warmer or air ventilation system.

WARNING

Seat warmer burns

Passengers should use extreme caution when using seat warmers due to the possibility of excess heating or burns. The seat warmer may cause burns even at low temperatures, especially if used for long periods of time. In particular, the driver must exercise extreme care for the following types of passengers:

1. Infants, children, elderly or handicapped persons, or hospital outpatients
2. Persons with sensitive skin, those unable to detect heat or pain in parts of the body that are next to the heaters, or those that burn easily
3. Fatigued individuals
4. Intoxicated individuals

5. Individuals taking medication that can cause drowsiness or sleepiness (sleeping pills, cold tablets, etc.)

Air ventilation seat (if equipped)



The temperature setting of the seat changes according to the buttons position.

- To ventilate front seats cushion, push the buttons.

Each time you push the buttons, the airflow will change as follows:

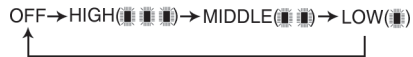

The seat warmer (with air ventilation) defaults to the OFF position whenever the EV button is turned on.

CAUTION

Seat damage

- When cleaning the seats, do not use an organic solvent such as paint thinner, benzene, alcohol and gasoline. Doing so may damage the air ventilation seat.
- Do not place heavy or sharp objects on the seat. Those things may damage the air ventilation seat.
- Be careful not to spill liquid such as water or beverages on the seat. If you spill some liquid, wipe the seat with a dry towel. Before using the air ventilation seat, dry the seat completely.

Sun visor

Use the sun visor to shield direct light through the front or side windows.



The actual sun visor lamp in the vehicle may differ from the illustration.

- To use the sun visor, pull it downward.
- To use the sun visor for the side window, pull it downward, unsnap it from the bracket (1) and swing it to the side (2).
- To use the vanity mirror, pull down the visor and slide the mirror cover (4). Adjust the sun visor extension forward or backward (3) (if equipped). The ticket holder (5) is provided for holding a tollgate ticket.

⚠ WARNING

For your safety, do not block your view when using the sun visor.

*** NOTICE**

Do not put several tickets in the ticket holder at one time. This could cause damage to the ticket holder.

USB charger

The USB car charger allows drivers to charge their digital devices such as smart phones, and PC tablets.

Front



Plug the cable into the USB port, and charging will begin.

The USB car charger is available with either the ACC on or the ignition on. We recommend you connect the USB port and digital devices with the vehicle running. See the display screen of the device to check its charging process completion. Your smart phone or table PC could get heated up while charging. This is no reason to worry, as it doesn't impact life or functions of the device. For safety, charging can be stopped if the battery gets too high where the temperature can negatively affect the device. Charging some digital devices is not available or requires special dedicated adapters if their charging methods don't fit the way the USB car charger works.

Power Delivery 3.0 is available on the smart phone or the tablet equipped with fast charging capabilities. It is applicable to digital devices with USB C-type.

Charging speed is determined according to the charging specification of the connected digital device.

Rated output:

- Digital device with fast charging :
 - 9.0V / Max 3.0A

- Digital devices with normal charging:
 - 5.0V / Max 3.0A

⚠ CAUTION

- Use the USB car charger with the ignition on. Otherwise, Vehicle battery can be discharged.
- Use the official USB cable of the manufacturer of the digital device to be charged.
- Make sure that any foreign object, drinks, and water do not come into contact with the USB car charger. Water or foreign object can damage the USB charger.
- Do not use devices that exceed current consumption of 2.1 A.
- Do not connect an electrical device that generates excessive electromagnetic noise to the USB car port. If you do so, noise can be caused or vehicle electronic devices can be interrupted while audio or AV is on.
- If the charger is connected incorrectly, it can cause serious damage to the device. Please note that damages due to incorrect usage are not covered by warranty service.

AC inverter (if equipped)



The AC inverter supplies 115V/150W electric power to operate electric accessories or equipment. If you wish to use the AC inverter, open up the AC inverter cover and connect a plug to it. The AC

inverter supplies electric power when vehicle is running.

*** NOTICE**

- Rated voltage: AC 115V
- Maximum electric power: 150W
- In order to avoid an electrical system failure, electric shock, etc., be sure to read owner's manual before use.
- Be sure to close the cover except for when in use.
- To prevent the battery from being discharged, do not use the AC inverter while the vehicle is not running.
- After using an electric accessory or equipment, pull the plug out. Leaving the accessory or equipment plugged in for a long time may cause battery discharge.
- Do not use an electric accessory or equipment the power consumption of which is greater than 150W (115V).
- When the AC inverter input voltage is less than 11.3V, automatically turn off the power. AC inverter will operate as normal when the voltage is increased.
- When the AC inverter input voltage is less than 10.7V, power will turn off. The AC inverter will operate as normal when the voltage is increased.
- While the power consumption of some electrical devices/appliances may be within the AC inverter's electric power range, it may malfunction in below cases.
 - If the device/appliance requires high electric power for initial start up
 - If the device/appliance processes precise/very accurate data
 - If the device/appliance requires very stable supply of electricity

⚠ CAUTION**Electric accessory devices**

- Do not use broken electric accessories which may damage the AC inverter and electrical systems of the vehicle.
- Do not use two or more electric accessories at the same time. It may cause damage to the electrical systems of the vehicle.

Power outlet

The power outlet is designed to provide power for mobile telephones or other devices designed to operate with vehicle electrical systems or other devices that are compatible with the power outlet and vehicle electrical system.



The devices should draw less than 15 amps with the vehicle on.

*** NOTICE**

- Use the power outlet only when the vehicle is on and remove the accessory plug after use. Using the accessory plug for prolonged periods of time with the vehicle off could cause the battery to discharge.
- Only use 12 V electric accessories which are less than 15 A in electric capacity.
- Adjust the air-conditioner or heater to the lowest operating level when using the power outlet.
- Close the cover when not in use.

- Some electronic devices can cause electronic interference when plugged into a vehicle's power outlet. These devices may cause excessive audio static and malfunctions in other electronic systems or devices used in your vehicle.
- Push the plug in as far as it will go. If good contact is not made, the plug may overheat and the fuse may open.
- Plug in battery equipped electronic devices with reverse current protection. The current from the battery may flow into the vehicle's electrical/electronic system and cause system malfunction.

⚠ WARNING**Electric shock**

Do not put a finger or a foreign object (pen, etc.) into a power outlet and do not touch with a wet hand. You may get an electric shock.

Wireless smart phone charging system (if equipped)

A wireless smart phone charging system is located in front of the center console.



[A]: Indicator, [B]: Charging pad

Firmly close all doors, and make sure to turn ON the EV button. To start wireless charging, place the smart phone equipped with wireless charging function on the wireless charging pad.

For best wireless charging results, place the smart phone on the center of the charging pad.

The wireless charging system is designed for one smart phone equipped with Qi only. Please refer to the smart phone accessory cover or the smart phone manufacturer homepage to check whether your smart phone supports Qi function.

WARNING

If any metallic object such as coins is located between the wireless charging system and the smart phone, the charging may be disrupted. Also, the metallic object may heat up.

Wireless smart phone charging

1. Remove any object on the smart phone charging pad including the smart key. If there is any foreign object on the pad other than a smart phone, the wireless charging function may not operate properly.
2. Place the smart phone on the center of the wireless charging pad.
3. The indicator light is orange when the smart phone is charging. The indicator light will turn Green when phone charging is complete.
4. You can choose to turn the wireless charging function to either ON or OFF by selecting the USM on the instrument cluster. Found in "Vehicle → Convenience → Wireless Charging System". (Please refer to "Instrument cluster" on page 5-68 for details).

INFORMATION

The infotainment system may change after software updates. For more information, refer to the user's manual pro-

vided in the infotainment system and the quick reference guide.

If the wireless charging does not work, gently move your smart phone around the pad until the charging indicator light turns yellow. Depending on the smart phone, the charging indicator light may not turn green even after the charging is complete.

If the wireless charging is not functioning properly, the orange light will blink and flash for ten seconds then turn off. In such cases, remove the smart phone from the pad and replace it on the pad again, or double check the charging status.

If you leave the smart phone on the charging pad when the vehicle ignition is in OFF, the vehicle will alert you through warning messages and sound (applicable for vehicles with voice guidance function) after the 'Good bye' function on the instrument cluster ends.

For some manufacturers' smart phones, the system may not warn you even though the smart phone is left on the wireless charging unit. This is due to the particular characteristic of the smart phone and not a malfunction of the wireless charging.

WARNING

Distracted driving

Driving while distracted can result in a loss of vehicle control that may lead to an accident, severe bodily injury or death. The driver's primary responsibility is in the safe and legal operation of a vehicle. Any use of handheld devices, other equipment, or vehicle systems that take the driver's eyes, attention, and focus away from the safe operation of a vehicle are not permissible by law.

These should never be used during the operation of the vehicle.

⚠ CAUTION

Liquid in wireless charging system

To prevent liquid from damaging the wireless smart phone charging system in your vehicle, be sure not to spill liquid over the charging system.

⚠ CAUTION

Metal in wireless charging system

If any metallic object such as a coin is located between the wireless charging system and the smart phone, the charging may be disrupted. Also, the metallic object may heat up and potentially damage the charging system. If there is any metallic object between the smart phone and the charging pad, immediately remove the smart phone. Remove the metallic object after it has cooled down.

⚠ CAUTION

- When the interior temperature of the wireless charging system rises above a set temperature, the wireless charging will cease to function. After the interior temperature drops below the threshold, the wireless charging function will resume.
- The wireless charging may not function properly when there is a heavy accessory cover on the smart phone.
- The wireless charging will stop when using the wireless smart key search function to prevent radio wave disruption.
- The wireless charging will stop when the smart key is moved out of the vehicle with the vehicle in ON.
- The wireless charging will stop when any of the doors are opened (applicable for vehicles equipped with smart keys).
- The wireless charging will stop when the smart phone is not in complete contact with the wireless charging pad.
- Items equipped with magnetic components such as credit card, telephone card, bankbook or any transportation ticket may become damaged during wireless charging.
- Place the smart phone on the center of the charge pad for best results. The smart phone may not charge when placed near the rim of the charging pad. When the smart phone does get charged, it may heat up excessively.
- For smart phones without built-in wireless charging system, an appropriate accessory has to be equipped in order to use the vehicle's wireless charging system.
- Certain smart phones may display messages on a weak current. This is due to the particular characteristics of that smart phone, and does not imply a malfunction of the wireless charging function.
- The indicator light of some manufacturers' smart phones may still be orange after the smart phone is fully charged. This is due to the particular characteristic of the smart phone and not a malfunction of the wireless charging.
- When any smart phone without a wireless charging function or a metallic object is placed on the charging

pad, a small noise may sound. This small noise is due to the vehicle discerning compatibility of the object placed on the charging pad. It does not affect your vehicle or the smart phone in any way.

- The wireless cellular phone charging system may not support certain cellular phones, which are not verified for the Qi specification ().
- When placing your smart phone on the charging pad, position the phone in the middle of the pad for maximum efficiency.
If your smart phone is off to the side, the charging speed may slow down, and in some cases, your phone may experience higher heat conduction.
- When charging some smart phones with a self-protection feature, the wireless charging speed may decrease, and the charging may stop.
- A smart phone that supports the wireless charging can only be charged wirelessly.
- The wireless charging pad has an internal cooling system which can create noise to keep your phone cool while it charges.

This device complies with part 15 of the FCC Rules

Operation is subject to the following two conditions:

1. This device may not cause harmful interference, and
2. This device must accept any interference received, including interference that may cause undesired operation.

Coat hook

A Coat hook is next to the rear grab handle.



* This actual feature may differ from the illustration.

CAUTION

Hanging clothing

Do not hang heavy clothes, since they may damage the hook.

WARNING

Do not hang other objects such as hangers or hard objects except clothes. Also, do not put heavy, sharp or breakable objects in the clothing's pockets. In an accident or when the curtain air bag is inflated, it may cause vehicle damage or body injury.



Floor mat anchors



When using a floor mat on the front floor carpet, make sure it attaches to the floor mat anchors in your vehicle. This keeps the floor mat from sliding forward.

⚠ WARNING

• **After market floor mat**

Do not install after market floor mats that are not capable of being securely attached to the vehicle's floor mat anchors.

Unsecured floor mats can interfere with pedal operation.

- Use floor mats not too thick and designed to be properly secured on the floor to avoid the interference with pedals. Make sure that installing the floor mats without removing plastic films on carpets may damage or break floor mat fix rings, resulting in the mats to be unsecured. Especially for a driver's seat, the unsecured mats may cause unintended acceleration/brake. Ensure to remove all the plastic films on the carpets before installing the mats.

The following must be observed when installing ANY floor mat to the vehicle.

- Ensure that the floor mats are securely attached to the vehicle's floor mat anchor(s) before driving the vehicle.
- Do not use ANY floor mat that cannot be firmly attached to the vehicle's floor mat anchors.
- Do not stack floor mats on top of one another (e.g., all-weather rubber mat on top of a carpeted floor mat). Only a single floor mat should be installed in each position.

Luggage board (if equipped)

- If temporary tire or full size tire equipped in luggage, you can place reflector triangle in luggage.
- If TMK equipped in luggage, first aid kit, tools, etc can be placed in the box for easy access.



1. Grasp the handle on the top of the cover and lift it (1).
2. Fold the rear part of luggage board frontward.
3. Lift up upward luggage board frontward (Luggage board)

Luggage net holder

To keep items from shifting in the cargo area, you can use the 4 holders located in the cargo area to attach the luggage net (if equipped), or you can fold the luggage net into half and attach it upwards by using the additional 2 holders located on each side.



If necessary, contact an authorized Kia dealer.

⚠ CAUTION

To prevent damage to the goods or the vehicle, be careful when carrying fragile or bulky objects in the luggage compartment.

⚠ WARNING

DO NOT over-stretch the luggage net and ALWAYS keep your face and body out of the luggage net's recoil path. Failure to comply with these instructions may result in severe facial injuries. DO NOT use the luggage net when the strap has visible signs of wear or damage.

Cargo security screen (if equipped)

Installing cargo security screen



- 1 Cargo security screen band
- 2 Cargo security screen cable

Operation

1. Take out the cargo security screen from the pouch. And slowly unfold the cargo security screen.
2. Attach the cargo security screen band (1) to the shopping bag hook.



3. After holding the cargo screen cable (2), insert it into the upper hook located under the rear glass and use it to fix it.



4. Removal of the cargo screen is the reverse of assembly.

Storing cargo security screen

Operation

1. Hold the cargo screen corners of the side with the ling strings. And fold it in half.



2. Turn your wrists to fold it and put it in the pouch.



⚠ WARNING

- Do not place objects on the cargo security screen. Such objects may move around inside the vehicle and possibly injure vehicle occupants during an accident or when braking.
- Never allow anyone to ride in the luggage compartment. It is designed for luggage only.
- Maintain the balance of the vehicle and locate the weight as forward as possible.

⚠ CAUTION

Do not unfold the cargo security screen near other people. The cargo security screen could spring causing injuries.

*** NOTICE**

- Since the cargo security screen may be damaged or malformed, do not put luggage on it when it is used.
- Pull out the cargo security screen using the handle in the center to prevent the guide pin from falling out of the guide.
- The cargo security screen may not automatically slide back in if the cargo security screen is not fully pulled out. Fully pull it out and then let go.

Exterior features**Roof rack (if equipped)**

If the vehicle has a roof rack, you can load cargo on top of your vehicle.



* The actual shape may differ from the illustration.

Crossbars and fixing components needed to install the roof rack on your vehicle may be obtained from an authorized Kia dealer or other qualified shop.

*** NOTICE**

- The crossbars (if equipped) should be placed in the proper load carrying positions prior to placing items onto the roof rack.
- If the vehicle is equipped with a sunroof, be sure not to position cargo onto the roof rack in such a way that it could interfere with sunroof operation.
- When the roof rack is not being used to carry cargo, the crossbars may need to be repositioned if wind noise is detected.

⚠ CAUTION

- When carrying cargo on the roof rack, take the necessary precautions to make sure the cargo does not damage the roof of the vehicle.
- When carrying large objects on the roof rack, make sure they do not exceed the overall roof length or width.

- When you are carrying cargo on the roof rack, do not operate the sunroof. (if equipped)

⚠ WARNING

- The following specification is the maximum weight that can be loaded onto the roof rack. Distribute the load as evenly as possible across the cross-bars (if equipped) and roof rack and secure the load firmly.

ROOF LOAD	220 lbs. (100 kg) EVENLY DISTRIBUTED
-----------	---

Loading cargo or luggage in excess of the specified weight limit on the roof rack may damage your vehicle.

- The vehicle center of gravity will be higher when items are loaded onto the roof rack. Avoid sudden starts, braking, sharp turns, abrupt maneuvers or high speeds that may result in loss of vehicle control or rollover resulting in an accident.
- Always drive slowly and turn corners carefully when carrying items on the roof rack. Severe wind updrafts, caused by passing vehicles or natural causes, can cause sudden upward pressure on items loaded on the roof rack. This is especially true when carrying large, flat items such as wood panels or mattresses. This could cause the items to fall off the roof rack and cause damage to your vehicle or others around you.
- To prevent damage or loss of cargo, FREQUENTLY check to ensure the cargo is securely fastened to the roof rack.

Infotainment system

*** NOTICE**

If you install an aftermarket HID head lamp, your vehicle's audio and electronic device may malfunction.

Using the infotainment/climate switchable controller



Press the button on the switchable controller to switch between infotainment system or climate control panel.

Press and hold the button to select the default mode for the control panel.

Switching between panels

Infotainment control panel



Climate control panel



Press the button on the switchable controller to select the desired control panel.

The selected control panel icon will appear and the control panel will be changed.

- The knob display will appear according to the selected control panel mode.
- When the vehicle is in the ACC position, only the infotainment system will be activated.

Setting the default mode



Press and hold the button to select the default mode for the control panel.

- After the setting, the control panel will return to the default mode after a certain period of time even if the control panel is switched to the different mode.
- If the mode is set to 'OFF', the control panel will display the mode used recently.

Audio system

* NOTICE

If you install an aftermarket HID headlamp, your vehicle's audio and electronic device may malfunction.

* INFORMATION

The infotainment system may change after software updates. For more information, refer to the user's manual provided in the infotainment system and the quick reference guide.

Shark-fin antenna



The sharkfin antenna transmits and receives wireless signals such as AM/FM, Sirius XM, GNSS, etc

* The signals which antenna can transmit and receive vary by the vehicle option.

* NOTICE

- Be careful of antenna damage by checking the height of the vehicle before entering low-ceiling spaces such as automated parking lots or automated washing machines.
- Be careful not to contact the antenna when loading cargo on the roof rack. Antenna transmission/reception performance may be degraded.

USB port

You can use the USB port to plug in an USB.



⚠ CAUTION

Depending on the size, length, or shape of the USB stick, if you forcibly close the tray cover, the USB device may be damaged, deformed or the cover may not reopen as the device is stuck.

When the stick is stuck, forcibly opening the cover can also cause damage to the device.

If the USB stick does not fit into the space, do not close the cover and try another USB stick with different specifications.

How vehicle radio works

FM reception

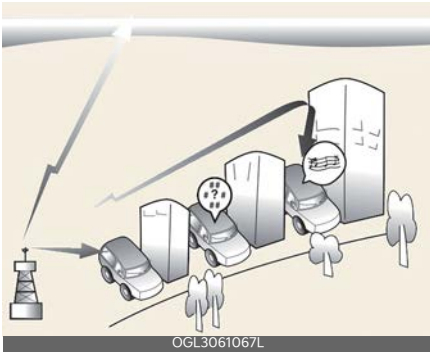

OGL3061067L

AM and FM radio signals are broadcast from transmitter towers located around your city. They are intercepted by the radio antenna on your vehicle. This signal is then processed by the radio and sent to your vehicle speakers.

However, in some cases the signal coming to your vehicle may not be strong and clear.

This can be due to factors, such as the distance from the radio station, closeness of other strong radio stations or the presence of buildings, bridges or other large obstructions in the area.

AM reception

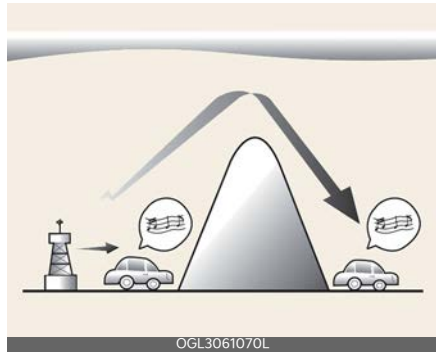

OGL3061070L

AM broadcasts can be received at greater distances than FM broadcasts. This is because AM radio waves are transmitted at low frequencies. These long distance, low frequency radio waves can follow the curvature of the earth rather than traveling straight. In addition, they curve around obstructions resulting in better signal coverage.

FM radio station

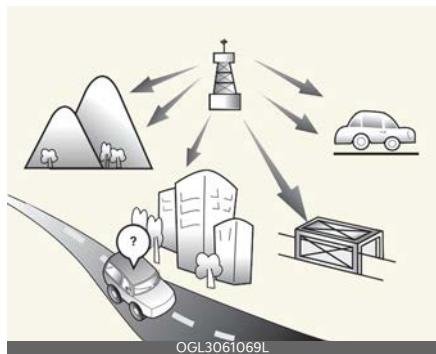

OGL3061069L

FM broadcasts are transmitted at high frequencies and do not bend to follow the earth's surface. Because of this, FM broadcasts generally begin to fade within short distances from the station. Also, FM signals are easily affected by buildings, mountains, and obstructions.

This can lead to undesirable or unpleasant listening conditions which might lead you to believe a problem exists with your radio.

The following conditions are normal and do not indicate radio trouble:

- Fading - As your vehicle moves away from the radio station, the signal will weaken and sound will begin to fade. When this occurs, we suggest that you select another station with a stronger signal.

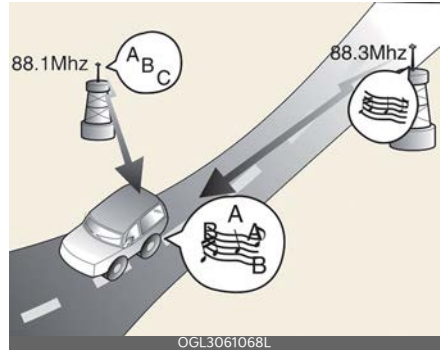

- Multi-Path Cancellation - Radio signals being received from several directions can cause distortion or fluttering. This can be caused by a direct and reflected signal from the same station, or by signals from two stations with close frequencies. If this occurs, select another station until the condition has passed.

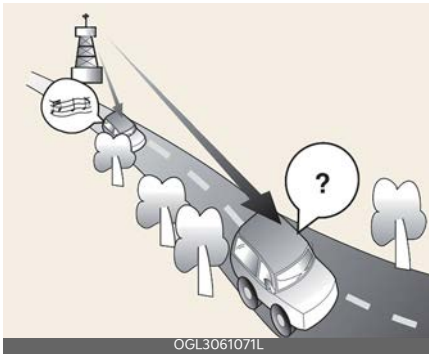

- Flutter/Static - Weak FM signals or large obstructions between the transmitter and your radio can disturb the signal causing static or fluttering noises to occur. Reducing the treble level may lessen this effect until the disturbance clears.
- Station Swapping - As an FM signal weakens, another more powerful signal near the same frequency may begin to play. This is because your radio is designed to lock onto the clearest signal. If this occurs, select another station with a stronger signal.

Using a cellular phone or a two-way radio

When a cellular phone is used inside the vehicle, noise may be produced from the audio system. This does not mean that something is wrong with the audio equipment. In such a case, try to operate mobile devices as far from the audio equipment as possible.

When using a communication system such as a cellular phone or a radio set inside the vehicle, a separate external antenna must be fitted. When a cellular phone or a radio set is used with only the internal antenna, it may interfere with the vehicle's electrical system and adversely affect the safe operation of the vehicle.

⚠ WARNING**Cell phone use**

Do not use a cellular phone while driving. Stop at a safe location to use a cellular phone.

⚠ WARNING**Distracted driving**

Driving while distracted can result in a loss of vehicle control that may lead to an accident, severe bodily injury, or death. The driver's primary responsibility is in the safe and legal operation of a vehicle. Any use of handheld devices, other equipment, or vehicle systems that take the driver's eyes, attention, and focus away from the safe operation of a vehicle are not permissible by law. These should never be used during the operation of the vehicle.

Declaration of Conformity**FCC**

This equipment has been tested and found to comply with the limits for a Class B digital device, pursuant to part 15 of the FCC Rules. These limits are designed to provide reasonable protection against harmful interference in a residential installation.

This equipment generates, uses and can radiate radio frequency energy and, if not installed and used in accordance with the instructions, may cause harmful interference to radio communications. However, there is no guarantee that interference will not occur in a particular installation. If this equipment does cause harmful interference to radio or television reception, which can be determined by turning the equipment off and on, the user is encouraged to try to correct the interference by one or more of the following measures:

- Reorient or relocate the receiving antenna.
- Increase the separation between the equipment and receiver.
- Connect the equipment into an outlet on a circuit different from that to which the receiver is connected.
- Consult the dealer or an experienced radio/TV technician for help.

⚠ CAUTION

Any changes or modifications to this device that is not explicitly approved by the manufacturer could void your authority to operate this equipment.

This device complies with part 15 of the FCC Rules. Operation is subject to the following two conditions:

1. This device may not cause harmful interference, and
2. This device must accept any interference received, including interference that may cause undesired operation.

This equipment complies with FCC radiation exposure limits set forth for an uncontrolled environment.

This equipment should be installed and operated with minimum 8 in (20 cm) between the radiator and your body.

This transmitter must not be collocated or operating in conjunction with any other antenna or transmitter unless authorized to do so by the FCC.

Before driving	6-5
EV button	6-6
• Starting the vehicle.....	6-7
• Turning off the vehicle.....	6-8
Reduction gear	6-9
• Reduction gear operation.....	6-9
• Parking.....	6-11
• LCD display messages.....	6-11
• Good driving practices	6-13
Regenerative braking system	6-14
• Regenerative braking (Paddle shifter).....	6-14
• One pedal driving	6-14
• i-Pedal	6-15
Smart regeneration system	6-16
• Setting smart regeneration system.....	6-16
• Smart regeneration system activation	6-16
• Resuming smart regeneration system	6-17
• Turning smart regeneration system off.....	6-17
• Vehicle-to-vehicle distance recognition sensor	6-17
• System malfunction	6-18
• Limitations of the system	6-18
Brake system	6-21
• Power brakes.....	6-21
• Electronic Parking Brake (EPB).....	6-23
• AUTO HOLD	6-27
• Anti-lock Brake System (ABS)	6-30
• Electronic Stability Control (ESC)	6-31
• Vehicle Stability Management (VSM).....	6-33
• Electronic Control Suspension (ECS).....	6-34
• Hill-start Assist Control (HAC)	6-34
• Brake Assistant System (BAS)	6-34

6 Driving your vehicle

• Good braking practices.....	6-35
Drive mode integrated control system	6-36
• DRIVE MODE.....	6-36
• Initial setting for each DRIVE MODE	6-37
Active air flap	6-38
• Active air flap malfunction.....	6-38
Forward Collision-Avoidance Assist (FCA) (Sensor Fusion)	6-39
• Forward Collision-Avoidance Assist settings.....	6-42
• Forward Collision-Avoidance Assist operation	6-44
• Forward Collision-Avoidance Assist malfunction and limitations.....	6-52
Lane Keeping Assist (LKA)	6-60
• Lane Keeping Assist settings.....	6-60
• Lane Keeping Assist operation	6-61
• Lane Keeping Assist malfunction and limitations.....	6-63
Blind-Spot Collision-Avoidance Assist (BCA)	6-65
• Blind-Spot Collision-Avoidance Assist settings.....	6-66
• Blind-Spot Collision-Avoidance Assist operation.....	6-67
• Blind-Spot Collision-Avoidance Assist malfunction and limitations.....	6-70
Safe Exit Warning (SEW)	6-74
• Safe Exit Warning settings.....	6-74
• Safe Exit Warning operation.....	6-75
• Safe Exit Warning malfunction and limitations	6-76
Safe Exit Assist (SEA)	6-78
• Safe Exit Assist settings.....	6-78
• Safe Exit Assist operation.....	6-79
• Safe Exit Assist malfunction and limitations	6-81
Manual Speed Limit Assist (MSLA).....	6-83
• Manual Speed Limit Assist operation.....	6-83

Intelligent Speed Limit Assist (ISLA)	6-85
• Intelligent Speed Limit Assist settings.....	6-85
• Intelligent Speed Limit Assist operation.....	6-87
• Intelligent Speed Limit Assist malfunction and limitations.....	6-88
Driver Attention Warning (DAW)	6-90
• Driver Attention Warning settings	6-91
• Driver Attention Warning operation	6-91
• Driver Attention Warning malfunction and limitations.....	6-93
Smart Cruise Control (SCC)	6-95
• Smart Cruise Control settings.....	6-96
• Smart Cruise Control operation.....	6-97
• Smart Cruise Control malfunction and limitations	6-104
Navigation-based Smart Cruise Control (NSCC)	6-109
• Navigation-based Smart Cruise Control settings	6-110
• Navigation-based Smart Cruise Control operation.....	6-110
• Limitations of Navigation-based Smart Cruise Control	6-112
Lane Following Assist (LFA)	6-115
• Lane Following Assist settings.....	6-115
• Lane Following Assist operation.....	6-116
• Lane Following Assist malfunction and limitations.....	6-118
Highway Driving Assist (HDA)	6-118
• Highway Driving Assist settings	6-119
• Highway Driving Assist operation.....	6-121
• Highway Driving Assist malfunction and limitations.....	6-126
Rear View Monitor (RVM)	6-128
• Rear View Monitor settings.....	6-128
• Rear View Monitor operation.....	6-130
• Rear View Monitor malfunction and limitations.....	6-131
Rear Cross-Traffic Collision-Avoidance Assist (RCCA)	6-132
• Rear Cross-Traffic Collision-Avoidance Assist settings.....	6-132

6 Driving your vehicle

- Rear Cross-Traffic Collision-Avoidance Assist operation..... 6-133
- Rear Cross-Traffic Collision-Avoidance Assist malfunction and limitations..... 6-136
- Reverse Parking Distance Warning (PDW) 6-139**
 - Reverse Parking Distance Warning settings..... 6-139
 - Reverse Parking Distance Warning operation..... 6-140
 - Reverse Parking Distance Warning malfunction and precautions..... 6-141
- Forward/Reverse Parking Distance Warning (PDW)..... 6-142**
 - Forward/Reverse Parking Distance Warning settings..... 6-142
 - Parking Distance Warning operation..... 6-143
 - Parking Distance Warning malfunction and limitations..... 6-145
- Reverse Parking Collision-Avoidance Assist (PCA) 6-147**
 - Parking Collision-Avoidance Assist settings 6-147
 - Parking Collision-Avoidance Assist operation..... 6-148
 - Parking Collision-Avoidance Assist malfunction and limitations..... 6-149
- Remote Smart Parking Assist (RSPA) 6-153**
 - Remote Smart Parking Assist settings 6-154
 - Remote Smart Parking Assist operation..... 6-155
 - Remote Smart Parking Assist malfunction and limitations..... 6-159
- Declaration of conformity 6-163**
- Special driving conditions 6-165**
- Winter driving 6-168**
- Vehicle load limit 6-172**
 - Steps for Determining Correct Load Limit - 6-172
 - Certification label..... 6-174
- Vehicle weight..... 6-175**

Driving your vehicle

Before driving

Before getting into the vehicle, you should examine the car and its surroundings. After getting into the vehicle, you should check a number of things before driving.

Before entering the vehicle

- Be sure that all windows, outside mirror(s), and outside lights are clean.
- Check the condition of the tires.
- Check under the vehicle for any sign of leaks.
- Be sure there are no obstacles behind you if you intend to back up.

Before starting

- Close and lock all doors.
- Position the seat so that all controls are easily reached.
- Buckle your seat belt.
- Adjust the inside and outside rear view mirrors.
- Be sure that all lights work.
- Check all gauges.
- Check the operation of warning lights when the EV button is turned to the ON position.
- Release the parking brake and make sure the brake warning light goes out.

For safe operation, be sure you are familiar with your vehicle and its equipment.

WARNING

Check Surroundings

Always check the surrounding areas near your vehicle for pedestrians, espe-

cially children, before putting a vehicle into D (Drive) or R (Reverse).

WARNING

Loose Objects

Securely store items in your vehicle. When you make a sudden stop or turn the steering wheel rapidly; loose objects may drop on the floor and it could interfere with the operation of the foot pedals, possibly causing an accident.

WARNING

Proper Footwear

Always wear appropriate shoes when operating your vehicle. Unsuitable shoes (high heels, ski boots, sandals, etc.) may interfere with your ability to use the brake and accelerator pedals.

WARNING

Driving While Intoxicated

Do not drive while intoxicated. Drinking and driving is dangerous. Even a small amount of alcohol will affect your reflexes, perceptions and judgment. Driving while under the influence of drugs is as dangerous as or more dangerous than driving drunk.

WARNING

Distracted Driving

Focus on the road while driving. The driver's primary responsibility is in the safe and legal operation of the vehicle. Use of any handled devices, other equipment or vehicle systems that distract the driver should not be used during vehicle operation.

⚠ WARNING

California Proposition 65

vehicle exhaust and a wide variety of automobile components and parts, including components found in the interior furnishings in a vehicle, contain or emit chemicals known to the State of California to cause cancer and birth defects and reproductive harm. In addition, certain fluid contained in vehicles and certain products of component wear contain or emit chemicals known to the State of California to cause cancer and birth defects or other reproductive harm.

EV button

Whenever the front door is opened, the EV button will appear for your convenience.



The light will go off after about 30 seconds when the door is closed.

When all doors are closed, if you lock the vehicle by using the transmitter or the smart key, the light will go off immediately.

EV button position

The EV button has the following four positions.

- OFF
- ACC (Accessory)
- ON
- START/RUN

OFF

To turn off the vehicle power (ON position), press the EV button with the shifter dial in the P (Park) position. When you press the EV button without the shifter dial in the P (Park) position, the EV button will not change to the OFF position but to the ACC position.

ACC (Accessory)

Press the EV button while it is in the OFF position without depressing the brake pedal.

If the EV button is in the ACC position for more than 1 hour, the button is turned

off automatically to prevent battery discharge.

ON

Press the EV button while it is in the ACC position without depressing the brake pedal.

The warning lights can be checked before the vehicle is started. Do not leave the EV button in the ON position for a long time. The battery may discharge, because the vehicle is not running.

START/RUN

To start the vehicle, depress the brake pedal and press the EV button with the shifter dial in the P (Park) position. For your safety, start the vehicle with the shifter dial in the P (Park) position.

If you press the EV button without depressing the brake pedal, the vehicle will not start and the EV button changes as follow:

Go to OFF → ACC → ON → OFF or ACC

* NOTICE

If you leave the EV button in the ACC or ON position for a long time, the battery will discharge.

⚠ WARNING

Starting Vehicle

Never press the EV button while the vehicle is in motion except in an emergency. This would result in loss of directional control and braking function, which could cause an accident.

⚠ WARNING

Leaving the Vehicle

To avoid unexpected or sudden vehicle movement, never leave your vehicle if the reduction gear is not locked in the P (Park) position and the parking brake is fully engaged. Before leaving the driver's seat, always make sure the reduction gear is engaged in P (Park), set the parking brake fully and shut the vehicle off.

Starting the vehicle

⚠ WARNING

Do not start the vehicle with the accelerator pedal depressed. The vehicle can move and lead to an accident.

- The vehicle will start by pressing the EV button, only when the smart key is in the vehicle.
 - Even when the smart key is in the vehicle, if it is far away from the driver, the vehicle may not start.
 - When the EV button is in the ACC or ON position, and any door is open, the system checks for the smart key. When the smart key is not in the vehicle, the **READY** indicator will blink and **Key not in vehicle** message will come on. When all doors are closed, the chime will also sound for about 5 seconds. Keep the smart key in the vehicle when in the ACC position or if the vehicle is ON.
1. Always carry the smart key with you.
 2. Make sure the parking brake is applied.
 3. Make sure the shifter dial is in P (Park).
 4. Depress the brake pedal.

- Press the EV button. If the vehicle starts, the **READY** indicator will come on.

* NOTICE

- Always start the vehicle with your foot on the brake pedal. Do not depress the accelerator while starting the vehicle.
- If ambient temperature is low, the **READY** indicator may remain illuminated longer than the normal amount of time.

* NOTICE

To prevent damage to the vehicle:

- If the **READY** indicator turns off while you are in motion, do not attempt to move the shifter dial to the P (Park) position.
If traffic and road conditions permit, you may put the shifter dial in the N (Neutral) position while the vehicle is still moving and press the EV button in an attempt to restart the vehicle.
- Do not push or tow your vehicle to start the vehicle.

⚠ WARNING

Unintended Vehicle Movement

Never leave the smart key in the vehicle with children or vehicle occupants who are unfamiliar with the vehicle operation. Pushing the EV button while the smart key is in the vehicle may result in unintended vehicle activation and/or unintended vehicle movement.

If the smart key battery is weak or the smart key does not work correctly, you can start the vehicle by pressing the EV button with the smart key.



OSG2EV051084

The side with the lock button should contact the EV button directly.

When you press the EV button directly with the smart key, the smart key should contact the button at a right angle.

When the stop lamp fuse is blown, you can't start the vehicle normally. Replace the fuse with a new one. If it is not possible, you can start the vehicle by pressing the EV button for 10 seconds while it is in the ACC position. The vehicle can start without depressing the brake pedal. But for your safety always depress the brake pedal before starting the vehicle.

Do not press the EV button for more than 10 seconds except when the stop lamp fuse is blown.

Turning off the vehicle

- Depress the brake pedal fully.
- Shift to P (Park).
- Apply the parking brake.
- Press the EV button to turn the vehicle off.
- Make sure the **READY** indicator light on the instrument cluster is turned off.

⚠ CAUTION

If the **READY** indicator light on the instrument cluster is still on, the vehicle is not turned off and can move when the gear is in any position except P (Park).

Reduction gear

Electric cars transmit the rotation of the motor to the wheel through the reducer.

Reduction gear operation

Select gear positions by turning the shifter dial.



WARNING

To reduce the risk of serious injury or death:

- ALWAYS check the surrounding areas near your vehicle for people, especially children, before shifting a vehicle into D (Drive) or R (Reverse).
- Before leaving the driver's seat, always make sure the gear is in the P (Park) position, then set the parking brake, and place the Power button in the OFF position. Unexpected and sudden vehicle movement can occur if these precautions are not followed.

For your safety, always depress the brake pedal while shifting to another gear.

Gear position



The indicator in the instrument cluster displays the gear position when the EV button is in the ON position.

P (Park)

Always come to a complete stop before shifting into P (Park).

To shift the gear from R (Reverse), N (Neutral) or D (Drive) to P (Park), press the [P] button.

If you turn off the vehicle in D (Drive) or R (Reverse), the gear automatically shifts to P (Park).

With the vehicle on, the gear automatically shifts to P (Park) if you open the driver's door when the gear is in N (Neutral), R (Reverse) or D (Drive) and the following conditions are met:

- The vehicle speed is below 1 mph (2 km/h).

When the vehicle is over a certain speed, the gear does not shift to P (Park) when the [P] button is pressed.

WARNING

- Shifting into P (Park) while the vehicle is in motion may cause you to lose control of the vehicle.
- After the vehicle has stopped, always make sure the gear is in P (Park), apply the parking brake, and turn the vehicle off.
- Do not use the P (Park) position in place of the parking brake.

R (Reverse)

Use this position to drive the vehicle backward.

To shift to R (Reverse), turn the shifter dial to R (Reverse) position while depressing the brake pedal.

⚠ CAUTION**Shifting**

Always come to a complete stop before shifting into or out of R (Reverse); you may damage the reduction gear if you shift into R (Reverse) while the vehicle is in motion, except on "Rocking the vehicle" on page 6-166.

N (Neutral)

To shift to N (Neutral) from P (Park), turn the shifter dial to N (Neutral) position while depressing the brake pedal.

In N (Neutral), if the driver attempts to turn off the vehicle, the gear remains in N (Neutral) and the EV button will be in the ACC position.

If the Electronic Parking Brake is applied, release the Electronic Parking Brake manually while depressing the brake pedal.

If equipped with Electronic Parking Brake, it is not released automatically when you turn the shift dial to N (Neutral).

To turn off the vehicle from the ACC position, press the [P] button within 3 minutes. The vehicle will shift to P (Park) and turn off.

When the driver's door is opened within 3 minutes with the EV button in the ACC position and the gear in N (Neutral), the vehicle is automatically turned OFF and shifted to the P (Park) position.

⚠ CAUTION

Do not open the driver's door when going through an automatic car wash tunnel machine. Failure to follow this instruction can damage your vehicle or the car wash machine.

For vehicles equipped with Electronic Parking Brake (EPB), the parking brake is automatically applied.

D (Drive)

This is the normal driving position.

To shift to D (Drive), turn the shifter dial to D (Drive) position while depressing the brake pedal.

Shift-lock system

For your safety, your vehicle has a shift-lock system which prevents shifting the gear from P (Park) or N (Neutral) into R (Reverse) or D (Drive) unless the brake pedal is depressed.

To shift from P (Park) or N (Neutral) into R (Reverse) or D (Drive), from R (Reverse) into D (Drive) or from D (Drive) into R (Reverse):

1. Depress and hold the brake pedal.
2. Start the vehicle or place the EV button in the ON position.
3. Turn the shift dial to R (reverse) or D (Drive).

*** NOTICE**

For your safety, you cannot shift the gear while the charging cable is connected.

When the battery (12V) is discharged

You cannot shift the gear when the battery is discharged.

Jump start your vehicle (refer to "Jump starting (12V battery)" on page 7-4) or contact an authorized Kia dealer.

Parking

1. Always come to a complete stop and continue to depress the brake pedal.
2. Shift to the P (Park) position.
3. Apply the parking brake.
4. Place the EV button in the OFF position.
5. Take the key with you when leaving the vehicle.

LCD display messages

If a message appears on the LCD display, refer to the next section for the appropriate steps to take.

Shifting conditions not met. Reduce speed, then shift

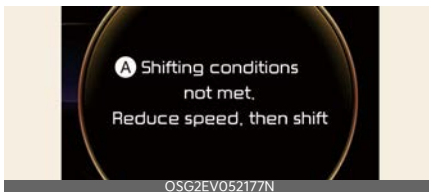

A: **Shifting conditions not met, Reduce speed, then shift**

The message appears on the LCD display in the following conditions:

1. When driving speed is too fast to shift the gear. Decrease the vehicle speed or slow down before shifting the gear.
2. When the gear is shifted while the vehicle is in Utility mode.

Press brake pedal to change gear



A: **Press brake pedal to change gear**

The message appears on the LCD display, when the brake pedal is not depressed while shifting the gear.

Depress the brake pedal and then shift the gear.

Shift to P after stopping



A: **Shift to P after stopping**

The message appears on the LCD display when the gear is shifted to P (Park) while the vehicle is moving.

Stop the vehicle before shifting to P (Park).

Gear already selected

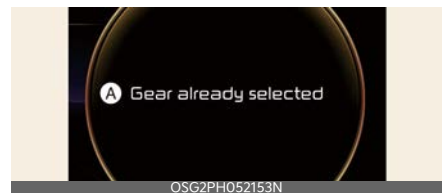

A: **Gear already selected**

The message appears on the LCD display when the selected gear position is shifted again.

PARK malfunction. Engage parking brake when parking vehicle



A: PARK malfunction. Engage parking brake when parking vehicle

The message is displayed when there is a problem with function engaging P (Park) position.

Immediately have the vehicle inspected by an authorized Kia dealer.

Check P button

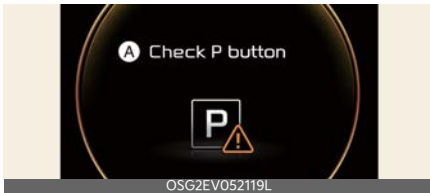

A: Check P button

The message appears on the LCD display when there is problem with the P button.

Immediately have the vehicle inspected by an authorized Kia dealer.

Check shifter dial

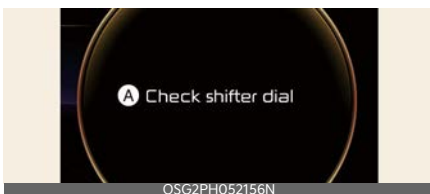

A: Check shifter dial

The message appears on the LCD display when there is problem with shift dial and P button.

Immediately have the vehicle inspected by an authorized Kia dealer.

Rotary shifter stuck



A: Rotary shifter stuck

The message appears on the LCD display when the shifter dial is continuously stuck or there is problem with the shifter dial.

Make sure that there is no object over the shifter dial. If the problem persists, immediately have the vehicle inspected by an authorized Kia dealer.

Shift button held down

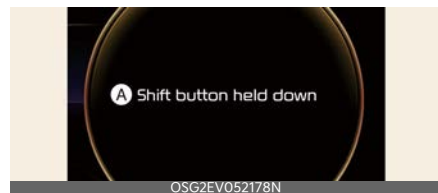

A: Shift button held down

The message appears on the LCD display when the shifter button is continuously pressed or there is problem with the button.

Make sure that there is no object over the shift button. If the problem persists, immediately have the system checked by an authorized Kia dealer.

Good driving practices

Good driving habits reduce the risk of accidents and help maintain vehicle performance.

- Never shift from P (Park) or N (Neutral) to any other position with the accelerator pedal depressed.
- Never shift from P (Park) when the vehicle is in motion.
Be sure the vehicle is completely stopped before you attempt to shift into R (Reverse) or D (Drive).
- Do not shift to N (Neutral) when driving. Doing so may result in an accident.
- Do not drive with your foot resting on the brake pedal. Even light, but consistent pedal pressure can result in the brakes overheating, brake wear and possibly even brake failure.
- Always apply the parking brake when leaving the vehicle. Do not depend on placing the gear in P (Park) to keep the vehicle from moving.
- Exercise extreme caution when driving on a slippery surface. Be especially careful when braking, accelerating or shifting gears. On a slippery surface, an abrupt change in vehicle speed can cause the drive wheels to lose traction and may cause loss of vehicle control resulting in an accident.
- Optimum vehicle performance and economy is obtained by smoothly depressing and releasing the accelerator.

WARNING

When driving uphill or downhill, always shift to D (Drive) for driving forward or shift to R (Reverse) for driving back-

wards, and check the gear position indicated on the cluster before driving.

Driving in the opposite direction of the selected gear can lead to a dangerous situation by shutting off the vehicle and affecting the braking performance.

WARNING

To reduce the risk of SERIOUS INJURY or DEATH:

- ALWAYS wear your seat belt. In a collision, an unbelted occupant is significantly more likely to be seriously injured or killed than a properly belted occupant.
- Avoid high speeds when cornering or turning.
- Do not make quick steering wheel movements, such as sharp lane changes or fast, sharp turns.
- The risk of rollover is greatly increased if you lose control of your vehicle at highway speeds.
- Loss of control often occurs if two or more wheels drop off the roadway and the driver over steers to reenter the roadway.
- In the event your vehicle leaves the roadway, do not steer sharply. Instead, slow down before pulling back into the travel lanes.
- Kia recommends you follow all posted speed limits.

Regenerative braking system

The regenerative braking system allows you to charge the battery when you use the brakes to stop the vehicle.

Regenerative braking (Paddle shifter)

The paddle shifter is used to adjust the regenerative braking level from 0 to 3 during decelerating or braking.



- Left side (+): Increases regenerative braking and deceleration.
- Right side (-): Decreases regenerative braking and deceleration.

Pull and hold the left side paddle shifter for more than 0.5 seconds and One Pedal Driving function is operated, increasing the regenerative braking. In this case, stopping the vehicle is possible by pulling the paddle shifter.

* Refer to "One pedal driving" on page 6-14.

Pull and hold the right side paddle shifter for over 1 second to turn on and off the automatic change of the regenerative braking.

* Refer to "Smart regeneration system" on page 6-16.

* NOTICE

The paddle shifter does not operate when:

- The (+) and (-) paddle shifters are pulled at the same time.
- The vehicle is decelerating by depressing the brake pedal.
- Smart Cruise Control is activated.
- Regenerative braking system is activated when the vehicle state of charge is 100%.
- SNOW mode is activated from DRIVE MODE.

The selected regenerative braking level is displayed on the instrument cluster.



- Initial setting of the regenerative braking level will be set the same with the regenerative braking level before turning of the vehicle.
- The setting will return to 1 when the vehicle is restarted from 0.

One pedal driving

The driver can stop the vehicle by pulling and holding the left side paddle shifter.

To operate

- Pull and hold the left side paddle shifter while coasting.
- When the vehicle speed is above 2 mph (3 km/h), release the paddle shifter to return to the previously set level.

- When the vehicle speed is below 2 mph (3 km/h), the function maintains control to stop the vehicle even though the paddle shifter is released.
- While the One pedal driving is in activation, the driver can control the vehicle stopping position using the accelerator pedal.

Automatic engagement of EPB

After the vehicle is stopped by the One Pedal Driving function, EPB is automatically engaged when any of these conditions occur:

- The driver's door is open.
- The hood is open.
- The liftgate is open.
- 5 minutes have passed after the vehicle has stopped.
- The system operation is limited due to other reasons.
- Shifting to P

⚠ WARNING

- Do not solely rely on one pedal driving to stop the vehicle. Stopping the vehicle may not be possible depending on the vehicle and road conditions. Pay attention to the road condition ahead and apply the brake if necessary.
- Avoid increasing the regenerative braking level suddenly on slippery roads (like snow or icy conditions) because it may lead to slipping of the tires and skidding of vehicle. It can be dangerous due to the loss of the vehicle's steering force.

⚠ CAUTION

When the vehicle is stopped or parked by One Pedal Driving on the steep hills, be sure to depress the brake pedal.

i-Pedal

i-Pedal is controlled by the accelerator pedal. i-Pedal provides vehicle speed control (acceleration/deceleration, stopping) without manually controlling the paddle shifter.

To operate

1. Pull the left side paddle shifter to level 3 regenerative braking system.
2. Pull the left side paddle shifter once again when the regenerative braking level is 3.
 - Check i-Pedal indicator symbol on the instrument cluster.

⚠ CAUTION

When the vehicle is stopped or parked by i-Pedal on the steep hills, be sure to depress the brake pedal.

Smart regeneration system

The Smart Regeneration System controls the regenerative braking automatically according to the road gradient and driving condition of the vehicle in front.

The system minimizes the unnecessary operation of the brake and acceleration pedal, improving the electric efficiency and assisting the driver.

Setting smart regeneration system

Pull and hold the right side paddle shifter for over 1 second to turn on and off the automatic change of the regenerative braking. The automatic regenerative braking adjustment by smart regeneration system is activated above the standard set level.

Smart regeneration system activation

With 'AUTO' for the regenerative braking level displayed on the cluster, the regenerative braking level is controlled automatically when vehicle speed is above 6 mph (10 km/h) and one of the condition below is met.

- The road gradient changes
- Distance from the vehicle ahead reduces or increases
- Speed of the vehicle ahead reduces or increases

* NOTICE

- The regenerative braking level can be adjusted based on the driver's deceleration style. (Strong/Medium/Gentle)

To adjust the level, select **Setup** → **Vehicle** → **ECO Vehicle** → **Smart Regeneration System** in the infotainment system.

The infotainment system may change after software updates. For more information, refer to the user's manual provided in the infotainment system and the quick reference guide.

* NOTICE

When vehicle speed is under 6 mph (10 km/h), the Smart Regeneration System is canceled. The driver must adjust the vehicle speed by depressing the accelerator or brake pedal according to the road condition ahead and driving condition.

When the system is turned on from the Vehicle Settings menu, but the front radar doesn't recognize the vehicle in front, 'AUTO' is displayed in white.



If the front radar recognizes the vehicle in front, 'AUTO' is displayed in blue. The regenerative braking level is automatically controlled depending on the driving condition of the vehicle in front and the level is indicated with arrows.

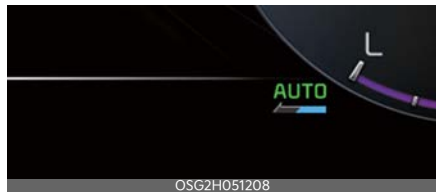

However, current regenerative braking level is maintained if the driver depresses the brake pedal while the system is in activation. Also, the system is

canceled temporarily if the accelerator pedal is depressed.

⚠ WARNING

The Smart Regeneration System which automatically controls the regenerative braking level when coasting is only a supplemental system for the driver's convenience. Do not solely rely on this system to stop the vehicle. The system cannot completely stop the vehicle in all situations nor avoid all collisions. The brake control may be insufficient depending on the speed of the vehicle in front and when the vehicle in front suddenly stops, a vehicle cuts in suddenly or there is a steep slope. Always look ahead cautiously to prevent unexpected and sudden situations from occurring.

Smart regeneration system will be temporarily canceled when:

- Canceled manually
Pulling and holding the right side of the paddle shifter for more than 1 second.
The Smart Regeneration System turns off temporarily and AUTO for the regenerative braking level disappears from the cluster.
- Canceled automatically
 - The vehicle is shifted to N (Neutral), R (Reverse) or P (Park).
 - Smart Cruise Control is in activation.
 - The ESC (Electronic Stability Control) or ABS is operating.

⚠ WARNING

When the Smart Regeneration System is canceled automatically, adjust the vehicle speed directly by depressing the

accelerator or brake pedal according to the road and driving conditions ahead.

Resuming smart regeneration system

To re-activate the Smart Regeneration System while driving:

- Pull and hold the right side paddle shifter for more than 1 second again. Then, AUTO for the regenerative braking level will appear on the cluster.

Turning smart regeneration system off

To turn off the system:

- Pull and hold the right side of the paddle shifter for more than 1 second.

Vehicle-to-vehicle distance recognition sensor

In order for the Smart Regeneration System to operate properly, always make sure the radar sensor cover is clean and free of dirt, snow, and debris.

Dirt, snow, or foreign substances on the lens may adversely affect the sensing performance of the sensor. In this case, the system operation may stop temporarily and not operate normally.

Front radar



⚠ CAUTION

- Do not apply license plate frame or foreign objects such as a bumper sticker or a bumper guard near the radar sensor. Doing so may adversely

affect the sensing performance of the radar.

- Always keep the radar sensor and lens cover clean and free of dirt and debris.
- Use only a soft cloth to wash the vehicle. Do not spray pressurized water directly on the sensor or sensor cover.
- Be careful not to apply unnecessary force on the radar sensor or sensor cover. If the sensor is forcibly moved out of proper alignment, the Smart Regeneration System may not operate correctly. In this case, a warning message may not be displayed. Have the vehicle inspected by an authorized Kia dealer.
- If the front bumper becomes damaged in the area around the radar sensor, the Smart Regeneration System may not operate properly. Have the vehicle inspected by an authorized Kia dealer.
- Use only genuine Kia parts to repair or replace a damaged sensor or sensor cover. Do not apply paint to the sensor cover.

System malfunction

The following message will appear when the Smart Regeneration System is not functioning normally.



A: Check Smart Regeneration System

The message will appear when the system is not functioning normally. The system will be canceled and the word

'AUTO' on the cluster will disappear and instead display regenerative braking level. Check for foreign substances on the front radar. Remove any dirt, snow, or foreign material that could interfere with the radar sensors. If the system still does not operate normally, take your vehicle to an authorized Kia dealer and have the system checked.

Limitations of the system

The Smart Regeneration System may not operate properly in certain situations when the driving condition is beyond the performance of the front radar sensor. Driver's attention is required in such cases when the system does not react properly or operate unintentionally.

Driving on a curved road



When driving on the curve, the system may not detect the vehicle in your lane and the regenerative braking level will reduce automatically, making you feel that the vehicle is accelerating.

Also, if the system suddenly recognizes the vehicle in front, the regenerative braking level will increase automatically, making you feel that the vehicle is decelerating.

The driver must maintain a safe braking distance, and if necessary, depress the brake pedal to reduce your driving speed in order to maintain a safe distance.



OSG2H051210

The smart regeneration system may recognize a vehicle in an adjacent lane when driving on a curved road. In this case, the system increase the braking level and slow the vehicle.

Always pay attention to road and driving conditions while driving. If necessary, depress the brake pedal to reduce your driving speed in order to maintain a safe distance. Also, when necessary, you may depress the accelerator pedal to prevent the system from unnecessarily decelerating your vehicle.

Always check the traffic conditions around the vehicle.

Driving on a sloped road



OSG2EV051003

When driving uphill or downhill, the system may not detect the vehicle in your lane and the regenerative braking level will reduce automatically, making you feel that the vehicle is accelerating.

Also, if the system suddenly recognizes the vehicle in front, the regenerative braking level will increase automatically, making you feel that the vehicle is decelerating.

The driver must maintain a safe braking distance, and if necessary, depress the

brake pedal to reduce your driving speed in order to maintain a safe distance.

Changing lanes

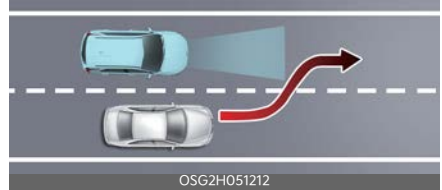

OSG2H051212

When a vehicle changes lanes in front of you, the smart regeneration system may not immediately detect the vehicle, especially if the vehicle changes lanes abruptly. In this case, you must maintain a safe braking distance, and if necessary, depress the brake pedal to reduce your driving speed in order to maintain a safe distance.

Recognizing the vehicle



OSG2H051061

Some vehicles in your lane cannot be recognized by the sensor:

- Narrow vehicles such as motorcycles or bicycles
- Vehicles offset to one side
- Slow-moving vehicles or sudden-decelerating vehicles
- Stopped vehicles (When the vehicle ahead drives away, the system may not detect a stopped vehicle.)
- Vehicles with small rear profile such as trailers with no loads

A vehicle ahead cannot be recognized correctly by the sensor if any of the following occurs:

- When the vehicle is pointing upwards due to overloading in the luggage compartment
- While the steering wheel is operating
- When driving to one side of the lane
- When driving on narrow lanes or on curves

Apply the brake or accelerator pedal if necessary.

WARNING

When using the Smart Regeneration System take the following precautions:

- If an emergency stop is necessary, you must apply the brakes.
- Keep a safe distance according to road conditions and vehicle speed. If the vehicle distance is too close during high-speed driving, a serious collision may result.
- Always maintain sufficient braking distance and decelerate your vehicle by applying the brakes if necessary.
- The Smart Regeneration System is designed to detect and monitor the vehicle ahead in the roadway through radar signals. It is not designed to detect oncoming vehicles, pedestrians, bicycles, motorcycles, or smaller wheeled objects such as luggage bags, shopping carts, or strollers.
- Vehicles moving in front of you with a frequent lane change may cause a delay in the system's reaction or may cause the system to react to a vehicle actually in an adjacent lane. Always drive cautiously to prevent unexpected and sudden situations from occurring.

- The Smart Regeneration System may not recognize complex driving situations so always pay attention to driving conditions and control your vehicle speed.

NOTICE

The Smart Regeneration System may not operate temporarily due to:

- Electrical interference
- Modifying the suspension
- Differences of tire abrasion or tire pressure
- Installing different type of tires

This device complies with Part 15 of the FCC rules.

Operation is subject to the following three conditions:

1. This device may not cause harmful interference, and
2. This device must accept any interference received, including interference that may cause undesired operation.
3. Changes or modifications not expressly approved by the party responsible for compliance could void the user's authority to operate the device.

Radio frequency radiation exposure information:

This equipment complies with FCC radiation exposure limits set forth for an uncontrolled environment.

This equipment should be installed and operated with minimum distance of 8 in. (20 cm) between the radiator (antenna) and your body.

This transmitter must not be colocated or operating in conjunction with any other antenna or transmitter.

Brake system

This vehicle is equipped with various brakes and functions to stop the vehicle or keep it stationary.

Power brakes

Your vehicle has power-assisted brakes that adjust automatically through normal usage.

If the vehicle is not on or is turned off while driving, the power assist for the brakes will not work. You can still stop your vehicle by applying greater force to the brake pedal than typical. The stopping distance, however, will be longer than with power brakes.

When the vehicle is not on, the reserve brake power is partially depleted each time the brake pedal is applied. Do not pump the brake pedal when the power assist has been interrupted.

Pump the brake pedal only when necessary to maintain steering control on slippery surfaces.

* NOTICE

- When stepping on the brake pedal under a certain driving or weather condition, you may witness your car make a sound of squealing or some other noises. This is not a brake malfunction but a normal phenomenon.
- When driving on the road to which deicing chemicals are applied, the vehicle may witness noises from the brake or abnormal abrasion of tires because of such deicing chemicals. You should operate brake additionally so that you would be able to remove the deicing chemicals on the brake disk and pad under a safe traffic condition.

⚠ CAUTION**Brake Pedal**

Do not drive with your foot resting on the brake pedal. This will create abnormally high brake temperatures which can cause excessive brake lining and pad wear.

⚠ WARNING**Steep Hill Braking**

Avoid continuous application of the brakes when descending a long or steep hill by increasing the regeneration level. Continuous brake application will cause the brakes to overheat and could result in a temporary loss of braking performance.

Wet brakes may impair the vehicle's ability to safely slow down; the vehicle may also pull to one side when the brakes are applied. Applying the brakes lightly will indicate whether they have been affected in this way. Always test your brakes in this fashion after driving through deep water. To dry the brakes, apply them lightly while maintaining a safe forward speed until brake performance returns to normal.

⚠ CAUTION

Do not depress the brake pedal continuously without the **READY** indicator ON. The battery may be discharged.

In the event of brake failure

If service brakes fail to operate while the vehicle is in motion, you can make an emergency stop with the parking brake. The stopping distance, however, will be much greater than normal.

⚠ WARNING**Parking Brake**

Avoid applying the parking brake to stop the vehicle while it is moving except in an emergency situation. Applying the parking brake while the vehicle is moving at normal speeds can cause a sudden loss of control of the vehicle. If you must use the parking brake to stop the vehicle, use great caution in applying the brake.

Disc brakes wear indicator

When your brake pads are worn and new pads are required, you will hear a high-pitched warning sound from your front brakes or rear brakes. You may hear this sound come and go or it may occur whenever you depress the brake pedal.

Always replace the front or rear brake pads as pairs.

⚠ CAUTION**Replace Brake Pads**

Do not continue to drive with worn brake pads. Continuing to drive with worn brake pads can damage the braking system and result in costly brake repairs, and can also lead to a serious accident.

⚠ WARNING**Brake Wear**

Do not ignore high pitched wear sounds from your brakes. If you ignore this audible warning, you will eventually lose braking performance, which could lead to a serious accident.

Electronic Parking Brake (EPB)

The Electronic Parking Brake switch is located on the lower left side of the shifter dial.

Applying the parking brake



1. Press the brake pedal.
2. Pull up the EPB switch.
3. Make sure the warning light comes on.

Also, the EPB is applied automatically if the AUTO HOLD button is on when the vehicle is turned off. However, if you pull up the EPB switch after the vehicle is turned off, the EPB will not be Applied.

* NOTICE

On a steep incline or when pulling a trailer, if the vehicle does not remain at a standstill, do as follows:

1. Apply the EPB.
2. Pull up the EPB switch for more than 3 seconds.

Do not operate the EPB while the vehicle is moving except in an emergency situation.

* NOTICE

A click or electric brake motor whine sound may be heard while operating or releasing the EPB.

These conditions are normal and indicate that the EPB is functioning properly.

Releasing the parking brake with Electronic Parking Brake (EPB) switch



1. Releasing the parking brake with EPB switch,
 - Place the EV button in the ON position.
 - Depress the brake pedal.
 - The shifter dial must be in P (Park).
2. Make sure the brake warning light goes off.

Automatic release of Electronic Parking Brake (EPB)

The EPB is released automatically under following conditions.

- Shifter dial in P (Park)

With the vehicle running depress the brake pedal and shift out of P (Park) to R (Reverse) or D (Drive).
- Shifter dial in N (Neutral)

With the vehicle running depress the brake pedal and shift out of N (Neutral) to R (Reverse) or D (Drive).
- Reduction gear
 1. Start the vehicle.
 2. Fasten the driver's seat belt.
 3. Close the driver's door, hood and liftgate.
 4. Depress the accelerator pedal while the shifter dial is in R (Reverse) or D (Drive).

Make sure the brake warning light goes off.

⚠ WARNING

- Never allow a passenger, children, or animal to touch the Electronic Parking Brake.
- Do not input any other objects around the Electronic Parking Brake. It may be operated unintentionally.

*** NOTICE**

- For your safety, you can engage the EPB even though the EV button is in the OFF position, but you cannot release it.
- For your safety, depress the brake pedal and release the parking brake manually with the EPB switch when you drive downhill or when backing up the vehicle.

⚠ CAUTION

- If the parking brake warning light is still on even though the EPB has been released, have the system checked by an authorized Kia dealer.
- Do not drive your vehicle with the EPB applied. It may cause excessive brake pad and brake rotor wear.
- Whenever leaving the vehicle or parking, make sure the gear is shifted to P (Park) position, then apply the parking brake. Block the tires if necessary.
- Electronic Parking Brake may not be released because it can freeze in winter. Do not use Electronic Parking Brake and shift the gear to P (Park), block the tires, and park the vehicle on the flat and safe road. If the Electronic Parking Brake is applied when you shift the gear to P (Park), release the Auto Hold and Electronic Parking Brake, and park the vehicle with the tires blocked.

- When driving with the Electronic Parking Brake applied, brake system may be overheated, brake lines may be worn, and the Electronic Parking Brake may be damaged.
- When the battery charge is not sufficient, Electronic Parking Brake may not be applied or released. In this case, connect to the auxiliary battery.

EPB (Electronic Parking Brake) may be automatically applied when:

- The EPB is overheated
- Requested by other systems
- If equipped with Electronic Parking Brake, parking brake is applied automatically when the gear is shifted to P (Park).

⚠ CAUTION

- If you notice a continuous noise or burning smell when the EPB is used for emergency braking, have your vehicle checked by an authorized Kia dealer.
- If the gear is shifted to N (Neutral) while Electronic Parking Brake is applied, it is not released automatically. If you don't release Electronic Parking Brake manually before using an automatic car wash tunnel machine or etc., this may result in damage to the vehicle or the automatic car wash tunnel machine.

*** NOTICE**

For EPB (Electronic Parking Brake) equipped vehicles with AUTO HOLD function used while driving, if the EV button has been turned OFF, the EPB will be engaged automatically. There-

fore, AUTO HOLD function should be turned off before the EV button is turned off.

System warning

The EPB will display a warning message with sound under certain conditions.

- If you try to drive off depressing the accelerator pedal with the EPB applied, but the EPB doesn't release automatically, a warning will sound and a message will appear.
- If the driver's seat belt is not fastened and the vehicle hood, driver's door or liftgate is opened, a warning will sound and a message will appear.

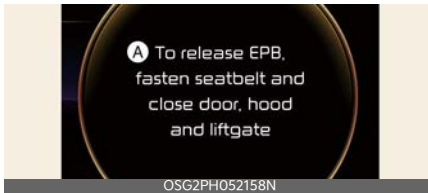

A: To release EPB, fasten seatbelt and close door, hood and liftgate

- If there is a problem with the vehicle, a warning may sound and a message may appear.

If the above situation occurs, depress the brake pedal and release EPB by pressing the EPB switch.

WARNING

- To prevent unintentional movement when stopped and leaving the vehicle, do not use the shifter dial in place of the parking brake. Set the parking brake and make sure the shifter dial is securely positioned in P (Park).
- Never allow a passenger to touch the parking brake. If the parking brake is released unintentionally, serious injury may occur.

- All vehicles should always have the parking brake fully engaged when parked to avoid inadvertent movement of the vehicles which can injure occupants or pedestrians.

CAUTION

- A click or electric brake motor whine sound may be heard while operating or releasing the EPB. These conditions are normal and indicate that the EPB is functioning properly.
- If you hand over the vehicle to other people, make sure they understand how to use the Electronic Parking Brake for safety.
- The EPB may malfunction if you drive with the EPB applied.
- When you automatically release EPB by depressing the accelerator pedal, depress it slowly.

When the conversion from AUTO HOLD to EPB is not working properly a warning will sound and a message will appear.

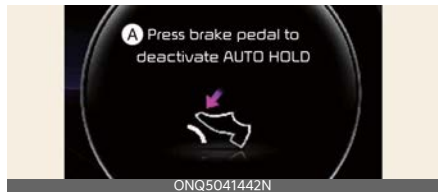

A: AUTO HOLD turning Off! Press brake pedal

* NOTICE

Engage the brake pedal when the above message appears for the AUTO HOLD and EPB may not activate.

If the EPB is applied while AUTO HOLD is activated because of an ESC (Elec-

tronic Stability Control) signal, a warning will sound and a message will appear.

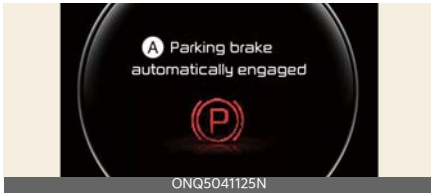

A: Parking brake automatically engaged

EPB malfunction indicator

This warning light appears if the EV button is changed to the ON position and goes off in approximately 3 seconds if the system is operating normally.



If the EPB malfunction indicator remains on, comes on while driving, or does not come on when the EV button is changed to the ON position, this indicates that the EPB may have malfunctioned.

If this occurs, have your vehicle checked by an authorized Kia dealer as soon as possible.

The EPB malfunction indicator may appear when the ESC indicator comes on to indicate that the ESC is not working properly, but it does not indicate a malfunction of the EPB.

The EPB warning light may appear if the EPB switch operates abnormally. Shut the vehicle off and turn it on again after a few minutes.

⚠ CAUTION

The warning light will go off and the EPB switch will operate normally. However, if the EPB warning light is still on, have the system checked by an authorized Kia dealer.

If the parking brake warning light does not appear or blinks even though the EPB switch was pulled up, the EPB is not applied.

If the parking brake warning light blinks when the EPB warning light is on, press the EPB switch, then pull it up. Once more press it back to its original position and pull it back up. If the EPB warning does not go off, have the system checked by an authorized Kia dealer.

Emergency braking

If there is a problem with the brake pedal while driving, emergency braking is possible by pulling up and holding the EPB switch.

Braking is possible only while you are holding the EPB switch.

⚠ WARNING

Do not operate the Electronic Parking Brake while the vehicle is moving except in an emergency situation. Applying the Electronic Parking Brake while the vehicle is moving at normal speeds can cause a sudden loss of control of the vehicle. If you must use the Electronic Parking Brake to stop the vehicle, use great caution in applying the brake.

*** NOTICE**

During emergency braking by the EPB, the parking brake warning light will

appear to indicate that the system is operating.

If you notice a continuous noise or burning smell when the EPB is used for emergency braking, have your vehicle checked by an authorized Kia dealer.

When the EPB (Electronic Parking Brake) is not released

If the EPB does not release normally, take your vehicle to an authorized Kia dealer by loading the vehicle on a flat-bed tow truck and have the system checked.

Brake Disc Cleaning (BDC)

If there is a surface rust on the brake disc or squeal can be heard, use Brake Disc Cleaning function to reduce noise and rust. While using Brake Disc Cleaning function, the regenerative brake system will be temporarily deactivated and the energy efficiency may be reduced.

Operation

- Press AUTO HOLD button for more than 3 seconds.
 - If the message is shown on the cluster, Brake Disc Cleaning function is activated.
 - Depress the brake pedal around 10 times and the regenerative braking will be temporarily deactivated. The rust and noise will be reduced. Brake Disc Cleaning operation time can change per braking conditions.
 - Brake Disc Cleaning function will be automatically deactivated after operation. To manually turn off, turn the vehicle to OFF position or press AUTO HOLD button for more than 3 seconds

AUTO HOLD

The AUTO HOLD maintains the vehicle in a standstill even though the brake pedal is not depressed after the driver brings the vehicle to a complete stop by depressing the brake pedal.

Applying AUTO HOLD function

1. Depress the brake pedal, start the vehicle and then press the AUTO HOLD button. The white AUTO HOLD indicator will come on indicating the system is in standby.



2. When coming to a complete stop by depressing the brake pedal, the AUTO HOLD indicator changes from white to green indicating the AUTO HOLD is engaged.
3. The vehicle will remain at a standstill even if you release the brake pedal.

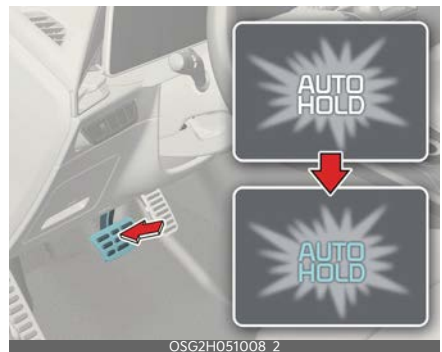

4. If EPB is applied, AUTO HOLD will be released.

If you press the accelerator pedal with the shifter dial in D (Drive), or R (Reverse) when the accelerator is not

depressed, the AUTO HOLD will be released automatically and the vehicle will start to move. The indicator changes from green to white indicating the AUTO HOLD is in standby and the EPB is released.

⚠ WARNING

When driving off from AUTO HOLD by depressing the accelerator pedal, always check the surrounding area near your vehicle.

Slowly depress the accelerator pedal for a smooth launch.

Canceling AUTO HOLD function



- To cancel the AUTO HOLD operation, press the AUTO HOLD switch. The AUTO HOLD indicator will turn off.
- To cancel the AUTO HOLD operation when the vehicle is at a standstill, press the AUTO HOLD switch while depressing the brake pedal.

*** NOTICE**

- The following are conditions when the AUTO HOLD will not engage (AUTO HOLD light will not turn green and the AUTO HOLD system remains in standby):
 - The shifter dial is in P (Park)
 - The EPB is applied
- For your safety, the AUTO HOLD automatically switches to EPB under any of the following conditions (AUTO

HOLD light remains white and the EPB automatically applies):

- The vehicle is in a standstill for more than 10 minutes
- The vehicle is standing on a steep slope
- The vehicle moved for a few seconds

In these cases, the brake warning light comes on, the AUTO HOLD indicator changes from green to white, and a warning sounds and a message will appear to inform you that EPB has been automatically engaged. Before driving off again, press foot brake pedal, check the surrounding area near your vehicle and release parking brake manually with the EPB switch.

- If the AUTO HOLD indicator lights up yellow, the AUTO HOLD is not working properly. Take your vehicle to an authorized Kia dealer and have the system checked.
- If the vehicle is restarted with the AUTO HOLD button pressed, AUTO HOLD will be in the standby state.

⚠ WARNING

To reduce the risk of an accident, do not activate AUTO HOLD while driving downhill, backing up or parking your vehicle.

If there is a malfunction with the driver's door or vehicle hood or liftgate open detection system, the AUTO HOLD may not work properly.

Take your vehicle to an authorized Kia dealer and have the system checked.

* NOTICE

A click or electric brake motor whine sound may be heard while operating or releasing the EPB, but these conditions are normal and indicate that the EPB is functioning properly.

Warning messages

The AUTO HOLD function will display a warning message with sound under certain conditions.

When the EPB is applied from AUTO HOLD, a warning will sound and a message will appear.



A: Parking brake automatically engaged

When the conversion from AUTO HOLD to EPB is not working properly a warning will sound and a message will appear.

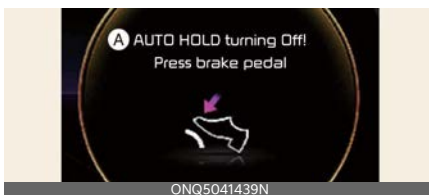

A: AUTO HOLD turning Off! Press brake pedal

* NOTICE

When this message is displayed, the AUTO HOLD and EPB may not operate. For your safety, depress the brake pedal.

If you do not apply the brake pedal when you release the AUTO HOLD by

pressing the [AUTO HOLD] switch, a warning will sound and a message will appear.

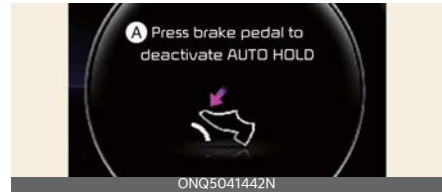

A: Press brake pedal to deactivate AUTO HOLD

⚠ WARNING

Parking Brake Use

- Never allow a passenger to touch the parking brake. If the parking brake is released unintentionally, serious injury may occur.
- All vehicles should always have the parking brake fully engaged when parked to avoid inadvertent movement of the vehicles which can injure occupants or pedestrians.

Check the brake warning light by pressing EV button ON (do not start the vehicle). This light will appear when the parking brake is applied with the EV button in the START or ON position.



Before driving, be sure the parking brake is fully released and the brake warning light is off.

If the brake warning light remains on after the parking brake is released while the vehicle is running, there may be a malfunction in the brake system. Immediate attention is necessary.

If at all possible, cease driving the vehicle immediately. If that is not possible, use extreme caution while operating the vehicle and only continue to drive the vehicle until you can reach a safe location or repair shop.

Anti-lock Brake System (ABS)

The ABS prevents the wheels from locking. So the vehicle remains stable and can still be steered.

ABS (or ESC) will not prevent accidents due to improper or dangerous driving maneuvers. Even though vehicle control is improved during emergency braking, always maintain a safe distance between you and objects ahead. Vehicle speeds should always be reduced during extreme road conditions. The vehicle should be driven at reduced speeds in the following circumstances:

- When driving on rough, gravel or snow-covered roads
- When driving with tire chains installed
- When driving on roads where the road surface is pitted or has different surface heights.

Driving in these conditions increases the stopping distance for your vehicle.

The ABS continuously senses the speed of the wheels. If the wheels are going to lock, the ABS system repeatedly modulates the hydraulic brake pressure to the wheels.

When you apply your brakes under conditions which may lock the wheels, you may hear a "tik-tik" sound from the brakes, or feel a corresponding sensation in the brake pedal. This is normal and it means your ABS is active.

In order to obtain the maximum benefit from your ABS in an emergency situation, do not attempt to modulate your

brake pressure and do not try to pump your brakes.

* NOTICE

A click sound may be heard in the vehicle compartment when the vehicle begins to move after the vehicle is started. These conditions are normal and indicate that the anti-lock brake system is functioning properly.

Even with the anti-lock brake system, your vehicle still requires sufficient stopping distance. Always maintain a safe distance from the vehicle in front of you. Always slow down when cornering. The anti-lock brake system cannot prevent accidents resulting from excessive speeds.

On loose or uneven road surfaces, operation of the anti-lock brake system may result in a longer stopping distance than for vehicles equipped with a conventional brake system.

The ABS warning light will stay on for approximately 3 seconds after the EV button is ON.



During that time, the ABS will go through self-diagnosis and the light will go off if everything is normal. If the light stays on, you may have a problem with your ABS. Contact an authorized Kia dealer as soon as possible.

When you drive on a road having poor traction, such as an icy road, and have operated your brakes continuously, the ABS will be active continuously and the ABS warning light may appear. Pull your vehicle over to a safe place and stop the vehicle.

Restart the vehicle. If the ABS warning light goes off, then your ABS system is normal. Otherwise, you may have a problem with the ABS. Contact an authorized Kia dealer as soon as possible.

* NOTICE

When you jump start your vehicle because of a drained battery, the vehicle may not run as smoothly and the ABS warning light may turn on at the same time. This happens because of low battery voltage. It does not mean your ABS has malfunctioned.

- Do not pump your brakes!
- Have the battery recharged before driving the vehicle.

Electronic Stability Control (ESC)

The ESC system is designed to stabilize the vehicle during cornering maneuvers.



ESC checks where you are steering and where the vehicle is actually going. ESC applies the brakes on individual wheels and intervenes with the vehicle management system to stabilize the vehicle.

ESC will not prevent accidents. Excessive speed in turns, abrupt maneuvers and hydroplaning on wet surfaces can still result in serious accidents.

Only a safe and attentive driver can prevent accidents by avoiding maneuvers that cause the vehicle to lose traction. Even with ESC installed, always follow all the normal precautions for driving -

including driving at safe speeds for the conditions.

▲ WARNING

For maximum protection, always wear your seat belt. No system, no matter how advanced, can compensate for all driver error and/or driving conditions. Always drive responsibly.

The ESC system is an electronic system designed to help the driver maintain vehicle control under adverse conditions. It is not a substitute for safe driving practices. Factors including speed, road conditions and driver steering input can all affect whether ESC will be effective in preventing a loss of control. It is still your responsibility to drive and corner at reasonable speeds and to leave a sufficient margin of safety.

When you apply your brakes under conditions which may lock the wheels, you may hear a "tik-tik" sound from the brakes, or feel a corresponding sensation in the brake pedal. This is normal and it means your ESC is active.

* NOTICE

A click sound may be heard in the vehicle compartment when the vehicle begins to move after the vehicle is started. These conditions are normal and indicate that the Electronic Stability Control System is functioning properly.

Electronic stability control (ESC) operation

ESC ON condition

- When the EV button is turned ON, ESC and ESC OFF indicator lights

appear for approximately 3 seconds, then ESC is turned on.

- Press the ESC OFF button for at least half a second after turning the vehicle ON to turn ESC off. (ESC OFF indicator will appear). To turn the ESC on, press the ESC OFF button (ESC OFF indicator light will go off).
- When starting the vehicle, you may hear a slight ticking sound. This is the ESC performing an automatic system self-check and does not indicate a problem.

When operating



When the ESC is in operation, the ESC indicator light blinks.

When the Electronic Stability Control is operating properly, you can feel a slight pulsation in the vehicle. This is only the effect of brake control and indicates nothing unusual.

When moving out of the mud or driving on a slippery road, pressing the accelerator pedal may not cause the vehicle speed to increase.

Electronic stability control (ESC) operation off



This car has 2 kinds of ESC off states.



If the vehicle stops when ESC is off, ESC remains off. Upon restarting the vehicle, the ESC will automatically turn on again.

ESC off state 1 - Traction control disabled

To turn off the traction control function and only operate the brake control function of the ESC, press the ESC OFF button (ESC OFF ) for less than 3

seconds and the ESC OFF indicator light (ESC OFF ) will appear.

ESC off state 2 - Traction & stability control disabled

To turn off the traction control function and the brake control function of the ESC, press the ESC OFF button (ESC OFF ) for more than 3 seconds. ESC OFF indicator light (ESC OFF ) will appear and ESC OFF warning chime will sound. At this state, the car stability control function does not operate any more.

Indicator light

ESC indicator light



ESC OFF indicator light



When EV button is turned to ON, the indicator light appears, then goes off if the ESC system is operating normally.

The ESC indicator light blinks whenever ESC is operating or appears when ESC fails to operate.

The ESC OFF indicator light comes on when the ESC is turned off with the button.

WARNING

Electronic Stability Control

Drive carefully even though your vehicle has Electronic Stability Control. It can only assist you in maintaining control under certain circumstances.

ESC OFF usage

When driving

- ESC should be turned on for daily driving whenever possible.
- To turn ESC off while driving, press the ESC OFF button while driving on a flat road surface.

WARNING

Operating ESC

Never press the ESC OFF button while ESC is operating (ESC indicator light blinks).

If ESC is turned off while ESC is operating, the vehicle may slip out of control.

NOTICE

- When operating the vehicle on a dynamometer, ensure that the ESC is turned off (ESC OFF light appeared). If the ESC is left on, it may prevent the vehicle speed from increasing, and result in false diagnosis.
- Turning the ESC off does not affect ABS or brake system operation.

Vehicle Stability Management (VSM)

This system provides further enhancements to vehicle stability and steering responses when a vehicle is driving on a slippery road or a vehicle detects changes in coefficient of friction between right wheels and left wheels when braking.

WARNING

Tire/Wheel Size

When replacing tires and wheels, make sure they are the same size as the original tires and wheels installed. Driving

with varying tire or wheel sizes may diminish any supplemental safety benefits of the VSM system.

Vehicle stability management (VSM) operation

When the VSM is in operation, ESC indicator light () blinks.

When the vehicle stability management is operating properly, you can feel a slight pulsation in the vehicle and/or abnormal steering responses (EPS- Electric Power Steering). This is only the effect of brake and EPS control and indicates nothing unusual.

The VSM does not operate when:

- Driving on a sloping road such as a gradient or incline
- Driving in reverse
- ESC OFF indicator light () remains on the instrument cluster
- EPS indicator light remains on the instrument cluster

Vehicle stability management (VSM) operation off

If you press the ESC OFF button to turn off the ESC, the VSM will also cancel and the ESC OFF indicator light () appears.

To turn on the VSM, press the button again. The ESC OFF indicator light goes out.

WARNING

Vehicle Stability Management

Drive carefully even though your vehicle has vehicle stability management. It can

only assist you in maintaining control of the vehicle under certain circumstances.

Malfunction indicator

The VSM can be deactivated even if you don't cancel the VSM operation by pressing the ESC OFF button. It indicates that a malfunction has been detected somewhere in the Electric Power Steering system or VSM system. If the ESC indicator light () or EPS warning light remains on, take your vehicle to an authorized Kia dealer and have the system checked.

The Vehicle Stability Management system is not a substitute for safe driving practices but a supplementary function only. It is the responsibility of the driver to always check the speed and the distance to the vehicle ahead. Always hold the steering wheel firmly while driving.

Your vehicle is designed to activate according to the driver's intention, even with installed VSM. Always follow all the normal precautions for driving at safe speeds for the conditions - including driving in inclement weather and on a slippery road.

WARNING

For maximum protection, always wear your seat belt. No system, no matter how advanced, can compensate for all driver error and/or driving conditions. Always drive responsibly.

Electronic Control Suspension (ECS) (if equipped)

The Electronic Control Suspension (ECS) controls the vehicle suspension automatically to maximize driving comfort by taking into account the driving condi-

tions such as speed, surface of the road cornering, stopping requirements and acceleration. If the ECS warning message comes on, you may have a problem with the ECS system. In this case, have your vehicle inspected by an authorized Kia dealer.

Hill-start Assist Control (HAC)

A vehicle has the tendency to roll back on a steep hill when it starts to go after stopping. The Hill-start Assist Control (HAC) prevents the vehicle from rolling back by applying the brakes automatically for approximately 2 seconds.

The brakes are released when the accelerator pedal is depressed or after about 2 seconds.

The HAC is activated only for about 2 seconds, so when the vehicle is starting off always depress the accelerator pedal.

WARNING

Maintaining Brake Pressure on Incline

HAC does not replace the need to apply brakes while stopped on an incline. While stopped, make sure you maintain brake pressure sufficient to prevent your vehicle from rolling backward and causing an accident. Don't release the brake pedal until you are ready to accelerate forward.

Brake Assistant System (BAS)

The Brake Assistant System provides additional pressure when the brake pedal is momentarily and strongly depressed in a situation sudden braking is required while driving.

The Brake Assistant System reduces the time for ABS (Anti-Lock Brake System) control to enter and consequently reduces the braking distance, by provid-

ing additional pressure up to the point of ABS intervention.

BAS operation

- When the vehicle speed is more than 20 mph (30 km/h) and the ABS control is not entered.
- When the brake pedal is depressed strongly over a certain level.
- When the friction of the road surface is above a certain level.

BAS operation off

- The vehicle speed is below 6 mph (10 km/h).
- The brake pedal is depressed over a certain conditions.
- The friction of the road surface is below a certain level.

WARNING

The system may not operate

depending on driver's driving habit, the degree to which the brake pedal is depressed and the road surface condition.

Good braking practices

Good braking practices help to drive safely and extend brake life.

- Check to be sure the parking brake is not engaged and the parking brake indicator light is out before driving away.
- Driving through water may get the brakes wet. They can also get wet when the vehicle is washed. Wet brakes can be dangerous! Your vehicle will not stop as quickly if the brakes are wet. Wet brakes may cause the vehicle to pull to one side.

To dry the brakes, apply the brakes lightly until the braking action returns to normal, taking care to keep the vehicle under control at all times. If the braking action does not return to normal, stop as soon as it is safe to do so and call an authorized Kia dealer for assistance.

- Don't coast down hills with the vehicle out of gear. This is extremely hazardous. Keep the vehicle in gear at all times, use the brakes to slow down, then shift to a lower gear so that vehicle braking will help you maintain a safe speed.
- Don't "ride" the brake pedal. Resting your foot on the brake pedal while driving can be dangerous because the brakes might overheat and lose their effectiveness. It also increases the wear of the brake components.
- If a tire goes flat while you are driving, apply the brakes gently and keep the vehicle pointed straight ahead while you slow down. When you are moving slowly enough for it to be safe to do so, pull off the road and stop in a safe place.
- Be cautious when parking on a hill. Firmly engage the parking brake and place the shifter dial in P. If your vehicle is facing downhill, turn the front wheels into the curb to help keep the vehicle from rolling. If your vehicle is facing uphill, turn the front wheels away from the curb to help keep the vehicle from rolling. If there is no curb or if it is required by other conditions to keep the vehicle from rolling, block the wheels.
- Under some conditions your parking brake can freeze in the engaged position. This is most likely to happen

when there is an accumulation of snow or ice around or near the rear brakes or if the brakes are wet. If there is a risk that the parking brake may freeze, apply it only temporarily while you put the shifter dial in P and block the rear wheels so the vehicle cannot roll. Then release the parking brake.

- Do not hold the vehicle on an incline with the accelerator pedal. This can cause the reduction gear to overheat. Always use the brake pedal or parking brake.
- Do not pump the brake pedal as the vehicle is equipped with ABS.
- The vehicle is equipped with electronic hydraulic brake. Due to malfunction or power instability, the brake booster may not operate normally and cause the brake pedal to feel stiff, resulting in longer braking distances. In this case, stop the vehicle by depressing the brake pedal stronger than usual. Have the system inspected by an authorized Kia dealer.
- The sound of electronic hydraulic brake operating or its motor may be heard temporarily when:
 - Repeatedly depressing the brake pedal
 - Opening driver's door

Drive mode integrated control system

The drive mode integrated control system allows the driver to select the drive mode most appropriate to the surrounding environment.

DRIVE MODE

The drive mode may be selected according to the driver's preference or road condition.



- The mode changes, as below, whenever the DRIVE MODE button is pressed.
- When restarting from ECO mode, the ECO mode is maintained, and when restarting from another mode, the mode is changed to NORMAL mode.

NORMAL mode

Normal mode is a driving with auto changing the driving mode on road condition.

ECO mode

ECO mode is a driving mode in which the vehicle can change the engagement status of the motor according to the situation required. Auto changing the driving mode helps improve energy efficiency.

Electric energy efficiency varies according to the driver's driving habit and road condition.

- When ECO mode is selected, the ECO indicator will appear on the instrument cluster and the color of the mood lamp will change.
- When ECO mode is activated:
 - The acceleration response may be slightly reduced if the accelerator pedal is depressed moderately.
 - The air conditioner performance may be limited.

The situations above are normal conditions when ECO mode is activated to help improve electric energy efficiency.

SPORT mode

SPORT mode is a driving mode improving driving performance.

In SPORT mode, the electric energy efficiency may decrease.

When SPORT mode is selected, the SPORT indicator will appear on the instrument cluster and the color of the mood lamp will change.

SNOW mode

SNOW mode is a driving mode improving driving performance by changing the engagement status of the motor according to the situation required. Auto changing the driving mode helps improve driving stability.

- Press and hold the drive mode button to select SNOW mode.
- When SNOW mode is selected, the SNOW indicator will appear on the instrument cluster and the color of the mood lamp will change.
- When SNOW mode is activated, the driving power is distributed to four wheels automatically, increasing the stability of the vehicle.

* NOTICE

- Depress the accelerator pedal softly on the snow and the ice.
- Keep appropriate distance from the vehicle in the front.
- Prevent rapid acceleration, deceleration and steering control. Abrupt driving on the snow may cause the accident.

Initial setting for each DRIVE MODE

* It is possible to set the driving condition for each drive mode, at the drive mode setting in Infotainment system, For more information, refer to the separately supplied manual.

DRIVE MODE	SNOW	NORMAL	ECO	SPORT
Characteristics	Snow driving	Normal driving mode	High electric energy efficiency mode	Sporty driving mode
Button activation	Press more than 1 second	Press	Press	Press
Cluster indicator	SNOW	-	ECO	SPORT
Climate system control	NORMAL	NORMAL	ECO/NORMAL*	NORMAL
Speed Limit	-	-	-	-
Regenerative braking level	0~1	0~3		
Brake mode	NORMAL	NORMAL/SPORT*	NORMAL	NORMAL/SPORT*

Active air flap



Active air flap system controls the air flap below the front bumper to cool the vehicle parts and improve energy efficiency.

Active air flap malfunction



A: Check Active Air Flap System

The active air flap system may not operate normally if the air flap is temporarily opened due to foreign factors or if the controller is contaminated by snow or rain, etc.

When the message is popped up on the display, stop the vehicle in a safe place and check the status of the air flap.

Start the vehicle after performing the necessary work like foreign matter removal and waiting 10 minutes. If the pop-up remains up, have the vehicle inspected by an authorized Kia dealer.

⚠ CAUTION

- Regardless of the pop-up, if the air flaps aren't in the same position, stop the vehicle and wait for 10 minutes and start the vehicle and inspect the air flap.
- The active air flap system is actuated by motors. Do not disturb actuation or

apply force excessively. It may cause failure.

* NOTICE

Active air flap system could be activate regardless of the vehicle condition.(Parking, driving, charging, etc.)

Forward Collision-Avoidance Assist (FCA) (Sensor Fusion)

Basic function



Forward Collision-Avoidance Assist is designed to help detect and monitor the vehicle ahead or help detect a powered two-wheeler, pedestrian or cyclist in the roadway and warn the driver that a collision is imminent with a warning message and warning and apply emergency braking.

In addition, if equipped with front corner radars, when driving at high speeds, Forward Collision-Avoidance Assist will help detect vehicles in front and adjacent lanes. If a collision is imminent when changing lanes, Forward Collision-Avoidance Assist will apply emergency braking to help prevent a collision. (if equipped)

Junction Turning function

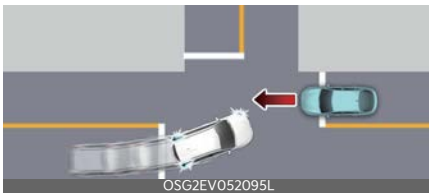

Junction Turning function can help avoid a collision with an oncoming vehicle in an adjacent lane when turning left at a crossroad with the turn signal on by applying emergency braking.

Junction Crossing function (if equipped)

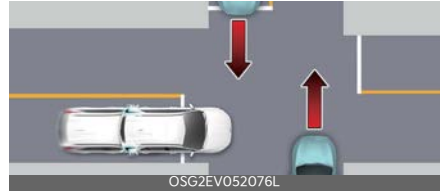

Junction Crossing function will help avoid a collision with oncoming vehicles on the left or right side when crossing an intersection by applying emergency braking.

Direct Oncoming response function (if equipped)



[A] : Oncoming vehicle

Direct Oncoming function helps reduce the speed at the collision when with a vehicle approaching from the opposite side is detected by applying emergency-braking.

Lane-Change Oncoming function (if equipped)



[A] : Oncoming vehicle

Lane-Change Oncoming function will help avoid a collision with an oncoming vehicle when changing lanes by assisting the driver's steering.

Lane-Change Side function (if equipped)

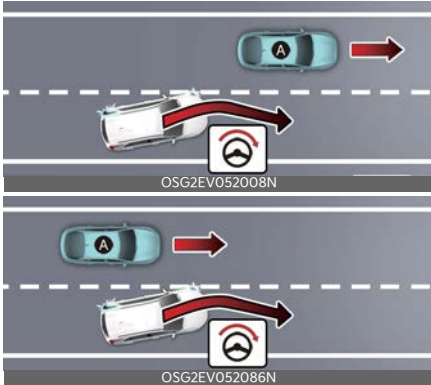

[A]: Front-side vehicle

Lane-Change Side function will help avoid a collision with the vehicle in the next lane when changing lanes by assisting the driver's steering.

Evasive Steering Assist function (if equipped)

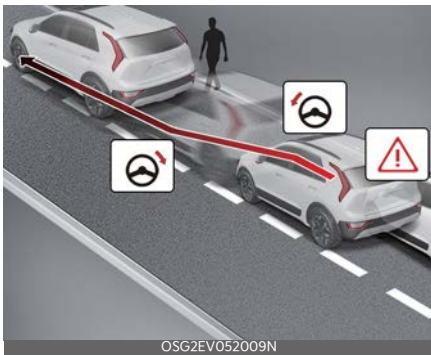

- Driver steering assist

Evasive Steering Assist function will help avoid a collision with a vehicle, pedestrian or cyclist ahead in the same lane. When a risk of collision is detected, Evasive Steering Assist function will warn the driver and if the driver steers to avoid collision it will assist the driver's steering.

- Evasive steering assist
Evasive Steering Assist function helps avoid a collision with a pedestrian or cyclist ahead in the same lane. When a risk or collision is detected, Evasive Steering Assist function will warn the driver and if there is space to avoid collision in the lane, it will assist the driver's steering.

Detecting sensor

Front view camera



Front radar



Front corner radar (if equipped)



Rear corner radar (if equipped)



Refer to the picture above for the detailed location of the detecting sensors.

CAUTION

Take the following precautions to maintain optimal performance of the detecting sensor:

- Never disassemble the detecting sensor or sensor assembly, or cause any damage to it.
 - If the detecting sensors have been replaced or repaired, have the vehicle inspected by an authorized Kia dealer.
 - Never install any accessories or stickers on the front windshield, or tint the front windshield.
 - Pay extreme caution to keep the front view camera dry.
 - Never place any reflective objects (for example, white paper, mirror) over the dashboard.
 - Do not place any objects near the front windshield or install any accessories on the front windshield. It can affect the performance of the defogging and defrosting function of the climate control system, which may prevent the Driver Assistance systems from operating.
 - Do not apply license plate frame or objects, such as a bumper sticker, film or a bumper guard, near the front radar cover.
- Always keep the front radar and cover clean and free of dirt and debris. Use only a soft cloth to wash the vehicle. Do not spray pressurized water directly on the sensor or sensor cover.
 - If the radar or around the radar has been damaged or impacted in any way, Forward Collision-Avoidance Assist may not properly operate even though a warning message does not appear on the cluster. Have the vehicle inspected by an authorized Kia dealer.
 - The genuine Kia front radar sensor covers are parts with quality and performance ensured. If arbitrarily applying paint on or changing the cover, Forward Collision-Avoidance Assist may not function properly. Use only Kia Genuine Parts or those of an equivalent standard with proven quality and performance to repair or replace the radar sensor covers.
 - Vehicles equipped with front corner radar and/or rear corner radar
 - Do not apply license plate frame or objects, such as a bumper sticker, film or a bumper guard, near the front corner radar or rear corner radar.
 - The function may not work properly when the bumper has been replaced, or the surroundings of the front corner radar or rear corner radar has been damaged or paint has been applied.
 - If a trailer, carrier, etc. is installed, it may adversely affect the performance of the rear corner radar or Forward Collision-Avoidance Assist may not operate properly.

Forward Collision-Avoidance Assist settings

Forward safety



A: Driver assistance

- 1 Driving safety
- 2 Forward safety

With the vehicle on, touch **Settings** → **Driver Assistance** → **Driving Safety** on the instrument cluster or **Settings** → **Vehicle** → **Driver Assistance** → **Driving Safety** on the infotainment system screen to set whether or not to use each function.

- **Forward safety:** Depending on the collision risk levels, an audible warning will sound, and the braking will be assisted. If this menu is deselected, Forward Collision-Avoidance Assist will turn off and the yellow warning light (🚗) will appear on the cluster.

Forward cross-traffic safety (if equipped)



A: Driver assistance

- 1 Forward safety
- 2 Forward cross-traffic safety

With the vehicle on, select **Settings** → **Vehicle** → **Driver assistance** → **Driving safety** → **Forward cross-traffic safety** from the infotainment system screen to turn on Junction Crossing function and deselect to turn off the function.

- **Forward cross-traffic safety:** Depending on the collision risk levels, with oncoming vehicles on the left or right side when crossing an intersection, an audible warning will sound, and the braking will be assisted.

Forward/side safety (if equipped)



A: Driver assistance

- 1 Driving safety
- 2 Forward/side safety

With the vehicle on, touch **Settings** → **Vehicle** → **Driver assistance** → **Driving safety** → **Forward/side safety** on the infotainment system. The forward and side vehicle detection function of For-

ward Collision-Avoidance Assist will be activated.

- **Forward/side safety:** Depending on the collision risk levels, an audible warning will sound, and the steering will be assisted. If this menu is deselected, Front/side safety will turn off and the yellow warning light (🚦) will appear on the cluster.

The driver can monitor Forward Collision-Avoidance Assist On/Off status from the Settings menu. If the Forward Safety warning light (🚦) or Emergency steering warning light (🚦) remains ON when Forward safety or Forward/side safety is selected, have the vehicle inspected by an authorized Kia dealer.

⚠️ WARNING

When the vehicle is restarted, Forward Collision-Avoidance Assist will always turn on. However, if **Forward safety** is deselected, the driver should always be aware of the surroundings and drive safely.

⚠️ CAUTION

- Forward safety settings include 'Basic function', 'Junction Turning function', and 'Direct On coming function' (if equipped) Forward Cross-Traffic Safety include 'Junction Crossing function' (if equipped). Forward/Side Cross-Traffic Safety includes 'Lane-change oncoming function', 'Lane-change side function' and 'Evasive Steering Assist function'. (if equipped)
- If Forward safety is deselected, Even if Forward Cross-Traffic safety and Forward/Side Cross-Traffic Safety is selected, 'Junction Crossing function' will not operate. (if equipped)

Forward Safety Warning Timing



A: Driving safety

1 Forward safety warning timing

2 Standard

3 Late

With the vehicle on, touch **Settings** → **Driver Assistance** → **Driving Safety** → **Forward Safety Warning Timing** on the instrument cluster or **Settings** → **Vehicle** → **Driver Assistance** → **Driving Safety** → **Forward Safety Warning Timing** on the infotainment system to change the initial warning activation timing of Forward Collision-Avoidance Assist.

- Use **Late** in normal driving conditions. If the Forward Safety Warning Timing seems sensitive, change it to **Late**.
- If **Late** is selected, Forward Collision-Avoidance Assist, warns the driver more slowly.

* NOTICE

- The setting of the Forward Safety Warning Timing applies to all functions of Forward Collision-Avoidance Assist.
- Even though **Standard** is selected for Forward Safety Warning Timing, if the

front vehicle suddenly stops, the warning may seem late.

- Select **Late** for Warning Timing when traffic is light and when driving speed is slow.

Warning Sound and Haptic



A: Driver Assistance

1 Warning Sound and Haptic

2 Warning Volume

3 Driving Safety Priority

With the vehicle on, touch **Settings** → **Vehicle** → **Driver Assistance** → **Warning Sound and Haptic** on the infotainment system to change the Warning Sound and Haptic.

- **Warning Volume:** You can adjust the Warning Volume from level 1 to 3.
- **Driving Safety Priority:** For safe driving, the audio volume will temporarily decrease to warn the driver with the audible warning.

* NOTICE

- Ensure that Warning Sound and Haptic you have set may apply to the Warning volume of other Driver Assistance systems.
- Warning Sound and Haptic will maintain its last setting even if the vehicle is restarted.
- If not equipped with the navigation system, select **User Settings** →

Driver Assistance to adjust the Warning Volume.

- The setting menu may not be available for your vehicle depending on the vehicle features and specifications.
- Descriptions of each Driver Assistance system may be slightly different from the owner's manual after updating the software of your infotainment system. In this case, scan the QR code in the infotainment system manual to access the web manual for checking the changes.

Forward Collision-Avoidance Assist operation

Basic function

The basic function for Forward Collision-Avoidance Assist is warned and controlled by the following level.

- Collision warning
- Emergency braking
- Stopping vehicle and ending brake control

Collision warning



A: **Collision warning!**

Collision warning will alert the driver with a warning message, an audible warning.

Collision Warning will be activated under the following conditions depending on the target ahead.

Your driving speed:

- For vehicle or powered two-wheeler: 6~124 mph (10~200 km/h)
- For pedestrian or cyclist: 6~53 mph (10~85 km/h)

Emergency braking



A: Emergency braking

The warning message, an audible warning will sound to warn the driver that emergency braking will be assisted. The brake assist will be activated and it helps avoiding collision of a vehicle, pedestrian and cyclist.

Emergency braking will be activated under the following your driving speed conditions, depending on the target ahead and the level of risk.

- For vehicle or powered two-wheeler:

	Driving target	Stopped target
Weak braking power	Approximately 6~124 mph (10~200 km/h)*	
Strong braking power	Approximately 6~80 mph (10~130 km/h)*	Approximately 6~47 mph (10~75 km/h) (6~62 mph (10~100 km/h))*

*: If Forward Collision-Avoidance Assist judges that avoiding a collision is difficult even by changing the driving lane. The function operate range may decrease due to surroundings of the vehicle. (if equipped)

- For pedestrian or cyclist: 6~40 mph (10~65 km/h)

CAUTION

The function operation range may decrease due to the front traffic condition or the surroundings of the vehicle.

Stopping vehicle and ending brake control



A: Drive carefully

When the vehicle is stopped due to emergency braking, the warning message will appear on the cluster.

For your safety, the driver should depress the brake pedal immediately and check the surroundings.

- Brake control will end after the vehicle is stopped by emergency braking for approximately 2 seconds.

Junction Turning function

The Junction turning function is warned and controlled by the following level.

- Collision warning
- Emergency braking
- Stopping vehicle and ending brake control

Collision warning



A: Collision warning!

Collision warning will alert the driver with a warning message, and an audible warning.

Collision warning will be activated in the following conditions.

- Your driving speed: Approximately 6~19 mph (10~30 km/h)
- Oncoming vehicle speed: Approximately 19~44 mph (30~70 km/h)

Emergency braking



A: Emergency braking

The warning message, an audible warning will sound to warn the driver that emergency braking will be assisted. The brake assist will be activated and it helps avoiding collision of a vehicle.

Emergency braking will be activated in the following conditions.

- Your driving speed: Approximately 6~19 mph (10~30 km/h)
- Oncoming vehicle speed: Approximately 19~44 mph (30~70 km/h)

Stopping vehicle and ending brake control



A: Drive carefully

When the vehicle is stopped due to emergency braking, the warning message will appear on the cluster.

For your safety, the driver should depress the brake pedal immediately and check the surroundings.

- Brake control will end after the vehicle is stopped by emergency braking for approximately 2 seconds.

Junction Crossing function (if equipped)

Warning and control

The Junction Crossing function is warned and controlled by the following level.

- Collision warning
- Emergency braking
- Stopping vehicle and ending brake control

Collision warning



A: Collision Warning!

Collision warning will alert the driver with a warning message, and an audible warning.

Collision warning will be activated in the following conditions.

- Your driving speed: Approximately 6~30 mph (10~50 km/h)
- Crossing vehicle speed: Approximately 6~12 mph (10~60 km/h)

Emergency braking

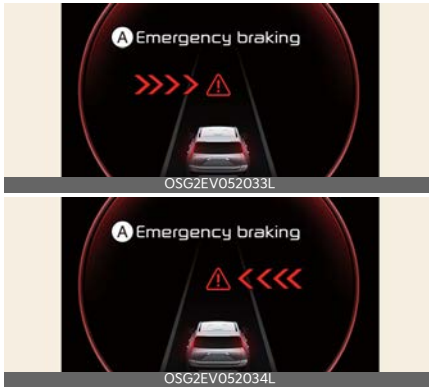

A: Emergency braking

The warning message, an audible warning will sound to warn the driver that emergency braking will be assisted. The brake assist will be activated and it helps avoiding collision of a vehicle.

Emergency braking will be activated in following conditions.

- Your driving speed: Approximately 6~19 mph (10~30 km/h)
- Crossing vehicle speed: Approximately 6~12 mph (10~20 km/h)

Stopping vehicle and ending brake control



A: Drive carefully

When the vehicle is stopped due to emergency braking, the warning message will appear on the cluster.

For your safety, the driver should depress the brake pedal immediately and check the surroundings.

- Brake control will end after the vehicle is stopped by emergency braking for approximately 2 seconds.

⚠ CAUTION

If the collision angle with the crossing vehicle is beyond a certain range, Junction Crossing Warning and control may be late or may not operate.

Direct Oncoming function (if equipped)

Warning and control

The Direct Oncoming function is warned and controlled by the following level.

- Collision warning
- Emergency braking
- Stopping vehicle and ending brake control

Collision warning



A: Collision Warning!

The warning message, an audible warning will sound to warn the driver of a collision.

Collision warning will be activated in following conditions.

- Your driving speed: Approximately 6~80 mph (10~130 km/h)
- Oncoming vehicle speed: Approximately above 6 mph (10 km/h)
- Oncoming powered two-wheeler speed: Approximately above 16 mph (25 km/h)

- Relative speed: Approximately below 84 mph (140 km/h)

Emergency braking



A: Emergency braking

The warning message, and an audible warning will sound to warn the driver of a collision.

Collision warning will be activated in following conditions.

- Your driving speed: Approximately 19-80 mph (30~130 km/h)
- Oncoming vehicle speed: Approximately above 6 mph (10 km/h)

Stopping vehicle and ending brake control



A: Drive carefully

When the vehicle is stopped due to emergency braking, the warning message will appear on the cluster.

For your safety, the driver should depress the brake pedal immediately and check the surroundings.

- Brake control will end after the vehicle is stopped by emergency braking for approximately 2 seconds

⚠ CAUTION

If your vehicle or the oncoming vehicle is not driving straight, Front Oncoming function warning and control may be late or may not operate.

Lane-change oncoming function (if equipped)

Warning and control

The Lane-change oncoming function is warned and controlled by the following level.

- Collision warning
- Emergency steering

Collision warning



A: Collision Warning!

Collision warning will alert the driver with a warning message, and an audible warning will sound.

Collision warning will be activated in the following conditions.

- Your driving speed: Approximately 25~90 mph (40~145 km/h)
- Oncoming vehicle speed: Approximately above 6 mph (10 km/h)
- Relative speed: Approximately below 124 mph (200 km/h)

Emergency steering



A: Emergency Steering

To warn the driver that emergency steering will be assisted, the warning message will appear on the cluster, and an audible warning will sound. Emergency steering will be activated in following conditions.

- Your driving speed: Approximately 25~90 mph (40~145 km/h)
- Oncoming vehicle speed: Approximately above 6 mph (10 km/h)
- Relative speed: Approximately below 124 mph (200 km/h)

Lane-change side function (if equipped)

Warning and control

The Lane-change side function is warned and controlled by the following level.

- Collision warning
- Emergency steering

Collision warning



A: Collision Warning!

To warn the driver of a collision, the warning message will appear on the cluster, and an audible warning will sound.

Emergency steering will be activated in following conditions.

- Your driving speed: Approximately 25~90 mph (40~145 km/h)

Emergency steering



A: Emergency Steering

To warn the driver that emergency steering will be assisted, the warning message will appear on the cluster, and an audible warning will sound.

The warning light on the outside rear view mirror (side view mirror) will appear when the vehicle on both lanes is detected from the rear. Steering will be assisted to avoid collision.

Emergency steering will be activated in following conditions.

- Your driving speed: Approximately 25~90 mph (40~145 km/h)
- Vehicle or powered two-wheeler in the next lane: Driving

⚠ CAUTION

- Lane-Change Side function does not operate if the oncoming vehicle from the front side is stopped.
- The detecting area of front and rear corner radar is determined by a standard lane width of the standard road. The warning may appear from the vehicle driving on the next next lane for narrow roads. Or, the warning may not appear due to not detecting vehicle on the next lane for wide roads.
- Lane change side function is deactivated in following conditions:
 - Approaching to next lane for standard amount of distance
 - Getting away from the collision hazard direction
 - Sharply steering the vehicle
 - Depressing the brake pedal
 - Forward Collision-Avoidance Assist is operating
- After Lane change side function is activated or lane change is done,

move your vehicle to the center of the lane afterwards.

Lane change side function will not operate when the vehicle is not being driven on the center of the lane.

*** NOTICE**

Emergency steering will only warn the driver about the danger if additional accidents are expected.

Evasive Steering Assist function (if equipped)

Warning and control

The Evasive Steering Assist function is warned and controlled by the following level.

- Emergency Steering

Emergency Steering (Driver steering assist)

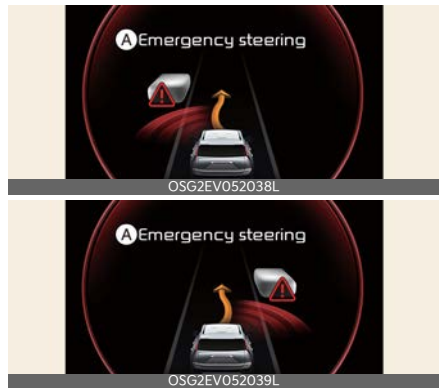

A: Emergency Steering

To warn the driver that emergency steering will be assisted, the warning message will appear on the cluster, and an audible warning will sound. If there is a risk of collision with a vehicle, pedestrian and cyclist in front, the steering will be assisted to help prevent collision

when the driver steers the vehicle to avoid collision.

Emergency Steering will be activated in following conditions.

- Your driving speed: Approximately 25~53 mph (40~85 km/h)

Emergency Steering (Evasive steering assist)

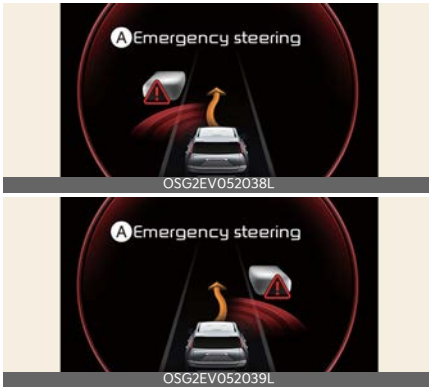

A: Emergency Steering

To warn the driver that emergency steering will be assisted, the warning message will appear on the cluster, and an audible warning will sound. If there is high risk of collision with a pedestrian and cyclist in front, and the vehicle speed to operate emergency braking is within the operation range, the steering will be assisted to help prevent collision when there is space to avoid collision in the driving lane.

Emergency Steering will be activated in following conditions.

- Your driving speed: Approximately 40~47 mph (65~75 km/h)

CAUTION

- The steering wheel may turn automatically when emergency steering is operating.

- Emergency steering will automatically cancel when risk factors disappear. If necessary, the driver must steer the vehicle.
- Emergency steering may not operate or may cancel during operation if the steering wheel is held tight or steered in the opposite direction.
- When steering is assisted to avoid collision with a vehicle, pedestrian and cyclist, Evasive steering assist will be canceled if collisions with other objects (vehicles, pedestrians, or cyclists) are expected.
- Evasive steering assist may not operate if space to avoid collision in the driving lane is insufficient.

*** NOTICE**

For more details on warning messages, refer to "Collision warning" on page 6-44.

WARNING

- For your safety, change the Settings after parking the vehicle at a safe location.
- Forward Collision-Avoidance Assist does not operate in all situations or cannot avoid all collisions.
- The driver should hold the responsibility to control the vehicle. Do not solely depend on Forward Collision-Avoidance Assist. Rather, maintain a safe braking distance, and if necessary, depress the brake pedal to reduce driving speed or to stop the vehicle.
- Never deliberately operate Forward Collision-Avoidance Assist on people, objects, etc. It may cause serious injury or death.

- Forward Collision-Avoidance Assist may not operate if the driver depresses the brake pedal to avoid collision.
- Depending on the road and driving conditions, Forward Collision-Avoidance Assist may warn the driver late or may not warn the driver.
- During Forward Collision-Avoidance Assist operation, the vehicle may stop suddenly injuring passengers and shifting loose objects. Always have the seat belt on and keep loose objects secured.
- If any other function's warning message is displayed or audible warning is generated, Forward Collision-Avoidance Assist warning message may not be displayed and audible warning may not be generated.
- You may not hear the warning sound of Forward Collision-Avoidance Assist if the surrounding is noisy.
- Forward Collision-Avoidance Assist may turn off or may not operate properly or may operate unnecessarily depending on the road conditions and the surroundings.
- Even if there is a problem with Forward Collision-Avoidance Assist, the vehicle's basic braking performance will operate properly.
- During emergency braking, braking control by Forward Collision-Avoidance Assist will automatically cancel when the driver excessively depresses the accelerator pedal or sharply steers the vehicle.

the speed range to operate Forward Collision-Avoidance Assist may reduce. Forward Collision-Avoidance Assist may only warn the driver, or it may not operate.

- Forward Collision-Avoidance Assist will operate under certain conditions by judging the risk level based on the condition of the oncoming vehicle, driving direction, speed and surroundings.
- When a collision with a surrounding vehicle is expected, Lane-change oncoming, Lane-change side and Evasive steering assist functions will only warn the driver. (if equipped)

*** NOTICE**

- When a collision is imminent, the Forward Collision-Avoidance Assist may assist the driver with brakes if the driver fails to brake enough.
- The images or colors may be displayed differently depending on the specifications of the instrument cluster or theme.

Forward Collision-Avoidance Assist malfunction and limitations

Forward Collision-Avoidance Assist malfunction



A: Check forward safety systems

⚠ CAUTION

- Depending on the condition of the vehicle, motorcycle, pedestrian and cyclist in front and the surroundings,



A: Check forward/side safety system

When Forward Collision-Avoidance Assist is not working properly, the warning message will appear, and the yellow (⚠️), (⚠️) and (⚠️) warning lights will appear on the cluster. Have the vehicle inspected by an authorized Kia dealer.

Forward Collision-Avoidance Assist disabled

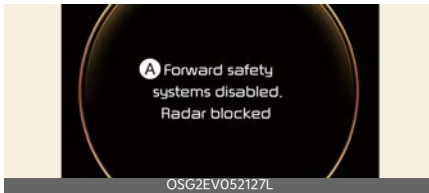

A: Forward safety system disabled. Radar blocked

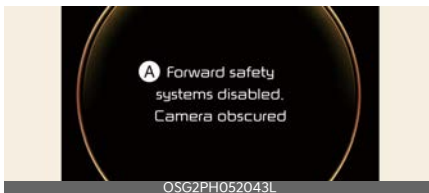

A: Forward safety systems disabled. Camera obscured

When the front windshield where the front view camera is located, front radar cover, bumper or sensor is covered with foreign material, such as snow or rain, it can reduce the detecting performance and temporarily limit or disable Forward Collision-Avoidance Assist.

If this occurs the warning message, and the yellow (⚠️), (⚠️) and (⚠️) warning lights will appear on the cluster.

Forward Collision-Avoidance Assist will operate properly when snow, rain or foreign material is removed.

If Forward Collision-Avoidance Assist does not operate properly after obstruction (snow, rain, or foreign material) is removed (including trailer, carrier, etc. from the rear bumper), have the vehicle inspected by an authorized Kia dealer.

⚠️ WARNING

- Even though the warning message or warning light does not appear on the cluster, Forward Collision-Avoidance Assist may not properly operate.
- Forward Collision-Avoidance Assist may not properly operate in an area (e.g. open terrain), where there is nothing to detect, or detecting sensor is covered in foreign material after turning ON the vehicle.

Limitations of Forward Collision-Avoidance Assist

Forward Collision-Avoidance Assist may not operate properly, or it may operate unexpectedly under the following circumstances:

- The detecting sensor or the surroundings are contaminated or damaged
- The temperature around the front view camera is high or low due to surrounding environment
- The camera lens is contaminated due to tinted, filmed or coated windshield, damaged glass, or sticky foreign material (sticker, bug, etc.) on the glass
- Moisture is not removed or frozen on the windshield

- Washer fluid is continuously sprayed, or the wiper is on
- Driving in heavy rain or snow, or thick fog
- The field of view of the front view camera is obstructed by sun glare
- Street light or light from an oncoming traffic is reflected on the wet road surface, such as a puddle on the road
- An object is placed on the dashboard
- Your vehicle is being towed
- The surrounding is very bright or the surrounding is very dark, such as in a tunnel, etc.
- The brightness changes suddenly, for example when entering or exiting a tunnel
- The brightness outside is low, and the headlamps are not on or are not bright
- Only part of the vehicle, powered two-wheeler, pedestrian or cyclist is detected
- The vehicle or powered two-wheeler in front is a bus, heavy truck, truck with an unusually shaped cargo, trailer, etc.
- The vehicle or powered two-wheeler in front has no tail lights, tail lights are located unusually, etc.
- The brightness outside is low, and the tail lamps are not on or are not bright
- The rear of the front vehicle is small or the vehicle does not look normal, such as when the vehicle is tilted, overturned, or the side of the vehicle is visible, etc.
- The front vehicle's ground clearance is low or high
- A vehicle, powered two-wheeler, pedestrian or cyclist suddenly cuts in front
- The bumper around the front radar is impacted, damaged or the front radar is out of position
- The temperature around the front radar is high or low
- Driving through a tunnel or iron bridge
- Driving in vast areas where there are few vehicles or structures (for example, desert, meadow, suburb, etc.)
- Driving near areas containing metal substances, such as a construction zone, railroad, etc.
- A material is near that reflects very well on the front radar, such as a guardrail, nearby vehicle, etc.
- The cyclist in front is on a bicycle made of material that does not reflect on the front radar
- The vehicle or powered two-wheeler in front is detected late
- The vehicle or powered two-wheeler in front is suddenly blocked by an obstacle
- The vehicle or powered two-wheeler in front suddenly changes lane or suddenly reduces speed
- The vehicle or powered two-wheeler in front is bent out of shape
- The front vehicle or powered two-wheeler or motorcycle speed is fast or slow
- The vehicle or powered two-wheeler in front steers in the opposite direction of your vehicle to avoid a collision
- With a vehicle or powered two-wheeler in front, your vehicle changes lane at low speed
- The vehicle in front is covered with snow
- You are departing or returning to the lane

- Unstable driving
- You are on a roundabout and the vehicle or powered two-wheeler in front is not detected
- You are continuously driving in a circle
- The vehicle in front has an unusual shape
- The vehicle in front is driving uphill or downhill
- The pedestrian or cyclist is not fully detected, for example, if the pedestrian is leaning over or is not fully walking upright
- The pedestrian or cyclist is wearing clothing or equipment that makes it difficult to detect
- The pedestrian or cyclist is difficult to distinguish from the similarly shaped structure in the surroundings
- You are driving by a pedestrian, cyclist, traffic signs, structures, etc., near the intersection
- When driving in the following places
 - Driving through steam, smoke or shadow
 - Driving through a tunnel or iron bridge
 - Driving in large areas where there are few vehicles or structures (i.e. desert, meadow, suburb, etc.)
 - Driving in a parking lot
 - Driving through toll gate, construction areas, partially paved roads, bumpy roads, speed bumps, etc.
 - Driving near areas containing metal substances, such as a construction zone, railroad, etc.
 - Driving on an incline road, curved road, etc.
 - Driving through a roadside with trees or streetlights
 - Driving through a narrow road where trees or grass are overgrown
 - There is interference by electromagnetic waves, such as driving in an area with strong radio waves or electrical noise
- The adverse road conditions cause excessive vehicle vibrations while driving
- Your vehicle height is low or high due to heavy loads, abnormal tire pressure, etc.



The illustration above shows the image the front view camera and front radar are capable of detecting as a vehicle, powered two-wheeler, pedestrian and cyclist.

- The pedestrian or cyclist in front is moving very quickly
- The pedestrian or cyclist in front is short or is posing a low posture
- The pedestrian or cyclist in front has impaired mobility or moving intersected with the driving direction
- There is a group of pedestrians, cyclists or a large crowd in front
- The pedestrian or cyclist is wearing clothing that easily blends into the background, making it difficult to detect
- Junction crossing, Lane-change oncoming, Lane-change side, Evasive steering assist function (if equipped)

- The temperature around the front corner radar or rear corner radar is high or low
- A trailer or carrier is installed around the rear corner radar
- The front corner radar or rear corner radar is covered with snow, rain, dirt, etc.
- The bumper around the front corner radar or rear corner radar is covered with objects, such as a bumper sticker, bumper guard, bike rack, etc.
- The bumper around the front corner radar or rear corner radar is impacted, damaged or the radar is out of position
- The front corner radar or rear corner radar is blocked by other vehicles, walls or pillars
- Driving on a highway (or motorway) ramp
- Driving on a road where the guardrail or wall is in double structure
- The other vehicle drives very close behind your vehicle, or the other vehicle passes by your vehicle in close proximity
- The speed of the other vehicle is very fast that it passes by your vehicle in a short time
- Your vehicle passes by the other vehicle
- Your vehicle has started at the same time as the vehicle next to you and has accelerated
- The vehicle in the next lane moves two lanes away from you, or when the vehicle two lanes away moves to the next lane from you
- A motorcycle or bicycle is detected
- A vehicle such as a flat trailer is detected
- A big vehicle such as a bus or truck is detected
- A small moving obstacle such as a pedestrian, animal, shopping cart or a baby stroller is detected
- A vehicle with low height such as a sports car is detected
- The lane is difficult to see due to foreign material, such as rain, snow, dust, sand, oil and water puddles
- The color of the lane marking is not distinguishable from the road
- There are markings on the road near the lane or the markings on the road looks similar to the lane markings
- The shadow is on the lane marking by a median strip, trees, guardrail, noise barriers, etc.
- The lane number increases or decreases, or the lane markings are crossing
- There are more than two lane markings on the road
- The lane markings are complicated or a structure substitutes for the lines, such as a construction area
- There are road markings, such as zig-zag lanes, crosswalk markings and road signs
- The lane suddenly disappears, such as at the intersection
- The lane is very wide or narrow
- There is a curb or road edges without a lane
- The vehicle in front is driving with one side on the lane marking
- The distance to the front vehicle is extremely short or the vehicle in front is covering the lane marking (or road edge)

⚠️ WARNING

- Driving on a curved road



Forward Collision-Avoidance Assist may not detect other vehicles, powered two-wheelers, pedestrians or cyclists in front of you when driving on curved roads adversely affecting the performance of the sensors. This may result in no warning, braking assist or steering assist (if equipped) when necessary.

When driving on a curve, you must maintain a safe braking distance, and if necessary, steer the vehicle and depress the brake pedal to reduce your driving speed in order to maintain a safe distance.



Forward Collision-Avoidance Assist may detect a vehicle, powered two-wheeler, pedestrian or cyclist in the next lane or outside the lane when driving on a curved road.

If this occurs, Forward Collision-Avoidance Assist may unnecessarily warn the driver and control the brake or steering (if equipped). Always check the traffic conditions around the vehicle.

- Driving on an inclined road

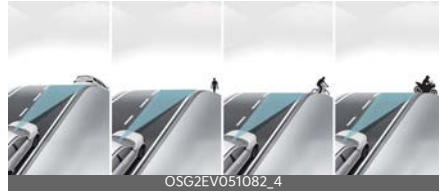

Forward Collision-Avoidance Assist may not detect other vehicles, powered two-wheelers, pedestrians or cyclists in front of you while driving uphill or downhill, adversely affecting the performance of the sensors.

This may result in unnecessary warning, braking assist, steering assist (if equipped) or no warning, braking assist, steering assist (if equipped) when necessary.

Also, vehicle speed may rapidly decrease when a vehicle, powered two-wheeler, pedestrian or cyclist ahead is suddenly detected.

Always have your eyes on the road while driving uphill or downhill and if necessary, steer your vehicle and depress the brake pedal to reduce your driving speed in order to maintain a safe distance.

- Changing lanes



[A]: Your vehicle,

[B]: Lane changing vehicle

When a vehicle (B) moves into your lane from an adjacent lane, it cannot be detected by the sensor until it is in the sensor's detection range.

Forward Collision-Avoidance Assist may not immediately detect the vehicle when the vehicle changes lanes abruptly. In this case, you must maintain a safe braking distance, and if necessary, steer your vehicle and depress the brake pedal to reduce your driving speed in order to maintain a safe distance.



[A]: Your vehicle,

[B]: Lane changing vehicle,

[C]: Same lane vehicle

When a vehicle (B) in front of you merges out of the lane, Forward Collision-Avoidance Assist may not immediately detect the vehicle (C) that is now in front of you. In this case, you must maintain a safe braking distance, and if necessary, steer your vehicle and depress the brake pedal to reduce your driving speed in order to maintain a safe distance.

- Detecting vehicle



If the vehicle in front of you has cargo that extends rearward from the cab,

or when the vehicle in front of you has higher ground clearance, additional special attention is required. Forward Collision-Avoidance Assist may not be able to detect the cargo extending from the vehicle. In these instances, you must maintain a safe braking distance from the rearmost object, and if necessary, steer your vehicle and depress the brake pedal to reduce your driving speed in order to maintain distance.

WARNING

- When you are towing a trailer or another vehicle, turn off Forward Collision-Avoidance Assist for safety reasons.
- Forward Collision-Avoidance Assist may operate if objects that are similar in shape or characteristics to vehicles, motorcycles, pedestrians and cyclists are detected.
- Forward Collision-Avoidance Assist does not operate on bicycles, or smaller wheeled objects, such as luggage bags, shopping carts, or strollers.
- Forward Collision-Avoidance Assist may not operate properly if interfered by strong electromagnetic waves.
- Forward Collision-Avoidance Assist may not operate for 15 seconds after the vehicle is started, or the front view camera is initialized.

This device complies with Part 15 of the FCC rules.

Operation is subject to the following three conditions:

1. This device may not cause harmful interference, and
2. This device must accept any interference received, including interference that may cause undesired operation.
3. Changes or modifications not expressly approved by the party responsible for compliance could void the user's authority to operate the device.

Radio frequency radiation exposure information:

This equipment complies with FCC radiation exposure limits set forth for an uncontrolled environment. This equipment should be installed and operated with minimum distance of 8 in (20 cm) between the radiator (antenna) and your body.

This transmitter must not be colocated or operating in conjunction with any other antenna or transmitter.

Lane Keeping Assist (LKA)

Lane Keeping Assist is designed to help detect lane markings (or road edges) while driving over a certain speed. Lane Keeping Assist will warn the driver if the vehicle leaves the lane without using the turn signal, or will automatically assist the driver's steering to help prevent the vehicle from departing the lane.

Detecting sensor

Front view camera



The front view camera is used as a detecting sensor to detect lane markings (or road edges).

Refer to the picture above for the detailed location of the detecting sensor.

CAUTION

For more details on the precautions of the front view camera, refer to "Forward Collision-Avoidance Assist (FCA) (Sensor Fusion)" on page 6-39.

Lane Keeping Assist settings

Lane safety

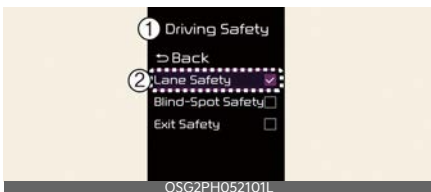

A: Driver Assistance

1 Driving Safety

2 Lane Safety

With the vehicle on, touch **Settings** → **Driver Assistance** → **Driving Safety** on the instrument cluster or **Settings** → **Vehicle** → **Driver Assistance** → **Driving Safety** on the infotainment system.

- **Lane Safety:** If Lane safety is selected, Lane Keeping Assist will automatically assist the driver's steering when lane departure is detected to help prevent the vehicle from moving out of its lane. If Lane safety is deselected, the indicator light (🚗) will be turned off.

WARNING

- Lane Keeping Assist does not control the steering wheel when the vehicle is driven in the middle of the lane.
- The driver should always be aware of the surroundings and steer the vehicle if **Lane Safety** is deselected.

Warning Sound and Haptic

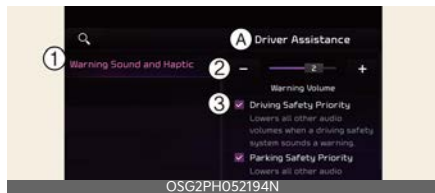

A: Driver Assistance

1 Warning Sound and Haptic

2 Warning Volume

3 Driving Safety Priority

With the vehicle on, touch **Settings** → **Vehicle** → **Driver Assistance** → **Warning Sound and Haptic** on the infotainment system to change the Warning Sound and Haptic.

- **Warning Volume:** You can adjust the Warning Volume from level 1 to 3.
- **Driving Safety Priority:** For safe driving, the audio volume will temporarily decrease to warn the driver with the audible warning.

* NOTICE

- Ensure that Warning Sound and Haptic you have set may apply to the Warning volume of other Driver Assistance systems.
- Warning Sound and Haptic will maintain its last setting even if the vehicle is restarted.
- If not equipped with the navigation system, select **User Settings** → **Driver Assistance** to adjust the Warning Volume.
- The setting menu may not be available for your vehicle depending on the vehicle features and specifications.
- Descriptions of each Driver Assistance system may be slightly different from the owner's manual after updating the software of your infotainment system. In this case, scan the QR code in the infotainment system manual to access the web manual for checking the changes.

Lane Keeping Assist operation

Turning Lane Keeping Assist On/Off



- With the vehicle ON, press and hold the Lane Driving Assist button to turn on/off Lane Keeping Assist. If Lane Keeping Assist is activated, the indicator (🚗) will be displayed on the cluster.

* NOTICE

- When the Lane Driving Assist button is pressed shortly, Lane Following Assist will turn on and off.
- Whenever the vehicle is turned off and on, Lane safety settings will always retain its settings.

6

Warning and control

Left



Right



Lane Keeping Assist will warn and help control the vehicle with Lane Departure Warning and Lane Keeping Assist.

Lane Departure Warning

The green (🚗) indicator light and the lane line depending on which direction the vehicle is steering will blink on the cluster.

An audible warning will sound to warn the driver that the vehicle is departing from the projected lane in front.

Lane departure warning will be activated in the following conditions.

- Your driving speed: Approximately 40~120 mph (60~200 km/h)

Lane Keeping Assist

The green (🚗) indicator light will blink on the cluster, and the steering wheel will make adjustments to warn the driver that the vehicle is departing from the projected lane in front.

Lane Keeping Assist will be activated in the following conditions.

- Your driving speed: Approximately 40~120 mph (60~200 km/h)

Hands-off warning



A: Keep hands on steering wheel

If the driver takes their hands off the steering wheel for several seconds, the warning message will appear on the cluster, and an audible warning will sound in stages.

⚠ WARNING

- The steering wheel may not be assisted if the steering wheel is held very tight or the steering wheel is steered over a certain degree.
- Lane Keeping Assist does not operate at all times. It is the responsibility of the driver to safely steer the vehicle and to maintain the vehicle in its lane.
- The hands-off warning message may appear late depending on road conditions. Always have your hands on the steering wheel while driving.
- If the steering wheel is held very lightly, the hands-off warning message may appear because Lane Keeping Assist may not recognize that the driver has their hands on the steering wheel.
- If you attach objects to the steering wheel, the hands-off warning may not work properly.

* NOTICE

- For more details on setting the functions in the infotainment system Vehicle Settings, refer to "User settings mode" on page 5-78.
- When lane markings (or road edges) are detected, the lane lines on the cluster will change from grey to white and the green (🚗) indicator light will appear.
- When lane markings (or road edges) are detected, the green lane lines on the cluster may appear.

Lane undetected



Lane detected



- The images and colors in the instrument cluster may differ depending on the cluster type or theme selected from the settings menu.
- Even though the steering is assisted by Lane Keeping Assist, the driver may control the steering wheel.
- The steering wheel may feel heavier or lighter when the steering wheel is assisted by Lane Keeping Assist than when it is not.

Lane Keeping Assist malfunction and limitations

Lane Keeping Assist malfunction

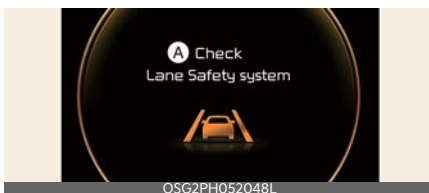

A: Check Lane Safety system

When Lane Keeping Assist is not working properly, the warning message will appear and the yellow (🚗) indicator

light will appear on the cluster. If this occurs, have the function inspected by an authorized Kia dealer.

Limitations of Lane Keeping Assist

Lane Keeping Assist may not operate properly or may operate unexpectedly under the following circumstances:

- The lane is contaminated or difficult to detect because:
 - The lane markings (or road edge) are covered with rain, snow, dirt, oil, etc.
 - The color of the lane marking (or road edge) is not distinguishable from the road
 - There are markings (or road edges) on the road near the lane or the markings (or road edges) on the road look similar to the lane markings (or road edge)
 - The lane marking (or road edge) is indistinct or damaged
 - The shadow is on the lane marking (or road edge) by a median strip, trees, guardrail, noise barriers, etc.
- The lane number increases or decreases, or the lane markings (or road edges) are crossing
- There are more than two lane markings (or road edges) on the road
- The lane markings (or road edges) are complicated or a structure substitutes for the lines, such as a construction area
- There are road markings, such as zig-zag lanes, crosswalk markings and road signs
- The lane suddenly disappears, such as at the intersection
- The lane (or road width) is very wide or narrow

- There is a road edge without a lane
- There is a boundary structure in the roadway, such as a tollgate, sidewalk, curb, etc.
- The distance to the front vehicle is extremely short or the vehicle in front is covering the lane marking (or road edge)

* NOTICE

For more details on the limitations of the front view camera, refer to "Forward Collision-Avoidance Assist (FCA) (Sensor Fusion)" on page 6-39.

⚠ WARNING

- The driver should hold the responsibility to safely drive and control the vehicle. Do not solely rely on Lane Keeping Assist and drive dangerously.
 - The operation of Lane Keeping Assist can be canceled or not work properly depending on road conditions and surroundings. Always be cautious while driving.
 - Refer to "Limitations of Lane Keeping Assist" if the lane is not detected properly.
 - When you are towing a trailer or another vehicle, turn off Lane Keeping Assist for safety reasons.
 - If the vehicle is driven at high speed, the steering wheel will not be controlled. The driver must always follow the speed limit when using Lane Keeping Assist.
 - If any other function's warning message is displayed or audible warning is generated, Lane Keeping Assist warning message may not be displayed and audible warning may not be generated.
- You may not hear the warning sound of Lane Keeping Assist if the surrounding is noisy. Adjust the vehicle volume moderately and always pay attention to the surrounding.
 - If you attach objects to the steering wheel, steering may not be assisted properly.
 - Lane Keeping Assist may not operate for 15 seconds after the vehicle is started, or the front view camera is initialized.
 - Lane Keeping Assist will not operate when:
 - The turn signal or hazard warning flasher is turned on.
 - The vehicle is not driven in the center of the lane when Lane Keeping Assist is turned on or right after changing a lane.
 - ESC (Electronic Stability Control) or VSM (Vehicle Stability Management) is activated.
 - The vehicle is driven rapidly on a curve.
 - Vehicle speed is below 35 mph (55 km/h) or above 130 mph (210 km/h).
 - The vehicle makes sharp lane changes.
 - The vehicle brakes suddenly.

Blind-Spot Collision-Avoidance Assist (BCA) (if equipped)

Blind-Spot Collision-Avoidance Assist is designed to help detect and monitor approaching vehicles in the driver's blind spot area and warn the driver of a possible collision with a warning message and audible warning.

In addition, if there is a risk of collision when driving forward out of a parking space, Blind-Spot Collision-Avoidance Assist can help avoid a collision assisting with applying the brake.



Blind-Spot Collision-Avoidance Assist helps detect and informs the driver that a vehicle is in the blind spot.

⚠ CAUTION

The detecting range may vary depending on the speed of your vehicle. Even if there is a vehicle in the blind spot area, Blind-Spot Collision-Avoidance Assist may not warn you when you pass by at high speeds.

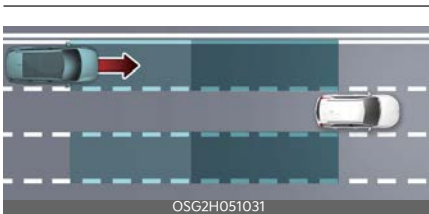

Blind-Spot Collision-Avoidance Assist helps detect and informs the driver that a vehicle is approaching at high speed from the blind spot area.

⚠ CAUTION

Warning timing may vary depending on the speed of the vehicle approaching at high speed.



When you are driving forward out of a parking space, if Blind-Spot Collision-Avoidance Assist judges that there is a collision risk with an approaching vehicle in the blind spot, it can help avoid collision by applying the brake.

Detecting sensor

Rear corner radar



Refer to the picture above for the detailed location of the detecting sensors.

⚠ CAUTION

- Never disassemble the detecting sensor assembly, or cause any damage to it.
- If the detecting sensor or near the sensor has been damaged or impacted in any way, even though the warning message does not appear on the cluster, Blind-Spot Collision-Avoidance Assist may not operate properly.

Have the function be inspected by an authorized Kia dealer.

- If the detecting sensors have been replaced or repaired, have the vehicle inspected by an authorized Kia dealer.
- The genuine Kia rear bumpers which the Rear corner radar sensors are mounted are parts with quality and performance ensured. If arbitrarily applying paint on or changing the bumper, the Blind-Spot Collision-Avoidance Assist may not function properly.
Use only Kia Genuine Parts or those of an equivalent standard with proven quality and performance to repair or replace the bumper.
- Do not arbitrarily attach or add vehicle wraps, accessories, license plate molds and stickers on or around the rear corner radar.
- If a trailer, carrier, etc., is installed, it may adversely affect the performance of the rear corner radar or Blind-Spot Collision-Avoidance Assist may not operate.

Blind-Spot Collision-Avoidance Assist settings

Blind-spot safety

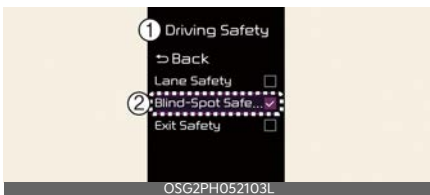

A: Driver Assistance

1 Driving Safety

2 Blind-Spot Safety

With the vehicle on, touch **User Settings** → **Driver Assistance** → **Driving Safety** → **Blind-Spot Safety** on the instrument cluster or **Settings** → **Vehicle** → **Driver Assistance** → **Driving Safety** → **Blind-Spot Safety** on the infotainment system.

- **Blind-Spot Safety:** Blind-Spot Collision-Avoidance Assist will warn you with a warning message and an audible warning depending on the collision risk level while driving, and will provide emergency braking depending on the collision risk level for parallel parking exit.



A: Blind-Spot Safety System is Off

When activating Blind-Spot Collision-Avoidance Assist or restarting the vehicle with this function activated, the warning light on the side mirrors will appear for approximately 3 seconds.

When the vehicle is restarted with Blind-Spot Collision-Avoidance Assist inactivated, the warning message will appear on the cluster.

⚠ WARNING

If **Blind-Spot Safety** is deselected, the driver should always be aware of the surroundings and drive safely.

*** NOTICE**

If the vehicle is restarted, Blind-Spot Collision-Avoidance Assist will maintain the last setting.

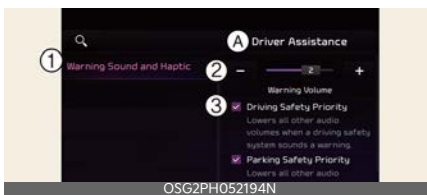
Warning Sound and Haptic

A: **Driver Assistance**

1 Warning Sound and Haptic

2 Warning Volume

3 Driving Safety Priority

With the vehicle on, touch **Settings** → **Vehicle** → **Driver Assistance** → **Warning Sound and Haptic** on the infotainment system to change the Warning Sound and Haptic.

- **Warning Volume:** You can adjust the Warning Volume from level 1 to 3.
- **Driving Safety Priority:** For safe driving, the audio volume will temporarily decrease to warn the driver with the audible warning.

*** NOTICE**

- Ensure that Warning Sound and Haptic you have set may apply to the Warning volume of other Driver Assistance systems.

- Warning Sound and Haptic will maintain its last setting even if the vehicle is restarted.
- If not equipped with the navigation system, select **User Settings** → **Driver Assistance** to adjust the Warning Volume.
- The setting menu may not be available for your vehicle depending on the vehicle features and specifications.
- Descriptions of each Driver Assistance system may be slightly different from the owner's manual after updating the software of your infotainment system. In this case, scan the QR code in the infotainment system manual to access the web manual for checking the changes.

Blind-Spot Collision-Avoidance Assist operation

Blind-Spot Collision-Avoidance Assist will warn and control as following action.

- Vehicle detection
- Collision warning
- Collision-avoidance assist (Parallel Exit)

Vehicle detection

First warning (Left/Right)





OSG2PH052080L

The warning light on the outside rear view mirror (side view mirror) and head-up display (if equipped) will appear when the vehicle on both lanes is detected from the rear.

A vehicle is detected in the following conditions.

- Your driving speed: Above 12 mph (20 km/h)
- The speed of the vehicle in your blind spot area: Above 7 mph (10 km/h)

Collision warning

With the vehicle detection state, Collision warning will alert the driver when the turn signal is activated to make a lane change with an adjacent car in the blind spot area.

- Collision warning will alert the driver with the warning light on the outside rear view mirrors (side view mirrors) and head-up display (if equipped) and an audible warning.
- When the turn signal is turned off or you move away from the lane, the collision warning will be canceled and the function will return to Vehicle detection state.

⚠ WARNING

- The detecting range of the front corner radar or rear corner radar is determined by a standard road width, therefore, on a narrow road, Blind-Spot Collision-Avoidance Assist may detect other vehicles two lanes over

and warn you. In contrast, on a wide road, Blind-Spot Collision-Avoidance Assist may not be able to detect a vehicle driving in the next lane and may not warn you.

- When the hazard warning flasher is on, the collision warning by the turn signal will not operate.

*** NOTICE**

Images or colors may be displayed differently depends on the instrument cluster specifications or theme.

Collision-avoidance assist (Parallel Exit)



OSG2PH052050N

A: Emergency Braking

The warning light on the outside rear view mirror (side view mirror), head-up display (if equipped) and an audible warning will warn the driver of a collision. It assists in braking control to prevent a collision with a vehicle approaching from the blind spot area. Collision-Avoidance Assist will be activated in the following conditions.

- Your driving speed: Below 2 mph (3 km/h)
- Speed of the vehicle in your blind spot area: Above 3 mph (5 km/h)



A: Drive carefully

When the vehicle is stopped due to emergency braking, the warning message will appear on the cluster. For your safety, the driver should depress the brake pedal immediately and check the surroundings.

- Brake control will end after the vehicle is stopped by emergency braking for approximately 2 seconds.

WARNING

- For your safety, change the Settings after parking the vehicle at a safe location.
- If any other system's warning message is displayed or audible warning is generated, Blind-Spot Collision-Avoidance Assist's warning message may not be displayed and audible warning may not be generated.
- You may not hear the warning sound of Blind-Spot Collision-Avoidance Assist if the surrounding is noisy.
- Blind-Spot Collision-Avoidance Assist may not operate if the driver applies the brake pedal to avoid collision.
- When Blind-Spot Collision-Avoidance Assist is operating, braking control by the function will automatically cancel when the driver excessively depresses the accelerator pedal or sharply steers the vehicle.
- During Blind-Spot Collision-Avoidance Assist operation, the vehicle may stop suddenly injuring passengers and

shifting loose objects. Always have the seat belt on and keep loose objects secured.

- Even if there is a problem with Blind-Spot Collision-Avoidance Assist, the vehicle's basic braking performance will operate properly.
- Blind-Spot Collision-Avoidance Assist does not operate in all situations or cannot avoid all collisions.
- Blind-Spot Collision-Avoidance Assist may warn the driver late or may not warn the driver depending on the road and driving conditions.
- Driver should maintain control of the vehicle at all times. Do not depend on Blind-Spot Collision-Avoidance Assist. Maintain a safe braking distance, and if necessary, depress the brake pedal to reduce driving speed or to stop the vehicle.
- Never operate Blind-Spot Collision-Avoidance Assist on people, animal, objects, etc. It may cause serious injury or death.

WARNING

The brake control may not operate properly depending on the status of ESC (Electronic Stability Control).

There will only be a warning when:

- The ESC (Electronic Stability Control) warning light is on
- ESC (Electronic Stability Control) is engaged in a different function

Blind-Spot Collision-Avoidance Assist malfunction and limitations

Blind-Spot Collision-Avoidance Assist malfunction



A: Check Blind-Spot Safety system

When Blind-Spot Collision-Avoidance Assist is not working properly, the warning message will appear on the cluster for several seconds, and the master (⚠️) warning light will appear on the cluster for several seconds. If this occurs, have Blind-Spot Collision-Avoidance Assist be inspected by an authorized Kia dealer.

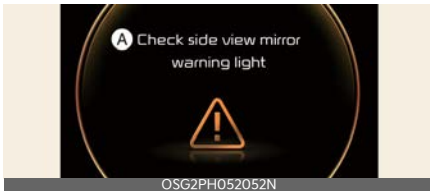

A: Check side view mirror warning light

When the outside rearview mirror warning light is not working properly, the warning message will appear on the cluster for several seconds, and the master (⚠️) warning light will appear on the cluster. If this occurs, have Blind-Spot Collision-Avoidance Assist be inspected by an authorized Kia dealers.

Blind-Spot Collision-Avoidance Assist disabled

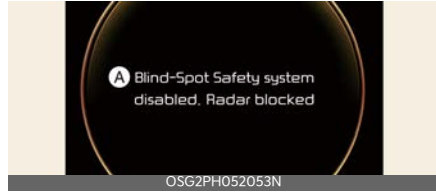

A: Blind-Spot Safety system disabled. Radar blocked

When the rear bumper around the rear corner radar or sensor is covered with foreign material, such as snow or rain, or installing a trailer or carrier, it can reduce the detecting performance and temporarily limit or disable Blind-Spot Collision-Avoidance Assist.

If this occurs, the warning message will appear on the cluster.

Blind-Spot Collision-Avoidance Assist will operate properly when such foreign material or trailer, etc., is removed, and then the vehicle is restarted.

If Blind-Spot Collision-Avoidance Assist does not operate properly after it is removed, have Blind-Spot Collision-Avoidance Assist be inspected by an authorized Kia dealer.

⚠️ WARNING

- Even though the warning message does not appear on the cluster, Blind-Spot Collision-Avoidance Assist may not properly operate.
- Blind-Spot Collision-Avoidance Assist may not properly operate in an area (for example, open terrain) where any objects are not detected right after the vehicle is turned on, or when the detecting sensor is blocked with foreign material right after the vehicle is turned on.

CAUTION

Turn off Blind-Spot Collision-Avoidance Assist to install or remove a trailer, carrier, or another attachment. Turn on Blind-Spot Collision-Avoidance Assist when finished.

Limitations of Blind-Spot Collision-Avoidance Assist

Blind-Spot Collision-Avoidance Assist may not operate properly, or it may operate unexpectedly under the following circumstances:

- There is inclement weather, such as heavy snow, heavy rain, etc.
- The detecting sensor is covered with snow, rain, dirt, etc.
- The temperature around the detecting sensor is high or low due to surrounding environment.
- The detecting sensor is blocked while driving near a vehicle, pillar, or wall.
- Driving on a highway (or motorway) ramp or driving through a tollgate.
- The road pavement (or the peripheral ground) abnormally contains metallic components (for example, possibly due to subway construction).
- There is a fixed object near the vehicle, such as sound barriers, guardrails, central dividers, entry barriers, street lamps, signs, tunnels, walls, etc. (including double structures)
- Driving through a narrow road where trees or grass are overgrown
- Driving in vast areas where there are few vehicles or structures (for example, desert, meadow, suburb, etc.)
- Driving on a wet road surface, such as a puddle on the road
- The other vehicle drives very close behind your vehicle, or the other vehicle passes by your vehicle in close proximity
- The speed of the other vehicle is very fast that it passes by your vehicle in a short time
- Your vehicle passes by the other vehicle
- Your vehicle changes lane
- Your vehicle has started at the same time as the vehicle next to you and has accelerated
- The vehicle in the next lane moves two lanes away from you, or when the vehicle two lanes away moves to the next lane from you
- A trailer or carrier is installed around the rear corner radar
- The bumper around the rear corner radar is covered with objects, such as a bumper sticker, bike rack, etc.
- The bumper around the rear corner radar is impacted, damaged or the radar is out of position
- Your vehicle height is low or high due to heavy loads, abnormal tire pressure, etc.
- When the following objects are detected:
 - A motorcycle or bicycle is detected
 - A vehicle such as a flat trailer is detected
 - A big vehicle such as a bus or truck is detected
 - A moving obstacle such as a pedestrian, animal, shopping cart or a baby stroller is detected
 - A vehicle with low height such as a sports car is detected

Braking control may not work, driver's attention is required in the following circumstances:

- The vehicle severely vibrates while driving over a bumpy road, uneven road or concrete patch
- Driving on a slippery surface due to snow, water puddle, ice, etc.
- The tire pressure is low or a tire is damaged
- The braking system has been modified
- The vehicle makes abrupt lane changes

⚠ WARNING

- Driving on a curved road



Blind-Spot Collision-Avoidance Assist may not operate properly when driving on a curved road. Blind-Spot Collision-Avoidance Assist may not detect the vehicle in the next lane.

Always pay attention to road and driving conditions while driving.

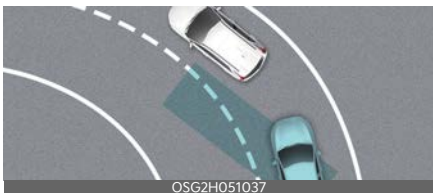

Blind-Spot Collision-Avoidance Assist may not operate properly when driving on a curved road. Blind-Spot Collision-Avoidance Assist may detect a vehicle in the same lane.

Always pay attention to road and driving conditions while driving.

- Driving on an inclined road



Blind-Spot Collision-Avoidance Assist may not operate properly when driving on a slope. The function may not detect the vehicle in the next lane or may incorrectly detect the ground or structure.

Always pay attention to road and driving conditions while driving.

- Driving where the road is merging/dividing



Blind-Spot Collision-Avoidance Assist may not operate properly when driving where the road merges or divides. The function may not detect the vehicle in the next lane.

Always pay attention to road and driving conditions while driving.

- Driving where the heights of the lanes are different



Blind-Spot Collision-Avoidance Assist may not operate properly when driving where the heights of the lanes are different. The function may not detect the vehicle on a road with different lane heights (underpass joining section, grade separated intersections, etc.).

Always pay attention to road and driving conditions while driving.

⚠ WARNING

- When you are towing a trailer or another vehicle, make sure that you turn off Blind-Spot Collision-Avoidance Assist.
- Blind-Spot Collision-Avoidance Assist may not operate properly if interfered by strong electromagnetic waves.
- Blind-Spot Collision-Avoidance Assist may not operate for 3 seconds after the vehicle is started, or the front view camera or rear corner radars are initialized.

This device complies with Part 15 of the FCC rules.

Operation is subject to the following two conditions:

1. This device may not cause harmful interference, and
2. This device must accept any interference received, including interference that may cause undesired operation.

Safe Exit Warning (SEW) (if equipped)



After the vehicle stops, when an approaching vehicle from the rear area is detected as soon as a passenger opens a door, Safe Exit Warning will warn the driver with a warning message and an audible warning to help prevent a collision.

⚠ CAUTION

Warning timing may vary depending on the speed of the approaching vehicle.

Detecting sensor

Rear corner radar



Refer to the picture above for the detailed location of the detecting sensors.

⚠ CAUTION

For more details on the precautions of the rear corner radars, refer to "Blind-Spot Collision-Avoidance Assist (BCA) (if equipped)" on page 6-65.

Safe Exit Warning settings

Exit Safety



A: Driver Assistance

- 1 Driving Safety
- 2 Exit Safety

With the vehicle on, touch **Settings** → **Driver Assistance** → **Driving safety** → **Exit Safety** on the instrument cluster or **Settings** → **Vehicle** → **Driver Assistance** → **Driving Safety** → **Exit Safety** on the infotainment system.

⚠ WARNING

If **Exit Safety** is deselected, Safe Exit Warning cannot warn you. The driver should always be aware of unexpected and sudden situations from occurring.

*** NOTICE**

If the vehicle is restarted, Safe Exit Warning will maintain the last setting.

Warning Sound and Haptic



A: **Driver Assistance**

1 Warning Sound and Haptic

2 Warning Volume

3 Driving Safety Priority

With the vehicle on, touch **Settings** → **Vehicle** → **Driver Assistance** → **Warning Sound and Haptic** on the infotainment system to change the Warning Sound and Haptic.

- **Warning Volume:** You can adjust the Warning Volume from level 1 to 3.
- **Driving Safety Priority:** For safe driving, the audio volume will temporarily decrease to warn the driver with the audible warning.

* NOTICE

- Ensure that Warning Sound and Haptic you have set may apply to the Warning volume of other Driver Assistance systems.
- Warning Sound and Haptic will maintain its last setting even if the vehicle is restarted.
- If not equipped with the navigation system, select **User Settings** → **Driver Assistance** to adjust the Warning Volume.
- The setting menu may not be available for your vehicle depending on the vehicle features and specifications.
- Descriptions of each Driver Assistance system may be slightly different from

the owner's manual after updating the software of your infotainment system. In this case, scan the QR code in the infotainment system manual to access the web manual for checking the changes.

Safe Exit Warning operation

Safe Exit Warning warns the following actions.

- Collision warning when exiting vehicle

Collision warning when exiting vehicle

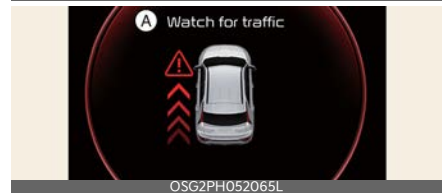

A: Watch for traffic

The warning light on the side view mirror will blink and the warning message will appear on the cluster, and an audible warning will sound.

- Safe Exit Warning will warn under the following circumstances:
 - Your driving speed: below 2 mph (3 km/h)
 - The speed of the approaching vehicle from the rear: above 4 mph (6 km/h)

⚠ WARNING

- For your safety, change the Settings after parking the vehicle at a safe location.
- If any other function's warning message is displayed or audible warning is generated, Safe Exit Warning warning message may not be displayed and audible warning may not be generated.
- You may not hear the warning sound of Safe Exit Warning if the surrounding is noisy.
- Safe Exit Warning does not operate in all situations or cannot prevent all collisions.
- Safe Exit Warning may warn the driver late or may not warn the driver depending and driving conditions. Always check vehicle surroundings.
- The driver and passengers are responsible for accidents that occurs while exiting the vehicle. Always check the surroundings before you exit the vehicle.

*** NOTICE**

- After the vehicle is turned off, Safe Exit Warning operates for approximately 3 minutes, but turns off immediately if the doors are locked.
- Images or colors may be displayed differently depends on the instrument cluster specifications or theme.

Safe Exit Warning malfunction and limitations

Safe Exit Warning malfunction



A: Check Blind-Spot Safety system

When Safe Exit Warning is not working properly, the warning message will appear on the cluster for several seconds, and the master warning light (⚠) will appear on the cluster. Have Safe Exit Warning be inspected by an authorized Kia dealer.

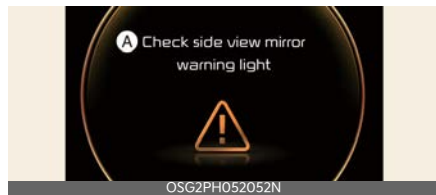

A: Check side view mirror warning light

When the outside rear view mirror warning light is not working properly, the warning message will appear on the cluster for several seconds, and the master warning light (⚠) will appear on the cluster. Have Safe Exit Warning be inspected by an authorized Kia dealer.

Safe Exit Warning disabled

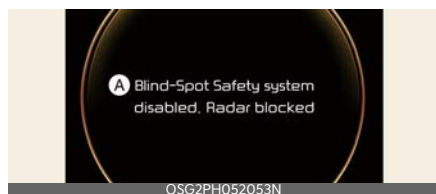

A: **Blind-Spot Safety system disabled. Radar blocked**

When the rear bumper around the rear corner radar or sensor is covered with foreign material, such as snow or rain, or installing a trailer or carrier, it can reduce the detecting performance and temporarily limit or disable Safe Exit Warning. If this occurs, the **Blind-Spot Safety systems disabled. Radar blocked** warning message will appear on the cluster.

Safe Exit Warning will operate normally when such foreign material or trailer, etc. is removed, and then the vehicle is restarted.

If Safe Exit Warning does not operate normally after it is removed, have the vehicle inspected by an authorized Kia dealer.

⚠ WARNING

- Even though the warning message does not appear on the cluster, Safe Exit Warning may not properly operate.
- Safe Exit Warning may not properly operate in an area (e.g., open terrain), where any substance are not detected right after the vehicle is turned on, or when the detecting sensor is blocked with foreign material right after the vehicle is turned on.

⚠ CAUTION

Turn off Safe Exit Warning to install a trailer, carrier, etc., or remove the trailer, carrier, etc. to use Safe Exit Warning.

Limitations of Safe Exit Warning

Safe Exit Warning may not operate normally, or Safe Exit Warning may operate unexpectedly under the following warning.

- Getting out of the vehicle where trees or grass are overgrown
- Getting out of the vehicle where the road is wet
- The approaching vehicle is very fast or very slow

*** NOTICE**

For more details on the precautions of the rear corner radars, refer to "Blind-Spot Collision-Avoidance Assist (BCA) (if equipped)" on page 6-65.

⚠ WARNING

- Safe Exit Warning may not operate normally if interfered by strong electromagnetic waves.
- Safe Exit Warning may not operate for approximately 3 seconds after the vehicle is restarted, or the rear corner radars are initialized.

Safe Exit Assist (SEA) (if equipped)



After the vehicle stops, when an approaching vehicle from the rear area is detected after a passenger opens the door, Safe Exit Assist will warn the driver with a warning message and an audible warning to help prevent a collision.



When the electronic child safety lock button is in the LOCK position and an approaching vehicle from the rear area is detected, the electronic child safety lock () button will not unlock even if the driver presses the button to prevent the rear doors from opening.

CAUTION

Warning timing may vary depending on the speed of the approaching vehicle.

Detecting sensor

Rear corner radar



Refer to the picture above for the detailed location of the detecting sensors.

CAUTION

For more details on the precautions of the rear corner radars, refer to "Blind-Spot Collision-Avoidance Assist (BCA) (if equipped)" on page 6-65.

Safe Exit Assist settings

Exit Safety

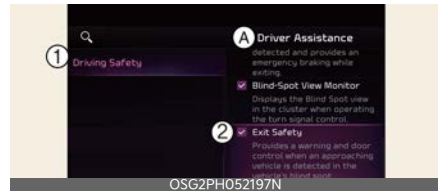
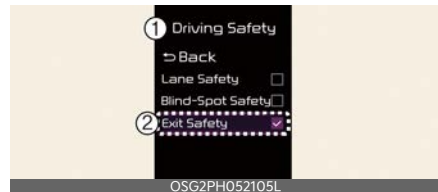

A: Driver Assistance

1 Driving Safety

2 Exit Safety

With the vehicle on, touch **Settings** → **Vehicle** → **Driver Assistance** → **Driving Safety** → **Exit Safety** on the instrument cluster or **Settings** → **Vehicle** → **Driver**

Assistance → **Driving Safety** → **Exit Safety** on the infotainment system.

⚠ WARNING

The driver should always be aware of his or her surroundings. If **Exit Safety** is deselected, Safe Exit Assist cannot assist you.

* NOTICE

If the vehicle is restarted, Safe Exit Assist will maintain the last setting.

Warning Sound and Haptic



A: Driver Assistance

1 Warning Sound and Haptic

2 Warning Volume

3 Driving Safety Priority

With the vehicle on, touch **Settings** → **Vehicle** → **Driver Assistance** → **Warning Sound and Haptic** on the infotainment system to change the Warning Sound and Haptic.

- **Warning Volume:** You can adjust the Warning Volume from level 1 to 3.
- **Driving Safety Priority:** For safe driving, the audio volume will temporarily decrease to warn the driver with the audible warning.

* NOTICE

- Ensure that Warning Sound and Haptic you have set may apply to the

Warning volume of other Driver Assistance systems.

- Warning Sound and Haptic will maintain its last setting even if the vehicle is restarted.
- If not equipped with the navigation system, select **User Settings** → **Driver Assistance** to adjust the Warning Volume.
- The setting menu may not be available for your vehicle depending on the vehicle features and specifications.
- Descriptions of each Driver Assistance system may be slightly different from the owner's manual after updating the software of your infotainment system. In this case, scan the QR code in the infotainment system manual to access the web manual for checking the changes.

Safe Exit Assist operation

Safe Exit Assist warns the following actions.

- Collision warning when exiting vehicle
- Safe Exit Assist linked with Electronic child safety lock

Collision warning when exiting vehicle



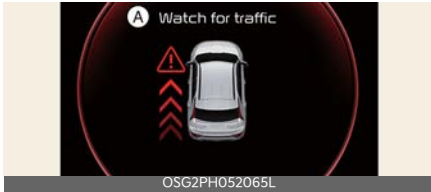

A: Watch for traffic

The warning light on the side view mirror will blink and the warning message will appear on the cluster, and an audible warning will sound.

- Collision warning when exiting vehicle will warn under the following circumstances:
 - Your driving speed: below 2 mph (3 km/h)
 - The speed of the approaching vehicle from the rear: above 4 mph (6 km/h)

Safe Exit Assist linked with Electronic child safety lock

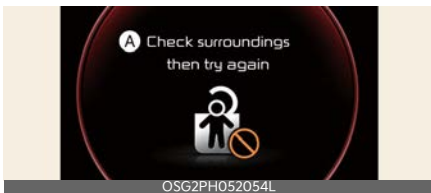

A: Check surroundings then try again

The warning light on the outside rear view mirror will blink and the warning message will appear on the cluster.

- Safe Exit Assist linked with Electronic child safety lock will operate in the following conditions:
 - Your driving speed: below 2 mph (3 km/h)
 - The speed of the approaching vehicle from the rear: above 4 mph (6 km/h)

*** NOTICE**

For more details on electric child safety lock button, refer to "Electronic child safety lock system (if equipped)" on page 5-18.

⚠ WARNING

If the driver presses the electronic child safety lock button again within 10 seconds after the warning message appears, Safe Exit Assist judges that the driver has unlocked the doors acknowledging the rear status. The electronic child safety lock will turn off (button indicator OFF) and the rear doors will unlock. Always check the surroundings before turning off the electronic child safety lock button.

*** NOTICE**

If a rear door is opened from the outside, it will open regardless of Safe Exit Assist operation.

⚠ WARNING

- For your safety, change the Settings after parking the vehicle at a safe location.
- If any other function's warning message is displayed or audible warning is generated, Safe Exit Assist warning message may not be displayed and audible warning may not be generated.
- You may not hear the warning sound of Safe Exit Assist if the surrounding is noisy.
- Safe Exit Assist does not operate in all situations or cannot prevent all collisions.

- Safe Exit Assist may warn the driver late or may not warn the driver depending on the road and driving conditions. Always check vehicle surroundings.
- The driver and passengers are responsible for accidents that occurs while exiting the vehicle. Always check the surroundings before you exit the vehicle.
- Never deliberately operate Safe Exit Assist. Doing so may lead to serious injury or death.

*** NOTICE**

- After the vehicle is turned off, Safe Exit Assist operates approximately for 3 minutes, but turns off immediately if the doors are locked.
- The images and colors in the instrument cluster may differ depending on the cluster type or theme selected from the settings menu.

Safe Exit Assist malfunction and limitations

Safe Exit Assist malfunction

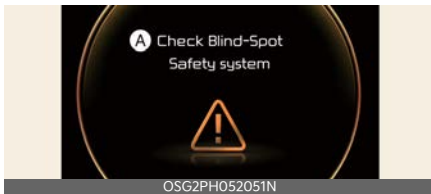

A: Check Blind-Spot Safety system

When Safe Exit Assist is not working properly, the warning message will appear on the cluster for several seconds, and the master (⚠️) warning light will appear on the cluster. Have Safe Exit Assist be inspected by an authorized Kia dealer.



A: Check side view mirror warning light

When the outside rearview mirror warning light is not working properly, the warning message will appear on the cluster for several seconds, and the master (⚠️) warning light will appear on the cluster. Have Safe Exit Assist be inspected by an authorized Kia dealer.

Safe Exit Assist disabled



A: Blind-Spot Safety system disabled. Radar blocked

When the rear bumper around the rear corner radar or sensor is covered with foreign material, such as snow or rain, or installing a trailer or carrier, it can reduce the detecting performance and temporarily limit or disable Safe Exit Assist. If this occurs, the warning message will appear on the cluster.

Safe Exit Assist will operate properly when such foreign material or trailer, etc., is removed, and then the vehicle is restarted.

If Safe Exit Assist does not operate properly after it is removed, have the vehicle inspected by an authorized Kia dealer.

⚠ WARNING

- Even though the warning message does not appear on the cluster, Safe Exit Assist may not properly operate.
- Safe Exit Assist may not properly operate in an area (for example, open terrain) where any objects are not detected right after the vehicle is turned on, or when the detecting sensor is blocked with foreign material right after the vehicle is turned on.

⚠ CAUTION

Turn off Safe Exit Assist to install or remove a trailer, carrier, or another attachment. Turn on Safe Exit Assist when finished.

Limitations of Safe Exit Assist

Safe Exit Assist may not operate properly, or it may operate unexpectedly under the following circumstances:

- Getting out of the vehicle where trees or grass are overgrown
- Getting out of the vehicle where the road is wet
- The approaching vehicle is very fast or very slow

*** NOTICE**

For more details on the limitations of the rear corner radar, refer to "Blind-Spot Collision-Avoidance Assist (BCA) (if equipped)" on page 6-65.

⚠ WARNING

- Safe Exit Assist may not operate properly if interfered by strong electromagnetic waves.

- Safe Exit Assist may not operate for 3 seconds after the vehicle is started, or the rear corner radars are initialized.

Manual Speed Limit Assist (MSLA)



- 1 Speed Limit indicator
- 2 Set speed

You can set the speed limit when you do not want to drive over a specific speed. If you drive over the preset speed limit, Manual Speed Limit Assist operates (set speed limit will blink and chime will sound) until the vehicle speed returns within the speed limit.

Manual Speed Limit Assist operation

Setting speed limit

1. Press and hold Driving Assist (DA) button at the desired speed. The Speed Limit (LIMIT) indicator will appear on the cluster.



2. Push the (+) switch up or (-) switch down, and release it at the desired speed. Push the (+) switch up or (-) switch down and hold it. The speed will increase or decrease to the nearest multiple of 5 in mph (multiple of 10) at first, and then increase or decrease by 5 mph (10 km/h).

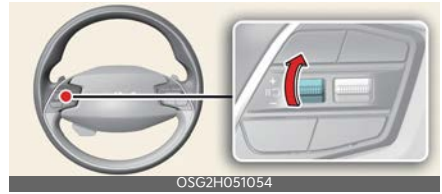

3. The set speed limit will be displayed on the cluster. If you would like to drive over the preset speed limit, depress the accelerator pedal beyond the pressure point to activate the kickdown mechanism. The set speed limit will blink and chime will sound until you return the vehicle speed within the speed limit.



* NOTICE

When the accelerator pedal is not depressed beyond the pressure point, vehicle speed will maintain within the speed limit.

Temporarily pausing Manual Speed Limit Assist



Press the (⏏) switch to temporarily pause the set speed limit. The set speed limit will turn off but the Speed Limit (S LIMIT) indicator will stay on.

Resuming Manual Speed Limit Assist



To resume Manual Speed Limit Assist after the function was paused, operate the (+), (-), (⏏) switch.

If you push the (+) switch up or (-) switch down, vehicle speed will be set to the current speed on the cluster.

If you press the (⏏) switch, vehicle speed will resume to the preset speed.

Turning off Manual Speed Limit Assist



Press the Driving Assist (DA) button to turn Manual Speed Limit Assist off. The

Speed Limit (S LIMIT) indicator will go off.

⚠ WARNING

Take the following precautions when using Manual Speed Limit Assist:

- Always set the vehicle speed under the speed limit in your country.
- Keep Manual Speed Limit Assist off when the function is not in use, to avoid inadvertently setting a speed. Check that the Speed Limit (S LIMIT) indicator is off.
- Manual Speed Limit Assist does not substitute for proper and safe driving. It is the responsibility of the driver to always drive safely and should always be aware of unexpected and sudden situations from occurring. Pay attention to the road conditions at all times.

Intelligent Speed Limit Assist (ISLA)

Intelligent Speed Limit Assist uses information from the detected road sign and navigation system to inform the driver of the speed limit and additional information of the current road. Also, Intelligent Speed Limit Assist helps the driver to maintain within the speed limit of the road.

CAUTION

- Intelligent Speed Limit Assist may not operate properly if the function is used in other countries.
- If a navigation is applied to your vehicle, the navigation needs to be regularly updated for Intelligent Speed Limit Assist to operate properly. For more information, refer to the user's manual provided in the infotainment system and the quick reference guide.

Detecting sensor

Front view camera



Refer to the picture above for the detailed location of the detecting sensor.

CAUTION

For more details on the precautions of the front view camera, refer to "Forward Collision-Avoidance Assist (FCA) (Sensor Fusion)" on page 6-39.

Intelligent Speed Limit Assist settings

Speed limit

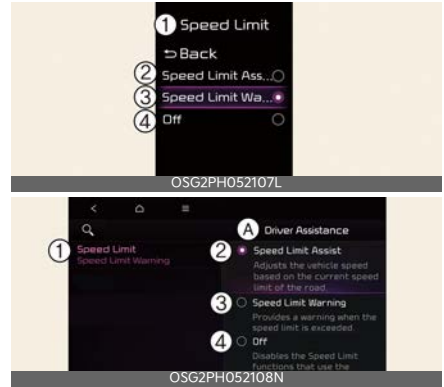

A: Driver Assistance

- 1 Speed Limit
- 2 Speed Limit Assist
- 3 Speed Limit Warning
- 4 Off

With the vehicle on, touch **Settings** → **Driver Assistance** → **Speed Limit** on the instrument cluster or **Settings** → **Vehicle** → **Driver Assistance** → **Speed Limit** on the infotainment system.

- **Select Country:** If the vehicle is not equipped with navigation system, a settings menu will be provided to select the country manually. For Intelligent Speed Limit Assist to operate properly, select the country where the vehicle is currently being driven.
- **Speed Limit Offset:** The offset for Speed limit can be adjusted. The vehicle will warn the speed limit or adjust the driving speed when the current driving speed is higher than the recognized speed limit added with set tolerance value.

- **Speed Limit Assist:** Intelligent Speed Limit Assist will inform the driver of speed limit and additional road signs. In addition, Intelligent Speed Limit Assist will inform the driver to change set speed of Manual Speed Limit Assist or Smart Cruise Control (If equipped) to help the driver stay within the speed limit.
- **Speed Limit Warning:** Intelligent Speed Limit Assist will inform the driver of speed limit and additional road signs. In addition, Intelligent Speed Limit Assist will warn the driver when the vehicle is driven faster than the speed limit. Manual Speed Limit Assist or Smart Cruise Control (If equipped) set speed will not be automatically adjusted. The driver should adjust the speed manually.
- **Off:** Intelligent Speed Limit Assist will turn off.

⚠ WARNING

For your safety, change the settings after parking the vehicle at a safe location.

*** NOTICE**

- Speed limit and Speed warning function operates based on an offset value added with the speed limit. Set the offset value to '0' to change or warn the speed according to the recognized speed limit.
- The setting of Speed limit offset is not reflected in Navigation-based Smart Cruise Control.

Warning Sound and Haptic



A: Driver Assistance

1 Warning Sound and Haptic

2 Warning Volume

3 Driving Safety Priority

With the vehicle on, touch **Settings** → **Vehicle** → **Driver Assistance** → **Warning Sound and Haptic** on the infotainment system to change the Warning Sound and Haptic.

- **Warning Volume:** You can adjust the Warning Volume from level 1 to 3.
- **Driving Safety Priority:** For safe driving, the audio volume will temporarily decrease to warn the driver with the audible warning.

*** NOTICE**

- Ensure that Warning Sound and Haptic you have set may apply to the Warning volume of other Driver Assistance systems.
- Warning Sound and Haptic will maintain its last setting even if the vehicle is restarted.
- If not equipped with the navigation system, select **User Settings** → **Driver Assistance** to adjust the Warning Volume.
- The setting menu may not be available for your vehicle depending on the vehicle features and specifications.
- Descriptions of each Driver Assistance system may be slightly different from

the owner's manual after updating the software of your infotainment system. In this case, scan the QR code in the infotainment system manual to access the web manual for checking the changes.

Intelligent Speed Limit Assist operation

Warning and control

Intelligent Speed Limit Assist is warned and controlled by the following action.

- Displaying speed limit
- Warning overspeed
- Changing set speed

* NOTICE

Intelligent Speed Limit Assist warning and control are described based on the Offset adjust to '0'. For details on Offset setting, refer to "Intelligent Speed Limit Assist settings" on page 6-85.

Displaying speed limit



Speed limit information is displayed on the instrument cluster.

* NOTICE

- If speed limit information of the road cannot be recognized, '---' sign will be displayed. Please refer to "Intelligent Speed Limit Assist malfunction and limitations" on page 6-88 if the road signs are difficult to recognize.

- Intelligent Speed Limit Assist provides additional road sign information in addition to speed limit. The additional road sign information provided may vary according to your country.
- The images and colors in the instrument cluster may differ depending on the cluster type or theme selected from the settings menu.

Warning overspeed



When driving at a speed higher than the displayed speed limit, the red speed limit indicator will be indicated.

Changing set speed



If the speed limit of the road changes during the operation of Manual Speed Limit Assist or Smart Cruise Control, an arrow in the direction of up or down is displayed to inform the driver that the set speed needs to be changed. At this time, the driver can change the set

speed according to the speed limit by using the (+) or (-) switch on the steering wheel.

⚠ WARNING

- When driving at a speed lower than the speed limit, set the offset under '0', or press (-) switch to decrease your set speed.
- Even after changing the set speed according to the speed limit of the road, the vehicle can still be driven over the speed limit. If necessary, depress the brake pedal to reduce your driving speed.
- If the speed limit of the road is under 20 mph (30 km/h), the set speed change function will not work.
- Intelligent Speed Limit Assist operates using the speed unit in the instrument cluster set by the driver. If the speed unit is set to a unit other than the speed unit used in your country, Intelligent Speed Limit Assist may not operate properly.

*** NOTICE**

- For more details on Manual Speed Limit Assist operation, refer to "Manual Speed Limit Assist (MSLA)" on page 6-83.
- For more details on Smart Cruise Control operation, refer to "Smart Cruise Control (SCC) (if equipped)" on page 6-95.

Intelligent Speed Limit Assist malfunction and limitations

Intelligent Speed Limit Assist malfunction



A: Check Speed Limit system

When Intelligent Speed Limit Assist is not working properly, the warning message will appear on the cluster for several seconds, and the master (⚠) warning light and speed limit warning light (⊠) will appear on the cluster. If this occurs, have the vehicle inspected by an authorized Kia dealer.

Intelligent Speed Limit Assist disabled

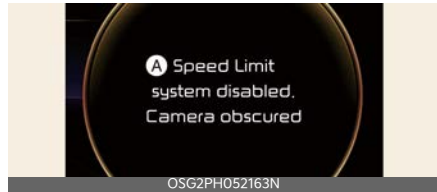

A: Speed Limit system disabled. Camera obscured

When the front windshield where the front view camera is located is covered with foreign material, such as snow or rain, it can reduce the detecting performance and temporarily limit or disable Intelligent Speed Limit Assist. If this occurs, the warning message and speed limit warning light (⊠) will appear on the cluster.

Intelligent Speed Limit Assist will operate properly when snow, rain or foreign

material is removed. Always keep it clean.

If Intelligent Speed Limit Assist does not operate properly after it is removed, have the vehicle inspected by an authorized Kia dealer.

WARNING

Even though the warning message or warning light does not appear on the cluster, Intelligent Speed Limit Assist may not operate properly.

Limitations of Intelligent Speed Limit Assist

Intelligent Speed Limit Assist may not operate properly, or it may operate unexpectedly under the following circumstances:

- The road sign is contaminated or indistinguishable
 - The road sign is difficult to see due to bad weather, such as rain, snow, fog, etc.
 - The road sign is partially obscured by surrounding objects or shadow
- The road signs do not conform to the standard
 - The text or picture on the road sign is different from the standard
 - The road sign is installed between the main line and the exit road or between diverging roads
 - A sign is attached to another vehicle
- The distance between the vehicle and the road signs is far
- The vehicle encounters appearing road signs
- Intelligent Speed Limit Assist incorrectly recognizes numbers or pictures in the street signs or other signs as the speed limit
- A road sign near the road you are driving is detected
- Multiple signs are installed close together
- Other Auxiliary signs or commercial signs are placed around the speed limit signs.
- The minimum speed limit sign is mis-recognized
- The minimum speed limit sign is on the road
- The brightness changes suddenly, for example when entering or exiting a tunnel or passing under a bridge
- Headlamps are not used or the brightness of the headlamps are weak at night or in the tunnel
- The field of view of the front view camera is obstructed by sun glare
- Road signs are difficult to recognize due to the reflection of sunlight, street lights, or oncoming vehicles
- The navigation information or GPS information contain errors.
- The driver does not follow the guide of the navigation.
- Driving on a road that is sharply curved or continuously curved
- Driving through speed bumps, or driving up and down or left to right on steep inclines
- The vehicle is shaking heavily
- Driving on a newly opened road
- The navigation is updated while driving
- The navigation is restarted while driving

⚠ WARNING

- Intelligent Speed Limit Assist is a supplemental function that helps the driver to comply with the speed limit on the road, and may not display the correct speed limit or control the driving speed properly.
- It is the responsibility of the driver to keep the speed limit.
- When initializing (rebooting) the camera or restarting the vehicle, the function may not operate for approximately 15 seconds.

*** NOTICE**

For more details on the limitations of the front view camera, refer to "Forward Collision-Avoidance Assist (FCA) (Sensor Fusion)" on page 6-39.

Driver Attention Warning (DAW)**Basic function**

Driver Attention Warning can help determine the driver's attention level by analyzing driving pattern and driving time while the vehicle is driven. Driver Attention Warning will recommend a break when the driver's attention level falls below a certain level.

Leading vehicle departure alert function

Leading Vehicle Departure Alert function will inform the driver when a detected vehicle in front departs from a stop.

Detecting sensor

Front view camera



The front view camera is used as a detecting sensor to help detect driving patterns and front vehicle departure while vehicle is being driven.

Refer to the picture above for the detailed location of the detecting sensor.

⚠ CAUTION

- Always keep the front view camera in good condition to maintain optimal performance of Driver Attention Warning.
- For more details on the precautions of the front view camera, refer to "For-

ward Collision-Avoidance Assist (FCA) (Sensor Fusion)" on page 6-39.

Driver Attention Warning settings

Driver Attention Warning

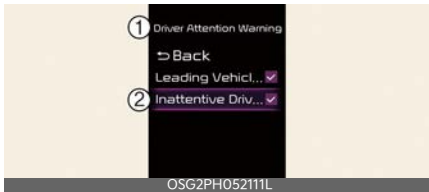

A: Driver Assistance

- 1 Driver Attention Warning
- 2 Inattentive Driving Warning

With the vehicle on, touch or deselect **Settings** → **Driver Assistance** → **Driver Attention Warning** on the instrument cluster or select **Settings** → **Vehicle** → **Driver Assistance** → **Driver Attention Warning** on the infotainment system.

- If **Inattentive Driving Warning** is selected, Driver Attention Warning will recommend taking a break when the level falls below a certain level.

Leading Vehicle Departure Alert

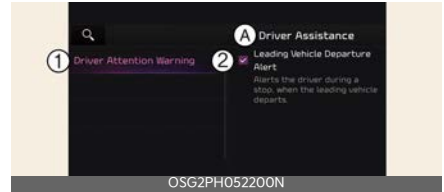
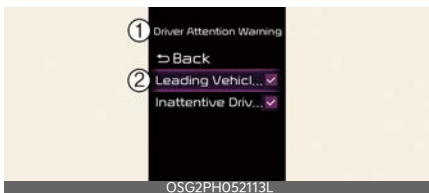

A: Driver Assistance

- 1 Driver Attention Warning
- 2 Leading Vehicle Departure Alert

- If **Leading Vehicle Departure Alert** is selected, the function will inform the driver when a detected vehicle in front departs from a stop.

* INFORMATION

Descriptions for each function of the Driver Assistance system may differ from the owners' manual by infotainment software update. Refer to the web manual that you can access with the QR code in the infotainment system quick reference.

6

Driver Attention Warning operation

Basic function

The basic function of Driver Attention Warning is to warn the driver 'Consider taking a break'.

Taking a break

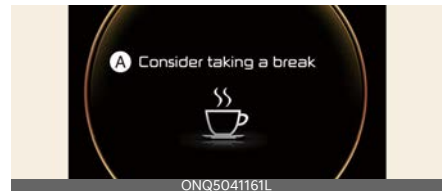

A: Consider taking a break

Warning message will appear on the cluster and an audible warning will sound to suggest that the driver take a

break, when the driver's attention level is below a certain level.

- Driver Attention Warning will not suggest a break when the total driving time is shorter than 4 minutes has not passed after the last break was suggested.

Driver Attention Warning operates under the following conditions:

- Your driving speed: Approximately 0~120 mph (0~200 km/h).

⚠ WARNING

For your safety, change the Settings after parking the vehicle at a safe location.

⚠ CAUTION

- Driver Attention Warning may suggest a break depending on the driver's driving pattern or habits, even if the driver doesn't feel fatigue.
- Driver Attention Warning is a supplemental function and may not be able to determine whether the driver is inattentive.
- The driver who feels fatigued should take a break at a safe location, even though there is no break suggestion by Driver Attention Warning.

*** NOTICE**

For more details on vehicle settings, refer to "User settings mode" on page 5-78.

Leading vehicle departure alert function



A: Leading vehicle is driving away

When a detected vehicle in front departs from a stop, Leading Vehicle Departure Alert will inform the driver by displaying the warning message on the cluster and an audible warning will sound.

⚠ WARNING

- If any other function's warning message is displayed or audible warning is generated, Leading Vehicle Departure Alert's warning message may not be displayed and audible warning may not be generated.
- The driver should hold the responsibility to safely drive and control the vehicle.

⚠ CAUTION

- Leading Vehicle Departure Alert is a supplemental function and may not alert the driver whenever the front vehicle departs from a stop.
- Always check the front of the vehicle and road conditions before departure.

*** NOTICE**

The images and colors in the instrument cluster may differ depending on the cluster type or theme selected from the settings menu.

Driver Attention Warning malfunction and limitations

Driver Attention Warning malfunction

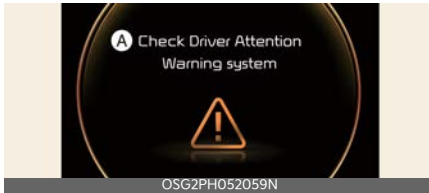

A: Check Driver Attention Warning system

When Driver Attention Warning is not working properly, the warning message will appear on the cluster for several seconds, and the master (⚠️) warning light will appear on the cluster. If this occurs, have Driver Attention Warning be inspected by an authorized Kia dealer.

Driver Attention Warning disabled

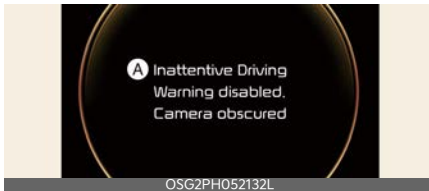

A: Inattentive Driving Warning disabled. Camera obscured

When the front view camera is located is covered with foreign material, such as snow or rain, it can reduce the detecting performance and temporarily limit or disable Driver Attention Warning.

If this occurs the warning message, and the (⚠️) warning light will appear on the cluster. Driver Attention Warning will operate normally when snow, rain or foreign material is removed. Always keep it clean.

If Driver Attention Warning does not operate normally after obstruction (snow, rain, or foreign material) is removed, have the vehicle inspected by an authorized Kia dealer.

⚠️ WARNING

- Driver Attention Warning may not work properly in areas where substances are not detected after turning ON the vehicle (e.g. in open terrain) or if the recognition sensor is contaminated.
- If restarting the vehicle with the sensors blocked or malfunctioned, the Driver Attention Warning may not properly operate as the function maintains the last setting.

Limitations of Driver Attention Warning

Driver Attention Warning may not work properly in the following situations:

- The vehicle is driven violently
- The vehicle intentionally crosses over lanes frequently
- The vehicle is controlled by Driver Assistance system, such as Lane Keeping Assist

Leading vehicle departure alert function

- When the vehicle cuts in

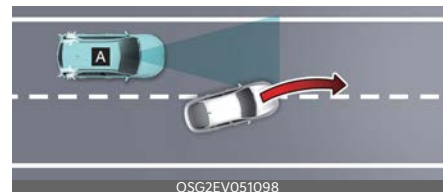



[A]: Your vehicle, [B]: Front vehicle
If a vehicle cuts in front of your vehicle, Leading Departure Alert may not operate properly.

- When the vehicle ahead sharply steers



[A]: Your vehicle, [B]: Front vehicle
If the vehicle in front makes a sharp turn, such as to turn left or right or make a U-turn, etc., Leading Vehicle Departure Alert may not operate properly.

- When the vehicle ahead abruptly departs

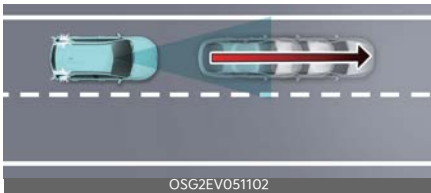

If the vehicle in front abruptly departs, Leading Vehicle Departure Alert may not operate properly.

- When a pedestrian or bicycle is between you and the vehicle ahead



If there is a pedestrian(s) or bicycle(s) in between you and the vehicle in front, Leading Vehicle Departure Alert may not operate properly.

- When in a parking lot

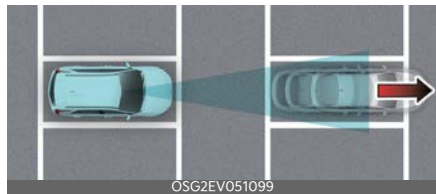

If a vehicle parked in front drives away from you, Leading Vehicle Departure Alert may alert you that the parked vehicle is driving away.

- When driving at a tollgate or intersection, etc.

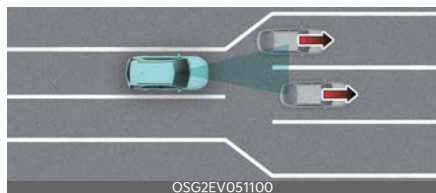

If you pass a tollgate or intersection with lots of vehicles or you drive where lanes are merged or divided frequently, Leading Vehicle Departure Alert may not operate properly.

⚠ WARNING

Driver Attention Warning may not operate for 15 seconds after the vehicle is

started, or the front view camera is initialized.

* NOTICE

For more details on the precautions of the front view camera, refer to "Forward Collision-Avoidance Assist (FCA) (Sensor Fusion)" on page 6-39.

Smart Cruise Control (SCC) (if equipped)

Basic function

Smart Cruise Control is designed to help detect the vehicle ahead and help maintain the desired speed and minimum distance between the vehicle ahead.

Overtake acceleration assist function

If the driver attempts to overtake, the vehicle will accelerate to assist overtaking.

Based on driving style (if equipped)

When Smart Cruise Control is operating, the vehicle applies the driver's driving style.

Detecting sensor

Front view camera



Front radar



Front corner radar (if equipped)



The front view camera and front radar, and front corner radars (if equipped) are used as a detecting sensor to detect front vehicles.

Refer to the picture above for the detailed location of the detecting sensor.

CAUTION

- Always keep the front view camera and front radar in good condition to maintain optimal performance of Smart Cruise Control.
- For more details on the precautions of the front view camera and front radar, refer to "Forward Collision-Avoidance Assist (FCA) (Sensor Fusion)" on page 6-39.

Smart Cruise Control settings

Smart Cruise Control

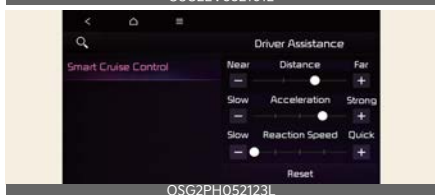
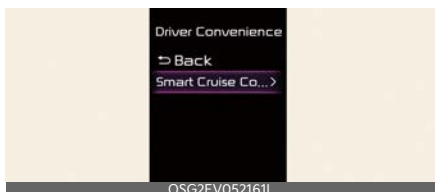

With the vehicle on, touch **Settings** → **Driver Assistance** → **Driving Convenience** → **Smart Cruise Control** on the instrument cluster or **Settings** → **Vehicle** → **Driver Assistance** → **Driving Convenience** → **Smart Cruise Control** on the infotainment system to set the distance, acceleration and the reaction speed.

Based on driving style (if equipped)



A: Driving convenience

1 Smart Cruise Control

2 Based on driving style

With the vehicle on, if **Settings** → **Driver Assistance** → **Driving Convenience** → **Smart Cruise Control** → **Based on Driving Style** is selected on the instrument cluster or **Settings** → **Vehicle** → **Driver assistance** → **Driving convenience** → **Smart Cruise Control** → **Based on Driving Style** is selected from the infotainment system screen, Smart Cruise Control will operate based on the driver's driving style, such as vehicle distance, acceleration, reaction speed.

The driver's driving style can be adjusted each driving style manually.

*** NOTICE**

- If equipped with Based on Driving Style, Based on driving mode and Based on driving style can be selected from the infotainment system screen by selecting **Settings** → **Vehicle** →

Driver assistance → Driving convenience → Smart Cruise Control.

- If Based on driving mode is selected, Smart Cruise Control will operate based on the drive mode selected.
- While Smart Cruise Control is operating with Based on driving style selected, if you press and hold the Vehicle Distance (🚗) button, Smart Cruise Control will change to Based on driving mode. Press and hold the Vehicle Distance (🚗) button to change Smart Cruise Control to Based on driving style mode.
- View driving style analysis is displayed when Based on Driving Style is selected.
- Smart Cruise Control learns the driver's driving styles only when the driver drives the vehicle.

- **Driving Safety Priority:** For safe driving, the audio volume will temporarily decrease to warn the driver with the audible warning.

*** NOTICE**

- Ensure that Warning Sound and Haptic you have set may apply to the Warning volume of other Driver Assistance systems.
- Warning Sound and Haptic will maintain its last setting even if the vehicle is restarted.
- If not equipped with the navigation system, select **User Settings → Driver Assistance** to adjust the Warning Volume.
- The setting menu may not be available for your vehicle depending on the vehicle features and specifications.
- Descriptions of each Driver Assistance system may be slightly different from the owner's manual after updating the software of your infotainment system. In this case, scan the QR code in the infotainment system manual to access the web manual for checking the changes.

Warning Sound and Haptic

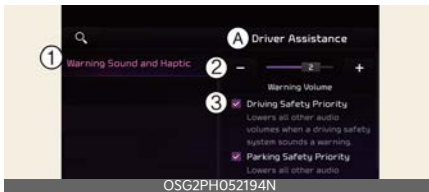

A: Driver Assistance

1 Warning Sound and Haptic

2 Warning Volume

3 Driving Safety Priority

With the vehicle on, touch **Settings → Vehicle → Driver Assistance → Warning Sound and Haptic** on the infotainment system to change the Warning Sound and Haptic.

- **Warning Volume:** You can adjust the Warning Volume from level 1 to 3.

Smart Cruise Control operation

Operating conditions for basic function

Basic function

Smart Cruise Control operates when the following conditions are satisfied.

- The gear is in D (Drive)
- Your driving speed is within the operating speed range
 - 5~100 mph (10~160 km/h): when there is no vehicle in front

- 0~100 mph (0~160 km/h): when there is a vehicle in front
- ESC (Electronic Stability Control) or ABS is on

Smart Cruise Control does not operate in the following conditions.

- The driver's door is opened
- The vehicle is in power limited mode
- EPB (Electronic Parking Brake) is applied
- ESC (Electronic Stability Control) or ABS is controlling the vehicle
- Forward Collision-Avoidance Assist brake control is operating
- Remote Smart Parking Assist brake control is operating (if equipped)

*** NOTICE**

When stopped behind another vehicle, the driver can turn on Smart Cruise Control while the brake pedal is depressed.

Operating conditions for Acceleration Assist

Overtaking Acceleration Assist will operate when the turn signal indicator is turned on to the left while Smart Cruise Control is operating, and the following conditions are satisfied:

- Your driving speed is above 60 km/h (40 mph)
- A vehicle is detected in front of your vehicle

Overtaking Acceleration Assist does not operate in the following conditions.

- The hazard warning flasher is on
- Vehicle speed is reduced to maintain distance with the vehicle in front

⚠ WARNING

- When the turn signal indicator is turned on to the left (left-hand drive)

or turned on to the right (right-hand drive) while there is a vehicle ahead, the vehicle may accelerate temporarily. Pay attention to the road conditions at all times.

- Regardless of your country's driving direction, Overtaking Acceleration Assist will operate when the conditions are satisfied. When using the function in countries with different driving direction, always check the road conditions at all times.

Turning on Smart Cruise Control



Press the Driving Assist button to turn on Smart Cruise Control. The speed will be set to the current speed on the cluster.

- If there is no vehicle in front of you, the set speed will be maintained.
- If there is a vehicle in front of you, the speed may be adjusted to maintain the distance to the vehicle ahead. If the vehicle ahead accelerates, your vehicle will travel at a steady cruising speed after accelerating to the set speed.

*** NOTICE**

If your vehicle speed is between 0~30 km/h (0~20 mph) when you press the Driving Assist button, the set speed will be set to 30 km/h (20 mph).

Setting vehicle distance



Each time the button is pressed, the headway changes as follows:

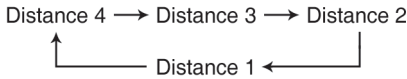

For example, if you drive at 90 km/h (56 mph), the distance is maintained as follows:

- Distance 4: approximately 52.5 m (172 ft.)
- Distance 3: approximately 40 m (130 ft.)
- Distance 2: approximately 32.5 m (106 ft.)
- Distance 1: approximately 25 m (82 ft.)

* NOTICE

The distance is set to the last set distance when the vehicle is restarted, or when Smart Cruise Control was temporarily canceled.

Increasing set speed



- Push the (+) switch up and release it immediately. The set speed will increase by 1 km/h (1 mph) each time the switch is operated in this manner.

- Push the (+) switch up and hold it. The set speed will increase by 10 km/h (5 mph) each time the switch is operated in this manner.

You can increase the set speed to 160 km/h (100 mph).

⚠ WARNING

Check the driving condition before using the (+) switch. Driving speed may sharply increase when you push up and hold the (+) switch.

Decreasing set speed



- Push the (-) switch down and release it immediately. The set speed will decrease by 1 km/h (1 mph) each time the switch is operated in this manner.
- Push the (-) switch down and hold it. The set speed will decrease by 10 km/h (5 mph) each time the switch is operated in this manner. You can decrease the set speed to 30 km/h (20 mph).

Temporarily canceling Smart Cruise Control



Press the (⏏) switch or depress the brake pedal to temporarily cancel Smart Cruise Control.

Resuming Smart Cruise Control

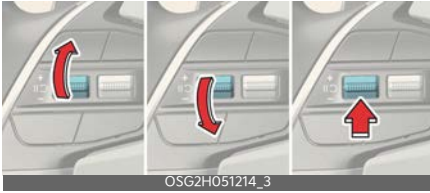

To resume Smart Cruise Control after the function was canceled, operate the (+), (-) or (||) switch.

If you push the (+) switch up or (-) switch down, the set speed will be set to the current speed on the cluster.

If you press the (||) switch, vehicle speed will resume to the preset speed.

⚠ WARNING

Check the driving condition before using the (||) switch. Driving speed may sharply increase or decrease when you press the (||) switch.

Turning off Smart Cruise Control



Press the Driving Assist button to turn Smart Cruise Control off.

*** NOTICE**

If your vehicle is equipped with Manual Speed Limit Assist, press and hold the Driving Assist button to turn off Smart Cruise Control. However Manual Speed Limit Assist will turn on.

⚠ WARNING

Do not use the switches and buttons at the same time. Smart Cruise Control may not operate properly.

Displaying operating status

You can see the status of the Smart Cruise Control operation in the Driving Assist view on the cluster. Refer to "LCD display modes" on page 5-75.

Smart Cruise Control will be displayed as below depending on the status of the function.

Operating

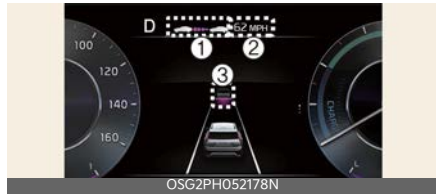

Temporarily canceled



Smart Cruise Control will be displayed as below depending on the status of the function.

- When operating
 1. Whether there is a vehicle ahead and the selected distance level
 2. Set speed
 3. Whether there is a vehicle ahead and the target vehicle distance
- When temporarily canceled
 1. Your vehicle (shaded)
 2. Previous set speed (shaded)

Accelerating temporarily

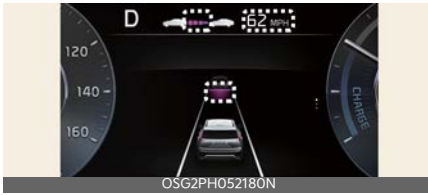

If you want to speed up temporarily without altering the set speed while Smart Cruise Control is operating, depress the accelerator pedal. While the accelerator pedal is depressed, the set speed, distance level and target distance will blink on the cluster.

However, if the accelerator pedal is depressed insufficiently, the vehicle may decelerate.

⚠ WARNING

Be careful when accelerating temporarily, because the speed and distance is not controlled automatically even if there is a vehicle in front of you.

Based on Driving Style operating (if equipped)

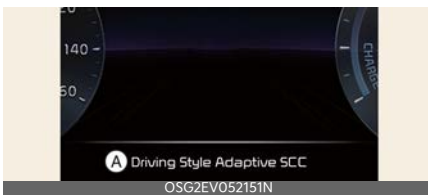

A: **Driving Style Adaptive SCC**

When Based on Driving Style is operating, the message will appear on the clus-

ter for 2 seconds, and the distance level and target distance will be displayed based on the driving style.

Temporarily canceling Smart Cruise Control

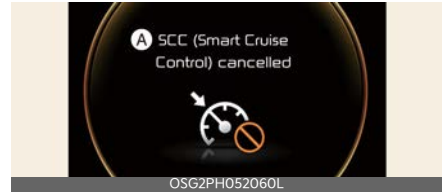

A: **SCC (Smart Cruise Control) cancelled**

Smart Cruise Control will be temporarily canceled automatically when:

- Your driving speed is above 105 mph (170 km/h)
- The vehicle is stopped for a certain period of time
- The accelerator pedal is continuously depressed for a certain period of time
- The conditions for the Smart Cruise Control to operate is not satisfied

If Smart Cruise Control is temporarily canceled automatically, the warning message will appear on the cluster, and an audible warning will sound to warn the driver.

*** NOTICE**

If Smart Cruise Control is temporarily canceled while the vehicle is at a standstill with the function activated, EPB (Electronic Parking Brake) maybe applied.

⚠ WARNING

When Smart Cruise Control is temporarily canceled, distance with the front vehicle will not be maintained. Always have your eyes on the road while driving, and

if necessary, depress the brake pedal to reduce your driving speed in order to maintain a safe distance.

Smart Cruise Control conditions not satisfied

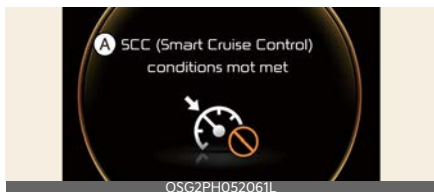

A: SCC (Smart Cruise Control) conditions not met

If the Driving Assist button, (+) switch, (-) switch or (||□) switch is operated when Smart Cruise Control operating conditions are not satisfied, the warning message will appear on the cluster, and an audible warning will sound.

In traffic situation

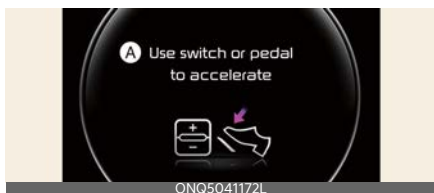

A: Use switch or pedal to accelerate

In traffic, your vehicle will stop if the vehicle ahead of you stops. Also, if the vehicle ahead of you starts moving, your vehicle will start as well.

In addition, after the vehicle has stopped and a certain time have passed, the warning message will appear on the cluster. Depress the accelerator pedal or operate the (+) switch, (-) switch or (||□) switch to start driving.

Warning road conditions ahead



A: Watch for surrounding vehicles

In the following situation, the warning message will appear on the cluster, and an audible warning will sound to warn the driver of road conditions ahead.

⚠ WARNING

Always pay attention to vehicles or objects that may suddenly appear in front of you, and if necessary, depress the brake pedal to reduce your driving speed in order to maintain a safe distance.

Collision warning



A: Collision warning!

While Smart Cruise Control is operating, when the collision risk with the vehicle ahead is high, the warning message will appear on the cluster, and an audible warning will sound to warn the driver. Always have your eyes on the road while driving, and if necessary, depress the brake pedal to reduce your driving speed in order to maintain a safe distance.

⚠ WARNING

In the following situations, Smart Cruise Control may not warn the driver of a collision.

Always pay attention to road and driving conditions while driving.

- The distance from the front vehicle is near, or the vehicle speed of the front vehicle is faster or similar with your vehicle
- The speed of the front vehicle is very slow or is at a standstill
- The accelerator pedal is depressed right after Smart Cruise Control is turned on

⚠ WARNING

- Smart Cruise Control does not substitute for proper and safe driving. It is the responsibility of the driver to always check the speed and distance to the vehicle ahead.
- Smart Cruise Control may not recognize unexpected and sudden situations or complex driving situations, so always pay attention to driving conditions and control your vehicle speed.
- Keep Smart Cruise Control off when the function is not in use to avoid inadvertently setting a speed.
- Do not open the door or leave the vehicle when Smart Cruise Control is operating, even if the vehicle is stopped.
- Always be aware of the selected speed and headway distance.
- Keep a safe distance according to road conditions and vehicle speed. If the headway distance is too close during high-speed driving, a serious collision may result.

- When maintaining distance with the vehicle ahead, if the front vehicle disappears, Smart Cruise Control may suddenly accelerate to the set speed. Always be aware of unexpected and sudden situations from occurring.
- Vehicle speed may decrease on an upward slope and increase on a downward slope.
- Always be aware of situations such as when a vehicle cuts in suddenly.
- When you are towing a trailer or another vehicle, turn off Smart Cruise Control for safety reasons.
- Turn off Smart Cruise Control when your vehicle is being towed.
- Smart Cruise Control may not operate properly if interfered by strong electromagnetic waves.
- Smart Cruise Control may not detect an obstacle in front and lead to a collision. Always look ahead cautiously to prevent unexpected and sudden situations from occurring.
- Vehicles moving in front of you with a frequent lane change may cause a delay in Smart Cruise Control reaction or may cause Smart Cruise Control to react to a vehicle actually in an adjacent lane. Always drive cautiously to prevent unexpected and sudden situations from occurring.
- Always be aware of the surroundings and drive safely, even though a warning message does not appear or an audible warning does not sound.
- If any other function's warning message is displayed or warning sound is generated, Smart Cruise Control warning message may not be displayed and warning sound may not be generated.

- You may not hear the warning sound of Forward Collision-Avoidance Assist if the surrounding is noisy.
- The vehicle manufacturer is not responsible for any traffic violation or accidents caused by the driver.
- Always set the vehicle speed under the speed limit in your country.
- If the driver's driving style changes, distance, acceleration and the reaction speed may change.

⚠ CAUTION

- The vehicle must be driven sufficiently to reflect the actual driving style of the driver, such as vehicle distance, acceleration and reaction speed.
- Based on Driving Style may not reflect the driver's driving style or driving conditions that affects driving safety.
- If you are driving in special conditions, such as snow, rain, fog or steep sloped roads, the vehicle may not be driven according to the driver's driving style.

*** NOTICE**

- Smart Cruise Control may not operate for a few seconds after the vehicle is restarted or the front view camera or front radar is initialized.
- You may hear a sound when the brake is controlled by Smart Cruise Control.
- Based on Driving Style may not reflect the driver's driving style that is not safe such as rapid acceleration.
- Based on Driving Style does not reflect any other driving style other

than vehicle distance, acceleration and reaction speed.

Smart Cruise Control malfunction and limitations

Smart Cruise Control malfunction



A: Check Smart Cruise Control System

When Smart Cruise Control is not working properly, the warning message will appear, and the (⚠) warning light will appear on the cluster. Have Smart Cruise Control be inspected by a professional workshop. Visit an authorized Kia dealer.

Smart Cruise Control disabled

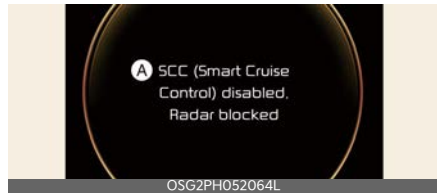

A: SCC (Smart Cruise Control) disabled. Radar blocked

When the front radar cover or sensor is covered with snow, rain, or foreign material, it can reduce the detecting performance and temporarily limit or disable Smart Cruise Control.

If this occurs the warning message will appear for a certain period of time on the cluster.

Smart Cruise Control will operate properly when snow, rain or foreign material is removed. Always keep it clean.

⚠ WARNING

Even though the warning message does not appear on the cluster, Smart Cruise Control may not properly operate.

⚠ CAUTION

Smart Cruise Control may not properly operate in an area (e.g. open terrain), where there is nothing to detect, or detecting sensor is covered in foreign material after turning ON the vehicle.

Limitations of Smart Cruise Control

Smart Cruise Control may not operate properly, or it may operate unexpectedly under the following circumstances:

- The detecting sensor or the surroundings are contaminated or damaged
- Washer fluid is continuously sprayed, or the wiper is on
- The camera lens is contaminated due to tinted, filmed or coated windshield, damaged glass, or sticky foreign material (sticker, bug, etc.) on the glass
- Moisture is not removed or frozen on the windshield
- The field of view of the front view camera is obstructed by sun glare
- Street light or light from an oncoming vehicle is reflected on the wet road surface, such as a puddle on the road
- The temperature around the front view camera is high or low
- An object is placed on the dashboard
- The surrounding is very bright
- The surrounding is very dark, such as in a tunnel, etc.
- The brightness changes suddenly, for example when entering or exiting a tunnel
- The brightness outside is low, and the headlamps are not on or are not bright
- Driving in heavy rain or snow, or thick fog
- Driving through steam, smoke or shadow
- Only part of the vehicle is detected
- The vehicle in front has no tail lights, tail lights are located unusually, etc.
- The brightness outside is low, and the tail lamps are not on or are not bright
- The rear of the front vehicle is small or does not look normal (for example, tilted, overturned, etc.)
- The front vehicle's ground clearance is low or high
- A vehicle suddenly cuts in front
- Your vehicle is being towed
- An object reflecting off the front radar such as a guardrail, nearby vehicle, etc.
- The bumper around the front radar is impacted, damaged or the front radar is out of position
- The temperature around the front radar is high or low
- The vehicle in front is made of material that does not reflect on the front radar
- Driving near a highway (or motorway) interchange or tollgate
- Driving on a slippery surface due to snow, water puddle, ice, etc.
- Driving on a curved road
- The vehicle in front is detected late
- The vehicle in front is suddenly blocked by an obstacle

- The vehicle in front suddenly changes lane or suddenly reduces speed
- The vehicle in front is bent out of shape
- The front vehicle's speed is fast or slow
- With a vehicle in front, your vehicle changes lane suddenly at low speed
- The vehicle in front is covered with snow
- Unstable driving
- You are on a roundabout and the vehicle in front is not detected
- You are continuously driving in a circle
- The adverse road conditions cause excessive vehicle vibrations while driving
- Your vehicle height is low or high due to heavy loads, abnormal tire pressure, etc.
- Driving in following places
 - Driving in a parking lot
 - Driving through a construction area, unpaved road, partial paved road, uneven road, speed bumps, etc.
 - Driving on an incline road, curved road, etc.
 - Driving through a roadside with trees or streetlights
 - Driving through a narrow road where trees or grass are overgrown
 - There is interference by electromagnetic waves, such as driving in an area with strong radio waves or electrical noise
 - Driving on a curved road
- Driving through a tunnel or iron bridge

- Driving near areas containing metal substances, such as a construction zone, railroad, etc.
- Driving in vast areas where there are few vehicles or structures (for example, desert, meadow, suburb, etc.)
 - Driving through steam, smoke or shadow
 - Driving near a highway (or motorway) interchange or tollgate
 - Driving near areas containing metal substances, such as a construction zone, railroad, etc.
- Driving on curved road



On curves, Smart Cruise Control may not detect a vehicle in the same lane, and may accelerate to the set speed. Also, vehicle speed may rapidly decrease when the vehicle ahead is detected suddenly.

Select the appropriate set speed on curves and apply the brake pedal or accelerator pedal according to the road and driving conditions ahead.



Your vehicle speed can be reduced due to a vehicle in the adjacent lane. Check to be sure that the road conditions permit safe operation of Smart Cruise Control and if necessary,

depress the brake pedal to reduce your driving speed in order to maintain a safe distance

- Driving on an inclined road



During uphill or downhill driving, the Smart Cruise Control may not detect a moving vehicle in your lane, and cause your vehicle to accelerate to the set speed. Also, vehicle speed will rapidly decrease when the vehicle ahead is detected suddenly.

Select the appropriate set speed on inclines and apply the brake pedal or accelerator pedal according to the road and driving conditions ahead.

- Changing lanes



[A] : Your vehicle,

[B] : Lane changing vehicle

When a vehicle (B) moves into your lane from an adjacent lane, it cannot be detected by the sensor until it is in

the sensor's detection range. Smart Cruise Control may not immediately detect the vehicle when the vehicle changes lanes abruptly. In this case, you must maintain a safe braking distance, and if necessary, depress the brake pedal to reduce your driving speed in order to maintain a safe distance.

- Situations when detecting are limited



In the following cases, some vehicles in your lane cannot be detected by the sensor:

- Vehicles offset to one side
- Slow-moving vehicles or sudden-decelerating vehicles
- Vehicles with higher ground clearance or vehicles carrying loads that stick out of the back of the vehicle
- Vehicles that has the front lifted due to heavy loads
- Vehicles within approximately 2 m (6 ft.) from your vehicle
- Oncoming vehicles
- Stopped vehicles
- Vehicles with small rear profile, such as trailers
- Narrow vehicles, such as motorcycles, bicycles, or powered two-wheelers
- Special vehicles
- Animals and pedestrians



In the following cases, the vehicle in front cannot be detected by the sensor. Always pay attention to the road and driving conditions and drive safely. If necessary, adjust your vehicle speed.

- You are steering your vehicle
- Driving on narrow or sharply curved roads
- When a vehicle ahead disappears at an intersection, your vehicle may accelerate.
Always pay attention to road and driving conditions while driving.



- When a vehicle in front of you merges out of the lane, Smart Cruise Control may not immediately detect the new vehicle that is now in front of you.
Always pay attention to road and driving conditions while driving.



- Always look out for pedestrians when your vehicle is maintaining a distance with the vehicle ahead.



This device complies with Part 15 of the FCC rules.

Operation is subject to the following three conditions:

1. This device may not cause harmful interference, and
2. This device must accept any interference received, including interference that may cause undesired operation.
3. Changes or modifications not expressly approved by the party responsible for compliance could void the user's authority to operate the device.

Radio frequency radiation exposure information:

This equipment complies with FCC radiation exposure limits set forth for an uncontrolled environment. This equipment should be installed and operated with minimum distance of 8 in (20 cm) between the radiator (antenna) and your body.

This transmitter must not be colocated or operating in conjunction with any other antenna or transmitter.

Navigation-based Smart Cruise Control (NSCC) (if equipped)

Navigation-based Smart Cruise Control can help drive at a certain speed according to the road conditions when driving on highways (or motorways) by using road information from the navigation system while Smart Cruise Control is operating.

* NOTICE

- Navigation-based Smart Cruise Control is available only on controlled access road of certain highways.
 - * Controlled access road indicates roads with limited entrances and exits that allow uninterrupted high speed traffic flow. Only passenger cars and motorcycles are allowed on controlled access roads.

Available highway (Controlled access road)	
USA	Select Interstate Highway and U.S. (Federal) and State Highways
Canada	Select Provincial and Territorial Highways

- Additional highways may be expanded by future navigation updates.

* NOTICE

Navigation-based Smart Cruise Control operates on main roads of highways (or motorways), and does not operate on interchanges or junctions.

⚠ WARNING

Navigation-based Smart Cruise Control (NSCC) is a supplemental function and is not a substitute for safe driving. It is the responsibility of the driver to always check the speed and distance to the

vehicle ahead. Always drive safely and use caution.

*** NOTICE**

- Highway Curve Zone Auto Slowdown and Highway Set Speed Auto Change function uses the same (NAV) symbol.
- The images and colors in the instrument cluster may differ depending on the cluster type or theme selected from the settings menu.

Highway Curve Zone Auto Slowdown

If vehicle speed is high, Highway Curve Zone Auto Slowdown function will temporarily decelerate your vehicle or limit acceleration to help you drive safely on a curve based on the curve information from the navigation.

Highway Set Speed Auto Change

Highway Set Speed Auto Change function automatically changes Smart Cruise Control set speed based on the speed limit information from the navigation.

Navigation-based Smart Cruise Control settings

Highway Auto Speed Change

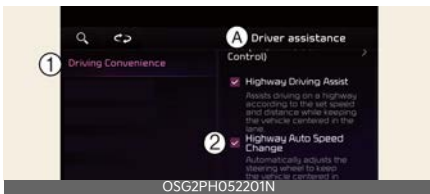

A: Driver Assistance
1 Driving Convenience

2 Highway Auto Speed Change

With the vehicle on, touch **Settings** → **Vehicle** → **Driver Assistance** → **Driving convenience** → **Highway Auto Speed Change** on the infotainment system.

*** NOTICE**

When there is a problem with Navigation-based Smart Cruise Control, the function cannot be set from the Settings menu.

*** INFORMATION**

Descriptions for each function of the Driver Assistance system may differ from the owners' manual by infotainment software update. Refer to the web manual that you can access with the QR code in the infotainment system quick reference.

Navigation-based Smart Cruise Control operation

Operating conditions

Navigation-based Smart Cruise Control is ready to operate if all of the following conditions are satisfied:

- Smart Cruise Control is operating
- Driving on main roads of highways (or motorways)

*** NOTICE**

For more details on how to operate Smart Cruise Control, refer to "Smart Cruise Control (SCC) (if equipped)" on page 6-95.

Navigation-based Smart Cruise Control display and control

When Navigation-based Smart Cruise Control operates, it will be displayed on the cluster as follows:

Navigation-based Smart Cruise Control standby



If the operating conditions are satisfied, the white (NAV) symbol will appear.

Navigation-based Smart Cruise Control operating



If temporary deceleration is required in the standby state and Navigation-based Smart Cruise Control is operating, the green (NAV) symbol will appear on the cluster.

If the Highway Set Speed Auto Change function operates, the (NAV) symbol and set speed will appear in green on the cluster, and an audible warning will sound.

⚠ WARNING



A: Drive carefully

The warning message will appear in the following circumstances:

- Navigation-based Smart Cruise Control is not able to slow down your vehicle to a safe speed

Highway Curve Zone Auto Slow-down

- Depending on the curve ahead on the highway (or motorway), the vehicle will decelerate, and after passing the curve, the vehicle will accelerate to Smart Cruise Control set speed.
- Vehicle deceleration time may differ depending on the vehicle speed and the degree of the curve on the road. The higher the driving speed, deceleration will start faster.

Highway Set Speed Auto Change

- Highway Set Speed Auto Change function will operate when Smart Cruise Control set speed and the highway (or motorway) speed limit is matched.
- While Highway Set Speed Auto Change function is operating, when the highway (or motorway), speed limit changes, Smart Cruise Control set speed automatically changes to the changed speed limit.
- If Highway Set Speed Auto Change function has changed to the standby state by driving on a road other than the highway (or motorway) main road, Highway Set Speed Auto Change function will operate again when you drive on the main road again without setting the set speed.
- If Highway Set Speed Auto Change function has changed to the standby state by depressing the brake pedal or pressing the (⏏) switch on the

steering wheel, press the (⏮) switch to restart the function.

* NOTICE

- If Smart Cruise Control set speed is adjusted different from the speed limit, Highway Set Speed Auto Change function will be in the standby state.
 - Highway Set Speed Auto Change function only operates based on the speed limits of the highway (or motorway), it does not work with the speed cameras.
 - Highway Set Speed Auto Change function does not operate on highway interchanges or junctions.
 - When Highway Set Speed Auto Change function is operating, the vehicle automatically accelerates or decelerates when the highway (or motorway) speed limit changes.
 - If the speed limit is higher than the speed limit of the speed camera, the audible warning may sound.
 - The maximum set speed for Highway Set Speed Auto Change function is 90 mph (140 km/h).
 - If the speed limit of a new road is not updated in the navigation, Highway Set Speed Auto Change function may not operate properly.
 - If the speed unit is set to a unit other than the speed unit used in your country, Highway Set Speed Auto Change function may not operate properly.
-
- The navigation is not working properly
 - Speed limit and road information in the navigation is not updated
 - Map information is not transmitted due to infotainment system's abnormal operation
 - The map information and the actual road is different because of real-time GPS data or map information error
 - The navigation searches for a route while driving
 - GPS signals are blocked in areas such as a tunnel
 - A road that divides into two or more roads and joins again
 - The driver goes off course the route set in the navigation
 - The route to the destination is changed or canceled by resetting the navigation
 - The vehicle enters a service station or rest area
 - Android Auto or Car Play is operating
 - The navigation cannot detect the current vehicle position (for example, elevated roads including overpass adjacent to general roads or nearby roads exist in a parallel way)
 - The navigation is being updated while driving
 - The navigation is being restarted while driving
 - The speed limit of some sections changes according to the road situations
 - Driving on a road under construction
 - Driving on a road that is controlled
 - There is bad weather, such as heavy rain, heavy snow, etc.

Limitations of Navigation-based Smart Cruise Control

Navigation-based Smart Cruise Control may not operate properly under the following circumstances:

Driving your vehicle

- Driving on a road that is sharply curved

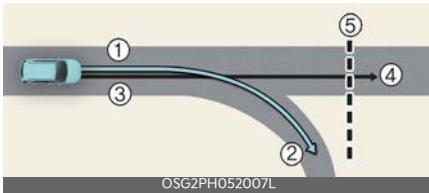

[1]: Set route, [2]: Branch line, [3]: Driving route, [4]: Main road, [5]: Curved road section

- When there is a difference between the navigation set route (branch line) and the driving route (main road), Highway Curve Zone Auto Slowdown function may not operate until the driving route is recognized as the main road.
- When the vehicle's driving route is recognized as the main road by maintaining the main road instead of the navigation set route, Highway Curve Zone Auto Slowdown function will operate. Depending on the distance to the curve and the current vehicle speed, vehicle deceleration may not be sufficient or may decelerate rapidly.

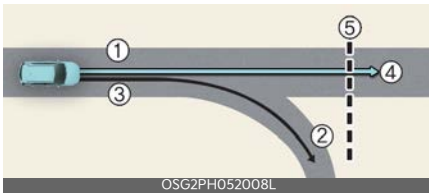

[1]: Main road, [2]: Branch line, [3]: Driving route, [4]: Set route, [5]: Curved road section

- When there is a difference between the navigation route (main road) and the driving route (branch line), Highway Curve Zone Auto Slowdown func-

Navigation-based Smart Cruise Control (NSCC)

tion will operate based on the curve information on the main road.

- When it is judged that you are driving out of the route by entering the highway interchange or junction, Highway Curve Zone Auto Slowdown function will not operate.

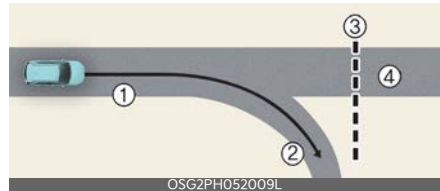

[1]: Driving route, [2]: Branch line, [3]: Curved road section, [4]: Main road

- If there is no destination set on the navigation, Highway Curve Zone Auto Slowdown function will operate based on the curve information on the main road.
- Even if you depart from the main road, Highway Curve Zone Auto Slowdown function may temporarily operate due to navigation information of the highway curve section.

⚠ WARNING

- Navigation-based Smart Cruise Control is not a substitute for safe driving practices, but a convenience function. Always have your eyes on the road, and it is the responsibility of the driver to avoid violating traffic laws.
- The navigation's speed limit information may differ from the actual speed limit information on the road. It is the driver's responsibility to check the speed limit on the actual driving road or lane.
- Navigation-based Smart Cruise Control will automatically be canceled when you leave the highway (or motorway) main road. Always pay

attention to road and driving conditions while driving.

- Navigation-based Smart Cruise Control may not operate due to the existence of leading vehicles and the driving conditions of the vehicle. Always pay attention to road and driving conditions while driving.
- When you are towing a trailer or another vehicle, turn off Navigation-based Smart Cruise Control for safety reasons.
- After you pass through a tollgate on a highway (or motorway), Navigation-based Smart Cruise Control will operate based on the first lane. If you enter one of the other lanes, Navigation-based Smart Cruise Control might not operate properly.
- The vehicle will accelerate if the driver depresses the accelerator pedal while Navigation-based Smart Cruise Control is operating, and the function will not decelerate the vehicle. However, if the accelerator pedal is depressed insufficiently, the vehicle may decelerate.
- If the driver accelerates and releases the accelerator pedal while Navigation-based Smart Cruise Control is operating, the vehicle may not decelerate sufficiently or may rapidly decelerate to a safe speed.
- If the curve is too large or too small, Navigation-based Smart Cruise Control may not operate.

*** NOTICE**

- A time gap could occur between the navigation's guidance and when Navigation-based Smart Cruise Control operation starts and ends.

- The speed information on the cluster and navigation may differ.
- Even if you are driving at a speed lower than Smart Cruise Control set speed, acceleration may be limited by the curve sections ahead.
- If Navigation-based Smart Cruise Control is operating while leaving the main road to enter an interchange, junction, rest area, etc., the function may operate for a certain period of time.
- Deceleration by Navigation-based Smart Cruise Control may feel it is not sufficient due to road conditions such as uneven road surfaces, narrow lanes, etc.

This device complies with Part 15 of the FCC rules.

Operation is subject to the following three conditions:

1. This device may not cause harmful interference, and
2. This device must accept any interference received, including interference that may cause undesired operation.
3. Changes or modifications not expressly approved by the party responsible for compliance could void the user's authority to operate the device.

Radio frequency radiation exposure information:

This equipment complies with FCC radiation exposure limits set forth for an uncontrolled environment. This equipment should be installed and operated with minimum distance of 8 in (20 cm) between the radiator (antenna) and your body.

This transmitter must not be colocated or operating in conjunction with any other antenna or transmitter.

Lane Following Assist (LFA)

Lane Following Assist is designed to help detect lane markings and/or vehicles on the road, and assists the driver's steering to help center the vehicle in the lane.

Detecting sensor

Front view camera



The front view camera is used as a detecting sensor to detect lane markings and front vehicles.

Refer to the picture above for the detailed location of the detecting sensor.

⚠ CAUTION

For more details on the precautions of the front view camera, refer to "Forward Collision-Avoidance Assist (FCA) (Sensor Fusion)" on page 6-39.

6

Lane Following Assist settings

Warning Sound and Haptic

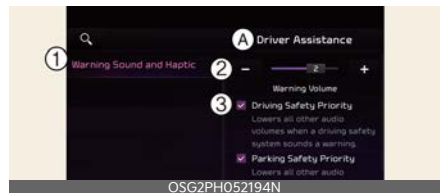

A: Driver Assistance

1 Warning Sound and Haptic

2 Warning Volume

3 Driving Safety Priority

With the vehicle on, touch **Settings** → **Vehicle** → **Driver Assistance** → **Warning Sound and Haptic** on the infotainment system to change the Warning Sound and Haptic.

- **Warning Volume:** You can adjust the Warning Volume from level 1 to 3.
- **Driving Safety Priority:** For safe driving, the audio volume will temporarily decrease to warn the driver with the audible warning.

*** NOTICE**

- Ensure that Warning Sound and Haptic you have set may apply to the Warning volume of other Driver Assistance systems.
- Warning Sound and Haptic will maintain its last setting even if the vehicle is restarted.
- If not equipped with the navigation system, select **User Settings** → **Driver Assistance** to adjust the Warning Volume.
- The setting menu may not be available for your vehicle depending on the vehicle features and specifications.
- Descriptions of each Driver Assistance system may be slightly different from the owner's manual after updating the software of your infotainment system. In this case, scan the QR code in the infotainment system manual to access the web manual for checking the changes.

Lane Following Assist operation

Turning Lane Following Assist On/Off



With the vehicle is on, shortly press the Lane Driving Assist button located on the steering wheel to turn on Lane Following Assist. The grey or green (Ⓢ) indicator light will appear on the cluster. Press the button again to turn off the function.

Lane Following Assist



If the vehicle ahead and/or both lane markings are detected and The vehicle speed is below 100 mph (160 km/h), the green (Ⓢ) indicator light appears on the cluster, and Lane Following Assist helps center the vehicle in the lane by assisting the steering wheel.

⚠ CAUTION

When the steering wheel is not assisted, the white (Ⓢ) indicator light blinks and change to grey.

Hands-off warning



A: Keep hands on steering wheel

If the driver takes their hands off the steering wheel for several seconds, the warning message will appear and an audible warning will sound in stages.

- First stage: Warning message
- Second stage: Warning message (red steering wheel) and audible warning

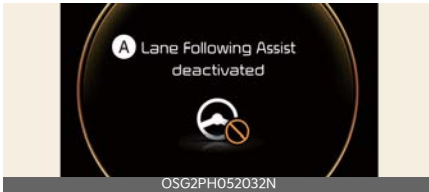

A: Lane Following Assist deactivated

If the driver still does not have their hands on the steering wheel after the hands-off warning the warning message will appear and Lane Following Assist will be automatically canceled.

⚠ WARNING

- The steering wheel may not be assisted if the steering wheel is held very tight or the steering wheel is steered over a certain degree.
- Lane Following Assist does not operate at all times. It is the responsibility of the driver to safely steer the vehicle and to maintain the vehicle in its lane.
- The hands-off warning message may appear late depending on road conditions. Always have your hands on the steering wheel while driving.

- If the steering wheel is held very lightly the hands-off warning message may appear because Lane Following Assist may not recognize that the driver has their hands on the steering wheel.
- If you attach objects to the steering wheel, the hands-off warning may not work properly.

* NOTICE

- When both lane markings are detected, the lane lines on the cluster will change from grey to white.

Lane undetected



Lane detected



- The images and colors in the instrument cluster may differ depending on the cluster type or theme selected from the settings menu.
- If lane markings are not detected, steering wheel control by Lane Following Assist can be limited depending on whether a vehicle is in front or the driving conditions of the vehicle.
- Even though the steering is assisted by Lane Following Assist, the driver may control the steering wheel.

- The steering wheel may feel heavier or lighter when the steering wheel is assisted by Lane Following Assist than when it is not.

Lane Following Assist malfunction and limitations

Lane Following Assist malfunction



A: Check Lane Following Assist system

When Lane Following Assist is not working properly, the warning message will appear and the master warning light (⚠️) will appear on the cluster.

If this occurs, have the vehicle inspected by an authorized Kia dealer .

Limitations of Lane Following Assist

For more details on Lane Following Assist limitations, refer to "Lane Keeping Assist (LKA)" on page 6-60.

Highway Driving Assist (HDA) (if equipped)

Basic function

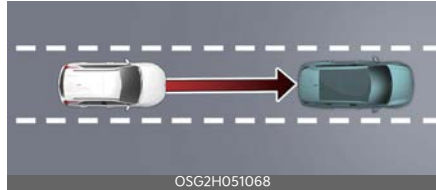

Highway Driving Assist is designed to help detect vehicles and lanes ahead, and help maintain distance from the vehicle ahead, maintain the set speed, help center the vehicle in the lane while driving on the highway (or motorway).

Highway Lane Change Assist (if equipped)



Highway Lane Change Assist function helps change lanes to the direction the driver slightly moves the turn signal switch if the function judges that lane change is possible.

* NOTICE

- Highway Driving Assist is available only on controlled access road of certain highways.
 - * Controlled access road indicates roads with limited entrances and exits that allow uninterrupted high speed traffic flow. Only passenger

cars and motorcycles are allowed on controlled access roads.

Available highway (Controlled access road)	
USA	Select Interstate Highway and U.S. (Federal) and State Highways
Canada	Select Provincial and Territorial Highways

- Additional highways may be expanded by future navigation updates.

Highway Driving Assist operates on main roads of highways (or motorways), and does not operate on interchanges or junctions.

Detecting sensor

Front view camera



Front radar



Front corner radar (if equipped)



Rear corner radar (if equipped)



Refer to the picture above for the detailed location of the detecting sensors.

CAUTION

For more details on the precautions of the detecting sensors, refer to "Forward Collision-Avoidance Assist (FCA) (Sensor Fusion)" on page 6-39.

Highway Driving Assist settings

Highway Driving Assist

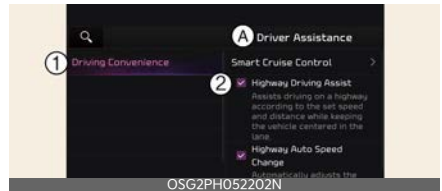

A: Driver assistance

1 Driving convenience

2 Highway Driving Assist

With the vehicle on, touch or select **Settings** → **Vehicle** → **Driver assistance** → **Driving convenience** on the infotainment system to set whether to use each function.

Basic function

If **Highway Driving Assist** is selected, it helps maintain distance from the vehicle ahead, maintain the set speed, and helps center the vehicle in the lane.

Highway Lane Change Assist (if equipped)



A: Driver assistance

1 Driving Convenience

2 Lane change assist (motorway)

If Lane change assist (motorway) is selected, it helps changing lanes safely.

⚠ WARNING

For your safety, change the Settings after parking the vehicle at a safe location.

* NOTICE

- Highway Driving Assist should be selected to use Highway Lane Change Assist. (if equipped)
- If there is a problem with the functions, the settings cannot be changed. Have the function be inspected by an authorized Kia dealer.
- If the vehicle is restarted, the functions will maintain the last setting.

Warning Sound and Haptic

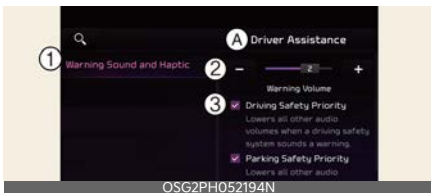

A: Driver Assistance

1 Warning Sound and Haptic

2 Warning Volume

3 Driving Safety Priority

With the vehicle on, touch **Settings** → **Vehicle** → **Driver Assistance** → **Warning Sound and Haptic** on the infotainment system to change the Warning Sound and Haptic.

- **Warning Volume:** You can adjust the Warning Volume from level 1 to 3.
- **Driving Safety Priority:** For safe driving, the audio volume will temporarily decrease to warn the driver with the audible warning.

* NOTICE

- Ensure that Warning Sound and Haptic you have set may apply to the Warning volume of other Driver Assistance systems.
- Warning Sound and Haptic will maintain its last setting even if the vehicle is restarted.
- If not equipped with the navigation system, select **User Settings** → **Driver Assistance** to adjust the Warning Volume.
- The setting menu may not be available for your vehicle depending on the vehicle features and specifications.
- Descriptions of each Driver Assistance system may be slightly different from the owner's manual after updating the software of your infotainment system. In this case, scan the QR code in the infotainment system manual to access the web manual for checking the changes.

Highway Driving Assist operation

Basic function

Displaying operating status

You can see the status of the Highway Driving Assist operation in the Driving Assist view on the cluster. Refer to "User settings mode" on page 5-78.

Operating State



Standby State



Highway Driving Assist will be displayed as below depending on the status of the function.

- 1 Highway Driving Assist indicator, whether there is a vehicle ahead and the selected distance level are displayed.
 - Highway Driving Assist indicator
 - Green **HDA**: Operating state
 - Grey **HDA**: Standby state
 - White **HDA** blink: Accelerator depressed state
- 2 Set speed
- 3 Lane Following Assist indicator
- 4 Whether there is a vehicle ahead and the selected headway
- 5 Whether the lane is detected or not

* NOTICE

- For more details on the display, refer to "Lane Following Assist (LFA)" on page 6-115.
- For more details on the display refer to "Smart Cruise Control (SCC (if equipped))" on page 6-95.
- The images and colors in the instrument cluster may differ depending on the cluster type or theme selected from the settings menu.

Highway Driving Assist operating

Highway Driving Assist operates when:

- When driving on available road, press Drive Assist button to turn on Highway Driving Assist.
- When entering the main roads of highways (or motorways) while Smart Cruise Control is operating, Driving Assist will not turn on if Lane Following Assist is turned off.

Restarting after stopping

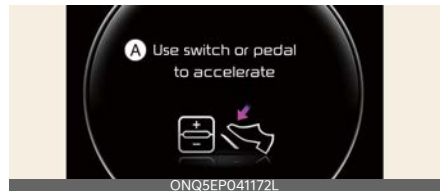

A: Use switch or pedal to accelerate

When Highway Driving Assist is operating, your vehicle will stop if the vehicle ahead of you stops. Also, if the vehicle ahead of you starts moving within 30 seconds after the stop, your vehicle will start as well. In addition, after the vehicle has stopped and 30 seconds have passed, the message will appear on the cluster. Depress the accelerator pedal or operate the (+) switch, (-) switch or (|||) switch to start driving.

Hands-off warning



A: Keep hands on steering wheel

If the driver takes their hands off the steering wheel for several seconds, the warning message will appear and an audible warning will sound in stages.

- First stage: Warning message
- Second stage: Warning message (red steering wheel) and audible warning



A: HDA (Motorway Driving Assist) sys. cancelled

If the driver still does not have their hands on the steering wheel after the hands-off warning, the warning message will appear and Highway Driving Assist will be automatically canceled.

Driving speed limit

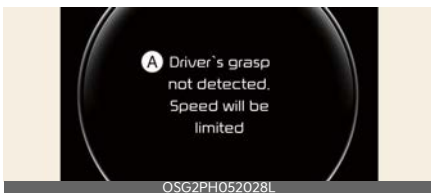

A: Driver's grasp not detected. Speed will be limited

When Highway Driving Assist is canceled by the hands-off warning, the driving speed will be limited.

While Driving Speed Limit function is operating, the warning message will appear on the cluster, and an audible warning will sound continuously.

Driving to one side within lane (if equipped)



When vehicle speed is above 40 mph (60 km/h), if a vehicle around you is driving at a close distance, your vehicle will control steering in the opposite direction of the vehicle to assist in safe driving. If there are vehicles in both sides of the lane that are driving close to you, the function will not veer to the opposite side of the lane.

Highway Driving Assist standby

When the Smart Cruise Control is temporarily canceled while Highway Driving Assist is operating, Highway Driving Assist will be in the standby state. At this time, Lane Following Assist will operate properly.

* NOTICE

- Driving Speed Limit helps you drive below 40 mph (60 km/h). At this time, the vehicle decelerates due to the vehicle ahead. After the vehicle has decelerated, it cannot automatically accelerate.
- Driving Speed Limit will cancel in the following circumstances:

- When the driver grabs the steering wheel again
- When the driver turns on Lane Following Assist by pressing the Lane Driving Assist button
- When (+), (-), (||) switch or (☺) button is operated, or the accelerator pedal or the brake pedal is depressed

Highway Lane Change Assist (if equipped)

Display and control

You can see the status of the Highway Lane Change Assist function operation in the Driving Assist view on the cluster. Refer to "LCD display" on page 5-75.

Highway Lane Change Assist function will be displayed as below depending on the status of the function.

Ready/Operating

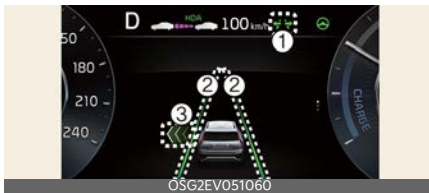

Standby/Canceled



1 Highway Lane Change Assist indicator

- Green (↔) on: Ready state
- Green (↔) blink: Operating state
- Grey (↔) on: Standby state

- White (↔) blink: Canceled state (display only a certain time)
- 2 Lane line**
The lane line is displayed identical to Highway Lane Change Assist indicator (1). However, the lane detection availability will be showed on Standby state.
 - 3 Green arrow and shade**
The green arrow is displayed when a certain amount of time has passed after the function has started operating, and until the lane change has completed.
 - 4 Message**
 - Message is displayed when the function does not operate even though the turn signal lever is used.
 - Message is displayed when the function is canceled while operating.

Highway Lane Change Assist function will turn on when the following conditions are satisfied.

- The Driving Assist button or Lane Driving Assist button is used to turn on Highway Driving Assist.

Highway Lane Change Assist ready to operate



A: Press OK button to enable Lane Change Assist

1 Confirm

While Highway Lane Change Assist function is on, the function will be ready

to operate when all the following conditions are satisfied:

- Highway Driving Assist is operating
- Lane Following Assist is operating
- A vehicle in the rear area of your vehicle is detected more than once after the vehicle is turned on
- Your vehicle speed is above 40 mph (60 km/h)
- Hands-off warning is not displayed on the cluster
- Hazard warning flasher is off

*** NOTICE**

- While Lane Change Assist function is turned on (indicator on), Lane Following Assist will not cancel even if the turn signal indicator or hazard warning flasher is operating.
- Lane Change Assist function turns off automatically when driven in the following road conditions:
 - One driving lane
 - A road with no structure, such as a medium strip, guardrails, etc.
 - There is a pedestrian or cyclist on the road ahead
- When the function is in the ready state, and vehicle speed is below 35 mph (55 km/h), the function will change to the standby state.
- The images or colors may be displayed differently depending on the specifications of the instrument cluster or theme.

⚠ WARNING

When Highway Lane Change Assist function turns off while operating, steering assist will be temporarily canceled. Always be cautious while driving.

Highway Lane Change Assist operating



Highway Lane Change Assist function will operate, when you push the turn signal lever to A or B position while the function is in the ready state (⚡⚡ indicator is green), and all of the following conditions are satisfied:

- The driver has his/her hand on the steering wheel
- There is no collision risk in the direction of lane change
- There is a single dotted lane line in the direction of lane change
- There are no Forward Collision-Avoidance Assist and Blind Spot Collision-Avoidance Assist warnings
- The vehicle is driven in the middle of the lane (should not be driving close to one side of the lane)
- The road you are driving on, or the road you are about to change lane is a road that the function can operate

*** NOTICE**

- When the turn signal lever is placed at A position, the Highway Lane Change Assist function is performed. After that, if the turn signal lever is placed in neutral, Highway Lane Change Assist function is canceled before stepping on the lane.

The Highway Lane Change Assist function is not canceled after stepping on the lane, but when the lane change

is completed, it is canceled and the turn signal turns off.

- When the turn signal lever is placed at B position for a certain period of time, the green arrow will appear. At this time, even when the lever is released and returns to its original position, lane change will still be assisted.
- While lane change is being made by the function, the turn signal indicator will blink even when the turn signal lever is not held, and the turn signal indicator will turn off when lane change is complete.
- Highway Lane Change Assist function will not operate on branch lines on the main road.

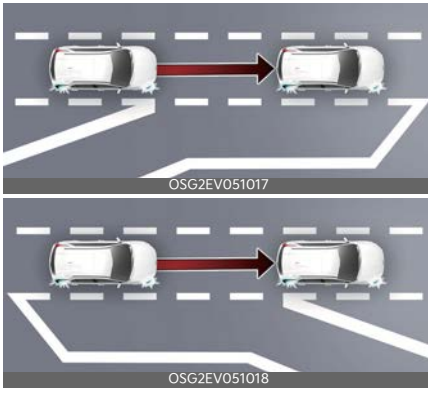

Highway Lane Change Assist standby

Highway Lane Change Assist function will be in the standby state when one of the ready state condition is not satisfied, or when entering or driving on one of the following roads:

- Road within a certain distance from the tollgate on the main road of the highway (or motorway)

- The road ahead ends without an interchange or junction
- Road with sharp curves
- Road with narrow lanes
- Road that is under construction

Highway Lane Change Assist cancel

The function will be canceled when:

- The turn signal lever is turned on in the opposite direction of lane change
- The steering wheel is steered sharply

⚠ WARNING

- While the function is operating, the function will cancel if one of the following occurs:
 - Highway Driving Assist is turned off
 - Lane Following Assist or Smart Cruise Control is turned off or temporarily canceled
 - Hands-off warning message is displayed on the cluster
 - The turn signal lever is placed at A position
 - The hazard warning flasher is turned on
 - Forward Collision-Avoidance Assist or Blind-Spot Collision-Avoidance Assist warning message is displayed
 - Possible collision is detected in the next lane, even though there are no Forward Collision-Avoidance Assist and Blind Spot Collision-Avoidance Assist warning
 - Entering a road under construction
 - The target lane to make a lane change disappears
 - The target lane to make a lane change is not detected

- There is a problem with turn signal lamps
- Highway Lane Change Assist function is off (The function turns off when the function is turned off from the settings menu, when the road changes to a one-way road, when there is an intersection or crosswalk ahead, when you enter a road with no structure, such as a medium strip, guardrail, etc., or when there is a pedestrian or cyclist on the driving lane.)
- Your vehicle speed is below 35 mph (55 km/h)
- While the function is operating, when the function is canceled, depending on the driving conditions, the vehicle may drive to the middle of the driving lane or steering assist may stop. Always pay attention to road and driving conditions while driving.
- The function may not operate normally on roads with pedestrians or cyclists, such as an intersection or crosswalk. Always pay attention to road and driving conditions while driving.



A: Check lane change assist function

When Highway Driving Assist is not working properly, the warning message will appear, and the (⚠️) warning light will appear on the cluster. Have Highway Driving Assist be inspected by an authorized Kia dealer.

⚠️ WARNING

- The driver is responsible for controlling the vehicle for safe driving.
- Always have your hands on the steering wheel while driving.
- Highway Driving Assist is a supplemental function that assists the driver in driving the vehicle and is not a complete autonomous driving system. Always check road conditions, and if necessary, take appropriate actions to drive safely.
- Always have your eyes on the road, and it is the responsibility of the driver to avoid violating traffic laws. The vehicle manufacturer is not responsible for any traffic violation or accidents caused by the driver.
- Highway Driving Assist may not be able to recognize all traffic situations. Highway Driving Assist may not detect possible collisions due to limitations of the function. Always be aware of the limitations of the function. Obstacles such as vehicles, motorcycles, bicycles, pedestrians, or unspecified objects or structures such as guardrails, tollgate, etc., that may

Highway Driving Assist malfunction and limitations

Highway Driving Assist malfunction



A: Check HDA (Motorway Driving Assist) system

collide with the vehicle may not be detected.

- Highway Driving Assist will turn off automatically under the following situations:
 - Driving on roads that Highway Driving Assist does not operate, such as a rest area, intersection, junction, etc.
 - The navigation does not operate properly such as when the navigation is being updated or restarted
- Highway Driving Assist may inadvertently operate or turn off depending on road conditions (navigation information) and surroundings.
- Lane Following Assist function may be temporarily disabled when the front view camera cannot detect lanes properly or the hands-off warning is on.
- You may not hear the warning sound of Highway Driving Assist if the surrounding is noisy.
- If the vehicle is driven at high speed above a certain speed at a curve, your vehicle may drive to one side or may depart from the driving lane.
- When you are towing a trailer or another vehicle, turn off Highway Driving Assist for safety reasons.
- The hands-off warning message may appear early or late depending on how the steering wheel is held or road conditions. Always have your hands on the steering wheel while driving.
- For your safety, please read the owner's manual before using the Highway Driving Assist.
- Highway Driving Assist will not operate when the vehicle is started, or

when the detecting sensors or navigation is being initialized.

Limitations of Highway Driving Assist

Highway Driving Assist and Highway Lane Change Assist may not operate properly, or it may not operate under the following circumstances:

- The map information and the actual road is different because the navigation is not updated
- The map information and the actual road is different because of real-time GPS data or map information error
- The infotainment system is overloaded by simultaneously performing functions such as route search, video playback, voice recognition, etc.
- GPS signals are blocked in areas such as a tunnel
- The driver goes off course, or resetting the navigation route by changing the destination (including route change according to real-time road traffic information), or canceling the route to the destination
- The vehicle enters a service station or rest area
- Android Auto or Car Play is operating
- The navigation cannot detect the current vehicle position (for example, elevated roads including overpass adjacent to general roads or nearby roads exist in a parallel way)
- White single dotted lane line or road edge cannot be detected
- The road is temporarily controlled due to construction, etc.
- There is no structure, such as a median strip, guardrails, etc., on the road

- There is a changeable lane in the direction of lane change
- When you are towing a trailer, carrying a carrier or other equipments

*** NOTICE**

For more details on the limitations of the front view camera and front radar, refer to "Forward Collision-Avoidance Assist (FCA) (Sensor Fusion)" on page 6-39.

This device complies with Part 15 of the FCC rules.

Operation is subject to the following three conditions:

1. This device may not cause harmful interference, and
2. This device must accept any interference received, including interference that may cause undesired operation.
3. Changes or modifications not expressly approved by the party responsible for compliance could void the user's authority to operate the device.

Radio frequency radiation exposure information:

This equipment complies with FCC radiation exposure limits set forth for an uncontrolled environment. This equipment should be installed and operated with minimum distance of 8 in (20 cm) between the radiator (antenna) and your body.

This transmitter must not be colocated or operating in conjunction with any other antenna or transmitter.

Rear View Monitor (RVM)

Rear View Monitor shows the area behind the vehicle to assist you when parking or backing up.

Detecting sensor

Wide-rear view camera



Refer to the picture above for the detailed location of the detecting sensor.

Rear View Monitor settings

Warning Sound and Haptic



A: Driver Assistance

1 Warning Sound and Haptic

2 Parking Safety Priority

With the vehicle on, touch **Settings** → **Vehicle** → **Driver Assistance** → **Warning Sound and Haptic** on the infotainment system to change the Warning Sound and Haptic.

- **Parking Safety Priority:** For safe parking, the audio volume will temporarily decrease while Rear View Monitor is operating.

* NOTICE

- If not equipped with the navigation system, select **User Settings** → **Driver Assistance** to adjust the Warning Volume.
- The setting menu may not be available for your vehicle depending on the vehicle features and specifications.
- Descriptions of each Driver Assistance system may be slightly different from the owner's manual after updating the software of your infotainment system. In this case, scan the QR code in the infotainment system manual to access the web manual for checking the changes.

Camera settings



A: Camera Settings

1 Display Contents

2 Display Settings

You can change Rear View Monitor 'Display Contents' by touching the setup icon (⚙️) on the screen while Rear View Monitor is operating, or touching **Settings** → **Vehicle** → **Driver assistance** → **Parking safety** → **Camera settings** on the infotainment system

- **Display Contents:** To change the settings of Rear view parking guide and Extended rear camera use.
- **Display Settings:** To change the screen's brightness and contrast.

* NOTICE

The settings menu may not be depending on the specifications of the vehicle specifications.

* INFORMATION

Descriptions for each function of the Driver Assistance system may differ from the owners' manual by infotainment software update. Refer to the web manual that you can access with the QR code in the infotainment system quick reference.

Display Contents

Rear View Parking Guide

Rear View Parking Guide Lines



If **Rear View Parking Guide Lines** is selected, the rear view parking guide lines will be displayed at the left side of the infotainment system screen.

* NOTICE

The horizontal guideline shows the distance of 1.6 ft. (0.5 m), 3.3 ft. (1 m) and 7.6 ft. (2.3 m) from the vehicle.

Top View Parking Guide Lines

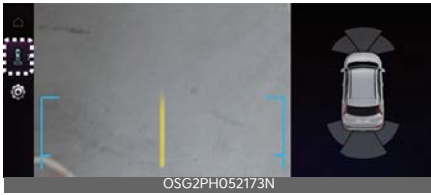

If **Rear View Parking Guide Lines** is selected, the top view parking guide lines will be displayed at the left side of the infotainment system screen.

* NOTICE

The horizontal scale of rear top view parking guide indicates the tailgate opening distance, 4.9 ft. (1.5 m) from the vehicle.

Extended Rear View Monitor

If Extended Rear View Monitor is selected, Rear View Monitor keeps displaying the rear view when shifting from R (Reverse) to N (Neutral) or D (Drive). When exceeding a certain speed, the rear view stops displaying.

Rear View Monitor operation

Parking/View button



Press the Parking/View button (1) to turn on Rear View Monitor.

Press the button again to turn off the function.

Rear view function

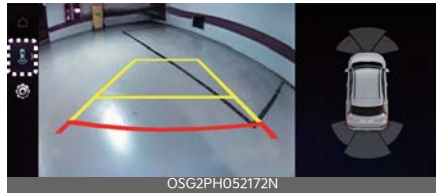

Operating conditions

Rear View Monitor will turn on when the following conditions are satisfied:

- Shifting the gear to R (Reverse).
- Pressing the Parking/View button (1) while P (Park) gear position is selected
- Pressing the View icon with the Rear top view on the screen

Off conditions

Rear View Monitor will turn off when the following conditions are satisfied:

- Pressing the Parking/View button (1) again while P (Park) gear position is selected. with the rear view on the screen.
- Changing the gear from R (Reverse) to P (Park).

* NOTICE

Rear View Monitor will not turn off when the vehicle is in R (Reverse).

Extended Rear View Monitor

Extended Rear View Monitor function maintains the rear view of the vehicle when shifting the gear from R (Reverse) to N (Neutral) or D (Drive) to help you park safely.

Operating conditions

Rear View Monitor will maintain when the following conditions are satisfied:

- Shifting the gear from R (Reverse) to N (Neutral) or D (Drive).
- The vehicle speed is below approximately 6 mph (10 km/h).

Off conditions

Extended Rear View Monitor function will turn off when one of the following conditions are satisfied:

- The vehicle speed is above approximately 6 mph (10 km/h).
- Pressing the Parking/View button (1).
- Shifting the gear to P (Park).

Rear Top View



Rear Top View shows the rear top view of your vehicle when parking for you to check the distance between an object and behind the vehicle.

Rear Top View will turn on under the following conditions:

- The gear is shifted to R (Reverse) and the icon is selected among the view buttons.
- The Parking/View button is pressed, while the gear is in P (Park), N (Neutral) or D (Drive), and vehicle speed is 6 mph (10 km/h) or less.

Rear View Monitor malfunction and limitations

Rear View Monitor malfunction

When Rear View Monitor is not working properly, or the screen flickers, or the camera image does not display properly, have the vehicle inspected by an authorized Kia dealer.

Limitations of Rear View Monitor

⚠ WARNING

- The wide-rear view camera does not cover the complete area behind the vehicle. The driver should always check the rear area directly through the inside and outside rearview mirror before parking or backing up.
- The image shown on the screen may differ from the actual distance of the object. Make sure to directly check the vehicle's surroundings for safety.
- Always keep the wide-rear view camera lens clean. If the lens is covered with foreign material, it may adversely affect camera performance and Rear View Monitor may not operate properly. However, do not use chemical solvents such as strong detergents containing high alkaline or volatile organic solvents (gasoline, acetone etc.). This may damage the camera lens.

Rear Cross-Traffic Collision-Avoidance Assist (RCCA) (if equipped)

Rear Cross-Traffic Collision-Avoidance Assist is designed to help detect vehicles approaching from the left and right side while your vehicle is reversing, and warn the driver that a collision is imminent with a warning message and an audible warning. Also, braking is assisted to help prevent collision.

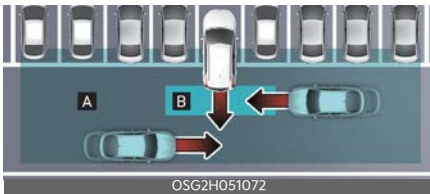

[A]: Rear Cross-Traffic Collision Warning operating range

[B]: Rear Cross-Traffic Collision-Avoidance Assist operating range

⚠ CAUTION

Warning timing may vary depending on vehicle speed of the approaching vehicle.

Detecting sensor

Rear corner radar



Refer to the picture above for the detailed location of the detecting sensors.

* NOTICE

For more details on the precautions of the rear corner radar, refer to "Blind-Spot Collision-Avoidance Assist (BCA) (if equipped)" on page 6-65.

Rear Cross-Traffic Collision-Avoidance Assist settings

Rear Cross-Traffic Safety

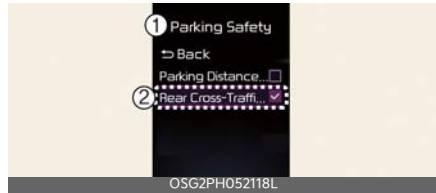

A: Driver Assistance

1 Parking Safety

2 Rear Cross-Traffic Safety

With the vehicle on, touch **Settings** → **Driver Assistance** → **Parking Safety** → **Rear Cross-Traffic Safety** from the User settings menu or select **Settings** → **Vehicle** → **Driver Assistance** → **Parking Safety** → **Rear Cross-Traffic Safety** on the infotainment system screen to turn on Rear Cross-Traffic Collision-Avoidance Assist.

⚠ WARNING

When the vehicle is restarted, Rear Cross-Traffic Collision-Avoidance Assist will always turn on. However, if **Rear Cross-Traffic Safety** is deselected after the vehicle is restarted, the driver should

always be aware of the surroundings and drive safely.

*** NOTICE**

If the vehicle is restarted, Warning Volume will maintain the last setting.

Warning Sound and Haptic

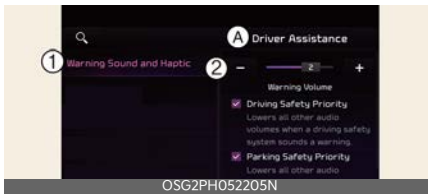

A: Driver Assistance

1 Warning Sound and Haptic

2 Warning Volume

With the vehicle on, touch **Settings** → **Vehicle** → **Driver Assistance** → **Warning Sound and Haptic** on the infotainment system to change the Warning Sound and Haptic.

- **Warning Volume:** You can adjust the Warning Volume from level 1 to 3.

*** NOTICE**

- Ensure that Warning Sound and Haptic you have set may apply to the Warning volume of other Driver Assistance systems.
- Warning Sound and Haptic will maintain its last setting even if the vehicle is restarted.
- If not equipped with the navigation system, select **User Settings** → **Driver Assistance** to adjust the Warning Volume.
- The setting menu may not be available for your vehicle depending on

the vehicle features and specifications.

- Descriptions of each Driver Assistance system may be slightly different from the owner's manual after updating the software of your infotainment system. In this case, scan the QR code in the infotainment system manual to access the web manual for checking the changes.

Rear Cross-Traffic Collision-Avoidance Assist operation

Rear Cross-Traffic Collision-Avoidance Assist will warn and control the vehicle depending on collision risk level: 'Collision warning', 'Emergency braking' and 'Stopping vehicle and ending brake control'.

Collision warning



A: Collision warning

- To warn the driver of an approaching vehicle from the rear left/right side of your vehicle, the warning light on the outside rearview mirror will blink and a warning will appear on the cluster. At the same time, an audible warning will sound. If the Rear View Monitor is operating, a warning will also appear on the infotainment system screen.
- Rear Cross-Traffic Collision-Avoidance Assist will operate when all the following conditions are satisfied:
 - The gear is shifted to R (Reverse)
 - Vehicle speed is below 5 mph (8 km/h)
 - The approaching vehicle is within approximately 82 ft. (25 m) from the left and right side of your vehicle
 - The speed of the vehicle approaching from the left and right is above 3 mph (5 km/h)

*** NOTICE**

- If the operating conditions are satisfied, there will be a warning whenever the vehicle approaches from the left or right side even though your vehicle speed is 0 mph (0 km/h).
- The images and colors in the cluster may differ depending on the cluster type or theme selected from the cluster.

Emergency braking



A: Emergency Braking

- To warn the driver of an approaching vehicle from the rear left/right side of your vehicle, the warning light on the outside rearview mirror will blink and a warning message will appear on the cluster. At the same time, an audible warning will sound. A warning will also appear on the infotainment system screen.
- Emergency braking will be assisted to help prevent collision with approaching vehicles from the left and right.
- Rear Cross-Traffic Collision-Avoidance Assist will operate when all the following conditions are satisfied:
 - The gear is shifted to R (Reverse)
 - Vehicle speed is below 5 mph (8 km/h)
 - The approaching vehicle is within approximately 5 ft. (1.5 m) from the left and right side of your vehicle
 - The speed of the vehicle approaching from the left and right is above 3 mph (5 km/h)

⚠ WARNING

Brake control ends when the conditions of the approaching vehicle from the rear left or right side are as below:

- The approaching vehicle is out of the detecting range
- The approaching vehicle passes behind your vehicle
- The approaching vehicle does not drive toward your vehicle
- The approaching vehicle speed slows down
- The driver depresses the brake pedal with sufficient power

Stopping vehicle and ending brake control



A: Drive carefully

- When the vehicle is stopped due to emergency braking, the warning message will appear on the cluster.
- Brake control will end after the vehicle is stopped by emergency braking for approximately 2 seconds.
- During emergency braking, braking control by Rear Cross-Traffic Collision-Avoidance Assist will automatically cancel when the driver excessively depresses the brake pedal.

WARNING

- For your safety, change the Settings after parking the vehicle at a safe location.
- If any other function's warning message is displayed or audible warning is generated, Rear Cross-Traffic Collision-Avoidance Assist's warning mes-

sage may not be displayed and audible warning may not be generated.

- You may not hear the warning sound of Rear Cross-Traffic Collision-Avoidance Assist if the surrounding is noisy.
- Rear Cross-Traffic Collision-Avoidance Assist may not operate if the driver applies the brake pedal to avoid collision.
- During Rear Cross-Traffic Collision-Avoidance Assist operation, the vehicle may stop suddenly injuring passengers and shifting loose objects. Always have the seat belt on and keep loose objects secured.
- Even if there is a problem with Rear Cross-Traffic Collision-Avoidance Assist, the vehicle's basic braking performance will operate properly.

WARNING

- When Rear Cross-Traffic Collision-Avoidance Assist is operating, braking control by function will automatically cancel when the driver excessively depresses the accelerator pedal.
- Rear Cross-Traffic Collision-Avoidance Assist does not operate in all situations or cannot avoid all collisions.
- Rear Cross-Traffic Collision-Avoidance Assist may warn the driver late or may not warn the driver depending on the road and driving conditions.
- The driver should hold the responsibility to control the vehicle. Do not solely depend on Rear Cross-Traffic Collision-Avoidance Assist. Rather, maintain a safe braking distance, and if necessary, depress the brake pedal to reduce driving speed or to stop the vehicle.

- Never deliberately operate Rear Cross-Traffic Collision-Avoidance Assist on people, animal, objects, etc. It may cause serious injury or death.

⚠ WARNING

The brake control may not operate properly depending on the status of ESC (Electronic Stability Control).

There will only be a warning when:

- The ESC (Electronic Stability Control) warning light is on
- ESC (Electronic Stability Control) is engaged in a different function

*** NOTICE**

- If braking is assisted by Rear Cross-Traffic Collision-Avoidance Assist, the driver must immediately depress the brake pedal and check vehicle surroundings.
- After shifting the gear to R (Reverse), braking control will operate once for left and right vehicle approach.

Rear Cross-Traffic Collision-Avoidance Assist malfunction and limitations

Rear Cross-Traffic Collision-Avoidance Assist malfunction

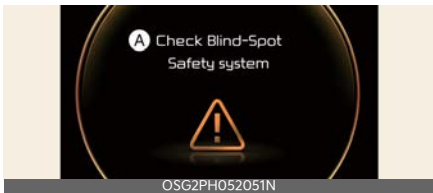

A: Check Blind-Spot Safety system

When Rear Cross-Traffic Collision-Avoidance Assist is not working properly, the warning message will appear on

the cluster for several seconds, and the master (⚠) warning light will appear on the cluster. If this occurs, have the function be inspected by an authorized Kia dealer.



A: Check side view mirror warning light

When the outside rearview mirror warning light is not working properly, the warning message will appear on the cluster for several seconds, and the master (⚠) warning light will appear on the cluster. If this occurs, have the function be inspected by an authorized Kia dealer.

Rear Cross-Traffic Collision-Avoidance Assist disabled

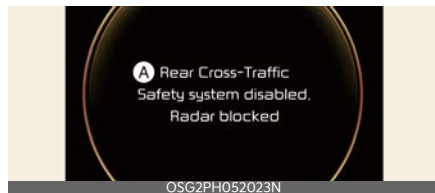

A: Rear Cross-Traffic Safety system disabled. Radar blocked

When the rear bumper around the rear-side radar or sensor is covered with foreign material, such as snow or rain, or installing a trailer or carrier, it can reduce the detecting performance and temporarily limit or disable Rear Cross-Traffic Collision-Avoidance Assist.

If this occurs, the warning message will appear on the cluster.

Rear Cross-Traffic Collision-Avoidance Assist will operate properly when such foreign material or trailer, etc., is removed.

If Rear Cross-Traffic Collision-Avoidance Assist does not operate properly after it is removed, have the function be inspected by an authorized Kia dealer.

⚠ WARNING

- Even though the warning message does not appear on the cluster, Rear Cross-Traffic Collision-Avoidance Assist may not operate properly.
- Rear Cross-Traffic Collision-Avoidance Assist may not operate properly in an area (for example, open terrain), where any substance are not detected after turning ON the vehicle.

⚠ CAUTION

Turn off Rear Cross-Traffic Collision-Avoidance Assist to install or remove a trailer, carrier, or another attachment. Turn on Rear Cross-Traffic Collision-Avoidance Assist when finished.

Limitations of Rear Cross-Traffic Collision-Avoidance Assist

Rear Cross-Traffic Collision-Avoidance Assist may not operate properly, or it may operate unexpectedly under the following circumstances:

- Departing from where trees or grass are overgrown
- Departing from where roads are wet
- Speed of the approaching vehicle is fast or slow

Braking control may not work, driver's attention is required in the following circumstances:

- The vehicle severely vibrates while driving over a bumpy road, uneven road or concrete patch
- Driving on a slippery surface due to snow, water puddle, ice, etc.
- The tire pressure is low or a tire is damaged
- The brake is tuned
- Remote Smart Parking Assist is operating (if equipped)

*** NOTICE**

For more details on the limitations of the rear corner radar, refer to "Blind-Spot Collision-Avoidance Assist (BCA) (if equipped)" on page 6-65.

⚠ WARNING

- Driving near a vehicle or structure



[A]: Structure

Rear Cross-Traffic Collision-Avoidance Assist may be limited when driving near a vehicle or structure, and may not detect the vehicle approaching from the left or right. If this occurs, the function may not warn the driver or control the brakes when necessary. Always check your surroundings while backing up.

- When the vehicle is in a complex parking environment



Rear Cross-Traffic Collision-Avoidance Assist may detect vehicles which are parking or pulling out near your vehicle (example, a vehicle leaving beside your vehicle, a vehicle parking or pulling out in the rear area, a vehicle approaching your vehicle making a turn, etc.).

If this occurs, the function may unnecessarily warn the driver and control the brake.

Always check your surroundings while backing up.

- When the vehicle is parked diagonally



Rear Cross-Traffic Collision-Avoidance Assist may be limited when backing up diagonally, and may not detect the vehicle approaching from the left or right. If this occurs, the function may not warn the driver or control the brakes when necessary.

Always check your surroundings while backing up.

- When the vehicle is on or near a slope



Rear Cross-Traffic Collision-Avoidance Assist may be limited when the vehicle is on a uphill or downhill slope, or near it, and may not detect the vehicle approaching from the left or right. If this occurs, the function may not warn the driver or control the brakes when necessary.

Always check your surroundings while backing up.

- Pulling into the parking space where there is a structure



[A]: Structure,

[B]: Wall

Rear Cross-Traffic Collision-Avoidance Assist may detect vehicles passing by in front of you when parking in reverse into a parking space with a wall or structure in the rear or side area. If this occurs, the function may unnecessarily warn the driver and control the brake.

Always check your surroundings while backing up.

- When the vehicle is parked rearward

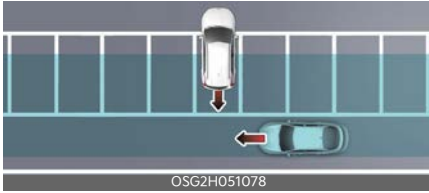

Rear Cross-Traffic Collision-Avoidance Assist may detect vehicles passing by behind you when parking in reverse into a parking space. If this occurs, the function may unnecessarily warn the driver and control the brake.

Always check your surroundings while backing up.

⚠ WARNING

- When you are towing a trailer or another vehicle, turn off Rear Cross-Traffic Collision-Avoidance Assist for safety reasons.
- Rear Cross-Traffic Collision-Avoidance Assist may not operate properly if interfered by strong electromagnetic waves.
- Rear Cross-Traffic Collision-Avoidance Assist may not operate for 3 seconds after the vehicle is started, or the rear corner radars are initialized.

This device complies with Part 15 of the FCC rules.

Operation is subject to the following two conditions:

1. This device may not cause harmful interference, and
2. This device must accept any interference received, including interference that may cause undesired operation.

Reverse Parking Distance Warning (PDW) (if equipped)

Reverse Parking Distance Warning will help warn the driver if a person, an animal or an object is detected within a certain distance when the vehicle is moving in reverse.

Detecting sensor

Rear ultrasonic sensors



Refer to the picture above for the detailed location of the detecting sensors.

Reverse Parking Distance Warning settings

Warning Sound and Haptic

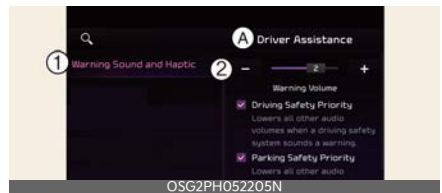

A: Driver Assistance

1 Warning Sound and Haptic

2 Warning Volume

With the vehicle on, touch **Settings** → **Vehicle** → **Driver Assistance** → **Warning Sound and Haptic** on the infotainment system to change the Warning Sound and Haptic.

- **Warning Volume:** You can adjust the Warning Volume from level 1 to 3.

*** NOTICE**

- Ensure that Warning Sound and Haptic you have set may apply to the Warning volume of other Driver Assistance systems.
- Warning Sound and Haptic will maintain its last setting even if the vehicle is restarted.
- If not equipped with the navigation system, select **User Settings** → **Driver Assistance** to adjust the Warning Volume.
- The setting menu may not be available for your vehicle depending on the vehicle features and specifications.
- Descriptions of each Driver Assistance system may be slightly different from the owner's manual after updating the software of your infotainment system. In this case, scan the QR code in the infotainment system manual to access the web manual for checking the changes.

Reverse Parking Distance Warning operation

Parking Safety button



Press the Parking Safety (P+) button to turn on or off Reverse Parking Distance Warning.

- When Reverse Parking Distance Warning is off (button indicator light off), if you shift the gear to R

(Reverse), Reverse Parking Distance Warning will automatically turn on.

- If you shift the gear to R (Reverse), Reverse Parking Distance Warning will not turn off even if you press the Parking Safety (P+) button for your safety.

Reverse Parking Distance Warning

Reverse Parking Distance Warning will operate under the following conditions.

- Shift the gear to R (Reverse).
- The vehicle's speed is below 6 mph (10 km/h).

Warning indication and warning sound

Distance from object	Warning indicator when driving backward	Warning sound
24-48 inches (60-120 cm)		Buzzer beeps intermittently
12-24 inches (30-60 cm)		Beeps more frequently
12 inches (within 30 cm)		Beeps continuously

- The corresponding indicator will appear on the cluster or infotainment system whenever each ultrasonic sensor detects a person, animal or object in its sensing range. Also an audible warning will sound.
- When more than two objects are detected at the same time, the closest one will be warned with an audible warning.

- Distance from object may be detected differently when obstacles are not located in front of the sensor.
- The shape of the indicator in the illustration may differ from the actual vehicle.

Reverse Parking Distance Warning malfunction and precautions

Reverse Parking Distance Warning malfunction

After starting the vehicle, a beep will sound once when the gear is shifted to R (Reverse) to indicate Reverse Parking Distance Warning is operating normally. However, if one or more of the following occurs, first check whether the ultrasonic sensor is damaged or blocked with foreign material. If it still does not work properly, have the vehicle inspected by an authorized Kia dealer.

- The audible warning does not sound.
- The buzzer sounds intermittently.
- The warning message appears on the cluster.



A: Ultrasonic sensor error or blockage

Limitations of Reverse Parking Distance Warning

- Reverse Parking Distance Warning may not operate normally when:
 - Moisture is frozen to the sensor (Reverse Parking Distance Warning will operate normally when it is melted.)

- Sensor is covered with foreign material, such as snow or water (Reverse Parking Distance Warning will operate normally when such foreign material are removed.)
- The weather is extremely hot or cold
- The sensor or sensor assembly is disassembled
- The surface of the sensor is pressed hard or an impact is applied with a hard object
- The surface of the sensor is scratched with a sharp object
- The sensors or its surrounding area is directly sprayed with high pressure washer
- Reverse Parking Distance Warning may malfunction when:
 - Heavy rain or water spray is present
 - Water flows on the surface of the sensor
 - Affected by another vehicle's sensors
 - The sensor is covered with snow
 - Driving on uneven road, gravel roads or bushes
 - Objects that generates ultrasonic waves are near the sensor
 - Installing the license plate differently from the original location
 - The vehicle bumper height or ultrasonic sensor installation has been modified
 - Attaching equipments or accessories around the ultrasonic sensors
- The following objects may not be detected:
 - Sharp or slim objects, such as ropes, chains or small poles.

- Objects, which tend to absorb sensor frequency, such as clothes, spongy material or snow.
- Objects smaller than 40 inches (100 cm) in length and narrower than 6 inches (14 cm) in diameter.
- Pedestrians, animals or objects that are very close to the ultrasonic sensors

⚠ WARNING

- Reverse Parking Distance Warning is a supplemental function. The operation of Reverse Parking Distance Warning can be affected by several factors (including environmental conditions). It is the responsibility of the driver to always check the rear view before and while parking.
- Your vehicle warranty does not cover any accidents or damage to the vehicle due to the malfunction of Reverse Parking Distance Warning.
- Pay close attention when driving near objects, pedestrians, and especially children. Some objects may not be detected by the ultrasonic sensors, due to the objects distance, size or material, all of which can limit the effectiveness of the sensor.
- Parking Distance Warning indicator may not occur sequentially depending on vehicle speed or obstacle shape.
- If Reverse Parking Distance Warning needs repair, have the vehicle inspected by an authorized Kia dealer.

Forward/Reverse Parking Distance Warning (PDW) (if equipped)

Forward/Reverse Parking Distance Warning will help warn the driver if an obstacle is detected within a certain distance when the vehicle is moving forward or in reverse at low speeds.

Detecting sensor

Front ultrasonic sensors



Rear ultrasonic sensors



Refer to the picture above for the detailed location of the detecting sensors.

Forward/Reverse Parking Distance Warning settings

Warning Sound and Haptic

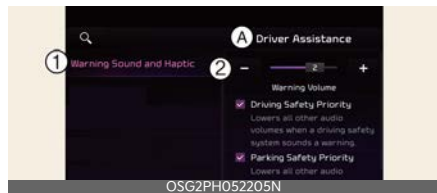

A: Driver Assistance

1 Warning Sound and Haptic

2 Warning Volume

With the vehicle on, touch **Settings** → **Vehicle** → **Driver Assistance** → **Warning Sound and Haptic** on the infotainment system to change the Warning Sound and Haptic.

- **Warning Volume:** You can adjust the Warning Volume from level 1 to 3.

* NOTICE

- Ensure that Warning Sound and Haptic you have set may apply to the Warning volume of other Driver Assistance systems.
- Warning Sound and Haptic will maintain its last setting even if the vehicle is restarted.
- If not equipped with the navigation system, select **User Settings** → **Driver Assistance** to adjust the Warning Volume.
- The setting menu may not be available for your vehicle depending on the vehicle features and specifications.
- Descriptions of each Driver Assistance system may be slightly different from the owner's manual after updating the software of your infotainment system. In this case, scan the QR code in the infotainment system manual to access the web manual for checking the changes.

Parking Distance Warning Auto On

You can set the parking distance warning to be ON at low speeds. To use Parking Distance Warning Auto On function, select **Settings** → **Driver Assistance** → **Parking Safety** → **Parking Distance Warning Auto On** on the instrument

cluster or **Settings** → **Vehicle** → **Driver Assistance** → **Parking Safety** → **Parking Distance Warning Auto On** on the infotainment system.

* NOTICE

When **Parking Distance Warning Auto On** is selected, the Parking Safety button indicator (P+▲) stays on.

Parking Distance Warning operation

Control switch

Parking Safety button



- Press the Parking Safety (P+▲) button to turn on Forward/Reverse Parking Distance Warning. Press the button again to turn off the function.
- When the gear is shifted to R (Reverse), Parking Distance Warning will automatically turn on (Parking Safety button indicator on).
- When the gear is in R (Reverse), Parking Distance Warning does not turn off even if the Parking Safety button (3) is pressed.

Forward Parking Distance Warning

Forward Parking Distance Warning will operate under the following conditions.



- The gear is shifted from R (Reverse) to D (Drive) with Reverse Parking Distance Warning on

- The gear is in D (Drive) and the Parking Safety (P_{SA}) button indicator light is on
- Forward Parking Distance Warning warns the driver when the vehicle is in D (Drive)
(If **Settings** → **Driver Assistance** → **Parking Safety** → **Parking Distance Warning Auto On** on the instrument cluster or **Settings** → **Vehicle** → **Driver Assistance** → **Parking Safety** → **Parking Distance Warning Auto On** on the infotainment system selected)
- Vehicle speed is below 6 mph (10 km/h).

*** NOTICE**

- Forward Parking Distance Warning does not operate when the vehicle's forward speed is above 6 mph (10 km/h) even when the Parking Safety (P_{SA}) button indicator is on. Forward Parking Distance Warning will operate again when the vehicle's forward speed decreases below 6 mph (10 km/h) while the Parking Safety (P_{SA}) button indicator is on.
- When the vehicle's forward speed is above 18 mph (30 km/h), the Forward Parking Distance Warning will turn off (Parking Safety button indicator off). Although you drive below 6 mph (10 km/h) again, Forward Parking Distance Warning will not automatically turn on (If **Settings** → **Driver Assistance** → **Parking Safety** → **Parking Distance Warning Auto On** on the instrument cluster or **Settings** → **Vehicle** → **Driver Assistance** → **Parking Safety** → **Parking Distance Warning Auto On** on the infotainment system not selected).

Warning indication and warning sound

Distance from object	Warning indicator when driving forward	Warning sound
24~40 inches (60~100 cm)		Buzzer beeps intermittently
12~24 inches (30~60 cm)		Beeps more frequently
12 inches (within 30 cm)		Beeps continuously

- The corresponding indicator will appear whenever each ultrasonic sensor detects a person, animal or object in its sensing range. Also an audible warning will sound.
- When more than two objects are detected at the same time, the closest one will be warned with an audible warning.
- The shape of the indicator in the illustration may differ from the actual vehicle.

Reverse Parking Distance Warning



Reverse Parking Distance Warning will operate under the following conditions.

- The gear is shifted to R (Reverse).
- Vehicle speed is below 6 mph (10 km/h).

*** NOTICE**

Parking Distance Warning detects and warns the driver of both rear and front corners, when the vehicle speed is below 6 mph (10 km/h).

Warning indication and warning sound

Distance from object	Warning indicator when driving backward	Warning sound
24-48 inches (60-120 cm)		Buzzer beeps intermittently
12-24 inches (30-60 cm)		Beeps more frequently
12 inches (within 30 cm)		Beeps continuously

- The corresponding indicator will appear whenever each ultrasonic sensor detects a person, animal or object in its sensing range. Also an audible warning will sound.
- When more than two objects are detected at the same time, the closest one will be warned with an audible warning.
- The shape of the indicator in the illustration may differ from the actual vehicle.

Parking Distance Warning malfunction and limitations

Parking Distance Warning malfunction

After starting the vehicle, a beep will sound when the gear is shifted to R (Reverse) to indicate Parking Distance Warning is operating properly.

However, if one or more of the following occurs, first check whether the ultrasonic sensor is damaged or blocked with foreign material. If it still does not work properly, have the vehicle inspected by an authorized Kia dealer.

- The direction of Parking Distance Warning sensor malfunction is shown on the instrument cluster.



A: Ultrasonic sensor error or blockage

Parking Distance Warning disabled

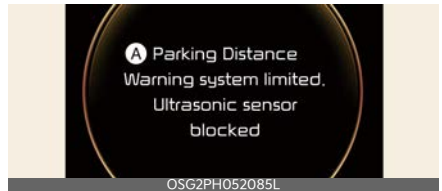

A: Parking Distance Warning system limited. Ultrasonic sensor blocked

If this occurs, the warning message appears on the cluster. Parking Distance Warning will operate properly when snow, rain or foreign material is removed. If Parking Distance Warning does not operate properly after obstruction (snow, rain, or foreign material) is removed (including trailer, carrier, etc., from the rear bumper), have the vehicle inspected by an authorized Kia dealer.

Limitations of Parking Distance Warning

- Parking Distance Warning may not operate properly when:
 - Moisture is frozen to the sensor
 - Sensor is covered with foreign substance, such as snow or water (Parking Distance Warning will operate properly when such substance is removed.)

- The weather is extremely hot or cold
- The sensor or sensor assembly is disassembled
- The surface of the sensor is pressed hard or hit with a hard object
- The surface of the sensor is scratched with a sharp object
- The sensors or its surrounding area is directly sprayed with high pressure washer
- Parking Distance Warning may malfunction when:
 - Heavy rain or water spray is present
 - Water flows on the surface of the sensor
 - Affected by another vehicle's sensors
 - The sensor is covered with snow or ice
 - Driving on uneven road, gravel roads or bushes
 - Objects that generates ultrasonic waves are near the sensor
 - License plate is installed in a different spot from the original location
 - The vehicle bumper height or ultrasonic sensor installation has been modified
 - Attaching equipment or accessories next to the ultrasonic sensors
- The following objects may not be detected:
 - Sharp or slim objects, such as ropes, chains or small poles.
 - Narrow objects, such as corners of a square column

- Objects, which tend to absorb sensor frequency, such as clothes, spongy material or snow.
- Objects smaller than 40 inches (100 cm) in length and narrower than 6 inches (14 cm) in diameter.
- Pedestrians, animals or objects that are very close to the ultrasonic sensors

 **WARNING**

- Parking Distance Warning is a supplemental function. The operation of Parking Distance Warning can be affected by several factors (including environmental conditions). It is the responsibility of the driver to always check the front and rear views before and while parking.
 - Your new vehicle warranty does not cover any accidents or damage to the vehicle due to the malfunction of Parking Distance Warning.
 - Pay close attention when driving near objects, pedestrians, and especially children. Some objects may not be detected by the ultrasonic sensors, due to the objects distance, size or material, all of which can limit the effectiveness of the sensor.
 - Parking Distance Warning does not warn you in the order of detection. It varies depending on the speed of the vehicle or the shape of a person, animal, or object.
 - If the Parking Distance Warning does not operate properly, have the vehicle inspected by an authorized Kia dealer.
-

Reverse Parking Collision-Avoidance Assist (PCA) (if equipped)

Reverse Parking Collision-Avoidance Assist can warn the driver or assist with braking to help reduce the possibility of collision with a pedestrian or an object while driving at low speed.

Detecting sensor

Wide-rear view camera



Rear ultrasonic sensors



Parking Collision-Avoidance Assist settings

Rear Safety

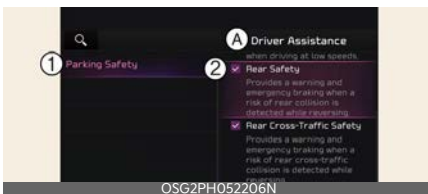

A: Driver Assistance

1 Parking Safety

2 Rear Safety

With the vehicle on, touch **Settings** → **Vehicle** → **Driver Assistance** → **Parking Safety** → **Rear Safety** on the infotainment system to set the Rear Safety.

* NOTICE

- If the vehicle is restarted, Warning volume will maintain the last setting.
- If you change the Warning volume, the Warning volume of other Driver Assistance systems may change.

Warning Sound and Haptic



A: Driver Assistance

1 Warning Sound and Haptic

2 Warning Volume

With the vehicle on, touch **Settings** → **Vehicle** → **Driver Assistance** → **Warning Sound and Haptic** on the infotainment system to change the Warning Sound and Haptic.

- **Warning Volume:** You can adjust the Warning Volume from level 1 to 3.

* NOTICE

- Ensure that Warning Sound and Haptic you have set may apply to the Warning volume of other Driver Assistance systems.
- Warning Sound and Haptic will maintain its last setting even if the vehicle is restarted.
- If not equipped with the navigation system, select **User Settings** →

Driver Assistance to adjust the Warning Volume.

- The setting menu may not be available for your vehicle depending on the vehicle features and specifications.
- Descriptions of each Driver Assistance system may be slightly different from the owner's manual after updating the software of your infotainment system. In this case, scan the QR code in the infotainment system manual to access the web manual for checking the changes.

Parking Collision-Avoidance Assist operation

Turning Parking Collision Avoidance Assist On/Off



Press and hold the Parking Safety (PWA) button more than 2 seconds, 'Rear Active Assist' or to turn the Parking Collision-Avoidance Assist on or off.

Operating conditions

Select 'Rear Safety' from the 'Parking Safety' menu of the infotainment system. Parking Collision-Avoidance Assist is enabled when the following conditions are satisfied:

- The tailgate and door are closed
- The Electronic Parking Brake (EPB) is released
- A trailer is not connected

- The gear is shifted to R (Reverse)
- Vehicle speed is below 6 mph (10 km/h) (detecting pedestrians)
- Vehicle speed is below 2 mph (4 km/h) (detecting objects)
- Parking Collision-Avoidance Assist components such as the wide-rear view camera and the rear ultrasonic sensors are in normal conditions



When Parking Collision-Avoidance Assist activates, a line appears behind the vehicle image in the instrument cluster.

* NOTICE

Parking Collision-Avoidance Assist operates only once after shifting the gear to R (Reverse). To reactivate Parking Collision-Avoidance Assist, shift the gear from another gear to R (Reverse).

Parking Collision-Avoidance Assist

If Parking Collision-Avoidance Assist detects a risk of collision around the vehicle with a pedestrian or an object, Parking Collision-Avoidance Assist will warn the driver with an audible warning and warning message on the instrument cluster. If the infotainment screen is on, a warning will appear on the screen.

If collision is imminent, Parking Collision-Avoidance Assist will assist you with braking.

Braking assist is released after 5 minutes. Immediately depress the brake pedal and check vehicle surroundings.

Braking assist is also released in the following conditions when:

- The gear is shifted to P (Park) or D (Drive)
- The brake pedal is depressed with sufficient power

*** NOTICE**

When Parking Collision-Avoidance Assist is activated while reversing, braking control will be released after 5 minutes and the Electronic Parking Brake (EPB) will be engaged.

Parking Collision-Avoidance Assist malfunction and limitations

Parking Collision-Avoidance Assist malfunction



When Parking Collision-Avoidance Assist or other related functions are not working properly, the warning message will appear on the cluster, and Parking Collision-Avoidance Assist will turn off automatically. Have the vehicle inspected by an authorized Kia dealer.

Parking Collision-Avoidance Assist disabled

Wide-rear view camera



The wide angle cameras are used as detecting sensors to detect pedestrians. If the camera lens is covered with foreign material, such as snow or rain, it may adversely affect camera performance and Parking Collision-Avoidance Assist may not operate properly. Always keep the camera lens clean.

Rear ultrasonic sensors



The ultrasonic sensors detect objects around the vehicle. If the sensors are covered with foreign material, such as snow or rain, it may adversely affect sensor performance and Parking Collision-Avoidance Assist may not operate properly. Always keep the rear bumper clean.

Warning message

Wide-rear view camera

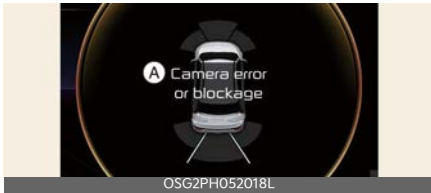

A: Camera error or blockage

Rear ultrasonic sensors

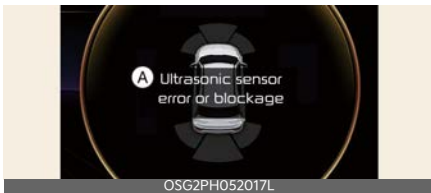

A: Ultrasonic sensor error or blockage

The warning message will appear on the cluster if the following situations occur:

- The camera(s) or ultrasonic sensor(s) is covered with foreign material, such as snow or rain, etc.
- There is inclement weather, such as heavy snow, heavy rain, etc.

If this occurs, Parking Collision-Avoidance Assist may turn off or may not operate properly. Check whether the cameras and ultrasonic sensors are clean.

Limitations of Parking Collision-Avoidance Assist

Parking Collision-Avoidance Assist may not assist braking or warn the driver even if there are pedestrians or objects under the following circumstances:

- There is a problem with the vehicle
- Any non-factory equipment or accessory is installed

- Your vehicle is unstable due to an accident or other causes
- Bumper height or rear ultrasonic sensor installation has been modified
- Wide view camera(s) or ultrasonic sensor(s) is damaged
- Wide view camera(s) or the ultrasonic sensor(s) is stained with foreign material, such as snow, dirt, etc.
- There is a problem with the surroundings
- Wide view camera(s) is obscured by a light source or by inclement weather, such as heavy rain, fog, snow, etc.
- The surrounding is very bright or very dark
- Outside temperature is very high or very low
- The wind is either strong (above 12 mph (20 km/h)) or blowing perpendicular to the rear bumper
- Objects generating excessive noise, such as vehicle horns, loud motorcycle vehicles or truck air brakes, are near your vehicle
- An ultrasonic sensor with similar frequency is near your vehicle
- The road is slippery or inclined
- There is a problem with the pedestrians or objects
- The pedestrians are difficult to detect
- There is ground height difference between the vehicle and the pedestrian
- The image of the pedestrian in the front view camera is indistinguishable from the background
- The pedestrian is near the rear edge of the vehicle
- The pedestrian is not standing upright

- The pedestrian is either very short or very tall to detect
- The pedestrian or cyclist is wearing clothing that easily blends into the background, making it difficult to detect
- The pedestrian is wearing clothing that does not reflect ultrasonic waves well
- Size, thickness, height, or shape of the object does not reflect ultrasonic waves well (for example, pole, bush, curbs, carts, edge of a wall, etc.)
- The pedestrian or the object is moving
- The pedestrian or the object is very close to the rear of the vehicle
- There is a large object such as a wall is behind the pedestrian or the object
- The object is not located at the front or rear center of your vehicle
- The object is not parallel to the rear bumper
- There is a problem with the driving conditions
- The driver drives the vehicle immediately after shifting to R (Reverse) or D (Drive)
- The driver accelerates or circles the vehicle

Parking Collision-Avoidance Assist may unnecessarily warn the driver or assist with braking even if there are no pedestrians or objects under the following circumstances:

- There is a problem with the vehicle
- Any non-factory equipment or accessory is installed
- Your vehicle is unstable due to an accident or other causes
- Bumper height or rear ultrasonic sensor installation has been modified

- Your vehicle height is low or high due to heavy loads, abnormal tire pressure, etc.
- Wide view camera(s) or the rear ultrasonic sensor(s) is stained with foreign material, such as snow, dirt, etc.
- There is a problem with the surroundings
- The pattern on the road is mistaken for a pedestrian
- There is shadow or light reflecting on the ground
- Pedestrians or objects are around the path of the vehicle
- Objects generating excessive noise, such as vehicle horns, loud motorcycle vehicles or truck air brakes, are near your vehicle
- Your vehicle is backing towards a narrow passage or parking space
- Your vehicle is backing towards an uneven road surface, such as an unpaved road, gravel, bump, gradient, etc.
- A trailer or carrier is installed on the rear of your vehicle
- An ultrasonic sensor with similar frequency is near your vehicle
- An ultrasonic sensor with similar frequency is near your vehicle

WARNING

- Always pay extreme caution while driving. The driver is responsible for controlling the brake for safe driving.
- Always look around your vehicle to make sure there are no pedestrians or objects before moving the vehicle.
- The performance of Parking Collision-Avoidance Assist may vary under certain conditions. If vehicle speed is above 2 mph (4 km/h), Parking Colli-

sion-Avoidance Assist will provide collision avoidance assist only when pedestrians are detected. Always look around and pay attention when driving your vehicle.

- Some objects may not be detected by the rear ultrasonic sensors due to the objects distance, size or material, all of which can limit the effectiveness of the sensor.
- Parking Collision-Avoidance Assist may not operate properly or may operate unnecessarily depending on the road conditions and the surroundings.
- Do not solely rely on Parking Collision-Avoidance Assist. Doing so may lead to vehicle damage or injuries.
- Always keep the wide angle cameras and ultrasonic sensors clean.
- Do not use any cleanser containing acid or alkaline detergents when cleaning the camera lens. Use only a mild soap or neutral detergent, and rinse thoroughly with water.
- Do not spray the wide angle cameras or the rear ultrasonic sensors or their surrounding area directly with a high pressure washer. It may cause the wide angle cameras or the ultrasonic sensors to malfunction.
- Do not apply objects, such as a bumper sticker or a bumper guard, near the wide angle cameras or ultrasonic sensors or apply paint to the bumper. Doing so may adversely affect the performance of Parking Collision-Avoidance Assist.
- Never disassemble or apply impact on the wide angle cameras or the ultrasonic sensors components.
- Do not apply unnecessary force on the wide angle cameras or the ultra-

sonic sensors. Parking Collision-Avoidance Assist may not operate properly if the wide angle cameras or the ultrasonic sensor(s) is forcibly moved out of proper alignment. Have the vehicle inspected by an authorized Kia dealer.

- Noise may be heard when sudden braking occurs to avoid a collision.
- If any other warning sound such as the seat belt warning chime is already generated, Parking Collision-Avoidance Assist warning may not sound.
- Parking Collision-Avoidance Assist may not work properly if the bumper has been damaged, replaced or repaired.
- Parking Collision-Avoidance Assist may not operate properly if interfered by strong electromagnetic waves.
- Playing the vehicle audio system at high volume may prevent passengers from hearing Parking Collision-Avoidance Assist warning sounds.
- The brake control may not operate properly depending on the status of ESC (Electronic Stability Control). There will only be a warning when:
 - The ESC (Electronic Stability Control) warning light is on
 - ESC (Electronic Stability Control) is engaged in a different function
- Check your brake fluid and brake pad conditions regularly. The brake performance may decrease depending on brake conditions.

*** NOTICE**

Parking Collision-Avoidance Assist can detect a pedestrian or an object when:

- A pedestrian is standing behind the vehicle

- A large obstacle, such as a vehicle, is parked in the rear center of your vehicle

Remote Smart Parking Assist (RSPA) (if equipped)

Remote Smart Parking Assist uses vehicle sensors to help the driver park and exit parking spaces remotely from outside the vehicle by controlling the steering wheel, vehicle speed and gearshifts.

Function	Description
Remote Operation	Remotely moving forward or backward 

- Remote Operation function may be operated from outside the vehicle using the smart key.
- When Remote Smart Parking Assist operates, Parking Distance Warning and Rear View Monitor will also operate. For more details, refer to "Forward/Reverse Parking Distance Warning (PDW) (if equipped)" on page 6-142, and "Rear View Monitor (RVM)" on page 6-128.

Detecting sensor

Front ultrasonic sensors



Front side ultrasonic sensors



Rear side ultrasonic sensors



Rear ultrasonic sensors



Refer to the picture above for the detailed location of the detecting sensors.

⚠ CAUTION

- Never disassemble the detecting sensor or sensor assembly, or cause any damage to it.
- If the detecting sensors need repair, have your vehicle inspected by an authorized Kia dealer.
- Remote Smart Parking Assist may malfunction if the vehicle bumper height or ultrasonic sensor installation has been modified or damaged. Any non-factory installed equipment or accessories may also interfere with the sensor performance.
- When the ultrasonic sensor is frozen or stained with snow, dirt, or water, the sensor may not operate until the stains are removed using a soft cloth.
- Do not push, scratch or strike the ultrasonic sensor. Sensor damage could occur.
- Do not spray the ultrasonic sensors or its surrounding area directly with a high pressure washer.

Remote Smart Parking Assist settings

Warning Sound and Haptic



A: Driver Assistance

1 Warning Sound and Haptic

2 Warning Volume

With the vehicle on, touch **Settings** → **Vehicle** → **Driver Assistance** → **Warning Sound and Haptic** on the infotainment system to change the Warning Sound and Haptic.

- **Warning Volume:** You can adjust the Warning Volume from level 1 to 3.

*** NOTICE**

- Ensure that Warning Sound and Haptic you have set may apply to the Warning volume of other Driver Assistance systems.
- Warning Sound and Haptic will maintain its last setting even if the vehicle is restarted.
- The setting menu may not be available for your vehicle depending on the vehicle features and specifications.
- Descriptions of each Driver Assistance system may be slightly different from the owner's manual after updating the software of your infotainment system. In this case, scan the QR code in the infotainment system manual to access the web manual for checking the changes.

Remote Smart Parking Assist operation

Remote Smart Parking Assist button

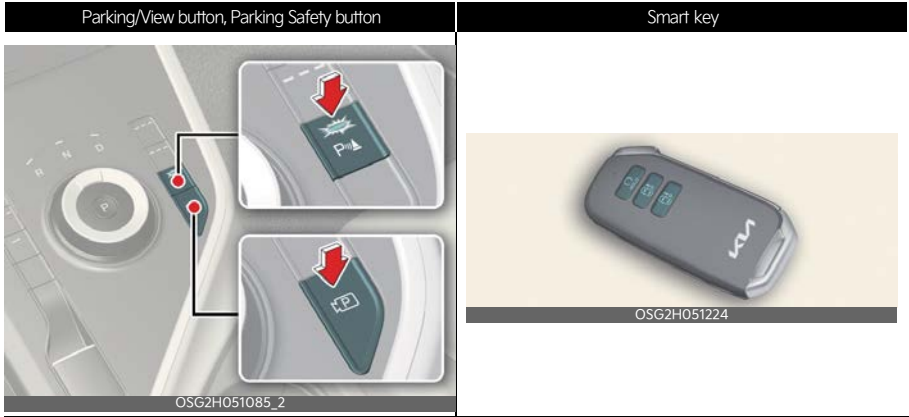

Location	Name	Symbol	Description
Inside vehicle	Parking/View button		<ul style="list-style-type: none"> Press and hold the Parking/View button to turn on Remote Smart Parking Assist. Also, Forward/Reverse Parking Distance warning will automatically turn on.
	Parking Safety button		<ul style="list-style-type: none"> Press the Parking Safety button while Remote Smart Parking Assist is operating to end function operation.
Smart key	Remote Start button		<ul style="list-style-type: none"> Press the Remote Start button after the door is locked with the vehicle off to start the vehicle remotely. Press the Remote Start button while Remote Operation function is operating to end function operation.
	Forward button		<ul style="list-style-type: none"> When using the Remote Operation function, the vehicle moves in the direction of the button while the button is pressed.
	Backward button		

Remote Operation

Operating order

Remote Operation operates in the following order:

1. Getting ready to remotely move forward and backward
2. Remotely moving forward and backward

1. Getting ready to remotely move forward and backward

There are two ways to operate Remote Operation function.

Method (1): Using the function with vehicle off



1. Within a certain range from the vehicle press the door lock (🔒) button on the smart key and lock all doors.
2. Press and hold the Remote Start button (🔌) within 4 seconds until the vehicle starts.

* For more details on remotely starting the vehicle, refer to "Remote start (5)" on page 5-7.

Method (2): Using the function with vehicle on



A: REMOTE Parking instructions

1. Leave vehicle (keep the smart key). Close all doors.
2. Press and hold the Forward or Backward button on the smart Key.

1. Park the vehicle in front of the space where you want to use Remote Operation function, and shift the gear to P (Park).
2. Press and hold the Parking/View (P) button to turn on Smart Parking Assist. A message will appear on the infotainment system screen.
3. Get out of the vehicle with the smart key and close all doors.

* NOTICE





'Agree' must be selected on the infotainment system screen and the infotainment system has to operate properly to use Remote Operation function.

2. Remote Operation



1. Press and hold one of the Forward (🔍) or Backward (🔍) button on the smart key.
 - Remote Smart Parking Assist will automatically control the steering

wheel, vehicle speed and gear shift. The vehicle will move in the direction of the button pressed.

- While Remote Operation function is operating, if you let the button, the vehicle will stop and function control will pause. The function will start operating again when the button is pressed and held again.
2. Hold down the Forward () or Backward () button until the vehicle reaches the target location.
 3. When Remote Operation is done, get in the vehicle with the smart key or press the Remote Start () button on the smart key from outside the vehicle.
 - The message will appear on the infotainment system screen. The vehicle will automatically shift to P (Park) and engage the parking brake.
 - When the Remote Start () button is pressed, the vehicle will turn off. If the driver is in the vehicle, the vehicle will retain ON position.

* NOTICE

- Remote Operation can control the vehicle remotely using the smart key outside the vehicle.
- Check that all smart keys are outside the vehicle when using Remote Operation function.
- Remote Operation function will operate only when the smart key is within 4 m (13 ft.) from the vehicle. If there is no vehicle movement even when the Forward or Backward button is pressed on the smart key, check the

distance to the vehicle and press the button again.

- The detecting range of the smart key may vary depending on the surroundings that are affected by radio waves such as transmission tower, broadcast station, etc.
- When remotely moving forward using method (1), it is recognized as an exit situation, and the vehicle moves 4 m (13 ft.) to check for pedestrians, animals or objects around the vehicle. After confirmation, the steering wheel is controlled according to the condition ahead.
- When remotely moving forward using method (2), it is recognized as a parking situation, and will immediately control the steering wheel according to the condition ahead to assist with entering the parking space and aligning the vehicle. However, performance may reduce depending on the pedestrians, animals, shape of objects, location, etc., around the vehicle.
- For moving remotely backward, both method (1) and (2) aligns the steering wheel first, and then will only move the vehicle straight.

⚠ WARNING

- When using Remote Operation function, make sure that all passengers have gotten out of the vehicle.
- If the vehicle's battery is discharged or Remote Smart Parking Assist malfunctions when parked in a narrow parking space, Remote Operation function will not operate. Always park your vehicle in a space wide enough for you to get in or out of your vehicle.

- Please note that depending on the parking space, you may not be able to exit from the space you have entered by using Remote Operation function.
- After parking, the surrounding may change due to the movement of surrounding vehicles. If this occurs, Remote Operation function may not operate.
- Before leaving the vehicle, close windows and sunroofs, and make sure the vehicle is off before locking the doors.



Remote Operation function operation status

Operation Status	Smart key LED	Hazard warning light
Under control	Green LED continuously blinks	-
Pause	Red LED continuously blinks	Blinks
Off	Red LED appears for 4 seconds and then turns off	Blinks 3 times and turns off
Complete	Green LED appears for 4 seconds and then turns off	Blinks 3 times and turns off

* NOTICE



- Operation status by the hazard warning light may not be applicable based on the regulation of your country.
- If the smart key is not within the operating range from the vehicle (approximately 4m (13 ft.)), the smart key LED will not appear or blink. Use the smart key within the operating range.

How to turn off Remote Operation function while operating

- Press the Parking/View () button or shift the gear except to P (Park) while the infotainment system screen guides the driver using method 2.
- Press the Parking Safety () button or select 'Cancel' on the infotainment system screen.
- Press the Remote Start () button on the smart key while the vehicle is being controlled by Remote Operation function. Remote Operation function will turn off. At this time, the vehicle will turn off.
- Get on the vehicle with the smart key. Remote Operation function will turn off. At this time, the vehicle will remain on.

Remote Smart Parking Assist will pause in the following conditions when:

When Remote operation function is paused, the vehicle will stop. If the condition that made the function to pause disappears, the function may operate again.

- There is a pedestrian, animal or object in the direction the vehicle is moving
- The door or tailgate is open
- The Forward () or Backward () button is not continuously pressed
- Simultaneously pressing multiple buttons on a smart key
- The smart key is not operated within 4 m (13 ft.) from the vehicle
- Button of another smart key is pressed in addition to the operating smart key (Excluding start button)

- Blind-Spot Collision-Avoidance Assist or Rear Cross-Traffic Collision-Avoidance Assist operates while the vehicle is being controlled in the reverse direction.
- The vehicle moves 7 m (22 ft.) while the smart key is pressed with Remote Operation function (maximum travel distance per button press)

Remote Smart Parking Assist will cancel in the following conditions when:

When Remote Operation function is canceled, the vehicle will automatically stop, shift the gear to P (Park) and engage EPB (Electronic Parking Brake).

- The steering wheel is steered
- The gear is shifted while the vehicle is moving
- Operating EPB while the vehicle is moving
- The hood is open
- The brake pedal or accelerator pedal is depressed when all the doors are closed
- The smart key is outside the vehicle when the brake pedal is depressed while the driver's door is open
- Rapid acceleration occurs
- Vehicle skid occurs
- The wheel is stuck by an obstacle and cannot move
- Approximately 3 minutes and 50 seconds have past after Remote Operation function has started to operate
- The slope of the road exceeds the operational range
- The function is paused for more than 1 minute

- The total travel distance of the vehicle has exceeded 14 m (45 ft.) after Remote Operation function operation
- The steering wheel, gearshift, braking, and drive controls are not working properly
- There is a problem with the smart key or the smart key battery is low
- ABS, TCS or ESC system operates due to slippery road conditions
- The alarm of the Theft Alarm System sounds

Remote Smart Parking Assist malfunction and limitations

Remote Smart Parking Assist malfunction

Remote Smart Parking Assist check



A: Check Parking Assist

1 Visit a dealer or nearby service center.

When Remote Smart Parking Assist is not working properly, the warning message will appear on the infotainment system screen. If the message appears, stop using Remote Smart Parking Assist, and have the vehicle inspected by an authorized Kia dealer.

Remote Smart Parking Assist canceled



A: Parking Assist Canceled. 1 Please refer to the owner's manual.

When Remote Parking Assist is operating, the function can be canceled, and the warning message may appear regardless of the parking order. Other messages may appear depending on the situations. Follow the instructions provided on the infotainment system screen while parking your vehicle with Remote Parking Assist. Always look around and pay attention when using Remote Smart Parking Assist.

Remote Smart Parking Assist standby



A: Parking Assist Conditions Not Met 1 Check for Ultrasonic Sensor blockage.

When the message appears, when Parking/View (P) button has been pressed and held, Remote Smart Parking Assist is in standby. After a while, press and hold the Parking/View (P) button again to see if Remote Smart Parking Assist works.

The message appears even when the smart key's battery is low. Check the smart key battery level.

Limitations of Remote Smart Parking Assist

In the following circumstances, Remote Smart Parking Assist performance to park or exit the vehicle may be limited, there may be a risk of collision, or Remote Smart Parking Assist may turn off. Park or exit the vehicle manually if necessary.

- An object is attached to the steering wheel
- The vehicle is installed with a snow chain, spare tire or different size wheel
- Tire pressure is lower or higher than the standard tire pressure
- Your vehicle is loaded with cargo longer or wider than your vehicle or a trailer is connected to your vehicle
- There is a problem with the wheel alignment
- Your vehicle is leaned severely to one side
- Your vehicle is equipped with a trailer hitch
- The license plate is installed differently from the original location
- There is a person, animal or object above or below the ultrasonic sensor when Remote Smart Parking Assist is activated
- There is an obstacle such as a person, animal or object (trash can, bicycle, motorcycle, shopping cart, narrow pillar, etc.) near the parking space
- There is a circular pillar or narrow pillar, or a pillar surrounded by objects such as fire extinguisher, etc., near the parking space

- The road surface is bumpy (curbstone, speed bump, etc.)
- The road is slippery
- The parking space is near a vehicle with higher ground clearance or big, such as a truck, etc.
- The parking space is Inclined
- The road surface of parking space with lines is wet due to snow, puddles, or there is a road marker inside the parking space
- There is heavy wind
- Operating Remote Smart Parking Assist on uneven roads, gravel roads, bushes, etc.
- The performance of the ultrasonic sensor is affected by extremely hot or cold weather
- The ultrasonic sensor is covered with snow or water
- An object that generates ultrasonic waves is nearby
- A wireless device with a transmission function operates near the ultrasonic sensors
- Your vehicle is affected by another vehicle's Parking Distance Warning
- The sensor is mounted or positioned incorrectly by an impact to the bumper
- The ultrasonic sensor cannot detect the following objects when:
 - Sharp or slim objects, such as ropes, chains or small poles
 - Objects smaller than 100 cm (40 in.) in length and narrower than 14 cm (6 in.) in diameter
 - Objects which tend to absorb sensor frequency, such as clothes, spongy material or snow

- A narrow object such as a corner of a square pillar
- Person, animal or object near the ultrasonic sensor

Remote Smart Parking Assist may not operate properly under the following circumstances:

- Parking on inclines



Park manually when parking on inclines.

- Parking in snow



Snow may interfere with sensor operation, or Remote Smart Parking Assist may cancel if the road is slippery while parking.

- Parking on uneven road



Remote Smart Parking Assist may cancel when the vehicle slips, or the vehicle cannot move due to road conditions such as pebbles or fragmented stones.

- Parking behind a truck



Do not use Remote Smart Parking Assist around vehicles with higher ground clearance, such as a bus, truck, etc. It may lead to an accident.

- Parking near a pillar



Remote Smart Parking Assist performance may reduce or collision with an obstacle may occur when there is a narrow object, circular pillar, square pillar, or a pillar surrounded by objects such as a fire extinguisher, etc., near the parking space. The driver should park the vehicle properly.

- Parking in a parking space with a vehicle on one side only



If Remote Smart Parking Assist is used, when parking in a parking space with a vehicle only on one side, your vehicle may cross the parking line to avoid the parked vehicle.

- Parking diagonal



Remote Smart Parking Assist does not provide diagonal parking. Even if your vehicle was able to enter the parking space, do not use Remote Smart Parking Assist because the function cannot operate properly.

⚠ WARNING

- The driver is responsible for safe parking and exit when using Remote Smart Parking Assist.
- When using Remote Smart Parking Assist, stay out of the way in the direction the vehicle moves for your safety.
- Always check surroundings when using Remote Smart Parking Assist. You may collide with pedestrians, animals, or objects if they are near the sensor or are in the sensor's blind spot area.
- A collision may occur if a pedestrian, animal, or object suddenly appears while Remote Smart Parking Assist is operating.
- Do not use Remote Smart Parking Assist when under the influence of alcohol.
- Do not let children or other people to use the smart key.
- If Remote Smart Parking Assist is used continuously for a long period, it may adversely affect Remote Smart Parking Assist performance.
- Remote Smart Parking Assist may not operate properly if the vehicle needs

wheel alignment adjustment such as when the vehicle tilts to one side. Have the vehicle inspected by an authorized Kia dealer.

- Noise may be heard when braking occurs by Remote Smart Parking Assist or when the brake pedal is depressed by the driver.
- Remote Smart Parking Assist may suddenly apply the brake to avoid collision.
- Use Remote Smart Parking Assist only in a parking space that is large enough for the vehicle to move safely.

* NOTICE

- If the 3rd stage warning (continuous beep) of the Forward/Reverse Parking Distance Warning sounds while Remote Smart Parking Assist is operating, it means the obstacle detected is close to your vehicle. At this time, Remote Smart Parking Assist will temporarily stop operating. Make sure there are no pedestrians, animals, or objects around your vehicle.
- Depending on brake operation, the stop lights may come on while the vehicle is moving.
- If the vehicle is remotely started that has been parked in cold weather for a long time, the operation of Remote Smart Parking function may be delayed or canceled depending on vehicle condition.

Declaration of conformity (if equipped)

The radio frequency components (Front Radar) complies:

For United States and United States territories



OCV051263N

The antenna(s) must be installed such that a minimum separation distance of at least 20 cm is maintained between the radiator (antenna) and all persons at all times. This device must not be co-located or operating in conjunction with any other antenna or transmitter.

ONQ5051134N

For Canada

This device complies with Innovation, Science and Economic Development Canada's licence-exempt RSS standard(s). Operation is subject to the following two conditions:

- (1) this device may not cause interference, and
- (2) this device must accept any interference, including interference that may cause undesired operation of the device.

Le présent appareil est conforme aux CNR d'Industrie Canada applicables aux appareils radio exempts de licence. L'exploitation est autorisée

aux deux conditions suivantes:

- (1) l'appareil ne doit pas produire de brouillage, et
- (2) l'utilisateur de l'appareil doit accepter tout brouillage radioélectrique subi, même si le brouillage est susceptible d'en compromettre le fonctionnement.

ONQ5051135N

The radio frequency components (Front/Rear Corner Radar) complies:

For United States and United States territories



OCV051263N

FCC ID : LTQH5TR

This device complies with Part 15 of the FCC Rules. Operation is subject to the following two conditions:

- (1) this device may not cause harmful interference, and
- (2) this device must accept any interference received, including interference that may cause undesired operation.

CAUTION TO USERS

Changes or modifications not expressly approved by the party responsible for compliance could void the user's authority to operate the equipment.

ONQ5051136N

Radio frequency radiation exposure information:

This equipment complies with FCC radiation exposure limits set forth for an uncontrolled environment. This equipment should be installed and operated with minimum distance of 8 in (20 cm) between the radiator (antenna) and your body. This transmitter must not be co-located or operating in conjunction with any other antenna or transmitter.

For Canada

Model: H5TR

IC: 3659A-H5TR

This device complies with Industry Canada licence-exempt RSS standard(s). Operation is subject to the following two conditions:

- (1) this device may not cause interference, and
- (2) this device must accept any interference, including interference that may cause undesired operation of the device.

Le présent appareil est conforme aux CNR d'Industrie Canada applicables aux appareils radio exempts de licence. L'exploitation est autorisée aux deux conditions suivantes:

- (1) l'appareil ne doit pas produire de brouillage, et
- (2) l'utilisateur de l'appareil doit accepter tout brouillage radioélectrique subi, même si le brouillage est susceptible d'en compromettre le fonctionnement.

ONQ5051137N

Special driving conditions

If driving conditions deteriorate due to poor weather or road conditions, you should pay even more attention than usual to your driving.

Hazardous driving conditions

When hazardous driving conditions are encountered such as water, snow, ice, mud, sand, or similar hazards, follow these suggestions:

- Drive cautiously and allow extra distance for braking.
- Avoid sudden braking or steering.
- When braking with non-ABS brakes pump the brake pedal with a light up-and-down motion until the vehicle is stopped.
- Do not pump the brake pedal on a vehicle equipped with ABS.
- If stalled in snow, mud, or sand, use the second gear. Accelerate slowly to avoid spinning the drive wheels.
- Use sand, rock salt, or other nonslip material under the drive wheels to provide traction when stalled in ice, snow, or mud.

Reducing the risk of a rollover

This multi-purpose passenger vehicle is defined as a Sports Utility Vehicle (SUV). Utility vehicles have a significantly higher rollover rate than other types of vehicles. SUV's have higher ground clearance and a narrower track to make them capable of performing in a wide variety of offroad applications.

Specific design characteristics give them a higher center of gravity than ordinary vehicles. An advantage of the higher ground clearance is a better view of the

road, which allows you to anticipate problems.

They are not designed for cornering at the same speeds as conventional passenger vehicles, any more than low-slung sports vehicles are designed to perform satisfactorily in off-road conditions. Due to this risk, driver and passengers are strongly recommended to buckle their seat belts.

In a rollover crash, an unbelted person is significantly more likely to die than a person wearing a seat belt. There are steps that a driver can make to reduce the risk of a rollover.

If at all possible, avoid sharp turns or abrupt maneuvers, do not load your roof rack with heavy cargo, and never modify your vehicle in any way.

WARNING

Rollover

As with other Sports Utility Vehicle (SUV), failure to operate this vehicle correctly may result in loss of control, an accident or vehicle rollover.

- SUVs have a significantly higher rollover rate than other types of vehicles.
- Specific design characteristics (higher ground clearance, narrower track, etc.) give this vehicle a higher center of gravity than ordinary vehicles.
- A SUV is not designed for cornering at the same speeds as conventional vehicles.
- Avoid sharp turns or abrupt maneuvers.
- In a rollover crash, an unbelted person is significantly more likely to die than a person wearing a seat belt. Make sure everyone in the vehicle is properly buckled up.

⚠ WARNING

Your vehicle is equipped with tires designed to provide safe riding and handling capability. Do not use a size and type of tire and wheel that is different from the one that is originally installed on your vehicle. It can affect the safety and performance of your vehicle, which could lead to steering failure or rollover and serious injury. When replacing the tires, be sure to equip all four tires with the tire and wheel of the same size, type, tread, brand and load-carrying capacity. If you nevertheless decide to equip your vehicle with any tire/wheel combination not recommended by Kia for off road driving, you should not use these tires for highway driving.

Rocking the vehicle

If it is necessary to rock the vehicle to free it from snow, sand, or mud, first turn the steering wheel right and left to clear the area around your front wheels. Then, shift back and forth between R (Reverse) and any forward gear.

Do not race the vehicle, and spin the wheels as little as possible. If you are still stuck after a few tries, have the vehicle pulled out by a tow vehicle to avoid vehicle overheating and possible damage to the reduction gear.

⚠ WARNING**Sudden Vehicle Movement**

Do not attempt to rock the vehicle if people or objects are nearby. The vehicle may suddenly move forward or backwards as it becomes unstuck.

⚠ WARNING**Vehicle Rocking**

Prolonged rocking may cause vehicle overheating, reduction gear damage or failure, and tire damage.

⚠ WARNING**Spinning Tires**

Do not spin the wheels, especially at speeds more than 35 mph (56 km/h). Spinning the wheels at high speeds when the vehicle is stationary could cause tires to overheat, which could result in tire damage that may injure bystanders.

The ESC system should be turned OFF prior to rocking the vehicle.

Smooth cornering

Avoid braking or gear changing in corners, especially when roads are wet. Ideally, corners should always be taken under gentle acceleration. If you follow these suggestions, tire wear will be held to a minimum.

Driving at night

Because night driving presents more hazards than driving in the daylight, here are some important tips to remember:

- Slow down and keep more distance between you and other vehicles, as it may be more difficult to see at night, especially in areas where there may not be any street lights.
- Adjust your mirrors to reduce the glare from other driver's headlights.
- Keep your headlights clean and properly aimed. (On vehicles not equipped

with the automatic headlight aiming feature.) Dirty or improperly aimed headlights will make it much more difficult to see at night.

- Avoid staring directly at the headlights of oncoming vehicles. You could be temporarily blinded, and it will take several seconds for your eyes to readjust to the darkness.

Driving in the rain

Rain and wet roads can make driving dangerous, especially if you're not prepared for the slick pavement.

Here are a few things to consider when driving in the rain:

- A heavy rainfall will make it harder to see and will increase the distance needed to stop your vehicle, so slow down.
- Keep your windshield wiping equipment in good shape. Replace your windshield wiper blades when they show signs of streaking or missing areas on the windshield.
- If your tires are not in good condition, making a quick stop on wet pavement can cause a skid and possibly lead to an accident. Be sure your tires are in good shape.
- Turn on your headlights to make it easier for others to see you.
- Driving too fast through large puddles can affect your brakes. If you must go through puddles, try to drive through them slowly.
- If you believe you may have gotten your brakes wet, apply them lightly while driving until normal braking operation returns.

Driving in flooded areas

Avoid driving through flooded areas unless you are sure the water is no higher than the bottom of the wheel hub. Drive through any water slowly. Allow adequate stopping distance because brake performance may be affected.

After driving through water, dry the brakes by gently applying them several times while the vehicle is moving slowly.

If the brake system is wet and has reduced braking effect or frequent sounds when braking, adjust the setting for the regenerative braking to '0' speed with paddle shifter and apply the brake pedal lightly several times. Maintain a safe distance to dry the brake system.

Setting the regenerative braking to '0' may reduce efficiency while braking several times for brake performance, but this is normal. The regenerative braking system will be normally operated afterwards.

Driving off-road

Drive carefully off-road because your vehicle may be damaged by rocks or roots of trees. Become familiar with the off-road conditions where you are going to drive before you begin driving.

Highway driving

Tires

Adjust the tire inflation pressures to specification. Low tire inflation pressures will result in overheating and possible failure of the tires.

Avoid using worn or damaged tires which may result in reduced traction or tire failure.

Never exceed the maximum tire inflation pressure shown on the tires.

WARNING

Under/Overinflated Tires

Always check the tires for proper inflation before driving. Underinflated or overinflated tires can cause poor handling, loss of vehicle control, and sudden tire failure leading to accidents, injuries, and even death. For proper tire pressures, refer to "Tires and wheels" on page 9-5.

WARNING

Tire Tread

Always check the tire tread before driving your vehicle. Worn-out tires can result in loss of vehicle control. Worn-out tires should be replaced as soon as possible. For further information and tread limits, refer to "Tires and wheels" on page 8-19.

Winter driving

Severe weather conditions in the winter result in greater wear and other problems.

To minimize the problems of winter driving, you should follow these suggestions:

Snowy or icy conditions

To drive your vehicle in deep snow, it may be necessary to use snow tires or to install tire chains on your tires.

If snow tires are needed, it is necessary to select tires equivalent in size and type of the original equipment tires. Failure to do so may adversely affect the safety and handling of your vehicle. Furthermore, speeding, rapid acceleration, sudden brake applications, and sharp turns are potentially very hazardous practices. During deceleration, use vehicle braking to the fullest extent. Sudden brake applications on snowy or icy roads may cause skids to occur. You need to keep sufficient distance between the vehicle in operation in front of your vehicle. Also, apply the brake gently. It should be noted that installing tire chains on the tire will provide a greater driving force, but will not prevent side skids.

Tire chains are not legal in all states. Check state laws before fitting tire chains.

CAUTION

- When the battery temperature is extremely low in winter, the battery temperature optimization is conducted for normal driving conditions. The optimization time may vary depending on the battery temperature and charging conditions.

- If the high voltage battery level and temperature is too low, the power may be limited. When the warning message is displayed, please charge the vehicle immediately.



A: Charge immediately. Power limited



A: Power limited. Low battery temperature

Snow tires

If you mount snow tires on your vehicle, make sure they are radial tires of the same size and load range as the original tires. Mount snow tires on all four wheels to balance your vehicle's handling in all weather conditions. Keep in mind that the traction provided by snow tires on dry roads may not be as high as your vehicle's original equipment tires. You should drive cautiously even when the roads are clear. Check with the tire dealer for maximum speed recommendations.

Do not install studded tires without first checking local, state and municipal regulations for possible restrictions against their use.

⚠ WARNING

Snow Tire Size

Snow tires should be equivalent in size and type to the vehicle's standard tires. Otherwise, the safety and handling of your vehicle may be adversely affected.

Tire chains

When using tire chains, install tire chains only on the front tires.

Normal type



Fabric type



Since the sidewalls of radial tires are thinner, they can be damaged by mounting some types of snow chains on them. Therefore, the use of snow tires is recommended instead of snow chains. Do not mount tire chains on vehicles equipped with aluminum wheels; snow chains may cause damage to the wheels. If snow chains must be used, use fabric type snow chains to prevent damage to your vehicle. Damage to your vehicle caused by improper snow chain use is not covered by your vehicle manufacturer's warranty.

Install tire chains only on the front tires.

Always check chain installation for proper mounting after driving approximately 0.3~0.6 miles (0.5~1 km) to ensure safe mounting. Retighten or remount the chains if they are loose.

Chain installation

When installing chains, follow the manufacturer's instructions and mount them as tightly as possible. Make sure the snow chains are SAE class "S" certified. Drive slowly (less than 20 mph (30 km/h)) with chains installed. If you hear the chains contacting the body or chassis, stop and tighten them. If they still make contact, slow down until it stops. Remove the chains as soon as you begin driving on cleared roads.

When mounting snow chains, park the vehicle on level ground away from traffic. Turn on the vehicle Hazard Warning flashers and place a triangular emergency warning device behind the vehicle if available. Always place the vehicle in P (Park), apply the parking brake and turn off the vehicle before installing snow chains.

- The use of chains may adversely affect vehicle handling.
- Do not exceed 20 mph (30 km/h) or the chain manufacturer's recommended speed limit, whichever is lower.
- Drive carefully and avoid bumps, holes, sharp turns, and other road hazards, which may cause the vehicle to bounce.
- Avoid sharp turns or locked-wheel braking.

CAUTION

Snow Chains

- Chains that are the wrong size or improperly installed can damage your vehicle's brake lines, suspension, body and wheels.
- Stop driving and retighten the chains any time you hear them hitting the vehicle.

Use high quality ethylene glycol coolant

Your vehicle is delivered with high quality ethylene glycol coolant in the cooling system. It is the only type of coolant that should be used because it helps prevent corrosion in the cooling system, lubricates the water pump and prevents freezing. Be sure to replace or replenish your coolant refer to "Scheduled maintenance service" on page 8-7. Before winter, have your coolant tested to assure that its freezing point is sufficient for the temperatures anticipated during the winter.

Check 12V battery and cables

Winter puts additional burdens on the battery system. Visually inspect the 12V battery and cables (refer to "Battery" on page 8-16). The level of charge in your battery can be checked by an authorized Kia dealer or a service station.

To keep locks from freezing

To keep the locks from freezing, squirt an approved de-icer fluid or glycerine into the key opening. If a lock is covered with ice, squirt it with an approved de-icing fluid to remove the ice. If the lock is frozen internally, you may be able to

thaw it out by using a heated key. Handle the heated key with care to avoid injury.

Use approved window washer anti-freeze in system

To keep the water in the window washer system from freezing, add an approved window washer anti-freeze solution in accordance with instructions on the container. Window washer anti-freeze is available from an authorized Kia dealer and most auto parts outlets. Do not use vehicle coolant or other types of anti-freeze as these may damage the paint finish.

Don't let your parking brake freeze

Under some conditions your parking brake can freeze in the engaged position. This is most likely to happen when there is an accumulation of snow or ice around or near the rear brakes or if the brakes are wet. If there is a risk the parking brake may freeze, apply it only temporarily while you put the gear shifter dial in P (Park) and block the rear wheels so the vehicle cannot roll. Then release the parking brake.

Don't let ice and snow accumulate underneath

Under some conditions, snow and ice can build up under the fenders and interfere with the steering. When driving in severe winter conditions where this may happen, you should periodically check underneath the vehicle to be sure the movement of the front wheels and the steering components are not obstructed.

Carry emergency equipment

Depending on the severity of the weather, you should carry appropriate emergency equipment. Some of the items you may want to carry include tow straps or chains, flashlight, emergency flares, sand, shovel, jumper cables, window scraper, gloves, ground cloth, coveralls, blanket, etc.

Vehicle load limit

The vehicle load limit is displayed on the tire and loading information label on the driver's door.

Tire and loading information label

The label located on the driver's side center pillar sill gives the original tire size, cold tire pressures recommended for your vehicle, the number of people that can be in your vehicle and vehicle capacity weight.

Example for spare tire



Vehicle capacity weight:

860 lbs. (390 kg)

Vehicle capacity weight is the maximum combined weight of occupants and cargo. If your vehicle is equipped with a trailer, the combined weight includes the tongue load.

Seating capacity:

Total: 5 persons (Front seat: 2 persons, Rear seat: 3 persons)

Seating capacity is the maximum number of occupants including a driver, your vehicle may carry.

However, the seating capacity may be reduced based upon the weight of all of the occupants, and the weight of the cargo being carried or towed.

Do not overload the vehicle as there is a limit to the total weight, or load limit including occupants and cargo, the vehicle can carry.

Towing capacity:

We do not recommend using this vehicle for trailer towing.

Cargo capacity:

The cargo capacity of your vehicle will increase or decrease depending on the weight and the number of occupants.

Steps for Determining Correct Load Limit -

- (1) Locate the statement "The combined weight of occupants and cargo should never exceed XXX kg or XXX lbs." on your vehicle's placard.
- (2) Determine the combined weight of the driver and passengers that will be riding in your vehicle.
- (3) Subtract the combined weight of the driver and passengers from XXX kg or XXX lbs.

(4) The resulting figure equals the available amount of cargo and luggage load capacity. For example, if the "XXX" amount equals 1400 lbs. and there will be five 150 lb passengers in your vehicle, the amount of available cargo and luggage load capacity is 650 lbs. (1400-750 (5 x 150) = 650 lbs.)

(5) Determine the combined weight of luggage and cargo being loaded on the vehicle. That weight may not safely exceed the available cargo and luggage load capacity calculated in Step 4.

(6) If your vehicle will be towing a trailer, load from your trailer will be transferred to your vehicle. Consult this manual to determine how this reduces the available cargo and luggage load capacity of your vehicle.

⚠ WARNING

Loose Cargo

Do not travel with unsecured objects in the passenger compartment of your vehicle (e.g. suit cases or unsecured child seats). These items may strike an occupant during a sudden stop or crash.

Example 1



Item	Description	Total
A	Vehicle Capacity Weight	860 lbs. (390 kg)
B	Subtract Occupant Weight 150 lbs. (68 kg) × 2	300 lbs. (136 kg)
C	Available Cargo and Luggage weight	560 lbs. (254 kg)

Example 2

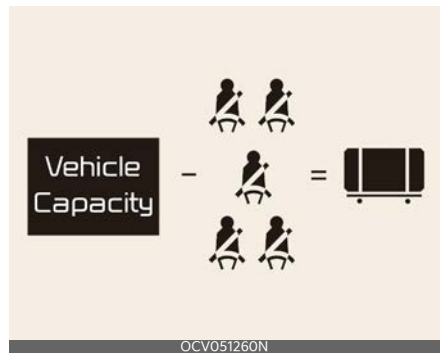

Item	Description	Total
A	Vehicle Capacity Weight	860 lbs. (390 kg)
B	Subtract Occupant Weight 150 lbs. (68 kg) × 5	750 lbs. (340 kg)
C	Available Cargo and Luggage weight	110 lbs. (50 kg)

Example 3

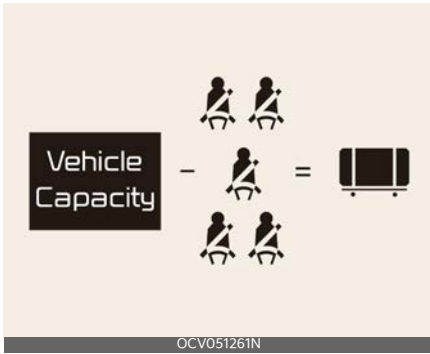

Item	Description	Total
A	Vehicle Capacity Weight	860 lbs. (390 kg)
B	Subtract Occupant Weight 161 lbs. (73 kg) × 5	805 lbs. (365 kg)
C	Available Cargo and Luggage weight	55 lbs. (25 kg)

Refer to your vehicle's tire and loading information label for specific information about your vehicle's capacity weight and seating positions. The combined weight of the driver, passengers and cargo should never exceed your vehicle's capacity weight.

Certification label

The certification label is located on the driver's door sill at the center pillar.



This label shows the maximum allowable weight of the fully loaded vehicle. This is called the GVWR (Gross Vehicle Weight Rating). The GVWR includes the weight of the vehicle, all occupants and cargo.

This label also tells you the maximum weight that can be supported by the front and rear axles, called Gross Axle Weight Rating (GAWR).

To find out the actual loads on your front and rear axles, you need to go to a weigh station and weigh your vehicle. Your dealer can help you with this. Be sure to spread out your load equally on both sides of the centerline.

WARNING
Over Loading

Never exceed the GVWR for your vehicle, the GAWR for either the front or rear axle and vehicle capacity weight. Exceeding these ratings can affect your vehicle's handling and braking ability.

The label will help you decide how much cargo and installed

equipment your vehicle can carry.

If you carry items inside your vehicle - like suitcases, tools, packages, or anything else - they are moving as fast as the vehicle. If you have to stop or turn quickly, or if there is a crash, the items will keep going and can cause an injury if they strike the driver or a passenger.

WARNING

Over Loading

Do not overload your vehicle. Overloading your vehicle can cause heat buildup in your vehicle's tires and possible tire failure, increased stopping distances and poor vehicle handling--all of which may result in a crash.

NOTICE

Overloading your vehicle may cause damage. Repairs would not be covered by your warranty. Do not overload your vehicle.

Vehicle weight

This chapter will guide you in the proper loading of your vehicle and/or trailer, to keep your loaded vehicle weight within its design rating capability, with or without a trailer.

Properly loading your vehicle will provide maximum return of the vehicle design performance. Before loading your vehicle, familiarize yourself with the following terms for determining your vehicle's weight ratings, with or without a trailer, from the vehicle's specifications and the compliance label:

Base curb weight This is the weight of the vehicle including battery and all standard equipment. It does not include passengers, cargo, or optional equipment.

Vehicle curb weight This is the weight of your new vehicle when you picked it up from your dealer plus any aftermarket equipment.

Cargo weight This figure includes all weight added to the Base Curb Weight, including cargo and optional equipment.

GAW (Gross axle weight) This is the total weight placed on each axle (front and rear) - including vehicle curb weight and all payload.

GAWR (Gross axle weight rating) This is the maximum allowable weight that can be carried by a single axle (front or rear). These numbers are shown on the compliance label. The total load on each axle must never exceed its GAWR.

GVW (Gross vehicle weight) This is the Base Curb Weight plus actual Cargo Weight plus passengers.

GVWR (Gross vehicle weight rating) This is the maximum allowable weight of the fully loaded vehicle (including all options, equipment, passengers and cargo). The GVWR is shown on the certification label located on the driver's door sill.

What to do in an emergency

Road warning	7-2
• Hazard warning flasher.....	7-2
In case of an emergency while driving	7-2
• If the vehicle stalls while driving.....	7-2
• If the vehicle stalls at a crossroad or crossing.....	7-2
• If you have a flat tire while driving.....	7-2
If the vehicle will not start	7-3
Emergency starting	7-4
• Jump starting (12V battery).....	7-4
• Push-starting.....	7-5
Tire Pressure Monitoring System (TPMS)	7-6
• Effective Use of the Tire Pressure Monitoring System (TPMS)...	7-6
• Low tire pressure telltale.....	7-7
• Tire replacement with TPMS.....	7-8
If you have a flat tire (with Tire Mobility Kit)	7-10
• Components of the Tire Mobility Kit.....	7-13
• Using the Tire Mobility Kit.....	7-14
• Distributing the sealant.....	7-15
• Checking the tire inflation pressure.....	7-16
• Technical data.....	7-17
Towing	7-17
• Using removable towing hook.....	7-18
If an accident occurs	7-20
Emergency commodity	7-21

What to do in an emergency

Road warning

When an emergency situation occurs while driving or when you park by the edge of the roadway, you must alert approaching or passing vehicles to be careful as they pass. For this, you should use the hazard warning flasher.

Hazard warning flasher

The hazard warning flasher serves as a warning to other drivers to exercise extreme caution when approaching, overtaking, or passing your vehicle.



It should be used whenever emergency repairs are being made or when the vehicle is stopped near the edge of a roadway.

Depress the flasher switch with the EV button in any position. The flasher switch is located in the center facia panel. All turn signal lights will flash simultaneously.

- The hazard warning flasher operates whether your vehicle is running or not.
- The turn signals do not work when the hazard flasher is on.
- Care must be taken when using the hazard warning flasher while the vehicle is being towed.

In case of an emergency while driving

The hazard warning flasher serves as a warning to other drivers to exercise extreme caution when approaching, overtaking, or passing your vehicle.

If the vehicle stalls while driving

1. Reduce your speed gradually, keeping a straight line.
2. Move cautiously off the road to a safe place.
3. Turn on your hazard warning flasher.
4. Try to start the vehicle again. If your vehicle will not start, contact an authorized Kia dealer or seek other qualified assistance.

If the vehicle stalls at a crossroad or crossing

1. If safe to do so, shift to the N (Neutral) position.
2. Push the vehicle to a safe location.

If you have a flat tire while driving

- Take your foot off the accelerator pedal and let the vehicle slow down while driving straight ahead.

WARNING

Do not apply the brakes immediately to slow down the vehicle.

- Use the paddle shifter (left side lever) to increase regenerative braking control.

WARNING

Do not attempt to pull off the road as this may cause loss of vehicle control resulting in an accident.

- When the vehicle has slowed to such a speed that it is safe to do so, brake carefully and pull off the road.
- Drive off the road as far as is possible and safe and park on firm, level ground.

⚠ WARNING

If you are on a divided highway, do not park in the median area between the two traffic lanes.

- When the vehicle is stopped, press the hazard warning flasher button, shift to P (Park), apply the parking brake, and place the EV button in the OFF position.
- Have all passengers get out of the vehicle. Be sure they all get out on the side of the vehicle that is away from traffic.
- Follow the instructions provided later in this chapter.

If the vehicle will not start

The vehicle may not start if the battery level is low.

Check the battery level by performing the following procedure.

1. Be sure the shifter dial is in P (Park).
The vehicle starts only when the shifter dial is in P (Park).
2. Check the 12-volt battery connections to be sure they are clean and tight.

⚠ WARNING

Do not push or pull the vehicle to start it. This could cause damage to your vehicle and/or injure you or those near the vehicle.

Emergency starting

Jump starting (12V battery)

Connect cables in numerical order and disconnect in reverse order.



Jump starting can be dangerous if done incorrectly. Therefore, to avoid harm to yourself or damage to your vehicle or battery, follow these jump starting procedures. If in doubt, we strongly recommend that you have a competent technician or towing service jump start your vehicle.

⚠ WARNING

Battery

Never attempt to check the electrolyte level of the battery as this may cause the battery to rupture or explode.

⚠ WARNING

Frozen Batteries

Do not attempt to jump start the vehicle if the discharged battery is frozen, as the battery may rupture or explode.

⚠ WARNING

Electrolyte

- Do not charge or discharge the battery arbitrarily. It may lead to fault, electric shock or burns.
- Do not damage the battery in such ways as to drop, deform, impact, out or spear with a sharp object. It may cause electrolyte leakage or fire.

- Breakdown of the battery may lead to electrolyte leakage or flammable gas generation. Contact an authorized Kia dealer immediately.
- If electrolyte leaks out, avoid contact with eyes, skin or clothes. In event of accident, flush with water and get medical help immediately.
- Do not place the battery near open flame or incinerate. It may lead to fire or explosion.
- Keep out of reach of children or animals.
- Keep the battery away from moisture or liquid. Do not touch or use if liquids have been spilled on.

⚠ WARNING

Battery Cables

Do not connect the jumper cable from the negative terminal of the booster battery to the negative terminal of the discharged battery, directly. This can cause the discharged battery to overheat, crack, and degrade.

Connect the jumper cable from the negative terminal of the booster battery to the chassis ground in the motor room.

⚠ WARNING

Sulfuric Acid Risk

Automobile batteries contain sulfuric acid. When jump starting your vehicle, be careful not to get sulfuric acid on yourself, your clothing, or on the vehicle. This acid is poisonous and highly corrosive.

⚠ WARNING**Battery**

Keep all flames or sparks away from the battery. The battery produces hydrogen gas which will explode if exposed to flame or sparks.

Jump-starting

1. Make sure the booster battery is 12-volt and that its negative terminal is grounded.
2. If the booster battery is in another vehicle, do not allow the vehicles to come in contact.
3. Turn off all unnecessary electrical loads.
4. Connect the jumper cables in the exact sequence shown in the illustration. First connect one end of a jumper cable to the positive terminal of the discharged battery (1), then connect the other end to the positive terminal of the booster battery (2). Proceed to connect one end of the other jumper cable to the negative terminal of the booster battery (3), then the other end to a solid, stationary, metallic point away from the battery (4).

Do not allow the jumper cables to contact anything except the correct battery terminals or the correct ground. Do not lean over the battery when making connections.

5. Start vehicle with the booster battery and let it run, then start the vehicle with the discharged battery.

If the cause of your battery discharging is not apparent, you should have your vehicle checked by an authorized Kia dealer.

*** NOTICE**

Make sure to connect one end of the jumper cable to the negative terminal of the booster battery, and the other end to a metallic point, far away from the battery.

Push-starting

Your vehicle equipped with reduction gear should not be push-started.

⚠ WARNING**Tow Starting Vehicle**

Never tow a vehicle to start it.

When the vehicle starts, the vehicle can suddenly surge forward and could cause a collision with the tow vehicle.

Tire Pressure Monitoring System (TPMS)

The tire pressure monitoring system detects the pressure of vehicle's tires and displays it on the LCD display.



- 1 Low tire pressure telltale / TPMS malfunction indicator
- 2 Low tire pressure position telltale (Shown on the LCD display)

Tire Pressure Indicator

- You can check the tire pressure in the assist mode on the cluster.
 - Refer to "LCD display" on page 5-75.
- Tire pressure is displayed 1~2 minutes later after driving.
- If tire pressure is not displayed when the vehicle is stopped, **Drive to display** message displays. After driving, check the tire pressure.
- You can change the tire pressure unit in the Setup menu on the infotainment system screen.
 - psi, kPa, bar (Refer to "User settings mode" on page 5-78).

* NOTICE

- The tire pressure may change due to factors such as parking condition,

driving style, and altitude above sea level.

- Low tire pressure warning may sound when a tire's pressure unit is equal or higher than nearby tires. This is a normal occurrence, which is due to the change in tire pressure along with tire temperature.
- The tire pressure shown on the dashboard may differ from the tire pressure measured by tire pressure gauge.

Effective Use of the Tire Pressure Monitoring System (TPMS)

Each tire, including the spare (if provided), should be checked monthly when cold and inflated to the inflation pressure recommended by the vehicle manufacturer on the vehicle placard or tire inflation pressure label.

(If your vehicle has tires of a different size than the size indicated on the vehicle placard or tire inflation pressure label, you should determine the proper tire inflation pressure for those tires.)

As an added safety feature, your vehicle has been equipped with a tire pressure monitoring system (TPMS) that illuminates a low tire pressure telltale when one or more of your tires is significantly under-inflated. Accordingly, when the low tire pressure telltale illuminates, you should stop and check your tires as soon as possible, and inflate them to the proper pressure. Driving on a significantly under-inflated tire causes the tire to overheat and can lead to tire failure. Under-inflation also reduces electric energy efficiency and tire tread life, and may affect the vehicle's handling and stopping ability.

Please note that the TPMS is not a substitute for proper tire maintenance, and it is the driver's responsibility to maintain correct tire pressure, even if under-inflation has not reached the level to trigger illumination of the TPMS low tire pressure telltale.

Your vehicle has also been equipped with a TPMS malfunction indicator to indicate when the system is not operating properly. The TPMS malfunction indicator is combined with the low tire pressure telltale. When the system detects a malfunction, the telltale will flash for approximately one minute and then remain continuously illuminated. This sequence will continue upon subsequent vehicle start-ups as long as the malfunction exists. When the malfunction indicator is illuminated, the system may not be able to detect or signal low tire pressure as intended. TPMS malfunctions may occur for a variety of reasons, including the installation of replacement or alternate tires or wheels on the vehicle that prevent the TPMS from functioning properly. Always check the TPMS malfunction telltale after replacing one or more tires or wheels on your vehicle to ensure that the replacement or alternate tires and wheels allow the TPMS to continue to function properly.

Always check the TPMS malfunction telltale after replacing one or more tires or wheels on your vehicle to ensure that the replacement or alternate tires and wheels allow the TPMS to continue to function properly.

*** NOTICE**

If any of the below happens, have the system checked by an authorized Kia dealer.

1. The Low Tire Pressure TPMS Malfunction Indicator does not appear for 3 seconds when the EV button is placed to the ON position or vehicle is ON (**READY** indicator ON).
2. The TPMS Malfunction Indicator remains illuminated after blinking for approximately 1 minute.
3. The Low Tire Pressure LCD display remains illuminated.

Low tire pressure telltale (⚠)

Low tire pressure position telltale

When the tire pressure monitoring system warning indicators appear, one or more of your tires is significantly under-inflated.



A: Low tire pressure

If the telltale appears, immediately reduce your speed, avoid hard cornering and anticipate increased stopping distances. You should stop and check your tires as soon as possible.

Inflate the tires to the proper pressure as indicated on the vehicle's placard or tire inflation pressure label located on the driver's side center pillar outer panel. If you cannot reach a service station or if the tire cannot hold the newly added air, replace the low pressure tire with the spare tire.

Then the TPMS malfunction indicator and the Low Tire Pressure telltale may turn on and appear after restarting and about 20 minutes of continuous driving

before you have the low pressure tire repaired and replaced on the vehicle. In winter or cold weather, the low tire pressure telltale may be illuminated if the tire pressure was adjusted to the recommended tire inflation pressure in warm weather. It does not mean your TPMS is malfunctioning because the decreased temperature leads to a proportional lowering of tire pressure.

When you drive your vehicle from a warm area to a cold area or from a cold area to a warm area, or the outside temperature is greatly higher or lower, you should check the tire inflation pressure and adjust the tires to the recommended tire inflation pressure.

When filling tires with more air, conditions to turn off the low tire pressure telltale may not be met. This is because a tire inflator has a margin of error in performance. The low tire pressure telltale will be turned off if the tire pressure is above the recommended tire inflation pressure.

⚠ WARNING

Low Pressure Damage

Do not drive on low pressure tires. Significantly low tire pressure can cause the tires to overheat and fail making the vehicle unstable resulting in increased braking distances and a loss of vehicle control.

Tire Pressure Monitoring System (TPMS) malfunction indicator (⚠)

The low tire pressure telltale will appear after it blinks for approximately one minute when there is a problem with the Tire Pressure Monitoring System.

If the system is able to correctly detect an underinflation warning at the same

time as system failure then it will illuminate both the TPMS malfunction and low tire pressure position telltales e.g. if Front Left sensor fails, the TPMS malfunction indicator appears, but if the Front Right, Rear Left, or Rear Right tire is under-inflated, the low tire pressure position telltales may appear together with the TPMS malfunction indicator.

Have the system checked by an authorized Kia dealer as soon as possible to determine the cause of the problem.

- The TPMS malfunction indicator may appear if the vehicle is moving around electric power supply cables or radios transmitters such as at police stations, government and public offices, broadcasting stations, military installations, airports, or transmitting towers, etc. This can interfere with normal operation of the Tire Pressure Monitoring System (TPMS).
- The TPMS malfunction indicator may appear if snow chains are used or some separate electronic devices such as notebook computer, mobile charger, remote starter or navigation etc., are used in the vehicle. This can interfere with normal operation of the Tire Pressure Monitoring System (TPMS).

Tire replacement with TPMS

If you have a flat tire, the Low Tire Pressure telltale will come on. Have the flat tire repaired by an authorized Kia dealer as soon as possible or replace the flat tire with the spare tire.

⚠ CAUTION

Repair Agents

Never use a puncture-repairing agent not approved by Kia to repair and/or inflate a low pressure tire. The sealant

not approved by Kia may damage the tire pressure sensor.

Each wheel is equipped with a tire pressure sensor mounted inside the tire behind the valve stem. You must use TPMS specific wheels. It is recommended that you always have your tires serviced by an authorized Kia dealer.

Even if you replace the low pressure tire with the spare tire, the Low Tire Pressure telltale will remain on until the low pressure tire is repaired and placed on the vehicle.

After you replace the low pressure tire with the spare tire, the TPMS malfunction indicator may appear after a few minutes because the TPMS sensor mounted on the spare wheel is not initiated.

Once the low pressure tire is inflated again to the recommended pressure and installed on the vehicle or the TPMS sensor mounted on the replaced spare wheel is initiated by an authorized Kia dealer, the TPMS malfunction indicator and the low tire pressure telltale will turn off within a few minutes of driving.

If the indicator has not disappeared after a few minutes of driving, please visit an authorized Kia dealer.

If an original mounted tire is replaced with the spare tire, the TPMS sensor on the replaced spare wheel should be initiated and the TPMS sensor on the original mounted wheel should be deactivated. If the TPMS sensor on the original mounted wheel located in the spare tire carrier still activates, the tire pressure monitoring system may not operate properly. Have the tire with TPMS serviced or replaced by an authorized Kia dealer.

You may not be able to identify a low tire by simply looking at it. Always use a good quality tire pressure gauge to measure the tire's inflation pressure. Please note that a tire that is hot (from being driven) will have a higher pressure measurement than a tire that is cold (from sitting stationary for at least 3 hours and driven less than 1 mile (1.6 km) during that 3 hour period).

Allow the tire to cool before measuring the inflation pressure. Always be sure the tire is cold before inflating to the recommended pressure.

A cold tire means the vehicle has been sitting for 3 hours and driven for less than 1 mile (1.6 km) in that 3 hour period.

Never use tire sealant if your vehicle is equipped with a Tire Pressure Monitoring System. The liquid sealant can damage the tire pressure sensors.

- The TPMS cannot alert you to severe and sudden tire damage caused by external factors such as nails or road debris.
- If you feel any vehicle instability, immediately take your foot off the accelerator, apply the brakes gradually and with light force, and slowly move to a safe position off the road.

* NOTICE

Protecting TPMS

Tampering with, modifying, or disabling the Tire Pressure Monitoring System (TPMS) components may interfere with the system's ability to warn the driver of low tire pressure conditions and/or TPMS malfunctions. Tampering with, modifying, or disabling the Tire Pressure Monitoring System (TPMS) components may void the warranty for that portion of the vehicle.

This device complies with Part 15 of the FCC rules.

Operation is subject to the following two conditions:

1. This device may not cause harmful interference, and
2. This device must accept any interference received, including interference that may cause undesired operation.
3. Changes or modifications not expressly approved by the party responsible for compliance could void the user's authority to operate the device.

If you have a flat tire (with Tire Mobility Kit)

The Tire Mobility Kit is a temporary fix to the tire and the tire should be inspected by an authorized Kia dealer as soon as possible.



- 1 Sealant bottle
- 2 Compressor

The tire mobility kit will be provided in the cargo area or in a dedicated bag in the tailgate in the side trim.

For safe operation, carefully read and follow the instructions in this manual before use.

⚠ CAUTION

When two or more tires are flat, do not use the tire mobility kit because the one supplied canister of sealant in the Tire Mobility Kit is only enough sealant for one flat tire.

⚠ WARNING

Tire Wall

Do not use the Tire Mobility Kit to repair large punctures or damage to the tire sidewalls. In these situations, the tire cannot be sealed completely and air will leak from the tire. This can result in tire failure.

⚠ WARNING

Have your tire repaired as soon as possible. The tire may lose air pressure at

any time after inflating with the Tire Mobility Kit.

⚠ WARNING

Speed with Temporary Fix

Do not exceed a speed of 50 mph (80 km/h) when driving with a tire sealed with the Tire Mobility Kit.

While driving, if you experience any unusual vibration, ride disturbance, or noise, reduce your speed and drive with caution until you can safely pull off to the side of the road.

Introduction

With the Tire Mobility Kit you stay mobile even after experiencing a tire puncture. The system of compressor and sealing compound effectively seals most punctures in a passenger car tire caused by nails or similar objects and reinflates the tire.

After you ensure that the tire is properly sealed you can drive cautiously on the tire at a max. speed of 50 mph (80 km/h) in order to reach a service station or tire dealer to have the tire replaced as soon as possible.

It is possible that some tires, especially with larger punctures or damage to the sidewall, cannot be sealed completely.

Air pressure loss in the tire may adversely affect tire performance.

For this reason, you should avoid abrupt steering or other driving maneuvers, especially if the vehicle is heavily loaded or if a trailer is in use.

The Tire Mobility Kit is not designed or intended as a permanent tire repair method and is to be used for one tire only.

This instruction shows you the step by step procedure to temporarily seal the puncture.

Read the section "Notes on the safe use of the Tire Mobility Kit".

Notes on the safe use of the Tire Mobility Kit

- Park your car at the side of the road so that you can work with the Tire Mobility Kit away from moving traffic.
- To be sure your vehicle will not move, even when you're on fairly level ground, always set your parking brake.
- Only use inflating Tire Mobility Kit for sealing/inflation passenger car tires. Only punctured areas located within the tread region of the tire can be sealed using the Tire Mobility Kit.
- Do not use on motorcycles, bicycles or any other type of tires.
- When the tire and wheel are damaged, do not use Tire Mobility Kit for your safety.
- Use of the Tire Mobility Kit may not be effective for tire damage larger than approximately 0.16 inches (4 mm). Please contact the nearest Kia dealership if the tire cannot be made road-worthy with the Tire Mobility Kit.
- Do not use the Tire Mobility Kit if a tire is severely damaged by driving with flat tires or with insufficient air pressure.
- Do not remove any foreign objects such as nails or screws that have penetrated the tire.
- Provided the car is outdoors, leave the vehicle ON (**READY** indicator ON). Otherwise operating the compressor may eventually drain the car battery.

- Never leave the Tire Mobility Kit unattended while it is being used.
- Do not leave the compressor running for more than 10 minutes at a time or it may overheat.
- Do not use the Tire Mobility Kit if the ambient temperature is below -22 °F (-30 °C).

⚠ CAUTION

When repairing a flat tire with the Tire Mobility Kit (TMK), quickly remove the sealant on the tire pressure sensor and wheel. When installing the repaired tire and wheel, tighten the wheel nut to a torque value of 79~94 lbf-ft (11~13 kgf·m).

⚠ WARNING

Sealant

- Keep out of the reach of children.
- Avoid contact with eyes.
- Do not swallow.

⚠ WARNING

Do not use the tire sealant after the sealant has expired (i.e. past the expiration date on the sealant container). This can increase the risk of tire failure.

⚠ WARNING

- If the sealant gets on your skin, wash it with a large amount of water. If skin irritation continues, visit a doctor for examination.
- If the sealant gets into your eyes, raise your eyelid and wash for at least 15 minutes. If eye irritation continues, visit a doctor for examination.
- If you swallowed the sealant, wash the mouth and drink a large amount of

water. However, do not give anything to an unconscious person and see the doctor immediately.

Exposure to the sealant for a long time may cause damage to the bodily tissues.

Components of the Tire Mobility Kit

Connectors, cable and connection hose are stored in the compressor housing.



* Connectors, cable and connection hose are stored in the compressor housing.

* Strictly follow the specified sequence, otherwise the sealant may escape under high pressure.

- 1 Speed restriction label
- 2 Sealant bottle
- 3 Sealant bottle filling hose
- 4 Power outlet connector
- 5 Sealant bottle holder
- 6 Compressor
- 7 ON/OFF switch
- 8 Tire inflation pressure gauge
- 9 Tire inflation pressure valve

⚠ WARNING

Expired sealant

Do not use the Tire sealant after the sealant has expired (i.e. past the expiration date on the sealant container). This can increase the risk of tire failure.

⚠ WARNING

Sealant

- Keep out of reach of children.
- Avoid contact with eyes.
- Do not swallow.

⚠ WARNING

Before using the Tire Mobility Kit, follow the instructions on the sealant bottle. Remove the label with the speed restriction from the sealant bottle and apply it to the steering wheel. Please note the expiration date on the sealant bottle.

*** NOTICE**

The sealant bottle and insert hose (3) cannot be reused.

⚠ CAUTION

Before using the tire repair kit, please read carefully the instruction attached on the sealant bottle. Detach the speed limit label on the sealant case and put it on a highly visible place. Always drive within the speed limit.

Using the Tire Mobility Kit

⚠ CAUTION

Detach the speed restriction label from the sealant bottle, and place it in a highly visible place inside the vehicle such as

on the steering wheel to remind the driver not to drive too fast.



1. Shake the sealant bottle.



2. Connect the filling hose onto the connector of the sealant bottle. (A) Remove the sealant bottle cap and sealant bottle holder cap and connect the bottle onto the sealant bottle holder. (B)

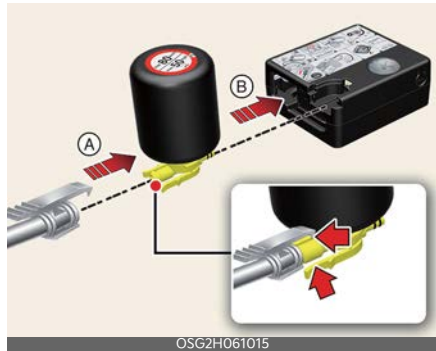

3. Make sure the compressor valve on the filling hose is locked.



4. Unscrew the valve cap from the valve of the defective tire and screw the filling hose of the sealant bottle onto the tire valve.



CAUTION

Securely install the sealant filling hose on the valve. If not, sealant may flow backward, possibly clogging the filling hose.

5. Ensure that the compressor is switched off, position 0.
6. Connect between compressor and the vehicle power outlet using the cable and connectors.



7. Make the EV button position on or ignition switch position on.
8. Switch on the compressor and let it run for approximately 5 ~ 7 minutes to fill the sealant up to proper pres-

sure. (refer to "Tires and wheels" on page 9-5). The inflation pressure of the tire after filling is unimportant and will be checked/corrected later. Be careful not to overinflate the tire and stay away from the tire when filling it. When the tire and wheel are damaged, do not use Tire Mobility Kit for your safety.

WARNING

If the tire pressure is below 26psi(180kPa), do not drive the vehicle. The tire may cause accident.

9. Switch off the compressor.
10. Detach the sealant filling hoses from the sealant bottle connector and from the tire valve. After using, leave the sealant bottle and the compressor attached together.

Return the TMK to its storage location in the vehicle.

WARNING

Carbon monoxide

Do not leave your vehicle running in a poorly ventilated area for extended periods of time. Carbon monoxide poisoning and suffocation can occur.

Distributing the sealant

After putting sealant into the tire, it is necessary to drive the vehicle so that the sealant becomes evenly distributed inside the tire.



- Immediately drive approximately 4~6 miles (7~10 km or, about 10 minutes) to evenly distribute the sealant in the tire.

Do not exceed a speed of 50 mph (80 km/h). If possible, do not fall below a speed of 12 mph (20 km/h).

While driving, if you experience any unusual vibration, ride disturbance or noise, reduce your speed and drive with caution until you can safely pull off of the side of the road.

▲ CAUTION

When you use the Tire Mobility Kit, the tire pressure sensors and wheel may be stained by sealant. Therefore, remove the tire pressure sensors and wheel stained by the sealant and have your vehicle inspected by an authorized Kia dealer.

Checking the tire inflation pressure

After driving briefly so as to distribute the sealant throughout the inside of the tire, you should check the tire inflation pressure.

1. After driving approximately 4~6 miles (7~10 km or about 10 minutes), stop at a safe location.
2. Connect the filling hose of the compressor (clip mounted side) directly and then connect the filling hose (opposite side) to the tire valve.



3. Connect between compressor and the vehicle power outlet using the cable and connectors.
4. Adjust the tire inflation pressure to the cold tire recommended pressure as indicated on the vehicle's placard or tire inflation pressure label located on the driver's side center pillar outer panel. (In this owner's manual, refer to "Tires and wheels" on page 9-5.)

- **To increase the inflation pressure**, switch on the compressor, position I. To check the current inflation pressure setting, briefly switch off the compressor.

*** NOTICE**

The pressure gauge may show higher than actual reading when the compressor is running. To get an accurate tire reading, the compressor needs to be turned off.

▲ WARNING

Do not let the compressor run for more than 10 minutes; otherwise, the device may overheat and be damaged.

- **To reduce the inflation pressure**, press the valve on the compressor.

▲ CAUTION

Tire Pressure Sensor

When you use the Tire Mobility Kit with a sealant that is not approved by Kia, the tire pressure sensors may be damaged by sealant. The sealant on the tire pressure sensor and wheel should be removed when you replace the tire with a new one and the tire pressure sensors should be inspected at an authorized dealer.

Technical data

- System voltage: DC 12 V
- Working voltage: DC 12 V
- Amperage rating: max. 15A ± 1A
- Suitable for use at temperatures: -22 to 158 °F (-30 to 70 °C)
- Max. working pressure: 87 psi (6 bar)
- Size
 - Compressor: 150 x 130 x 60 mm (5.9 x 5.1 x 2.4 in.)
 - Sealant bottle: 121 x 76 ø mm (4.5 x 3.4 ø in.)
 - Compressor weight: 1.5 lbs (680 g)
 - Sealant volume: 300 ml (18.3 cu. in.)

* Sealant and spare parts can be obtained and replaced at an authorized vehicle or tire dealer. Empty sealant bottles may be disposed of at home. Liquid residue from the sealant should be disposed of by your vehicle or tire dealer or in accordance with local waste disposal regulations.

Towing

If emergency towing is necessary, we recommend having it done by an authorized Kia dealer or a commercial tow-truck service.

Towing service

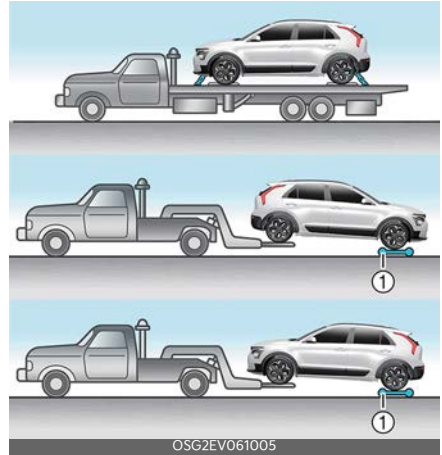

1 Dollies

Proper lifting and towing procedures are necessary to prevent damage to the vehicle. The use of wheel dollies (1) or flatbed is recommended.

⚠ WARNING

Side and Curtain Air Bag

If your vehicle is equipped with side and curtain air bag, place the EV button in OFF or ACC when the vehicle is being towed.

The side and curtain air bag may deploy when the EV button is ON, and the rollover sensor detects the situation as a rollover.

⚠ CAUTION

- Do not tow the vehicle forward with the rear wheels on the ground as this may cause damage to the vehicle.
- Do not tow with sling-type equipment. Use wheel lift or flatbed equipment.

⚠ WARNING

- If you tow the vehicle while the rear wheels are touching the ground, the vehicle motor may generate electricity and the motor components may be damaged or a fire may occur.
- When a vehicle fire occurs due to the battery, there is a risk of a second fire. Contact the fire department when towing the vehicle.

When the vehicle is being towed with tow truck or it needs to be moved, move the vehicle very short distance (within 32 ft. (10 m)) with the speed of 3 mph (5 km/h). In this case, the vehicle should be in N (Neutral) and the parking brake should be disengaged. If the parking brake and gear change operation is unavailable, move the vehicle with the rear wheels off the ground.

Using removable towing hook

Front



Rear



1. Open the liftgate, and remove the towing hook from the tool case.
2. Remove the hole cover pressing the lower part (front/rear) of the cover on the bumper.
3. Install the towing hook by turning it clockwise into the hole until it is fully secured.
4. Remove the towing hook and install the cover after use.

*** INFORMATION**

Towing in this manner may be done only on hard-surfaced roads for a short distance and at low speed. Also, the wheels, axles, power train, steering and brakes must all be in good condition.

- Do not use the tow hooks to pull a vehicle out of mud, sand or other conditions from which the vehicle cannot be driven out under its own power.
- Avoid towing a vehicle heavier than the vehicle doing the towing.
- The drivers of both vehicles should communicate with each other frequently.
- Before emergency towing, check if the hook is not broken or damaged.
- Fasten the towing cable or chain securely to the hook.
- Do not jerk the hook. Apply it steadily and with even force.
- To avoid damaging the hook, do not pull from the side or at a vertical angle. Always pull straight ahead.

- Press the EV button to the ACC position so the steering wheel is not locked.
- Shift the gear to N (Neutral).
- Release the parking brake.
- To avoid serious damage to the gear, limit the vehicle speed to 15 km/h (10 mph) and drive less than 1.5 km (1 mile) when towing.
- Press the brake pedal with more force than normal since you will have reduced brake performance.
- More steering effort will be required because the power steering system will be disabled.
- If you are driving down a long hill, the brakes may overheat and brake performance will be reduced. Stop often and let the brakes cool off.
- The driver must be in the vehicle for steering and braking operations when the vehicle is towed and passengers other than the driver must not be allowed to be on board.

⚠ CAUTION

- Attach a towing strap to the tow hook.
 - Using a portion of the vehicle other than the tow hooks for towing may damage the body of your vehicle.
 - Use only a cable or chain specifically intended for use in towing vehicles. Securely fasten the cable or chain to the towing hook provided.
 - Accelerate or decelerate the vehicle in a slow and gradual manner while maintaining tension on the tow rope or chain to start or drive the vehicle, otherwise tow hooks and the vehicle may be damaged.
-

⚠ WARNING

Use extreme caution when towing the vehicle.

- Avoid sudden starts or erratic driving maneuvers which would place excessive stress on the emergency towing hook and towing cable or chain. The hook and towing cable or chain may break and cause serious injury or damage.
- If the disabled vehicle is unable to be moved, do not forcibly continue the towing. We recommend that you contact an authorized Kia dealer or a commercial tow truck service for assistance.

If an accident occurs

If an accident occurs, stay calm and take the following precautions.

WARNING

High Voltage Components

- For your safety, do not touch high voltage cables, connectors and package modules. High voltage components are orange in color.
- Exposed cables or wires may be visible inside or outside of the vehicle. Never touch the wires or cables, because an electrical shock, an injury, or a death may occur.

NOTICE

Any gas or electrolyte leakage from your vehicle is not only poisonous but also flammable. Upon witnessing one of those, make sure your car is parked in a safe area away from any roads, open the windows, and maintain a safe distance away from the vehicle. Immediately contact an authorized Kia dealer and advise them that an electric vehicle is involved.

- If you need towing, refer to "Towing" on page 7-17.
- When the vehicle is severely damaged, remain a safe distance of 50 ft. (15 m) or more between your vehicle and other vehicles/flammables.
- If a fire occurs, immediately call emergency services (911) and advise the emergency responders that an electric vehicle is involved.

WARNING

Submersion in Water

Do not touch your vehicle if it has been submerged in water. The high-voltage battery may cause shock or may catch fire. Immediately contact the authorities and advise them of the condition of your vehicle and that an electric vehicle is involved.

Emergency commodity (if equipped)

Fire extinguisher

If there is small fire and you know how to use the fire extinguisher, follow these steps carefully.

1. Pull out the safety pin at the top of the extinguisher that keeps the handle from being accidentally pressed.
2. Aim the nozzle towards the base of the fire.
3. Stand approximately 2.5 m (8 ft) away from the fire and squeeze the handle to discharge the extinguisher. If you release the handle, the discharge will stop.
4. Sweep the nozzle back and forth at the base of the fire. After the fire appears to be out, watch carefully since it may re-ignite.

First-aid kit

Scissors, bandages, adhesive tape, etc. are provided in the kit.

Reflector triangle

Place the Reflector triangle on the road to warn oncoming vehicles.

Tire pressure gauge

1. Unscrew the inflation valve cap.
2. Press and hold the gauge against the tire valve.
3. Pressing firmly will activate the gauge and avoid too much leak.
4. Adjust the inflation of the tires to the specified pressure, as necessary.
5. Reinstall the inflation valve cap.

WARNING

- When an accident occur, park the vehicle to a safe place. To avoid the leak of electricity in high voltage battery, turn the vehicle off and pull the yellow label in the high voltage battery switch to shut down the high voltage battery. Also, disconnect the auxiliary battery(12V) cable to shut-down. Be sure to disconnect both (+)cable and (-) cable.
- Do not touch the exposed electric wires. Do not touch high voltage wires (orange), connectors and other electric components.
- When an accident occur, the lethal gas and fluid from damaged high voltage battery can be leaked. Be aware not to touch or exposed to the gas and fluid. When flammable or poison gas leak inside the vehicle, open windows and evacuate to a safe place. When leaked fluid comes in contact with your eyes, flush your eyes with clean water. When the fluid contacts with your skin, wash it with salt water. Get immediate medical attention afterward.
- When the vehicle is flooded, immediately turn the vehicle off and evacuate to a safe place. For your safety we recommend to call the fire station and or visit an authorized Kia dealer.
- When the fire spread to the high voltage battery, the additional fire may occur. In this situation, be sure to accompany a fire truck when the vehicle is being towed.

Motor room compartment	8-3
Maintenance services	8-4
Owner maintenance	8-5
Scheduled maintenance service	8-7
Explanation of scheduled maintenance items	8-10
Coolant	8-11
Brake fluid	8-12
• Checking the brake fluid level.....	8-12
Washer fluid	8-13
• Checking the washer fluid level.....	8-13
Climate control air filter	8-13
• Replacing the climate control air filter.....	8-13
Wiper blade	8-14
• Replacing the front wiper blade.....	8-14
• Replacing rear wiper blade.....	8-15
Battery	8-16
• For best battery service.....	8-16
• Battery capacity label.....	8-17
• Battery recharging.....	8-17
• Reset items.....	8-18
Tires and wheels	8-19
• Tire care.....	8-19
• Recommended cold tire inflation pressures.....	8-19
• Checking tire inflation pressure.....	8-20
• Tire rotation.....	8-21
• Wheel alignment and tire balance.....	8-21
• Tire replacement.....	8-22
• Wheel replacement.....	8-22
• Tire traction.....	8-22
• Tire maintenance.....	8-23

8 Maintenance

• Tire sidewall labeling.....	8-23
• Tire terminology and definitions.....	8-26
• All season tires.....	8-29
• Summer tires.....	8-29
• Snow tires.....	8-29
• Tire chains.....	8-30
• Radial-ply tires.....	8-30
• Low aspect ratio tire.....	8-31
Fuses.....	8-32
• Replacing inner panel fuse.....	8-33
• Replacing motor room fuse.....	8-33
• Fuse/relay panel description.....	8-35
Light bulbs.....	8-41
• Bulb replacement precaution.....	8-41
• Light bulb position (Front).....	8-42
• Light bulb position (Rear).....	8-42
• Light position (Side).....	8-43
• Replacing lights (LED type).....	8-43
• Replacing headlamp (Low beam/High beam) (Bulb type).....	8-43
• Headlamp bulb.....	8-44
• Replacing rear turn signal lamp, backup lamp (Bulb type).....	8-44
• Replacing high mounted stop lamp (LED type).....	8-44
• Replacing license plate lamp (Bulb type).....	8-44
• Replacing map lamp (Bulb type).....	8-45
• Replacing room lamp (Bulb type).....	8-45
• Replacing vanity mirror lamp (Bulb type).....	8-45
• Replacing glove box lamp (Bulb type).....	8-46
• Replacing luggage lamp (Bulb type).....	8-46
Appearance care.....	8-47
• Exterior care.....	8-47
• Interior care.....	8-51
California perchlorate notice.....	8-53

Maintenance

Motor room compartment

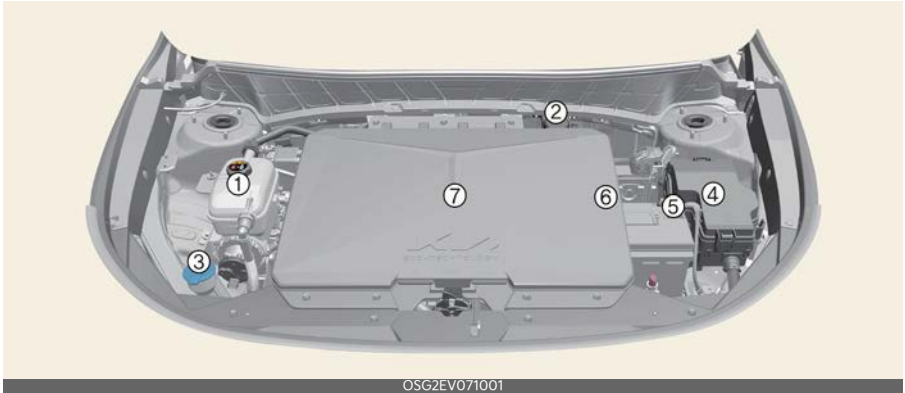

OSG2EV071001

* The actual features in your vehicle may not necessarily be available due to the selected options or regions.

- 1 Coolant reservoir
- 2 Brake fluid reservoir
- 3 Windshield washer fluid reservoir
- 4 Fuse box
- 5 Negative battery terminal (-)
- 6 Positive battery terminal (+)
- 7 Front trunk

Maintenance services

You should exercise the utmost care to prevent damage to your vehicle and injury to yourself whenever performing any maintenance or inspection procedures.

Should you have any doubts concerning the inspection or servicing of your vehicle, have an authorized Kia dealer perform this work.

An authorized Kia dealer has factory-trained technicians and genuine Kia parts to service your vehicle properly. For expert advice and quality service, see an authorized Kia dealer.

Inadequate, incomplete or insufficient servicing may result in operational problems with your vehicle that could lead to vehicle damage, an accident, or personal injury.

Owner's responsibility

* NOTICE

Maintenance Service and Record Retention are the owner's responsibility.

You should retain documents that show proper maintenance has been performed on your vehicle in accordance with the scheduled maintenance service charts shown on the following pages. You need this information to establish your compliance with the servicing and maintenance requirements of your vehicle warranties.

Detailed warranty information is provided in your Warranty & Consumer Information manual.

Repairs and adjustments required as a result of improper maintenance or a lack of required maintenance are not covered.

Have your vehicle maintained and repaired by an authorized Kia dealer. An authorized Kia dealer meets Kia's high service quality standards and receives technical support from Kia in order to provide you with a high level of service satisfaction.

* NOTICE

NHTSA Safety Corrosion Alert

The National Highway Traffic Safety Administration (NHTSA) has issued a general warning to all vehicle owners of all brands regarding the risks associated with vehicle underbody corrosion. From your initial purchase, take the following steps to prevent unsafe corrosion damage to your vehicle:

- Wash the undercarriage of your vehicle regularly during the winter and whenever your vehicle has been exposed to such salts or chemicals.
- Do a thorough washing of the undercarriage at the end of the winter.
- Use professional service technicians or governmental inspection stations to annually inspect for corrosion.
- Immediately seek an inspection of your vehicle if you become visually aware of corrosion flaking or scaling or if you become aware of a change in vehicle performance, such as soft or spongy brakes, fluids leaking, impairment of directional control, suspension noises or rattling metal straps.
- NHTSA further advises that after a vehicle is 7 years old, it is essential that you take these indicated maintenance steps to ensure that you protect yourself from unsafe corrosion conditions.

Owner maintenance precautions

Improper or incomplete service may result in problems. This section gives instructions only for the maintenance items that are easy to perform.

As explained earlier in this section, several procedures can be done only by an authorized Kia dealer with special tools.

* NOTICE

Improper owner maintenance during the warranty period may affect warranty coverage. For details, read the separate Warranty & Consumer Information manual provided with the vehicle. If you're unsure about any servicing or maintenance procedure, have it done by an authorized Kia dealer.

⚠ WARNING

Maintenance Work

Do not wear jewelry or loose clothing while working under the hood of your vehicle with **READY** mode. These items can become entangled in moving parts, if you must run the vehicle in the **READY** mode while working under the hood, make certain that you remove all jewelry (especially rings, bracelets, watches, and necklaces) and all neckties, scarves, and similar loose clothing before getting near cooling fans.

⚠ WARNING

Touching Metal Parts

Do not touch metal parts (including strut bars) while the vehicle is operating or hot. Doing so could result in serious bodily injury. Turn the vehicle off and wait until the metal parts cool down to perform maintenance work on the vehicle.

Owner maintenance

The following lists are vehicle checks and inspections that should be performed by the owner or an authorized Kia dealer at the frequencies indicated to help ensure safe, dependable operation of your vehicle.

Any adverse conditions should be brought to the attention of your dealer as soon as possible.

These Owner Maintenance Checks are generally not covered by warranties and you may be charged for labor, parts and lubricants used.

When you stop for charge

- Check the coolant level in coolant reservoir.

⚠ WARNING

When the coolant level is low, have the reservoir filled by an authorized Kia dealer by using only designated coolant water for electric vehicles. Using other types of water or antifreeze can cause serious damage to the vehicle.

- Check the windshield washer fluid level.

While operating your vehicle:

- Check for vibrations in the steering wheel. Notice any increased steering effort or looseness in the steering wheel, or change in its straight-ahead position.
- Notice if your vehicle constantly turns slightly or "pulls" to one side when traveling on smooth, level road.
- When stopping, listen and check for unusual sounds, pulling to one side,

increased brake pedal travel or "hard-to-push" brake pedal.

- If any slipping or changes in the operation of your gear shift occurs, take your vehicle to an authorized Kia dealer.
- Check the reduction gear P (Park) function.
- Check the parking brake.
- Check for fluid leaks under your vehicle (water dripping from the air conditioning system during or after use is normal).

At least monthly:

- Check the coolant level in the coolant reservoir.
- Check the operation of all exterior lights, including the stop/tail lamps, turn signals and hazard warning flashers.
- Check the inflation pressures of all tires including the spare for tires that are worn, show uneven wear, or are damaged.
- Check for loose wheel lug nuts.

At least once every 6 months:

- Check the cooling system, heater and air conditioning hoses for leaks or damage.
- Check the windshield washer spray and wiper operation. Clean the wiper blades with clean cloth dampened with washer fluid.
- Check the head lamp alignment.
- Check the lap/shoulder belts for wear and function.

At least once a year:

- Clean the body and door drain holes.

WARNING

When the coolant level is low, have the reservoir filled by an authorized Kia dealer by using only designated coolant water for electric vehicles. Using other types of water or antifreeze can cause serious damage to the vehicle.

- Lubricate the door hinges and check the hood hinges.
- Lubricate the door and hood locks and latches.
- Lubricate the door rubber weatherstrips.
- Check the air conditioning system.
- Inspect and lubricate shift gear linkage and controls.
- Clean the battery and terminals.
- Check the brake fluid level.

Scheduled maintenance service

Follow the Normal Maintenance Schedule if the vehicle is usually operated where none of the following conditions apply.

If any of the following conditions apply, follow the Maintenance Under Severe Usage Conditions.

- Repeated driving short distance of less than 5 miles (8 km) in normal temperature or less than 10 miles (16 km) in freezing temperature.
- Low speed driving for long distances.
- Driving on rough, dusty, muddy, unpaved, graveled or salt-spread roads.
- Driving in areas using salt or other corrosive materials or in very cold weather.
- Driving in heavy dust condition.
- Driving in heavy traffic area.
- Driving on uphill, downhill, or mountain road repeatedly.
- Using for towing or camping and driving with loading on the roof.
- Driving as a patrol car, taxi, other commercial use of vehicle towing.
- Frequently driving under high speed or rapid acceleration/deceleration.
- Frequently driving in stop-and-go condition.

If your vehicle is operated in any of the prior listed conditions, you should inspect, replace or refill more frequently, using the severe usage maintenance schedule instead of the normal usage maintenance schedule.

* NOTICE

After 10 years or 100,000 miles (150,000 km), we recommend to use severe maintenance schedule.

Normal maintenance schedule

I: Inspect and if necessary, adjust, correct, clean or replace.

R: Replace or change.

Number of months or driving distance, whichever comes first												
Months	12	24	36	48	60	72	84	96	108	120	132	144
Miles×1,000	8	16	24	32	40	48	56	64	72	80	88	96
Km×1,000	13	26	39	52	65	78	91	104	117	130	143	156
Tire rotation	Rotate every 8,000 miles (13,000 km)											
Reduction gear fluid	-	-	-	I	-	-	-	I	-	-	-	I
Climate control air filter	I	R	I	R	I	R	I	R	I	R	I	R
Brake fluid	Inspect every 8,000 miles (13,000 km) or 12 months Replace every 48,000 miles (78,000 km) or 48 months											
Coolant*	At first, replace at 120,000 miles (195,000 km) or 120 months After that, replace every 24,000 miles (39,000 km) or 24 months											
Air conditioner refrigerant												
Air conditioner compressor												
12V Battery condition												
Brake discs and pads												
Brake lines, hoses and connections	I	I	I	I	I	I	I	I	I	I	I	I
Suspension ball joints												
Steering gear rack, linkage and boots												
Cooling system												
Drive shaft and boots	-	I	-	I	-	I	-	I	-	I	-	I

* Coolant

When replacing or adding coolant, we recommend that you visit an authorized Kia dealer.

For your convenience, it can be replaced prior to its interval when you do maintenance of other items.

Maintenance under severe usage conditions

I: Inspect and if necessary, adjust, correct, clean or replace.

R: Replace or change.

Maintenance item	Maintenance operation	Maintenance intervals	Driving condition
Reduction gear fluid	R	Every 72,000 miles (117,000 km)	A, B, E, F, H, J
Drive shaft and boots	I	More frequently	B, C, D, E, F, G, H, I
Climate control air filter	R	More frequently	B, D, F
Brake discs, pads and calipers	I	More frequently	B, C, D, F, G, H, I, J
Steering gear rack, linkage and boots	I	More frequently	C, D, E, F, G
Suspension ball joints	I	More frequently	B, C, D, E, F

Severe driving conditions

- A. Repeated driving short distance of less than 5 miles (8 km) in normal temperature or less than 10 miles (16 km) in freezing temperature
- B. Driving on rough, dusty, muddy, unpaved, graveled or salt spread roads
- C. Driving in areas using salt or other corrosive materials or in very cold weather
- D. Driving in heavy dust condition
- E. Driving in heavy traffic area with the ambient temperature higher than 90 °F (32 °C) while consuming more than 50% of electric energy.
- F. Driving on uphill, downhill, or mountain roads repeatedly
- G. Towing a trailer, or using a camper or roof rack
- H. Driving as a patrol car, taxi, other commercial use or vehicle towing
- I. Frequently driving under high speed or rapid acceleration/deceleration
- J. Frequently driving in stop-and-go conditions

Explanation of scheduled maintenance items

The following parts require scheduled maintenance.

Reduction gear fluid

The reduction gear fluid should be inspected according to the intervals specified in the maintenance schedule.

Cooling system

Check the cooling system components, such as the cooling system, coolant reservoir, hoses and connections, coolant 3-way valve, chiller for leakage and damage. Replace any damaged parts.

Coolant

The coolant should be changed at the intervals specified in the maintenance schedule.

Brake hoses and lines

Visually check for proper installation, chafing, cracks, deterioration and any leakage. Replace any deteriorated or damaged parts immediately.

* NOTICE

NHTSA Safety Corrosion Alert

NHTSA has warned all vehicle owners of all brands that they must maintain their vehicles in a manner which will prevent brake hose and brake line failures due to corrosion when such vehicles are exposed to winter road salt and related chemicals. While serious corrosion conditions typically only manifest themselves as safety issues after 7 years of vehicle use, the corrosion process starts immediately, and thus, underbody

cleaning maintenance must commence from your vehicle's first exposure to road salts and chemicals. NHTSA urges vehicle owners to take the following steps to prevent corrosion:

1. Wash the undercarriage of your vehicle regularly throughout the winter and do a thorough washing in the spring to remove road salt and other de-icing chemicals.
 2. Monitor the brake system for signs of corrosion by having regular professional inspections and watching for signs of problems, including loss of brake fluid, unusual leaks and soft or spongy feel in the brake pedal.
 3. Replace the entire brake pipe assembly if you find severe corrosion that causes scaling or flaking of brake components.
-

Brake fluid

Check the brake fluid level in the brake fluid reservoir. The level should be between "MIN" and "MAX" marks on the side of the reservoir. Use only hydraulic brake fluid conforming to DOT 4 specification.

Brake discs, pads and calipers

Check the pads for excessive wear, discs for run out and wear, and calipers for fluid leakage.

Suspension mounting bolts

Check the suspension connections for looseness or damage. Retighten to the specified torque.

Steering gear box, linkage & boots/lower arm ball joint

With the vehicle stopped and off, check for excessive free-play in the steering wheel.

Check the linkage for bends or damage. Check the dust boots and ball joints for deterioration, cracks, or damage. Replace any damaged parts.

Drive shafts and boots

Check the drive shafts, boots and clamps for cracks, deterioration, or damage. Replace any damaged parts and, if necessary, repack the grease.

Air conditioning refrigerant

Check the air conditioning lines and connections for leakage and damage.

Coolant

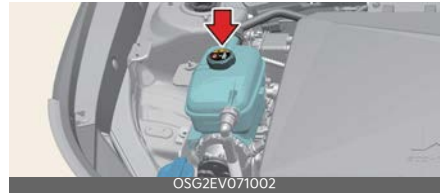

Check the condition and connections of all the cooling system hoses and heater hoses. Replace any swollen or deteriorated hoses.

The coolant level should be filled between the MAX or F and the MIN or L marks on the side of the coolant reservoir when the parts in the motor compartment is cool.

If the coolant is low, Visit an authorized Kia dealer.

⚠ WARNING



The electric motor for the cooling fan may continue to operate or start up when the vehicle is not running and can cause serious injury.

Keep hands, clothing and tools away from the rotating fan blades of the cooling fan.

The electric motor for the cooling fan is controlled by vehicle coolant temperature, refrigerant pressure and vehicle speed. As the vehicle coolant temperature decreases, the electric motor will automatically shut off. This is a normal condition.

Brake fluid

Checking the brake fluid level

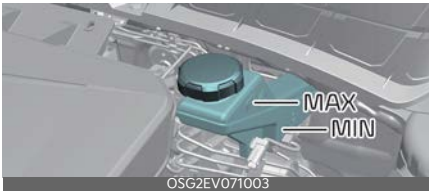

Operation

- Clean the area around the reservoir cap.
- Periodically check that the fluid level in the brake fluid reservoir is between MIN and MAX. The level will fall as the vehicle's mileage increases. This is a normal condition associated with the wear of the brake linings.

Use only the specified brake fluid. (Refer to "Recommended lubricants and capacities" on page 9-5.)

* INFORMATION

If the fluid level is excessively low, have the system checked by a professional workshop. Visit an authorized Kia dealer.

⚠ WARNING

- In the event the brake system requires frequent additions of fluid, have the system inspected by a professional workshop. Visit an authorized Kia dealer.
- When changing and adding brake fluid, handle it carefully. Do not let it come in contact with your eyes. If brake fluid should come in contact with your eyes, immediately flush them with a large quantity of fresh tap

water. Have your eyes examined by a doctor as soon as possible.

⚠ CAUTION

Do not allow brake fluid to contact the vehicle's body paint, as paint damage will result. Brake fluid, which has been exposed to open air for an extended time should never be used as its quality cannot be guaranteed. It should be properly disposed. Don't put in the wrong kind of fluid. A few drops of mineral-based oil in your brake system can damage brake system parts.

Washer fluid

Checking the washer fluid level



Operation

- Check the fluid level in the washer fluid reservoir and add fluid if necessary.
- Plain water may be used if washer fluid is not available.

However, use washer solvent with antifreeze characteristics in cold climates to prevent freezing.

The reservoir is translucent so that you can check the level with a quick visual inspection.

⚠ WARNING

- Do not use coolant or antifreeze in the washer fluid reservoir.
- Coolant can severely obscure visibility when sprayed on the windshield and may cause loss of vehicle control or damage to paint and body trim.
- Windshield Washer fluid agents contain some amounts of alcohol and can be flammable under certain circumstances. Do not allow sparks or flame to contact the washer fluid or the washer fluid reservoir. Damage to the vehicle or occupants could occur.
- Windshield washer fluid is poisonous to humans and animals. Do not drink and avoid contacting windshield washer fluid. Serious injury or death could occur.

Climate control air filter

Replacing the climate control air filter

Operation

1. Open the glove box and remove the stopper (1). With the glove box open, remove the glove box by pushing the both sides of it (2).

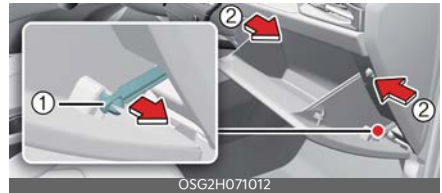

2. Remove the climate control air filter cover (2) by pulling out both sides (1) of the cover.

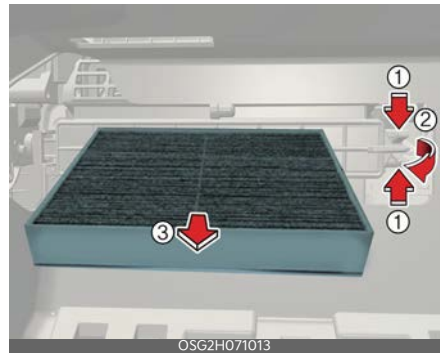

3. Replace the climate control air filter (3).



4. Reassemble in reverse order of disassembly.

* NOTICE

When replacing the climate control air filter install it properly. Otherwise, the system may produce noise and the effectiveness of the filter may be reduced.

Wiper blade

Replacing the front wiper blade



Operation

1. Turn off the vehicle.
2. Move the wiper switch to the single wiping (MIST) position within 20 seconds.
3. Hold the wiper switch for more than 2 seconds.
4. Raise the wiper arm.
5. Lift the wiper blade clip up (1). Pull down the blade assembly and remove it (2).

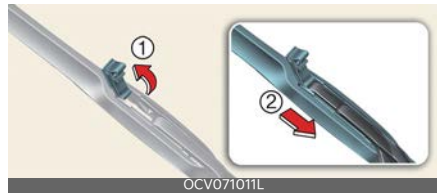

6. Install the new blade assembly.



7. Upon starting the vehicle, the wiper arms will return to their normal operating position.

Replacing rear wiper blade



Operation

1. Turn off the vehicle.
2. Move the wiper switch to the single wiping (MIST) position.
3. Hold the wiper switch for more than 2 seconds.
4. Raise the wiper arm and pull out the wiper blade assembly.



5. Lift up the wiper blade, and pull the blade to remove it.



6. Install the new blade assembly by inserting the center part into the slot in the wiper arm until it clicks into place.

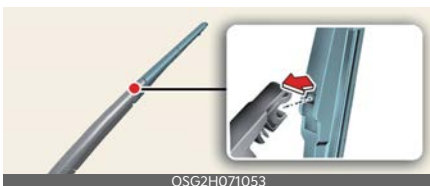

If the replacement is complete, put down the wiper arm to place it on the rear windshield, and turn the vehicle to ON position and operate the wipers to check the blade is installed correctly.

7. Make sure the blade assembly is installed firmly by trying to pull it slightly.

* INFORMATION

To prevent damage to the wiper arms or other components, have the wiper blade replaced by a professional workshop. Visit an authorized Kia dealer.

⚠ CAUTION

- Do not use gasoline, kerosene, paint thinner, or other solvents on or near them.
- Do not attempt to move the wipers manually.
- The use of a non-specified wiper blade could result in wiper malfunction and failure.
- Do not allow the wiper arm to fall against the windshield, since it may chip or crack the windshield.
- If the wiper arm receives too much force while pulling the blade, the center part may be damaged.
- The wiper could not operate for approximately 10 seconds when the wiper is operated without washer fluid or the blades are frozen. This is not a malfunction, it is a wiper protection system activated by motor overload circuit within the wiper motor.
- The front windshield should be cleaned with water hose and wiped with clean towel with wiper blades raised up. Also, the wiper blades

should be wiped clean when the grease or wax is applied to the blades.

*** NOTICE**

Commercial hot waxes applied by automatic car washes have been known to make the windshield difficult to clean. And it is the responsibility of customers to wash and manage the vehicle with adequate methods and materials.

Battery

The battery powers the various devices installed in the vehicle.

For best battery service

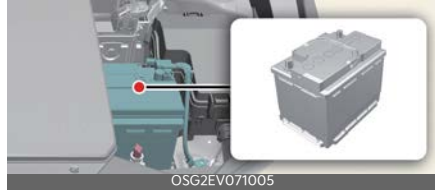

- Keep the battery securely mounted.
- Keep the top of the battery clean and dry.
- Keep the terminals and connections clean, tight, and coated with petroleum jelly or terminal grease.
- Immediately rinse any electrolyte spilled from the battery using a solution of water and baking soda.
- If the vehicle is not going to be used for an extended period, disconnect the battery cables.

⚠ WARNING

Risk of Explosion



Keep lit cigarettes and all other flames or sparks away from the battery.



The battery contains hydrogen -- a highly combustible gas which will explode if it comes in contact with a flame or

spark.



Keep batteries out of the reach of children because batteries contain highly corrosive SULFURIC ACID and electrolytes.

Do not allow battery acid to contact your skin, eyes, clothing or paint finish.



Wear eye protection when charging or working near a battery. Always provide ventilation when working in an enclosed space.



Always read the following instructions carefully when handling a battery.



If any electrolyte gets into your eyes, flush your eyes with clean water for at least 15 minutes and get immediate medical attention. If electrolyte gets on your skin, thoroughly wash the contacted area. If you feel pain or burning sensation, get medical attention immediately.



An inappropriately disposed battery can be harmful to the environment and human health. Dispose the battery according to your local law(s) or regulation.



The battery contains lead. Do not dispose of it after use. Please return the battery to an authorized Kia dealer to be recycled.

WARNING

Risk of Electrocutation

Never touch the electrical motor while the vehicle is running. This system works with high voltage, which can electrocute, injure, or kill you.

*** NOTICE**

If you connect unauthorized electronic devices to the battery, the battery may be discharged. Never use unauthorized devices.

WARNING

Recharging Battery

Never attempt to recharge the battery when the battery cables are connected.

Battery capacity label

Example



* The actual battery label in the vehicle may differ from the illustration.

- 1 The Kia model name of battery
- 2 The nominal capacity (in Ampere hours)
- 3 The nominal reserve capacity (in min.)
- 4 The nominal voltage
- 5 The cold-test current in amperes by SAE
- 6 The cold-test current in amperes by EN

Battery recharging

Your vehicle has a maintenance-free, calcium-based battery.

- If the battery becomes discharged in a short time (because, for example, the headlights or interior lights were left on while the vehicle was not in use), run the vehicle for at least approximately 60 minutes while driving when vehicle is stopped in ON position.

Also, connect the fully automatic regulated charger to the 12V battery located in the motor room compartment.

- If the battery gradually discharges because of high electric load while the vehicle is being used, recharge it at 20~30 A for 2 hours.

When recharging the battery, observe the following precautions:

- The battery must be removed from the vehicle and placed in an area with good ventilation.
 - Do not allow cigarettes, sparks, or flame near the battery.
 - Watch the battery during charging, and stop or reduce the charging rate if the battery cells begin gassing (boiling) violently or if the temperature of the electrolyte of any cell exceeds 49°C (120°F).
 - Wear eye protection when checking the battery during charging.
 - Disconnect the battery charger in the following order.
 1. Turn off the battery charger main switch.
 2. Unhook the negative clamp from the negative battery terminal.
 3. Unhook the positive clamp from the positive battery terminal.
 - Before performing maintenance or recharging the battery, turn off all accessories and stop the vehicle.
 - The negative battery cable must be removed first and installed last when the battery is disconnected.
- Climate control system (Refer to "Automatic climate control system" on page 5-109)
 - Sunroof (Refer to "Sunroof (if equipped)" on page 5-50)
 - Trip computer (Refer to "Trip computer mode" on page 5-76)
 - Driver position memory system (Refer to "Driver Position Memory System (if equipped)" on page 5-30)
 - Infotainment system (Refer to "Infotainment system" on page 5-136)

Reset items

The following items should be reset after the battery has been discharged or the battery has been disconnected.

- Auto up/down window (Refer to "Window opening and closing" on page 5-43)

Tires and wheels

Tire care

For proper maintenance, safety, and maximum electric energy economy, you must always maintain recommended tire inflation pressures and stay within the load limits and weight distribution recommended for your vehicle.

Recommended cold tire inflation pressures

All tire pressures should be checked when the tires are cold. "Cold Tires" means the vehicle has not been driven for at least three hours or driven less than one mile (1.6 km).

Recommended pressures must be maintained for the best ride, vehicle handling, and minimum tire wear.

For recommended inflation pressure, refer to "Tires and wheels" on page 9-5.

All specifications (sizes and pressures) can be found on a label attached to the driver's side center pillar.



⚠ WARNING

Tire Underinflation

Inflate your tires consistent with the instructions provided in this manual. Severe underinflation (10 psi (70 kPa) or more) can lead to severe heat build-up, causing blowouts, tread separation and other tire failures that can result in the loss of vehicle control. This risk is much higher on hot days and when driving for long periods at high speeds.

Failure to maintain specified pressure may result in excessive wear, poor handling, reduced fuel economy, deformation of tire and/or wheel, harsh ride conditions, possibility for additional damage from road hazards, or result in tire failure.

Tire pressure

Always observe the following:

- Check tire pressure when the tires are cold. (After vehicle has been parked for at least three hours or hasn't been driven more than one mile (1.6 km) since startup.)
- Check the pressure of your spare tire each time you check the pressure of other tires.
- Never overload your vehicle. Be careful not to overload a

vehicle luggage rack if your vehicle is equipped with one.

- Warm tires normally exceed recommended cold tire pressures by 4 to 6 psi (28 to 41 kPa). Do not release air from warm tires to adjust the pressure or the tires will be underinflated.

⚠ WARNING

Tire Inflation

Overinflation or underinflation can reduce tire life, adversely affect vehicle handling, and lead to sudden tire failure. This could result in loss of vehicle control and potential injury.

Checking tire inflation pressure

Check your tires once a month or more.

Use a good quality gauge to check tire pressure. You cannot tell if your tires are properly inflated simply by looking at them. Radial tires may look properly inflated even when they're underinflated.

Check the tire's inflation pressure when the tires are cold. "Cold" means your vehicle has been sitting for at least three hours or driven no more than 1 mile (1.6 km).

1. Remove the valve cap from the tire valve stem.
 2. Press the tire gauge firmly onto the valve to get a pressure measurement. If the cold tire inflation pressure matches the recommended pressure on the tire and loading information label, no further adjustment is necessary.
 3. If the pressure is low, add air until you reach the recommended amount.
 4. If you overfill the tire, release air by pushing on the metal stem in the center of the tire valve.
 5. Recheck the tire pressure with the tire gauge.
 6. Be sure to put the valve caps back on the valve stems. They help prevent leaks by keeping out dirt and moisture.
- Inspect your tires frequently for proper inflation as well as wear and damage. Always use a tire pressure gauge.
- Tires with too much or too little pressure wear unevenly causing poor handling, loss of vehicle control, and sudden tire failure leading to accidents, injuries, and even death. The recommended cold tire pressure for your vehicle can be found in this manual and on the tire label located on the driver's side center pillar.

Tire rotation

To equalize tread wear, it is recommended that the tires be rotated every 8,000 miles (13,000 km) or sooner if irregular wear develops.

During rotation, check the tires for correct balance.

When rotating tires, check for uneven wear and damage. Abnormal wear is usually caused by incorrect tire pressure, improper wheel alignment, out-of-balance wheels, severe braking or severe cornering. Look for bumps or bulges in the tread or side of tire. Replace the tire if you find either of these conditions. Replace the tire if fabric or cord is visible. After rotation, be sure to bring the front and rear tire pressures to specification and check lug nut tightness.

Refer to "Tires and wheels" on page 9-5.

Disc brake pads should be inspected for wear whenever tires are rotated.

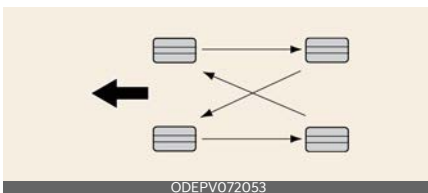

Rotate radial tires that have an asymmetric tread pattern only

from front to rear and not from right to left.

⚠ WARNING

Mixing Tires

Do not mix bias ply and radial ply tires under any circumstances. This may cause unusual handling characteristics.

Wheel alignment and tire balance

The wheels on your vehicle were aligned and balanced carefully at the factory to give you the longest tire life and best overall performance.

In most cases, you will not need to have your wheels aligned again. However, if you notice unusual tire wear or your vehicle pulling one way or the other, the alignment may need to be reset. If you notice your vehicle vibrating when driving on a smooth road, your wheels may need to be rebalanced.

⚠ CAUTION

Wheel Weight

Improper wheel weights can damage your vehicle's aluminum wheels. Use only approved wheel weights.

Tire replacement

If the tire is worn evenly, a tread wear indicator will appear as a solid band across the tread.



A: Tread wear indicator

This shows there is less than 1/16 inch (1.6 mm) of tread left on the tire. Replace the tire when this happens.

Do not wait for the band to appear across the entire tread before replacing the tire.

The ABS (Anti-lock Brake System) works by comparing the speed of the wheels. The tire size affects wheel speed. When replacing tires, all 4 tires must use the same size originally supplied with the vehicle. Using tires of a different size can cause the ABS (Anti-lock Brake System) and ESC (Electronic Stability Control) to work irregularly.

It is best to replace all four tires at the same time. If that is not possible, or necessary, then replace the two front or two rear tires as a pair. Replacing just one tire can seriously affect your vehicle's handling.

* NOTICE

We recommend that when replacing tires, use the same originally supplied with the vehicles. If not, that affects driving performance.

Wheel replacement

When replacing the metal wheels for any reason, make sure the new wheels are equivalent to the original factory units in diameter, rim width and offset.

A wheel that is not the correct size may adversely affect wheel and bearing life, braking and stopping abilities, handling characteristics, ground clearance, body-to-tire clearance, snow chain clearance, speedometer and odometer calibration, headlight aim and bumper height.

▲ CAUTION

Wheels

Wheels that do not meet Kia specifications may fit poorly and result in damage to the vehicle or unusual handling and poor vehicle control.

Tire traction

Tire traction can be reduced if you drive on worn tires, tires that are improperly inflated or on slippery road surfaces. Tires should be replaced when tread wear

indicators appear. Slow down whenever there is rain, snow or ice on the road to reduce the possibility of losing control of the vehicle.

Tire maintenance

In addition to proper inflation, correct wheel alignment helps to decrease tire wear. If you find a tire is worn unevenly, have a professional workshop check the wheel alignment. Visit an authorized Kia dealer.

When you have new tires installed, make sure they are balanced. This will increase vehicle ride comfort and tire life. Additionally, a tire should always be rebalanced if it is removed from the wheel.

Tire sidewall labeling



This information identifies and describes the fundamental characteristics of the tire and also provides the tire identification number (TIN) for safety standard certification. The TIN can be used to identify the tire in case of a recall.

1. Manufacturer or brand name

Manufacturer or brand name is shown.

2. Tire size designation

A tire's sidewall is marked with a tire size designation. You will need this information when selecting replacement tires for your vehicle.

Example tire size designation:

(These numbers are provided as an example only.)

P215/55R17 108T

P: Applicable vehicle type (tires marked with the prefix "P" are intended for use on passenger vehicles or light trucks; however, not all tires have this marking).

215 - Tire width in millimeters.

55 - Aspect ratio. The tire's section height as a percentage of its width.

R - Tire construction code (Radial).

17 - Rim diameter in inches.

108 - Load Index, a numerical code associated with the maximum load the tire can carry.

T - Speed Rating Symbol. See the speed rating chart in this section for additional information.

Wheel size designation

Wheels are also marked with important information that you need if you ever have to replace one. The following explains what the letters and numbers in the wheel size designation mean.

Example wheel size designation:

7.0JX17

7.0 - Rim width in inches.

J - Rim contour designation.

17 - Rim diameter in inches.

Tire speed ratings

The chart below lists many of the different speed ratings currently being used for passenger car tires. The speed rating is part of the tire size designation on the sidewall of the tire. This symbol corresponds to that tire's designed maximum safe operating speed.

Speed Rating Symbol	Maximum Speed
S	180 km/h (112 mph)
T	190 km/h (118 mph)
H	210 km/h (130 mph)
V	240 km/h (149 mph)
W	270 km/h (168 mph)
Y	300 km/h (186 mph)

3. Checking tire life (TIN: Tire Identification Number)

Any tires that are over 6 years old, based on the manufacturing

date, should be replaced by new ones. You can find the manufacturing date on the tire sidewall, displaying the DOT Code. The manufacturing date is designated by the last four digits (characters) of the DOT code.

DOT: XXXX XXXX 0000

The front part of the DOT means a plant code number, tire size and tread pattern and the last four numbers indicate week and year manufactured.

For example, DOT XXXX XXXX 1622 represents that the tire was produced in the 16th week of 2022.

⚠ WARNING

Tire Age

Replace tires within the recommended time frame. Failure to replace tires as recommended can result in sudden tire failure, which could lead to a loss of control and an accident.

4. Tire ply composition and material

The number of layers or plies of rubber-coated fabric in the tire. Tire manufacturers also must indicate the materials in the tire, which include steel, nylon, polyester, and others. The letter "R" means radial ply construction;

the letter "D" means diagonal or bias ply construction; and the letter "B" means belted-bias ply construction.

5. Maximum permissible inflation pressure

This number is the greatest amount of air pressure that should be put in the tire. Do not exceed the maximum permissible inflation pressure. Refer to "Tires and wheels" on page 9-5.

6. Maximum load rating

This number indicates the maximum load in kilograms and pounds that can be carried by the tire. When replacing the tires on the vehicle, always use a tire that has the same load rating as the factory installed tire.

7. Uniform tire quality grading

Quality grades can be found where applicable on the tire sidewall between tread shoulder and maximum section width.

For example:

- Treadwear 200
- Traction AA
- Temperature A

Tires degrade over time, even when they are not being used. Regardless of the remaining tread, we recommend that tires

be replaced after approximately six (6) years of normal service. Heat caused by hot climate or frequent high loading conditions can accelerate the aging process.

Tread wear

The tread wear grade is a comparative rating based on the wear rate of the tire when tested under controlled conditions on a specified government test course. For example, a tire graded 150 would wear one-and-a-half times (1½) as well on the government course as a tire graded 100.

The relative performance of tires depends upon the actual conditions of their use, however, and may depart significantly from the norm due to variations in driving habits, service practices and differences in road characteristics and climate.

The tires available as standard or optional equipment on your vehicle may vary with respect to grade.

Traction - AA, A, B & C

The traction grades, from highest to lowest, are AA, A, B and C. Those grades represent the tire's ability to stop on wet pavement as measured under controlled conditions on specified govern-

ment test surfaces of asphalt and concrete. A tire marked C may have poor traction performance. The traction grade assigned to this tire is based on straight-ahead braking traction tests, and does not include acceleration, cornering, hydroplaning, or peak traction characteristics.

Temperature -A, B & C

The temperature grades are A (the highest), B and C representing the tire's resistance to the generation of heat and its ability to dissipate heat when tested under controlled conditions on a specified indoor laboratory test wheel.

Sustained high temperature can cause the material of the tire to degenerate and reduce tire life, and excessive temperature can lead to sudden tire failure. The grade C corresponds to a level of performance which all passenger vehicle tires must meet under the Federal Motor Vehicle Safety Standard No. 109. Grades B and A represent higher levels of performance on the laboratory test wheel than the minimum required by law.

Tire terminology and definitions

Refer to the following for detailed definitions of the terms that are found in the tire description.

Air Pressure The amount of air inside the tire pressing outward on the tire. Air pressure is expressed in pounds per square inch (psi) or kilopascal (kPa).

Accessory Weight This means the combined weight of optional accessories. Some examples of optional accessories are automatic transaxle, power seats, and air conditioning.

Aspect Ratio The relationship of a tire's height to its width.

Belt A rubber coated layer of cords that is located between the plies and the tread. Cords may be made from steel or other reinforcing materials.

Bead The tire bead contains steel wires wrapped by steel cords that hold the tire onto the rim.

Bias Ply Tire A pneumatic tire in which the plies are laid at alternate angles less than 90 degrees to the centerline of the tread.

Cold Tire Pressure The amount of air pressure in a tire, measured in pounds per square inch (psi) or kilopascals (kPa) before a tire has built up heat from driving.

Curb Weight This means the weight of a motor vehicle with standard and optional equipment including the maximum capacity of fuel, oil and coolant, but without passengers and cargo.

DOT Markings A code molded into the sidewall of a tire signifying that the tire is in compliance with the U.S. Department of Transportation motor vehicle safety standards. The DOT code includes the Tire Identification Number (TIN), an alphanumeric designator which can also identify the tire manufacturer, production plant, brand and date of production.

GVWR Gross Vehicle Weight Rating

GAWR FRT Gross Axle Weight Rating for the Front Axle.

GAWR RR Gross Axle Weight Rating for the Rear axle.

Intended Outboard Sidewall The side of an asymmetrical tire that must always face outward when mounted on a vehicle.

Kilopascal (kPa) The metric unit for air pressure.

Light truck (LT) tire A tire designated by its manufacturer as primarily intended for use on lightweight trucks or multipurpose passenger vehicles.

Load ratings The maximum load that a tire is rated to carry for a given inflation pressure.

Load Index An assigned number ranging from 1 to 279 that corresponds to the load carrying capacity of a tire.

Maximum Inflation Pressure

The maximum air pressure to which a cold tire may be inflated. The maximum air pressure is molded onto the sidewall.

Maximum Load Rating The load rating for a tire at the maximum permissible inflation pressure for that tire.

Maximum Loaded Vehicle

Weight The sum of curb weight; accessory weight; vehicle capacity weight; and production options weight.

Normal Occupant Weight The number of occupants a vehicle is designed to seat multiplied by 150 pounds (68 kg).

Occupant Distribution Designated seating positions.

Outward Facing Sidewall The side of a asymmetrical tire that has a particular side that faces outward when mounted on a vehicle. The outward facing sidewall bears white lettering or bears manufacturer, brand, and/or model name molding that is higher or deeper than the same

moldings on the inner facing sidewall.

Passenger (P-Metric) Tire A tire used on passenger cars and some light duty trucks and multi-purpose vehicles.

Ply A layer of rubber-coated parallel cords.

Pneumatic tire A mechanical device made of rubber, chemicals, fabric and steel or other materials, that, when mounted on an automotive wheel, provides the traction and contains the gas or fluid that sustains the load.

Production options weight The combined weight of installed regular production options weighing over 5 lb. (2.3 kg) in excess of the standard items which they replace, not previously considered in curb weight or accessory weight, including heavy duty brakes, ride levelers, roof rack, heavy duty battery, and special trim.

Recommended Inflation Pressure Vehicle manufacturer's recommended tire inflation pressure and shown on the tire placard.

Radial Ply Tire A pneumatic tire in which the ply cords that extend to the beads are laid at 90 degrees to the centerline of the tread.

Rim A metal support for a tire and upon which the tire beads are seated.

Sidewall The portion of a tire between the tread and the bead.

Speed Rating An alphanumeric code assigned to a tire indicating the maximum speed at which a tire can operate.

Traction The friction between the tire and the road surface. The amount of grip provided.

Tread The portion of a tire that comes into contact with the road.

Treadwear Indicators Narrow bands, sometimes called "wear bars," that show across the tread of a tire when only 2/32 inch (1.6 mm) of tread remains.

UTQGS Uniform Tire Quality Grading Standards, a tire information system that provides consumers with ratings for a tire's traction, temperature and treadwear. Ratings are determined by tire manufacturers using government testing procedures. The ratings are molded into the sidewall of the tire.

Vehicle Capacity Weight The number of designated seating positions multiplied by 150 lbs. (68 kg) plus the rated cargo and luggage load.

Vehicle Maximum Load on the Tire Load on an individual tire

due to curb and accessory weight plus maximum occupant and cargo weight.

Vehicle Normal Load on the Tire Load on an individual tire that is determined by distributing to each axle its share of the curb weight, accessory weight, and normal occupant weight and dividing by 2.

Vehicle Placard A label permanently attached to a vehicle showing the original equipment tire size and recommended inflation pressure.

All season tires

Kia specifies all season tires on some models to provide good performance for use all year round, including snowy and icy road conditions.

All season tires are identified by ALL SEASON and/or M+S (Mud and Snow) on the tire sidewall. Snow tires have better snow traction than all season tires and may be more appropriate in some areas.

Summer tires

Kia specifies summer tires on some models to provide superior performance on dry roads. Summer tire performance is substantially reduced in snow and ice. Summer tires do not have the tire traction rating M+S (Mud and

Snow) on the tire side wall. If you plan to operate your vehicle in snowy or icy conditions, Kia recommends the use of snow tires or all season tires on all four wheels.

Snow tires

If you equip your vehicle with snow tires, they should be the same size and have the same load capacity as the original tires. Snow tires should be installed on all four wheels; otherwise, poor handling may result.

Snow tires should carry 4 psi (28 kPa) more air pressure than the pressure recommended for the standard tires on the tire label on the driver's side of the center pillar, or up to the maximum pressure shown on the tire sidewall, whichever is less.

Do not drive faster than 75 mph (120 km/h) when your vehicle is equipped with snow tires.

WARNING

Do not use summer tires at temperatures below 45 °F (7 °C) or when driving on snow or ice. At temperatures below 45 °F (7 °C), summer tires can lose elasticity, and therefore traction and braking power as well. Change the tires on your vehicle to winter or all-weather tires of the same size as the standard tires of the vehi-

cle. Both types of tires are identified by the M+S (Mud and Snow) marking. Using summer tires at very cold temperatures could cause cracks to form, thereby damaging the tires permanently.

Tire chains

Tire chains, if necessary, should be installed on the rear wheels. Be sure that the chains are installed in accordance with the manufacturer's instructions.

To minimize tire and chain wear, do not continue to use tire chains when they are no longer needed.

- When driving on roads covered with snow or ice, drive at less than 20 mph (30 km/h).
- Use the SAE "S" class or fabric chains.
- If you hear noise caused by chains contacting the body, retighten the chain to avoid contact with the vehicle body.
- To prevent body damage, retighten the chains after driving 0.3~0.6 miles (0.5~1.0 km).
- Do not use tire chains on vehicles equipped with aluminum wheels. In unavoidable circumstance, use fabric type snow chains.

Radial-ply tires

Radial-ply tires provide improved tread life, road hazard resistance and smoother high speed ride.

The radial-ply tires used on this vehicle are of belted construction, and are selected to complement the ride and handling characteristics of your vehicle. Radial-ply tires have the same load carrying capacity, as bias-ply or bias belted tires of the same size, and use the same recommended inflation pressure.

Mixing of radial-ply tires with bias-ply or bias belted tires is not recommended. Any combinations of radial-ply and bias-ply or bias belted tires when used on the same vehicle will seriously deteriorate vehicle handling. The best rule to follow is: Identical radial-ply tires should always be used as a set of four.

Longer wearing tires can be more susceptible to irregular tread wear. It is very important to follow the tire rotation interval shown in this section to achieve the tread life potential of these tires. Cuts and punctures in radial-ply tires are repairable only in the tread area, because of sidewall flexing. Consult your tire dealer for radial-ply tire repairs.

Low aspect ratio tire (if equipped)

Low aspect ratio tires, whose aspect ratio is lower than 50, are provided for sporty looks.

Because the low aspect ratio tires are optimized for handling and braking, it may be more uncomfortable to ride in and there is more noise compare with normal tires.

CAUTION

Because the sidewall of the low aspect ratio tire is shorter than the normal, the wheel and tire of the low aspect ratio tire is easier to be damaged. So, follow the instructions below.

- When driving on a rough road or off road, drive cautiously because tires and wheels may be damaged. And after driving, inspect tires and wheels.
- When passing over a pothole, speed bump, manhole, or curb stone, drive slowly so that the tires and wheels are not damaged.
- If the tire is impacted, we recommend that you inspect the tire condition or contact an authorized Kia dealer.
- To prevent damage to the tire, inspect the tire condition and

pressure every 1,900 miles (3,000 km).

- It is not easy to recognize the tire damage with your own eyes. But if there is the slightest hint of tire damage, even though you cannot see the tire damage with your own eyes, have the tire checked or replaced because the tire damage may cause air leakage from the tire.
- If the tire is damaged by driving on a rough road, off road, pothole, manhole, or curb stone, it will not be covered by the warranty.
- You can find out the tire information on the tire sidewall.

Fuses

Blade type



Cartridge type



Multi fuse



BFT

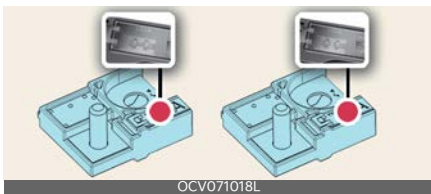

* Left: Normal, Right: Blown
 * The actual fuse/relay panel label may differ.

Before replacing a blown fuse, disconnect the negative battery cable. If the electrical system does not work, first check the driver's side fuse panel. Always replace a blown fuse with one of the same rating.

If the replacement fuse blows, this indicates an electrical problem. Avoid using the system involved and immediately consult a professional workshop. Consult an authorized Kia dealer.

⚠ WARNING

- Never replace a fuse with anything but another fuse of the same rating.
- A higher capacity fuse could cause damage and possibly a fire.
- Never install a wire or aluminum foil instead of the proper fuse even as a temporary repair. It may cause extensive wiring damage and a possible fire.
- Do not arbitrarily modify or add-on electric wiring of the vehicle.

⚠ CAUTION

- When replacing a blown fuse or relay with a new one, make sure the new fuse or relay fits tightly into the clips. The incomplete fastening fuse or relay may cause the vehicle wiring and electric systems damage and a possible fire.
- Do not remove fuses, relays and terminals fastened with bolts or nuts. The fuses, relays and terminals may be fastened incompletely, and it may cause a possible fire. If fuses, relays and terminals fastened with bolts or nuts are blown, consult a professional workshop. Consult an authorized Kia dealer.
- Do not input any other objects except fuses or relays into fuse/relay terminals such as a driver or wiring. It may cause contact failure and system malfunction.
- Do not plug in screwdrivers or after-market wiring into the terminal origi-

nally designed for fuse and relays only. The electrical system and wiring of the vehicle interior may be damaged or burned due to contact failure.

- If you directly connect the wire on the taillight or replace the bulb which is over the regulated capacity to install trailers etc., the inner junction block can get burned.
- Do not use a screwdriver or any other metal object to remove fuses because it may cause a short circuit and damage the system.

* NOTICE

- When replacing fuse, press the EV button to the OFF position and turn off switches of all electrical devices then remove battery (-) terminal.
- The actual fuse/relay panel label may differ from equipped items.

Replacing inner panel fuse

Operation

1. Press the EV button to the OFF position and turn all other switches off.
2. Open the fuse panel cover.



3. Pull the suspected fuse straight out. Use the removal tool (1) provided in the main fuse box in the motor compartment.



4. Check the removed fuse; replace it if it is blown. Spare fuses are provided in the instrument fuse panel (or in the motor compartment fuse panel).
5. Push in a new fuse of the same rating, and make sure it fits tightly in the clips.

* INFORMATION

If the headlights or taillights, stoplights, day time running lights (DRL) do not work and the fuses are OK, consult a professional workshop. Consult an authorized Kia dealer.

Replacing motor room fuse

Replacing blade/cartridge type fuses



Operation

1. Turn the vehicle and all other switches off.
2. Remove the fuse panel cover by pressing the tab and pulling the cover up.

When the blade type fuse is disconnected, remove it by using the clip (1) designed for changing fuses located

in the motor room fuse. Upon removal, securely insert reserve fuse of equal quantity.



3. Check the removed fuse; replace it if it is blown. To remove or insert the fuse, use the fuse puller in the motor compartment fuse panel.
4. Push in a new fuse of the same rating, and make sure it fits tightly in the clips. If it fits loosely, consult a professional workshop. Consult an authorized Kia dealer.

Replacing main/multi fuses



Operation

1. Turn off the vehicle.
2. Remove the fuse panel cover by pressing the tab and pulling the cover up.
3. Disconnect the negative battery cable.
4. Remove the nuts shown in the picture above.
5. Replace the fuse with a new one of the same rating.
6. Reinstall in the reverse order of removal.

7. If it fits loosely, consult a professional workshop. Consult an authorized Kia dealer.

Replacing relay



1. Turn the vehicle and all other switches off.
2. Remove the fuse panel cover by pressing the tab and pulling the cover up.
3. Replace the relay with a new one of the same rating.
4. Reinstall in the reverse order of removal.
5. If it fits loosely, consult a professional workshop. Consult an authorized Kia dealer.

⚠ CAUTION

- After checking the fuse panel in the motor compartment, securely install the fuse panel cover through the audible clicking sound. If not, electrical failures may occur from water contact.
- Visually inspect the battery cap for secure closing. If the battery cap is not securely latched, the electrical system may be damaged to due influx of moisture into the system.

*** NOTICE**

- The electronic system may not function correctly even when the motor room and internal fuse box's individual fuses are not disconnected. In

such case the cause of the problem may be disconnection of the main fuse (BFT type), which is located inside the positive battery terminal (+) cap. Since the main fuse is designed more intricately than other parts, visit a professional workshop. Visit an authorized Kia dealer.

- If the multi fuse is blown, consult a professional workshop. Consult an authorized Kia dealer.

Fuse/relay panel description

Inside the fuse/relay panel covers, you can find the fuse/relay label describing fuse/relay name and capacity.

* NOTICE

Not all fuse panel descriptions in this manual may be applicable to your vehicle. It is accurate at the time of printing. When you inspect the fuse panel in your vehicle, refer to the fuse panel label.

Driver's side fuse panel

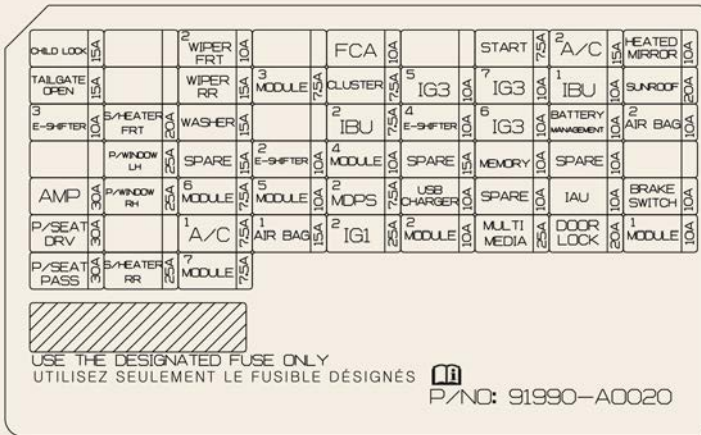

OSG2EV072010N

ICU Junction Block

Fuse Name	Fuse Rating	Circuit Protected
CHILD LOCK	15A	Electronic child safety lock system
WIPER FRT 2	10A	Front Wiper Motor
A/C 2	15A	Air Conditioner Control Module
FCA	10A	Front Radar
START	7.5A	VCU, IBU
HEATED MIRROR	10A	Driver/Passenger Power Outside Mirror
TAILGATE OPEN	15A	Tailgate open Relay
WIPER RR	15A	Rear Wiper Relay, Rear Wiper Motor

Fuse Name	Fuse Rating	Circuit Protected
MODULE 3	7.5A	Stop Lamp Switch, P/WDW Main SW, Digital Key 2 Touch Unit
CLUSTER	7.5A	Instrument Cluster, Head Up Display
IG3 5	10A	V2L(Vehicle To Load)
IG3 7	10A	Audio/ Navigation Head Unit, Charging Ind, Instrument Cluster, Air Conditioner Control Module, PTC Heater Unit
IBU 1	10A	IBU (Integrated Body Control Unit)
SUNROOF	20A	Sunroof Controller (Blind Motor)
E-SHIFTER 3	10A	SCU (Shift by wire Control Unit), Console Switch
S/HEATER FRT	20A	Front Air Ventilation Seat Control Module, Front Seat Warmer Control Module
WASHER	15A	Multifunction Switch
IBU 2	7.5A	IBU (Integrated Body Control Unit)
E-SHIFTER 4	10A	SCU (Shift by wire Control Unit)
IG3 6	10A	Battery Management System Unit
BATTERY MANAGE- MENT	10A	Battery Management System
AIR BAG 2	10A	SRS (Supplemental Restraint System) Control Module
P/WINDOW LH	25A	Power Window Main Switch
E-SHIFTER 5	10A	SCU (Shift by wire Control Unit), Console Switch
MODULE 4	10A	IBU (Integrated Body Control Unit), ADAS Driving ECU, ADAS Parking ECU, VESS (Virtual Engine Sound System) UNIT, FRONT VIEW CAMERA, CRASH PAD SWITCH, OVER-HEAD CONSOLE, FRONT/REAR CORNER RADAR
MEMORY	10A	Instrument Cluster, Head Up Display, Mood Lamp, Air Conditioner Control Module
AMP	30A	AMP (Amplifier)
P/WINDOW RH	25A	Power Window Main Switch, Passenger Power Switch
MODULE 6	7.5A	IBU (Integrated Body Control Unit), Digital Key 2 Touch Unit
MODULE 5	10A	Head Lamp Leveling Device, Audio/ Navigation Head Unit, Wireless Smart Phone Charging System, ADAS Driving ECU, Overhead Console Lamp, Electric Chromic Mirror, Amp (Amplifier), Seat Warmer Control Module
MDPS 2	7.5A	Motor Driven Power Steering Unit
USB CHARGER	10A	USB CHARGER (FRONT TRAY/ SEAT Driver/ Passenger)
IAU	10A	DIGITAL KEY 2 TOUCH UNIT
BRAKE SWITCH	10A	IBU (Integrated Body Control Unit), Stop Lamp Switch
P/SEAT DRV	30A	Driver Power Seat Switch, Driver IMS (Integrated memory system) Control Module
A/C 1	7.5A	Air Conditioner Control Module
AIR BAG 1	15A	SRS (Supplemental Restraint System) Control Module
IG1 2	25A	Engine Room Junction Block (PCB Block Fuse - IEB4, ECU1)
MODULE 2	10A	AMP (Amplifier), IBU, ADAS Parking ECU, Audio/ Navigation Head Unit, Engine Room Junction Block (P/Outlet Relay), Digital Key 2 Touch Unit
MULTI MEDIA	25A	Audio (Display), Audio/Video & Navigation Head Unit
DOOR LOCK	20A	Center Door Lock lock Relay
MODULE 1	10A	Hazard Switch, Rain Sensor, Steering Wheel Remote Control, ADAS Driving ECU, Power Tailgate Unit, Power Seat, Outside Mirror, Engine Room Junction Block (Blower Relay)
P/SEAT PASS	30A	Passenger Power Seat Switch, Passenger Seat Relay Unit
S/HEATER RR	25A	Rear Seat Warmer Control Module

Fuse Name	Fuse Rating	Circuit Protected
MODULE 7	7.5A	ADAS Parking ECU, AC Inverter, Seat Warmer Control Module

Motor compartment fuse panel

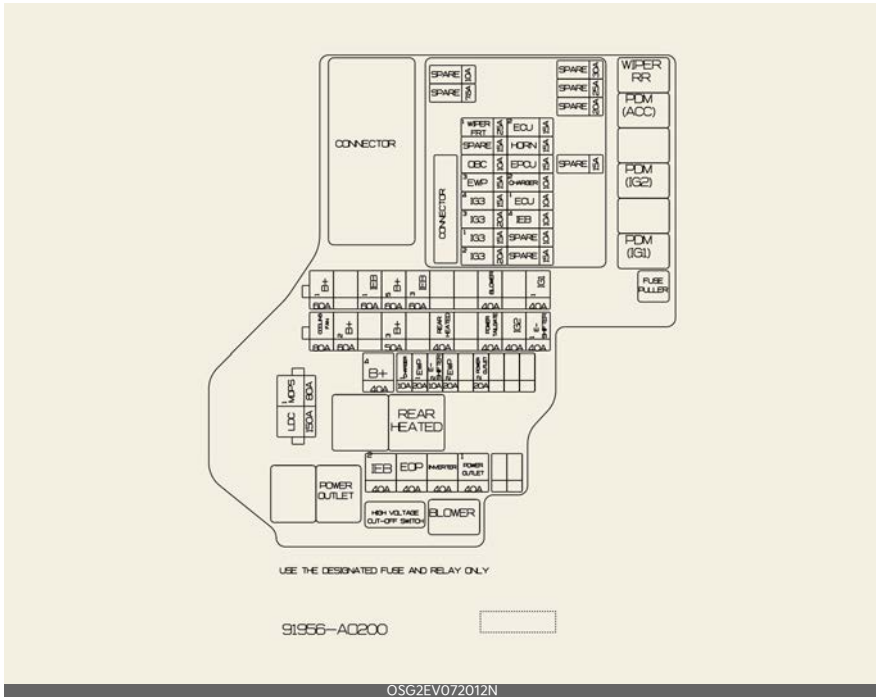

Circuit (P/R Junction Block)

Fuse Name	Fuse Rating	Circuit Protected
MULTI FUSE-1	LDC	Fuse (IEB2, EOP, Inverter, Power Outlet)
	MDPS1	Motor Driven Power Steering Unit * MDPS is the same as EPS (Electric Power Steering).

	Fuse Name	Fuse Rating	Circuit Protected
MULTI FUSE-2	B+5	60A	Engine Room PCB Junction Block
	IG11	40A	ICU Junction Block (FUSE -MODULE2, USB CHARGER, A/BAG1, IBU2, MDPS2, CLUSTER, MODULE3, MODULE4, MODULE5, E-SHIFTER5, FCA, ING1 2)
	B+1	60A	ICU Junction Block (IPS)
	IEB 1	60A	IEB (Integrated Electronic Brake Module)
	IEB 3	60A	IEB (Integrated Electronic Brake Module)
	BLOWER	40A	Blower Relay
MULTI FUSE-3	COOLIN FAN	80A	Cooling Fan Controller
	REAR HEATED	40A	Rear Heated Relay
	B+2	60A	ICU Junction Block (IPS)
	B+3	50A	ICU Junction Block (FUSE - E-SHIFTER3, P/WDW LH, P/WDW RH, T/GATE OPEN, AMP, P/SEAT DRV, P/SEAT PASS, S/HEATER FRT, S/HEATER RR, CHILD LOCK)
	POWER TAIL-GATE	40A	Power Tailgate Unit
	IG2	40A	ICU Junction Block (FUSE - WASHER, A/C1, MODULE6, MODULE7, WIPER RR)
	E-SHIFTER 1	40A	SCU (Shift by wire Control Unit)
FUSE	B+4	40A	ICU Junction Block (FUSE - MULTIMEDIA, MEMORY, A/C2 AIR BAG2 , BRAKE SWITCH, MODULE1, IBU1, SUNROOF, BATTERY MANAGEMENT, DOOR LOCK, IAU)
	IEB 2	40A	IEB (Integrated Electronic Brake Module)
	CHARGER 1	10A	CDM (Charge Door Module)
	EWP1	10A	Battery Electronic Water Pump
	EWP2	10A	Battery Electronic Water Pump
	POWER OUT-LET 1	40A	Front Power Outlet
	INVERTER	40A	AC Inverter
	EOP	40A	Front Electronic Oil Pump
	E-SHIFTER2	10A	SCU (Shift by wire Control Unit)
	POWER OUT-LET 2	20A	Front Power Outlet

PCB Block

Fuse Name	Fuse Rating	Circuit Protected
WIPER FRT1	25A	Front Wiper Motor
EPCU	15A	Front Inverter
HORN	15A	HORN
OBC	10A	VCMS, ICCU_SIG
EWP 3	15A	Electronic Water Pump
IG3 1	15A	Inverter, VCU
IG3 3	20A	Electronic Water Pump
ECU 1	10A	VCU
IG3 4	15A	VCMS, ICCU_SIG, COOLING FAN, CDM, A/C COMP

Fuse Name	Fuse Rating	Circuit Protected
IEB 4	10A	IEB (Integrated Electronic Brake Module)
CHARGER 2	10A	Charger Lock, Unlock Relay
IG3 2	20A	FRONT ELECTRONIC OIL PUMP, 3WAY VALVE BATT, ICU IG3 FUSE(IG3 7, IG3 5, E-SHIFTER 4, IG3 6)
ECU 2	15A	VCU

Relay

Refer to the following table for the relay type.

Relay Name	TYPE
Rear Heated Relay	MINI
ACC Relay	MICRO
IG1 Relay	MICRO
Blower Relay	MICRO
IG2 Relay	MICRO
Power Outlet Relay	MICRO
REAR WIPER RELAY	MICRO

Light bulbs

Light bulbs are installed in various parts of the vehicle to provide lighting inside and outside the vehicle as well as to alert other vehicles.

Bulb replacement precaution

Please keep extra bulbs on hand with appropriate wattage ratings in case of emergencies.

Refer to "Bulb wattage" on page 9-4.

When changing lamps, first turn off the vehicle at a safe place, firmly apply the parking brake and disconnect the (-) battery terminal (For plug-in hybrid vehicle) or battery connector (For hybrid vehicle).

⚠ WARNING

Working on the lights

Prior to start working on the light system, firmly apply the parking brake, ensure that turn the ignition switch or EV button and turn off the lights to avoid sudden movement of the vehicle and burning your fingers or receiving an electric shock.

Use only bulbs of the specified wattage.

⚠ CAUTION

Light replacement

Be sure to replace the burned-out bulb with one of the same wattage rating. Otherwise, it may cause damage to the fuse or electric wiring system.

Fully install light bulbs and any parts used to secure them. Failure to do so may result in heat damage, fire, or water entering the headlamp unit. This may damage the headlamps or cause condensation to build up on the lens. To

prevent damage or fire, make sure bulbs are fully seated and locked.

⚠ CAUTION

Headlamp lens

To prevent damage, do not clean the headlamp lens with chemical solvents or strong detergents.

* NOTICE

- If the light bulb or lamp connector is removed while the lamp is still on, the fuse box's electronic system may log it as a malfunction. Therefore, a lamp malfunction incident may be recorded as a Diagnostic Trouble Code (DTC) in the fuse box.
- It is normal for an operating lamp to flicker momentarily. This is due to a stabilization function of the vehicle's electronic control device. If the lamp lights up normally after momentarily blinking, then it is functioning as normal.

However, if the lamp continues to flicker several times or turns off completely, there may be an error in the vehicle's electronic control device. Please have the vehicle checked by an authorized Kia dealer immediately.

* NOTICE

Have the headlamp aiming adjusted by an authorized Kia dealer after an accident or after the headlamp assembly is reinstalled.

* NOTICE

You can find moisture inside the lens of lamps after a car wash or driving in the rain. It is a natural event caused by the

temperature difference between the inside and the outside of the lamp and does not mean there is a problem with its functions. The moisture inside the lamp would disappear if you drive the vehicle with the headlamp turned on. However, the level at which the moisture is removed may differ depending on the size/location/condition of the lamp. If the moisture continues to stay inside the lamp, have the vehicle checked by an authorized Kia dealer.

If you don't have the necessary tools, the correct bulbs and the expertise, consult an authorized Kia dealer. In many cases, it is difficult to replace vehicle light bulbs because other parts of the vehicle must be removed before you can get to the bulb. This is especially true if you have to remove the headlamp assembly to get to the bulb(s).

Removing/installing the headlamp assembly can result in damage to the vehicle. If non-genuine parts or substandard bulbs are used, it may lead to blowing a fuse or other wiring damages. Kia Genuine Parts we guarantee for quality and performance.

Do not install extra lamps or LEDs to the vehicle. If additional lights are installed, it may lead to lamp malfunctions and flickering. Additionally, the fuse box and other wiring may be damaged.

Light bulb position (Front)

Headlamp - Type A



Headlamp - Type B



Fog lamp



- 1 Headlamp (Low) (LED type)
- 2 Headlamp (Low/High) (Bulb type)
- 3 Headlamp (Low/High) (LED type)
- 4 Day time running lamp/Position lamp/ Front turn signal lamp (LED type)
- 5 Front fog lamp (LED type)
- 6 Front side marker lamp (LED type)

Light bulb position (Rear)

Rear combination lamp - Type A



Rear combination lamp - Type B





- 1 Rear turn signal lamp (Bulb type)
- 2 Backup lamp (Bulb type)
- 3 Rear turn signal lamp (LED type)
- 4 Backup lamp (LED type)
- 5 Tail lamp/Stop lamp (LED type)
- 6 High mounted stop lamp (LED type)
- 7 License plate lamp (Bulb type)
- 8 Rear side marker (LED type)

Light position (Side)



- 1 Side repeater lamp (LED type)

Replacing lights (LED type)

If the LED lamp does not operate, have your vehicle checked by an authorized Kia dealer. The LED lamp cannot be replaced as a single component because it is an integrated unit. The LED lamp has to be replaced with the unit.

A skilled technician should check or repair the LED lamp, for it may damage related parts of the vehicle.

Replacing headlamp (Low beam/ High beam) (Bulb type)

Operation

1. Before turning off the vehicle, operate the steering wheel in the opposite

direction of the lamp to be replaced to steer the tires toward the inside of the vehicle body.

- When replacing the right head-lamp: operate to the left
 - When replacing the left headlamp: operate to the right
2. Turn off vehicle and disconnect the (-) battery terminal (For plug-in hybrid vehicle) or battery connector (For hybrid vehicle).
 3. Remove the wheel guard fasteners using a tool and then remove the wheel guard.



4. Remove the socket from the assembly (1) by turning the socket counter-clockwise until the tabs on the socket align with the slots on the assembly



5. Remove the bulb from the socket by pressing it in and rotating it counter-clockwise until the tabs on the bulb align with the slots in the socket. Pull the bulb out of the socket.
6. Insert a new bulb by inserting it into the socket and rotating it until it locks into place
7. Install the socket in the assembly by aligning the tabs on the socket with the slots in the assembly. Push the

socket into the assembly and turn the socket clockwise

- Connect the (-) battery terminal (For plug-in hybrid vehicle) or battery connector (For hybrid vehicle).

Headlamp bulb



⚠ WARNING

Halogen bulbs

- Halogen bulbs contain pressurized gas that will produce flying pieces of glass if broken.
- Always handle them carefully, and avoid scratches and abrasions. If the bulbs are lit, avoid contact with liquids. Never touch the glass with bare hands. Residual oil may cause the bulb to overheat and burst when lit. A bulb should be operated only when installed in a headlight.
- If a bulb becomes damaged or cracked, replace it immediately and carefully dispose of it.
- Wear eye protection when changing a bulb. Allow the bulb to cool down before handling it.

Replacing rear turn signal lamp, backup lamp (Bulb type)

If the rear turn signal lamp or backup lamp does not operate, have your vehicle checked by a professional workshop. A skilled technician should check or repair the lamps, for it may damage related parts of the vehicle.

Replacing high mounted stop lamp (LED type)



If the high mounted stop lamp (LED) does not operate, have your vehicle checked by an authorized Kia dealer.

The LED lamp cannot be replaced as a single component because it is an integrated unit. The LED lamp has to be replaced with the unit.

A skilled technician should check or repair the high mounted stop lamp (LED), for it may damage related parts of the vehicle.

Replacing license plate lamp (Bulb type)

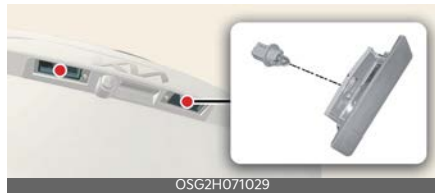

- Turn off vehicle and disconnect the (-) battery terminal (For plug-in hybrid vehicle) or battery connector (For hybrid vehicle).
- Using a flat-blade screwdriver, gently pry the lens cover from lamp housing.
- Remove the bulb by pulling it straight out.
- Install a new bulb in the socket.
- Align the lens cover tabs with the lamp housing notches and snap the lens into place.

Replacing map lamp (Bulb type)



⚠ WARNING

Interior lamps

Prior to working on the Interior lamps, ensure that the "OFF" button is depressed to avoid burning your fingers or receiving an electric shock.

1. Turn off vehicle and disconnect the (-) battery terminal (For plug-in hybrid vehicle) or battery connector (For hybrid vehicle).
2. Using a flat-blade screwdriver, gently pry the lens cover from lamp housing.
3. Remove the bulb by pulling it straight out.
4. Install a new bulb in the socket.
5. Align the lens cover tabs with the lamp housing notches and snap the lens into place.

⚠ CAUTION

Be careful not to dirty or damage the lens, lens tab, and plastic housings.

Replacing room lamp (Bulb type)



⚠ WARNING

Interior lamps

Prior to working on the Interior lamps, ensure that the "OFF" button is depressed to avoid burning your fingers or receiving an electric shock.

1. Turn off vehicle and disconnect the (-) battery terminal (For plug-in hybrid vehicle) or battery connector (For hybrid vehicle).
2. Using a flat-blade screwdriver, gently pry the lens cover from lamp housing.
3. Remove the bulb by pulling it straight out.
4. Install a new bulb in the socket.
5. Align the lens cover tabs with the lamp housing notches and snap the lens into place.

⚠ CAUTION

Be careful not to dirty or damage the lens, lens tab, and plastic housings.

Replacing vanity mirror lamp (Bulb type)



⚠ WARNING

Interior lamps

Prior to working on the Interior lamps, ensure that the "OFF" button is depressed to avoid burning your fingers or receiving an electric shock.

1. Turn off vehicle and disconnect the (-) battery terminal (For plug-in hybrid

- vehicle) or battery connector (For hybrid vehicle).
2. Using a flat-blade screwdriver, gently pry the lamp assembly from interior.
3. Remove the bulb by pulling it straight out.
4. Install a new bulb in the socket.
5. Install the lamp assembly to interior.

⚠ CAUTION

Be careful not to dirty or damage the lens, lens tab, and plastic housings.

Replacing glove box lamp (Bulb type)

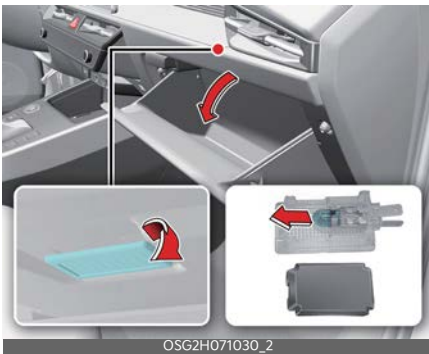

⚠ WARNING

Interior lamps

Prior to working on the Interior lamps, ensure that the "OFF" button is depressed to avoid burning your fingers or receiving an electric shock.

1. Turn off vehicle and disconnect the (-) battery terminal (For plug-in hybrid vehicle) or battery connector (For hybrid vehicle).
2. Using a flat-blade screwdriver, gently pry the lamp assembly from interior.
3. Remove the cover from the lamp assembly.

4. Remove the bulb by pulling it straight out.
5. Install a new bulb in the socket.
6. Install the cover to the lamp assembly.
7. Install the lamp assembly to interior.

⚠ CAUTION

Be careful not to dirty or damage the lens, lens tab, and plastic housings.

Replacing luggage lamp (Bulb type)



⚠ WARNING

Interior lamps

Prior to working on the Interior lamps, ensure that the "OFF" button is depressed to avoid burning your fingers or receiving an electric shock.

1. Turn off vehicle and disconnect the (-) battery terminal (For plug-in hybrid vehicle) or battery connector (For hybrid vehicle).
2. Using a flat-blade screwdriver, gently pry the lamp assembly from interior.
3. Remove the cover from the lamp assembly.
4. Remove the bulb by pulling it straight out.
5. Install a new bulb in the socket.
6. Install the cover to the lamp assembly.
7. Install the lamp assembly to interior.

⚠ CAUTION

Be careful not to dirty or damage the lens, lens tab, and plastic housings.

Appearance care**Exterior care****Exterior general caution**

Read all warning and caution statements that appear on the label and follow the label directions when using any chemical cleaner or polish.

*** NOTICE**

If you park the vehicle around a stainless signboard or windshield building etc., the plastic exterior trim (bumper, spoiler, garnish, lamp, outside mirror etc.) may be damaged by reflected sunlight from the external structure. To avoid damaging the plastic exterior trim, park the vehicle away from the areas where the reflected light may occur or use a vehicle cover. (Depending on the vehicle, the type of exterior trim applied such as spoiler may differ.)

Finish maintenance**Washing**

To help protect your vehicle's finish from rust and deterioration, wash it thoroughly and frequently at least once a month with lukewarm or cold water.

If you use your vehicle for off-road driving, you should wash it after each off-road trip. Pay special attention to the removal of any accumulation of salt, dirt, mud, and other foreign materials. Make sure the drain holes in the lower edges of the doors and rocker panels are kept clear and clean. Insects, tar, tree sap, bird droppings, industrial pollution and similar deposits can damage your vehicle's finish if not removed immediately.

Even prompt washing with plain water may not completely remove all these deposits. A mild soap, safe for use on painted surfaces, may be used. After washing, rinse the vehicle thoroughly with lukewarm or cold water. Do not allow soap to dry on the finish.

⚠ WARNING

After washing the vehicle, test the brakes while driving slowly to see if they have been affected by water. If braking performance is impaired, dry the brakes by applying them lightly while maintaining a slow forward speed.

⚠ CAUTION

- Do not use strong soap, chemical detergents or hot water, and do not wash the vehicle in direct sunlight or when the body of the vehicle is warm.
- Be careful when washing the side windows and other gaps (between door and body structure, side windows and exterior) of your vehicle. Especially, with high-pressure water, water may leak through the windows and wet the interior.
- To prevent damage to the plastic parts and lamps, do not clean with chemical solvents or strong detergents.

High-pressure washing



OSG2PH072020L

- When using high-pressure washers, make sure to maintain sufficient distance from the vehicle. Insufficient clearance or excessive pressure can lead to component damage or water penetration.
- Do not spray the camera, sensors or its surrounding area directly with a high pressure washer. Shock applied from high pressure water may cause the device to not operate normally.
- Do not bring the nozzle tip close to boots (rubber including weather strips or plastic covers) or connectors as they may be damaged if they come into contact with high pressure water.

⚠ CAUTION

- Water washing in the motor compartment including high pressure water washing may cause the failure of electrical circuits located in the motor compartment.
- Never allow water or other liquids to come in contact with electrical/electronic components inside the vehicle as this may damage them.

Waxing

Wax the vehicle when water will no longer bead on the paint.

Always wash and dry the vehicle before waxing. Use a good quality liquid or paste wax, and follow the manufacturer's instructions. Wax all metal trim to protect it and to maintain its luster.

Removing oil, tar, and similar materials with a spot remover will usually strip the wax from the finish. Be sure to re-wax these areas even if the rest of the vehicle does not yet need waxing. Do not apply

wax on embossed unpainted unit, as it may tarnish the unit.

⚠ CAUTION

- Wiping dust or dirt off the body with a dry cloth will scratch the finish.
- Do not use steel wool, abrasive cleaners, acid detergents or strong detergents containing high alkaline or caustic agents on chrome-plated or anodized aluminum parts. This may result in damage to the protective coating and cause discoloration or paint deterioration.

Finish damage repair

Deep scratches or stone chips in the painted surface must be repaired promptly. Exposed metal will quickly rust and may develop into a major repair expense.

*** NOTICE**

If your vehicle is damaged and requires any metal repair or replacement, be sure the body shop applies anti-corrosion materials to the parts repaired or replaced.

Bright-metal maintenance

- To remove road tar and insects, use a tar remover, not a scraper or other sharp object.
- To protect the surfaces of bright metal parts from corrosion, apply a coating of wax or chrome preservative and rub to a high luster.
- During winter weather or in coastal areas, cover the bright metal parts with a heavier coating of wax or preservative. If necessary, coat the parts

with non-corrosive petroleum jelly or other protective compound.

Underbody maintenance

Corrosive materials used for ice and snow removal and dust control may collect on the underbody. If these materials are not removed, accelerated rusting can occur on underbody parts such as the frame, floor pan, even though they have been treated with rust protection.

Thoroughly flush the vehicle underbody and wheel openings with lukewarm or cold water once a month, after off-road driving and at the end of each winter. Pay special attention to these areas because it is difficult to see all the mud and dirt. It will do more harm than good to wet down the road grime without removing it. The lower edges of the doors, rocker panels, and frame members have drain holes that should not clog with dirt; trapped water in these areas can cause rusting.

⚠ WARNING

After washing the vehicle, test the brakes while driving slowly to see if they have been affected by water. If braking performance is impaired, dry the brakes by applying them lightly while maintaining a slow forward speed.

Aluminum wheel maintenance

The aluminum wheels are coated with a clear protective finish.

- Do not use any abrasive cleaner, polishing compound, solvent, or wire brushes on aluminum wheels. They may scratch or damage the finish.
- Clean the wheel when it has cooled.

- Use only a mild soap or neutral detergent, and rinse thoroughly with water. Also, be sure to clean the wheels after driving on salted roads. This helps prevent corrosion.
- Avoid washing the wheels with high-speed car wash brushes.
- Do not use any alkaline or acid detergent. It may damage and corrode the aluminum wheels coated with a clear protective finish.

Corrosion protection

Protecting your vehicle from corrosion

By using the most advanced design and construction practices to combat corrosion, we produce vehicles of the highest quality. However, this is only part of the job. To achieve the long-term corrosion resistance your vehicle can deliver, the owner's cooperation and assistance is also required.

Common causes of corrosion

The most common causes of corrosion on your vehicle are:

- Road salt, dirt and moisture that is allowed to accumulate underneath the vehicle.
- Removal of paint or protective coatings by stones, gravel, abrasion or minor scrapes and dents which leave unprotected metal exposed to corrosion.

High-corrosion areas

If you live in an area where your vehicle is regularly exposed to corrosive materials, corrosion protection is particularly important. Some of the common causes

of accelerated corrosion are road salts, dust control chemicals, ocean air and industrial pollution.

Moisture breeds corrosion

Moisture creates the conditions in which corrosion is most likely to occur. For example, corrosion is accelerated by high humidity, particularly when temperatures are just above freezing. In such conditions, the corrosive material is kept in contact with the vehicle's surface by moisture that evaporate slowly. Mud is particularly corrosive because it dries slowly and holds moisture in contact with the vehicle. Although the mud appears to be dry, it can still retain moisture and promote corrosion. High temperatures can also accelerate corrosion of parts that are not properly ventilated so the moisture can be dispersed.

Keep your vehicle clean and free of mud or accumulations of other materials. This applies not only to the visible surfaces but particularly to the underside of the vehicle.

To help prevent corrosion

You can help prevent corrosion from getting started by observing the following:

Keep your vehicle clean

The best way to prevent corrosion is to keep your vehicle clean and free of corrosive materials. Attention to the underside of the vehicle is particularly important.

- If you live in a high-corrosion area - where road salts are used, near the ocean, areas with industrial pollution, acid rain, etc., you should take extra care to prevent corrosion. In winter,

hose off the underside of your vehicle at least once a month and be sure to clean the underside thoroughly when winter is over.

- When cleaning underneath the vehicle, give particular attention to the components under the fenders and other areas that are hidden from view. Do a thorough job; just dampening the accumulated mud rather than washing it away will accelerate corrosion rather than prevent it. Water under high pressure and steam are particularly effective in removing accumulated mud and corrosive materials.
- When cleaning lower door panels, rocker panels and frame members, be sure that drain holes are kept open so that moisture can escape and not be trapped inside to accelerate corrosion.

Keep your garage dry

Don't park your vehicle in a damp, poorly ventilated garage. This creates a favorable environment for corrosion. This is particularly true if you wash your vehicle in the garage or drive it into the garage when it is still wet or covered with snow, ice or mud. Even a heated garage can contribute to corrosion unless it is well ventilated so moisture is dispersed.

Keep paint and trim in good condition

Scratches or chips in the finish should be covered with "touch-up" paint as soon as possible to reduce the possibility of corrosion. If bare metal is showing through, the attention of a qualified body and paint shop is recommended.

Bird droppings are highly corrosive and may damage painted surfaces in just a few hours. Always remove bird droppings as soon as possible.

Don't neglect the interior

Moisture can collect under the floor mats and carpeting and cause corrosion. Check under the mats periodically to be sure the carpeting is dry. Use particular care if you carry fertilizers, cleaning materials or chemicals in the vehicle.

These should be carried only in proper containers and any spills or leaks should be cleaned up, flushed with clean water and thoroughly dried.

Interior care

Interior general precautions

* NOTICE

Prevent chemicals such as perfume, cosmetic oil, sun cream, hand cleaner, and air freshener from contacting the interior parts because they may cause damage or discoloration. If they do contact the interior parts, wipe them off immediately. If necessary, use a mixture of warm water and mild non-detergent cleaner (test all cleaners on a concealed area before use). Use proper car cleaner to clean interior parts.

▲ CAUTION

- Never allow water or other liquids to come in contact with electrical/electronic components inside the vehicle as this may damage them.
- When cleaning leather products (steering wheel, seats etc.), use neutral detergents or low alcohol content solutions. If you use high alcohol con-

tent solutions or acid/alkaline detergents, the color of the leather may fade or the surface may get stripped off.

Taking care of leather seats (if equipped)

- Vacuum the seat periodically to remove dust and sand on the seat. It will prevent abrasion or damage of the leather and maintain its quality.
- Wipe the leather seat cover often with dry or soft cloth.
- Sufficient use of a leather protective may prevent abrasion of the cover and helps maintain the color. Be sure to read the instructions and consult a specialist when using leather coating or protective agents.
- Leather with bright colors is easily contaminated and clear in appearance. Clean the seats frequently.
- Avoid wiping with wet cloth. It may cause the surface to crack.

Cleaning the leather seats (if equipped)

- Remove all contaminations instantly. Refer to instructions below for removal of each contaminant.
- Cosmetic products
 - Apply cleansing cream on a cloth and wipe the contaminated point. Wipe off the cream with a wet cloth and remove water with a dry cloth.
- Beverages
 - Apply a small amount of neutral detergent and wipe until contaminations do not smear.
- Oil

- Remove oil instantly with absorbable cloth and wipe with stain remover for leather only.
- Chewing gum
 - Harden the gum with ice and remove gradually.

Fabric seat cover using precautions (if equipped)

Clean the fabric seats regularly with a vacuum cleaner in consideration of fabric material characteristics. If they are heavily soiled with beverage stains, etc., use a suitable interior cleaner. To prevent damage to seat covers, wipe off the seat covers down to the seams with a large wiping motion and moderate pressure using a soft sponge or microfiber cloth.

Velcro closures on clothing or sharp objects may cause snagging or scratches on the surface of the seats. Make sure not to rub such objects against the surface.

Cleaning the upholstery and interior trim

Car interior surfaces

Remove dust and loose dirt from interior surfaces with a whisk broom or a vacuum cleaner. If necessary, clean interior surfaces with a mixture of warm water and mild non-detergent cleaner (test all cleaners on a concealed area before use).

Fabric

Remove dust and loose dirt from fabric with a whisk broom or vacuum cleaner. Clean with a mild soap solution recommended for upholstery or carpets.

Remove fresh spots immediately with a fabric spot cleaner. If fresh spots do not receive immediate attention, the fabric can be stained and its color can be affected. Also, its fire-resistant properties can be reduced if the material is not properly maintained.

CAUTION

Using anything but recommended cleaners and procedures may affect the fabric's appearance and fire-resistant properties.

Cleaning the lap/shoulder belt webbing

Clean the belt webbing with any mild soap solution recommended for cleaning upholstery or carpet. Follow the instructions provided with the soap. Do not bleach or re-dye the webbing because this may weaken it.

Cleaning the interior window glass

If the interior glass surfaces of the vehicle become fogged (that is, covered with an oily, greasy or waxy film), they should be cleaned with a glass cleaner. Follow the directions on the glass cleaner container.

CAUTION

Do not scrape or scratch the inside of the rear window. This may result in damage of the rear window defroster grid.

California perchlorate notice

Perchlorate Material-special handling may apply, See

<https://dtsc.ca.gov/perchlorate>

Notice to California Vehicle Dismantlers: Perchlorate containing materials, such as air bag inflators, seatbelt pre-tensioners and keyless remote entry batteries, must be disposed of according to Title 22 California Code of Regulations Section 67384.10 (a).

Specifications, Consumer information and Reporting safety

Dimensions	9-2
Electric vehicle specifications	9-3
Available front trunk weight.....	9-3
Air conditioning system.....	9-3
Volume and weight	9-3
Bulb wattage	9-4
Tires and wheels	9-5
Recommended lubricants and capacities	9-5
Vehicle Identification Number (VIN).....	9-6
Vehicle certification label.....	9-6
Tire specification and pressure label.....	9-7
Motor number	9-7
Air conditioner compressor label	9-8
Refrigerant label.....	9-8
Declaration of conformity	9-9
Consumer Assistance (U.S. only).....	9-9
Electrical Equipment (U.S. only)	9-11
Reporting Safety Defects (U.S. only).....	9-12
Online factory authorized manuals (U.S. only)	9-13

Specifications, Consumer information and Reporting safety defects

Dimensions

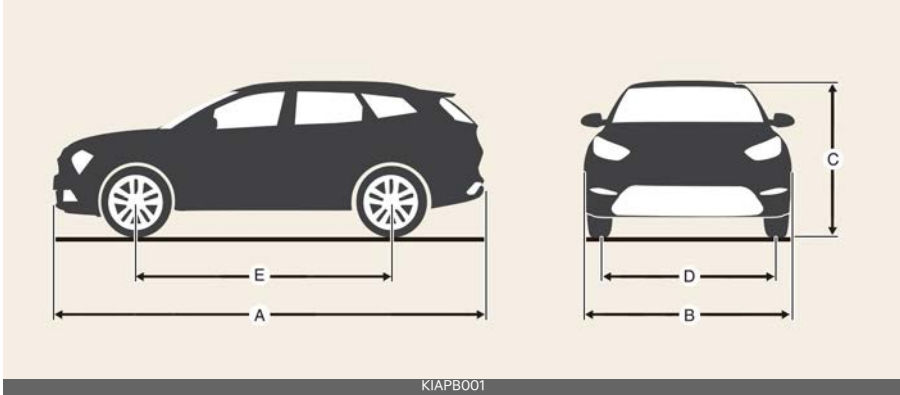

		Item		in (mm)
A	Overall length			174.0 (4,420)
B	Overall width			71.9 (1,825)
C	Overall height			61.8 (1,570)
D	Tread	Front	215/55 R17	61.8 (1,571)
		Rear	215/55 R17	62.2 (1,581)
E	Wheelbase			107.1 (2,720)

Electric vehicle specifications

OBC: On-Board Battery Chargers

Items		Extended type
		2WD
Motor	Max. output (kW)	150
	Max. torque (Nm)	255
Battery (Lithium-ion)	Capacity (kWh)	64.8
	Power output (kW)	182
	Voltage (V)	358
Charger (OBC)	Max. output (kW)	AC single phase
		AC 3 phase
		7 kW
		10.4 kW

Available front trunk weight

Item	2WD
front trunk weight	25 lbs. (10 kg)

Air conditioning system

Item			Weight of volume (g)	Classification
Refrigerant	Type A	With heat pump	850±25	R-134a
		Without heat pump	750±25	R-134a
	Type B	With heat pump	850±25	R-1234yf
		Without heat pump	750±25	R-1234yf
Compressor lubricant			180±10	POE

Please contact a professional workshop for more details. Contact an authorized Kia dealer.

Volume and weight

- MIN: Behind rear seat
- MAX: Behind front seat

Gross Vehicle Weight	Luggage Volume	
	MIN.	MAX.
4,784 lbs. (2,170 kg)	22.8 cu-ft (646 L)	63.7 cu-ft (1805 L)

Bulb wattage

*: if equipped

Light bulb	Bulb type	Wattage (Watt)	
Head lamp (Type A)	Head lamp (High/Low)	HB3	60
	Turn signal lamps	LED	LED
	Position and daytime running lamps	LED	LED
	Side marker	LED	LED
Head lamp (Type B)	Head lamp (High)	LED	LED
	Head lamp (High/Low)	LED	LED
	Turn signal lamps	LED	LED
	Position and daytime running lamps	LED	LED
	Side marker	LED	LED
Front and side	Front fog lamps	LED	LED
	Side repeater lamps	LED	LED
Rear combination lamp	Stop lamps	LED	LED
	Tail lamps	LED	LED
Rear lower combination lamp (Type A)	Turn signal lamps	PY21W	21
	Backup lamps	W16W	16
Rear lower combination lamp (Type B)	Turn signal lamps	LED	LED
	Backup lamps	LED	LED
Rear	High mounted stop lamp	LED	LED
	License plate lamps	W5W	5
	Side marker	LED	LED
Interior	Map lamps (Bulb type)	WEDGE(W10W)	10
	Map lamps (LED type)	LED	LED
	Room lamps (Bulb type)	FESTOON	10
	Room lamps (LED type)	LED	LED
	Vanity mirror lamps*	FESTOON	5
	Glove box lam	W5W	5
	Luggage lamp (Bulb type)	FESTOON	10
	Luggage lamp (LED type)	LED	LED
Ambient light	LED	LED	

* : if equipped

Tires and wheels

*1. Load Index

*2. Speed Symbol

Item	Tire size	Wheel size	Load capacity		Speed capacity		Inflation pressure [bar (psi, kPa)]				Wheel lug nut torque kgf·m (lbf·ft, N·m)
			L ^{*1}	kg	SS ^{*2}	km/h	Normal load		Maximum load		
							Front	Rear	Front	Rear	
Full size tire	215/55 R17	7.0J X 17"	94	670	V	240	2.5 (36, 250)				11~13 (79~94, 107~127)

⚠ CAUTION

When replacing tires, use the same size originally supplied with the vehicle. Using tires of a different size can damage the related parts or make it work irregularly.

* NOTICE

- We recommend that when replacing tires, use the same originally supplied with the vehicles. If not, that affects driving performance.
- When driving in high altitude grades, it is natural for the atmospheric pressure to decrease. Therefore, please check the tire pressure and add more air when necessary.
 - Additionally required tire air pressure per km above sea level: 1.5 psi/km

Recommended lubricants and capacities

To help achieve proper vehicle performance and durability, use only lubricants of the proper quality. These lubricants and fluids are recommended for use in your vehicle.

Lubricant	Volume (L)	Classification
Reduction gear fluid	Approx. 2.8 ~2.9	SK ATF SP4M-1, MICHANG ATF SP4M-1, S-OIL ATF SP4M-1, Kia Genuine ATF SP4M-1
Brake fluid	As required	SAE J1704 DOT-4 LV, FMVSS 116 DOT-4, ISO4925 CLASS-6
Coolant	Without heat pump	Mixture of antifreeze and water (Ethylene-glycol with phosphate-based coolant for cooling device)
	With heat pump	

Vehicle Identification Number (VIN)

Type A



Type B



The Vehicle Identification Number (VIN) is the number used in registering your vehicle and in all legal matters pertaining to its ownership, etc.

- Type A: Engraved on the floor under the front left or right seat. Open the cover to check the VIN.
- Type B: Written on a plate attached to the top left or top right of the dashboard through the front windshield.

Vehicle certification label (if equipped)



The vehicle certification label attached on the center pillar as shown gives the vehicle identification number (VIN).

Tire specification and pressure label



The tire label located on the driver's side center pillar as shown gives the tire pressures recommended for your vehicle. The tires supplied on your new vehicle are chosen to provide the best performance for normal driving.

Motor number

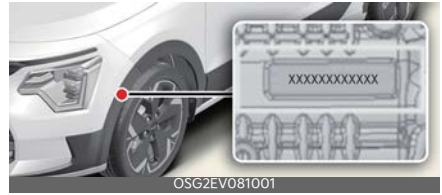

The motor number is stamped on the motor as shown.

Air conditioner compressor label

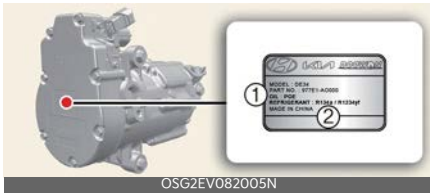

- 1 Refrigerant oil
- 2 Refrigerant

A compressor label informs you the type of compressor your vehicle is equipped with such as model, supplier part number, production number, refrigerant (1) and refrigerant oil (2).

Refrigerant label



The refrigerant label is located as shown.

Declaration of conformity

CE CE 0678

The radio frequency components of the vehicle comply with requirements and other relevant provisions of Directive 1995/5/EC.

Further information including the manufacturer's declaration of conformity is available on Kia website as follows:

<http://www.kia-hotline.com>

Consumer Assistance (U.S. only)

Roadside Assistance is provided on all new current model year Kia Vehicles from the date the vehicle is delivered to the first retail buyer or otherwise put into use (inservice date), whichever is earlier, for a period of 60 months or 60,000 miles, whichever is earlier, subject to the terms, conditions and exclusions set forth in the Kia Warranty and Consumer Information Manual applicable to your model year vehicle.

Kia America, Inc. reserves the right to limit or deny services or other benefits to any owner or driver when, in Kia America, Inc.'s judgment, the claims and/or service requests are excessive in frequency or type of occurrence.

Toll free consumer assistance

from 5:00 AM to 6:00 PM PST, Monday through Friday and is accessible by dialing 1-800-333-4Kia (4542).

For more information regarding assistance available, please refer to your Kia Warranty & Consumer Information Manual.

Emergency roadside assistance

hours a day, 365 days a year and is accessible by dialing 1-800-333-4Kia (4542).

Please note that you must provide your Vehicle Identification Number (VIN) to verify coverage at the time of your call. The VIN can be found on the dash of your vehicle on the driver's side, on the door jamb of the driver's door, your vehicle's registration or proof of insurance card.

Kia utilizes a network of over 30,000 roadside assistance providers. Should you accidentally run out of energy consumption, require a battery jump, or need help changing a tire, a Kia Roadside Assistance Representative will dispatch someone to deliver a small quantity of gas, change a flat tire with your inflated spare, or arrange a battery jump to allow you to proceed to your destination. We have access to a network of over 10,000 locksmiths to help you should you become locked out of your Kia.

In the event that mechanical difficulty renders your vehicle undriveable due to a warranty-related concern, Kia's Roadside Assistance Representative will arrange to transport your vehicle to the nearest Kia dealer or to an authorized Kia alternative service location.

Your vehicle must be accessible to our dispatch transport vehicle, as determined by our driver, to receive this service.

*** NOTICE**

Roadside Assistance benefits are not available for any Kia vehicle that has ever been or should have been issued a "salvage" title or similar "branded" title under any state's law, or has been declared a "total loss" or equivalent by a financial institution or insurance company.

Trip interruption

Trip interruption expense benefits are provided in the event that a warranty-related disablement occurs more than 150 miles from your home, and the repairs require more than 24 hours to complete. Reasonable reimbursement is

included for meals, lodging, or rental vehicle expenses. Trip interruption coverage is limited to \$100 per day subject to a three day maximum limit per incident. You must contact the Kia Roadside Assistance Center to obtain pre-authorization of expenses. Once the Kia Roadside Assistance Center gives authorization for trip interruption benefits, they will assist you in making the necessary arrangements. Insurance deductibles, expenses, and claims paid by your insurance company or other providers are not eligible for reimbursement.

Fleet vehicles are excluded from reimbursement under Kia's Trip Interruption Policy.

Registering your vehicle in a foreign country

If you plan to register your vehicle in a foreign country, you should confirm that it conforms to the regulations in that country. Even if you successfully register the vehicle in a foreign country, you may experience the following problems and should therefore consider the possibility of having to deal with them:

1. The fuel specified for your vehicle may be unavailable. If other than the specified fuel is used, it could cause damage to the vehicle, the fuel injection system, and other fuel-related parts which may not be covered under your New Vehicle Emissions Limited Warranty.
2. We must, therefore, clearly state that when you leave the country in which you purchased your Kia new and register it in another country, problems arising from the use of fuel other than the specified fuel are not subject to

manufacturer's warranty. Because vehicles like yours may not be marketed in the new country of registration, parts, servicing techniques and tools necessary to maintain and repair your vehicle may be unavailable.

Even if vehicles like yours are sold there, mechanical specifications required by the government may vary enough from the country of purchase to cause additional problems.

3. There may not be an Authorized Kia Dealer in the area in which you plan to register your vehicle. You may additionally experience difficulty in obtaining services in a foreign country for any number of reasons.

Further, we cannot assume any responsibility for problems that result from unsatisfactory service or lack of service outside of the United States.

Electrical Equipment (U.S. only)

The electrical system of your vehicle is designed to perform under all reasonably expected operating conditions. However, before any additional electrical equipment is installed in your vehicle, consult an Authorized Kia Dealer, in order to ensure that you do not void your warranty.

Certain electrical equipment, or the way in which it is installed, may adversely affect the operation of your vehicle, including such systems as the vehicle control system, the audio system and the electrical charging system and thus potentially void all or part of your warranty.

We assume no responsibility for any expense you may incur or for any malfunction of your vehicle or any of its components or systems that may result from the installation of additional electrical equipment that is not supplied, or recommended for installation by, Kia.

Installation of a mobile two-way radio system

If a mobile two-way radio system is installed improperly, or if an excessively powerful type of system is used, other electronic systems may be adversely affected. To avoid damage to your vehicle, consult an Authorized Kia Dealer concerning the proper equipment and installation.

Kia vehicles are designed and manufactured to meet or exceed all applicable safety standards.

For your safety, however, we strongly urge you to read and follow all directions in this Owner's Manual, particularly the

information under the headings "NOTICE", "CAUTION" and "WARNING". If, after reading this manual, you have any questions regarding the operation of your vehicle, safety issues and defects please contact your Kia's toll-free Consumer Assistance hot line as below:
National Consumer Affairs Manager
Kia America, Inc.
P.O. Box 52410
Irvine, CA 92619-2410
1-800-333-4Kia (4542)

Reporting Safety Defects (U.S. only)

If you believe that your vehicle has a defect which could cause a crash or could cause injury or death, you should immediately inform the National Highway Traffic Safety Administration (NHTSA) in addition to notifying Kia America, Inc.

If NHTSA receives similar complaints, it may open an investigation, and if it finds that a safety defect exists in a group of vehicles, it may order a recall and remedy campaign. However, NHTSA cannot become involved in individual problems between you, your dealer, or Kia America, Inc.

To contact NHTSA, you may call the Vehicle Safety Hotline toll-free at 1-888-327-4236 (TTY: 1-800-424-9153); go to <http://www.safercar.gov>; download the SaferCar mobile application; or write to: Administrator, NHTSA, 1200 New Jersey Ave. SE., Washington, DC 20590. You can also obtain other information about motor vehicle safety from <http://www.safercar.gov>.

Online factory authorized manuals (U.S. only)

The following publications are available on www.KiaTechinfo.com.

Service manual

This manual covers maintenance and recommended procedures for repair to vehicle and chassis components. It is written for the Journeyman mechanic, but is simple enough for most mechanically inclined owners to understand.

Electrical troubleshooting manual

This manual complements the Service Manual by providing indepth troubleshooting information for each electrical circuit in your vehicle.

Owner's manual

This manual describes the overall features and operating procedures for the vehicle.

Abbreviation **A**

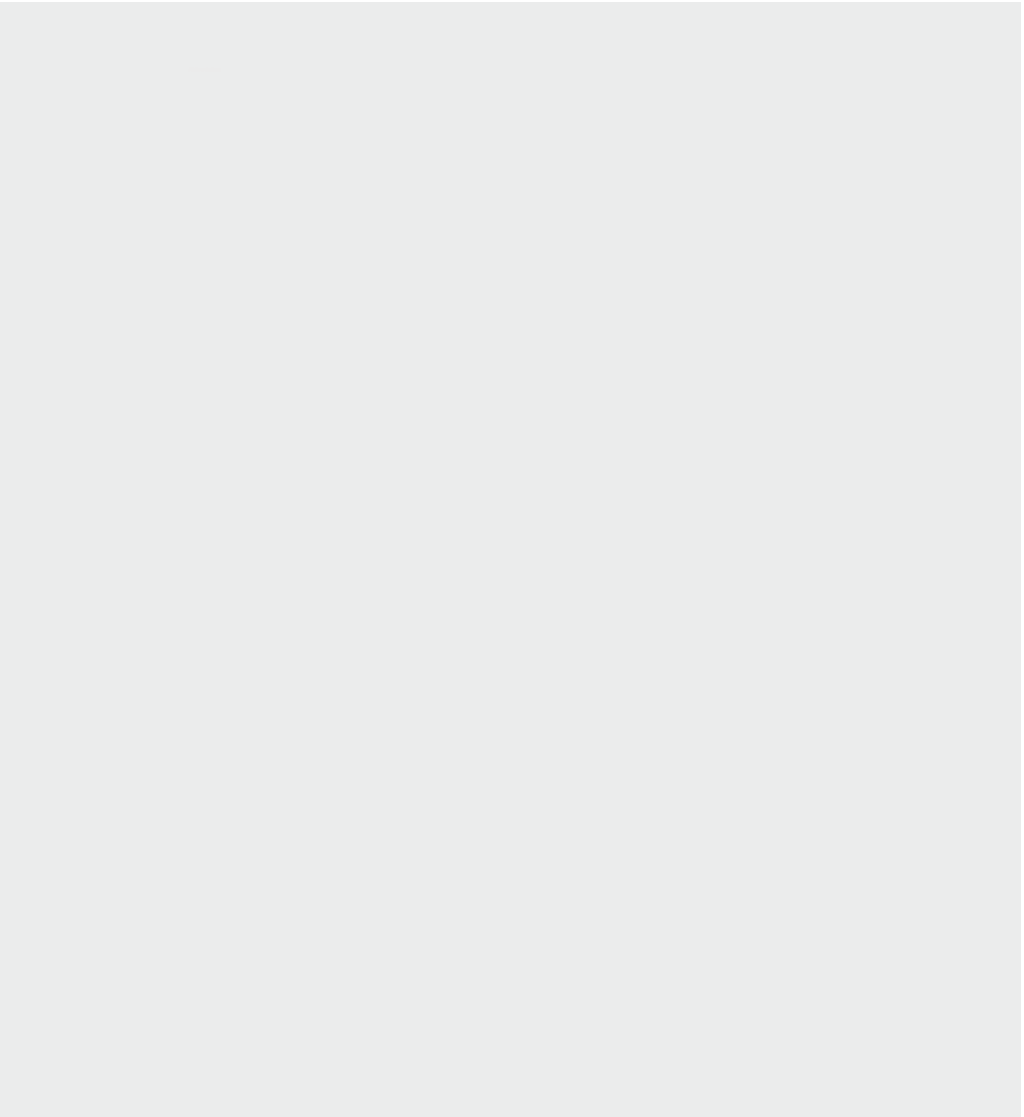

Abbreviation

ABS

Anti-lock Brake System

BCM

Body Control Module

BCW

Blind-spot Collision Warning

CRS

Child Restraint System

DAW

Driver Attention Warning

DRL

Day time Running Light

EBD

Electronic Brake force Distribution

ECM

Electric Chromic Mirror

EDR

Event Data Recorder

EFD

Emergency fastening device

EPB

Electronic Parking Brake

EPS

Electric Power Steering

ESC

Electronic Stability Control

EV

Electric Vehicle

FCA

Forward Collision-Avoidance Assist

FCC

Federal Communications Commission

FMVSS

Federal Motor Vehicle Safety Standards

HAC

Hill-start Assist Control

HBA

High Beam Assist

HMSL

High Mounted Stop Lamp

HV

High Voltage

ICCB

In-Cable Control Box

LATCH

Lower Anchors and Tether for Children

LDC

Low voltage DC-DC Converter

LFA

Lane Following Assist

LKA

Lane Keeping Assist

NHTSA

National Highway Traffic Safety Administration

MIL

Malfunction Indicator Lamp

Abbreviation

MMT

Methylcyclopentadienyl Manganese
Tricarbonyl

OBC

On-board Battery Chargers

ODS

Occupant Detection System

RCCA

Rear Cross-traffic Collision-avoidance
Assist

RCCW

Rear Cross-traffic Collision Warning

SCC

Smart Cruise Control

SOC

State Of Charge

SRS

Supplemental Restraint System

SRSCM

SRS Control Module

TBT

Turn By Turn

TIN

Tire Identification Number

TMK

Tire Mobility Kit

TPMS

Tire Pressure Monitoring System

VCU

Vehicle Control Unit

VESS

Virtual vehicle Sound System

VIN

Vehicle Identification Number

VSM

Vehicle Stability Management

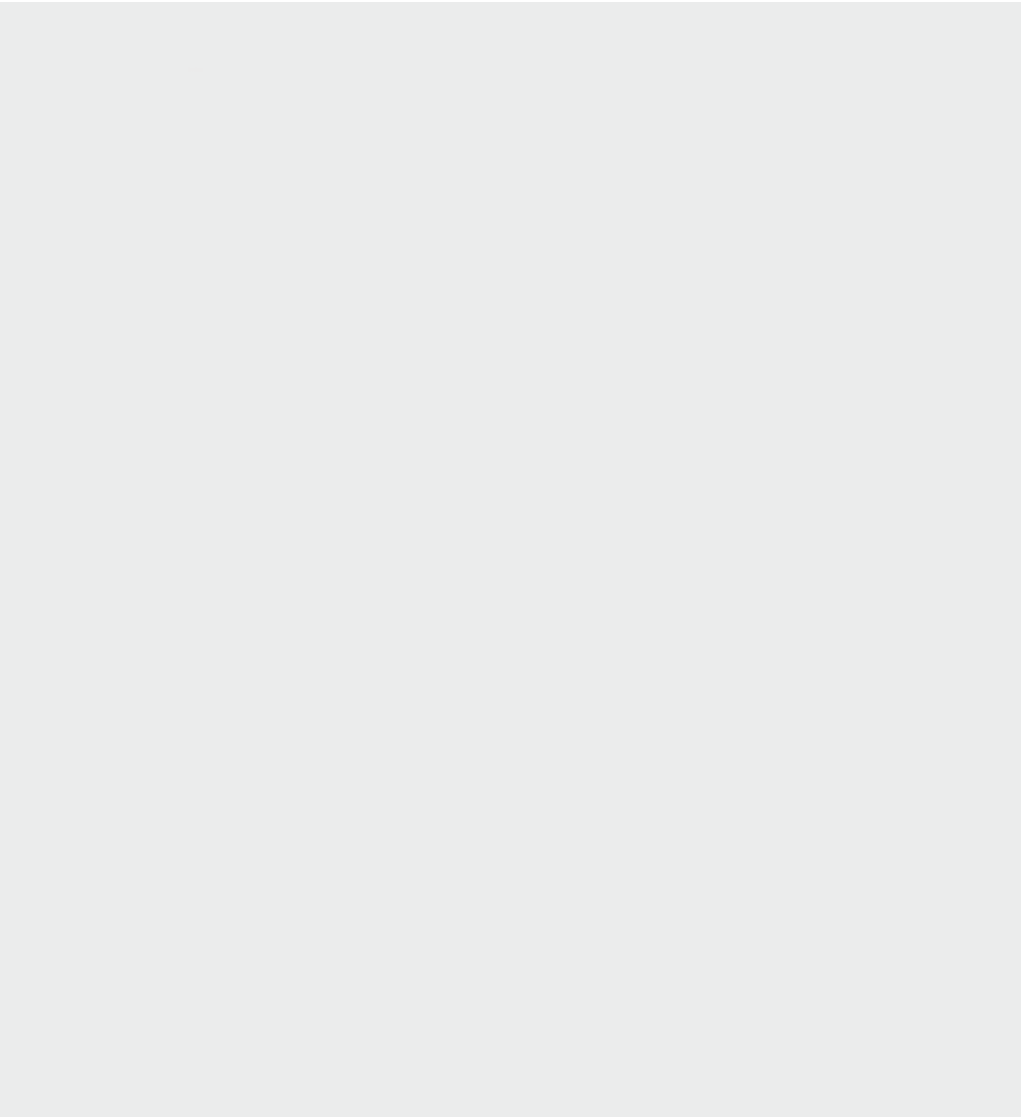

Index

A

A/C automatic drying	5-122
AC charge	1-23
checking charging status	1-24
how to connect	1-23
how to disconnect	1-24
ac inverter	5-128
active air flap	6-38
malfunction	6-38
air bag warning label	4-51
air bag warning light	4-34
air bags	4-32
adding equipment to or modifying your vehicle	4-51
air bag collision sensors	4-47
air bag warning label	4-51
air bag warning light	4-34
curtain air bag	4-45
driver's and passenger's front air bag	4-42
how air bags operate	4-33
inflation and non-inflation conditions	4-48
inflation conditions	4-48
non-inflation conditions	4-49
occupant detection system (ODS)	4-36
side air bag	4-44
SRS care	4-50
SRS components and functions	4-35
air ventilation seat	5-126
ambient light	5-124
anti-lock brake system (ABS)	6-30
appearance care	8-47
exterior care	8-47
interior care	8-51
armrest	4-14
audio system	5-137
radio	5-138
USB port	5-137
auto defogging system (ADS)	5-121
auto hold	6-27
automatic climate control system	5-109
air conditioning refrigerant label	5-118

checking the amount of air conditioner refrigerant and compressor lubricant	5-119
climate control air filter	5-118
heating and air conditioning automatically	5-110
heating and air conditioning manually	5-112
system operation	5-116
using the infotainment/climate switchable controller	5-110

B

battery	8-16
battery capacity label	8-17
battery recharging	8-17
for best battery service	8-16
reset items	8-18
battery saver function	5-95
before driving	6-5
blind-spot collision-avoidance assist (BCA)	6-65
malfunction and limitations	6-70
operation	6-67
settings	6-66
Brake Assistant System (BAS)	6-34
brake fluid	8-12
checking the brake fluid level	8-12
brake system	6-21
anti-lock brake system (ABS)	6-30
auto hold	6-27
Brake Assistant System (BAS)	6-34
electronic control suspension (ECS)	6-34
electronic parking brake (EPB)	6-23
electronic stability control (ESC)	6-31
hill-start assist control (HAC)	6-34
power brakes	6-21
vehicle stability management (VSM)	6-33
bulb replacement precaution	8-41

C

california perchlorate notice	8-53
cargo security screen	5-134
center console storage	5-123
certification label	6-174

charge indicator lamp for electric vehicle	1-19	personalized profile and vehicle settings	5-26
charging status	1-19	smart phone	5-20
charge types for electric vehicle	1-17	used vehicle/digital key 2 touch maintenance	5-29
charging information	1-17	door locks	5-13
charging time information	1-17	child-protector rear door lock	5-17
charging types	1-18	door lock/unlock features	5-17
charging and climate	1-8	from inside the vehicle	5-15
off-peak time settings	1-9	rear occupant alert (ROA) system	5-19
scheduled climate settings	1-9	with the mechanical key	5-14
charging connector lock	1-19	with the smart key	5-13
locking charging cable	1-19	drive mode	6-36
charging door	5-49	drive mode integrated control system	6-36
opening and closing the charging door	5-49	drive mode	6-36
charging electric vehicle	1-21	driver attention warning (DAW)	6-90
charging electric vehicle (abrupt stop)	1-35	malfunction and limitations	6-93
actions to be taken	1-35	operation	6-91
child restraint system (CRS)	4-25	settings	6-91
children always in the rear	4-25	driver position memory system	5-30
installing a CRS	4-27	recalling memory positions	5-30
selecting a CRS	4-26	resetting memory positions	5-30
climate control air filter	8-13	seat easy access	5-31
replacing the climate control air filter	8-13	storing memory positions	5-30
closing the hood	5-47	driver's and passenger's front air bag	4-42
coat hook	5-132	driver's side fuse panel	8-36
consumer assistance	9-9	driving electric vehicle	1-36
coolant	8-11	distance to empty	1-37
cup holder	5-124	eco driving	1-38
curtain air bag	4-45	electricity use	1-38
		how to start the vehicle	1-36
		how to stop the vehicle	1-36
		lcd display messages (related to electric vehicle)	1-41
		power/charge gauge	1-39
		state of charge (soc) gauge for high voltage battery	1-39
		virtual engine sound system (VESS)	1-36
		warning and indicator lights (related to electric vehicle)	1-40
<hr/>			
D		E	
day/night rear view mirror	5-57	electric chromic mirror (ECM)	5-57
daytime running light (DRL)	5-96		
DC charge	1-25		
checking charging status	1-26		
how to connect	1-26		
how to disconnect	1-26		
declaration of conformity	5-140, 6-163		
defroster	5-107		
operating rear window defroster	5-107		
outside mirror defroster	5-108		
digital key 2 touch	5-20		
card key	5-23		

I

if an accident occurs	7-20
immobilizer system	5-10
important safety precautions	4-3
indicator lights	5-91
infotainment system	5-136
audio system	5-137
using the infotainment/climate switchable controller	5-136
inside rear view mirror	5-57
day/night rear view mirror	5-57
electric chromic mirror (ECM)	5-57
electric chromic mirror (ECM) with HomeLink® system	5-58
installing a CRS	4-27
securing a child restraint seat with tether anchor	4-29
securing a child restraint with a lap/shoulder belt	4-30
securing a child restraint with the LATCH anchors	4-28
instrument cluster	5-68
gauges	5-72
instrument panel illumination control	5-71
instrument panel illumination control	5-71
intelligent speed limit assist (ISLA)	6-85
malfunction and limitations	6-88
operation	6-87
settings	6-85
interior features	5-124
ac inverter	5-128
air ventilation seat	5-126
ambient light	5-124
cargo security screen	5-134
coat hook	5-132
cup holder	5-124
floor mat anchor(s)	5-132
power outlet	5-129
seat warmer	5-125
sun visor	5-127
USB charger	5-127
wireless smart phone charging system	5-129
interior light	5-104

automatic turn off function	5-104
glove box lamp	5-106
luggage room lamp	5-105
map lamp	5-104
room lamp	5-105
vanity mirror lamp	5-105

K

keys	5-6
battery replacement	5-9
smart key	5-6

L

lane following assist (LFA)	6-115
malfunction and limitations	6-118
operation	6-116
settings	6-115
lane keeping assist (LKA)	6-60
malfunction and limitations	6-63
operation	6-61
settings	6-60
LCD display	5-75
changing LCD display modes	5-75
electric energy economy	5-76
LCD display modes	5-75
LCD display modes	5-75
driving assist mode	5-76
information mode	5-78
master warning mode	5-78
trip computer mode	5-76
turn by turn (TBT) mode	5-78
liftgate	5-32
closing the liftgate	5-32
emergency liftgate safety release	5-32
opening the liftgate	5-32
light bulbs	8-41
bulb replacement precaution	8-41
light bulb position (front)	8-42
light bulb position (rear)	8-42
light bulb position (side)	8-43
lighting	5-95
battery saver function	5-95
daytime running light (DRL)	5-96
front fog light	5-98
headlamp delay function	5-95
high beam assist (HBA)	5-99

lighting control	5-96
one-touch lane change	5-98
operating high beam	5-97
operating turn signals	5-98
lighting control	5-96
auto light	5-97
head light (low beam)	5-96
position and tail lamp	5-96
luggage board	5-133
luggage net holder	5-133

M

main components of electric vehicle	1-4
high voltage battery warmer system	1-5
high voltage (hv) battery (lithium-ion)	1-4
maintenance	
lights bulbs	8-41
maintenance services	8-4
manual speed limit assist (MSLA)	6-83
operation	6-83
mirrors	5-57
inside rear view mirror	5-57
outside rear view mirror	5-65
motor compartment fuse panel	8-38
motor room compartment	8-3

N

navigation-based smart cruise control (NSCC)	6-109
limitations	6-112
operation	6-110
settings	6-110

O

occupant detection system (ODS)	4-36
odometer	5-73
one-touch lane change	5-98
online factory authorized manuals	9-13
opening the hood	5-46
outside rear view mirror	5-65

adjusting the outside rear view mirrors	5-65
folding the outside rear view mirror	5-65
reverse parking aid function	5-66
outside temperature gauge	5-73
overview of electric vehicle	1-3
battery information	1-3
characteristics of electric vehicles	1-3
owner maintenance	8-5

P

portable charge	1-27
charging status indicator lamp for portable charger	1-31
checking charging status	1-29
how to connect	1-28
how to disconnect	1-33
precautions	1-33
setting the charge level	1-27
power button	
power button position	6-6
power button position	6-6
power liftgate	5-34
emergency liftgate safety release	5-38
operating the power liftgate	5-35
resetting the power liftgate	5-37
setting the power liftgate	5-36
power outlet	5-129
power window lock button	5-45
precautions for charging electric vehicle	1-21
unlock charging connector in emergency	1-22
pre-tensioner seat belt	4-21

R

rear cross-traffic collision-avoidance assist (RCCA)	6-132
malfunction and limitations	6-136
operation	6-133
rear cross-traffic collision-avoidanceassist (RCCA)	
settings	6-132
rear door locks	
electronic child safety lock system	5-18

rear occupant alert (ROA) system	5-19	folding the rear seat	4-14
rear seat headrest	4-13	front seat adjustment for manual seat	4-8
rear view monitor (RVM)	6-128	front seat adjustment for power seat	4-9
malfunction and limitations	6-131	infotainment system	4-8
operation	6-130	seatback pocket	4-13
settings	6-128	seat belt precautions	4-22
reduction gear	6-9	seat belt restraint system	4-17
good driving practices	6-13	seat belt warning light	4-18
LCD display messages	6-11	seat belts	4-17
operation	6-9	care of seat belts	4-24
parking	6-11	driver's 3-point system with emergency locking retractor	4-18
remote smart parking assist (RSPA)	6-153	front passenger and rear seat 3-point system with combination locking retractor	4-20
malfunction and precautions	6-159	pre-tensioner seat belt	4-21
operation	6-155	seat belt precautions	4-22
settings	6-154	seat belt restraint system	4-17
reporting safety defects	9-12	seat belt warning light	4-18
reverse parking collision-avoidance assist (PCA)	6-147	seat warmer	5-125
malfunction and precautions	6-149	seatback pocket	4-13
operation	6-148	securing a child restraint seat with tether anchor	4-29
settings	6-147	securing a child restraint with a lap/shoulder belt	4-30
reverse parking distance warning (PDW)	6-139	securing a child restraint with the LATCH anchors	4-28
malfunction and precautions	6-141	side air bag	4-44
operation	6-140	smart cruise control (SCC)	6-95
settings	6-139	malfunction and limitations	6-104
road warning	7-2	operation	6-97
roof rack	5-135	settings	6-96
<hr/>			
S		smart key	5-6
safe exit assist (SEA)	6-78	mechanical key	5-8
malfunction and limitations	6-81	operation	5-6
operation	6-79	smart liftgate with auto open	5-39
settings	6-78	detecting area	5-40
safe exit warning (SEW)	6-74	how to deactivate	5-40
malfunction and limitations	6-76	how to use	5-39
operation	6-75	smart regeneration system	6-16
settings	6-74	activation	6-16
safety precautions for electric vehicle	1-47	limitation	6-18
scheduled charging	1-20	malfunction	6-18
scheduled maintenance service	8-7	resuming	6-17
seat	4-5	setting	6-16
feature of seat leather	4-7	turning off	6-17
		smart ventilation	5-122

certification label	6-174
vehicle modifications	2-3
vehicle stability management (VSM)	6-33
vehicle to load (V2L)	1-9
energy information	1-10
how to connect	1-10
LCD display messages	1-11
vehicle weight	6-175
virtual engine sound system (vess)	1-36

W

warning and indicator lights	5-85
indicator lights	5-91
warning lights	5-85
warning lights	5-85
washer fluid	8-13
checking the washer fluid level	8-13
welcome system	5-106
window opening and closing	5-43
windows	5-42
power window lock button	5-45
window opening and closing	5-43
windshield defrosting and defogging	5-120
A/C automatic drying	5-122
auto defogging system (ADS)	5-121
automatic ventilation	5-122
defogging inside windshield with automatic climate control	5-120
defogging logic	5-121
defrosting outside windshield with the automatic climate control	5-120
smart ventilation	5-122
winter driving	6-168
wiper blade	8-14
replacing the front wiper blade	8-14
wipers and washers	5-101
wireless smart phone charging system	5-129

2022 KIA AMERICA, INC.



"Printed with soy-based ink on recycled paper. We support a healthy planet and better tomorrow."



Movement that inspires