

Polestar 2

—

Manual



# Start

This car is the meeting point of design, technology and innovation. Every aspect is designed to offer unparalleled performance.

Please read the Manual, in order to both optimise your experience with the Polestar 2, and to learn everything you need to know about it. Manuals and other instructions can be found on the Polestar Support Site ([support.polestar.com](https://support.polestar.com)) and via the Polestar app.

# Table of contents

- 7 Manual information**

You can find information here on where to find and read the Manual, how to navigate in the Manual in the centre display and how to read the Manual.
- 13 Your Polestar**

You will find information here on how to create and register a Polestar ID, installation of accessories, how to view the car's identification number (VIN), etc.
- 27 Safety**

You will find information here on the various safety systems that your car is equipped with, such as airbags, the Whiplash Protection System (WHIPS), child restraint systems, etc. and how you can activate and deactivate the passenger airbags.
- 67 Displays and voice control**

You will find information here on the car's instruments and controls, the driver display (with meters and indicator and warning symbols, etc.), the centre display (operation, navigation and symbols, etc.) and voice control and how to use it.
- 127 Lighting**

You will find information here on the car's interior and external lighting and its lighting control.
- 145 Windows, glass and mirrors**

You will find information here on the car's windows, window mechanisms, rearview mirrors, etc. and how to operate them. You will also find information on the car's panoramic roof, washers and wipers, etc. and how to use these.

- 159 Seats and steering wheel**  
You will find information here on the car's seat and steering wheel and how to adjust them and save position settings for the seat, rear view mirrors and head-up display.
- 173 Climate**  
You will find information here on the car's climate control and heater, how to change its settings, air distribution, etc. and how to activate and deactivate heating of the seats, steering wheel, rear window and door mirrors.
- 197 Key, locks and alarm**  
You will find information here on how you can lock and unlock the car in different ways. How to activate various functions, and which settings you can define. You will also find information on the alarm and how to activate and deactivate it.
- 241 Driver support**  
You will find information here on the car's various driver support systems such as electronic stability control, cruise control, etc. You will also find information on settings and restrictions and on how to activate and deactivate various systems.
- 347 Electric operation and charging**  
You can find information here on charging for electric operation, and on symbols and messages in the driver display relating to charging. You will also find information on long-term storage of vehicles with electric operation.
- 371 Starting and driving**  
Information on how to start and switch off the car and on the various ignition modes can be found here. You will also find information on brakes, drive modes, jump starting, towing, etc.
- 413 Audio and media**  
You will find information here on the radio, media player, phone, apps, etc. and which settings you can define. You will also find information on how to connect your mobile phone to the car.
- 431 Polestar Connect**  
You will find information here about Polestar Connect and how you use the car's CONNECT and SOS to get in touch with Polestar Support or summon assistance from an emergency call centre. You can also find information on the Polestar app.
- 441 Navigation**  
You will find information here on navigation, symbols and messages in the navigation system, which settings you can define and how to activate and deactivate the system.
- 451 Wheels and tyres**  
You will find information here on wheels and tyres, how to check and adjust tyre pressures and how to change wheels. You will also find information on the emergency puncture repair kit, tools, winter tyres, snow chains, etc.
- 479 Loading, storage and passenger compartment**  
You will find information here on the interior, electrical sockets and USB input, storage spaces, the warning triangle, the cargo area, recommendations when loading, etc.

**493 Maintenance and service**

You will find information here on the service programme, car status, Download Centre, checking and topping up fluids, batteries, fuses, cleaning, washing, wiper blade replacement, etc.

**541 Specifications**

Information on decals, dimensions, weights, engine specifications, fluid and oil specifications, approved wheel and tyre dimensions, tyre pressures, etc. can be found here.

**555 Alphabetical Index**

Section 01

—



Manual information

# Available information

Polestar works continuously to develop the user information. The information is available when you need it in several different product formats.

## The car's centre display

The complete and current information for your car is always available in the car's centre display.

To access the Manual – tap on  and then on .

Find information by:

- using the search function
- visually navigating using exterior and interior images
- clicking through categories.

The manual contains important safety instructions. Polestar recommends that you read the information under each category in its entirety before driving for the first time.

## Polestar's support site

Go to [support.polestar.com](https://support.polestar.com) and select your country. The Manual can be found online here. The Polestar support site also has instruction videos and further information and assistance relating to your Polestar and your car ownership.

On the support site you can find:

- online version of the Manual
- popular articles
- video tutorials.

The support site is updated with the latest information and is available for most markets.

## Printed information

In the car's glovebox you will find printed information of selected topics that can be practical to have when, for example, you do not have access to the centre display or the support site.

Depending on equipment level selected, market, etc. additional manual information may also be available in printed format in the car.

A printed Manual and associated supplement can be ordered. Contact Polestar Support for orders.

## Related information

- Reading the Manual (p. 10)

## IMPORTANT

The driver is always responsible that the vehicle is driven safely in traffic and that applicable laws and regulations are followed. It is also important that the car is maintained and handled in accordance with Polestar's recommendations in the manual information.

If there should be a difference between the information in the centre display and the printed information then it is always the information in the centre display that applies.

Information in the centre display for your car may differ from the information shown on the Polestar support site.



# Polestar Support

## NOTE

- The digital Manual is not available while driving.
- Changing the language in the centre display may mean that some manual information is not compliant with national or local laws and regulations.

The support site includes information on logging in to the Polestar website and contact details, for example.

## Support on the Internet

Go to [support.polestar.com](https://support.polestar.com) to visit the site.

It contains support for e.g. in-car apps, functions and online services. Videos and step-by-step instructions explain different procedures, e.g. how to connect the car to a phone. Here there is also information about accessories and software adapted for your car model.

## Contact

Contact details for Polestar Support can be found on the support site.

For questions on using the car, the CONNECT button can be used to make contact with Polestar Assistance. An operator is available to answer 24 hours a day.

Other ways of contacting Polestar Support are to use the Polestar app or to phone up. Other contact channels include online forms and chat on the website.

## Hotline

Local

0800-051-7863

Other countries

+800-707 088 22

## Website

Create a personal Polestar ID and go to [polestar.com](https://polestar.com), where it is possible to get an overview of service, agreements and warranties, among other things. Here there is also informa-

>>

# Reading the Manual

tion about accessories and software adapted for your car model.

## Related information

- Contact Polestar (p. 14)
- Polestar ID (p. 14)

To help you get to know your new car, read the Manual before you drive it for the first time.

Reading the Manual is a way to become familiar with new functions, get advice on how to handle the car in different situations and learn how to make use of all the car's features. Please pay attention to the safety instructions and important prompts contained in the Manual. The different sections should be read in their entirety.

The intention of this Manual is to explain all possible functions, options and accessories included in a Polestar vehicle. It is not intended as an indication or guarantee that all of these features, functions and options are included in every vehicle. Some terminology used may not exactly match terminology used in sales, marketing and advertising materials.

Development work is constantly underway in order to improve our product. Modifications may mean that information, descriptions and illustrations in the Manual differ from the equipment in the car. We reserve the right to make modifications without prior notice.

© Polestar

## Options/accessories

In addition to standard equipment, the Manual also describes options (factory fitted equipment) and certain accessories (retrofitted extra equipment).

All, at the time of publication known, options and accessories are marked with an asterisk: .

The equipment described in the Manual is not available in all cars - they have different equipment depending on adaptations for the needs of different markets and national or local laws and regulations.

In the event of uncertainty over what is standard or an option/accessory, contact Polestar Support.

### Special texts

#### Decals

The car contains different types of decal which are designed to convey important information in a clear manner. The decals in the car have the following descending degree of importance for the warning/information.

#### Warning of personal injury

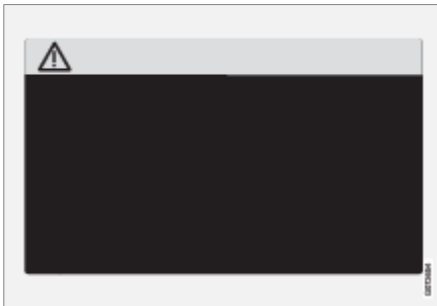

Black ISO symbols on yellow warning field, white text/image on black message field. Used to indicate the presence of danger which, if the warning is ignored, may result in serious personal injury or fatality.

#### Risk of property damage

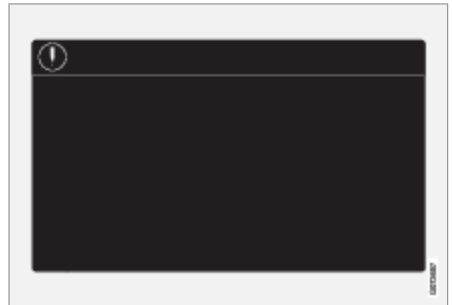

White ISO symbols and white text/image on black or blue warning field and message field. Used to indicate the presence of danger which, if the warning is ignored, may result in damage to property.

#### Information

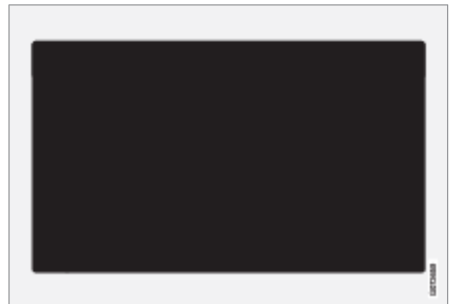

White ISO symbols and white text/image on black message field.

#### Illustrations and video clips

Illustrations and video clips used in the Manual are sometimes schematic and are intended to provide an overall picture or example of a cer-

tain function. They may deviate from the car's appearance depending on equipment level and market.

#### Related information

- Available information (p. 8)
- Polestar Support (p. 9)

### WARNING

Warning texts appear if there is a risk of injury.

### IMPORTANT

Important texts appear if there is a risk of damage.

### NOTE

- Information in the centre display for your car may differ from the information shown on the Polestar support site.
- Note texts give advice or tips that facilitate the use of e.g. features and functions.

### NOTE

- It is not intended that the decals illustrated in the Manual should be exact replicas of those in the car. They are included to show their approximate appearance and location in the car. The information that applies to your particular car is available on the respective decals for your car.

Section 02

—

Your Polestar

# Contact Polestar

Use the following contact information to contact Polestar.

Polestar HQ

Assar Gabrielssons Väg 9

SE-405 31 Gothenburg

Sweden

020-79 77 89

[polestar.com](http://polestar.com)

# Polestar ID

Polestar ID is a personal ID that gives access to various services via a single username and password.

One example of a service requiring a Polestar ID is when you want to check your car on your phone using the Polestar app.

A Polestar ID is created on the website, [polestar.com](http://polestar.com) or in the Polestar app.

## Related information

- [Creating a Polestar ID \(p. 15\)](#)
- [Problems logging in with Polestar ID \(p. 16\)](#)
- [Book service and repair \(p. 495\)](#)

## NOTE

- The services available may vary over time and depend on equipment level and market.
- If the username/password for a service (e.g. Polestar Connect) is changed, then it is also changed automatically for other services.

# Creating a Polestar ID

It is possible to create a Polestar ID in different ways.

## Create a Polestar ID with the Polestar app

It is possible to create a Polestar ID using the Polestar app.

1. Download the latest version of the Polestar app to your phone, via e.g. the App Store or Google Play.
2. Choose to create a Polestar ID.
3. The website for Polestar ID creation opens. Fill in the requested information.
4. Check the box to accept the terms and conditions.
5. Press the button to create a Polestar ID.
6. An email/SMS will be sent to the address/mobile number you entered. Follow the steps provided in the message to confirm.
  - > Your Polestar ID is now ready to be used.

## Creating a Polestar ID on the Polestar website

1. Go to [polestar.com](https://polestar.com)
2. Choose to create a Polestar ID.
3. The website for Polestar ID creation opens. Fill in the requested information.
4. Check the box to accept the terms and conditions.
5. Press the button to create a Polestar ID.
6. An email/SMS will be sent to the address/mobile number you entered. Follow the steps provided in the message to confirm.
  - > Your Polestar ID is now ready to be used.

## Related information

- Polestar ID (p. 14)
- Problems logging in with Polestar ID (p. 16)

# Problems logging in with Polestar ID

This article describes problems that may arise when logging in with Polestar ID. If you have forgotten your password or the username linked to your Polestar ID, for example.

## Common problems

Common problems and solutions when logging in with a Polestar ID are listed below.

### Forgotten your password

To reset your password, follow the instructions below:

Via the Polestar website

1. Go to [polestar.com](https://polestar.com)
2. Select Log in.
3. Select Forgotten password.
4. Enter the username for your Polestar ID (email address or mobile number).
  - > You will receive an email/SMS with a link which you can use to set a new password.

In the Polestar app.

1. Start the Polestar app.
2. Select "Log in"
3. Press "Forgotten password?" and follow the instructions.

### Login failure after creation of a new account

Sometimes there may be a delay in the process which can result in an account not being available directly after it has been created. Try again after 24 hours, and if the problem persists contact Polestar Support for more assistance.

### What is my Polestar ID (username)?

Your Polestar ID is either an email address or a mobile number.

### Unlock your Polestar ID

Your account will be locked after 5 failed attempts to log in. You can easily unlock your account by clicking on Forgotten password? in the login screen.

### Login failure after changing Polestar ID (username)

Make sure you have received a confirmation message by email/SMS when you confirm your new username. Once this has been done, you should be able to login with the new user name. If you did not receive the confirmation message (by email or SMS), your old username is probably still in place. Log in and try to change your username again.

### Login failure after changed password

Try to login with your previous password. If this is not successful, try to reset your password.

### Account registered to a different market

An account is registered to a specific market and cannot be moved to a different market. To be able to re-use the same username (email address or mobile number), we advise you to first delete your account for the old market and then create a new account for the new market.

### E-mail failure

If you did not receive a confirmation e-mail after registering, make sure that you entered a valid e-mail address and that the e-mail was not stopped by a spam filter. Try to register your e-mail address again.



# Environmental efficiency

## More help

Contact Polestar Support if you have not found a solution to a problem relating to Polestar ID and need further help.

## Related information

- Polestar ID (p. 14)
- Creating a Polestar ID (p. 15)

Polestar has undertaken to improve the environment by offering a product range that is clean and efficient and affects the environment as little as possible.

## Optimised drivetrain

Polestar has a drivetrain that is specifically designed to minimise pollution and maximise efficiency. These powertrains have been optimised for increased efficiency and reduced pollution.

## Improved environment, both inside and out

Polestar's environmental commitment also extends to the interior of the car, which is cleaned by the climate control system. An air filter in the air intake that stops pollen and dust, together with the air cleaning system in the car, is known as the Interior Air Quality System (IAQS) within Polestar. It also cleans the air in the interior of the car from hydrocarbons, ground-level ozone and nitrous oxides. The materials included in the fittings have been selected for their sustainability and have been tested to ensure that they do not give off strong odours or other pollution.

## Cooperation for a cleaner future

All Polestar cars meet strict international environmental requirements, such as the production plants (which hold accreditation to ISO 14001) and all Polestar partners and staff. This ensures compliance with environmental laws and regulations while also guaranteeing ongoing improvements.

## Related information

- Range for electric operation (p. 392)
- Start and switch off preconditioning (p. 194)

>>

# Connection and entertainment

- Air quality (p. 176)

The car has an intelligent interface and offers online connectivity with the digital world. An intuitive navigation structure makes it possible to receive relevant support, information and entertainment when it is necessary, without distracting the driver.

## Information when it is needed, where it is needed

The different displays in the car provide information at the right time. The information is shown in different locations based on how it should be prioritised by the driver.

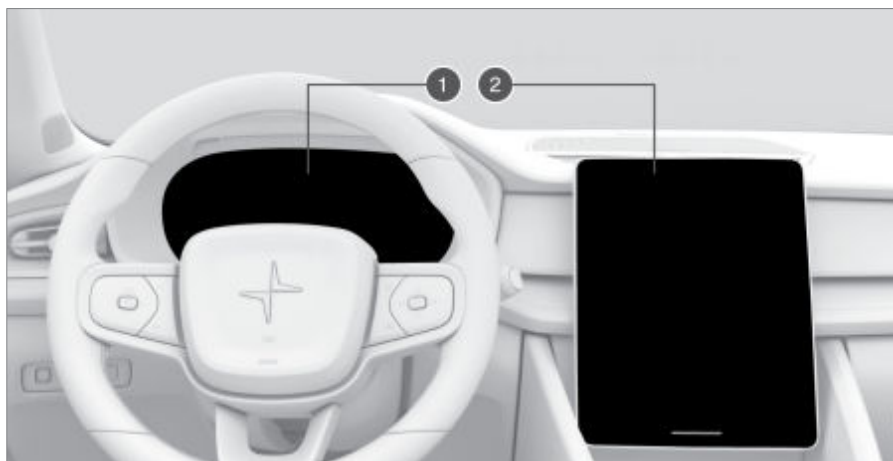

*Different types of information are shown in different displays depending on how the information should be prioritised.*

- ① The driver display shows information on speed, road sign information, warning and control symbols and information on the battery, for example. The driver display can also show incoming calls or information on what song is playing. The display is operated via the two steering wheel keypads.
- ② Many of the car's primary functions are controlled from the centre display, e.g. the climate control system, the entertainment system and the settings for the seats. The centre display also shows information on navigation and road sign information, for example. The information that is shown in the centre display can be acted on by the driver or someone else in the car when the opportunity arises.

#### Voice control system

The voice control system can be used without the driver needing to take his/her hands off the steering wheel. The system can understand natural speech. Use voice control to, for example, play back a song, call someone, increase the temperature or read out a text message.

#### Related information

- Driver display (p. 72)

- Overview of centre display (p. 105)
- Voice control with Google Assistant (p. 124)

#### NOTE

Wearing gloves may restrict or impede touchscreen response.

# Recording data

As part of Polestar's safety and quality assurance, certain information about the vehicle's operation, functionality and incidents are recorded in the car.

This vehicle is equipped with an "Event Data Recorder" (EDR). Its primary purpose is to register and record data related to traffic accidents or collision-like situations, such as times when the airbag deploys or the vehicle strikes an obstacle in the road. The data is recorded in order to increase understanding of how vehicle systems work in these types of situations. The EDR is designed to record data related to vehicle dynamics and safety systems for a short time, usually 30 seconds or less.

The EDR in this vehicle is designed to record data related to the following in the event of traffic accidents or collision-like situations:

- How the various systems in the car worked
- Whether the driver and passenger seatbelts were fastened/tensioned
- The driver's use of the accelerator or brake pedal
- The travel speed of the vehicle

This can help us understand the circumstances in which traffic accidents, injuries and damage occur. The EDR only records data when a non-trivial collision situation occurs. The EDR does not record any data during normal driving conditions. Similarly, the system never registers who is driving the vehicle or the geographic location of the accident or near-miss situation. However, other parties, such as the police, could use the recorded data in combination with the type of personally identifiable information routinely collected after a traffic accident. Special equipment and access to either the vehicle or the EDR is required to be able to interpret the registered data.

In addition to the EDR, the car is equipped with a number of computers designed to continually check and monitor the function of the car. They can record data during normal driving conditions, but in particular, register faults affecting the vehicle's operation and functionality, or upon activation of the vehicle's active driver support function.

Some of the recorded data is required to enable service and maintenance technicians to diagnose and remedy any faults that occurred in the vehicle. The registered information is also needed to enable Polestar to satisfy legal requirements laid out in laws and by government authorities. Information registered in the vehicle is stored in its computer until the vehicle is serviced or repaired.

In addition to the above, the registered information can be used in aggregate form for research and product development with the aim of continuously improving the safety and quality of Polestar cars.

Polestar will not contribute to the above-described information being disclosed to third parties without the vehicle owner's consent. To comply with national legislation and regulations, Polestar may be forced to disclose information of this nature to the police or other authorities who may assert a legal right to access such. Special technical equipment which Polestar and workshops that have entered into agreements with Polestar have access to is required to be able to read and interpret the recorded data. Polestar is responsible for ensuring that the information, which is transferred to Polestar during servicing and maintenance, is securely stored and managed and that its management complies with relevant legal requirements. Contact Polestar Support for further information.

# Approval of terms and conditions and data collection

## Related information

- Contact Polestar (p. 14)

Messages about different terms and conditions and data collection can be shown in the centre display. Collection of data takes place to provide better car, safety and app functions, for example.

The first time you use your car, a guide opens in the centre display to assist you to make various settings. In connection with the guide, you are also prompted to give your consent to different types of terms and conditions and the collection of information.

Prompts to give consent can also be shown in the event of, for example:

- First-time use of apps and services
- New user profiles
- Logging out from and deleting user profiles
- Change of ownership
- Resetting the settings

## Related information

- User profiles (p. 118)
- Resetting user data (p. 118)

# Important information on accessories and auxiliary equipment

The incorrect connection and installation of accessories and extra equipment can negatively affect the car's electronic system.

Polestar strongly recommends that Polestar owners should only install genuine accessories approved by Polestar, and that installation of accessories is only carried out by trained and qualified service technicians. Certain accessories only function when associated software is installed in the car's computer system. Contact Polestar Support for more information.

The equipment described in the Manual is not available in all cars - they have different equipment depending on adaptations for the needs of different markets and national or local laws and regulations.

Options or accessories described in this Manual are marked with an asterisk. In the event of uncertainty over what is standard or an option/ accessory, contact Polestar Support.

## Related information

- Installation of accessories (p. 23)
- Connection of equipment to the car's diagnostic socket (p. 23)
- Reading the Manual (p. 10)

## WARNING

The driver always bears the ultimate responsibility that the car is used safely and that laws and regulations in force are followed.

It is also important that the car has maintenance and service according to Polestar's recommendations, the manual information and the Status and Warranty book.

## Installation of accessories

Contact Polestar Support for more information on installation of accessories.

- Always seek the advice of a trained and qualified Polestar service technician before installing any accessories in or on your car.
- Accessories that are not approved by Polestar may not have been specifically tested for use with your car.
- Some of the car's performance or safety systems can be negatively affected if you install accessories that have not been tested by Polestar, or if you permit someone without experience of the car to install accessories.
- Damage that is caused by accessories installed in a non-approved or incorrect way is not covered by any new car warranty. More warranty information can be found in the Status and Warranty booklet. Polestar does not accept any liability for deaths, personal injury or costs arising as a result of the installation of accessories.

### Related information

- Important information on accessories and auxiliary equipment (p. 22)

## Connection of equipment to the car's diagnostic socket

Incorrect connection and installation of software or diagnostic tools may have a negative effect on the car's electronic system.

Polestar strongly recommends that Polestar owners should only install genuine accessories approved by Polestar. Contact Polestar Support for more information on installation of accessories. Certain accessories only function when associated software is installed in the car's computer system.

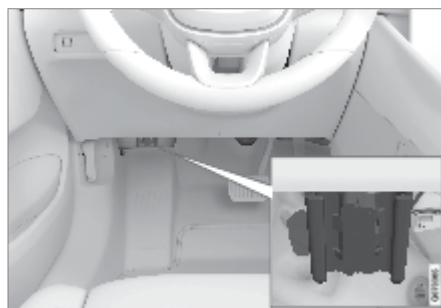

*Data link connector (On-board Diagnostic, OBDII) is under the instrument panel on the driver's side.*

### Related information

- Important information on accessories and auxiliary equipment (p. 22)

### NOTE

Polestar accepts no liability for the consequences if unauthorised equipment is connected to the On-board Diagnostic socket (OBDII). Contact Polestar Support for more information.

## Showing the car's identification number

If you get in touch with Polestar Support with regard to Polestar Connect subscriptions, for example, the car's identification number (VIN<sup>1</sup>) is needed.

1. Open the app view in the centre display.
2. Tap on settings  in the bottom of the display.
3. Continue to System, About and then VIN number.
  - > The car's identification number is shown.

Another way of finding VIN is:

- on first page in Status and Warranty
- in the car's registration document
- look on the dashboard through the car's windscreen.

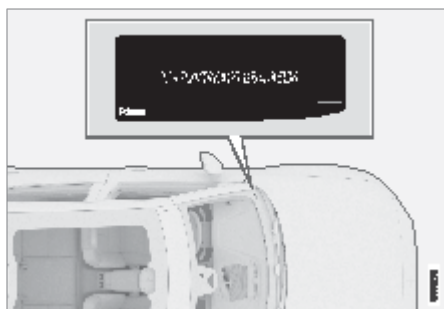

### Related information

- Polestar Connect (p. 432)

## Change of market when importing or relocating

If you import a car or move to a different country with your car, you should contact Polestar Support to get help with registering your car in the new country. If you do not do this then you may experience that apps, the Polestar app, software downloads and other online services are affected and do not work correctly.

### Creating a new Polestar ID in your new home market

When you relocate to another country you should create a Polestar ID in the new country. If you have already created a Polestar ID in another country and want to use the same email address, you first need to delete your Polestar ID in the region you originally created it. Alternatively, you can create a new Polestar ID using another e-mail address.

### Download the Polestar app

Download the Polestar app from the country in which the car will be used, then link the app to your car.

### Related information

- Polestar ID (p. 14)
- Creating a Polestar ID (p. 15)
- Polestar Connect (p. 432)

## NOTE

Contact Polestar support if you have imported or relocated with your car to a new country.

Available services may vary depending on market.



# Driver distraction

The driver is responsible for doing everything possible to ensure the safety of themselves, their passengers and other road users. Part of this responsibility is avoiding distractions such as carrying out an activity that is not related to operating the car in a driving environment.

Your new Polestar is, or can be, equipped with content-rich entertainment and communications systems. This could be mobile phones with handsfree, navigation systems and audio systems with lots of functions. You may also have other portable electronic devices for your own convenience. Used correctly, in a safe way they can enrich the driving experience. If they are used in the wrong way they could distract you.

We wish to give the following warnings regarding such systems, to indicate Polestar's concern for your safety. Never use a device or function in the car in such a way that it will distract you from the task of driving safely. Distractions can lead to serious accidents. Apart from these general warnings, we offer the following advice regarding the new functions that may be in the car:

## Related information

- Audio and media (p. 414)
- Google Maps (p. 442)

## WARNING

- Never use a hand-held mobile phone while driving. In some areas it is forbidden for the driver to use a mobile phone while the car is moving.
- If the car is equipped with a navigation system you must only set and change the itinerary when the car is parked.
- Never program the audio system while the car is moving. Program the radio's presets when the car is parked and then use the programmed presets for faster and simpler use of the radio.
- Never use laptops or hand-held computers while the car is moving.



Section 03

—

Safety

# Safety

The vehicle is equipped with several safety systems that work together to protect the vehicle's driver and passengers in the event of an accident.

The car is equipped with a number of sensors that react in the event of an accident and activate different safety systems, such as different types of airbags and seatbelt tensioners. Depending on the specific accident situation, such as collisions at different angles, roll-over or driving off the road, the systems react in different ways to provide good protection.

There are also mechanical safety systems such as Whiplash Protection System. The car is also constructed so that a large part of the force of a collision is distributed to beams, pillars, floor, roof and other parts of the body.

The car's safety mode may be activated after a collision if an important function in the car has been damaged.

## Warning symbol in driver display



The warning symbol is illuminated in the driver display when the car is started. The symbol is extinguished after approximately 6 seconds if the car's safety system is fault-free.



If the specific warning symbol is broken then the general warning symbol is illuminated instead and the driver display shows the same message.

## Related information

- Safety during pregnancy (p. 29)
- Seatbelts (p. 32)
- Airbags (p. 38)
- Whiplash Protection System (p. 30)

- Pedestrian Protection System (p. 31)
- Safety mode (p. 47)
- Child safety (p. 49)

## WARNING

- If the warning symbol remains illuminated or is switched on during driving and the message Drive to workshop SRS airbag Service urgent is shown in the driver display, it means that part of one of the safety systems does not have full functionality. Contact Polestar Support.
- Never modify or repair the car's various safety systems yourself. Defective work in one of the systems can cause malfunction and result in serious personal injury. Contact Polestar Support.

# Safety during pregnancy

It is important that the seatbelt is used correctly during pregnancy, and that pregnant drivers adjust their seating position.

- Seatbelts (p. 32)
- Power front seat (p. 160)

## Seatbelt

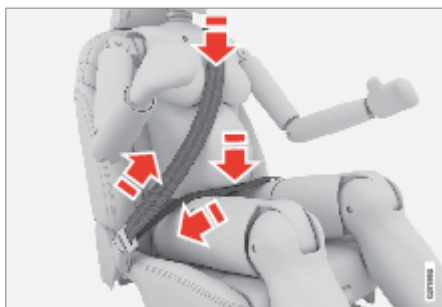

The diagonal section should wrap over the shoulder then be routed between the breasts and to the side of the abdomen.

The lap section should lay flat over the thighs and as low as possible under the abdomen. – It must never be allowed to ride upward. Remove the slack from the seatbelt and ensure that it fits as close to the body as possible. In addition, check that there are no twists in the seatbelt.

## Seating position

As the pregnancy progresses, pregnant drivers must adjust the seat and steering wheel such that they can easily maintain control of the vehicle as they drive (which means that they must be able to easily operate the foot pedals and steering wheel). The aim should be to position the seat with as large a distance as possible between abdomen and steering wheel.

## Related information

- Safety (p. 28)

# Whiplash Protection System

Whiplash Protection System (WHIPS) reduces the risk of whiplash injuries. The system consists of energy absorbing backrests and seat cushion, as well as a specially designed head restraint in the front seats.

WHIPS is deployed in the event of a rear-end collision, where the angle and speed of the collision and the nature of the colliding vehicle all have an influence.

When WHIPS is deployed, the front seat backrests are lowered backward and the seat cushions move downward to change the seating position of the driver and front seat passenger. Its movement helps to absorb some of the forces that can arise and cause whiplash.

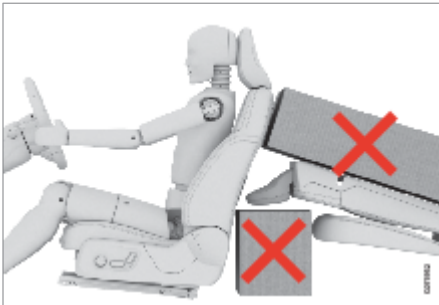

*Do not leave any objects on the floor behind or under the front seats or in the rear seat that may prevent WHIPS from functioning.*

## Seating position

For good protection from WHIPS the driver and passenger must have the correct seating position and make sure that the system's function is not obstructed.

Set the correct seating position in the front seat before driving starts.

Driver and front seat passenger should sit in the centre of the seat with as little space as possible between the head and the head restraint.

## WHIPS and child seats

The protection provided by the car to children seated in a child seat or on a booster cushion is not diminished by WHIPS.

## Related information

- Safety (p. 28)
- Power front seat (p. 160)
- Rear Collision Warning\* (p. 305)

## WARNING

- WHIPS is a supplement to the seatbelts. Always use a seatbelt.
- Never modify or repair the seat or WHIPS yourself. Contact Polestar Support.

If the front seats have been subjected to a major load, such as in conjunction with a collision, the seats must be replaced. Some of the seats' protective properties may have been lost even if they do not appear damaged.

- Do not squeeze rigid objects between the rear seat cushion and the front seat's backrest.

If a backrest in the rear seat is lowered then any load must be secured to prevent it from sliding up to the front seat backrest in the event of a collision.

# Pedestrian Protection System

## WARNING

- If a rear-facing child seat is being used in the rear seat, the corresponding front seat must be moved forwards so that it is not in contact with the child seat.

The Pedestrian Protection System (PPS) is a system which, in certain frontal collisions, contributes to mitigating a pedestrian's impact with the car.

In certain frontal collisions with a pedestrian, the sensors in the front of the car react and the system is activated.

When PPS is activated, the following occur:

- The bonnet is raised and pushed slightly back.
- An automatic alarm is sent via Polestar Connect.

The sensors are active at a speed of approx. 25-50 km/h (15-30 mph).

The sensors are designed to detect a collision with an object that has similar properties to those of the human leg.

### Symbols in the driver display

Symbol	Specification
	PPS has been activated, or a fault has occurred in the system. Follow the recommendation given.

### Related information

- Safety (p. 28)
- Automatic collision alarm with Polestar Connect (p. 433)

# Seatbelts

## WARNING

- Do not fit any accessories or change anything in the front. Incorrect intervention at the front may cause incorrect function in the system and lead to serious injury and damage to the car.

Polestar recommends that genuine wiper arms are used and that only genuine parts are used for them.

- Never modify or repair the system yourself. Contact Polestar Support. Defective work in the system could cause malfunction and result in serious personal injury.
- Contact Polestar Support in the event of any damage to the front of the car so as to ensure that the system is intact.

## NOTE

There may be objects in the traffic environment that prompt a signal to the sensors that is similar to a collision with a pedestrian. It is possible that the system will be activated in the event of a collision with such an object.

Heavy braking can have serious consequences if the seatbelts are not used.

It is important that the seatbelt lies against the body so it can provide good protection. Do not lean the backrest too far back. The seatbelt is designed to protect in a normal seating position.

## Related information

- Safety (p. 28)
- Seatbelt tensioner (p. 35)
- Putting on and taking off seatbelts (p. 33)
- Door and seatbelt reminder (p. 37)

## WARNING

- Remember not to clip or hook the seatbelt to hooks or other interior fittings, as this prevents the belt from tightening properly.
- The seatbelts and airbags interact. If a seatbelt is not used or is used incorrectly, this may diminish the protection provided by the airbag in the event of a collision.



## Putting on and taking off seatbelts

### WARNING

- Never modify or repair the seatbelts yourself. Contact Polestar Support.

If the seatbelt has been subjected to a major load, such as in conjunction with a collision, the entire seatbelt must be replaced. Some of the seatbelt's protective properties may have been lost even if the seatbelt does not appear damaged. The seatbelt must also be replaced if it shows signs of wear or damage. The new seatbelt must be type-approved and designed for installation at the same location as the replaced seatbelt.

Make sure that all passengers have fastened their seatbelts before starting to drive.

#### Putting on seatbelts

1. Pull out the seatbelt slowly and make sure it is not twisted or damaged.
2. Lock the belt by inserting the locking tab in the intended buckle.
  - > A loud "click" indicates that the belt has locked.

3. Position the belt as high as possible without it chafing against your throat.

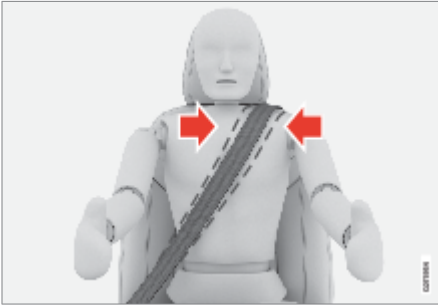

*The seatbelt must pass over the shoulder (not down over the arm).*

In the front seats, the height of the belt can be adjusted.

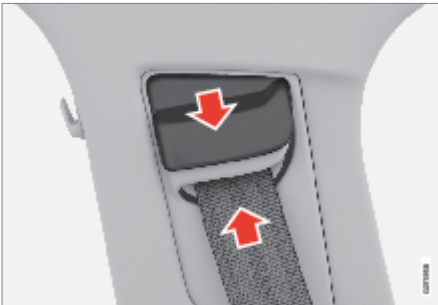

Push the seatbelt bracket together and move the belt up or down.

4. Tension the hip strap over the lap by pulling the diagonal shoulder belt up towards the shoulder.

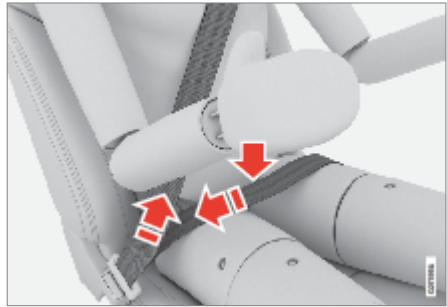

*The hip strap must be positioned low down (not over the abdomen).*

#### Taking off seatbelts

1. Press the red button on the seatbelt buckle and then let the belt retract.
2. If the seatbelt does not retract fully, feed it in by hand so that it does not hang loose.

#### Related information

- Seatbelts (p. 32)
- Seatbelt tensioner (p. 35)
- Door and seatbelt reminder (p. 37)
- Rear seat (p. 166)

# Seatbelt tensioner

## WARNING

- Always insert the tongue of the seatbelt into the buckle on the correct side. The seatbelts and buckles would otherwise possibly not function as intended in the event of a collision. There is a risk of serious injury.
- Each seatbelt is designed for only one person.
- Remember not to clip or hook the seatbelt to hooks or other interior fittings, as this prevents the belt from tightening properly.
- Do not make any damages on seatbelts nor insert any foreign objects into a buckle. The seatbelts and buckles would then possibly not function as intended in the event of a collision. There is a risk of serious injury.

## NOTE

The seatbelt is equipped with an inertia reel that is locked in the following situations:

- if the belt is extended too quickly.
- during braking and acceleration.
- if the car leans heavily.
- when driving in bends.

The car is fitted with standard seatbelt tensioners and electric seatbelt tensioners that can tension the seatbelts in critical situations and collisions.

### Standard seatbelt tensioner

The seatbelts in the front seat and the outer seats in the rear seat are equipped with standard belt pretensioners.

The seatbelt tensioner tensions the seatbelt in the event of a collision with sufficient force in order to more effectively restrain the occupant.

### Electric belt pretensioners

The driver and front passenger seatbelts are equipped with an electric seatbelt tensioner.

The seatbelt tensioners work together and can be activated together with the driver support systems of assistance at risk of collision and Rear Collision Warning. In critical situations, such as panic braking, driving off the road (e.g. the car rolls into a ditch, lifts off the ground or hits something in the terrain), skidding, or risk of collision, the seatbelt can be tensioned by the seatbelt tensioner's electric motor.

The electric seatbelt tensioner helps to adjust the occupant to a better position, reducing the risk of striking the car's interior and improving the effect of safety systems, such as the car's airbags.

When the critical situation has come to an end, the seatbelt and the electric seatbelt pretensioner are restored automatically, but they can also be restored manually.

### Related information

- Seatbelts (p. 32)
- Putting on and taking off seatbelts (p. 33)

>>

# Resetting the electric seatbelt tensioner

- Resetting the electric seatbelt tensioner\* (p. 36)
- Activating and deactivating passenger airbag\* (p. 42)

## WARNING

Never modify or repair the seatbelts yourself. Contact Polestar Support.

If the seatbelt has been subjected to a major load, such as in conjunction with a collision, the entire seatbelt must be replaced. Some of the seatbelt's protective properties may have been lost even if the seatbelt does not appear damaged. The seatbelt must also be replaced if it shows signs of wear or damage. The new seatbelt must be type-approved and designed for installation at the same location as the replaced seatbelt.

## IMPORTANT

If the passenger airbag is deactivated, the electric seatbelt tensioner on the passenger side will also be deactivated.

The electric seatbelt tensioner is designed to be reset automatically, but the seatbelt tensioner can be reset manually if the belt remains extended.

1. Stop the car at a safe place.
2. Unfasten the seatbelt and then refasten it.
  - > The seatbelt and electric seatbelt tensioner are reset.

## Related information

- Seatbelt tensioner (p. 35)
- Seatbelts (p. 32)

## WARNING

Never modify or repair the seatbelts yourself. Contact Polestar Support.

If the seatbelt has been subjected to a major load, such as in conjunction with a collision, the entire seatbelt must be replaced. Some of the seatbelt's protective properties may have been lost even if the seatbelt does not appear damaged. The seatbelt must also be replaced if it shows signs of wear or damage. The new seatbelt must be type-approved and designed for installation at the same location as the replaced seatbelt.

# Door and seatbelt reminder

The system reminds unbelted occupants to wear a seatbelt, and also warns about an open door, bonnet or lid.

## Information in the driver display



Graphics in the driver display with different types of warnings. The warning colour on the door and tailgate is dependent on the speed of the car.

The driver display graphic shows the status for the seatbelts, bonnet, tailgate and doors.

The graphic can be acknowledged by pressing the O button on the right-hand steering wheel keypad.



Directly when the graphic is acknowledged, or after a while if the graphic is not acknowledged, it can change over to a smaller format that is shown at the top of the driver display.

## Seatbelt reminder



Visual reminder in the roof console.

A visual reminder is given in the roof console and by means of the warning symbol in the driver display.

Type of visual reminder (fixed or flashing) and acoustic reminder (different signals) depends on speed as well as driving time and mileage.

Reminder or information by means of a graphic is given in different ways depending on seatbelt position.

For the front seat and rear seat outer seats, the following is given:

- reminder in the event of driver or passengers not wearing a seatbelt while driving
- reminder if a seatbelt is unbuckled while driving
- information on which seatbelts are or are not buckled.

For the rear seat centre seat, the following is given:

- reminder if the seatbelt is unbuckled while driving

# Airbags

- information on whether or not the seatbelt is buckled.

## Reminder for doors, bonnet, and hatch

If the bonnet, tailgate or any door is not closed properly, the graphic in the driver display shows what is open. Stop the car in a safe place as soon as possible and close the source of the warning.



If the car is driven at a speed lower than approx. 10 km/h (6 mph) then the driver display's information symbol illuminates.



If the car is driven at a speed higher than approx. 10 km/h (6 mph) then the driver display's warning symbol illuminates.

## Related information

- Seatbelts (p. 32)
- Putting on and taking off seatbelts (p. 33)

## NOTE

- The seatbelts built into child restraint systems are not included in the seatbelt reminder system.
- If the seatbelt reminder is activated by a child seat on an outer seat in the rear seat that is not attached with the seatbelt, the reminder can be acknowledged, or the seatbelt can be attached.

The car is equipped with airbags and inflatable curtains for driver and passengers.

## Deployed airbags

If any of the airbags have deployed, the following is recommended:

- Recovering the car. Contact Polestar Support. Do not drive with deployed airbags.
- Contact Polestar Support for replacement of components in the car's safety system.
- Always contact a doctor.

## Related information

- Safety (p. 28)
- Driver airbag (p. 39)
- Passenger airbag (p. 40)
- Outer side airbags (p. 44)
- Inflatable curtains (p. 46)

## WARNING

- The airbag system's control module is located in the centre console. If the centre console is drenched with water or other liquid, disconnect the cables to the starter battery. Do not attempt to start the car since the airbags may deploy. Recovering the car. Contact Polestar Support.

# Driver airbag

## WARNING

- Never drive with deployed airbags. They can make steering difficult. Other safety systems may also be damaged. The smoke and dust created when the airbags are deployed can cause skin and eye irritation/injury after intensive exposure. In case of irritation, wash with cold water. The rapid deployment sequence and airbag fabric may cause friction and skin burns.

## NOTE

The detectors react differently depending on the nature of the collision and whether or not the seatbelts are fastened. Applies to all belt positions.

It is therefore possible that only one (or none) of the airbags may inflate in a collision. The detectors sense the force of the collision on the vehicle and the action is adapted accordingly so that none, one or more airbags are deployed.

As a supplement to the seatbelt, the car is equipped with a driver airbag.



*Driver side front seat airbag.*

In the event of a frontal collision, the airbag helps to protect the head, neck, face and chest of the driver as well as the knees and legs.

A sufficiently violent collision trips the sensors and the airbag is inflated. The airbag cushions the initial collision impact for the occupant. The airbag deflates when compressed by the collision. When this occurs, smoke escapes into the car. This is completely normal. The entire process, including inflation and deflation of the airbag, occurs within tenths of a second.

### Driver airbag location

This airbag is fitted into the centre of the steering wheel. The steering wheel is marked AIRBAG.

### Related information

- Airbags (p. 38)
- Passenger airbag (p. 40)

# Passenger airbag

## WARNING

- The seatbelts and airbags interact. If the belt is not used or is used incorrectly, this may diminish the protection provided by the airbag in the event of a collision.

To minimise the risk of injury if the airbag deploys, passengers must sit as upright as possible with their feet on the floor and backs against the backrest.

- Contact Polestar Support for repairs. Defective work in the airbag system could cause malfunction and result in serious personal injury.

As a supplement to the seatbelts, the vehicle is equipped with an airbag on the passenger side in the front seat.



*Passenger side front airbag.*

In the event of a frontal collision, the airbag helps to protect the head, neck, face and chest of the passenger as well as the knees and legs.

A sufficiently violent collision trips the sensors and the airbag is inflated. The airbag cushions the initial collision impact for the occupant. The airbag deflates when compressed by the collision. When this occurs, smoke escapes into the car. This is completely normal. The entire process, including inflation and deflation of the airbag, occurs within tenths of a second.

### Passenger airbag location

The airbag is folded up into a compartment above the glovebox. Its cover panel is marked AIRBAG.



## Label for passenger airbag



*Label on the passenger side's sun visor.*

The warning label for the passenger airbag is positioned as shown above.

### Related information

- Airbags (p. 38)
- Driver airbag (p. 39)
- Activating and deactivating passenger airbag\* (p. 42)

## WARNING

- The seatbelts and airbags interact. If the belt is not used or is used incorrectly, this may diminish the protection provided by the airbag in the event of a collision.

To minimise the risk of injury if the airbag deploys, passengers must sit as upright as possible with their feet on the floor and backs against the backrest.

## WARNING

- Contact Polestar Support for repairs. Defective work in the airbag system could cause malfunction and result in serious personal injury.
- Do not put objects in front of or above the dashboard where the passenger airbag is located.
- If the car is not equipped with a switch to activate/deactivate the passenger airbag, the airbag will always be activated.
- Never allow anybody to stand or sit in front of the front passenger seat.

Never use a rear-facing child seat on the front passenger seat if the airbag is activated.

Front-facing passengers (children and adults) must never sit on the front passenger seat if the passenger airbag is deactivated.

Failure to follow the advice given above can endanger life or lead to serious personal injury.

# Activating and deactivating passenger airbag

The passenger airbag can be deactivated if the car is equipped with a switch, Passenger Airbag Cut Off Switch (PACOS).

The switch for the passenger airbag is located on the passenger end of the instrument panel and is accessible when the passenger door is open.

Check that the switch is in the required position.

## Activating passenger airbag



- A** ON - the airbag is activated and all front-facing passengers (children and adults) can sit safely on the passenger seat.
- B** OFF - The airbag is deactivated and children in rear-facing child seats can sit safely on the passenger seat.

- 1** Pull the switch outward and turn from OFF to ON.
  - > The driver display shows the message Passenger airbag on.
- 2.** Confirm the message by pressing the right-hand steering wheel keypad's O button.

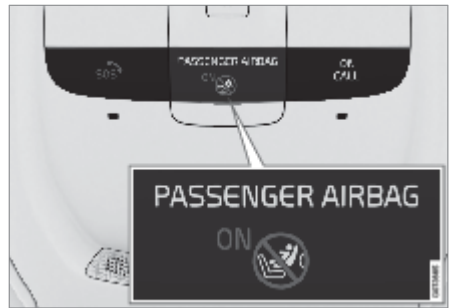

- > A text message and a warning symbol in the roof console indicate that the airbag for the front passenger seat is activated.

## Deactivating passenger airbag



1 Pull the switch outward and turn from ON to OFF.

> The driver display shows the message Passenger airbag off.

2. Confirm the message by pressing the right-hand steering wheel keypad's O button.



> A text message and a symbol in the roof console indicate that the airbag for the front passenger seat is deactivated.

### Related information

- Seatbelt tensioner (p. 35)
- Child seats (p. 49)

## WARNING

- If the car is not equipped with a switch to activate/deactivate the passenger airbag, the airbag will always be activated.
- Never use a rear-facing child seat on the front passenger seat when the airbag is activated.

The passenger airbag must always be activated when front-facing passengers (children and adults) are sitting in the front passenger seat.

Failure to follow the advice given above can endanger life or lead to serious personal injury.

- Front-facing passengers (children and adults) must never sit on the passenger seat when the airbag is deactivated.

Failure to follow the advice given above can endanger life or lead to serious personal injury.

## IMPORTANT

If the passenger airbag is deactivated, the electric seatbelt tensioner on the passenger side will also be deactivated.

## Outer side airbags

### NOTE

- If the passenger airbag has been activated/deactivated before the car has been started, the message is shown in the driver display, as well as the following indication in the roof console, approximately 6 seconds after the car has been started.
- If the passenger airbag has been activated/deactivated before the car has been started, the message is shown in the driver display, as well as the following indication in the roof console, approximately 6 seconds after the car has been started.

The outer side airbags on the driver's and passenger seats act to protect the chest and hips in the event of a collision.



The outer side airbags are fitted in the outer backrest frames of the front seats and help to protect the driver and passengers in the front seat.

A sufficiently violent collision trips the sensors and the outer side airbags are inflated. The airbag inflates between the occupant and the door panel and thereby cushions the initial impact. The airbag deflates when compressed by the collision. The outer side airbag is normally inflated only for the seat on the side of the collision.

### Side airbags and child seats

The protection provided by the car to children seated in a child seat or on a booster cushion is not diminished by the side airbag.

### Related information

- Airbags (p. 38)

## Interior side airbags

### WARNING

- Contact Polestar Support for repairs. Defective work in the side airbag system could cause malfunction and result in serious personal injury.
- Do not put objects in the area between the outside of the seat and the door panel, since this area is required by the side airbag.

Polestar recommends the use only of car seat covers approved by Polestar. Other seat covers may impede the operation of the side airbags.

- Side airbags are a supplement the seatbelts. Always use a seatbelt.

The interior side airbags on the driver's and passenger seats act to protect the head, chest and hips in the event of a collision.



The interior side airbags are fitted in the inner backrest frames of the front seats and help to protect the driver and passengers in the front seat. The seat is marked AIRBAG.

A sufficiently violent collision trips the sensors and the interior side airbags are inflated. The airbag inflates between the occupant and the tunnel console and thereby cushions the initial impact. The interior side airbag is normally inflated only for the seat on the opposite side to the collision.

### Side airbags and child seats

The protection provided by the car to children seated in a child seat or on a booster cushion is not diminished by the side airbag.

### Related information

- Airbags (p. 38)

## Inflatable curtains

### WARNING

- Contact Polestar Support for repairs. Defective work in the side airbag system could cause malfunction and result in serious personal injury.
- Do not put objects in the area between the inside of the seat and the tunnel console, since this area is required by the side airbag.

Polestar recommends the use only of car seat covers approved by Polestar. Other seat covers may impede the operation of the side airbags.

- Side airbags are a supplement the seatbelts. Always use a seatbelt.

The inflatable curtain, Inflatable Curtain (IC), helps to prevent the driver and passengers from striking their heads on the inside of the car during a collision.

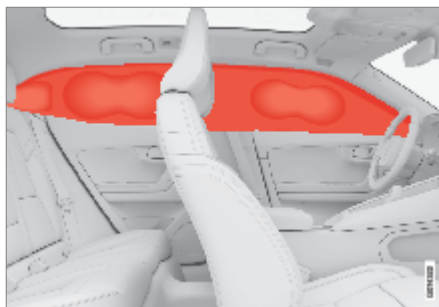

The inflatable curtain is mounted along both sides of the headlining and helps protect the driver and outer seat passengers of the car. The panels are labelled with IC AIRBAG.

A sufficiently violent collision trips the sensors and the inflatable curtain is inflated.

### Related information

- Airbags (p. 38)

### WARNING

- Contact Polestar Support for repairs. Defective work in the inflatable curtain system can cause malfunction and result in serious personal injury.

# Safety mode

## WARNING

- Never hang or attach heavy items onto the handles in the roof. The hooks are only designed for light coats and jackets (not for solid objects such as umbrellas).

Do not screw or install anything onto the car's headlining, door pillars or side panels. This could compromise the intended protection. Polestar recommends only using Polestar genuine parts that are approved for fitting within these areas.

- Leave 10 cm (4 inches) space between the load and the side windows if the car is loaded to above the top edge of the door windows. Otherwise, the intended protection of the inflatable curtain, which is concealed in the headlining, may be compromised.
- The inflatable curtain is a supplement to the seatbelts. Always use a seatbelt.

Safety mode is a protective state that is triggered when a collision may have damaged any of the car's vital functions, such as the high voltage system, sensors for any of the safety systems, or the brake system.

If the car has been in a collision, the message **Safety mode See Manual** may be shown on the driver display with a warning symbol as long as the display is not damaged and the car's electrical system is still in working order. This message means that the car has reduced functionality.

If the car is in safety mode, it is possible to attempt to reset the system in order to start and move the car for a short distance, if in a dangerous traffic situation for example.

### Related information

- Safety (p. 28)
- Starting and moving the car after safety mode (p. 48)
- Recovery (p. 407)

## WARNING

- Never attempt to repair your car or reset the electronics yourself if the car has been in safety mode. This could result in personal injury or the car not functioning as normal. Contact Polestar Support for help with completing the check and restoring the car to normal status after Safety mode See Manual has been displayed.
- If the car is in safety mode it must not be towed. It must be transported from its location. Contact Polestar Support.

# Starting and moving the car after safety mode

If the car is in safety mode, it is possible to attempt to reset the system in order to start and move the car for a short distance, if in a dangerous traffic situation for example.

## Reset and start the car after safety mode

1. Check the general damage situation of the car.  
If there is only minor damage, starting can be attempted.
2. Switch off the car manually.
3. Then try to start the car.
  - > The car's electronics carry out a systems check and then try to resume normal status. The driver display shows the message Car start System check, wait during this time. This can take up to one minute.
4. Then try to start the car again when the message Car start System check, wait is no longer shown in the driver's display.

## Moving the car after safety mode

1. If the driver display shows the message The car is now in normal mode after a start attempt, the car can be carefully moved if standing in a dangerous position.
2. Do not move the car further than necessary.

## Related information

- Safety mode (p. 47)
- Starting the car (p. 372)
- Switching off the car (p. 373)
- Recovery (p. 407)

## WARNING

If the car is in safety mode it must not be towed. It must be transported from its location. Contact Polestar Support.

## IMPORTANT

If the message Safety mode See Manual is still shown on the display the car must not be driven or towed but a vehicle recovery service must then be used instead. Even if the car appears to be drivable, hidden damage may make the car impossible to control once moving.



# Child safety

Children must always sit secure while travelling in the car.

The equipment that should be used is selected taking account of the weight and size of the child.

Polestar recommends that children travel in a rear-facing child seat until as late an age as possible, at least until 4 years of age, and then in a front-facing child seat until the child is 140 cm (4 feet 7 inches) tall.

Children of all ages and sizes must always sit correctly secured in the car. Never allow a child to sit on the knee of a passenger.

## Related information

- Safety (p. 28)
- Child seats (p. 49)
- Activating and deactivating the child lock (p. 207)

## NOTE

- Legal provisions about the type of child seat that must be used for children of different ages and heights vary from country to country. Check what does apply.
- When using child safety equipment, it is important to read the installation instructions included.

In the event of questions when fitting child safety equipment, contact the manufacturer for clearer instructions.

# Child seats

Suitable child seats should always be used when children are travelling in the car.

Children should sit comfortably and safely. Make sure that the child seat is positioned, mounted and used correctly.

Look in the installation instructions for the child seat for the correct fitting.

## Related information

- Child safety (p. 49)
- Upper mounting points for child seats (p. 50)
- Lower mounting points for child seats (p. 51)
- i-Size/ISOFIX mounting points for child seats (p. 52)
- Child seat positioning (p. 53)
- Activating and deactivating passenger air-bag\* (p. 42)

## NOTE

- When using child safety equipment, it is important to read the installation instructions included.

In the event of questions when fitting child safety equipment, contact the manufacturer for clearer instructions.

- Never leave a child seat loose in the car. Always secure it according to the instructions for the child seat, even when it is not in use.
- Long-term installation and use of child seats may cause wear and tear on the car's fittings.

# Upper mounting points for child seats

The car is equipped with upper mounting points for child seats in the front seat and the outer rear seats.

The upper mounting points are primarily intended for use with front-facing child seats.

Always follow the manufacturer's installation instructions when connecting a child seat to the upper mounting points.

## The location of the mounting points



*Mounting point locations for the rear seat are indicated by symbols on the rear of the backrest.*

The mounting points for the rear seat are located on the rear of the outer rear seats.



*The mounting point location for the front seat is indicated by a symbol on the rear of the front seat.*

The mounting point for the front seat is located on the lower rear of the front seat.

## Related information

- Child seats (p. 49)
- Lower mounting points for child seats (p. 51)
- i-Size/ISOFIX mounting points for child seats (p. 52)
- Overview table for location of child seats (p. 57)
- Table for location of child seats using the car's seatbelts (p. 58)

## WARNING

The child seat's upper straps must be routed through the hole in the head restraint leg before they are tensioned at the mounting point. If this is not possible, follow the recommendations from the child seat manufacturer.

## Lower mounting points for child seats

### NOTE

- Adjust the seat's head restraint in order to facilitate the installation of child restraint systems.
- The parcel shelf must be removed before child restraint systems can be installed in the mounting points.

The car is equipped with lower mounting points for child seats in the front seat and rear seat.

The lower mounting points are designed to be used in conjunction with certain rear-facing child seats.

Always follow the manufacturer's installation instructions when connecting a child seat to the lower mounting points.

### The location of the mounting points



*Mounting point locations for the front seat.*

The mounting points for the front seat are located on the sides of the passenger seat's legroom.

# i-Size/ISOFIX mounting points for child seats



*Mounting point locations for the rear seat.*

The mounting points for the rear seat are located on the rear section of the front seat's floor rails.

## Related information

- Child seats (p. 49)
- Upper mounting points for child seats (p. 50)
- i-Size/ISOFIX mounting points for child seats (p. 52)
- Overview table for location of child seats (p. 57)
- Table for location of child seats using the car's seatbelts (p. 58)

The car is equipped with i-Size/ISOFIX mounting points for child seats in the front seat and rear seat.

i-Size/ISOFIX<sup>2</sup> is a fixture system for car child seats that is based on an international standard.

Always follow the manufacturer's installation instructions when connecting a child seat to the i-Size/ISOFIX mounting points.

## The location of the mounting points



*Mounting point locations for the front seat are indicated by symbols on the upholstery of the backrest.*

The mounting points for i-Size/ISOFIX for the front seat are concealed behind the lower section of the passenger seat's backrest.

Press the seat cushion down to access the mounting points.

# Child seat positioning



Mounting point locations for the rear seat are indicated by symbols<sup>2</sup> on the upholstery of the backrest.

The mounting points for i-Size/ISOFIX for the rear seat are located behind covers in the lower section of the rear seat's backrest, in the outer seats.

To access the mounting points, remove the covers.

## Related information

- Child seats (p. 49)
- Upper mounting points for child seats (p. 50)
- Lower mounting points for child seats (p. 51)
- Overview table for location of child seats (p. 57)
- Table for location of i-Size child seats (p. 60)
- Table for location of ISOFIX child seats (p. 61)

It is important to position the child seat in the right place in the car. The choice of location depends, amongst other things, on the type of child seat and whether the passenger airbag is activated.



*Rear-facing child seat and airbag are not compatible.*

Always fit rear-facing child seats in the rear seat if the passenger airbag is activated. If a child is sitting on the front passenger seat then he/she could suffer serious injury if the airbag deploys.

If the passenger airbag is deactivated then rear-facing child seats can be fitted on the front passenger seat.

## Label for passenger airbag



*Label on the passenger side's sun visor.*

The warning label for the passenger airbag is positioned as shown above.

## Related information

- Child seats (p. 49)
- Child seat mounting (p. 55)
- Overview table for location of child seats (p. 57)
- Table for location of child seats using the car's seatbelts (p. 58)
- Table for location of i-Size child seats (p. 60)
- Table for location of ISOFIX child seats (p. 61)

## WARNING

Never allow anybody to stand or sit in front of the front passenger seat.

Never use a rear-facing child seat on the front passenger seat if the airbag is activated.

Front-facing passengers (children and adults) must never sit on the front passenger seat if the passenger airbag is deactivated.

Failure to follow the advice given above can endanger life or lead to serious personal injury.

## NOTE

Regulations regarding the placement of children in cars vary from country to country. Check what does apply.

# Child seat mounting

It is important to remember a number of things when a child restraint system is mounted and used, which depend on where the child restraint system is positioned.

## Installation in the front seat

- When fitting rear-facing child seats, check that the passenger airbag is deactivated.
- When fitting front-facing child seats, check that the passenger airbag is activated.
- Only use child restraint systems that are recommended by Polestar, universally approved or are semi-universal/vehicle-specific, and where the car is included on the manufacturer's vehicle list.
- ISOFIX child seats can only be fitted when the car is equipped with the ISOFIX console<sup>3</sup>.
- The passenger seat is equipped with the ISOFIX fixture system and is approved for i-Size<sup>3</sup>.
- The passenger seat is equipped with upper mounting point<sup>3</sup>. Polestar recommends routing the child seat's upper straps through the hole in the head restraint before they are tensioned at the mounting point. If this is not possible, follow the recommendations from the child seat manufacturer.
- If the child seat is equipped with lower straps, Polestar recommends that the lower mounting points are used with these<sup>3</sup>.
- If the child seat is equipped with support legs, always fit the support leg/support legs directly to the floor. Never fit a support leg to a footrest or other object.
- The ISOFIX guide can be used in order to facilitate child seat installation.

## Installation in the rear seat

- Only use child restraint systems that are recommended by Polestar, universally approved or are semi-universal/vehicle-specific, and where the car is included on the manufacturer's vehicle list.
- A child seat with support legs must not be fitted in the centre seat.
- The outer seats are equipped with the ISOFIX fixture system and are approved for i-Size<sup>3</sup>.
- The outer seats are equipped with upper mounting points. Polestar recommends routing the child seat's upper straps through the hole in the head restraint before they are tensioned at the mounting point. If this is not possible, follow the recommendations from the child seat manufacturer.
- If the child seat is equipped with lower straps, never adjust the position of the seat in front after the straps have been fitted in the lower mounting points. Always remember to remove the lower straps when the child seat is not installed.
- If the child seat is equipped with support legs, always fit the support leg/support legs directly to the floor. Never fit a support leg to a footrest or other object.

<sup>3</sup> Varies depending on market.

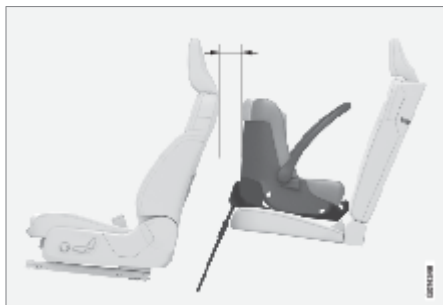

*With the installation of an infant seat in the rear seat, Polestar recommends a distance of at least 50 mm (2 inches) from the front part of the infant seat to the rearmost part of the seat in front.*

#### Related information

- Child seat positioning (p. 53)
- Overview table for location of child seats (p. 57)
- Table for location of child seats using the car's seatbelts (p. 58)
- Table for location of i-Size child seats (p. 60)
- Table for location of ISOFIX child seats (p. 61)

## WARNING

Child restraint systems with steel braces or some other design that could rest on the seatbelt buckle's opening button must not be used, as they could cause the seatbelt buckle to open accidentally.

Do not secure the straps for the child restraint system into the seat's horizontal adjustment bar or in springs, rails or beams under the seat. Sharp edges may damage the straps.

Do not allow the upper section of the child restraint system to rest against the windscreen.

## NOTE

- When using child safety equipment, it is important to read the installation instructions included.

In the event of questions when fitting child safety equipment, contact the manufacturer for clearer instructions.

- Never leave a child seat loose in the car. Always secure it according to the instructions for the child seat, even when it is not in use.
- Long-term installation and use of child seats may cause wear and tear on the car's fittings.



# Overview table for location of child seats

The table gives an overview of the types of child seats suitable for the car's seats.

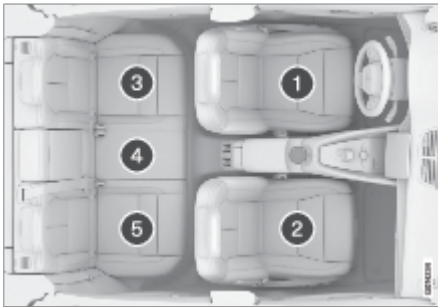

Seat positions in a left-hand drive car.

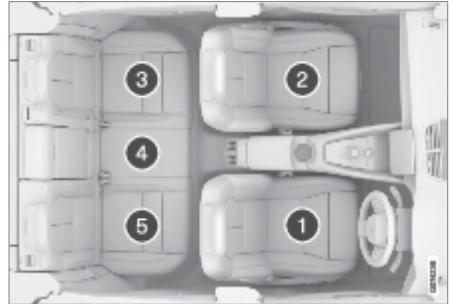

Seat positions in a right-hand drive car.

	i-Size child seats	Universally approved child seats secured using the car's seatbelt	Other child seat categories <sup>A</sup>
Seat position <sup>B</sup>	2 <sup>C, D</sup> , 3, 5	2 <sup>C</sup> , 3, 4, 5	2 <sup>C</sup> , 3, 4 <sup>E</sup> , 5

A For more information, contact the child seat manufacturer.

B As per the numbering above.

C Activated airbag for front-facing child seats. Deactivated airbag for rear-facing child seats.

D Varies depending on market.

E Does not apply for child restraint systems with support legs.

## Related information

- Child seat positioning (p. 53)
- Child seat mounting (p. 55)
- Table for location of child seats using the car's seatbelts (p. 58)
- Table for location of i-Size child seats (p. 60)
- Table for location of ISOFIX child seats (p. 61)

## WARNING

When front-facing child seats are fitted on the front passenger seat (seat position 2), the passenger airbag must be activated.

When rear-facing child seats are fitted on the front passenger seat (seat position 2), the passenger airbag must be deactivated.

# Table for location of child seats using the car's seatbelts

The table gives a recommendation for which child seats suit which locations, and for what size of child.

Weight	Front seat (with deactivated airbag, only rear-facing child seats) <sup>A</sup>	Front seat (with activated airbag, only front-facing child seats) <sup>A</sup>	Outer rear seat	Centre rear seat
Group 0 max 10 kg	U <sup>B,C,D</sup>	X	U <sup>D</sup>	U <sup>D</sup>
Group 0+ max 13 kg	U <sup>B,C,D</sup>	X	U <sup>D</sup>	U <sup>D</sup>
Group 1 9-18 kg	L	U <sup>F</sup> B,C,E,F	U <sup>E,F,L</sup>	U <sup>E,F</sup>
Group 2 15-25 kg	L	U <sup>F</sup> B,C,F	U <sup>F,L</sup>	U <sup>F</sup>
Group 3 22-36 kg	X	U <sup>F</sup> B,C,G	U <sup>G</sup>	U <sup>G</sup>

U: Suitable for universal category restraints approved for use in this mass group.

UF: Suitable for front-facing universally approved child seats.

L: Suitable for particular child restraints. These restraints may be of the specific vehicle, restricted or semi-universal categories.

X: The seat is not suitable for children in this mass group.

- A The seat cushion extension must always be retracted for the installation of child restraint systems.
- B Adjust the seat to a more raised position.
- C Adjust the backrest inclination, as well as seat cushion height and inclination if necessary.
- D Polestar recommends: Maxi Cosi Cabriofix (type approval E4 04443517).
- E Polestar recommends rear-facing child seat for children in this mass group.
- F Polestar recommends: Booster cushion with and without backrest (type approval E5 04216); Volvo booster seat (type approval E1 04301312)/Römer KidFix SL (type approval E1 04301312).
- G Polestar recommends: Booster cushion with and without backrest (type approval E5 04216); Volvo booster seat (type approval E1 04301312)/Römer KidFix SL (type approval E1 04301312); Nania/OSANN Junior (type approval ECE R44: E24 – 040148).

## Related information

- Child seat positioning (p. 53)
- Child seat mounting (p. 55)
- Overview table for location of child seats (p. 57)
- Table for location of i-Size child seats (p. 60)

- Table for location of ISOFIX child seats (p. 61)
- Seatbelts (p. 32)

## WARNING

Never use a rear-facing child seat on the front passenger seat if the passenger air-bag is activated.

## NOTE

Always read the Manual section on installing a child seat before installing one in the car.

# Table for location of i-Size child seats

The table gives a recommendation for which i-Size child seats suit which locations, and for what size of child.

The child seat must be approved in accordance with UN Reg R129.

Type of child seat	Front seat (with deactivated airbag, only rear-facing child seats) <sup>A</sup>	Front seat (with activated airbag, only front-facing child seats) <sup>A</sup>	Outer rear seat <sup>A</sup>	Centre rear seat
i-Size child seats	Yes <sup>B, C, D</sup>	Yes <sup>B, C, D</sup>	Yes <sup>B</sup>	No

A Polestar recommends that children should travel in rear-facing child restraint systems for as long as possible, at least until 4 years of age.

B Polestar recommends: BeSafe iZi Kid X2 i-Size (type approval E4-129R-000002).

C Adjust the backrest so that the head restraint does not interfere with the child seat.

D For child restraint systems with support legs, adjust the seat to a more raised position.

## Related information

- Child seat positioning (p. 53)
- Child seat mounting (p. 55)
- Overview table for location of child seats (p. 57)
- Table for location of child seats using the car's seatbelts (p. 58)
- Table for location of ISOFIX child seats (p. 61)
- i-Size/ISOFIX mounting points for child seats (p. 52)

## NOTE

Always read the Manual section on installing a child seat before installing one in the car.

## Table for location of ISOFIX child seats

The table gives a recommendation for which ISOFIX child seats suit which locations, and for what size of child.

The child seat must be approved in accordance with UN Reg R44 and the car model must be included in the manufacturer's vehicle list.

Weight	Size class <sup>A</sup>	Type of child seat	Front seat (with deactivated airbag, only rear-facing child seats) <sup>B, C, D</sup>	Front seat (with activated airbag, only front-facing child seats) <sup>B, C, D</sup>	Outer rear seat	Centre rear seat
Group 0 max 10 kg	E	Rear-facing infant seat	IL <sup>B</sup> , X <sup>E</sup>	X	IL	X
Group 0+ max 13 kg	E	Rear-facing infant seat	IL <sup>B, F</sup> , X <sup>E</sup>	X	IL	X
	C	Rear-facing child seat				
	D	Rear-facing child seat				

Weight	Size class <sup>A</sup>	Type of child seat	Front seat (with deactivated airbag, only rear-facing child seats) <sup>B, C, D</sup>	Front seat (with activated airbag, only front-facing child seats) <sup>B, C, D</sup>	Outer rear seat	Centre rear seat
Group 1 9-18 kg	A	Front-facing child seat	X	IL <sup>B, F, G</sup> , X <sup>E</sup>	IL <sup>G</sup> , IUFG <sup>G</sup>	X
	B	Front-facing child seat				
	B1	Front-facing child seat				
	C	Rear-facing child seat	IL <sup>B, F, H</sup> , X <sup>E</sup>	X	IL <sup>H</sup>	X
	D	Rear-facing child seat				

IL: Suitable for particular ISOFIX child restraint systems. These child restraint systems are those of the specific vehicle, restricted or semi-universal categories.

IUF: Suitable for ISOFIX forward child restraint systems of universal category approved for use in the mass group.

X: Not suitable for ISOFIX child restraint systems.

- A For child seats with the ISOFIX fixture system there is a size classification to help users choose the right type of child restraint system. The size class can be read on the child restraint system's label.
- B Works for the installation of i-Size child restraint systems and ISOFIX child restraint systems (IL) if the passenger seat is equipped with ISOFIX mountings (varies depending on market) and is i-Size-marked. The upper mounting point for child restraint systems is only available for an i-Size marked position.
- C The seat cushion extension must always be retracted for the installation of child restraint systems.
- D For child restraint systems with support legs, adjust the seat to a more raised position.
- E Applicable if the car is not fitted with an ISOFIX bracket.
- F Adjust the backrest so that the head restraint does not interfere with the child seat.
- G Polestar recommends rear-facing child seat for children in this mass group.
- H Polestar recommends: BeSafe iZi Kid X2 i-Size (type approval E4-129R-000002).

### Related information

- Child seat positioning (p. 53)
- Child seat mounting (p. 55)
- Overview table for location of child seats (p. 57)
- Table for location of child seats using the car's seatbelts (p. 58)
- Table for location of i-Size child seats (p. 60)
- i-Size/ISOFIX mounting points for child seats (p. 52)

## WARNING

Never use a rear-facing child seat on the front passenger seat if the passenger air-bag is activated.

## NOTE

- Always read the Manual section on installing a child seat before installing one in the car.
- If an ISOFIX child seat has no size classification, the car model must be included on the vehicle list for the child seat.

# Detail information for child seat manufacturers

The table provides detailed information for child seat manufacturers on which locations in the car are appropriate for which types of child seat.

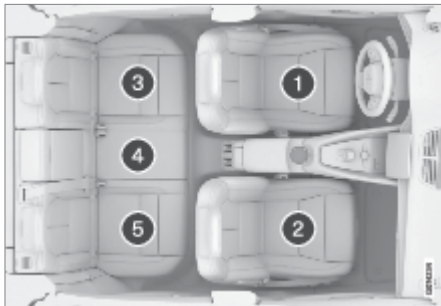

Seat positions in a left-hand drive car.

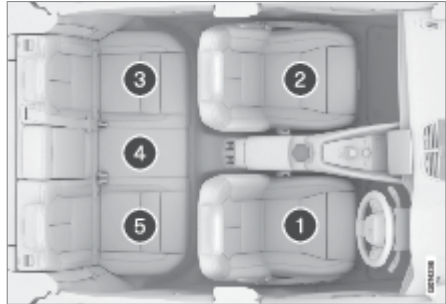

Seat positions in a right-hand drive car.

Seat position <sup>A</sup>	1	2 (with deactivated airbag, only rear-facing child seats) <sup>B, C</sup>	2 (with activated airbag, only front-facing child seats) <sup>B, C</sup>	3 <sup>C</sup>	4 <sup>D</sup>	5 <sup>C</sup>
Seat position suitable for universal category restraints which are attached using the car's seatbelt (Yes/No).	No	Yes <sup>E</sup>	Yes <sup>E</sup>	Yes	Yes	Yes
Seat position for i-Size (Yes/No)	No	Yes <sup>F, G</sup>	Yes <sup>F, G</sup>	Yes	No	Yes
Seat position lateral fixture (L1/L2/No)	No	No	No	No	No	No
Largest suitable rearward facing fixture (R1/R2/R3/No)	No	R3 <sup>H</sup>	No	R3	No	R3



Seat position <sup>A</sup>	1	2 (with deactivated airbag, only rear-facing child seats) <sup>B, C</sup>	2 (with activated airbag, only front-facing child seats) <sup>B, C</sup>	3 <sup>C</sup>	4 <sup>D</sup>	5 <sup>C</sup>
Largest suitable forward facing fixture (F1/F2/F2x/F3/No)	No	No	F3 <sup>E, H</sup>	F3	No	F3
Largest suitable booster fixture (B2/B3/No)	No	No	B3	B3	No	B3

A In accordance with illustration.

B The seat cushion extension must always be retracted for the installation of child restraint systems.

C A child seat with support legs can be used on this seat.

D A child seat with support legs cannot be used on this seat.

E Adjust the backrest to a more upright position.

F Varies depending on market.

G For child restraint systems with support legs, adjust the seat to a more raised position.

H Works for the installation of i-Size child restraint systems and ISOFIX child restraint systems (IL) if the passenger seat is equipped with ISOFIX mountings (varies depending on market) and is i-Size-marked. The upper mounting point for child restraint systems is only available for an i-Size marked position.



## Section 04

—

## Displays and voice control

# Displays and controls by the driver in a left-hand drive car

The overviews show where the displays and controls by the driver are located.

## Steering wheel and instrument panel

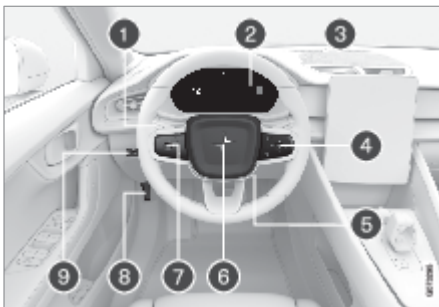

- ① Position lamps, daytime running lights, dipped beam, main beam, direction indicators, rear fog lamp, resetting the trip meter
- ② Driver display
- ③ Wipers and washing, rain sensor
- ④ Right-hand steering wheel keypad
- ⑤ Steering wheel adjustment
- ⑥ Horn
- ⑦ Left-hand steering wheel keypad
- ⑧ Opening the bonnet
- ⑨ Display lighting, unlocking/opening/closing of tailgate

## Roof console

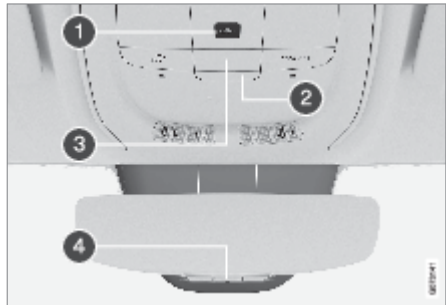

- ① Front reading lamps and interior lighting
- ② Hatch for SIM card
- ③ Display in roof console, CONNECT button
- ④ Manual dimming or HomeLink®<sup>4</sup>

## Centre and tunnel console

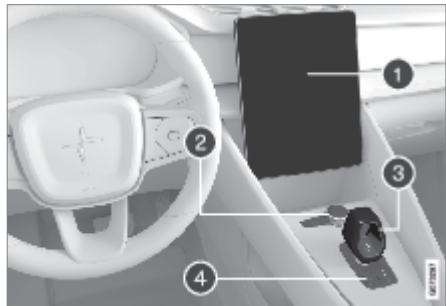

- ① Centre display
- ② Hazard warning flashers, defrosting, media
- ③ Gear selector
- ④ Parking brake

<sup>4</sup> For cars with automatic dimming, there is no control for manual dimming.

# Displays and controls by the driver in a right-hand drive car

## Driver's door

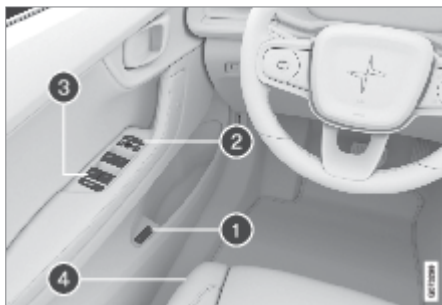

- ① Memories for power front seats settings
- ② Central locking and door mirrors
- ③ Electric windows and child locks
- ④ Adjusting front seat

## Related information

- Adjusting the power front seat (p. 161)
- Adjusting the steering wheel (p. 171)
- Lighting control (p. 128)
- Starting the car (p. 372)
- Driver display (p. 72)
- Overview of centre display (p. 105)
- Gear positions (p. 385)

The overviews show where the displays and controls by the driver are located.

## Steering wheel and instrument panel

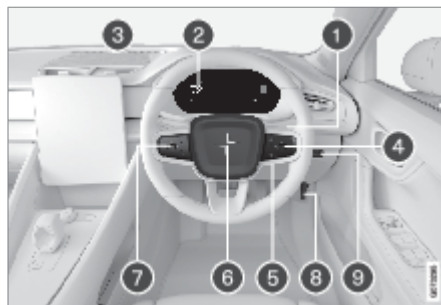

- ① Position lamps, daytime running lights, dipped beam, main beam, direction indicators, rear fog lamp, resetting the trip meter
- ② Driver display
- ③ Wipers and washing, rain sensor
- ④ Right-hand steering wheel keypad
- ⑤ Steering wheel adjustment
- ⑥ Horn
- ⑦ Left-hand steering wheel keypad
- ⑧ Opening the bonnet
- ⑨ Display lighting, unlocking/opening/closing of tailgate

## Roof console

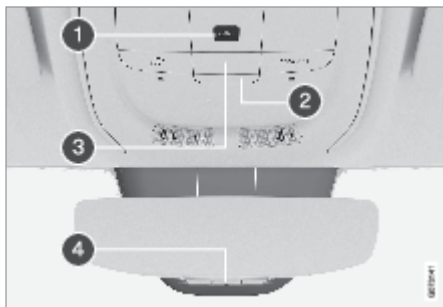

- ① Front reading lamps and interior lighting
- ② Hatch for SIM card
- ③ Display in roof console, CONNECT button
- ④ Manual dimming or HomeLink®<sup>5</sup>

## Driver's door

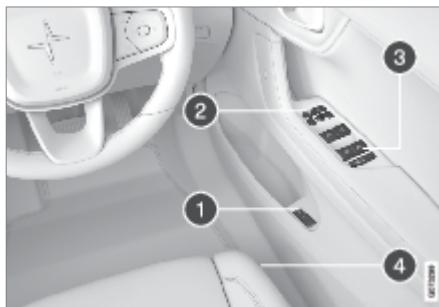

- ① Memories for power front seats settings
- ② Central locking and door mirrors
- ③ Electric windows and child locks
- ④ Adjusting front seat

## Centre and tunnel console

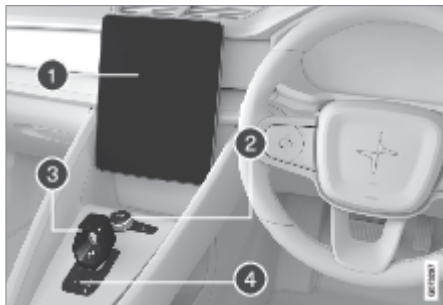

- ① Centre display
- ② Hazard warning flashers, defrosting, media
- ③ Gear selector
- ④ Parking brake

## Related information

- Adjusting the power front seat (p. 161)
- Adjusting the steering wheel (p. 171)
- Lighting control (p. 128)
- Starting the car (p. 372)
- Driver display (p. 72)
- Overview of centre display (p. 105)
- Gear positions (p. 385)

# Date and time



The clock is shown in the centre display where it is also possible to change the settings for date and time.

## Clock location



The clock is located at the top right of the centre display's status bar.

## Date and time settings

1. Tap on  at the top of the centre display.
2. Tap on  and then System, then select Date and Time.
3. Select the desired setting.

## Automatic setting for date and time

Date and time are set automatically as standard. The time zone is adjusted automatically based on the location of the car.

Adjust date, time and time zone manually by deactivating the setting for automatic date and time.

For both settings it is possible to select the 24 or 12-hour clock.

## Related information

- Overview of centre display (p. 105)
- Centre display's views (p. 110)
- Car function view in the centre display (p. 112)
- Keyboard in centre display (p. 114)
- Messages in the centre display (p. 123)

# Driver display

The driver display shows information about the car and driving.

The driver display contains gauges, indicators and indicator and warning symbols. The content of the driver display depends on the car's equipment, settings and which functions are active at that time.

The driver display is activated as soon as a door is opened. The driver display extinguishes after a while if it is not used. To reactivate it, proceed with one of the following:

- Depress the brake pedal.
- Open one of the doors.



Location in the driver display:

On the left	In the middle	On the right
Indicator and warning symbols	Temperature	Indicator and warning symbols
Speedometer	Messages, in some cases with graphics	Battery meter
Driving direction selected	Door and seatbelt information	Power meter
Cruise control and speed limiter information	Driver support functions	Trip meter
Odometer <sup>A</sup>	–	Distance to empty battery
–	–	App menu (activated via steering wheel keypad)

A Accumulated mileage.

## Related information

- Driver display settings (p. 74)
- Indicator and warning symbols (p. 79)
- Cleaning the driver display (p. 521)
- Trip computer (p. 76)
- Resetting the trip meter (p. 77)
- Messages in the driver display (p. 104)

## WARNING

- If the driver display should extinguish, not illuminate on activation/start or be fully or partially illegible, the car must not be used: contact Polestar Support.



## WARNING

- In the event of a fault in the driver display the information on e.g. brakes, airbags or other safety systems may not be shown. In which case, the driver cannot check the status of the car's systems or receive current warnings and information.

# Driver display settings

Change display mode or set what should be shown in the driver display.

## App menu

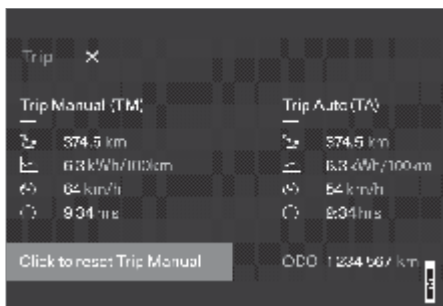

### Overview of app menu.

Trip – Information on trip meter and odometer, among other things.

## Managing the app menu



### Right-hand keypad on the steering wheel.

- ① Close menu/change display mode
- ② Left/right
- ③ Up/down
- ④ Open menu/confirm

The app menu closes after a period of inactivity or after certain options have been selected.

## Display modes

The driver display has three different display modes that are changed via the  button on the right-hand side of the steering wheel.

- Car Centric - the middle section of the driver display is adapted depending on which functions are active.
- Calm - the middle section of the driver display is empty.
- Navigation - a map is shown of the entire driver display.

## System settings

System settings for the driver display are made via the centre display.

1. Press .
2. Press .
3. Select Displays.
4. Change the preferred settings.

These settings are personal and are saved to the active user profile.

## Related information

- Driver display (p. 72)
- Messages in the driver display (p. 104)
- Trip computer (p. 76)

# Battery meter

## NOTE

It is not possible to open the app menu while there is an unacknowledged message in the driver display. The message has to be confirmed first before the app menu can be opened.

The battery meter shows energy amount and, together with the trip computer, calculates approximate range.

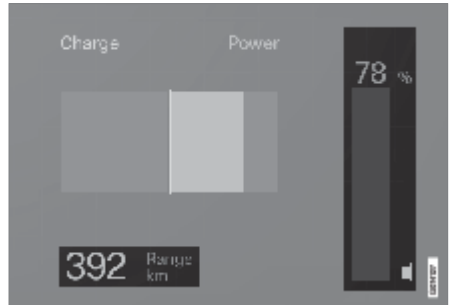

*Battery meter and calculated range in the driver display.*

The battery meter shows how much energy there is in the battery. The trip computer calculates approximate range for the energy left in the battery. Factors such as driving method and outside temperature can affect the estimated range.

## Related information

- Driver display (p. 72)
- Regenerative braking (p. 384)
- Range for electric operation (p. 392)

## Power meter

The power meter indicates when the car is being driven on electricity, when it is recovering energy to the battery, or when regeneration is limited.

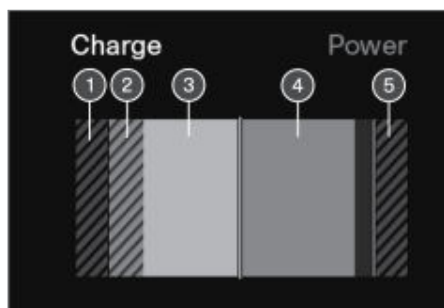

Power meter location is to the right in the driver display.

- 1 Grey dashed – regeneration to the battery is limited.
- 2 Orange dashed – forceful braking counteracts the possibility of regeneration.
- 3 White – regeneration with the accelerator pedal or the brake pedal.
- 4 Orange – the car is consuming energy.
- 5 Dashed – the electrical drive system is limited.

### Related information

- Driver display (p. 72)
- Regenerative braking (p. 384)
- Setting level for braking action (p. 385)

## Trip computer

The car's trip computer registers values, e.g. mileage, average consumption and average speed.

### Information in the trip computer

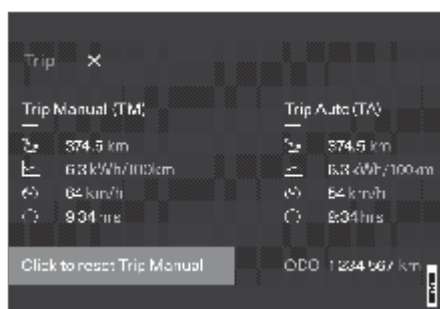

Overview of trip computer in the driver display.



Mileage



Average consumption



Average speed



Driving time

### Trip meter

There are two trip meters, TM and TA.

# Resetting the trip meter



TM can be reset manually and TA is reset automatically if the car is not used for at least four hours.

## Odometer

The odometer records the car's total mileage. This value cannot be reset to zero.

## Trip computer settings

Trip computer settings are made via the centre display.

1. Press .
2. Press .
3. Select Displays.
4. Change the preferred settings.

## Related information

- Range for electric operation (p. 392)
- Resetting the trip meter (p. 77)
- Journey statistics in the centre display (p. 78)
- Journey statistics in the centre display (p. 78)
- Driver display (p. 72)
- Changing system units (p. 117)

The trip meter can be reset to zero in the driver display or by using the left-hand stalk switch.

Reset all information in the trip meter to zero (mileage, average consumption, average speed and driving time).

## Resetting to zero in the driver display

1. Press the O button on the steering wheel.
2. Browse with the arrows to Trip.
3. Click on the O button.
4. Click once more on the O button to confirm.
  - > The trip meter is reset to zero.

## Reset to zero using the left-hand stalk switch



- A long press on the RESET button on the left-hand stalk switch.
  - > The trip meter is reset to zero.

## Related information

- Trip computer (p. 76)

# Journey statistics in the centre display

Make use of the journey statistics from the trip computer in order to provide an overview of the driving and to facilitate more economic driving.

- Economical driving (p. 394)

The journey statistics are available via the Driver performance button in the app view.



The journey statistics provide an overview of:

- Instant consumption
- Average consumption
- Driving time
- Average speed
- Mileage

## Related information

- Trip computer (p. 76)
- Range for electric operation (p. 392)

# Outside temperature gauge

The temperature outside the car is shown in the driver display.



If the car has been stationary, the gauge may display a temperature reading that is too high.



When the temperature outside the car is between  $-5^{\circ}\text{C}$  and  $+2^{\circ}\text{C}$  ( $23^{\circ}\text{F}$  to  $36^{\circ}\text{F}$ ), a snowflake symbol illuminates to warn of icy conditions.

Change, for example, the unit in the temperature gauge via settings in the centre display.





## Related information



- Driver display (p. 72)
- Changing system units (p. 117)
- Driver display settings (p. 74)

# Indicator and warning symbols





The indicator and warning systems alert the driver to the fact that a function is activated, a system is working, or a defect or serious error has occurred.







## Red symbols

	<b>Warning</b> The red warning symbol illuminates when a fault has been detected, which could affect the safety or driveability of the car. An explanatory text is shown on the driver display at the same time.  The warning symbol can also illuminate in conjunction with other symbols.
	<b>Seatbelt reminder</b> Illuminates or flashes when someone in the car has not buckled his/her seatbelt.
	<b>Airbags</b> A fault is detected in one of the car's safety systems. Read the message in the driver display and contact Polestar Support.
	<b>Fault in brake system</b> A fault has arisen in the brake system. Read the message in the driver display and contact Polestar Support.

	<p>Parking brake</p> <p>Constant glow: the parking brake is activated.</p> <p>Flashing: a fault has arisen with parking brake. Read the message in the driver display.</p>
	<p>Fault in the electrical system</p> <p>A fault has arisen in the electrical system. Contact Polestar Support.</p>
	<p>Assistance at risk of collision</p> <p>Warns of a risk of collision with other vehicles, pedestrians, cyclists or large animals.</p>



### Amber symbols

	<p>Information</p> <p>A problem has arisen in one of the car's systems. Read the message in the driver display.</p> <p>The information symbol can also illuminate in conjunction with other symbols.</p>
	<p>Fault in brake system</p> <p>A fault has arisen in the brake system. Read the message in the driver display.</p>
	<p>ABS fault</p> <p>The system is disengaged. The car's regular brake system continues to work, but without the ABS function.</p>
	<p>Rear fog lamp</p> <p>The rear fog lamp is switched on.</p>





	<p>Tyre pressure system</p> <p>Low tyre pressure.</p> <p>If there is a fault in the tyre pressure system, the symbol will flash for approx. 1 minute and then illuminate with a constant glow. This may be because the system cannot detect or warn of low tyre pressure as intended.</p>
	<p>Fault in the headlamp system</p> <p>A fault has arisen in the headlamp system. Read the message in the driver display.</p>
	<p>Lane assistance</p> <p>Lane assistance warns/intervenes.</p>
	<p>Reduced performance</p> <p>Temporary fault in the powertrain. Read the message in the driver display.</p>
	<p>Stability system</p> <p>Constant glow: a fault has arisen in the system.</p> <p>Flashing: the system is working.</p>
	<p>Stability system, sport mode</p> <p>Sport mode is selected.</p>





### Blue symbols



	Active main beam Active main beam is switched on and illuminates.
	Main beam Main beam illuminates.

### Green symbols

	Left and right-hand direction indicator Direction indicator in use.
	
	Front fog lamps The front fog lamp is switched on.
	Position lamps The position lamps illuminate.

### White/Grey symbols

	Active main beam Active main beam is switched on but does not illuminate.
	Braking when stationary Braking when stationary is activated.

	Lane assistance White symbol: Lane assistance is activated and road lines are detected. Grey symbol: Lane assistance is activated and road lines are not detected.
	Rain sensor The rain sensor is activated.

### Related information

- Driver display (p. 72)

# License agreement for driver display

A license is an agreement for the right to operate a certain activity or the right to use someone else's entitlement according to the terms and conditions in the agreement. The following text is Polestar's agreement with the manufacturer or developer.

uct under the terms of the respective licenses. The source code corresponding to the open source components is also provided along with the product wherever mandated by the respective OSS license.

## 1.1 List of used Open Source Components

This table contains a list of open source software (OSS) components used within the prod-

SI No.	Name of OSS Component	Version of OSS Component	Name and Version of License (License text can be found in Appendix below)	Home Page	More Information
1	BidiReferenceCcpp	26	Unicode Terms of Use	<a href="http://www.unicode.org/Public/PROGRAMS/BidiReferenceCcpp/">http://www.unicode.org/Public/PROGRAMS/BidiReferenceCcpp/</a>	(C) Socionext Embedded Software Austria GmbH (SESA) Copyright (C) 1999-2009, ASMUS, Inc
2	FASTCRC32		License of Stephan brumme/ Zlib style License	<a href="http://stephan-brumme.com/">http://stephan-brumme.com/</a>	Copyright © 2011-2013 Stephan Brumme. All rights reserved, Copyright (C) 1995-2006, 2010, 2011, 2012 Mark Adler
3	Freescale IMX6 HDMI		BSD 3-clause "New" or "Revised" License	<a href="https://www.nxp.com/">https://www.nxp.com/</a>	Copyright © 2009-2012, Freescale Semiconductor, Inc, Copyright © 2010-2012, Freescale Semiconductor, Inc.

SI No.	Name of OSS Component	Version of OSS Component	Name and Version of License (License text can be found in Appendix below)	Home Page	More Information
4	FreeType Hashing		MIT License	<a href="https://sourceforge.net/p/canvasdraw/cd/642/tree/trunk/freetype/include/freetype/internal/ftthash.h">https://sourceforge.net/p/canvasdraw/cd/642/tree/trunk/freetype/include/freetype/internal/ftthash.h</a>	Copyright 2000 Computing Research Labs, New Mexico State University Copyright 2001-2015 Francesco Zappa Nardelli
5	Freetype Project - BDF	1.16	MIT License	<a href="https://www.freetype.org/">https://www.freetype.org/</a>	Copyright (C) 2001, 2002 by Francesco Zappa Nardelli.
6	Freetype Project - PCF	24.16.8	MIT License	<a href="https://www.freetype.org/">https://www.freetype.org/</a>	Copyright 2000-2001, 2003 by Francesco Zappa Nardelli Copyright (C) 2000, 2001, 2002, 2003, 2006, 2010 by Francesco Zappa Nardelli Copyright (C) 2000-2004, 2006-2011, 2013, 2014 by Francesco Zappa Nardelli Copyright 2000-2010, 2012-2014 by Francesco Zappa Nardelli Copyright 2003 by Francesco Zappa Nardelli
7	Freetype Project - Pcfutil		Open Group License	<a href="https://www.freetype.org/">https://www.freetype.org/</a>	Copyright 1990, 1994, 1998 The Open Group
8	HarfBuzz	1.3.1	MIT License	<a href="http://freedesktop.org/wiki/Software/HarfBuzz">http://freedesktop.org/wiki/Software/HarfBuzz</a>	Copyright © 2007 Chris Wilson Copyright © 2009, 2010 Red Hat, Inc. Copyright © 2011, 2012 Google, Inc.

SI No.	Name of OSS Component	Version of OSS Component	Name and Version of License (License text can be found in Appendix below)	Home Page	More Information
9	Integrity Libnet		Internet Software Consortium-IBM License ISC License	<a href="https://github.com/lattera/glibc/blob/master/resolv/inet_pton.c">https://github.com/lattera/glibc/blob/master/resolv/inet_pton.c</a>	Copyright © 1996 by Internet Software Consortium. Copyright © 1995 by International Business Machines, Inc.
10	Khronos EGL Headers	1.3	MIT License	<a href="http://www.khronos.org/registry/egl/">http://www.khronos.org/registry/egl/</a>	Copyright © 2007-2013 The Khronos Group Inc. Copyright 2008 VMware, Inc. Copyright © 2013-2014 The Khronos Group Inc.
11	Khronos Group - OpenGL ES	2.0	SGI Free Software License B v2.0	<a href="http://www.khronos.org/opengles/">http://www.khronos.org/opengles/</a>	
12	libjpeg	6b	Independent JPEG Group License	<a href="http://www.ijg.org/">http://www.ijg.org/</a>	Copyright (C) 1991-1997, Thomas G. Lane.

SI No.	Name of OSS Component	Version of OSS Component	Name and Version of License (License text can be found in Appendix below)	Home Page	More Information
13	libpng	1.4.3	libpng License	<a href="http://github.com/coapp-packages/libpng/">http://github.com/coapp-packages/libpng/</a>	Copyright © 1998-2010 Glenn Randers-Pehrson Copyright © 2007, 2009 Glenn Randers-Pehrson Version 0.96 Copyright © 1996, 1997 Andreas Dilger Version 0.88 Copyright © 1995, 1996 Guy Eric Schalnat, Group 42, Inc.
14	Libunibreak	2.1	zlib License	<a href="https://github.com/adah1972/libunibreak">https://github.com/adah1972/libunibreak</a>	Copyright (C) 2008-2011 Wu Yongwei Copyright (C) 2012 Tom Hacohe tom@stosb.com
15	lz4 Compression algorithm	NA	BSD 2-clause "Simplified" License	<a href="http://github.com/Cyan4973/lz4/">http://github.com/Cyan4973/lz4/</a>	Copyright (C) 2011-2014, Yann Collet
16	md5	NA	Public Domain	<a href="https://doxygen.reactos.org/d7/d04/sdk_2lib_23rdparty_2freetype_2src_2base_2md5_8c_source.html">https://doxygen.reactos.org/d7/d04/sdk_2lib_23rdparty_2freetype_2src_2base_2md5_8c_source.html</a>	

SI No.	Name of OSS Component	Version of OSS Component	Name and Version of License (License text can be found in Appendix below)	Home Page	More Information
17	NetBSD	1.5	HPND like license IBM License BSD-4-Clause (University of California-Specific) BSD 3-clause "New" or "Revised" License BSD One Clause License	<a href="http://www.netbsd.org/">http://www.netbsd.org/</a>	Copyright © 1998 Manuel Bouyer Copyright © 1996 Matt Thomas., Copyright 1997 Marshall Kirk McKusick. All Rights Reserved, Copyright © 1985, 1988, 1989, 1991, 1993, 1995 The Regents of the University of California Copyright © 1989, 1993 The Regents of the University of California Copyright © 1983, 1993 The Regents of the University of California Copyright 2000-2011 Green Hills Software Copyright (c) 1996 by Internet Software Consortium. Copyright (C) 1998 WIDE Project, Portions Copyright © 1995 by International Business Machines, Inc, Copyright (C) 1994, 1995, 1997 ToolS GmbH Copyright (C) 1994, 1995, 1997 Wolfgang Solfrank Copyright © 1995, 1999 Berkeley Software Design, Inc Portions Copyright © 1993 by Digital Equipment Corporation Copyright ©

SI No.	Name of OSS Component	Version of OSS Component	Name and Version of License (License text can be found in Appendix below)	Home Page	More Information
					1992 Henry Spencer Copyright © 1997, 1998, 1999 The NetBSD Foundation, Inc Copyright © 1994 James A. Jegers
18	NetBSD_BSD4	NA	BSD 4-clause "Original" or "Old" License	<a href="http://www.netbsd.org/">http://www.netbsd.org/</a>	Copyright 2000-2011 Green Hills Software Copyright © 1994, 1998 Christopher G. Demetriou

SI No.	Name of OSS Component	Version of OSS Component	Name and Version of License (License text can be found in Appendix below)	Home Page	More Information
19	The FreeType Project - freetype2	2.6.3	Freetype Project License	<a href="http://sourceforge.net/projects/freetype/">http://sourceforge.net/projects/freetype/</a>	<p>Copyright 2013-2016 by David Turner, Robert Wilhelm, and Werner Lemberg, Copyright 2007-2016 by Rahul Bhalerao</p> <p><a href="mailto:rahul.bhalerao@redhat.com">rahul.bhalerao@redhat.com</a></p> <p><a href="mailto:b.rahul.pm@gmail.com">b.rahul.pm@gmail.com</a></p> <p>Copyright 2009-2016 by Oran Agra and Mickey Gabel, Copyright 2008-2016 by David Turner, Robert Wilhelm, Werner Lemberg, and suzuki toshiya., Copyright 2000 Computing Research Labs, New Mexico State University, Copyright 2001-2015 Francesco Zappa Nardelli, Copyright 2004-2016 by Masatake YAMATO and Redhat K.K, Copyright 2007-2016 by Derek Clegg and Michael Toftdal, Copyright 2010-2016 by Joel Klinghed, Copyright 2007-2013 Adobe Systems Incorporated, Copyright 2007-2014 Adobe Systems Incorporated, Copyright</p>



SI No.	Name of OSS Component	Version of OSS Component	Name and Version of License (License text can be found in Appendix below)	Home Page	More Information
					2004-2016 by Albert Chin-A-Young, Copyright 2013-2016 by Google, Inc, Copyright 2002-2016 by Roberto Alameda, Copyright 2003 Huw D M Davies for Codeweavers, Copyright 2007 Dmitry Timoshkov for Codeweavers
20	Vivante Driver software	NA	MIT License	<a href="http://www.vivantecorp.com/">http://www.vivantecorp.com/</a>	Copyright 2012 - 2016 Vivante Corporation, Santa Clara, California Copyright © 2007 The Khronos Group Inc Copyright © 2014 - 2016 Vivante Corporation Copyright 2012 Vivante Corporation, Sunnyvale, California Copyright © 2011 Intel Corporation Copyright (C) 1999-2001 Brian Paul
21	zlib	1.2.8	zlib License	zlib License	Copyright (C) 1995-2007 Mark Adler Copyright (C) 1995-2005 Jean-loup Gailly Copyright (C) 1995-2010 Mark Adler Copyright (C) 2003 Chris Anderson Copyright (C) 1998 Brian Raiter
22	RBTree.cpp	NA	Public Domain	<a href="http://eternallyconfuzzled.com/tuts/datastructures/jsw_tut_rbtree.aspx">http://eternallyconfuzzled.com/tuts/datastructures/jsw_tut_rbtree.aspx</a>	(C) Socionext Embedded Software Austria GmbH (SESA)

## 2. APPENDIX - LICENSE TEXT

### 2.1 HPND Like license

Portions Copyright (c) 1993 by Digital Equipment Corporation.

Permission to use, copy, modify, and distribute this software for any purpose with or without fee is hereby granted, provided that the above copyright notice and this permission notice appear in all copies, and that the name of Digital Equipment Corporation not be used in advertising or publicity pertaining to distribution of the document or software without specific, written prior permission.

THE SOFTWARE IS PROVIDED "AS IS" AND DIGITAL EQUIPMENT CORP. DISCLAIMS ALL WARRANTIES WITH REGARD TO THIS SOFTWARE, INCLUDING ALL IMPLIED WARRANTIES OF MERCHANTABILITY AND FITNESS. IN NO EVENT SHALL DIGITAL EQUIPMENT CORPORATION BE LIABLE FOR ANY SPECIAL, DIRECT, INDIRECT, OR CONSEQUENTIAL DAMAGES OR ANY DAMAGES WHATSOEVER RESULTING FROM LOSS OF USE, DATA OR PROFITS, WHETHER IN AN ACTION OF CONTRACT, NEGLIGENCE OR OTHER TORTIOUS ACTION, ARISING OUT OF OR IN CONNECTION WITH THE USE OR PERFORMANCE OF THIS SOFTWARE.

### 2.2 BSD 2-clause "Simplified" License

#### BSD Two Clause License

Redistribution and use in source and binary forms, with or without modification, are permitted provided that the following conditions are met: Redistributions of source code must retain the above copyright notice, this list of conditions and the following disclaimer. Redistributions in binary form must reproduce the above copyright notice, this list of conditions and the follow-

ing disclaimer in the documentation and/or other materials provided with the distribution.

THIS SOFTWARE IS PROVIDED BY THE AUTHOR "AS IS" AND ANY EXPRESS OR IMPLIED WARRANTIES, INCLUDING, BUT NOT LIMITED TO, THE IMPLIED WARRANTIES OF MERCHANTABILITY AND FITNESS FOR A PARTICULAR PURPOSE ARE DISCLAIMED. IN NO EVENT SHALL THE AUTHOR BE LIABLE FOR ANY DIRECT, INDIRECT, INCIDENTAL, SPECIAL, EXEMPLARY, OR CONSEQUENTIAL DAMAGES (INCLUDING, BUT NOT LIMITED TO, PROCUREMENT OF SUBSTITUTE GOODS OR SERVICES; LOSS OF USE, DATA, OR PROFITS; OR BUSINESS INTERRUPTION) HOWEVER CAUSED AND ON ANY THEORY OF LIABILITY, WHETHER IN CONTRACT, STRICT LIABILITY, OR TORT (INCLUDING NEGLIGENCE OR OTHERWISE) ARISING IN ANY WAY OUT OF THE USE OF THIS SOFTWARE, EVEN IF ADVISED OF THE POSSIBILITY OF SUCH DAMAGE.

### 2.3 IBM License

Portions Copyright (c) 1995 by International Business Machines, Inc.

International Business Machines, Inc. (hereinafter called IBM) grants permission under its copyrights to use, copy, modify, and distribute this Software with or without fee, provided that the above copyright notice and all paragraphs of this notice appear in all copies, and that the name of IBM not be used in connection with the marketing of any product incorporating the Software or modifications thereof, without specific, written prior permission.

To the extent it has a right to do so, IBM grants an immunity from suit under its patents, if any, for the use, sale or manufacture of products to the extent that such products are used for performing Domain Name System dynamic updates in TCP/IP networks by means of the

Software. No immunity is granted for any product per se or for any other function of any product.

THE SOFTWARE IS PROVIDED "AS IS", AND IBM DISCLAIMS ALL WARRANTIES, INCLUDING ALL IMPLIED WARRANTIES OF MERCHANTABILITY AND FITNESS FOR A PARTICULAR PURPOSE. IN NO EVENT SHALL IBM BE LIABLE FOR ANY SPECIAL, DIRECT, INDIRECT, OR CONSEQUENTIAL DAMAGES OR ANY DAMAGES WHATSOEVER ARISING OUT OF OR IN CONNECTION WITH THE USE OR PERFORMANCE OF THIS SOFTWARE, EVEN IF IBM IS APPRISED OF THE POSSIBILITY OF SUCH DAMAGES.

#### 2.4 BSD 3-clause "New" or "Revised" License

Copyright/Copyright holders – see List of Open Source Components

All rights reserved.

Redistribution and use in source and binary forms, with or without modification, are permitted provided that the following conditions are met:

Redistributions of source code must retain the above copyright notice, this list of conditions and the following disclaimer. Redistributions in binary form must reproduce the above copyright notice, this list of conditions and the following disclaimer in the documentation and/or other materials provided with the distribution. Neither the name of the [ORGANIZATION] nor the names of its contributors may be used to endorse or promote products derived from this software without specific prior written permission.

THIS SOFTWARE IS PROVIDED BY THE COPYRIGHT HOLDERS AND CONTRIBUTORS "AS IS" AND ANY EXPRESS OR IMPLIED WARRANTIES, INCLUDING, BUT NOT LIMITED TO, THE

IMPLIED WARRANTIES OF MERCHANTABILITY AND FITNESS FOR A PARTICULAR PURPOSE ARE DISCLAIMED. IN NO EVENT SHALL THE COPYRIGHT OWNER OR CONTRIBUTORS BE LIABLE FOR ANY DIRECT, INDIRECT, INCIDENTAL, SPECIAL, EXEMPLARY, OR CONSEQUENTIAL DAMAGES (INCLUDING, BUT NOT LIMITED TO, PROCUREMENT OF SUBSTITUTE GOODS OR SERVICES; LOSS OF USE, DATA, OR PROFITS; OR BUSINESS INTERRUPTION) HOWEVER CAUSED AND ON ANY THEORY OF LIABILITY, WHETHER IN CONTRACT, STRICT LIABILITY, OR TORT (INCLUDING NEGLIGENCE OR OTHERWISE) ARISING IN ANY WAY OUT OF THE USE OF THIS SOFTWARE, EVEN IF ADVISED OF THE POSSIBILITY OF SUCH DAMAGE.

#### 2.5 BSD 4-clause "Original" or "Old" License

Copyright/Copyright holders – see List of Open Source Components

All rights reserved.

Redistribution and use in source and binary forms, with or without modification, are permitted provided that the following conditions are met:

1. Redistributions of source code must retain the above copyright notice, this list of conditions and the following disclaimer.
2. Redistributions in binary form must reproduce the above copyright notice, this list of conditions and the following disclaimer in the documentation and/or other materials provided with the distribution.
3. All advertising materials mentioning features or use of this software must display the following acknowledgement: This product

includes software developed by the organization.

4. Neither the name of the organization nor the names of its contributors may be used to endorse or promote products derived from this software without specific prior written permission.

THIS SOFTWARE IS PROVIDED BY COPYRIGHT HOLDER "AS IS" AND ANY EXPRESS OR IMPLIED WARRANTIES, INCLUDING, BUT NOT LIMITED TO, THE IMPLIED WARRANTIES OF MERCHANTABILITY AND FITNESS FOR A PARTICULAR PURPOSE ARE DISCLAIMED. IN NO EVENT SHALL {{COPYRIGHT HOLDER}} BE LIABLE FOR ANY DIRECT, INDIRECT, INCIDENTAL, SPECIAL, EXEMPLARY, OR CONSEQUENTIAL DAMAGES (INCLUDING, BUT NOT LIMITED TO, PROCUREMENT OF SUBSTITUTE GOODS OR SERVICES; LOSS OF USE, DATA, OR PROFITS; OR BUSINESS INTERRUPTION) HOWEVER CAUSED AND ON ANY THEORY OF LIABILITY, WHETHER IN CONTRACT, STRICT LIABILITY, OR TORT (INCLUDING NEGLIGENCE OR OTHERWISE) ARISING IN ANY WAY OUT OF THE USE OF THIS SOFTWARE, EVEN IF ADVISED OF THE POSSIBILITY OF SUCH DAMAGE.

2.6 BSD-4-Clause (University of California-Specific)

BSD-4-Clause (University of California-Specific)

Copyright/Copyright holders – see List of Open Source Components

Redistribution and use in source and binary forms, with or without modification, are permitted provided that the following conditions are met:

1. Redistributions of source code must retain the above copyright notice, this list of conditions and the following disclaimer.
2. Redistributions in binary form must reproduce the above copyright notice, this list of conditions and the following disclaimer in the documentation and/or other materials provided with the distribution.
3. All advertising materials mentioning features or use of this software must display the following acknowledgement: This product includes software developed by the University of California, Berkeley and its contributors.
4. Neither the name of the University nor the names of its contributors may be used to endorse or promote products derived from this software without specific prior written permission.

THIS SOFTWARE IS PROVIDED BY THE REGENTS AND CONTRIBUTORS ``AS IS'' AND ANY EXPRESS OR IMPLIED WARRANTIES, INCLUDING, BUT NOT LIMITED TO, THE IMPLIED WARRANTIES OF MERCHANTABILITY AND FITNESS FOR A PARTICULAR PURPOSE ARE DISCLAIMED. IN NO EVENT SHALL THE REGENTS OR CONTRIBUTORS BE LIABLE FOR ANY DIRECT, INDIRECT, INCIDENTAL, SPECIAL, EXEMPLARY, OR CONSEQUENTIAL DAMAGES (INCLUDING, BUT NOT LIMITED TO, PROCUREMENT OF SUBSTITUTE GOODS OR SERVICES; LOSS OF USE, DATA, OR PROFITS; OR BUSINESS INTERRUPTION) HOWEVER CAUSED AND ON ANY THEORY OF LIABILITY, WHETHER IN CONTRACT, STRICT LIABILITY, OR TORT (INCLUDING NEGLIGENCE OR OTHERWISE) ARISING IN ANY WAY OUT OF THE USE OF THIS SOFTWARE, EVEN IF ADVISED OF THE POSSIBILITY OF SUCH DAMAGE.

## 2.7 FreeType Project License

The FreeType Project LICENSE

2006-Jan-27

Copyright 1996-2002, 2006 by David Turner, Robert Wilhelm, and Werner Lemberg

### Introduction

The FreeType Project is distributed in several archive packages; some of them may contain, in addition to the FreeType font engine, various tools and contributions which rely on, or relate to, the FreeType Project. This license applies to all files found in such packages, and which do not fall under their own explicit license. The license affects thus the FreeType font engine, the test programs, documentation and makefiles, at the very least. This license was inspired by the BSD, Artistic, and IJG (Independent JPEG Group) licenses, which all encourage inclusion and use of free software in commercial and freeware products alike. As a consequence, its main points are that:

We don't promise that this software works. However, we will be interested in any kind of bug reports. ( ` as is' distribution)

You can use this software for whatever you want, in parts or full form, without having to pay us. ( ` royalty-free' usage)

You may not pretend that you wrote this software. If you use it, or only parts of it, in a program, you must acknowledge somewhere in your documentation that you have used the FreeType code. ( ` credits')

We specifically permit and encourage the inclusion of this software, with or without modifications, in commercial products. We disclaim all warranties covering The FreeType Project and assume no liability related to The FreeType Project. Finally, many people asked us for a prefer-

red form for a credit/disclaimer to use in compliance with this license. We thus encourage you to use the following text: "Portions of this software are copyright © 1996-2002, 2006 The FreeType Project ([www.freetype.org](http://www.freetype.org)). All rights reserved."

"Portions of this software are copyright © 1996-2002, 2006 The FreeType Project ([www.freetype.org](http://www.freetype.org)). All rights reserved."

### Definitions

Throughout this license, the terms `package', `FreeType Project', and `FreeType archive' refer to the set of files originally distributed by the authors (David Turner, Robert Wilhelm, and Werner Lemberg) as the `FreeType Project', be they named as alpha, beta or final release. `You' refers to the licensee, or person using the project, where `using' is a generic term including compiling the project's source code as well as linking it to form a `program' or `executable'. This program is referred to as `a program using the FreeType engine'. This license applies to all files distributed in the original FreeType Project, including all source code, binaries and documentation, unless otherwise stated in the file in its original, unmodified form as distributed in the original archive. If you are unsure whether or not a particular file is covered by this license, you must contact us to verify this.

Throughout this license, the terms `package', `FreeType Project', and `FreeType archive' refer to the set of files originally distributed by the authors (David Turner, Robert Wilhelm, and Werner Lemberg) as the `FreeType Project', be they named as alpha, beta or final release. `You' refers to the licensee, or person using the project, where `using' is a generic term including compiling the project's source code as well as linking it to form a `program' or `executable'. This program is referred to as `a program using the FreeType engine'. This license applies to all

>>

files distributed in the original FreeType Project, including all source code, binaries and documentation, unless otherwise stated in the file in its original, unmodified form as distributed in the original archive. If you are unsure whether or not a particular file is covered by this license, you must contact us to verify this.

### No Warranty

THE FREETYPE PROJECT IS PROVIDED `AS IS' WITHOUT WARRANTY OF ANY KIND, EITHER EXPRESS OR IMPLIED, INCLUDING, BUT NOT LIMITED TO, WARRANTIES OF MERCHANTABILITY AND FITNESS FOR A PARTICULAR PURPOSE. IN NO EVENT WILL ANY OF THE AUTHORS OR COPYRIGHT HOLDERS BE LIABLE FOR ANY DAMAGES CAUSED BY THE USE OR THE INABILITY TO USE, OF THE FREETYPE PROJECT. Redistribution

### Redistribution

This license grants a worldwide, royalty-free, perpetual and irrevocable right and license to use, execute, perform, compile, display, copy, create derivative works of, distribute and sublicense the FreeType Project (in both source and object code forms) and derivative works thereof for any purpose; and to authorize others to exercise some or all of the rights granted herein, subject to the following conditions:

Redistribution of source code must retain this license file ( `FTL.TXT') unaltered; any additions, deletions or changes to the original files must be clearly indicated in accompanying documentation. The copyright notices of the unaltered, original files must be preserved in all copies of source files. Redistribution in binary form must provide a disclaimer that states that the software is based in part of the work of the FreeType Team, in the distribution documentation. We also encourage you to put an URL to the FreeType web page in your documentation,

though this isn't mandatory. These conditions apply to any software derived from or based on the FreeType Project, not just the unmodified files. If you use our work, you must acknowledge us. However, no fee need be paid to us.

### Advertising

Neither the FreeType authors and contributors nor you shall use the name of the other for commercial, advertising, or promotional purposes without specific prior written permission. We suggest, but do not require, that you use one or more of the following phrases to refer to this software in your documentation or advertising materials: `FreeType Project', `FreeType Engine', `FreeType library', or `FreeType Distribution'. As you have not signed this license, you are not required to accept it. However, as the FreeType Project is copyrighted material, only this license, or another one contracted with the authors, grants you the right to use, distribute, and modify it. Therefore, by using, distributing, or modifying the FreeType Project, you indicate that you understand and accept all the terms of this license.

### Contacts

There are two mailing lists related to FreeType: [freetype@nongnu.org](mailto:freetype@nongnu.org)

Discusses general use and applications of FreeType, as well as future and wanted additions to the library and distribution. If you are looking for support, start in this list if you haven't found anything to help you in the documentation.

[devel@nongnu.org](mailto:devel@nongnu.org)

Discusses bugs, as well as engine internals, design issues, specific licenses, porting, etc.

Our home page can be found at: <http://www.freetype.org>

## 2.8 Independent JPEG Group License

The Independent JPEG Group's JPEG software README for release 6b of 27-Mar-1998

This distribution contains the sixth public release of the Independent JPEG Group's free JPEG software. You are welcome to redistribute this software and to use it for any purpose, subject to the conditions under LEGAL ISSUES, below. Serious users of this software (particularly those incorporating it into larger programs) should contact IJG at [jpeg-info@uunet.uu.net](mailto:jpeg-info@uunet.uu.net) to be added to our electronic mailing list. Mailing list members are notified of updates and have a chance to participate in technical discussions, etc. This software is the work of Tom Lane, Philip Gladstone, Jim Boucher, Lee Crocker, Julian Minguillon, Luis Ortiz, George Phillips, Davide Rossi, Guido Vollbeding, Ge' Weijers, and other members of the Independent JPEG Group. IJG is not affiliated with the official ISO JPEG standards committee.

### LEGAL ISSUES

In plain English:

We don't promise that this software works. (But if you find any bugs, please let us know!) You can use this software for whatever you want. You don't have to pay us. You may not pretend that you wrote this software. If you use it in a program, you must acknowledge somewhere in your documentation that you've used the IJG code. In legalese:

The authors make NO WARRANTY or representation, either express or implied, with respect to this software, its quality, accuracy, merchantability, or fitness for a particular purpose. This software is provided "AS IS", and you, its user, assume the entire risk as to its quality and accuracy. This software is copyright (C) 1991-1998, Thomas G. Lane. All Rights Reserved except as specified below.

Permission is hereby granted to use, copy, modify, and distribute this software (or portions thereof) for any purpose, without fee, subject to these conditions:

1. If any part of the source code for this software is distributed, then this README file must be included, with this copyright and no-warranty notice unaltered; and any additions, deletions, or changes to the original files must be clearly indicated in accompanying documentation.
2. If only executable code is distributed, then the accompanying documentation must state that "this software is based in part on the work of the Independent JPEG Group".
3. Permission for use of this software is granted only if the user accepts full responsibility for any undesirable consequences; the authors accept NO LIABILITY for damages of any kind.

These conditions apply to any software derived from or based on the IJG code, not just to the unmodified library. If you use our work, you ought to acknowledge us.

Permission is NOT granted for the use of any IJG author's name or company name in advertising or publicity relating to this software or products derived from it. This software may be referred to only as "the Independent JPEG Group's software".

We specifically permit and encourage the use of this software as the basis of commercial products, provided that all warranty or liability claims are assumed by the product vendor. `ansi2knr.c` is included in this distribution by permission of L. Peter Deutsch, sole proprietor of its copyright holder, Aladdin Enterprises of Menlo Park, CA. `ansi2knr.c` is NOT covered by the above copyright and conditions, but instead by the usual distribution terms of the Free Software Foundation; principally, that you must include source

>>

code if you redistribute it. (See the file ansi2knr.c for full details.)

However, since ansi2knr.c is not needed as part of any program generated from the IJG code, this does not limit you more than the foregoing paragraphs do. The Unix configuration script "configure" was produced with GNU Autoconf. It is copyright by the Free Software Foundation but is freely distributable. The same holds for its supporting scripts (config.guess, config.sub, ltconfig, ltmain.sh). Another support script, install-sh, is copyright by M.I.T. but is also freely distributable.

It appears that the arithmetic coding option of the JPEG spec is covered by patents owned by IBM, AT&T, and Mitsubishi. Hence arithmetic coding cannot legally be used without obtaining one or more licenses. For this reason, support for arithmetic coding has been removed from the free JPEG software. (Since arithmetic coding provides only a marginal gain over the unpatented Huffman mode, it is unlikely that very many implementations will support it.) So far as we are aware, there are no patent restrictions on the remaining code.

The IJG distribution formerly included code to read and write GIF files. To avoid entanglement with the Unisys LZW patent, GIF reading support has been removed altogether, and the GIF writer has been simplified to produce "uncompressed GIFs". This technique does not use the LZW algorithm; the resulting GIF files are larger than usual, but are readable by all standard GIF decoders. We are required to state that:

"The Graphics Interchange Format(c) is the Copyright property of CompuServe Incorporated. GIF(sm) is a Service Mark property of CompuServe Incorporated."

## 2.9 Internet Software Consortium-IBM License

Copyright (c) 1996 by Internet Software Consortium.

Permission to use, copy, modify, and distribute this software for any purpose with or without fee is hereby granted, provided that the above copyright notice and this permission notice appear in all copies.

THE SOFTWARE IS PROVIDED "AS IS" AND INTERNET SOFTWARE CONSORTIUM DISCLAIMS ALL WARRANTIES WITH REGARD TO THIS SOFTWARE INCLUDING ALL IMPLIED WARRANTIES OF MERCHANTABILITY AND FITNESS. IN NO EVENT SHALL INTERNET SOFTWARE CONSORTIUM BE LIABLE FOR ANY SPECIAL, DIRECT, INDIRECT, OR CONSEQUENTIAL DAMAGES OR ANY DAMAGES WHATSOEVER RESULTING FROM LOSS OF USE, DATA OR PROFITS, WHETHER IN AN ACTION OF CONTRACT, NEGLIGENCE OR OTHER TORTIOUS ACTION, ARISING OUT OF OR IN CONNECTION WITH THE USE OR PERFORMANCE OF THIS SOFTWARE.

Portions Copyright (c) 1995 by International Business Machines, Inc.

International Business Machines, Inc. (hereinafter called IBM) grants permission under its copyrights to use, copy, modify, and distribute this Software with or without fee, provided that the above copyright notice and all paragraphs of this notice appear in all copies, and that the name of IBM not be used in connection with the marketing of any product incorporating the Software or modifications thereof, without specific, written prior permission.

To the extent it has a right to do so, IBM grants an immunity from suit under its patents, if any, for the use, sale or manufacture of products to the extent that such products are used for performing Domain Name System dynamic



updates in TCP/IP networks by means of the Software. No immunity is granted for any product per se or for any other function of any product.

THE SOFTWARE IS PROVIDED "AS IS", AND IBM DISCLAIMS ALL WARRANTIES, INCLUDING ALL IMPLIED WARRANTIES OF MERCHANTABILITY AND FITNESS FOR A PARTICULAR PURPOSE. IN NO EVENT SHALL IBM BE LIABLE FOR ANY SPECIAL, DIRECT, INDIRECT, OR CONSEQUENTIAL DAMAGES OR ANY DAMAGES WHATSOEVER ARISING OUT OF OR IN CONNECTION WITH THE USE OR PERFORMANCE OF THIS SOFTWARE, EVEN IF IBM IS APPRISED OF THE POSSIBILITY OF SUCH DAMAGES.

## 2.10 Khronos License

Copyright (c) 2013 The Khronos Group Inc.

\*\* \*\* Permission is hereby granted, free of charge, to any person obtaining a \*\* copy of this software and/or associated documentation files (the \*\* "Materials"), to deal in the Materials without restriction, including \*\* without limitation the rights to use, copy, modify, merge, publish, \*\* distribute, sublicense, and/or sell copies of the Materials, and to \*\* permit persons to whom the Materials are furnished to do so, subject to \*\* the following conditions: \*\* \*\* The above copyright notice and this permission notice shall be included \*\* in all copies or substantial portions of the Materials. \*\*

\*\* THE MATERIALS ARE PROVIDED "AS IS", WITHOUT WARRANTY OF ANY KIND, \*\* EXPRESS OR IMPLIED, INCLUDING BUT NOT LIMITED TO THE WARRANTIES OF \*\* MERCHANTABILITY, FITNESS FOR A PARTICULAR PURPOSE AND NONINFRINGEMENT. \*\* IN NO EVENT SHALL THE AUTHORS OR COPYRIGHT HOLDERS BE LIABLE FOR ANY \*\* CLAIM, DAMAGES OR OTHER LIABILITY, WHETHER

IN AN ACTION OF CONTRACT, \*\* TORT OR OTHERWISE, ARISING FROM, OUT OF OR IN CONNECTION WITH THE \*\* MATERIALS OR THE USE OR OTHER DEALINGS IN THE MATERIALS.

## 2.11 License of Stephan Brumme/ Zlib style License

This software is provided 'as-is', without any express or implied warranty. In no event will the author be held liable for any damages arising from the use of this software. Permission is granted to anyone to use this software for any purpose, including commercial applications, and to alter it and redistribute it freely, subject to the following restrictions: The origin of this software must not be misrepresented; you must not claim that you wrote the original software. If you use this software in a product, an acknowledgment in the product documentation would be appreciated but is not required. Altered source versions must be plainly marked as such, and must not be misrepresented as being the original software.

## 2.12 MIT License

The MIT License

Copyright/Copyright holders – see List of Open Source Components

Permission is hereby granted, free of charge, to any person obtaining a copy of this software and associated documentation files (the "Software"), to deal in the Software without restriction, including without limitation the rights to use, copy, modify, merge, publish, distribute, sublicense, and/or sell copies of the Software, and to permit persons to whom the Software is furnished to do so, subject to the following conditions:

The above copyright notice and this permission notice shall be included in all copies or substantial portions of the Software.

THE SOFTWARE IS PROVIDED "AS IS", WITHOUT WARRANTY OF ANY KIND, EXPRESS OR IMPLIED, INCLUDING BUT NOT LIMITED TO THE WARRANTIES OF MERCHANTABILITY, FITNESS FOR A PARTICULAR PURPOSE AND NONINFRINGEMENT. IN NO EVENT SHALL THE AUTHORS OR COPYRIGHT HOLDERS BE LIABLE FOR ANY CLAIM, DAMAGES OR OTHER LIABILITY, WHETHER IN AN ACTION OF CONTRACT, TORT OR OTHERWISE, ARISING FROM, OUT OF OR IN CONNECTION WITH THE SOFTWARE OR THE USE OR OTHER DEALINGS IN THE SOFTWARE.

### 2.13 Open Group License

Copyright 1996, 1998 The Open Group.

Permission to use, copy, modify, distribute, and sell this software and its documentation for any purpose is hereby granted without fee, provided that the above copyright notice appear in all copies and that both that copyright notice and this permission notice appear in supporting documentation. The above copyright notice and this permission notice shall be included in all copies or substantial portions of the Software.

THE SOFTWARE IS PROVIDED "AS IS", WITHOUT WARRANTY OF ANY KIND, EXPRESS OR IMPLIED, INCLUDING BUT NOT LIMITED TO THE WARRANTIES OF MERCHANTABILITY, FITNESS FOR A PARTICULAR PURPOSE AND NONINFRINGEMENT. IN NO EVENT SHALL THE OPEN GROUP BE LIABLE FOR ANY CLAIM, DAMAGES OR OTHER LIABILITY, WHETHER IN AN ACTION OF CONTRACT, TORT OR OTHERWISE, ARISING FROM, OUT OF OR IN CONNECTION WITH THE SOFTWARE OR THE USE OR OTHER DEALINGS IN THE SOFTWARE.

Except as contained in this notice, the name of The Open Group shall not be used in advertising or otherwise to promote the sale, use or other dealings in this Software without prior written authorization from The Open Group.

### 2.14 Public Domain

Public domain code is not subject to any license.

### 2.15 BSD One Clause License

BSD One Clause License

Copyright/Copyright holders – see List of Open Source Components

All rights reserved.

Redistribution and use in source and binary forms, with or without modification, are permitted provided that the following conditions are met:

\* Redistributions of source code must retain the above copyright notice, this list of conditions and the following disclaimer.

THIS SOFTWARE IS PROVIDED BY THE COPYRIGHT HOLDERS AND CONTRIBUTORS "AS IS" AND ANY EXPRESS OR IMPLIED WARRANTIES, INCLUDING, BUT NOT LIMITED TO, THE IMPLIED WARRANTIES OF MERCHANTABILITY AND FITNESS FOR A PARTICULAR PURPOSE ARE DISCLAIMED. IN NO EVENT SHALL THE COPYRIGHT OWNER OR CONTRIBUTORS BE LIABLE FOR ANY DIRECT, INDIRECT, INCIDENTAL, SPECIAL, EXEMPLARY, OR CONSEQUENTIAL DAMAGES (INCLUDING, BUT NOT LIMITED TO, PROCUREMENT OF SUBSTITUTE GOODS OR SERVICES; LOSS OF USE, DATA, OR PROFITS; OR BUSINESS INTERRUPTION) HOWEVER CAUSED AND ON ANY THEORY OF LIABILITY, WHETHER IN CONTRACT, STRICT LIABILITY, OR TORT (INCLUDING NEGLIGENCE OR OTHERWISE) ARISING IN ANY WAY OUT OF THE USE OF

THIS SOFTWARE, EVEN IF ADVISED OF THE POSSIBILITY OF SUCH DAMAGE.

## 2.16 ISC License

### ISC License (ISCL)

Copyright/Copyright holders – see List of Open Source Components

Permission to use, copy, modify, and/or distribute this software for any purpose with or without fee is hereby granted, provided that the above copyright notice and this permission notice appear in all copies.

THE SOFTWARE IS PROVIDED "AS IS" AND THE AUTHOR DISCLAIMS ALL WARRANTIES WITH REGARD TO THIS SOFTWARE INCLUDING ALL IMPLIED WARRANTIES OF MERCHANTABILITY AND FITNESS. IN NO EVENT SHALL THE AUTHOR BE LIABLE FOR ANY SPECIAL, DIRECT, INDIRECT, OR CONSEQUENTIAL DAMAGES OR ANY DAMAGES WHATSOEVER RESULTING FROM LOSS OF USE, DATA OR PROFITS, WHETHER IN AN ACTION OF CONTRACT, NEGLIGENCE OR OTHER TORTIOUS ACTION, ARISING OUT OF OR IN CONNECTION WITH THE USE OR PERFORMANCE OF THIS SOFTWARE.

## 2.17 SGI Free Software License B v2.0

### ISC License (ISCL)

Copyright/Copyright holders – see List of Open Source Components

Permission is hereby granted, free of charge, to any person obtaining a copy of this software and associated documentation files (the "Software"), to deal in the Software without restriction, including without limitation the rights to use, copy, modify, merge, publish, distribute, sublicense, and/or sell copies of the Software, and to permit persons to whom the Software is fur-

nished to do so, subject to the following conditions:

The above copyright notice including the dates of first publication and either this permission notice or a reference to <http://oss.sgi.com/projects/FreeB/> shall be included in all copies or substantial portions of the Software.

THE SOFTWARE IS PROVIDED "AS IS" AND THE AUTHOR DISCLAIMS ALL WARRANTIES WITH REGARD TO THIS SOFTWARE INCLUDING ALL IMPLIED WARRANTIES OF MERCHANTABILITY AND FITNESS. IN NO EVENT SHALL THE AUTHOR BE LIABLE FOR ANY SPECIAL, DIRECT, INDIRECT, OR CONSEQUENTIAL DAMAGES OR ANY DAMAGES WHATSOEVER RESULTING FROM LOSS OF USE, DATA OR PROFITS, WHETHER IN AN ACTION OF CONTRACT, NEGLIGENCE OR OTHER TORTIOUS ACTION, ARISING OUT OF OR IN CONNECTION WITH THE USE OR PERFORMANCE OF THIS SOFTWARE.

Except as contained in this notice, the name of Silicon Graphics, Inc. shall not be used in advertising or otherwise to promote the sale, use or other dealings in this Software without prior written authorization from Silicon Graphics, Inc.

## 2.18 Unicode Terms of Use

For the general privacy policy governing access to this site, see the Unicode Privacy Policy. For trademark usage, see the Unicode® Consortium Name and Trademark Usage Policy.

### A. Unicode Copyright.

1. Copyright © 1991-2014 Unicode, Inc. All rights reserved.
2. Certain documents and files on this website contain a legend indicating that "Modification is permitted." Any person is hereby authorized, without fee, to modify such documents and files to create derivative

>>

works conforming to the Unicode® Standard, subject to Terms and Conditions herein.

3. Any person is hereby authorized, without fee, to view, use, reproduce, and distribute all documents and files solely for informational purposes in the creation of products supporting the Unicode Standard, subject to the Terms and Conditions herein.
4. Further specifications of rights and restrictions pertaining to the use of the particular set of data files known as the "Unicode Character Database" can be found in Exhibit 1.
5. Each version of the Unicode Standard has further specifications of rights and restrictions of use. For the book editions (Unicode 5.0 and earlier), these are found on the back of the title page. The online code charts carry specific restrictions. All other files, including online documentation of the core specification for Unicode 6.0 and later, are covered under these general Terms of Use.
6. No license is granted to "mirror" the Unicode website where a fee is charged for access to the "mirror" site.
7. Modification is not permitted with respect to this document. All copies of this document must be verbatim.

#### B. Restricted Rights Legend.

Any technical data or software which is licensed to the United States of America, its agencies and/or instrumentalities under this Agreement is commercial technical data or commercial computer software developed exclusively at private expense as defined in FAR 2.101, or DFARS 252.227-7014 (June 1995), as applicable. For technical data, use, duplication, or disclosure by the Government is subject to restrictions as set forth in DFARS 202.227-7015 Technical Data,

Commercial and Items (Nov 1995) and this Agreement. For Software, in accordance with FAR 12-212 or DFARS 227-7202, as applicable, use, duplication or disclosure by the Government is subject to the restrictions set forth in this Agreement.

#### C. Warranties and Disclaimers.

1. This publication and/or website may include technical or typographical errors or other inaccuracies. Changes are periodically added to the information herein; these changes will be incorporated in new editions of the publication and/or website. Unicode may make improvements and/or changes in the product(s) and/or program(s) described in this publication and/or website at any time.
2. If this file has been purchased on magnetic or optical media from Unicode, Inc. the sole and exclusive remedy for any claim will be exchange of the defective media within ninety (90) days of original purchase.
3. EXCEPT AS PROVIDED IN SECTION C.2, THIS PUBLICATION AND/OR SOFTWARE IS PROVIDED "AS IS" WITHOUT WARRANTY OF ANY KIND EITHER EXPRESS, IMPLIED, OR STATUTORY, INCLUDING, BUT NOT LIMITED TO, ANY WARRANTIES OF MERCHANTABILITY, FITNESS FOR A PARTICULAR PURPOSE, OR NON-INFRINGEMENT. UNICODE AND ITS LICENSORS ASSUME NO RESPONSIBILITY FOR ERRORS OR OMISSIONS IN THIS PUBLICATION AND/OR SOFTWARE OR OTHER DOCUMENTS WHICH ARE REFERENCED BY OR LINKED TO THIS PUBLICATION OR THE UNICODE WEBSITE.

#### D. Waiver of Damages.

In no event shall Unicode or its licensors be liable for any special, incidental, indirect or consequential damages of any kind, or any damages

whatsoever, whether or not Unicode was advised of the possibility of the damage, including, without limitation, those resulting from the following: loss of use, data or profits, in connection with the use, modification or distribution of this information or its derivatives.

#### E. Trademarks & Logos.

1. The Unicode Word Mark and the Unicode Logo are trademarks of Unicode, Inc. "The Unicode Consortium" and "Unicode, Inc." are trade names of Unicode, Inc. Use of the information and materials found on this website indicates your acknowledgement of Unicode, Inc.'s exclusive worldwide rights in the Unicode Word Mark, the Unicode Logo, and the Unicode trade names.
2. The Unicode Consortium Name and Trademark Usage Policy ("Trademark Policy") are incorporated herein by reference and you agree to abide by the provisions of the Trademark Policy, which may be changed from time to time in the sole discretion of Unicode, Inc.
3. All third party trademarks referenced herein are the property of their respective owners.

#### F. Miscellaneous.

1. Jurisdiction and Venue. This server is operated from a location in the State of California, United States of America. Unicode makes no representation that the materials are appropriate for use in other locations. If you access this server from other locations, you are responsible for compliance with local laws. This Agreement, all use of this site and any claims and damages resulting from use of this site are governed solely by the laws of the State of California without regard to any principles which would apply the laws of a different jurisdiction. The user agrees that any disputes regarding this site shall be resolved

solely in the courts located in Santa Clara County, California. The user agrees said courts have personal jurisdiction and agree to waive any right to transfer the dispute to any other forum.

2. Modification by Unicode. Unicode shall have the right to modify this Agreement at any time by posting it to this site. The user may not assign any part of this Agreement without Unicode's prior written consent.
3. Taxes. The user agrees to pay any taxes arising from access to this website or use of the information herein, except for those based on Unicode's net income.
4. Severability. If any provision of this Agreement is declared invalid or unenforceable, the remaining provisions of this Agreement shall remain in effect.
5. Entire Agreement. This Agreement constitutes the entire agreement between the parties.

#### 2.19 libpng License

This copy of the libpng notices is provided for your convenience. In case of any discrepancy between this copy and the notices in the file png.h that is included in the libpng distribution, the latter shall prevail.

#### COPYRIGHT NOTICE, DISCLAIMER, and LICENSE:

The above copyright notice and this permission notice shall be included in all copies or substantial portions of the Software.

If you modify libpng you may insert additional notices immediately following this sentence. libpng versions 1.0.7, July 1, 2000, through 1.0.13, April 15, 2002, are Copyright (c) 2000-2002 Glenn Randers-Pehrson and are distributed according to the same disclaimer and license as

libpng-1.0.6 with the following individuals added to the list of Contributing Authors:

Simon-Pierre Cadieux, Eric S. Raymond, Gilles Vollant

and with the following additions to the disclaimer:

There is no warranty against interference with your enjoyment of the library or against infringement. There is no warranty that our efforts or the library will fulfill any of your particular purposes or needs. This library is provided with all faults, and the entire risk of satisfactory quality, performance, accuracy, and effort is with the user.

libpng versions 0.97, January 1998, through 1.0.6, March 20, 2000, are Copyright (c) 1998, 1999 Glenn Randers-Pehrson, and are distributed according to the same disclaimer and license as libpng-0.96, with the following individuals added to the list of Contributing Authors:

Tom Lane, Glenn Randers-Pehrson, Willem van Schaik.

libpng versions 0.89, June 1996, through 0.96, May 1997, are Copyright (c) 1996, 1997 Andreas Dilger Distributed according to the same disclaimer and license as libpng-0.88, with the following individuals added to the list of Contributing Authors:

John Bowler, Kevin Bracey, Sam Bushe, Magnus Holmgren, Greg Roelofs, Tom Tanner.

libpng versions 0.5, May 1995, through 0.88, January 1996, are Copyright (c) 1995, 1996 Guy Eric Schalnat, Group 42, Inc. For the purposes of this copyright and license, "Contributing Authors" is defined as the following set of individuals:

Andreas Dilger, Dave Martindale, Guy Eric Schalnat, Paul Schmidt, Tim Wegner.

The PNG Reference Library is supplied "AS IS". The Contributing Authors and Group 42, Inc. disclaim all warranties, expressed or implied, including, without limitation, the warranties of merchantability and of fitness for any purpose. The Contributing Authors and Group 42, Inc. assume no liability for direct, indirect, incidental, special, exemplary, or consequential damages, which may result from the use of the PNG Reference Library, even if advised of the possibility of such damage. Permission is hereby granted to use, copy, modify, and distribute this source code, or portions hereof, for any purpose, without fee, subject to the following restrictions:

1. The origin of this source code must not be misrepresented.
2. Altered versions must be plainly marked as such and must not be misrepresented as being the original source.
3. This Copyright notice may not be removed or altered from any source or altered source distribution.

The Contributing Authors and Group 42, Inc. specifically permit, without fee, and encourage the use of this source code as a component to supporting the PNG file format in commercial products. If you use this source code in a product, acknowledgment is not required but would be appreciated. A "png\_get\_copyright" function is available, for convenient use in "about" boxes and the like:

```
printf("%s",png_get_copyright(NULL));
```

Also, the PNG logo (in PNG format, of course) is supplied in the files "pngbar.png" and "pngbar.jpg" (88x31) and "pngnow.png" (98x31).

Libpng is OSI Certified Open Source Software. OSI Certified Open Source is a certification mark of the Open Source Initiative.

Glenn Randers-Pehrson

randeg@alum.rpi.edu

April 15, 2002

## 2.20 zlib License

Copyright/Copyright holders – see List of Open Source Components

This software is provided 'as-is', without any express or implied warranty. In no event will the authors be held liable for any damages arising from the use of this software.

Permission is granted to anyone to use this software for any purpose, including commercial applications, and to alter it and redistribute it freely, subject to the following restrictions:

1. The origin of this software must not be misrepresented; you must not claim that you wrote the original software. If you use this software in a product, an acknowledgment in the product documentation would be appreciated but is not required.
2. Altered source versions must be plainly marked as such, and must not be misrepresented as being the original software.
3. This notice may not be removed or altered from any source distribution.

## Related information

- Driver display (p. 72)

# Messages in the driver display

The driver display can show messages to inform or assist the driver in the event of different events.



Examples of messages in the driver display.

Messages are shown in the middle of the driver display. The composition may vary and is shown together with graphics, symbols or buttons for acknowledging the message or accepting a request, for example.

## Managing messages



Right-hand keypad on the steering wheel.

- ① Left/right
- ② Confirm

The message disappears from the driver display when it has been acknowledged/acted on and can instead be seen in the notification view of the centre display.

## Service messages

Shown below is a selection of service messages and their meanings.

Message	Specification
Stop safely <sup>A</sup>	Stop and contact Polestar Support. Serious risk of damage.
Book time for regular maintenance	Time for a service – contact Polestar Support <sup>A</sup> . Shown before the next service date.
Time for regular maintenance	Time for a service – contact Polestar Support <sup>A</sup> . Shown at the next service date.
Regular maintenance overdue	Time for a service – contact Polestar Support <sup>A</sup> . Shown when the service date has passed.

<sup>A</sup> Part of message, shown together with information on where the problem has arisen.

## Related information

- Driver display (p. 72)
- Driver display settings (p. 74)
- Messages in the centre display (p. 123)



# Overview of centre display



Many of the car's functions are controlled from the centre display. Presented here is the centre display and its options.

## Home view



*Home view is the first view shown when the screen is started.*

The home view consists of four tiles that show the last used apps. The centre display's different views can also be reached from the home view,

>>

such as climate view, camera view, car function view, app view and user profiles.

### Camera view

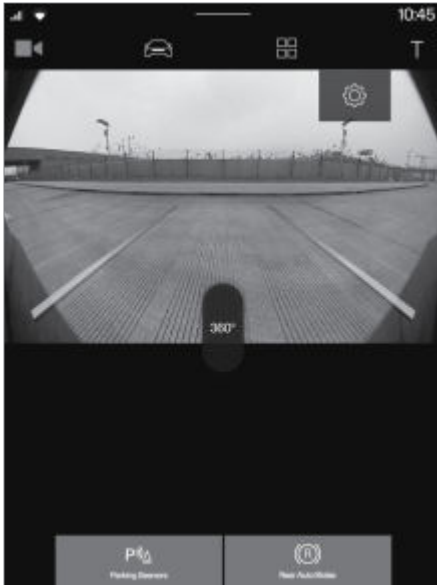

Camera view shows the park assist cameras (PAC<sup>6</sup>), which displays a composite 360° view and separate views for each of the four cameras: rear, front, left or right camera view.

### App view



The view for apps that have been downloaded (third-party apps) or for the car's built-in functions.

## User profiles

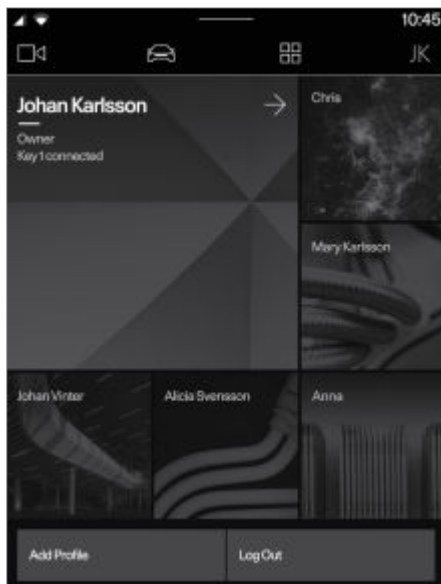

Many of the settings made in the car can be adapted according to the user's personal preferences and can be saved in different user profiles.

## Car functions

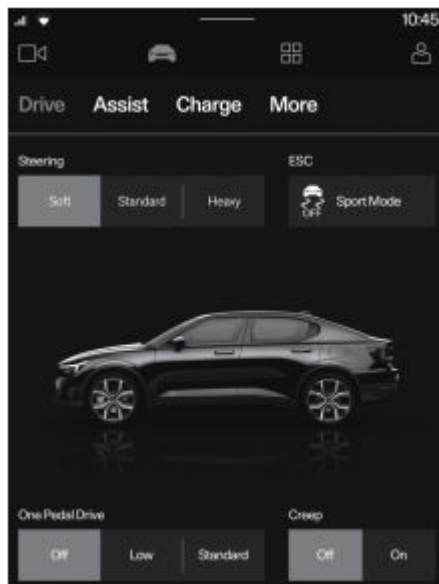

View showing car functions.

### Related information

- Managing the centre display (p. 109)
- Centre display's views (p. 110)
- Moving apps in centre display (p. 113)
- Apps (p. 415)
- Symbols in the centre display's status bar (p. 113)
- Google Maps (p. 442)
- Bluetooth Media Player (p. 419)
- Phone (p. 420)
- Climate controls (p. 181)
- Audio settings (p. 414)

>>

- Changing system language (p. 117)
- Changing system units (p. 117)
- Cleaning the centre display (p. 520)
- Messages in the centre display (p. 123)
- Charging in the car's centre display (p. 366)

## NOTE

If necessary, the climate control can be used to cool down the media system in the centre display. In these cases, the message Cooling infotainment system is shown in the driver display.

# Managing the centre display

Many of the car's functions are controlled and regulated from the centre display. The centre display is a touch screen that reacts to touch.

## Using the touch screen functionality in the centre display

The screen reacts differently depending on whether you press, drag or swipe across it. Actions such as browsing between different views, marking objects, scrolling in a list and moving apps can be performed by touching the screen in different ways.

The centre display is a capacitive touchscreen.

Two people can interact with the screen at the same time, e.g. to adjust the climate for the driver and passenger side respectively.

## Returning to home view from another view

- Briefly press the home button below the centre display.
  - > The last position of the home view is shown.

## Using the controls in the centre display

The control is used for many of the car's functions. Regulate e.g. temperature by means of one of the following:

- drag the control to the desired temperature,
- tap on + or – in order to raise or lower the temperature gradually, or
- tap on the desired temperature on the control.

## Related information

- Moving apps in centre display (p. 113)
- Keyboard in centre display (p. 114)

- Cleaning the centre display (p. 520)

### IMPORTANT

Do not use sharp objects on the screen as they may scratch it.

### NOTE

Wearing gloves may restrict or impede touchscreen response.

# Centre display's views

The centre display is started automatically when the driver's door is opened.

## Home view

Home view is the view that is shown when the screen is started. It is made up of four subviews.

It is possible to make your own choices on which apps are to be shown in subviews in home view. An app selected from the app view starts in the relevant subview in the home view.

The subviews are dynamic and show the last apps used, e.g. navigation, media or phone. Tap on the desired app to expand it, or swipe downwards on the tile to view more apps.

## Status field

The activities in the car are shown at the top of the screen. Among other things, the status field shows other network and connection information, as well as the time.

## Notification view

The car's notifications are collected together at the top of the screen.

Drag the tab down in order to access the notification view. Missed calls or information relating to the car, for example, are shown here.

Exit the notification view by tapping outside of notifications, on the home button, or by swiping upwards. The underlying view is then visible and available for use again.

## Climate view

The climate row is available at the bottom of the screen. The most common climate settings can be made directly there, such as setting temperature and seat heating.

Sweep up on the climate row to open the climate view with more setting options.

Swipe down on the climate view or press the home button to close the climate view.

## Camera view

The camera view starts automatically when gear position R is used.

Camera view shows the park assist cameras (PAC<sup>7</sup>), which displays a composite 360° view and separate views for each of the four cameras: rear, front, left or right camera view.

The camera view is closed automatically when the car is driving at a certain speed or by tapping on .

## App view

Tap on  at the top of the centre display.

Apps that have been downloaded, both third-party apps and apps for embedded functions.

Tap on an app to open it in full screen mode.

Go back to the home view by tapping on .

## Car functions

Tap on  to access car functions from the home view. From here it is possible to manage settings and activate or deactivate different functions.

- Drive – settings for steering and brakes, for example.
- Assist – activate or deactivate various driver support functions.
- Charge – activated automatically when charging. Option to set the amperage and

# Managing subviews in centre display

timer and unlock the charging cable. Shows charging stations and saved locations.

- More – Settings that apply to wireless phone charger, exterior and interior lighting, mirrors, seats, locking, as well as wiper blades. Information on the car status and servicing can also be found here.

Go back to the home view by tapping on .

## User profiles

Tap on the initials or the  symbol at the top of the centre display to access user profiles from the home view.

Many of the settings made in the car can be adapted according to the user's personal preferences and can be saved in different user profiles.

Settings that can be saved in a user profile include, amongst other things, screens, mirrors, front seats, navigation, audio and media system, language and voice control.

Go back to the home view by tapping on the initials or the  symbol.

## Related information

- Managing subviews in centre display (p. 111)
- Symbols in the centre display's status bar (p. 113)
- Resetting user data (p. 118)
- User profiles (p. 118)
- Climate controls (p. 181)
- Apps (p. 415)
- Car function view in the centre display (p. 112)
- Overview of centre display (p. 105)
- Charging in the car's centre display (p. 366)
- Moving apps in centre display (p. 113)

The centre display's home view and app view include subviews that can be expanded.

## Expanding an app in home view

Expanding an app:

- Tap on the desired app. When an app is opened, the other apps are temporarily suppressed.

An open app gives access to its basic functions.

Closing an app:

- Briefly press the physical home button below the centre display.

## Expanding a tile in app view

Expanding a subview:

- Press **•••**
  - > The tile is expanded and provides access to additional apps.

Closing an expanded subview:

- The subview can be closed in two ways:
  - Press 
  - Briefly tap on the home button in the bottom of the centre display.

# Car function view in the centre display



Home button for the centre display.

There is always the option to go back to home view by pressing the home button.

## Related information

- Managing the centre display (p. 109)
- Centre display's views (p. 110)

Type of button	Property	Affects car function
Selection buttons	Selection of function mode.	Selection buttons are available in the car function view and charging view, for example.
Function buttons	Have on/off positions.	Most buttons in function view are function buttons.

## The various button modes and functions

Press the button once briefly to activate or deactivate the function.

The function is activated when the entire button for a function button or selection button is lit up. The function is deactivated when the button is extinguished.

When a function is activated, extra text with an explanation for certain functions is shown. The text is displayed for a few seconds, and then the button lights up.

All settings and buttons are collected under the various subviews in the car function view. Navigate to the car function view from the home view by tapping on .

To toggle between the subviews in the car function view, tap on the preferred heading. For further functions, tap on More.

## Different types of buttons

There are different types of buttons for car functions; see below:

Some functions have further settings. Tap on **•••** to access these.

## Related information

- Managing the centre display (p. 109)
- Centre display's views (p. 110)



# Moving apps in centre display

The app view consists of four tiles where the apps can be moved and organised according to requirements, expand a tile for access to more apps than those shown.

Newly installed apps are located in the app view.

Moving apps in the centre display:

1. Tap on  at the top of the centre display.
2. Tap on an app and hold it down.
  - > It is then possible to move it.
3. Drag the app to the required location in the app view.

Swipe across the screen to scroll up or down in the view.

## Related information

- Car function view in the centre display (p. 112)
- Apps (p. 415)
- Managing the centre display (p. 109)







## NOTE

- It is not possible to move apps so that a subview is left with no apps.
- Apps cannot be added to locations that are already occupied.

# Symbols in the centre display's status bar

Below is an overview of the symbols that can be shown in the centre display's status bar.

The status bar shows activities in progress and, in some cases, their status. Not all symbols are shown all the time due to the limited space in the status bar.

Symbol	Specification
	Connected to the Internet.
	Roaming activated.
	Bluetooth device connected.
	Information sent to and from GPS.
	Clock.
	Wireless phone charging

## Related information

- Centre display's views (p. 110)
- Messages in the centre display (p. 123)
- Phone (p. 420)
- Date and time (p. 71)

# Keyboard in centre display

The centre display keyboard makes it possible to make entries using keys. It is also possible to "draw in" letters and characters on the screen by hand.

The keyboard can be used to enter characters, letters and numbers, e.g. to write text messages from the car, enter passwords or search for articles in the Manual in the centre display.

The keyboard is only shown when entries can be made on the screen.

- Managing the centre display (p. 109)
- Managing text messages (p. 424)



Hides the keyboard. If this is not possible, the button is not shown.



Changes keyboard mode to write letters and characters by hand instead.

Pressing the confirmation button above the keypad confirms the entered text. The appearance of the button differs depending on context.

## Variants of a letter or character

Variants of a letter or character, e.g. é or è, can be entered by holding down the letter or character. A box is displayed showing possible variants of letters or characters. Press the required variant. If no variant is selected, the original letter/character is entered.

## Related information



- Changing keyboard language in centre display (p. 115)
- Enter the characters, letters and words manually in the centre display (p. 116)

# Changing keyboard language in centre display

To make it possible to switch between different languages for the keyboard, the languages must first be added under Settings.

## Adding or deleting languages in settings

The keyboard is automatically set to the same languages as the system language. Keyboard language can be adapted manually without affecting the system language.

1. Press   
Tap on  at the bottom of the display.
2. Tap on System, Language and inputs Keyboard.
3. Select one or more languages from the list.
  - > It is now possible to switch between the selected languages directly from the keyboard for text input.

If no languages have been actively selected under Settings, the keyboard retains the same language as the car's system language.

## Switching between different languages in the keyboard



When a number of languages have been selected in Settings, the button in the keyboard is used to switch between the different languages.

To change keyboard language with list:

1. Give a long press on the button.
  - > A list opens.

2. Select the required language. If more than four languages have been selected, it is possible to browse in the list from the keyboard.
  - > The keyboard is adapted to the selected language and other word suggestions are given.

To change the keyboard language without displaying the list:

- One short press of the button.
  - > The keyboard is adapted to the next language in the list without displaying the list.

## Related information

- Changing system language (p. 117)
- Keyboard in centre display (p. 114)

# Enter the characters, letters and words manually in the centre display

The centre display keyboard allows you to enter characters, letters and words on the screen by "drawing" by hand.



Press the button on the keyboard to change from typing with the keys to entering letters and characters by hand.



Return to the keyboard with regular character input.

## Writing characters/letters/words by hand

1. Write a character, a letter, a word or parts of a word in the area for hand-written letters. Write a word or parts of a word above each other or on a line.
  - > A number of suggested characters, letters or words is shown. The most likely choice is found at the top of the list.
2. Enter the character/letters/word by waiting a moment.
  - > The character/letter/word at the top of the list is entered. It is also possible to select a different character by pressing the required character, letter or word in the list.

## Related information



- Keyboard in centre display (p. 114)

## IMPORTANT

Do not use sharp objects on the screen as they may scratch it.

## Changing system units

Unit settings are defined by the centre display.



1. Open app view .
2. Press .
3. Continue to System, Units.
4. Select the unit standard required for e.g. distance, speed or temperature.
  - > The units in the driver display and centre display are changed.

### Related information

- Overview of centre display (p. 105)
- Resetting user data (p. 118)
- Changing system language (p. 117)

## Changing system language

Language settings are defined by the centre display.

1. Open app view .
2. Press .
3. Continue to System, Languages and input.
4. Select the required language.
  - > The language in the driver display and centre display are changed.

### Related information

- Overview of centre display (p. 105)
- Resetting user data (p. 118)
- Changing system units (p. 117)

### NOTE

Changing the language in the centre display may mean that some information in the Manual is not compliant with national or local laws and regulations. Do not switch to a language that is difficult to understand as this may make it difficult to find your way back through the screen structure.

## Resetting user data



Resetting user data and system settings is performed via the centre display.

Settings that can be restored to standard value:

- apps
- network settings
- factory reset

In the event of a change of ownership, user data and system settings should be restored to factory settings.

Restoring settings via the centre display

1. Press .
2. Press .
3. Go through to System, Reset options to reset the desired setting.

User profile Admin must be selected in order to be able to reset network settings or reset the car to factory settings.

### Related information

- Overview of centre display (p. 105)
- Buying and selling a car with Polestar Connect (p. 436)
- Approval of terms and conditions and data collection (p. 21)
- Profile settings (p. 120)

## User profiles

Many of the settings made in the car can be saved in a personal user profile.

When first used, or after a factory reset, the Admin profile is pre-installed and active in the car.

The Admin profile has administrator privileges and cannot be deleted.

Tap on  at the top of the centre display to access profiles.

The home view shows the initials of the active profile. A  symbol is shown instead when the system is logged out.

### Automatic profile selection

It is possible to link your key to a profile. The profile, along with all of its settings, will then be selected automatically every time the car is used with that specific key.

The last used profile is activated if a key is not linked to a specific profile.

### General information on settings

Changes to the car's settings are saved in different ways depending on the category the settings belong to. The settings can be personal, global or adapted to a drive cycle.

### Personal preferences

Personal settings are saved to an active profile.

There are two types of personal settings:

- Function settings – settings that apply to driver support, driver's side climate control, the driver's seat, the door mirrors, as well as interior and exterior lighting. These settings retain their values when a profile is added or when logging out from an active profile.

# Managing user profiles

- Audio and media settings – settings that apply to, navigation, audio and media system, apps, and linked accounts. These settings return to standard settings when a profile is added or when logging out from an active profile.

## Global settings

The global settings are not changed when the profile is changed. They remain the same regardless of which profile is active. Examples of global settings are passenger side climate control, memory function for passenger seat, and some system settings.

## Drive cycle defaults

A number of settings return to their defaults<sup>8</sup> after a drive cycle.

It is possible to adjust the values for these settings while driving. In the next drive cycle, the settings will return to their standard value.

## Related information

- Managing user profiles (p. 119)
- Profile settings (p. 120)
- Connect key to user profile (p. 122)
- Storing a position for seat and door mirrors (p. 162)
- Using stored position for seat and rearview mirrors (p. 163)
- Connect account to user profile (p. 121)

You can change to another profile even if the key used is linked to another profile.

## Creating a profile

1. Tap on the initials or the  symbol at the top of the centre display.
2. Select Add profile.
3. The profile is created.
  - > The profile is set as active profile.

An instruction for how the new profile can be set appears while creating a new profile.

You can create up to six different profiles.

## Selecting a profile

1. Tap on the initials or the  symbol at the top of the centre display.
  - > Selectable profiles are shown.
2. Select the preferred profile.
  - > The profile is selected and the system loads the settings for the selected profile.

## Logging out from a profile

1. Tap on the initials at the top of the centre display.
2. Select Log out.
  - > Logging out takes place from the profile and it is no longer possible to access the account linked to the profile.
3. The system is set in a logged-out mode and changed settings are not saved in any profile.

# Profile settings

## Related information

- User profiles (p. 118)
- Centre display's views (p. 110)
- Profile settings (p. 120)
- Connect key to user profile (p. 122)
- Connect account to user profile (p. 121)
- Approval of terms and conditions and data collection (p. 21)
- Connect key to user profile (p. 122)

## NOTE

- To cancel the moving of the seat when changing the profile, tap on any of the buttons on the seat part of the front seat.
- Creating, selecting and logging out of a user profile are only possible while the car is stationary.

In profile settings, you can change profile name, add and remove linked keys, link different accounts, as well as delete the active profile.

## Activating screen lock

When screen lock is activated, a passcode is required in order to be able to use the active profile.

1. Tap on the initials at the top of the centre display.
2. Press Profile settings.
3. Select Screen lock.
4. Select type of screen lock and activate.
  - > The screen lock will be shown in the centre display when changing to a profile with passcode, and each time the system is restarted.

## Deleting a profile

Settings that have been saved to one or more profiles can only be deleted if the car is stationary.

1. Tap on the initials at the top of the centre display.
2. Press Profile settings
3. Select Delete this profile.
  - > User information and connections linked to the profile are deleted.
4. The system is set in a logged-out mode and changed settings are not saved in any profile.

## Related information

- User profiles (p. 118)



# Connect account to user profile

- Managing user profiles (p. 119)
- Connect account to user profile (p. 121)
- Connect key to user profile (p. 122)
- Resetting user data (p. 118)

## NOTE

User profiles can only be deleted when the car is stationary.

It is possible to add accounts to the selected user profile.

### Add an account

1. Tap on the initials at the top of the centre display.
2. Press Account.
3. Select Add account.
  - > A list of accounts that can be added is shown.
4. Select desired account.

### Related information

- User profiles (p. 118)
- Profile settings (p. 120)

# Connect key to user profile

It is possible to connect your key to a profile. The profile along with all of its settings will then be automatically selected every time the car is used with that specific key.

The first time the key is used, it is not linked to any specific profile. When the car is started, the Admin profile, or the last used profile, will automatically be activated.

## Linking a key to a profile

1. Tap on the initials at the top of the centre display.
2. Press Profile settings.
3. Select Connect car key to profile to link the selected key to a profile.

It is only possible to link a profile to the key currently being used in the car. If there are multiple keys in the car, the More than one key was found, put the key to be connected on the backup reader message is shown.



*Backup reader's location in the tunnel console.*

## Disconnecting a key from a profile

1. Tap on  at the top of the centre display.

2. Press Profile settings.

3. Select User recognition by car key to remove the active profile from the linked key.

You can unlink a key from a profile even if the key is not inside the car.

## Related information

- User profiles (p. 118)
- Key (p. 208)
- Profile settings (p. 120)

## NOTE

If the key was previously linked to another profile, the link is moved from the previous profile to the active profile.

# Messages in the centre display



- ① Shown at the top of the centre display. Requires immediate management, and can have up to three buttons that allow the user to manage the message. Dismiss by swiping right or left. The message is then saved in the notification view.
- ② Shown as a window in the centre display and requires immediate attention. Can have 1-3 buttons for management.
- ③ Shown for a few seconds at the top of the centre display. It is not possible to do anything with the notification and it is not saved anywhere.

The following illustrative example shows how messages and notifications can be shown in the centre display in different contexts.

## Related information

- Overview of centre display (p. 105)
- Centre display's views (p. 110)

# Voice control with Google Assistant

Google Assistant, which is integrated in the car, makes it possible to use your voice to control a range of functions, e.g. the climate control system, Google Maps for navigation, the radio and your phone.

## What is Google Assistant?

Google Assistant is a digital assistant that makes it possible to use your voice to control various in-car functions and get help with other things such as searching for information, weather forecasts, managing your Google Calendar, etc.

The Assistant understands natural speech, i.e. you do not need any knowledge of specific commands to get the system to do different things. Instead, the user can speak freely with the system, which provides feedback in the form of responses to what was requested or indicating if it cannot understand what the user wanted.

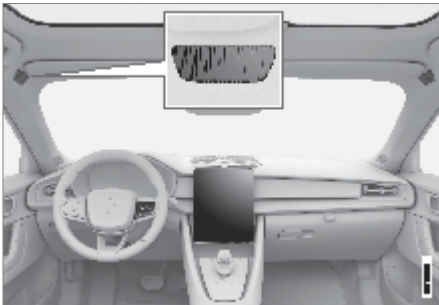

*Voice control system microphone*

## Which areas can be controlled via Google Assistant?

In addition to asking the Assistant for information searched for via Google, searching for weather forecasts, or managing the Google cal-

ender<sup>9</sup>, etc., a number of in-car functions can be controlled using your voice. These include:

- media
- radio
- phone and SMS<sup>10</sup>
- navigation via Google Maps
- climate.

## Related information

- Using voice control (p. 125)
- Google Maps (p. 442)

## WARNING

The driver always holds overall responsibility for driving the vehicle in a safe manner and complying with all applicable rules of the road.

## NOTE

Poorer connection may have a negative effect on the functions.

<sup>9</sup> Internet connection required.



<sup>10</sup> Dictating SMS only works for phones with Android or iOS 13 or later.

# Using voice control

Google Assistant makes it possible to use your voice to control different functions in the car or, for example, to ask for information such as a weather forecast.

## Launching Google Assistant

Google Assistant can be started in three different ways as follows

- say the voice command "OK Google" or "Hey Google"<sup>11</sup>
- press briefly on the steering wheel button for voice control 
- tap on the microphone in the centre display 

The system shows that it is active and listening by means of a brief audible signal<sup>12</sup> and a graphic confirmation in the centre display.

## Examples of voice control

After the system has started it is possible to make different requests by speaking freely. Several examples of how to use voice control are given below.

- "Navigate home" – Show directions to the address stored in Maps as home address for the Google account used to log in.
- "Read my messages" – Read out text messages sent to the phone.
- "Raise the temperature" – Raises the temperature in the passenger compartment.
- "Play music" – Plays back music in selected media app.

Logging in with a Google account means that the assistant will be more personalised when

the car is online. For example, it is possible to call contacts stored in [contacts.google.com](https://contacts.google.com) or enquire about what is entered in Google Calendar.

## Related information

- Voice control with Google Assistant (p. 124)
- Connect account to user profile (p. 121)

## NOTE

- Google Assistant is not available in all languages as yet. Find out more at [support.google.com](https://support.google.com) about accessibility, or try another language if possible.
- The instructions above are general descriptions and include third-party suppliers. Availability, procedure and functionality are subject to change or variation.

<sup>11</sup> "Hey Google" only works in certain languages.

<sup>12</sup> When a voice command is used to start the system, you will hear the audible signal only if you pause before you continue your request.



Section 05

—

Lighting

# Lighting control



The different lighting controls are used to control both exterior and interior lighting. The left-hand stalk switch activates and adjusts the exterior lighting. The interior brightness is adjusted using a thumbwheel on the instrument panel.

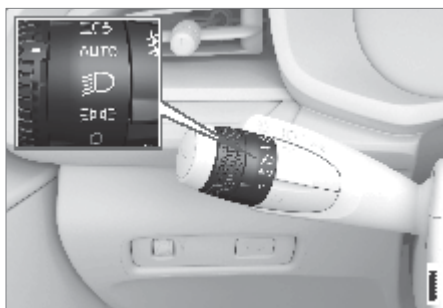

## Exterior lighting



*Rotating ring in the left-hand stalk switch.*

When the car is started, the following functions are available for the rotating ring's different positions:

Position	Specification
	Daytime running lights. Main beam flash can be used.
	Daytime running lights and position lamps. Position lamps when the car is parked. <sup>A</sup> Main beam flash can be used.
	Dipped beam and position lamps. Main beam can be activated. Main beam flash can be used.

Position	Specification
	Daytime running lights and position lamps in daylight.  Dipped beam and position lamps in weak daylight or darkness, or when the front and/or rear fog lamp is activated.  The Active main beam function can be activated.  Main beam can be activated when dipped beam is switched on.  Main beam flash can be used.
	Active main beam on/off.

<sup>A</sup> If the car is stationary but running, the rotating ring can be moved to  position from another position to switch on only the position lamps instead of other lighting.

Polestar recommends that **AUTO** mode is used when the vehicle is driven.

## Thumbwheel in instrument panel



*Thumbwheel (to left) for adjusting interior brightness.*



# Adjusting light functions via the centre display

## Related information

- Adjusting light functions via the centre display (p. 129)
- Interior lighting (p. 142)
- Position lamps (p. 130)
- Using direction indicators (p. 135)
- Using main beam (p. 133)
- Dipped beam (p. 132)
- Front fog lamps/cornering lights (p. 137)
- Rear fog lamp (p. 138)
- Active bending lights (p. 136)
- Brake lights (p. 139)
- Emergency brake lights (p. 140)
- Hazard warning flashers (p. 140)

## WARNING

The car's lighting system is not able to determine when daylight is too weak or sufficiently strong, e.g. in fog and rain, in all situations.

The driver is always responsible for ensuring that the car is driven with a beam pattern suitable for the traffic situation and in accordance with applicable traffic regulations.

Several light functions can be adjusted and activated via the centre display. This applies to active main beam, home safe lighting and welcome lighting, for example.

1. Tap on  in the centre display.
2. Then tap on More.
3. Select Interior Lights or Exterior Lights and then select the function that needs to be adjusted.

## Related information

- Lighting control (p. 128)
- Active main beam (p. 134)
- Using home safe lighting (p. 141)
- Welcome light and farewell light (p. 142)
- Using direction indicators (p. 135)
- Car function view in the centre display (p. 112)

# Adapting the headlamp pattern from the headlamps

The headline patent can be adjusted when switching from right-hand to left-hand traffic, and vice versa. This function adapts the beam from the headlamps so that there is less risk of oncoming traffic being dazzled.

1. Tap on  in the centre display.
2. Then tap on More.
3. Select Exterior Lights and activate/deactivate Temporary Left Hand Traffic/Temporary Right Hand Traffic.

## Related information

- Adjusting light functions via the centre display (p. 129)
- Active bending lights (p. 136)
- Car function view in the centre display (p. 112)

# Position lamps

Position lamps can be used so that other road users can see the car if it stops or is parked. The position lamp is switched on with the rotating ring on the stalk switch.



*Stalk switch rotating ring in position lamps position.*

Turn the rotating ring to the  position - the front and rear position lamps are switched on (number plate lighting is switched on at the same time).

If the car is in drive mode, the daytime running lights are switched on instead of the front position lamps.

If the car is stationary but running, the rotating ring can be moved to the position lamp  position from another position to switch on only the position lamps instead of other lighting.

When driving for more than 30 seconds at max. 10 km/h (approx. 6 mph), or if the speed exceeds 10 km/h (approx. 6 mph), the daytime running lights are switched on. The driver should then turn to a position other than .

If the tailgate is opened when it is dark outside, the rear position lamps are switched on (if not already switched on) to warn road users approaching from behind. The position lamps

# Daytime running lights

illuminate for approx. 10 minutes or until the tailgate is closed.

## Related information

- Lighting control (p. 128)
- Daytime running lights (p. 131)
- Usage modes (p. 373)

The car has sensors that detect the light conditions in the surroundings. With the rotating ring on the stalk switch in position **0**, **304E** or **AUTO**, the daytime running lights are switched on. In position **AUTO**, the headlamps change automatically to dipped beam in weak daylight or darkness.



*Stalk switch rotating ring in AUTO position.*

If the stalk switch rotating ring is in the **AUTO** position, the daytime running lights (DRL<sup>13</sup>) are switched on when the car is driven in daylight. The car automatically changes lighting from daytime running light to dipped beam in weak daylight or darkness. Changing to dipped beam also takes place if the rear fog lamp is activated.

## Related information

- Lighting control (p. 128)
- Usage modes (p. 373)
- Dipped beam (p. 132)
- Daytime running lights (p. 131)

## Dipped beam

### WARNING

This system help to save energy - it cannot determine in all situations when daylight is too weak or sufficiently strong, e.g. in mist and rain.

The driver is always responsible for ensuring that the car is driven with the correct beam pattern for the traffic situation and in accordance with applicable traffic regulations.

When driving with the stalk switch's rotating ring in the **AUTO** position, dipped beam is activated automatically in weak daylight or darkness.



*Stalk switch rotating ring in **AUTO** position.*

With the stalk switch's rotating ring in **AUTO** position, dipped beam is also activated automatically if the front and rear fog lamps are activated.

With the stalk switch's rotating ring in the **D** position, dipped beam is always activated when the car is started.

### Tunnel detection

The car detects when it is driven into a tunnel and switches from daytime running lights to dipped beam.

Note that the rotating ring in the left-hand stalk switch must be in **AUTO** mode for tunnel detection to work.

### Related information

- Lighting control (p. 128)
- Usage modes (p. 373)
- Daytime running lights (p. 131)
- Bulb replacement (p. 519)

# Using main beam

Main beam is operated with the left-hand stalk switch. Main beam is the car's strongest lighting and should be used when driving in the dark for better visibility, as long as it does not dazzle other road users.

- Active main beam (p. 134)
- Bulb replacement (p. 519)

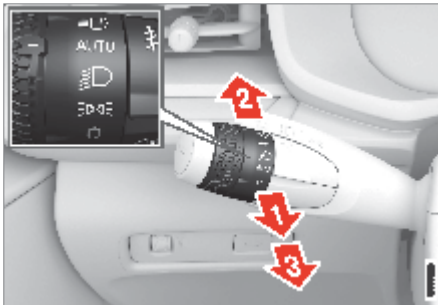

Steering wheel stalk switch with rotating ring.

## Main beam flash

- Move the stalk switch backwards slightly to main beam flash position. Main beam comes on until the stalk switch is released.

## Main beam

- Main beam can be activated when the steering wheel stalk switch's rotating ring is in position **AUTO**<sup>2</sup> or **D**. Activate main beam by moving the stalk switch forwards.
- Deactivate by moving the stalk switch backwards.

When main beam has been activated the  symbol illuminates in the driver display.

## Related information

- Lighting control (p. 128)

<sup>2</sup> When dipped beam is activated.

# Active main beam



Active main beam is a function which uses a camera sensor at the top edge of the windscreen to detect the headlamp beams from oncoming traffic or the rear lights of vehicles in front, and then switches from main beam to dipped beam or adaptive functionality.



The symbol  represents active main beam.

The function can start while driving in the dark when the car's speed is approx. 20 km/h (approx. 12 mph) or higher. The function can also take streetlights into account. When the camera sensor no longer detects any oncoming car or car in front, main beam is switched on again after about a second.

## Activate active main beam

Active main beam is activated and deactivated by turning the left-hand stalk switch to position . The rotating ring then returns to position **AUTO**. When active main beam is activated, the symbol  illuminates with a white glow in the driver display. When main beam is activated, the symbol shines blue.

If active main beam is deactivated while main beam is on the lighting is immediately reset to dipped beam.

Active main beam does not need to be reactivated every time the car is started.

## Adaptive functionality

The active main beam has adaptive functionality. In this case, unlike with conventional dimming, the main beam continues to shine on both sides of oncoming vehicles or vehicles in front. Only the part of the beam pointing directly at the vehicle is dimmed.

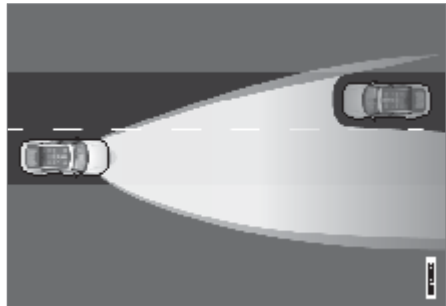

*Adaptive functionality: Dipped beam directly towards oncoming vehicle, but continued main beam on both sides of the vehicle.*

The main beam is partly dimmed, that is, if the light beam shines slightly brighter than dipped beam, the symbol  in the driver display shines blue.

On a motorway or at high speed, the system may shift from adaptive to automatic functionality.

## Limitations for active main beam

The camera sensor on which the function is based has limitations.

## Using direction indicators



If the symbol is shown in the driver display, together with the message Active High Beam Temporarily unavailable, then switching between main and dipped beam must be performed manually. The  symbol extinguishes when these messages are shown.



The same applies if this symbol is shown together with the message Windscreen sensor blocked See Manual.

Active main beam may be temporarily unavailable e.g. in situations with dense fog or heavy rain. When active main beam becomes available again, or the windscreen sensors are no longer blocked, the message goes out and the  symbol illuminates.

### Related information

- Lighting control (p. 128)
- Using main beam (p. 133)
- Camera unit (p. 341)
- Recommended maintenance for camera unit (p. 343)

## WARNING

Active main beam is an aid for using the optimum beam pattern when conditions are favourable.

The driver always bears responsibility for manually switching between main and dipped beam when traffic situations or weather conditions so require.

The car's direction indicators are operated with the left-hand stalk switch. The direction indicator lamps flash three times or continuously, depending on how far up or down the stalk switch is moved.



*Direction indicators.*

### Short flash sequence

-  Move the stalk switch up or down to the first position and release. The direction indicator lamps flash three times. If the function is deactivated via the centre display, the lamps will flash once.

### Continuous flash sequence

-  Move the stalk switch up or down to its end position.

The stalk switch remains in its position and is moved back manually, or automatically by the steering wheel movement.

### Related information

- Hazard warning flashers (p. 140)
- Adjusting light functions via the centre display (p. 129)

# Active bending lights

- Bulb replacement (p. 519)

## NOTE

- This automatic flashing sequence can be stopped by moving the stalk switch immediately in the opposite direction.
- If the symbol for direction indicators in the driver display flashes more quickly than normal - see the message in the driver display.

Active bending lights are designed to provide additional illumination in bends and junctions.

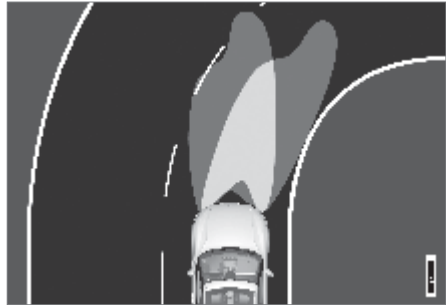

*Headlamp pattern with function deactivated (left) and activated (right) respectively.*

Active bending lights follow steering wheel movements to provide additional illumination in bends and junctions and can thereby provide the driver with improved visibility.

The function is activated automatically when the car is started. In the event of a fault in the function, the  symbol illuminates in the driver display at the same time as the driver display shows an explanatory text.

The function is only active in weak daylight or darkness and only when the car is moving and dipped beam is switched on.

1. Tap on  in the centre display.
2. Then tap on More.
3. Select Exterior Lights and activate/deactivate active bending light.

## Related information

- Adjusting light functions via the centre display (p. 129)



# Front fog lamps/ cornering lights

- Car function view in the centre display (p. 112)
- Front fog lamps/cornering lights (p. 137)

The front fog lamps can be activated in order to provide better visibility when driving in fog.

The cornering lights come on automatically in weak daylight or darkness in order to illuminate the area diagonally in front of the car.

## Front fog lamps



*Front fog lamp button.*

The front fog lamps can be switched on when the steering wheel stalk switch's rotating ring is in position **AUTO**, **☰** or **☷**.

Tap on the button to activate and deactivate. The symbol **☷** shines in the driver display when the front fog lamps are switched on.

The front fog lamps are switched off automatically when the car is switched off or when the rotating ring on the stalk switch is set to the **0** position.

## Cornering lights

The front fog lamps include the cornering light function, which temporarily illuminates the area diagonally in front of the car in the direction in which the steering wheel is turned on a sharp bend, or in the direction in which the direction indicators are indicating.

>>

## Rear fog lamp

This function is activated in weak daylight or darkness when the stalk switch's rotating ring is in position **AUTO** or **SD** and the speed of the car is lower than approx. 30 km/h (approx. 20 mph).

Both cornering lights are also switched on as a supplement to the reversing light when reversing.

The function is activated when the car is supplied from the factory, and it can be activated and deactivated via the centre display.

### Related information

- Lighting control (p. 128)
- Rear fog lamp (p. 138)
- Switching off the car (p. 373)
- Adjusting light functions via the centre display (p. 129)

### NOTE

Regulations on the use of fog lamps vary from country to country.

The rear fog lamp is considerably stronger than a normal rear light and should only be used in reduced visibility due to fog, snow, smoke or dust so that other road users have an early warning of a vehicle ahead.



Button for rear fog lamp.

Rear fog lamps can only be switched on when:

- the steering wheel stalk switch's rotating ring is in position **AUTO** or **SD**
- the steering wheel stalk switch's rotating ring is in position **SD** and the fog lamps are switched on.

Press the button to switch the lights on/off. The **☰** symbol in the driver display illuminates when the rear fog lamp is switched on.

The rear fog lamps are switched off automatically when:

- the steering wheel stalk switch's rotating ring is in position **0**
- the steering wheel stalk switch's rotating ring is in position **SD** and the fog lamps are switched off.

# Brake lights

## Related information

- Lighting control (p. 128)
- Usage modes (p. 373)
- Bulb replacement (p. 519)
- Front fog lamps/cornering lights (p. 137)

## NOTE

Regulations on the use of rear fog lamps vary from country to country.

The brake light automatically comes on during braking.

The brake light is illuminated when the brake pedal is depressed and when the car is braked automatically by one of the driver support systems.

The brake light also comes on during regenerative braking if the braking force exceeds a certain level.

## Related information

- Emergency brake lights (p. 140)
- Brake functions (p. 375)
- Bulb replacement (p. 519)
- Driving support systems (p. 242)

# Emergency brake lights

Emergency brake lights are activated to alert vehicles behind about heavy braking.

The function means that the brake light flashes instead of - as in normal braking - shining with a constant glow.

The emergency brake lights are activated during heavy braking or if the ABS system is activated at high speeds.

After the driver brakes to a low speed and then releases the brake, the brake light returns to normal glow.

The car's hazard warning flashers are activated at the same time. These flash until the driver accelerates the car to a higher speed again or switches off the car's hazard warning flashers.

## Related information

- Brake lights (p. 139)
- Foot brake (p. 375)
- Hazard warning flashers (p. 140)

# Hazard warning flashers

Hazard warning flashers warn other road users by means of all of the car's direction indicators being activated simultaneously. The function can be used to give a warning in the event of traffic hazards.

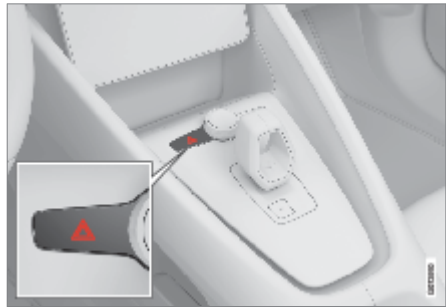

*Button for hazard warning flashers.*

Press the button to activate the hazard warning flashers.

The hazard warning flashers are automatically activated when the car brakes so powerfully that the emergency brake lights are activated and the speed is low. The hazard warning flashers start to flash after the emergency brake lights have stopped flashing and are then deactivated automatically when the car drives away again or are deactivated if the button is depressed.

Hazard warning flashers are activated automatically in the event of a collision.

## Related information

- Emergency brake lights (p. 140)
- Using direction indicators (p. 135)

# Using home safe lighting

## NOTE

Regulations for the use of hazard warning flashers may vary between countries.

Some of the exterior lighting can be kept switched on to work as home safe lighting after the car has been locked.

To activate the function:

1. Switch off the car.
2. Move the left-hand stalk switch forward toward the instrument panel and release.
3. Get out of the car and lock the door.
  - > The  symbol comes on in the driver display to indicate that the function is activated and outer lighting is switched on: Position lamp, headlamp, number plate lighting and lighting in outer handles.

The length of time that home safe lighting remains on can be set via the centre display.

### Related information

- Adjusting light functions via the centre display (p. 129)
- Welcome light and farewell light (p. 142)

## Welcome light and farewell light

Welcome lighting is switched on when the car is unlocked, and farewell lighting is activated when the driver leaves the car.

### Welcome lighting

The function is activated when the key is used for unlocking. In daylight, position lamps, interior roof lamps, floor lights and cargo area lighting are activated. The headlamps, number plate lighting and lighting in the outer handles with their beams directed towards the ground are also activated in weak daylight or darkness.

The lighting stays on for approximately 2 minutes if no doors are opened. The time for the interior lighting will be extended if a door is opened within the activation period.

The function can be activated and deactivated via the centre display.

### Farewell light

When the driver leaves the car after driving, the car keeps the position lamps and number plate lighting on. The lighting stays on for approximately 2 minutes or until the car is locked.

### Related information

- Adjusting light functions via the centre display (p. 129)
- Using home safe lighting (p. 141)
- Key (p. 208)

## Interior lighting

The passenger compartment is equipped with several types of lighting, e.g. general interior lighting, adjustable decor illumination and reading lighting.

### Front roof lighting

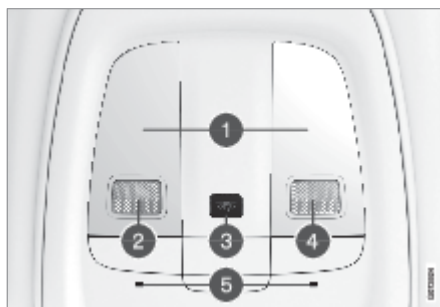

*Lighting and controls in the roof console.*

- ① General interior lighting
- ② Reading lamp, left-hand side
- ③ Button for passenger compartment lighting and automatic passenger compartment lighting
- ④ Reading lamp, right-hand side
- ⑤ Ambience lights

### Reading lighting

The reading lamps in the roof console are switched on or off by pressing gently and briefly on each reading lamp. The brightness is adjusted by pressing the lamp and keeping your finger on it.

### Passenger compartment lighting

The floor lighting and general interior lighting are switched on or off with a short press on the

button for passenger compartment lighting in the roof console.

#### Auto function for passenger compartment lighting

The automatic function is activated and deactivated by holding depressed the button for passenger compartment lighting. When the button illuminates

- white, the automatic function is activated
- orange, the automatic function is deactivated.

When the automatic function is activated, the passenger compartment lighting is illuminated according to the following.

The passenger compartment lighting comes on when

- the car is unlocked
- a side door is opened.

The passenger compartment lighting goes off when

- the car is locked
- gear position D, R or N is selected
- a side door is closed
- a side door has remained open for approx. 2 minutes.

#### Rear roof lighting

There are reading lamps in the rear part of the car which are also used as general interior lighting.



*In cars with panoramic roof, there are two lamp units on each side of the roof.*

The reading lamps are switched on or off by pressing gently and briefly on the lamp. The brightness is adjusted by pressing the lamp and keeping your finger on it.

#### Polestar symbol in the roof

A Polestar symbol is projected in the roof when the car is unlocked. The light is dimmed while driving and is extinguished on locking. The brightness can be finely adjusted using the thumbwheel in the instrument panel.

#### Glovebox lighting

Glovebox lighting is switched on and off respectively when the lid is opened or closed.

#### Sun visor mirror lighting

The lighting for the mirror in the sun visor is switched on or off when the lid is opened or closed.

#### Ground lighting

The ground lighting is switched on or off when the corresponding door is opened or closed.

>>

# Adjusting interior lighting

## Lighting in the cargo area

The lighting in the cargo area is switched on or off when the tailgate is opened or closed.

## Decor lighting

The ambient light switches on when the doors are opened, and switches off when the car is locked. The intensity of the decor lighting can be adapted in the centre display and also precisely adjusted using the thumbwheel in the instrument panel.

## Ambience lights

There are a number of lights in the roof that provide ambience light. The light can be adapted in the centre display and also precisely adjusted using the thumbwheel in the instrument panel.

## Lighting in storage compartments in doors

The lighting in door storage compartments is illuminated when the car has been unlocked and is extinguished on locking. The brightness can be precisely adjusted using the thumbwheel in the instrument panel.

## Lighting in the tunnel console

The lighting in the tunnel console is switched on when the car is unlocked and switched off when the car is locked. The brightness can be precisely adjusted using the thumbwheel in the instrument panel.

## Related information

- Adjusting interior lighting (p. 144)
- Lighting control (p. 128)
- Usage modes (p. 373)
- Passenger compartment interior (p. 480)

The lamps inside the car come on differently depending on the usage position. The interior lighting can be adjusted with a thumbwheel in the instrument panel, and certain light functions can also be adjusted via the centre display.

## Adjusting the interior lighting via the thumbwheel



The thumbwheel on the instrument panel, to the left of the steering wheel, is used to adjust the brightness of the display lighting, controls lighting, ambient decor illumination and ambience light

## Adjusting the interior lighting via the centre display

1. Tap on  in the centre display.
2. Then tap on Interior Lights.
3. Then adjust the function that is required.

## Related information

- Interior lighting (p. 142)
- Adjusting light functions via the centre display (p. 129)
- Usage modes (p. 373)



## Section 06

—

## Windows, glass and mirrors

# Windows, glass and mirrors

The car contains several different windows, glass panes and mirrors. A number of these are laminated, tinted and/or heated.

The windscreen, panoramic roof and side windows have laminated glass. Laminated glass is reinforced, which provides better protection against break-ins and improved sound insulation in the passenger compartment.



The symbol is shown on the windows where the glass is laminated.<sup>15</sup>

## Related information

- Pinch protection for windows (p. 146)
- Panoramic roof\* (p. 153)
- Power windows (p. 147)
- Rearview and door mirrors (p. 149)
- Using windscreen wipers (p. 154)
- Using windscreen and headlamp washers (p. 157)
- Activating and deactivating the heated rear window and door mirrors (p. 189)

## IMPORTANT

Avoid using tinted film with a metallised surface coating on the rear window. This may disrupt reception as the car's radio antenna is located inside the window.

# Pinch protection for windows

All power windows in your car have pinch protection which is deployed if they are blocked by any object while opening or closing.

In the event of blocking, the movement stops and then reverses automatically to approx. 50 mm (approx. 2 inches) from the blocked position (or to full ventilation position).

It is possible to force pinch protection when closing has been cancelled, e.g. when ice is formed, by continuing to press the control in one and the same direction.

If any fault arises with the pinch protection, a reset sequence can be tested.

## Related information

- Reset sequence for window pinch protection (p. 147)
- Operating power windows (p. 148)

## WARNING

If the starter battery is disconnected, the automatic opening and closing function must be reset to work properly. A reset must take place for pinch protection to work.

# Reset sequence for window pinch protection

If a problem occurs with the electrical functions for the electric windows, a reset sequence can be tested.

1. Start with the window in closed position.
2. Then operate the controls in the manual position 3 times upwards to closed position.
  - > The system is initialised automatically.

## Related information

- Pinch protection for windows (p. 146)
- Operating power windows (p. 148)

## WARNING

If the starter battery is disconnected, the automatic opening and closing function must be reset to work properly. A reset must take place for pinch protection to work.

# Power windows

Each door has a control panel for the electrically-driven power windows. The driver's door has controls for operating all windows.



*Driver's door control panel*

- ① Window controls in the driver's door.
- ② Window controls in the passenger door.
- ③ Controls for windows in the rear doors.

## Related information

- Operating power windows (p. 148)
- Pinch protection for windows (p. 146)
- Reset sequence for window pinch protection (p. 147)

# Operating power windows

## WARNING

Children, other passengers or objects may be trapped by the moving parts.

- Always operate the windows with caution.
- Do not allow children to play with the controls.
- Never leave children alone in the car.
- Remember always to take the key with you when leaving the car.
- Never put an object or part of the body through the windows, even if the car's electrical system is fully disconnected.

All electric windows can be operated using the control panel in the driver's door – only the window in the passenger door is operated using the control panel in the passenger door.

The power windows are equipped with pinch protection. If any fault arises with the pinch protection, a reset sequence can be tested.



### Operating the power windows

- ➡ Operating without auto. Move one of the controls gently up or down. The power windows move up or down as long as the control is held in position.
- ➡ Operating with auto. Move one of the controls up or down to the end position and release it. The window runs automatically to its end position.

In order for the power windows to be used, the car must be in Comfort or Drive mode. It is only possible to operate one control at a time.

### Related information

- Power windows (p. 147)
- Pinch protection for windows (p. 146)
- Reset sequence for window pinch protection (p. 147)

- Usage modes (p. 373)

## WARNING

Children, other passengers or objects may be trapped by the moving parts.

- Always operate the windows with caution.
- Do not allow children to play with the controls.
- Never leave children alone in the car.
- Remember always to take the key with you when leaving the car.
- Never put an object or part of the body through the windows, even if the car's electrical system is fully disconnected.

## NOTE

- One way to reduce the pulsating wind noise when the rear windows are open is to also open the front windows slightly.
- The windows cannot be opened at speeds above approx. 180 km/h (approx. 112 mph), but they can be closed.

The driver always bears responsibility for following traffic regulations in force.

- It may not be possible to operate windows at low temperatures.

# Rearview and door mirrors

The rearview mirrors and door mirrors can be used to give the driver better visibility to the rear.

## Interior rearview mirror

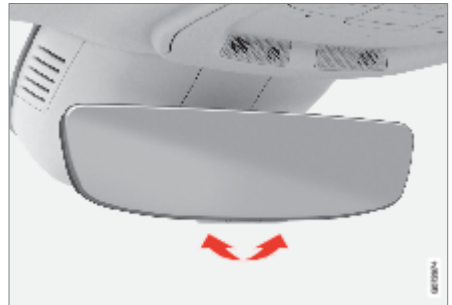

The interior rearview mirror is adjusted by angling it manually. The rearview mirror is equipped with automatic dimming that can be adjusted in the centre display.

## Door mirrors

The door mirrors have wide-angle fields<sup>16</sup> in the outer edges of the mirrors to make it easier to see objects in blind spots.

The door mirror positions are adjusted with the joystick in the driver's door control panel. There are also a number of automatic settings that can be linked to the memory function buttons for the power seat.

## Related information

- HomeLink<sup>®</sup>\* (p. 408)
- Adjusting rearview mirror dimming (p. 150)
- Angling adjustment of the door mirrors (p. 151)

>>

# Adjusting rearview mirror dimming

- Storing a position for seat and door mirrors (p. 162)
- Activating and deactivating the heated rear window and door mirrors (p. 189)

## WARNING

Both door mirrors are curved to provide optimal vision. Objects may appear to be further away than they actually are.

Bright light from behind is automatically dimmed by the interior rearview and door mirrors when it is dark outside or in limited light conditions, such as when driving in tunnels. Automatic dimming is always active while driving, apart from when gearbox reverse position is selected.

The interior rearview mirror contains two sensors - one forward facing and one rearward facing - that work together to identify and eliminate dazzling light. The forward facing sensor detects ambient light, while the rearward facing sensor detects the light from vehicle headlights behind.

1. Tap on  in the centre display.
2. Press Assist.
3. Select **•••**.
4. Tap on the button for mirrors and select the preferred setting.

Dimming sensitivity will affect both the interior rearview mirror and the door mirrors.

## Related information

- Rearview and door mirrors (p. 149)
- Angling adjustment of the door mirrors (p. 151)

## NOTE

- When sensitivity is changed there is no immediately noticeable change in dimming, but the change takes place gradually.

# Angling adjustment of the door mirrors

## NOTE

- If the sensors are obscured by e.g. parking permits, transponders, sun visors or objects in the seats or on the parcel shelf in such a way that light is prevented from reaching the sensors, then the dimming function of the interior rearview and door mirrors is reduced.

To ensure better visibility to the rear, the door mirrors need to be set to the preferences of the driver. There are a number of automatic settings that can also be linked to the memory function buttons for the power seat.

## Using controls for door mirrors

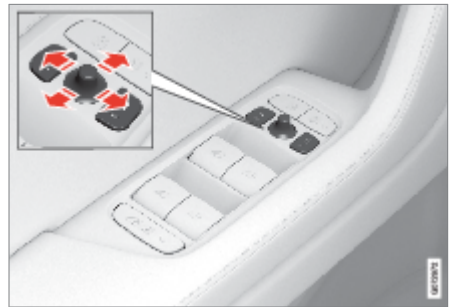

### *Controls for door mirrors*

The door mirror positions are adjusted with the joystick in the driver's door control panel. The car's electrical system must be active.

1. Press the L button for the left-hand door mirror or the R button for the right-hand door mirror. The light in the button illuminates.
2. Adjust the position with the joystick in the centre.
3. Press the L or R button again. The light should no longer be illuminated.

### **Folding in rearview mirrors electrically**

The mirrors can be retracted for parking/driving in narrow spaces.

1. Depress the L and R buttons simultaneously.

2. Release them after approximately 1 second.  
The mirrors automatically stop in the fully retracted position.

Fold out the mirrors by pressing down the L and R buttons simultaneously. The mirrors stop automatically in folded out mode with the previous setting.

### Restoring to original position

Mirrors that have been moved out of position by an external force must be reset electrically to their original position for electric retracting/ extending to work correctly.

1. Fold in the door mirrors by pressing down the L and R buttons simultaneously.
2. Fold them out again by pressing the L and R buttons simultaneously.
3. Repeat the above procedure as necessary.

The mirrors are returned to their original position.

### Angling during parking

A door mirror can be angled down for the driver to view the side of the road when parking, for example.

- Engage reverse gear and press the L or R button.

Note that the button may need to be pressed twice, depending on whether it was already pre-selected. The button flashes when the door mirror is angled down. When reverse gear is disengaged, the door mirror automatically starts to return after approx. 3 seconds and then reaches its original position after approx. 8 seconds.

### Automatic angling during parking

With this setting, the door mirror is automatically angled down when reverse gear is selected. The folded position is preset and cannot be adjusted. This is so that the driver can, for example, see the edge of the road while parking.

1. Tap on  in the centre display.
2. Press Assist.
3. Select **•••**.
4. Tap on the button for mirrors and select the preferred setting.

You can make the door mirror return to its original position by pressing the L or R button twice.

### Automatic retraction when locking

In the centre display, you can set all the rearview and door mirrors to retract/extend automatically when the car is locked/unlocked using the key.

1. Tap on  in the centre display.
2. Press Assist.
3. Select **•••**.
4. Tap on the button for mirrors and select the preferred setting.

### Related information

- Rearview and door mirrors (p. 149)
- Adjusting rearview mirror dimming (p. 150)
- Storing a position for seat and door mirrors (p. 162)
- Activating and deactivating the heated rear window and door mirrors (p. 189)



## Panoramic roof

### NOTE

If you manually fold in the mirrors with the L and R buttons and then lock the car, they will not fold out automatically when you unlock the car, even if this setting has been made. They must then be folded out manually.

The roof is an entire panoramic roof in tinted glass in order to damp incoming light, heat and ultraviolet radiation.



There is a Polestar symbol at the roof console that illuminates when the car is running. It can then be seen from both inside and outside the vehicle's passenger compartment.

### Related information

- Windows, glass and mirrors (p. 146)

# Wiper blades and washer fluid

Together with the washer fluid, the wipers aim to improve visibility as well as headlamp pattern.

The nozzles for the windscreen wipers are integrated on the top side of the wiper arm. Washer fluid is ejected when window washing is activated and the wiper arms start to move.

The fact that the nozzles are integrated in the wiper arm helps to bring about more effective window washing at different speeds and in various weather conditions, e.g. strong winds. It may also reduce the risk of obscuring the driver's vision, which is otherwise common when washing the windscreen in the traditional way. Integrated nozzles of this type also result in more efficient consumption of washer fluid.

The washer nozzles are heated automatically in cold weather in order to prevent the washer fluid freezing.

Information indicating that the washer fluid needs topping up appears in the driver display when there is approx. 1 litre (1 qt) of washer fluid remaining.

## Related information

- Using the rain sensor (p. 155)
- Using windscreen and headlamp washers (p. 157)
- Using the rain sensor's memory function (p. 156)
- Filling washer fluid (p. 538)
- Setting the wiper blades to service position (p. 537)
- Replacing windscreen wiper blades (p. 536)
- Using windscreen wipers (p. 154)

# Using windscreen wipers

The windscreen wipers are designed to clean the windscreen. Different settings for the windscreen wipers are set using the right-hand stalk switch.

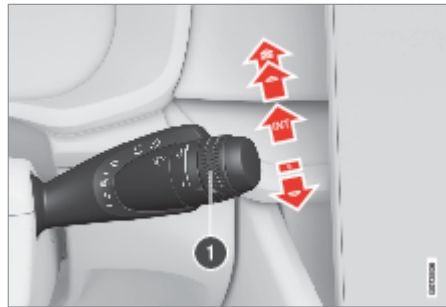

*Right-hand stalk switch.*

- ① The thumbwheel is used to set rain sensor sensitivity and wiper swipe frequency.

## Single sweep

-  Lower the stalk switch and release to make one sweep.

## Windscreen wipers off

- 0 Move the stalk switch to position 0 to switch off the windscreen wipers.

## Intermittent wiping

-  Move the lever up to switch the wipers to intermittent wiping. Set the number of sweeps per time unit with the thumbwheel when intermittent wiping is selected.

## Continuous wiping

-  Raise the stalk switch for the wipers to sweep at normal speed.

# Using the rain sensor

-  Raise the stalk switch further for the wipers to sweep at high speed.

## Related information

- Using the rain sensor (p. 155)
- Using windscreen and headlamp washers (p. 157)
- Wiper blades and washer fluid (p. 154)
- Using the rain sensor's memory function (p. 156)
- Filling washer fluid (p. 538)
- Setting the wiper blades to service position (p. 537)
- Replacing windscreen wiper blades (p. 536)

The rain sensor automatically starts the windscreen wipers based on how much water it detects on the windscreen. Rain sensor sensitivity can be adjusted with the thumbwheel on the right-hand stalk switch.

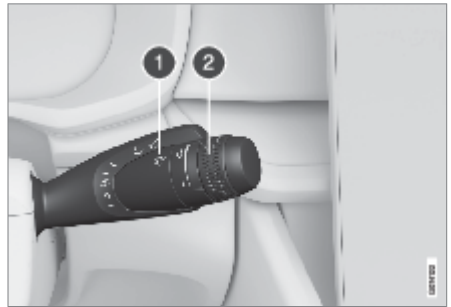

*Right-hand stalk switch.*

- ① Rain sensor button
- ② Thumbwheel sensitivity/frequency

When the rain sensor is activated, the rain sensor symbol  is shown in the driver display.

## Activating the rain sensor

When activating the rain sensor, the windscreen wipers must be in position 0 or in the position for a single sweep.

Activate the rain sensor by pressing the rain sensor button .

Move the lever down to make the wipers move.

Turn the thumbwheel upward for higher sensitivity and downward for lower sensitivity. An extra sweep is made when the thumbwheel is turned upward.

## IMPORTANT

- Before activating the wipers - ensure that the wiper blades are not frozen in, and that any snow or ice on the windscreen is scraped away.
- Use plenty of washer fluid when the wipers are cleaning the windscreen. The windscreen must be wet when the windscreen wipers are operating.

# Using the rain sensor's memory function

## Deactivating the rain sensor

Deactivate the rain sensor by pressing the rain sensor button  or moving the stalk switch up to another wiper program.

The rain sensor is deactivated automatically when the car is switched off.

The rain sensor is deactivated automatically when wiper blades are set in service position. The rain sensor is reactivated when service mode has been deactivated.

## Related information

- Using windscreen and headlamp washers (p. 157)
- Wiper blades and washer fluid (p. 154)
- Using the rain sensor's memory function (p. 156)
- Filling washer fluid (p. 538)
- Setting the wiper blades to service position (p. 537)
- Replacing windscreen wiper blades (p. 536)
- Using windscreen wipers (p. 154)

## IMPORTANT

The windscreen wipers could start and be damaged in an automatic car wash. Switch off the rain sensor before washing the car. The symbol in the driver display extinguishes.

The rain sensor automatically starts the windscreen wipers based on how much water it detects on the windscreen.

## Activating/deactivating the memory function

The memory function for the rain sensor can be activated in such a way that the rain sensor button does not need to be depressed each time the car is started:

1. Tap on  in the centre display.
2. Then tap on More.
3. Select Mirrors & Wipers and activate/deactivate the rain sensor's memory function

## Related information

- Using the rain sensor (p. 155)
- Using windscreen and headlamp washers (p. 157)
- Wiper blades and washer fluid (p. 154)
- Filling washer fluid (p. 538)
- Setting the wiper blades to service position (p. 537)
- Replacing windscreen wiper blades (p. 536)
- Using windscreen wipers (p. 154)

# Using windscreen and headlamp washers

Windscreen and headlamp washers are designed to clean the windscreen and headlamps. Windscreen and headlamp washers are started using the right-hand stalk switch.

## Starting windscreen and headlamp washers



*Washing function, right-hand stalk switch.*

- Move the right-hand stalk switch toward the steering wheel to start the windscreen and headlamp washers.
  - > The windscreen wipers will make several more sweeps once the stalk switch has been released.

## Headlamp washing

To save fluid, the headlamps are washed automatically at a defined interval when the headlamps are switched on.

## Reduced washing

If only approx. 1 litre (1 qt) of washer fluid remains in the reservoir and the message Washer fluid Refill washer fluid, level low, together with the  symbol, is shown in the driver display, then the supply of washer fluid to the headlamps is switched off. This is to prioritise cleaning the

windscreen and the visibility through it. The headlamps are only washed if main or dipped beam is switched on.

## Related information

- Using the rain sensor (p. 155)
- Wiper blades and washer fluid (p. 154)
- Using the rain sensor's memory function (p. 156)
- Filling washer fluid (p. 538)
- Setting the wiper blades to service position (p. 537)
- Replacing windscreen wiper blades (p. 536)
- Using windscreen wipers (p. 154)

## IMPORTANT

Avoid activating the washer system when it is frozen or the washer reservoir is empty, otherwise there is a risk of damaging the pump.



## Section 07

—

Seats and steering  
wheel

## Front seats

The seat has a range of adjustment options to increase your comfort.

### Related information

- Power front seat (p. 160)
- Adjusting the power front seat (p. 161)
- Storing a position for seat and door mirrors (p. 162)
- Using stored position for seat and rearview mirrors (p. 163)
- Adjusting the length of the seat cushion in the front seat (p. 164)
- Adjusting the lumbar support in the front seat (p. 164)
- Adjusting the passenger seat from the driver's seat (p. 165)
- Rear seat (p. 166)

## Power front seat

The car's front seats have a range of setting options in order to enhance comfort. The power seat can be moved forwards/backwards and upwards/downwards. The front edge of the seat cushion can be raised/lowered as well as adjusted in length and the backrest inclination can be changed. The lumbar support can be adjusted upward/downward/forward/backward.

Seat adjustment can be made when the car is in Comfort or Drive mode. Adjustment can also be performed within a certain time after the engine has been switched off.

### Related information

- Front seats (p. 160)
- Adjusting the power front seat (p. 161)
- Storing a position for seat and door mirrors (p. 162)
- Using stored position for seat and rearview mirrors (p. 163)
- Adjusting the length of the seat cushion in the front seat (p. 164)
- Adjusting the lumbar support in the front seat (p. 164)
- Adjusting the passenger seat from the driver's seat (p. 165)
- Usage modes (p. 373)

### IMPORTANT

The power seats have overload protection that is triggered if any seat is blocked by an object. If this happens, remove the object and then move the seat again.



# Adjusting the power front seat

Set to desired sitting position using the control on the front seat's seating section. Use the different controls to set the various comfort functions.



- Using stored position for seat and rearview mirrors (p. 163)
- Adjusting the length of the seat cushion in the front seat (p. 164)
- Adjusting the lumbar support in the front seat (p. 164)
- Adjusting the passenger seat from the driver's seat (p. 165)

- ① Four-way button that controls the seat's four-way lumbar support.
- ② Raise/lower the seat cushion's front edge by adjusting the control up/down.
- ③ Raise/lower the seat by means of adjusting the control up/down.
- ④ Move the seat forward/backward by adjusting the control forward/backward.
- ⑤ Change the backrest inclination by adjusting the control forward/backward.

Only one movement (forward/back/up/down) can be made at a time.

The backrests of the front seats cannot be lowered fully forward.

## Related information

- Front seats (p. 160)
- Power front seat (p. 160)
- Storing a position for seat and door mirrors (p. 162)

# Storing a position for seat and door mirrors

You can store the position for power seat and door mirrors in the memory buttons.

Store two different positions for the power seat and the door mirrors using the memory buttons. The buttons are located on the inside of one of the front doors or both.



- ① Button M for storing settings.
- ② Memory button.
- ③ Memory button.

## Storing a position

1. Adjust seat and door mirrors to the desired position.
2. Press and hold the M button depressed. The light indicator in the button illuminates.
3. Within three seconds, press and hold the 1 or 2 button.
  - > When the position has been stored in the selected memory button, an acoustic signal can be heard and the light indicator in the M button extinguishes.

If none of the memory buttons is depressed within three seconds then the M button extinguishes and no storing takes place.

The seat or the door mirrors must be readjusted before a new memory can be set.

## Related information

- Front seats (p. 160)
- Power front seat (p. 160)
- Adjusting the power front seat (p. 161)
- Using stored position for seat and rearview mirrors (p. 163)
- Adjusting the length of the seat cushion in the front seat (p. 164)
- Adjusting the lumbar support in the front seat (p. 164)
- Adjusting the passenger seat from the driver's seat (p. 165)
- Angling adjustment of the door mirrors (p. 151)

# Using stored position for seat and rearview mirrors

If the positions for the power seat and the door mirrors have been stored, they can be activated by using the memory buttons.

## Using a stored setting



To use a stored position, hold one of the memory buttons depressed, 1 (2) or 2 (3), until the stored position is reached.

If the memory button is released, the movement of the seat and door mirrors will be stopped.

## Related information

- Front seats (p. 160)
- Power front seat (p. 160)
- Adjusting the power front seat (p. 161)
- Storing a position for seat and door mirrors (p. 162)
- Adjusting the length of the seat cushion in the front seat (p. 164)
- Adjusting the lumbar support in the front seat (p. 164)
- Adjusting the passenger seat from the driver's seat (p. 165)
- Angling adjustment of the door mirrors (p. 151)

## WARNING

- Because the driver's seat can be adjusted with the ignition off, children should never be left unattended in the vehicle.
- Movement of the seat can be STOPPED at any time by pressing any button on the power seat control panel.
- Do not adjust the seat while driving.
- Make sure there is nothing under the seats when they are being adjusted.

## Adjusting the length of the seat cushion in the front seat

The length of the seat cushion can be adjusted using the handle on the front of the seat.



Control for seat cushion adjustment.

1. Grip the handle ① on the front of the seat and pull upwards.
2. Adjust the length of the seat cushion.
3. Release the handle and make sure that the seat cushion has reached the correct position.

### Related information

- Front seats (p. 160)
- Power front seat (p. 160)
- Adjusting the power front seat (p. 161)
- Storing a position for seat and door mirrors (p. 162)
- Using stored position for seat and rearview mirrors (p. 163)
- Adjusting the lumbar support in the front seat (p. 164)
- Adjusting the passenger seat from the driver's seat (p. 165)

## Adjusting the lumbar support in the front seat

The lumbar support is adjusted using a control on the side of the seat cushion.

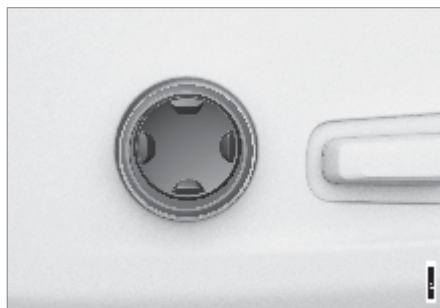

Four-way button that controls the car's four-way lumbar support.

The lumbar support can be adjusted forward/backward and up/down and is located at the side of the seat part of the seat.

### Adjusting the lumbar support

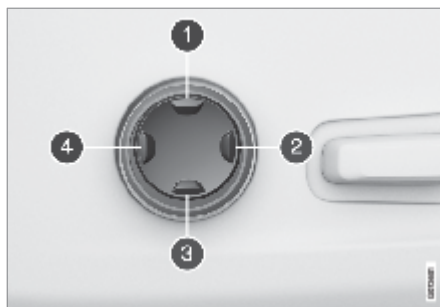

- Press the four-way button up ①/down ③ to move the lumbar support upwards/downwards.
- Press the front section ④ of the four-way button to increase lumbar support.

# Adjusting the passenger seat from the driver's seat

- Press the rear section ② of the four-way button to reduce lumbar support.

## Related information

- Front seats (p. 160)
- Power front seat (p. 160)
- Adjusting the power front seat (p. 161)
- Storing a position for seat and door mirrors (p. 162)
- Using stored position for seat and rearview mirrors (p. 163)
- Adjusting the length of the seat cushion in the front seat (p. 164)
- Adjusting the passenger seat from the driver's seat (p. 165)

The front passenger seat can be adjusted from the driver's seat.

## Activating the function

1. Tap on  in the centre display.
2. Press More.
3. Press Seats.
4. Then select On in the function in order to activate.

## Adjust passenger seat

From activation of the function the driver must adjust the passenger seat within 10 seconds. If no adjustment is made within this time the function is deactivated.

The driver adjusts the passenger seat using the controls on the driver's seat:



- ① Move the passenger seat forward/backward by adjusting the control forward/backward.
- ② Change the passenger seat's backrest inclination by adjusting the control forward/backward.

>>

# Rear seat

## Related information

- Front seats (p. 160)
- Power front seat (p. 160)
- Adjusting the power front seat (p. 161)
- Storing a position for seat and door mirrors (p. 162)
- Using stored position for seat and rearview mirrors (p. 163)
- Adjusting the length of the seat cushion in the front seat (p. 164)
- Adjusting the lumbar support in the front seat (p. 164)

Polestar 2 has five seats. The rear seat is divided into two folding sections, with one and two seats respectively.

## Related information

- Front seats (p. 160)
- Child safety (p. 49)
- Child seats (p. 49)

## WARNING

Only children up to 125 cm (4 feet, 1 inch) may travel on booster cushions in the rear seat. Children more than 125 cm (4 feet, 1 inch) tall travelling on booster cushions must sit in the front seat of the car.<sup>17</sup>

<sup>17</sup> Different countries have different legal provisions relating to the type of child restraint system to be used for children of different ages and heights and how children are to be positioned in the car. Check which rules apply.

# Folding the backrest in the rear seat

The rear seat backrest is divided into two parts. The two parts can be folded forward individually.

The armrest in the centre seat must be folded up before folding the seat down.

The through-load hatch in the rear seat must be closed before being folded.

## Folding the backrest

To make it possible to fold the rear seat, the car must be stationary and at least one rear door must be open.



Make sure that there are no people or objects in the rear seat.

1. Fold down the centre seat head restraint manually.
2. Pull the handles located in the left and right-hand sides of the rear seat back forward to fold down the left and right-hand parts of the rear seat.
3. The backrest is released from the lock and needs to be folded down manually to a horizontal position.

## Folding up the backrest

The backrest is folded up to the upright position manually:

1. Move the backrest up/back.
2. Push the back further until the inhibitor engages.
3. Adjust the centre seat head restraint if necessary.

## Related information

- Adjusting the head restraint in the rear seat (p. 168)

## WARNING

- Adjust the seat and fix it before driving away. Take care when adjusting the seat. Adjusting it carelessly or in an uncontrolled fashion may result in crush injuries.
- When loading long objects, they must always be secured safely so as to prevent injury when braking suddenly.
- Always switch off the engine and apply the parking brake when loading and unloading the car.
- For cars with automatic gearing, set the gear selector to P to prevent the gear selector being moved accidentally.
- The red indicator should no longer be displayed when the backrest has been folded back. If it is still displayed, the backrest has not been locked.

# Adjusting the head restraint in the rear seat

## WARNING

- Check that the backrests and head restraints in the rear seat are locked properly after being folded up.

## IMPORTANT

There must be no objects in the rear seat when the backrest is to be folded. Nor may the seatbelts be connected. Otherwise there is a risk of damaging the upholstery in the rear seat.

## NOTE

The front seats may need to be moved forward and/or the backrests may need to be adjusted to allow the rear backrests to be folded all the way forward.

Adjust the centre seat head restraint according to the height of the passenger.

### Adjusting the centre seat head restraint



The centre seat head restraints must be adjusted according to the height of the passenger so that it covers the entire back of the head if possible. Push it up manually as required.

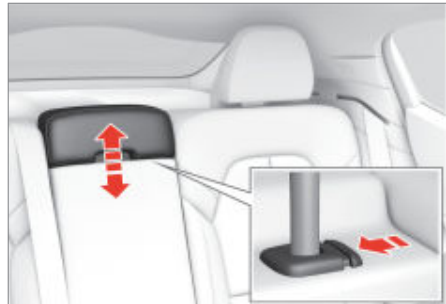

To move the restraint down, the button (see the picture) must be pressed while carefully pushing down the head restraint at the same time.

### Related information

- Folding the backrest in the rear seat (p. 167)



# Steering wheel controls and horn

## WARNING

The head restraint for the centre seat must be in its lowermost position when the centre seat is not in use. When the centre seat is in use, the head restraint must be adjusted correctly to the height of the passenger so that it covers the entire back of the head, if possible.

The steering wheel houses the horn and controls for e.g. the driver support systems and voice control.

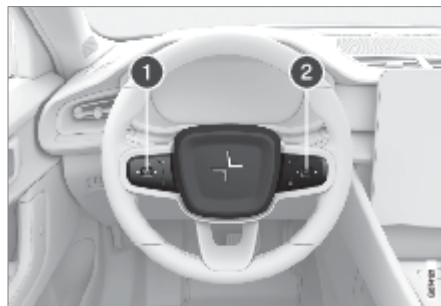

*Keypads in the steering wheel.*

- ① Controls for driver support systems.<sup>18</sup>
- ② Controls for voice control and menu, message and phone handling.

## Horn

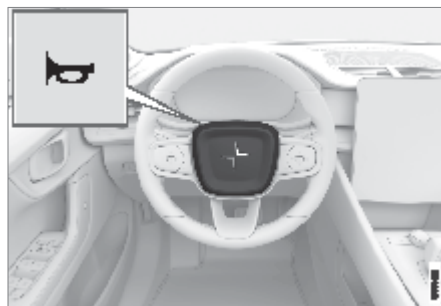

*The horn is located in the centre of the steering wheel.*

## Related information

- Steering lock (p. 170)

>>

# Steering lock

- Adjusting the steering wheel (p. 171)

The steering wheel lock makes it difficult to steer the car if it is stolen, for example. A mechanical noise can be perceived when the steering lock is locked or unlocked.

## Activating the steering lock

The steering lock is activated when the car is locked from the outside. If the car is left unlocked then the steering lock will be activated automatically after a while.

## Deactivating the steering lock

The steering lock is deactivated when the car is unlocked from outside. If the car is not locked, the steering wheel lock will be deactivated as long as the key is in the passenger compartment and the car is started.

## Related information

- Steering wheel controls and horn (p. 169)
- Adjusting the steering wheel (p. 171)

# Adjusting the steering wheel

The steering wheel can be adjusted in different positions.

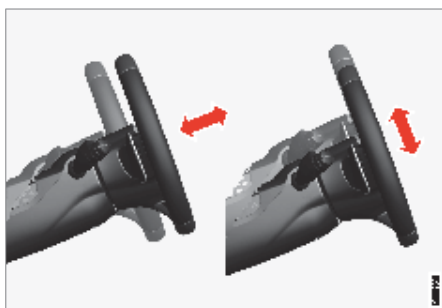

*The steering wheel can be adjusted for height and for depth.*

Adjusting the steering wheel



*Lever for steering wheel adjustment.*

1. Push the lever forwards to release the steering wheel.
2. Adjust the steering wheel to the position that suits you.

3. Pull the lever back to fix the steering wheel in place. If the lever is stiff, press the steering wheel lightly at the same time as you move the lever back.

## Related information

- Steering lock (p. 170)
- Steering wheel controls and horn (p. 169)
- Adjusting the power front seat (p. 161)

## WARNING

Adjust the steering wheel and fix it before driving away. The steering wheel must never be adjusted while driving.



Section 08

—

Climate

# Climate

The car is equipped with electronic climate control. The climate control system cools or heats as well as dehumidifies the air in the passenger compartment.

All climate control system functions are controlled from the centre display and physical buttons in the centre console. Many of the climate functions can be controlled with voice control.

## Activation of climate control

The climate control functions are available when someone is sitting in the driver's seat or the centre display is in use.<sup>19</sup>

Climate control starts automatically during fast charging.

## Related information

- Climate zones (p. 175)
- Climate control - sensors (p. 175)
- Perceived temperature (p. 176)
- Using voice control (p. 125)
- Parking climate (p. 193)
- Air quality (p. 176)
- Air distribution (p. 179)
- Climate controls (p. 181)
- Usage modes (p. 373)

## NOTE

- Heating or cooling cannot be hastened by selecting a higher or lower temperature than the actual desired temperature.

## NOTE

- If necessary, the climate control can be used to cool down the media system in the centre display. In these cases, the message Cooling infotainment system is shown in the driver display.

# Climate zones

The number of climate zones that the car is divided into governs the options for setting different temperatures for different parts of the passenger compartment.

## 2-zone climate

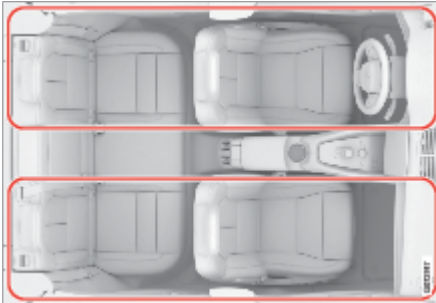

*Climate zones with 2-zone climate.*

With 2-zone climate, the temperature in the passenger compartment can be set separately for the left and right-hand sides.

### Related information

- Climate (p. 174)

# Climate control - sensors

The climate control system has a number of sensors to help control the climate in the car. Do not cover or block the sensors with clothing or other objects.

## Sensor location

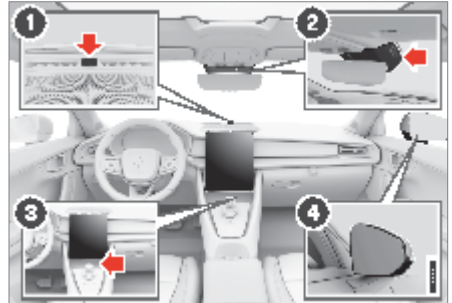

- ① Sun sensor - on the upper side of the instrument panel.
- ② Moisture sensor - in the casing by the interior rearview mirror.
- ③ Temperature sensor for the passenger compartment - by the physical buttons in the centre console.
- ④ Outside temperature sensor - in the right-hand door mirror.

With the Interior Air Quality System there is also an air quality sensor that is fitted into the climate control system air intake.

### Related information

- Climate (p. 174)
- Interior Air Quality System (p. 178)

# Perceived temperature Air quality

The climate control system regulates the climate in the passenger compartment based on the perceived temperature, not on actual temperature.

The temperature you select in the passenger compartment corresponds to the physically perceived temperature as affected by factors such as the ambient temperature, air speed, humidity, solar radiation, etc. in and around the car at the time.

The system includes a sun sensor which detects on which side the sun is shining into the passenger compartment. This means that the temperature can differ between the right and left-hand side's air vents despite the controls being set for the same temperature on both sides.

## Related information

- Climate (p. 174)

The materials selected for the passenger compartment and the air cleaning system ensure that the air quality in the passenger compartment is high.

## Materials in the passenger compartment

The interior of the passenger compartment is designed to be pleasant and comfortable, even for people with contact allergies and for asthma sufferers.

Tested materials have been developed in order to reduce the quantity of dust in the passenger compartment and to contribute to making the passenger compartment easier to keep clean.

The carpets in both the passenger compartment and the cargo area are removable and easy to remove and clean.

Use cleaning agents and car care products recommended by Polestar to clean the interior.

## Air cleaning system

In addition to the passenger compartment filter, Clean Zone Interior Package and the Interior Air Quality System also help to maintain high air quality in the passenger compartment.

## Related information

- Climate (p. 174)
- CleanZone (p. 177)
- Clean Zone Interior Package (p. 177)
- Interior Air Quality System (p. 178)
- Passenger compartment filter (p. 179)



# CleanZone

The CleanZone function checks and indicates whether or not all conditions have been met for good air quality in the passenger compartment.

If the conditions have not been met then the CleanZone text in the climate view is white. When all conditions have been met, this is indicated by the text changing colour to blue.

Conditions that need to be met:

- That all doors and the boot lid are closed.
- That all side windows are closed.
- That the air quality system Interior Air Quality System is activated.
- That the ventilation fan is activated.
- That the air recirculation is deactivated.

## Related information

- Air quality (p. 176)
- Clean Zone Interior Package (p. 177)
- Interior Air Quality System (p. 178)
- Passenger compartment filter (p. 179)

## NOTE

CleanZone does not indicate that the air quality is good. It only indicates that the conditions for good air quality have been met.

# Clean Zone Interior Package

Clean Zone Interior Package (CZIP) comprises a series of modifications that keep the passenger compartment even clearer from allergy and asthma-inducing substances.

The following is included:

- An enhanced fan function that means that the fan starts when the car is unlocked with the remote control key. The fan fills the passenger compartment with fresh air. The function starts when required and is disengaged automatically after a time or when one of the passenger compartment doors is opened. The amount of time the fan runs is reduced gradually due to reduced need up until the car is 4 years old.
- The fully automatic air quality system Interior Air Quality System (IAQS).

## Related information

- Air quality (p. 176)
- CleanZone (p. 177)
- Interior Air Quality System (p. 178)
- Passenger compartment filter (p. 179)

# Interior Air Quality System

Interior Air Quality System (IAQS) is a fully automatic air quality system that separates gases and particles to reduce the levels of odours and contaminants in the passenger compartment.

IAQS is a part of the Clean Zone Interior Package (CZIP) and cleans the air in the passenger compartment from contaminants such as particles, hydrocarbons, nitrous oxides and ground-level ozone.

If the air quality sensor senses that the outside air is contaminated, the air intake is closed and air recirculation is activated.

## Related information

- Activating and deactivating the air quality sensor (p. 178)
- Air quality (p. 176)
- CleanZone (p. 177)
- Clean Zone Interior Package (p. 177)
- Passenger compartment filter (p. 179)

# Activating and deactivating the air quality sensor

The air quality sensor is part of the fully automatic air quality system Interior Air Quality System (IAQS).

It is possible to set whether the air quality sensor should be activated/deactivated.

1. Open the climate view in the centre display by swiping up on the home view.
2. Press Settings in the climate view.
3. Select desired setting under Air Quality Sensor to activate/deactivate the air quality sensor.

## Related information

- Interior Air Quality System (p. 178)

## NOTE

The air quality sensor must always be enabled to ensure the best air in the passenger compartment.

In a cold climate recirculation is limited so as to prevent misting.

In the event of misting, the defrost functions for windscreen, side windows and rear window should be used.

# Passenger compartment filter

All air entering the car's passenger compartment is cleaned with a filter.

## Replacing the passenger compartment filter

To maintain high climate system performance, the filter must be changed at regular intervals. Follow the Polestar Service Programme for the recommended replacement intervals. If the car is used in a severely contaminated environment, it may be necessary to replace the filter more often.

## Related information

- Air quality (p. 176)
- CleanZone (p. 177)
- Clean Zone Interior Package (p. 177)
- Interior Air Quality System (p. 178)

## NOTE

There are different types of passenger compartment filter. Make sure that the correct filter is fitted.

# Air distribution

The climate control system distributes the incoming air via a number of different vents in the passenger compartment.

## Automatic and manual air distribution

With auto-regulated climate running the air distribution takes place automatically. If necessary, the air distribution can be controlled manually.

## Adjustable air vents

Some of the air vents in the car are adjustable, which means that you can open/close the vent to aim the air flow.

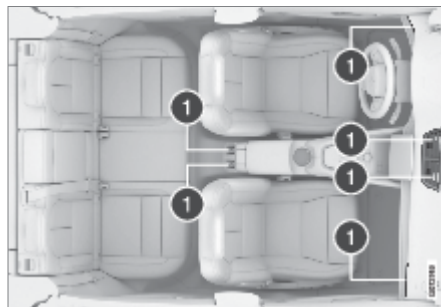

*Location of adjustable air vents in the passenger compartment.*

- ① Four on the instrument panel and two at the rear of the tunnel console.

## Related information

- Climate (p. 174)
- Changing air distribution (p. 180)
- Opening, closing and aiming the air vents (p. 180)

# Changing air distribution

The air distribution can be changed manually if required.

1. Open the climate view in the centre display by swiping up on the home view.
2. The air distribution buttons in the climate view are located in the middle around the AUTO button, from the top:
  - Air distribution - windscreen defroster vents
  - Air distribution - air vents in instrument panel and centre console
  - Air distribution - air vents in the floor

Press one or more of the air distribution buttons in order to open/close the corresponding air flow.

- > The air distribution is changed and the buttons illuminate/extinguish.

If all air distribution buttons are deselected in manual mode, the climate control system returns to automatically regulated climate control.

## Related information

- Air distribution (p. 179)
- Opening, closing and aiming the air vents (p. 180)

# Opening, closing and aiming the air vents

Some air vents in the passenger compartment can be opened, closed and aimed individually.

If the car's outer vents are aimed at the side windows then misting can be eliminated.

If the car's outer vents are aimed inwards then, in a hot climate, a comfortable environment is obtained in the passenger compartment.

## Opening and closing the air vents

Air vents on the instrument panel and at the back of the tunnel console:

- Turn the rotary knob in the middle of the air vent to open/close the air flow from the vent.

The air flow is at maximum when the marking on the knob is in vertical position.

## Aiming the air vents

- Move the lever in the middle of the air vent horizontally/vertically to direct the air flow from the vent.

## Related information

- Air distribution (p. 179)
- Changing air distribution (p. 180)

# Climate controls

The climate control system's functions are controlled from physical buttons in the centre console, the centre display and the climate controls at the rear of the tunnel console.

## Physical buttons in centre console



- 1 Button for max defroster.
- 2 Button for heated rear window and door mirrors.

## Climate row in centre display

The most common climate functions can be regulated from the climate row.

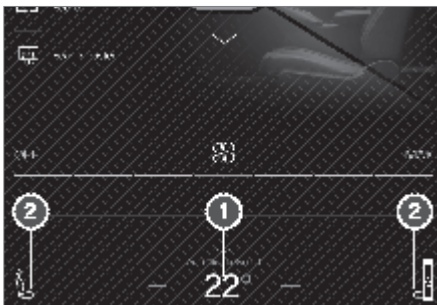

- 1 Temperature controls for driver and passenger side.<sup>20</sup>
- 2 Controls for heated driver and front passenger seats, ventilated seats and heated steering wheel.

## Climate view in centre display

Open the climate view in the centre display by swiping up on the home view.

## Main climate

In addition to the climate row's functions, other main climate functions can also be controlled under Main Climate.



Controls for max. defroster.



Controls for air conditioning.



Controls for air recirculation.



Controls for heated rear window and door mirrors.

<sup>20</sup> If synchronisation of the temperature has been deactivated, the current temperature is shown both on the driver and passenger side.

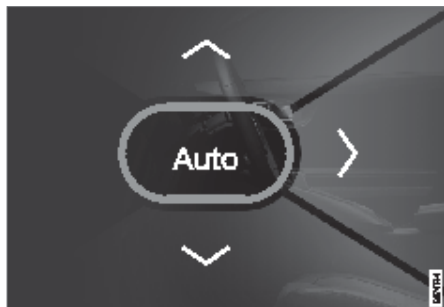

Button for auto-regulation of the climate control and arrows for air distribution.

#### Parking climate

The car's parking climate control can be adjusted under Parking.

#### Settings

Additional climate settings can be made under Settings.

#### Physical buttons at the rear of the tunnel console

There are physical buttons at the rear of the tunnel console to control the seat heating for the rear seat.

#### Related information

- Climate (p. 174)
- Activating and deactivating heated front seat (p. 183)
- Activating and deactivating heated rear seat\* (p. 184)
- Activating and deactivating ventilated front seat\* (p. 185)

- Activating and deactivating the heated steering wheel (p. 185)
- Activating auto climate control (p. 186)
- Activating and deactivating air recirculation (p. 187)
- Activating and deactivating max defroster (p. 188)
- Activating and deactivating the heated rear window and door mirrors (p. 189)
- Regulating fan level for front seat (p. 190)
- Synchronising temperature (p. 191)
- Activating and deactivating air conditioning (p. 192)
- Changing air distribution (p. 180)

## Activating and deactivating heated front seat

The seats can be heated in order to increase comfort for driver and passengers when it is cold.



1. Press the seat button for the driver's side or passenger side in the centre display's climate row in order to open the controls for seat heating.



2. Tap on the heated seat button repeatedly to switch the heat on/off and toggle between the three heat levels.
  - > The level changes and the button shows the set level.

### Related information

- Climate controls (p. 181)
- Activating and deactivating automatic start of heated front seat (p. 183)

## WARNING

Heated seats must not be used by people who find it difficult to perceive an increase in temperature due to a lack of sensation or who otherwise have problems operating the controls for the heated seats.

## Activating and deactivating automatic start of heated front seat

The seats can be heated in order to increase comfort for driver and passengers when it is cold.

It is possible to set whether automatic start of heated seats should be activated/deactivated when the driver gets into the car.<sup>21</sup> With automatic start activated, heating will start in low ambient temperature.

1. Open the climate view in the centre display by swiping up on the home view.
2. Press Settings in the climate view.
3. Select the desired setting under Auto Driver Seat Heating Level and Auto Passenger Seat Heating Level in order to activate/deactivate automatic start of heated driver's and passenger seat.

### Related information

- Climate controls (p. 181)
- Activating and deactivating heated front seat (p. 183)
- Usage modes (p. 373)

# Activating and deactivating heated rear seat

The seats can be heated in order to increase comfort for driver and passengers when it is cold.

## Activating and deactivating heated rear seat



*Buttons for heated rear seats on the tunnel console.*

- Repeatedly press the physical heated seat button on the left-hand or right-hand side on the tunnel console at the back to switch the heat on/off and toggle between the three heat levels.
  - > The level changes and the LEDs in the button show the set level.

## Related information

- Climate controls (p. 181)

## WARNING

Heated seats must not be used by people who find it difficult to perceive an increase in temperature due to a lack of sensation or who otherwise have problems operating the controls for the heated seats.



## Activating and deactivating ventilated front seat

The seats can be ventilated for extra comfort in a hot climate, for example.

The ventilation system is made up of fans in the seats and backrests, which suck air through the seat upholstery. The colder the air is in the passenger compartment, the greater the cooling effect.



1. Press the seat button for the driver's side or passenger side in the centre display's climate row in order to open the controls for ventilated seats.



2. Tap on the button for ventilated seats repeatedly to switch the ventilation On/Off and toggle between the three ventilation levels.
  - > The level changes and the button shows the set level.

### Related information

- Climate controls (p. 181)

## Activating and deactivating the heated steering wheel

The steering wheel can be heated in order to increase comfort for the driver when it is cold.



1. Tap on the driver side seat button in the climate row in the centre display to show the controls for the steering wheel heating.



2. Tap on the heated steering wheel button repeatedly to switch the heat on/off and toggle between the three heat levels.
  - > The level changes and the button shows the set level.

### Related information

- Climate controls (p. 181)
- Activating and deactivating automatic start of heated steering wheel (p. 186)

## Activating and deactivating automatic start of heated steering wheel

The steering wheel can be heated in order to increase comfort for the driver when it is cold.

It is possible to set whether automatic start of heated steering wheel should be activated/ deactivated when the driver gets into the car.<sup>22</sup> With automatic start activated, heating will start in low ambient temperature.

1. Open the climate view in the centre display by swiping up on the home view.
2. Press Settings in the climate view.
3. Select desired setting under Auto Start Steering Wheel Heat to activate/deactivate automatic start of heated steering wheel.

### Related information

- Activating and deactivating the heated steering wheel (p. 185)
- Usage modes (p. 373)

## Activating auto climate control

With auto climate control activated, multiple climate functions are controlled automatically.

1. Open the climate view in the centre display by swiping up on the home view.
  2. Give a short or long press on AUTO.
    - Short press - air recirculation, air conditioning and air distribution are controlled automatically.
    - Long press - air recirculation, air conditioning and air distribution are controlled automatically, temperature and fan speed are changed to standard settings: 22 °C (72 °F) and level 3.
- > Auto-regulation of the climate is activated and the button illuminates.

### Related information

- Climate controls (p. 181)

### NOTE

Temperature and fan speed can be changed without deactivating the automatically-regulated climate control system. The automatically-regulated climate control system is deactivated when the air distribution is changed manually or when maximum defroster is activated.

# Activating and deactivating air recirculation

Air recirculation shuts out bad air, exhaust gases, etc. from outside the car by the climate control system reusing the air in the passenger compartment.

1. Open the climate view in the centre display by swiping up on the home view.



2. Tap on the button for air recirculation.
  - > Air recirculation is activated/deactivated and the button illuminates/extinguishes.

## Related information

- Climate controls (p. 181)
- Activating and deactivating time setting for air recirculation (p. 187)

## IMPORTANT

If the air in the car is recirculated for too long then there is a risk of misting on the insides of the windows.

## NOTE

- It is not possible to activate air recirculation when max defroster is activated.
- If the system's air quality sensor detects that the outdoor air is contaminated, the air intake is closed and air recirculation is activated automatically.

# Activating and deactivating time setting for air recirculation

Air recirculation shuts out bad air, exhaust gases, etc. from outside the car by the climate control system reusing the air in the passenger compartment.

It is possible to set whether the air recirculation timer should be activated/deactivated. When the timer is activated, air recirculation is automatically switched off after 20 minutes.

1. Open the climate view in the centre display by swiping up on the home view.
2. Press Settings in the climate view.
3. Select desired setting under Recirculation Timer to activate/deactivate the air recirculation timer.

## Related information

- Activating and deactivating air recirculation (p. 187)

# Activating and deactivating max defroster

Max defroster is used to quickly remove mist and ice from windows.

Max defroster deactivates auto-regulation of the climate and air recirculation, activates air conditioning and changes the fan level to 5 and the temperature to HI.

When max defroster is deactivated, the climate control system returns to the previous settings.

## Activating and deactivating max defroster from centre console

There is a physical button in the centre console for quick access to max defroster.

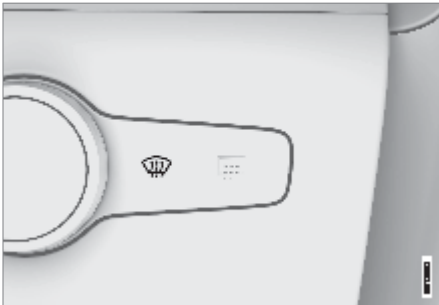

*Physical button in the centre console.*

- Press the button.
  - > Max defroster is activated/deactivated and the button illuminates/extinguishes. While max defroster is activated, the temperature in the different climate zones is not synchronised.

## Activating and deactivating max defroster from centre display

1. Open the climate view in the centre display by swiping up on the home view.



2. Press the button for max. defroster.

- > Max defroster is activated/deactivated and the button illuminates/extinguishes. While max defroster is activated, the temperature in the different climate zones is not synchronised.

## Related information

- Climate controls (p. 181)

## NOTE

Changing the fan level to 5 increases the noise level.

# Activating and deactivating the heated rear window and door mirrors

The heated rear window and door mirrors are used to quickly remove mist and ice from the windows and mirrors.

## Activating and deactivating heated rear window and door mirrors from centre console

In the centre console is a physical button for rapid access to the heated rear window and door mirrors.

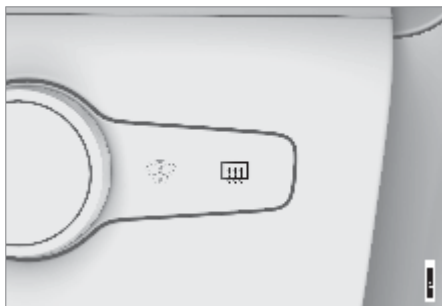

*Physical button in the centre console.*

- Press the button.
  - > Heated rear window and door mirrors are activated/deactivated and the button illuminates/extinguishes.

## Activating and deactivating heated rear window and door mirrors from centre display

1. Open the climate view in the centre display by swiping up on the home view.



2. Press the button for heated rear window and door mirrors.
  - > Heated rear window and door mirrors are activated/deactivated and the button illuminates/extinguishes.

## Related information

- Climate controls (p. 181)
- Activating and deactivating automatic starting of the heated rear window and door mirrors (p. 190)

## Activating and deactivating automatic starting of the heated rear window and door mirrors

The heated rear window and door mirrors are used to quickly remove mist and ice from the windows and mirrors.

It is possible to set whether automatic start of heated rear window and door mirrors should be activated/deactivated when the driver gets into the car.<sup>23</sup> With automatic start activated, heating will start when there is a risk of ice or misting on the windscreen/window. The heating switches off automatically when the windscreen/window is sufficiently warm and the ice or misting is gone.

1. Open the climate view in the centre display by swiping up on the home view.
2. Press Settings in the climate view.
3. Select desired setting under Auto Rear Defroster to activate/deactivate automatic start of heated rear window and door mirrors.

### Related information

- Activating and deactivating the heated rear window and door mirrors (p. 189)
- Usage modes (p. 373)

## Regulating fan level for front seat

The fan can be set to several different automatically controlled fan speeds for the front seat.

1. Open the climate view in the centre display by swiping up on the home view.
2. Tap on the desired fan level: OFF, 1-5 or Max.
  - > Fan level is changed and the selected level illuminates.

### Related information

- Climate controls (p. 181)

### IMPORTANT

If the fan is fully switched off then the air conditioning is not engaged, which results in a risk of misting on the insides of the windows.

### NOTE

The climate control system automatically adjusts the air flow within the selected fan level based on requirements. This means that the fan speed may change even though the fan level is the same.

# Regulating temperature for front seat

The temperature can be set to the desired number of degrees for the front seat's climate zones.

1. Tap on the temperature button in the middle of the climate row on the centre display to open the control.<sup>24</sup>
2. Drag the control to the desired temperature.
  - > The temperature changes and the button shows the set temperature.

## Related information

- Climate controls (p. 181)

### NOTE

Heating or cooling cannot be hastened by selecting a higher or lower temperature than the actual desired temperature.

# Synchronising temperature

The temperature in the car's different climate zones is as standard synchronised with the set temperature for the driver's side, but it is possible to deactivate synchronisation and set the temperature separately for the individual climate zones.

## Deactivating synchronisation of temperature

1. Tap on the temperature button in the middle of the climate row in the centre display to open the control.



2. Tap on the synchronisation button above the temperature controls.
  - > The temperature can now be set separately for the individual climate zones. Set temperature is now shown separately on the driver's and passenger side in the climate row instead of only in the middle.

## Resetting synchronised temperature

1. Press the temperature button for the driver's and passenger side in the centre display's climate row in order to open the controls.



2. Tap on the synchronisation button above the temperature controls.
  - > The temperature for all zones in the car is synchronised with the set temperature for the driver's side.

<sup>24</sup> If synchronisation of the temperature has been deactivated, the current temperature is shown both on the driver and passenger side.

# Activating and deactivating air conditioning

## Related information

- Climate controls (p. 181)

The air conditioning cools and dehumidifies incoming air as required.

When the air conditioning is activated, the climate control system automatically controls starting and switching off as required.

1. Open the climate view in the centre display by swiping up on the home view.



2. Tap on the air conditioning button.
  - > The air conditioning is activated/deactivated and the button illuminates/extinguishes.

## Related information

- Climate controls (p. 181)

### NOTE

- Close all side windows for air conditioning to work optimally.
- It is not possible to activate the air conditioning when the fan control is in OFF position.



# Parking climate

Parking climate control is a generic term for various functions that improve the passenger compartment climate when the car is parked, e.g. preconditioning.

Open the climate view in the centre display by swiping up in the home view and tapping on Parking to access the functions.

## Related information

- Climate (p. 174)
- Preconditioning (p. 193)
- Symbols and messages for parking climate control (p. 195)

# Preconditioning

Preconditioning is a climate function which, if possible, attempts to reach comfort temperature in the passenger compartment before departure.

Preconditioning can only be started with direct start from the centre display.

The function utilises several systems in different cases:

- In a cold climate, the parking heater warms up the passenger compartment to a comfortable temperature.
- The air conditioning, in a hot climate, cools the passenger compartment to the comfort temperature.
- Heated rear window and door mirrors are automatically activated as required.

During preconditioning in a hot climate, condensation from the air conditioning may drip under the car. This is normal.

## Related information

- Parking climate (p. 193)
- Start and switch off preconditioning (p. 194)

## NOTE

- Preconditioning is available when the high voltage battery is sufficiently charged, but running preconditioning without the car connected to an electrical socket affects the car's range.

# Start and switch off preconditioning

## NOTE

- During preconditioning of the passenger compartment, the car works to reach comfort temperature and not the temperature set in the climate control system.

Preconditioning heats or cools the passenger compartment, if possible, prior to driving. The function is started using direct start from the centre display.

1. Open the climate view in the centre display by swiping up on the home view.
2. Press Parking.
3. Tap on Start preconditioning to direct-start the preconditioning.

## Related information





- Parking climate (p. 193)
- Preconditioning (p. 193)
- Range for electric operation (p. 392)
- Usage modes (p. 373)

## NOTE

- Preconditioning is available when the high voltage battery is sufficiently charged, but running preconditioning without the car connected to an electrical socket affects the car's range.
- The car's doors and windows should be closed during the preconditioning of the passenger compartment.
- When there is someone sitting in the driver's seat<sup>25</sup> preconditioning is paused and normal climate control is started. When the car starts to drive<sup>26</sup>, preconditioning is switched off.

# Symbols and messages for parking climate control

A number of symbols and messages regarding parking climate control can be shown in the driver display.

Symbol	Message	Specification
	Parking climate Service required	Parking climate control is disengaged. Contact Polestar Support to check the function as soon as possible.
	Parking climate Temporarily unavailable	Parking climate control is temporarily disengaged. If the problem persists for some time, contact Polestar Support to check the function.
	Parking climate unavailable Charge level too low	Parking climate control cannot be activated if the State of Charge (SoC) of the high voltage battery is too low to start the parking heater. Start the car.
	Limited parking climate Charge level too low	The running time for parking climate control is limited when the State of Charge (SoC) in the high voltage battery is too low. Start the car.

## Related information

- Parking climate (p. 193)

# Parking heater

The parking heater heats the passenger compartment as necessary before driving if the car's preconditioning is activated.

The parking heater is a high-voltage heater and is fitted under the front cargo area.

The parking heater starts automatically if the parking climate's preconditioning is activated and the passenger compartment needs to be heated up.

It switches off automatically when the car is started.

## Battery and charging

The heater is powered by the car's high voltage battery. If the charge level of the high voltage battery is too low, then the heater is switched off automatically and the driver display shows a message.

### NOTE

Make sure that there is enough charge in the high voltage battery if the parking heater needs to be used.

## Section 09

—

## Key, locks and alarm

## Locking and unlocking

The car can be locked and unlocked in several different ways.

- with the key's buttons
- with the key tag
- keyless, the key must be within range
- from the inside of the car using the locking controls in the doors
- remote unlocking with Polestar Connect
- using the detachable key blade (if the battery in the key is exhausted).

### Related information

- Locking and unlocking settings (p. 200)
- Contact Polestar (p. 14)
- Locking and unlocking with the key (p. 210)
- Keyless locking and unlocking of doors (p. 199)
- Locking and unlocking from inside the car (p. 205)
- Alarm (p. 237)

## Keyless locking and unlocking

With the keyless locking and unlocking function, just having the key with you in your pocket or bag is enough to unlock the doors and tailgate. The car is locked or unlocked by touching the door handle.

### Related information

- Keyless locking and unlocking of doors (p. 199)
- Keyless tailgate unlocking (p. 200)
- Closing and locking the tailgate with the button (p. 201)
- Keyless opening and closing of the tailgate with a foot movement (p. 203)
- Locking and unlocking settings (p. 200)

### NOTE

Be aware that the system may be activated in connection with car washing if the key is in range.

# Keyless locking and unlocking of doors

Keyless unlocking allows the doors to be opened by gripping the door handle.



- ① Touch-sensitive recess for locking.
- ② Touch-sensitive surface for unlocking.

- Touch the button on the handle or grip the handle
  - > The car is locked or unlocked.

## Automatic relocking

If none of the doors is opened within 2 minutes of unlocking, they are locked automatically. This function prevents the car from being left unlocked unintentionally.

## Related information

- Locking and unlocking settings (p. 200)
- Keyless tailgate unlocking (p. 200)
- Keyless locking and unlocking (p. 198)

## NOTE

- One of the car's keys must be within range for locking and unlocking to work.
- Be aware that the system may be activated in connection with car washing if the key is in range.

## Locking and unlocking settings

Settings for locking and unlocking can be adjusted as required in the centre display.

1. Tap on  in the centre display.
2. Press More.
3. Select Locking.
4. Change the preferred settings.

## Keyless tailgate unlocking

Using keyless locking and unlocking, it is sufficient to press gently on the rubberised pressure plate on the tailgate's handle in order to unlock.

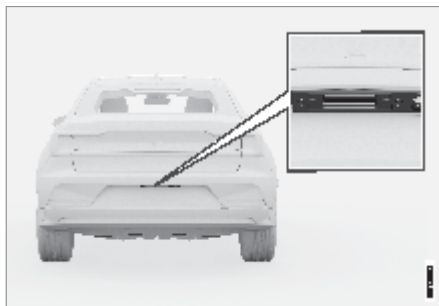

*The handle is positioned beneath the tailgate.*

- Press gently on the rubberised pressure plate beneath the tailgate's handle.
  - > The tailgate is now unlocked.

### Related information

- Closing and locking the tailgate with the button (p. 201)
- Keyless locking and unlocking of doors (p. 199)
- Keyless locking and unlocking (p. 198)
- Key range (p. 212)
- Keyless opening and closing of the tailgate with a foot movement (p. 203)

### WARNING

Do not drive with an open tailgate! Toxic exhaust fumes could be drawn into the car through the cargo area.



# Closing and locking the tailgate with the button

## IMPORTANT

- Minimal force is required to release the tailgate's lock - just gently press on the rubberised panel.
- Do not place the lift force on the rubber panel when opening the tailgate - lift the handle. Using too much force may damage the electrical contacts on the rubber panel.

## NOTE

One of the car's keys must be within range behind the car for unlocking to work.

The buttons on the underside of the tailgate can close and lock the car automatically.



### Closing

- Tap on the  button on the underside of the tailgate.
  - > The tailgate closes automatically and remains unlocked.

### Closing and locking

- Tap on the  button on the underside of the tailgate.
  - > The tailgate closes automatically and the car is locked<sup>27</sup>.

### Cancel closing

- Press the button on the instrument panel.
- Press the key's button.
- Tap on the closing button on the underside of the tailgate.
- Press the tailgate handle.
- Using a foot movement.

The tailgate movement is interrupted and stops. The tailgate can then be operated manually.

>>

If the tailgate is stopped when it is almost closed, the next activation will open the tailgate.

### Pinch protection

If anything offering sufficient resistance prevents the tailgate opening or closing, pinch protection is activated.

- When opening – the movement is interrupted, the tailgate stops and a long signal sounds.
- When closing – the movement is interrupted, the tailgate stops, a long signal sounds and the tailgate returns to its set maximum opening.

### Pretensioned springs



### Related information

- Setting the maximum tailgate opening (p. 203)
- Keyless opening and closing of the tailgate with a foot movement (p. 203)

## WARNING

- Note the risk of crushing when opening and closing.
- Check that there is nobody near the tailgate before starting to open or close it as a crush injury may have severe consequences.
- Always operate the tailgate with caution.
- Do not open the pretensioned springs. They are pretensioned to a high pressure and may cause injury if opened.

## NOTE

- During manual tailgate operation, open or close it slowly. Do not use force to open/close it if there is resistance. It may be damaged and stop working correctly.
- The button is active 24 hours after the hatch has been left open. Thereafter, it must be closed manually.
- If the flap has been open for more than 30 minutes, it will close at a slow speed.
- One of the car's keys must be within range for locking and unlocking to work.
- When locking or closing, three signals will sound if the key is not detected sufficiently close to the tailgate.

## Setting the maximum tailgate opening

Adapt the maximum tailgate opening, e.g. to make things easier if the car is in a garage where space is restricted.

### Setting max. opening

1. Open the tailgate and stop it in the preferred opening position.
2. Press and hold down the  button on the underside of the tailgate for approximately 3 seconds.
  - > Two signals sound, and the stored position is therefore saved.

### Restoring maximum opening

1. Open the tailgate to the fully open position.
2. Press and hold down the  button on the underside of the tailgate for approximately 3 seconds.
  - > Two signals sound, and the stored position is therefore deleted.

### Related information

- Closing and locking the tailgate with the button (p. 201)

### NOTE

- It is not possible to set a lower opening position than a half-open tailgate.
- If the system has worked constantly for too long, it will switch off in order to prevent overloading. It can be used again after approx. 2 minutes.

## Keyless opening and closing of the tailgate with a foot movement

The tailgate can be opened and closed by moving a foot under the bumper, which makes life easier when your hands are full.



*The sensor is located under the centre of the rear bumper.*

One of the car's keys must be within range behind the car, approx. 1 metre (3 feet), for opening to be possible. This also applies to an already unlocked car in order to avoid accidental opening e.g. in a car wash.

## Opening and closing with foot movement



*Kicking motion within the detector's activation area.*

1. Make one forward kicking motion under the centre of the rear bumper.
2. Take one step back, the bumper must not be touched.
  - > A short acoustic signal sounds when opening and closing is activated – the tailgate is opened/closed.

If several kicking motions take place without an approved key being located behind the car, opening will not be possible until after a certain delay.

Do not leave your foot positioned under the car during the kicking motion. This could cause activation to fail.

### Interrupt opening or closing with a foot movement

- Make one forward kicking motion while the tailgate is opening or closing in order to stop its movement.

The key does not need to be near to the car to interrupt tailgate opening or closing.

If the tailgate is stopped when it is almost closed, the next activation will open the tailgate.

### Related information

- Keyless locking and unlocking (p. 198)
- Key range (p. 212)

### NOTE

- One of the car's keys must be within range for locking and unlocking to work.
- There is a risk of reduced function, or no function, if the left rear wing is loaded with large amounts of ice, snow, dirt or similar. For this reason, make sure you keep it clean.
- Pay attention to the possibility that the system may be activated in a car wash or similar if the key is within range.

# Antenna locations for the start and lock systems

Antennas for the keyless start and lock system are built into the car.

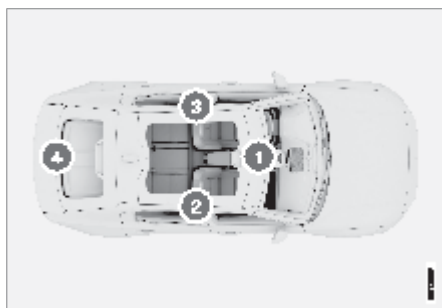

Antenna locations:

- ① In the storage compartment in the tunnel console
- ② In the upper front section of the left-hand rear door
- ③ In the upper front section of the right-hand rear door
- ④ In the cargo area

## Related information

- Keyless locking and unlocking (p. 198)
- Key range (p. 212)

## WARNING

People with pacemaker operations should not come closer than 22 cm (9 inches) to the keyless system's antennas with their pacemaker. This is to prevent interference between the pacemaker and the keyless system.

# Locking and unlocking from inside the car

The doors and tailgate can be locked and unlocked from inside using the central locking controls in the driver's door.

Depending on the settings in the key, either all doors or only the selected door will be unlocked.

## Front doors



*Locking and unlocking button with indicator lamp in the driver's door.*

## Locking

- Tap on the  button – all doors must be closed.
  - > All doors and the tailgate are locked.

## Unlocking<sup>28</sup>

- Tap on the  button.
  - > All doors and the tailgate are unlocked.

<sup>28</sup> Depending on the settings in the key, either all doors or only the selected door will be unlocked.

# Unlocking the tailgate from the inside of the car

## Rear doors



## Locking

The door must be closed to allow locking.

- Tap on the  button.
  - > The doors are locked.

## Unlocking<sup>28</sup>

Alternative unlocking using the door handles.



- Pull the door handle.
  - > The door is unlocked <sup>29</sup>.

## Related information

- Locking and unlocking settings (p. 200)
- Unlocking the tailgate from the inside of the car (p. 206)
- Activating and deactivating the child lock (p. 207)

The tailgate can be unlocked from inside by pressing the button on the instrument panel.



- Brief press on the  button on the instrument panel.
  - > The tailgate is unlocked and can be opened from outside using the handle under the tailgate.
- Long press on the  button on the instrument panel.
  - > The tailgate opens.

## Related information

- Locking and unlocking from inside the car (p. 205)

# Activating and deactivating the child lock

The child lock prevents the rear doors being opened from inside.

The child lock can either be manual or electrical.

## Manual child lock

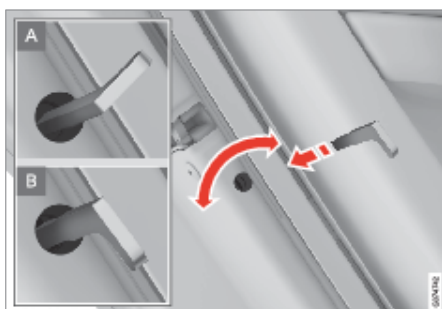

*Manual child lock. Which must not be mixed up with manual door lock.*

- Use the key's detachable key blade to turn the knob.

**A** The door is blocked against opening from the inside.

**B** The door can be opened both from outside and from inside.

## Electric child lock



*Button for activation and deactivation.*

- Lamp illuminated – the lock is activated.
- Lamp extinguished – the lock is deactivated.

When the child lock is activated, the rear

- windows can only be opened using the buttons in the driver's door
- doors cannot be opened from the inside.

If the child lock is activated when the car is switched off, the function will continue to be activated the next time the car is started.

## Symbols and messages

Symbol	Message	Specification
	Rear child lock activated	The child lock is activated.
	Rear child lock deactivated	The child lock is deactivated.

# Key

## Related information

- Locking and unlocking from inside the car (p. 205)
- Detachable key blade (p. 217)

## NOTE

- The knob control on a door only blocks that particular door - not both rear doors simultaneously.
- Cars with an electric child safety lock do not have a manual child lock.

The car is supplied with two keys and a key tag.



*Key or key tag (Key Tag).*

The keys are not used physically when starting as the car has keyless starting. It is sufficient for a key to be present in the car to allow the car to start.





These keys can be linked to different user profiles to save personal preferences in the car.

## The key's buttons



*The key has four buttons - one on the left-hand side and three on the right-hand side.*



-  Locking – A button press locks the doors and the tailgate while also activating the alarm at the same time.  
A longer button press closes all windows.
-  Unlocking – A button press unlocks the doors and tailgate while also deactivating the alarm at the same time.  
A longer button press opens all windows in order to air the car quickly in hot weather, for example.
-  Tailgate – A button press unlocks the tailgate while also deactivating the alarm at the same time.  
A longer button press opens the tailgate. The tailgate is also closed with a longer button press – acoustic warning signals sound.
-  Panic function – Used to attract attention in an emergency. Press and hold the button for at least 3 seconds or press it twice within 3 seconds to activate the direction indicators and the horn. The function can be turned off with the same button once it has been active for at least 5 seconds. Otherwise the function switches off automatically after 3 minutes.

### Button-less key (Key Tag)

The key tag works in the same way as the regular key as regards keyless starting and locking and unlocking.

The key is waterproof to a depth of approx. 10 metres (30 feet) for up to 60 minutes. It has no detachable key blade and the battery cannot be replaced.

### Interference

Key functions for keyless starting and keyless locking and unlocking can be disrupted by electromagnetic fields and screening.

If there is still interference - use the key's detachable key blade to unlock and then place the key in the backup reader in the cup holder to disarm the car and allow the car to be started.

### Related information

- Replacing the battery in the key (p. 213)
- Detachable key blade (p. 217)
- User profiles (p. 118)
- Immobiliser (p. 220)
- Key range (p. 212)
- Connect key to user profile (p. 122)

## WARNING

If anyone is left in the car, make sure the power windows are de-energised by always taking the key with you when you leave the car.

## NOTE

- Be aware of the risk of locking the key in the car.
  - A key left in the car will be deactivated when the car is locked and the alarm is armed using another valid key. The "Double lock" function is also deactivated. The key left behind is reactivated when the car is unlocked.

# Locking and unlocking with the key

## NOTE

- Avoid storing the key close to metal objects or electronic apparatus, e.g. phones, tablets, laptops or chargers - preferably no closer than 10-15 cm (4-6 inches).
- When the key is placed in the cup holder, make sure that no other car keys, metal objects or electronic apparatus (e.g. phones, tablets, laptops or chargers) are in the cup holder. Several car keys close to each other in the cup holder can cause interference with each other.

The buttons on the key can be used to lock and unlock the doors and the tailgate simultaneously.



### Locking with the key

- Press the key  button to lock the car.

All doors must be locked to be able to activate the lock sequence. If any of the doors or the tailgate is open, these will only be locked and alarmed when they are closed. The alarm's movement detectors are activated when the doors and the tailgate are closed and locked.

### Locking when the tailgate is open

### Unlocking with the key

- Press the key  button to unlock the car.

### Automatic relocking

If none of the doors or the tailgate is opened within 2 minutes of unlocking, they are locked automatically. This function prevents the car from being left unlocked unintentionally.

# Unlocking the tailgate with a key

## When the key does not work

If it is not possible to lock or unlock with the key, the battery may be discharged - in which case, lock or unlock the driver's door with the detachable key blade.

## Related information

- Unlocking the tailgate with a key (p. 211)
- Key (p. 208)
- Replacing the battery in the key (p. 213)
- Locking and unlocking with the detachable key blade (p. 218)

## NOTE

- Be aware of the risk of locking the key in the car.
- A key left in the car will be deactivated when the car is locked and the alarm is armed using another valid key. The "Double lock" function is also deactivated. The key left behind is reactivated when the car is unlocked.
- If the car has been locked while the tailgate is open, be careful not to leave the key in the cargo area when the tailgate is closed and the car is completely locked<sup>30</sup>.
- Always try moving closer to the car and making another unlock attempt.

It is possible to unlock just the tailgate using a button on the key.

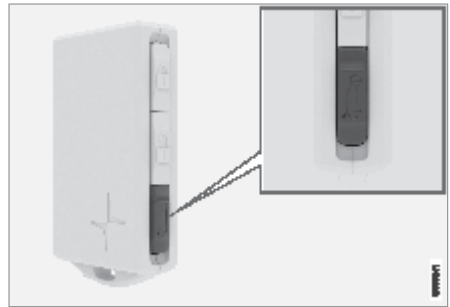

- Brief press on the  button on the key.
  - > The tailgate is unlocked but remains closed.

The side doors are still locked and the alarm is armed. The lock and alarm indicator on the instrument panel extinguishes in order to show that the entire car is not locked.

If the tailgate is not opened within approximately 2 minutes then it is relocked and the alarm is re-armed.

- Long press on the  button on the key.
  - > The tailgate is unlocked and opened, while the side doors remain locked and their alarm functions armed.

## Related information



- Key (p. 208)

<sup>30</sup> If the key is detected inside the car, the tailgate will not lock when it is closed.

# Key range

In order for the key to work properly it needs to be within a certain distance from the car.

## For manual use

The key's functions for e.g. locking/unlocking that are activated by pressing on  or  have a range that extends approx. 20 metres (65 feet) from the car.

If the car does not verify a button being pressed - move closer and try again.

## For keyless use

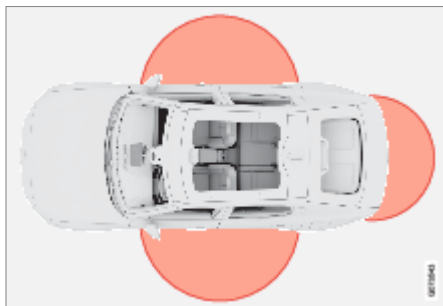

The marked area in the illustration shows areas covered by the system's antennas.

For keyless use, a key must be within a semicircular area with a radius of approx. 1.5 metres (5 feet) on both long sides and approx. 1 metre (3 feet) from the tailgate.

## If the key is removed from the car



If the key is removed from the car when the engine is running, the warning message Car key not found See Manual is shown in the driver display and an acoustic reminder sounds when the last door is closed.

The message extinguishes when the key is returned to the car, followed by a press of the right-hand keypad's O button, or when the last door is closed.

## Related information

- Key (p. 208)
- Antenna locations for the start and lock systems (p. 205)
- Keyless locking and unlocking (p. 198)

## NOTE

The key functions may be disrupted by surrounding radio waves, buildings, topographical conditions, etc. The car can always be locked or unlocked using the key blade.

# Replacing the battery in the key

The battery in the key needs to be replaced when it has become discharged.





The battery for the key should be replaced if

- the information symbol illuminates and the message Car key battery low See Manual is shown in the driver display
- the locks repeatedly do not react to signals from the key within 20 metres (65 feet) of the car.

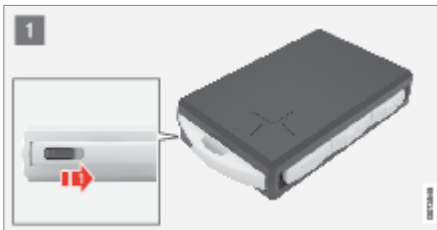

The battery in the Key Tag cannot be replaced – contact Polestar Support.

## Opening the key and changing the battery

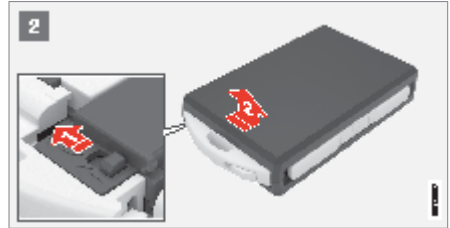

- 1  Hold the key with the front visible and the Polestar logo facing the right way – slide the button by the key ring to the right. Slide the front side's shell a few millimetres upwards.  
 The shell will then come free and can be lifted off the key.



- 2  Turn the key, move the button to the side and slide the back shell a few millimetres upwards.  
 The shell will then come free and can be lifted off the key.

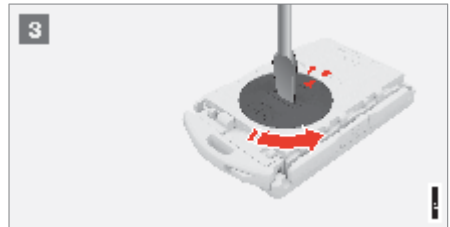

- 3 Use a screwdriver or similar to turn the battery cover anticlockwise until the markings meet at the OPEN text.  
Carefully lift away the battery cover by pressing e.g. a fingernail down into the recess.  
Then prize the battery cover upwards.



4 The battery (+) side is facing upwards. Then carefully prize loose the battery as illustrated.

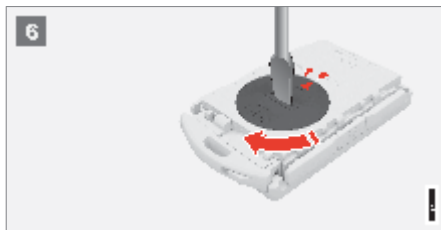

6 Refit the battery cover and turn it clockwise until the marking aligns with the CLOSE text.



5 Install a new battery with the (+) side up. Avoid touching the key's battery contacts with your fingers.

- Place the battery in the holder with the edge down. Then slide the battery forwards so that it fastens under the two plastic catches.
- Press the battery down so that it fastens under the upper black plastic catch.

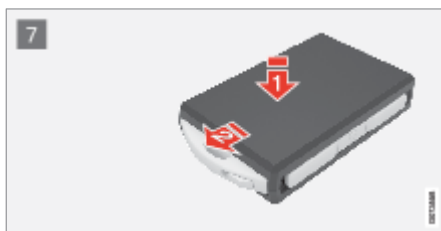

7

- Reposition the rear side's shell and press it down until a clicking sound can be heard.
- Then slide the shell back.
- > A further click will indicate that the shell is properly positioned and securely attached.

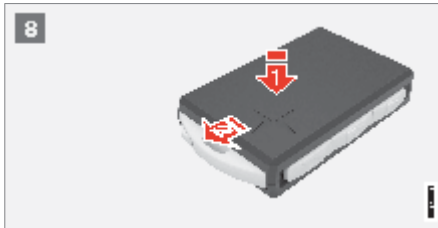

- 8** Turn the key over and refit the front side's shell by pressing it down until a clicking sound can be heard.
- Then slide the shell back.
- > A further click will indicate that the shell is securely attached.

#### Related information

- Key (p. 208)

## WARNING

- Check that the battery is positioned correctly, with the correct polarity. If the key is not to be used for any length of time, remove the battery to prevent it leaking and causing damage. Batteries that are leaking or damaged may cause chemical burns on contact with the skin, so wear protective gloves when handling damaged batteries.
- Keep batteries out of the reach of children.
- Do not leave batteries lying around in places where they could be swallowed by children or pets.
- Batteries must not be dismantled, short-circuited or thrown into naked flames.
- Do not charge non-rechargeable batteries as this may cause an explosion.

Check that there is no damage to the key before use. If damage is detected – being unable to close the battery cover properly, for example – the product should not be used. Keep defective products out of the reach of children.

## WARNING

- California Proposition 65

When you use or perform service or maintenance on a passenger vehicle, you may be exposed to chemicals, including exhaust gases, carbon monoxide, phthalates and lead, which are known in the State of California to cause cancer, birth defects or other reproductive harm. Minimise the exposure by avoiding the inhalation of exhaust gases, not running at idling speed more than necessary, servicing the vehicle in a well-ventilated area and wearing gloves or washing your hands frequently when you service the vehicle. More information is available at [www.P65Warnings.ca.gov/passenger-vehicle](http://www.P65Warnings.ca.gov/passenger-vehicle).

## NOTE

- All batteries have a limited service life and must eventually be replaced. The service life of the battery varies depending on how often the vehicle/key is used.
- Always try moving closer to the car and making another unlock attempt.
- Use batteries with the designation CR2032, 3 V.
- Polestar recommends that the batteries to be used in the key fulfil UN Manual of Test and Criteria, Part III, subsection 38.3. Contact Polestar Support for replacement of factory-fitted batteries.

## IMPORTANT

- Contact Polestar Support if your Key Tag battery is exhausted. The key has to be deleted from the car as it can still be used for backup starting.
- Avoid touching new batteries and their contact surfaces with your fingers as this may impair their function.
- Make sure that exhausted batteries are disposed of in a manner which is kind to the environment.



## Ordering additional keys

The car is supplied with two keys and a Key Tag. Additional keys can be ordered.

A total of twelve keys can be programmed and used for one single car. If additional keys are ordered, additional user profiles are added – one per new key. This also applies for the key tag.

### If you lose a key

If you lose a key then a new one can be ordered – contact Polestar Support. The remaining keys must be taken to the workshop. The code of the missing key must be erased from the system as a theft prevention measure.

The current number of keys registered to the car can be checked via  in the centre display.

### Related information

- Key (p. 208)

## Detachable key blade

The key contains a detachable key blade of metal with which a number of functions can be activated and some operations carried out.

Contact Polestar Support when ordering new key blades.

### The key blade's application areas

Using the key's detachable key blade:

- the driver's door can be opened manually if central locking cannot be activated with the standard key
- the doors are emergency-locked

### Detaching the key blade

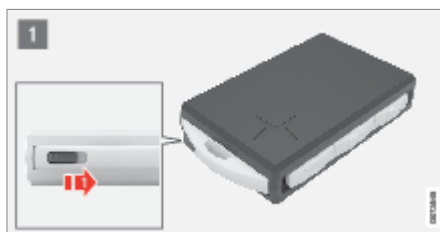

**1**  Hold the key with the front visible and the Polestar logo facing the right way – slide the button at bottom edge by the key ring to the right. Guide the front side's shell a few millimetres upwards.

 The shell will then come free and can be lifted off the key.

# Locking and unlocking with the detachable key blade



2 → Detach the key blade by angling it up.

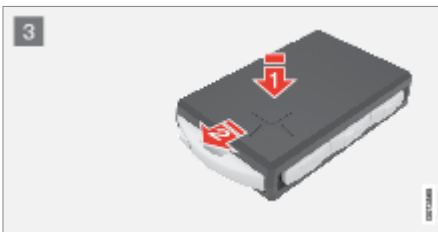

3 Return the key blade to its intended position in the key after use.

→ Refit the shell by pressing it downward until a clicking sound is heard.

↔ Then slide the shell back.

> A further click will indicate that the shell is securely attached.

## Related information

- Locking and unlocking with the detachable key blade (p. 218)
- Key (p. 208)

The removable key blade can be used to unlock the car from the outside – if there is no power to your car or the key battery is discharged, for example.

## Unlocking

The alarm is triggered when the car is unlocked with the key blade.



→ Pull out the front door handle on the left-hand side to its end position so that the lock cylinder become visible.

↔ Insert the key in the lock cylinder.

↻ Turn clockwise 45 degrees so that the key blade is pointing straight back.

↻ Turn the key back 45 degrees to its starting position. Remove the key from the lock cylinder and release the handle so that the rear section of the handle is resting against the car again.

5. Pull out the handle.

> The door opens.

## Locking

The doors have a lock switch at the end which must be depressed using the key blade – these are then mechanically locked/blocked to prevent them being opened from outside.

The doors can still be opened from the inside.

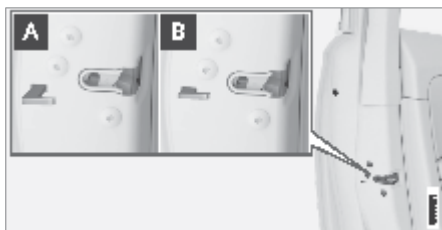

*Manual locking of the door.*

- Remove the detachable key blade from the key. Insert the key blade in the hole for lock reset and press the key in until it bottoms, approx. 12 mm (0.5 inches).

- A** The door can be opened from both the outside and the inside.
- B** The door is blocked against opening from the outside. To return to position A, the inner door handle must be opened.

#### Related information

- Detachable key blade (p. 217)
- Activating and deactivating alarms (p. 238)
- Replacing the battery in the key (p. 213)
- Key (p. 208)

#### NOTE

- A door's lock reset only locks that particular door - not all doors simultaneously.
- A manually locked rear door with the child lock activated cannot be opened from either the inside or the outside. The door can then only be unlocked using the buttons on the key, the central locking button or Polestar Connect.

#### NOTE

- When the door is unlocked using the key blade and is then opened, the alarm is triggered.

# Immobiliser

The electronic immobiliser is a theft protection system that prevents an unauthorised person from starting the car.

The car can only be started with the correct key.

The following error message in the driver display is related to the electronic immobiliser:

Symbol	Message	Specification
	Car key not found See Manual	Error reading the key during starting - place the key on the key symbol in the cup holder and try again.

## Related information

- Key (p. 208)
- Ordering additional keys (p. 217)

# Type approval for the key system

Type approval for the car's key system can be seen in the following tables.

For detailed information on type approval, go to [polestar.com](http://polestar.com)

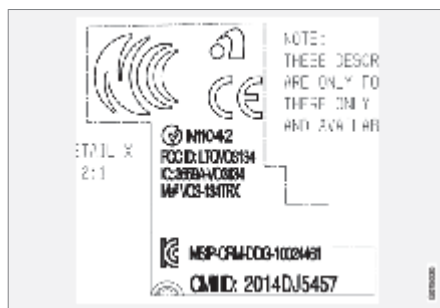

Lock system keyless start (Passive Start) and keyless locking/unlocking (Passive Entry)





*CEM label for the key system. For supplementary type approval numbers, see following tables.*



Country/ Area	Type approval	
Argentina	CNC ID: C-14771	
Brazil	MT-3245/2015	 <p>ANATEL 0589-15-6830</p> <p>(01) 0 7897843840961</p>

Country/ Area	Type approval	
Europe	<p>APTIV Services Deutschland GmbH, hereby declares that this VO3-134TRX conforms to the essential property requirements and other relevant provisions contained in directive 2014/53/EU.</p> <p>APTIV Services Deutschland GmbH, hereby declares that this CV1-134TRX conforms to the essential property requirements and other relevant provisions contained in directive 2014/53/EU.</p> <p>The full text of the EU declaration of conformity can be found at <a href="http://polestar.com">polestar.com</a></p> <p>Manufacturer: APTIV Services Deutschland GmbH, Am Technologiepark 1, D-42119 Wuppertal, Germany</p>	
The United Arab Emirates	<p>ER37847/15</p> <p>DA0062437/11</p>	
Indonesia	Nomor: 38301/SDPPI/2015	
Jordan	TRC/LPD/2014/250	
Malaysia	RDBV/25A/1118/S(18-4228), RDBV/26A/1118/S(18-4229)	
Mexico	IFETEL: RLVDEVO15-0396	



Country/ Area	Type approval	
Namibia	TA-2016-02	
Russia		
Serbia	P1614120100	
South Africa	TA-2014-1868	



## Key

Country/ Area	Type approval	
Argentina	CNC ID: H-23694	
Brazil	<p>Anatel: 06768-19-06643</p> <p>Modelo: HUF8423MS</p> <p>Este equipamento opera em caráter secundário isto é não tem direito a proteção contra interferência prejudicial, mesmo de estações do mesmo tipo, e não pode causar interferência a sistemas operando em caráter primário.</p>	
<p>CU (Customs Union)</p> <p>Kazakhstan, Russia</p>		

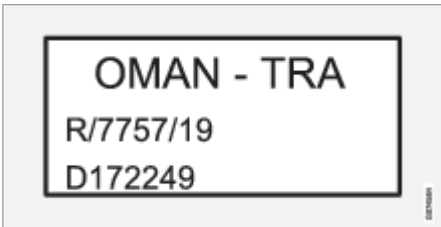

Country/ Area	Type approval	
Europe	<p>Huf Hülsbeck &amp; Fürst GmbH &amp; Co. KG hereby declares that this type of radio equipment HUF8423MS conforms to directive 2014/53/EU.</p> <p>The full text of the EU declaration of conformity can be found at polestar.com</p> <p>Wavelength: 433.92 MHz</p> <p>Maximum radiated transmission power: 10 mW</p> <p>Manufacturer: Huf Hülsbeck &amp; Fürst GmbH &amp; Co. KG, Steeger Str. 17, 42551 Velbert, Germany</p>	
Philippines	ESD-1919938C	 <p>The logo for the National Telecommunications Commission (NTC) of the Philippines. It features a circular emblem with the text 'NATIONAL TELECOMMUNICATIONS COMMISSION' around the perimeter. To the right of the emblem, the letters 'NTC' are printed in a large, bold, sans-serif font. Below the emblem and 'NTC', the text 'Type Approved' and 'No.: ESD-1919938C' is displayed in a smaller font. A small vertical 'ESD19938C' label is visible on the right side of the logo area.</p>
The United Arab Emirates		 <p>The logo for the Telecommunications Regulatory Authority (TRA) of the United Arab Emirates. It consists of a rectangular box with a double-line border. Inside the box, the text 'TRA REGISTERED No: ER72465/19 DEALER No: DA36976/14' is centered and printed in a bold, sans-serif font. A small vertical 'ESD19938C' label is visible on the right side of the box.</p>
Ghana	NCA Approved: ZRO-M8-7E3-138	



Country/ Area	Type approval	
Indone- sia <sup>A</sup>	Sertifikat Nomor: 65073/SDPPI/ 2019  PLG ID: 8093	
Morocco	AGREE PAR L'ANRT MAROC  Numéro d'agrément: MR 20402 ANRT 2019  Date d'agrément: 10/07/2019	
Moldova		
Nigeria	Connection and use of this communication equipment is permitted by the Nigerian Communications Commission	
Oman		



Country/ Area	Type approval	
Paraguay	HUF8423MS	
Serbia	I00519	
Singapore	Complies with IMDA Standards DA103787	
South Africa	TA-2019/772	



Country/ Area	Type approval	
Taiwan	<p>本產品符合低功率電波輻射性電機管理辦法 第十二條、第十四條等條文規定 .1 經型式認證合格之低功率射頻電機，非經許可，公司、商號或使用者均不得擅自變更頻率、加大功率或變更原設計之特性及功能 .2 低功率射頻電機之使用不得影響飛航安全及干擾合法通信；經發現有干擾。現象時，應立即停用，並改善至無干擾時方得繼續使用 前項合法通信，指依電信法規定作業之無線電通信 低功率射頻電機須忍受合法通信或工業、科學及醫療用電波輻射性電機設備之干擾</p>	
Ukraine	<p>.Справжнім Huf Hülsbeck &amp; Fürst GmbH &amp; Co KG заявляє, що тип радіобладнання відповідає Технічному[HUF8423MS] регламенту радіобладнання; повний текст -декларації про відповідність доступний на веб :сайті за такою адресою</p> <p>For detailed information on type approval, go to polestar.com.</p> <p>Робоча частота: 433,92 ГГц</p>	



Country/ Area	Type approval	
Vietnam		 <p>The logo for Vietnam Type Approval (ICT) features a stylized 'Q' shape with a mouse cursor arrow pointing to it. To the left of the 'Q' is the word 'Company' and the number '0214190619A/DTA2'. Below the 'Q' is the text 'ICT'. A small 'DENVER' logo is visible in the bottom right corner of the logo area.</p>
Belarus		 <p>The logo for Belarus Type Approval (TP BY) consists of the letters 'TP' inside a rounded square, with 'BY' written below it.</p>
Zambia		 <p>The logo for Zambia Type Approval (ZICTA) features a globe icon to the left of the word 'ZICTA'. Below 'ZICTA' is the reference number 'ZMB/ZICTA/TA/2019/7/105'. A small 'DENVER' logo is visible in the bottom right corner of the logo area.</p>



A Only applies to Indonesia.

Button-less key (Key Tag)

Country/ Area	Type approval	
Argentina	CNC ID: H-23695	
Brazil	<p>Anatel: 06950-19-06643</p> <p>Modelo: HUF8432MS</p> <p>Este equipo opera em caráter secundário isto é não tem direito a proteção contra interferência prejudicial, mesmo de estações do mesmo tipo, e não pode causar interferência a sistemas operando em caráter primário.</p>	
<p>CU (Customs Union)</p> <p>Kazakhstan, Russia</p>		



Country/ Area	Type approval	
Europe	<p>Huf Hülsbeck &amp; Fürst GmbH &amp; Co. KG hereby declares that this type of radio equipment HUF8432MS conforms to directive 2014/53/EU.</p> <p>The full text of the EU declaration of conformity can be found at polestar.com.</p> <p>Wavelength: 433.92 MHz</p> <p>Maximum radiated transmission power: 10 mW</p> <p>Manufacturer: Huf Hülsbeck &amp; Fürst GmbH &amp; Co. KG, Steeger Str. 17, 42551 Velbert, Germany</p>	
Philip- pines	ESD-1919939C	 <p>The logo for the National Telecommunications Commission (NTC) of the Philippines. It features a circular emblem with the text 'NATIONAL TELECOMMUNICATIONS COMMISSION' around the perimeter. To the right of the emblem, the letters 'NTC' are printed in a large, bold, sans-serif font. Below the emblem and 'NTC', the text 'Type Approved' and 'No.: ESD-1919939C' is displayed in a smaller font. A small vertical 'DENVER' logo is visible on the right side of the box.</p>
The Uni- ted Arab Emirates		 <p>The logo for the Telecommunications Regulatory Authority (TRA) of the United Arab Emirates. It consists of a rectangular box with a double border. Inside the box, the text 'TRA' is at the top, followed by 'REGISTERED No: ER72465/19' and 'DEALER No: DA36976/14' on separate lines. A small vertical 'DENVER' logo is visible on the right side of the box.</p>
Ghana	NCA Approved: ZRO-M8-7E3-139	

Country/ Area	Type approval	
Indone- sia <sup>A</sup>	Sertifikat Nomor: 65072/SDPPI/ 2019  PLG ID: 8093	
Morocco	AGREE PAR L'ANRT MAROC  Numéro d'agrément: MR 20403 ANRT 2019  Date d'agrément: 10/07/2019	
Moldova		
Nigeria	Connection and use of this com- munications equipment is permit- ted by the Nigerian Communica- tions Commission	
Oman		

Country/ Area	Type approval	
Paraguay	HUF8432MS	
Serbia	I00519	
Singapore	Complies with IMDA Standards DA103787	
South Africa	TA-2019-773	



Country/ Area	Type approval	
Taiwan	<p>本產品符合低功率電波輻射性電機管理辦法 第十二條、第十四條等條文規定 .1 經型式認證合格之低功率射頻電機，非經許可，公司、商號或使用者均不得擅自變更頻率、加大功率或變更原設計之特性及功能 .2 低功率射頻電機之使用不得影響飛航安全及干擾合法通信；經發現有干擾現象時，應立即停用，並改善至無干擾時方得繼續使用 前項合法通信，指依電信法規定作業之無線電通信 低功率射頻電機須忍受合法通信或工業、科學及醫療用電波輻射性電機設備之干擾</p>	
Ukraine	<p>.Справжнім Huf Hülsbeck &amp; Fürst GmbH &amp; Co KG заявляє, що тип радіобладнання відповідає Технічному[HUF8432MS] регламенту радіобладнання; повний текст -декларації про відповідність доступний на веб :сайті за такою адресою</p> <p>For detailed information on type approval, go to polestar.com.</p> <p>Робоча частота: 433,92 ГГц</p>	

Country/ Area	Type approval	
Vietnam		
Belarus		
Zambia		

A Only applies to Indonesia.

#### Related information

- Key (p.208)

# Lock confirmation

The car indicates with hazard warning flashers when the car is locked or unlocked.

## Exterior indication

### Locking

- The car's hazard warning flashers indicate locking by flashing and retracting the door mirrors.

### Unlocking

- The car's hazard warning flashers indicate unlocking by two flashes and extending the door mirrors.

All doors, the tailgate and bonnet must be closed to indicate the car is locked.

## Lock and alarm indicator on the instrument panel



The lock and alarm indicator shows the status of the locking system:

- A long flash indicates locking.
- Short flashes indicate that the car is locked.
- Rapid flashes after disarming the alarm indicate that the alarm has been triggered.

## Front door



An illuminated indicator lamp in the lock button of either front door indicates that all doors are locked. If any door is opened, the lamp will extinguish in both doors.

## Rear door



An illuminated indicator lamp in the lock button for one of the doors indicates that the door in question is locked. If any door is unlocked, its lamp will extinguish while the others will continue to illuminate.

# Double lock

## Other indication

The home safe lighting and welcome light functions can also be activated when locking and unlocking.

## Related information

- Locking and unlocking settings (p. 200)
- Locking and unlocking (p. 198)
- Welcome light and farewell light (p. 142)
- Using home safe lighting (p. 141)

Double lock means that all opening handles are released mechanically when locking from the outside, which makes it impossible to open the doors from the inside.

Double lock is activated when locking with a key or with keyless locking and takes place with a delay of approx. 10 seconds after the doors have locked. If a door is opened within the delay time then the sequence is interrupted and the alarm is deactivated.

The car can only be unlocked with a key, keyless unlocking or the Polestar Connect when double lock is activated.

The driver's door can also be unlocked with the detachable key blade. If the car is unlocked with the detachable key blade, the alarm will be triggered.

## Related information

- Alarm (p. 237)

## WARNING

Do not lock the car from the outside while there is anyone left in the car.

# Alarm

The alarm provides audible and visual warnings if anyone enters the car without a valid key.



## Alarm indicator

A red LED on the instrument panel indicates the alarm system's status:

- LED not lit – alarm not armed.
- The LED flashes once every other second – alarm is armed.
- The LED flashes quickly after the car has been unlocked – the alarm has been triggered.

When armed, the alarm is triggered if:

- a door, the bonnet or the tailgate is opened
- a movement is detected in the passenger compartment
- the car is lifted or towed away
- the siren is disconnected.

## Alarm signals

When the alarm has been triggered, the following happens:

- A siren sounds for 30 seconds or until the alarm is switched off.

- Hazard warning flashers flash for 5 minutes or until the alarm is switched off.

If the cause of alarm activation is not rectified, the alarm cycle is repeated up to 10 times<sup>31</sup>.

## Movement and tilt sensors

Movement and tilt detectors react to movements inside the car<sup>32</sup> e.g. if the window is broken or if anyone tries to tow the car away.

To avoid triggering the alarm unintentionally:

- Close all windows when leaving the car.
- If the climate control is used – aim the airflow so that it does not point upwards in the passenger compartment.

It is also possible to reduce the alarm level in the centre display.

## Symbols and messages

Symbol	Message	Specification
	Alarm system failure Service required	A fault has arisen in the alarm system, contact Polestar Support.

## Related information

- Activating and deactivating alarms (p. 238)
- Reduced alarm level (p. 239)

<sup>31</sup> Applies to certain markets.

<sup>32</sup> Airflows from the climate control are also registered.

# Activating and deactivating alarms

## NOTE

Do not attempt to repair or alter components in the alarm system yourself. Any such attempts may affect the terms of the insurance.

The alarm is activated when the car is locked, and is deactivated when the car is unlocked. It is also possible to deactivate the alarm without a working key.

### Deactivate the alarm without a functioning key

The car can be unlocked and disarmed even if the key does not work, e.g. if the key's battery is dead.

1. Open the driver's door with the detachable key blade.
  - > The alarm is triggered.



2. Place the key on the key symbol in the backup reader in the tunnel console's cup holder.
  - > The alarm is deactivated.

### Related information

- Alarm (p. 237)
- Locking and unlocking with the detachable key blade (p. 218)

# Reduced alarm level

Reduce the alarm level, e.g. when travelling on a car ferry.

The alarm's movement and tilt detectors react to movements inside the car. These detectors are switched off in reduced alarm level.

## Activating reduced alarm level

1. Tap on  in the centre display.
2. Press More.
3. Select Locking.
4. Activate Reduced guard.

If the car is unlocked and then locked again, the reduced alarm level must be reactivated.

## Related information

- Locking and unlocking settings (p. 200)
- Alarm (p. 237)

### NOTE

The electrical sockets are active for a maximum of 10 minutes after locking with reduced alarm level.





## Section 10

—

## Driver support

# Driving support systems

The car is equipped with different driver support systems which can assist the driver in different situations, either actively or passively.

For example, the systems can help the driver to:

- maintain a set speed
- maintain a certain time interval to the vehicle ahead
- prevent a collision by giving a warning to the driver and braking the car
- help the driver to park.

Some of the systems are fitted as standard while others are options – which alternative applies is market dependent.

## Related information

- Speed-dependent steering force (p. 243)
- Electronic stability control (p. 244)
- Road Sign Information (p. 248)
- Cruise control functions (p. 254)
- Overtaking Assistance\* (p. 276)
- Lane assistance (p. 284)
- Assistance at risk of collision (p. 292)
- Rear Collision Warning\* (p. 305)
- BLIS (p. 306)
- Driver Alert Control (p. 310)
- Warning and auto-brake while reversing\* (p. 312)
- Park Assist (p. 315)
- Park assist camera (p. 321)
- Radar unit (p. 329)
- Camera unit (p. 341)

## WARNING

The functions are supplementary aids - they cannot handle all situations in all conditions.

The driver always bears responsibility that the vehicle is driven safely and that applicable road traffic rules and regulations are followed.

# Speed-dependent steering force

Speed related power steering causes the steering wheel force to increase with the speed of the car so as to be able to give the driver enhanced sensitivity.

## Reduced power

In rare situations, the power steering may need to work at reduced power, and turning the steering wheel may then seem slightly heavier. This may occur when the power steering becomes too hot and then needs temporary cooling. It may also occur if the power supply is disrupted.



In the event of reduced power, the message Power steering assistance Temporarily reduced is shown, as well as this symbol in the driver display.

While the power steering is working at reduced power, the driver support functions and steering assistance systems are not available.

## Change the steering force level

1. Tap on  in the centre display.
2. Press Drive.
3. Choose the preferred setting for steering.

Steering wheel resistance selection can only be accessed if the car is stationary or is moving at low speed and in a straight line.

## Related information

- Driving support systems (p. 242)

## WARNING

If the temperature increases too much, the servo may be forced to switch off completely. In such a situation, the driver display shows the Stop safely Power steering failure message, combined with a symbol.

# Electronic stability control

Electronic Stability Control (ESC<sup>33</sup>) helps the driver to avoid skidding and improves the car's traction.



The driver display shows this symbol when the system is engaged.

Braking from the system may be heard as a pulsing sound, and the car may accelerate

more slowly than expected when applying the throttle.

The system consists of the following subfunctions:

- Stability function<sup>34</sup>
- Spin control and traction control system
- Engine Drag Control
- Trailer Stability Assist

## Stability function<sup>34</sup>

The function checks the driving and brake force of the wheels individually in order to stabilise the car.

## Spin control and traction control system

The function is active at low speed and brakes the drive wheels that spin so that additional traction shall be transferred to the drive wheels that are not spinning.

The function can also prevent the driving wheels from spinning against the road surface during acceleration.

## Engine Drag Control

Engine Drag Control (EDC<sup>35</sup>) can prevent involuntary wheel locking, e.g. after shifting down or engine braking when driving in low gear on slippery road surfaces.

Involuntary wheel locking while driving can, amongst other things, impair the driver's ability to steer the car.

## Trailer Stability Assist<sup>36</sup>

The function of Trailer Stability Assist (TSA<sup>37</sup>) is to stabilise a car with a trailer connected in situations where the combination has begun to fishtail.

## Related information

- Driving support systems (p. 242)
- Activating and deactivating sport mode for electronic stability control (p. 246)
- Symbols and messages for electronic stability control (p. 246)

<sup>33</sup> Electronic Stability Control

<sup>34</sup> Also known as Active Yaw Control.

<sup>35</sup> Engine Drag Control

<sup>36</sup> Trailer Stability Assist is included when a Polestar original towbar is installed.

<sup>37</sup> Trailer Stability Assist

# Electronic Stability Control in sport mode

## WARNING

- The function is supplementary driver support intended to facilitate driving and make it safer – it cannot handle all situations in all traffic, weather and road conditions.
- The driver is advised to read all sections in the Manual that relate to this function to learn about factors such as its limitations and what the driver should be aware of before using the system.
- Driver support functions are not a substitute for the driver's attention and judgement. The driver is always responsible for ensuring the car is driven in a safe manner, at the appropriate speed, with an appropriate distance to other vehicles, and in accordance with current traffic rules and regulations.

## NOTE

Trailer Stability Assist (TSA<sup>38</sup>) is disabled when ESC sport mode is selected.

The stability system (ESC<sup>39</sup>) is always activated – it cannot be switched off. However, the driver can select ECS Sport mode, which allows for a more active driving experience.

With Sport mode selected, interventions from the system are reduced and the car is allowed to skid more and greater control than normal is thus transferred to the driver.

When Sport mode is selected, the function can be considered as deactivated, despite the function continuing to help the driver in many cases.

Sport mode also provides more traction even if the car has become bogged down or is driving on a loose surface, such as in sand or deep snow.

## Related information

- Electronic stability control (p. 244)
- Activating and deactivating sport mode for electronic stability control (p. 246)

## NOTE

Trailer Stability Assist (TSA<sup>40</sup>) is disabled when ESC sport mode is selected.

## Activating and deactivating sport mode for electronic stability control

The stability system (ESC<sup>41</sup>) is always activated – it cannot be switched off. However, the driver can select sport mode, which allows for a more active driving experience.



The driver display indicates activated Sport mode by displaying this symbol with a constant glow until the function is deactivated or the engine is switched off. The next time the engine is started, the system is

back in its normal mode again.

1. Tap on  in the centre display.
2. Press Drive.
3. Select to activate or deactivate ECS.

Sport mode cannot be selected when one of the following functions is activated:





- Speed limiter
- Cruise control
- Adaptive cruise control
- Pilot Assist

### Related information

- Electronic Stability Control in sport mode (p. 245)
- Electronic stability control (p. 244)

## Symbols and messages for electronic stability control

A number of symbols and messages regarding electronic stability control (ESC<sup>42</sup>) can be shown on the driver display. Here are some examples.

Symbol	Message	Specification
	Constant glow for approx. 2 seconds	System check when the engine is started.
	Flashing light	The system is being activated.
	Constant glow	Sport mode is selected.  NOTE: The system is not deactivated in this mode – it is partly reduced.
	ESC Temporarily off	The system has been temporarily reduced due to excessive brake temperature - the function is reactivated automatically when the brakes have cooled.
	ESC Service required	The system is disengaged. Stop the car in a safe place, switch off the engine and start it again.

A text message can be cleared by briefly pressing the  button, located in the centre of the steering wheel's right-hand keypad.

If you still see a message, please contact Polestar Support.

#### Related information

- Electronic stability control (p. 244)
- Polestar Support (p. 9)

# Road Sign Information

The Road Sign Information function (RSI<sup>43</sup>) can help the driver to observe speed-related road signs and certain prohibition signs.

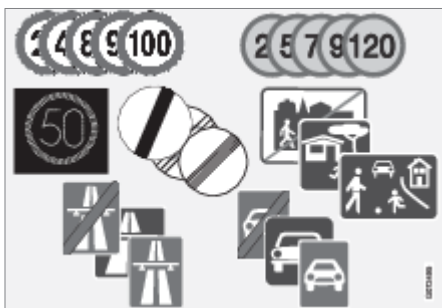

Examples of readable signs<sup>44</sup>.

RSI can provide information about such things as current speed, when overtaking is prohibited or when the direction of travel is one-way.

If the car passes a speed limit sign, it will be shown in the driver display.

Road sign information (RSI<sup>45</sup>) also includes sub-functions that can warn the driver if a speed limit has been exceeded or in connection with speed cameras.

## Related information

- Driving support systems (p. 242)
- Activating and deactivating road sign information (p. 249)
- Display mode for road sign information (p. 250)
- Warning for speed limitation and speed camera from road sign information (p. 252)
- Limitations of Road Sign Information (p. 254)

## WARNING

- The function is supplementary driver support intended to facilitate driving and make it safer – it cannot handle all situations in all traffic, weather and road conditions.
- The driver is advised to read all sections in the Manual that relate to this function to learn about factors such as its limitations and what the driver should be aware of before using the system.
- Driver support functions are not a substitute for the driver's attention and judgement. The driver is always responsible for ensuring the car is driven in a safe manner, at the appropriate speed, with an appropriate distance to other vehicles, and in accordance with current traffic rules and regulations.

## NOTE

In certain markets, the Road Sign Information function is only available in combination with map data.

<sup>43</sup> Road Sign Information

<sup>44</sup> Road signs are market-dependent - illustrations in these instructions only show a few examples.

<sup>45</sup> Road Sign Information



# Activating and deactivating road sign information

The Road Sign Information function (RSI<sup>46</sup>) is optional – the driver can choose to activate or deactivate this function.



Activate or deactivate the function using this button in the centre display under Assist.

- Button indication on – the function is activated.
- Extinguished button indication – the function is deactivated.

## Related information

- Road Sign Information (p. 248)
- Automatic speed limiter (p. 260)
- Limitations of Road Sign Information (p. 254)

## NOTE

- If the automatic speed limiter function is activated, road sign information is shown in the driver display even if the Road Sign Information function is not activated.
- To remove road sign information from the driver display, you must deactivate both the automatic speed limiter and Road Sign Information.
- When the automatic speed limiter function is activated but Road Sign Information is deactivated, no warnings are given from Road Sign Information. Road Sign Information must also be activated in order to receive warnings.

# Display mode for road sign information

The Road Sign Information function (RSI<sup>47</sup>) shows road signs in different ways depending on the sign and the situation.



Example<sup>48</sup> of detected speed information.

When the function detects a road sign with an imposed speed limit the driver display shows the sign as a symbol.

Since speed-related information is obtained from map data, the driver display can show or change information on the speed limit without having passed a speed-related sign.



An additional sign, such as "no overtaking", may be shown together with the speed limit symbol.



If the driver enters a road marked with this no-entry sign on each side, or on one side with confirmation from map data, the symbol for this sign flashes on and off in the driver display to warn the driver. The driver can also be given an acoustic warning

when driving towards a no-entry road if the function for acoustic warning for road signs is activated.<sup>49</sup>

## Speed limit or end of motorway

When the function detects an "indirect speed limit sign" stating the end of the current speed limit – e.g. at the end of a motorway – a symbol may be shown with the corresponding road sign in the driver display.

Normal speed limit signs are displayed in normal cases even if an indirect speed limit sign has been passed – indirect speed limit signs are only shown if map data has no information on the speed limit for the section of road in question.

Example of indirect speed limit sign:

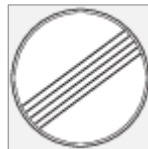

End of all restrictions.



End of motorway.

The driver display symbol extinguishes after 10-30 seconds and remains so until the next speed related sign is passed.

## Changed speed limit

When passing a direct speed limit sign when a speed limit changes a symbol with the corres-

<sup>47</sup> Road Sign Information

<sup>48</sup> Road signs are market-dependent - the illustrations in these instructions only show examples.

<sup>49</sup> Applies to certain markets.

ponding road sign appears in the driver's display.



Example of direct speed limit sign.

The driver display symbol extinguishes after about 5 minutes until the next speed-related sign is passed.

Speed limit signs are shown in the driver display when map data contains information on the speed limit for the road section in question, even if no direct sign has been passed. If there is no information in map data, the sign goes off after approx. 3 minutes after the last passing of a speed limit sign.

#### Additional signs

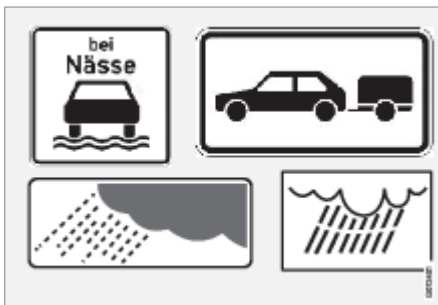

*Examples of additional signs.*

Sometimes different speed limits are signed for the same road - an additional sign then indicates the circumstances under which the different speeds apply. The road section may be particularly susceptible to accidents in rain and/or fog, for example.

An additional sign relating to rain is only shown if the windscreen wipers are in use.

If a trailer is connected to the car's electrical system and you pass a speed sign with the additional sign "trailer", the indicated speed will appear on the driver display.

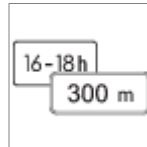

Some speed limits only apply after a certain distance or at a certain time of day. The driver's attention is drawn to this fact by means of a symbol for an additional sign below the speed symbol.

#### Sign for "School" and "Children at play"



If a warning sign for "School" or "Children at play" is included in the satellite navigator's map data, the driver display shows a sign of this type.

#### Related information

- Road Sign Information (p. 248)
- Google Maps (p. 442)
- Limitations of Road Sign Information (p. 254)

# Warning for speed limitation and speed camera from road sign information

Road sign information (RSI<sup>50</sup>) includes subfunctions that can warn the driver if a speed limit has been exceeded or in connection with speed cameras.



Examples of information on speed camera and speed limit in the driver display

## Speed limit warning



The speed warning is given by the driver display symbol<sup>51</sup> showing the applicable maximum permitted speed temporarily flashing when this speed is exceeded.

A speed warning is always given if the speed limit is exceeded in connection with speed camera information.

Speed warning warns the driver when the applicable speed limit or stored maximum speed is exceeded – this warning is repeated once after approx. 30 seconds within the same speed limit area unless the driver reduces the speed.

Another warning is available only when the driver has reduced the speed by at least 5 km/h (3 mph) and then exceeds the speed limit again, or when the car reaches a new/different speed limit area.

## Warning for speed camera



Road sign information can give information on speed cameras ahead in the driver display<sup>52</sup>.

If the car exceeds a detected speed limit with the speed warning function activated, a speed warning is given when the car approaches a speed camera, provided that the navigation map for the area in question contains information on speed cameras.

## Related information

- Road Sign Information (p. 248)
- Adjusting warnings from road sign information (p. 253)
- Limitations of Road Sign Information (p. 254)

<sup>50</sup> Road Sign Information

<sup>51</sup> Road signs are customised for each market – the one shown here is just an example.



<sup>52</sup> Information on speed cameras on the navigation map is not available for all markets/areas.

# Adjusting warnings from road sign information

## NOTE

- To get an acoustic warning if you exceed the required speed, the speed warning function must be activated and the visual warning for road signs subfunction must be set to On. An acoustic warning is then given if the car's speed exceeds the speed indicated by the road sign information function in the driver display.
- An option is available to receive an acoustic warning for speed cameras independently of the car's speed and exceeded speed limit, even if the function for acoustic warning for road signs is deactivated.

The driver can select which warnings are activated for road sign information (RSI<sup>53</sup>) and adjust the limit for them.

1. Tap on  in the centre display.
2. Press Assist.
3. Tap on  for road sign information and select the desired setting.

You can choose to do the following:

- Activate speed warning
- Adjust the limit for Speed Warning<sup>54</sup>
- Activating acoustic warning in connection with speed warning<sup>55</sup>
- Activating acoustic warning in connection with speed camera warning<sup>56</sup>

## Related information

- Road Sign Information (p. 248)
- Warning for speed limitation and speed camera from road sign information (p. 252)
- Limitations of Road Sign Information (p. 254)

<sup>53</sup> Road Sign Information

<sup>54</sup> The function does not take account of the selected limit adjustment when the driver display shows the symbol for speed camera.

<sup>55</sup> The driver can also be warned when driving towards one-way traffic/no entry road. Applies to certain markets.

<sup>56</sup> The car needs access to map data with information on speed cameras.

# Limitations of Road Sign Information

The Road Sign Information (RSI<sup>57</sup>) function may have limitations in certain situations.

Examples of what can reduce the function are as follows:

- Faded signs
- Signs positioned on bends
- Rotated or damaged signs
- Signs positioned high above the roadway
- Fully/partially obscured or poorly positioned signs
- signs completely or partly covered with frost, snow and/or dirt
- digital road maps are out-of-date, inaccurate or have no speed information<sup>58</sup>

## Related information

- Road Sign Information (p. 248)
- Limitations for camera unit (p. 341)
- Limitations for radar device (p. 329)





## NOTE

- In certain markets, the Road Sign Information function is only available in combination with map data.
- Some bicycle rack types connected to the power socket for trailers can be interpreted as connected trailers by the Road Sign Information system. The driver display may show incorrect speed information in such cases.
- This function uses the car's camera and/or radar units, which have certain general limitations.

# Cruise control functions

There are several driver support systems that can assist you while driving in order to maintain a suitable speed depending on situation. Here is a summary to make them more easily distinguishable from each other.

It is recommended that you read all sections in the Manual that relate to a function in order to learn about factors such as its limitations and what the driver should be aware of before using the system.

	Speed limiter <sup>A</sup>	Automatic speed limiter <sup>B</sup>	Cruise control <sup>C</sup>	Adaptive cruise control <sup>DE</sup>	Pilot Assist <sup>E</sup>
Symbol in the driver display					
Brief description	The driver controls the speed with the accelerator pedal but is prevented by the speed limiter from mistakenly exceeding a preselected/preset maximum speed.	The automatic speed limiter uses speed information from the Road Sign Information <sup>F</sup> function to automatically adapt the car's maximum speed.	The cruise control helps the driver to maintain an even speed, which can result in a more relaxed driving experience on, for example, motorways and long straight main roads in smooth traffic flows.	The adaptive cruise control helps the driver to maintain an even speed combined with a preselected time interval to the vehicle ahead.	Pilot Assist can help the driver to drive the car between the lane's side markings using steering assistance as well as to maintain an even speed, combined with a preselected time interval to the vehicle ahead.

A Speed Limiter

B Automatic Speed Limiter

C Cruise Control

D Adaptive Cruise Control

E This function can be either standard or optional, depending on market.

F Road Sign Information

### Related information







- Driving support systems (p. 242)
- Speed limiter (p. 259)
- Automatic speed limiter (p. 260)
- Cruise control (p. 262)
- Adaptive cruise control\* (p. 264)
- Pilot Assist\* (p. 268)



# Cruise control function steering wheel buttons

The cruise control functions can be controlled using the left-hand steering wheel keypad. This applies to speed limiter (SL<sup>59</sup>), automatic speed limiter (ASL<sup>60</sup>), cruise control (CC<sup>61</sup>), adaptive cruise control (ACC<sup>62</sup>) and Pilot Assist.



*Cruise control function buttons*

- ① : From standby mode – Activates the selected function and stores the current speed.  
: From active mode – Sets the function in standby mode.
- ② : From standby mode – Activates the selected function and resumes the stored speed.  
: From active mode – Increases the stored speed.
- ③ : Reduces stored speed.
- ④ : When the speed limiter is selected/active, the automatic speed limiter can be selected too.
- ⑤ : When adaptive cruise control\* is selected/active, Pilot Assist\* can be selected too.

- ⑥ : Reduces the time interval to vehicles ahead.
- ⑦ : Increases the time interval to vehicles ahead.

## Related information

- Cruise control functions (p. 254)
- Selecting and activating the cruise control function (p. 257)
- Deactivating cruise control functions (p. 259)
- Setting the stored speed for cruise control functions (p. 280)
- Setting the time interval to the vehicle ahead (p. 281)



# Selecting and activating the cruise control function

## WARNING

- The function is supplementary driver support intended to facilitate driving and make it safer – it cannot handle all situations in all traffic, weather and road conditions.
- The driver is advised to read all sections in the Manual that relate to this function to learn about factors such as its limitations and what the driver should be aware of before using the system.
- Driver support functions are not a substitute for the driver's attention and judgement. The driver is always responsible for ensuring the car is driven in a safe manner, at the appropriate speed, with an appropriate distance to other vehicles, and in accordance with current traffic rules and regulations.

The cruise control functions must first be selected in the centre display before they can be activated using the steering wheel button. This applies to speed limiter (SL<sup>63</sup>), automatic speed limiter (ASL<sup>64</sup>), cruise control (CC<sup>65</sup>), adaptive cruise control (ACC<sup>66</sup>) and Pilot Assist.

1.



Select the desired function with the button for cruise control functions in the centre display under Assist.

- > The button's symbol changes depending on the function selected, and the symbol in the driver display is visible but extinguished.

2. When the desired function is selected – press the steering wheel button  to activate.

- > The symbol in the driver display is illuminated – the function is started and the current speed is stored as maximum speed.

3. If the function is set in standby mode – press the steering wheel button  to reactivate.

- > The driver display's cruise control indicator illuminates – the car then follows the last stored speed again.

63 Speed Limiter

64 Automatic Speed Limiter

65 Cruise Control

66 Adaptive Cruise Control

### Change between speed limiter and automatic speed limiter

- When the speed limiter is selected – press the steering wheel button  to change to automatic speed limiter. Press again to change back.

### Change between adaptive cruise control and Pilot Assist

- When the adaptive cruise control is selected – press the steering wheel button  to change to Pilot Assist. Press again to change back.

### Criteria

Certain conditions must be met in order to start any of the functions.

#### Speed limiter and automatic speed limiter

- The speed limiter cannot be activated until after the engine has been started.
- The lowest maximum speed that can be stored is 30 km/h (20 mph).

#### Cruise control

- In order to start the cruise control from the standby mode, the car's current speed must be 30 km/h (20 mph) or higher.

#### Adaptive cruise control

- The driver's seatbelt must be buckled and the driver's door must be closed.
- There must be a vehicle (the "target vehicle") within reasonable distance in front of the car, or the current speed must be at least 15 km/h (9 mph).

### Pilot Assist

- The driver's seatbelt must be buckled and the driver's door must be closed.
- The lane's edge markings must be clear and must be detected by the car.
- There must be a vehicle (the "target vehicle") within reasonable distance in front of the car, or the current speed must be at least 15 km/h (9 mph).
- The speed must not exceed 140 km/h (87 mph).
- The driver must keep his/her hands on the steering wheel.

### Related information

- Cruise control functions (p. 254)
- Deactivating cruise control functions (p. 259)
- Standby mode for cruise control (p. 263)
- Standby mode for adaptive cruise control\* (p. 266)

## WARNING

A significant increase in speed may follow when the speed is resumed with the  steering wheel button.

# Deactivating cruise control functions

The cruise control functions can be deactivated using the steering wheel button. The function is then set in standby mode. This applies to speed limiter (SL<sup>67</sup>), automatic speed limiter (ASL<sup>68</sup>), cruise control (CC<sup>69</sup>), adaptive cruise control (ACC<sup>70</sup>) and Pilot Assist.

- Press the steering wheel button .
  - > The symbol and indicators are extinguished – the speed limiter is set in standby mode, and the driver can exceed the stored speed limit.

When another function is selected in the centre display, both the driver display symbol and the indicator for the previously selected function are hidden – this deletes the set/stored maximum speed.

## Related information

- Cruise control functions (p. 254)
- Selecting and activating the cruise control function (p. 257)

## WARNING

When cruise control functions are in standby mode, the driver must intervene and regulate both speed and distance to the vehicle ahead.

# Speed limiter

The speed limiter (SL<sup>71</sup>) can be likened to a reverse cruise control - the driver regulates the speed using the accelerator pedal but is prevented from accidentally exceeding a stored maximum speed by the speed limiter.

## Temporary acceleration

The speed limiter can be temporarily overridden when the accelerator pedal is fully depressed, without the speed limiter first having to be set in standby mode - e.g. to be able to quickly accelerate the car out of a situation.

In which case, proceed as follows:

1. Fully depress the accelerator pedal and release it to interrupt acceleration when the desired speed has been reached.
  - > In this mode, the speed limiter is still activated and the driver display's symbol is therefore illuminated.
2. Fully release the accelerator pedal when the temporary acceleration is finished.
  - > The car is then engine-braked automatically to below the last stored maximum speed.

## Steep roads

On steep hills, the speed limiter's braking effect may be inadequate and the stored maximum speed may be exceeded.

## Related information

- Driving support systems (p. 242)
- Cruise control function steering wheel buttons (p. 256)

# Automatic speed limiter

- Selecting and activating the cruise control function (p. 257)
- Deactivating cruise control functions (p. 259)
- Automatic speed limiter (p. 260)

## WARNING

- The function is supplementary driver support intended to facilitate driving and make it safer – it cannot handle all situations in all traffic, weather and road conditions.
- The driver is advised to read all sections in the Manual that relate to this function to learn about factors such as its limitations and what the driver should be aware of before using the system.
- Driver support functions are not a substitute for the driver's attention and judgement. The driver is always responsible for ensuring the car is driven in a safe manner, at the appropriate speed, with an appropriate distance to other vehicles, and in accordance with current traffic rules and regulations.

The Automatic Speed Limiter (ASL<sup>72</sup>) function helps the driver to adapt the car's maximum speed to the speed shown on the road signs.



The function has a dynamic symbol that changes appearance when the function is active.

The colour of the symbol indicates the status of the function:

Symbol	Meaning
Illuminated	Automatic speed limiter is active.
Grey	Automatic speed limiter is selected but in standby mode.
Extinguished	Automatic speed limiter is inactive. Other cruise control is selected.

## Speed information from road signs

The automatic speed limiter uses speed information from the Road Sign Information (RSI<sup>73</sup>) function to automatically adapt the car's maximum speed.

Road sign information bases its information on the speed-dependent road signs that the car passes, as well as map data. Physical signs passed have highest priority, which may be necessary for roadworks, for example.

If road sign information cannot interpret and provide speed information to the driver support systems, the automatic speed limiter is set in standby mode and changes to normal speed limiter. In such cases the driver must intervene and brake to a suitable speed.

The automatic speed limiter will be reactivated when road sign information can once again interpret and provide speed information.

#### Tolerance level for automatic speed limiter

Automatic speed limiter can be set to different tolerance levels. The tolerance is adjusted in the same way as the speed setting is in the speed limiter.

If, for example, the car follows a signed speed limit of 70km/h (43 mph) the driver can instead choose to allow the car to maintain 75 km/h (47 mph).

The tolerance is followed until a road sign with a lower or higher speed is passed - then the car follows the new signed speed limit instead and the tolerance is deleted from the memory.

#### Related information

- Cruise control functions (p. 254)
- Speed limiter (p. 259)
- Road Sign Information (p. 248)
- Selecting and activating the cruise control function (p. 257)
- Deactivating cruise control functions (p. 259)
- Setting the stored speed for cruise control functions (p. 280)

## WARNING

- Even if the driver clearly sees the speed-related road sign, the speed information from the Road Sign Information to automatic speed limiter function may be incorrect – in such cases the driver must intervene him/herself and accelerate or brake to a suitable speed.
- The function is supplementary driver support intended to facilitate driving and make it safer – it cannot handle all situations in all traffic, weather and road conditions.
- The driver is advised to read all sections in the Manual that relate to this function to learn about factors such as its limitations and what the driver should be aware of before using the system.
- Driver support functions are not a substitute for the driver's attention and judgement. The driver is always responsible for ensuring the car is driven in a safe manner, at the appropriate speed, with an appropriate distance to other vehicles, and in accordance with current traffic rules and regulations.

## NOTE

The maximum selectable tolerance is +/- 10 km/h (5 mph).

# Cruise control

The cruise control (CC<sup>74</sup>) helps the driver maintain an even speed, which can result in more relaxed driving on motorways and long, straight roads in regular traffic flows.

## Use engine braking instead of the foot brake

With Cruise Control, speed is regulated with less frequent application of the foot brake. On a hill, it may sometimes be desirable to start moving a little faster and limit the acceleration only by engine braking. In this case the driver can temporarily disable foot brake application by Cruise Control.

To do so, proceed as follows:

- Depress the accelerator pedal about halfway down and release.
  - > Cruise Control will disengage its automatic foot braking and then uses engine braking only.

## Related information

- Cruise control functions (p. 254)
- Selecting and activating the cruise control function (p. 257)
- Deactivating cruise control functions (p. 259)
- Standby mode for cruise control (p. 263)
- Setting the stored speed for cruise control functions (p. 280)

## WARNING

- The function is supplementary driver support intended to facilitate driving and make it safer – it cannot handle all situations in all traffic, weather and road conditions.
- The driver is advised to read all sections in the Manual that relate to this function to learn about factors such as its limitations and what the driver should be aware of before using the system.
- Driver support functions are not a substitute for the driver's attention and judgement. The driver is always responsible for ensuring the car is driven in a safe manner, at the appropriate speed, with an appropriate distance to other vehicles, and in accordance with current traffic rules and regulations.

# Standby mode for cruise control

Cruise control (CC<sup>75</sup>) can be deactivated and set in standby mode. This can take place automatically or due to intervention by the driver.

Standby mode means that the function is selected in the centre display but not activated. The symbol in the driver display is extinguished and the cruise control does not then regulate the speed.

## Standby mode on driver intervention

Cruise control is deactivated and set to standby mode if any of the following occur:

- The foot brake is used.
- The gear selector is moved to the N position.
- The driver maintains a speed higher than the stored speed for more than 1 minute.

The driver must then control the speed himself/herself.

A temporary increase in speed with the accelerator pedal, e.g. during overtaking, does not affect the setting - the car returns to the last stored speed when the accelerator pedal is released.

## Automatic standby mode

Automatic standby mode may be activated if any of the following occur, for example:

- The wheels lose traction.
- The engine speed is too low/high.
- The brake temperature is too high.
- The speed falls below 30 km/h (20 mph).

The driver must then control the speed himself/herself.

## Related information

- Cruise control (p. 262)

# Adaptive cruise control<sup>76</sup>

The adaptive cruise control (ACC<sup>77</sup>) can help the driver to maintain a constant speed, combined with a preset time interval to the vehicle ahead.

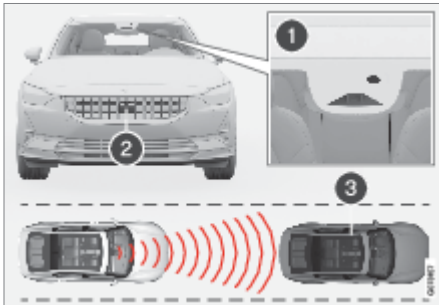

The camera and radar unit measures the distance to the vehicle ahead.

- ① Camera unit
- ② Radar unit
- ③ Distance measurement to vehicle ahead

An adaptive cruise control can provide a more relaxing driving experience on long journeys on motorways and long straight main roads in smooth traffic flows.

The driver selects the desired speed and a time interval to the vehicle ahead. If the camera and radar units detect a slower vehicle in front of the car, the speed is automatically adapted using the preset time interval to the vehicle ahead. When the road is clear again the car returns to the selected speed.

Adaptive Cruise Control regulates the speed with acceleration and braking. It is normal for the brakes to emit a low sound when they are being used to adjust the speed.

Adaptive cruise control attempts to:

- regulate the speed smoothly. In situations that demand sudden braking the driver must brake himself/herself. This applies in cases of large speed differences or if the vehicle in front brakes suddenly. Due to the limitations of the radar unit, braking may come unexpectedly or not at all.
- follow the vehicle ahead in the same lane at a time interval set by the driver. If the radar unit cannot see any vehicle ahead, the car will instead maintain the speed stored by the driver. This also takes place if the speed of the vehicle ahead increases and exceeds the stored speed.

## Steep roads and/or heavy load

Bear in mind that the adaptive cruise control is primarily intended for use when driving on level road surfaces. The function may have difficulty in keeping the correct distance from the vehicle ahead when driving on steep downhill gradients - in which case, be extra attentive and ready to brake.

Do not use adaptive cruise control if the car has a heavy load or with a trailer connected to the car.

## Related information

- Cruise control functions (p. 254)
- Selecting and activating the cruise control function (p. 257)
- Deactivating cruise control functions (p. 259)
- Standby mode for adaptive cruise control\* (p. 266)
- Symbols and messages for adaptive cruise control\* (p. 267)
- Setting the time interval to the vehicle ahead (p. 281)



- Setting the stored speed for cruise control functions (p. 280)
- Warning from cruise control functions in the event of a risk of collision (p. 278)
- Automatic braking with cruise control functions (p. 282)
- Change of target with cruise control functions (p. 279)
- Overtaking Assistance\* (p. 276)

## WARNING

- This is not a collision avoidance system. The driver is always responsible and must intervene if the system does not detect a vehicle ahead.
- The function does not brake for humans or animals, and not for small vehicles such as bicycles and motorcycles. Nor for low trailers, oncoming, slow or stationary vehicles and objects.
- Do not use the function in demanding situations, such as in city traffic, at junctions, on slippery surfaces, with a lot of water or slush on the road, in heavy rain/snow, in poor visibility, on winding roads or on slip roads.

## WARNING

- The function is supplementary driver support intended to facilitate driving and make it safer – it cannot handle all situations in all traffic, weather and road conditions.
- The driver is advised to read all sections in the Manual that relate to this function to learn about factors such as its limitations and what the driver should be aware of before using the system.
- Driver support functions are not a substitute for the driver's attention and judgement. The driver is always responsible for ensuring the car is driven in a safe manner, at the appropriate speed, with an appropriate distance to other vehicles, and in accordance with current traffic rules and regulations.

## IMPORTANT

Driver support components must only be maintained at a workshop – contact Polestar Support.

## NOTE

This function uses the car's camera and/or radar units, which have certain general limitations.

# Standby mode for adaptive cruise control<sup>78</sup>

The adaptive cruise control (ACC<sup>79</sup>) can be deactivated and set in standby mode. This can take place automatically or due to intervention by the driver.

Standby mode means that the function is selected in the centre display but not activated. The symbol in the driver display is extinguished and the adaptive cruise control does not then regulate the speed or distance to vehicles ahead.

## Standby mode on driver intervention

Adaptive cruise control is deactivated and set to standby mode if any of the following occur:

- The foot brake is used.
- The gear selector is moved to the N position.
- The driver maintains a speed higher than the stored speed for more than 1 minute.

A temporary increase in speed with the accelerator pedal, e.g. during overtaking, does not affect the setting - the car returns to the last stored speed when the accelerator pedal is released.

## Automatic standby mode

Automatic standby mode may be enabled if any of the following occur:

- Any of the systems on which adaptive cruise control is dependent stops working, e.g. stability control/anti-skid (ESC<sup>80</sup>).
- The driver opens the door.
- The driver takes off the seatbelt.
- The engine speed is too low/high.
- One or more wheels lose traction.

- The brake temperature is high.
- The parking brake is applied.
- The camera and/or radar units are covered by e.g. snow or heavy rainfall (camera lens/radio waves are blocked).
- The speed is below 5 km/h (3 mph) and ACC is uncertain whether the vehicle ahead is a stationary vehicle or an object, such as a speed bump.
- The speed is below 5 km/h (3 mph) and the vehicle ahead turns off so that ACC no longer has a vehicle to follow.

## Related information

- Adaptive cruise control\* (p. 264)

## WARNING

- With the adaptive cruise control is in standby mode, the driver must intervene and regulate both speed and distance to the vehicle ahead.
- When the adaptive cruise control is in standby mode and the car comes too close to a vehicle ahead, the driver may be warned of the short distance by the Distance Warning function instead.

<sup>78</sup> This function can be either standard or optional, depending on market.

<sup>79</sup> Adaptive Cruise Control



<sup>80</sup> Electronic Stability Control

## Symbols and messages for adaptive cruise control<sup>81</sup>

### WARNING

- With automatic standby mode, the driver is warned via an acoustic signal and a message in the driver display.
- The driver must then regulate the car's speed, apply the brakes as needed and maintain a safe distance to other vehicles.

A number of symbols and messages regarding the adaptive cruise control (ACC<sup>82</sup>) can be shown. Here are some examples.

Symbol	Message	Specification
	The symbol is illuminated	The car is maintaining the stored/selected speed.
	Adaptive Cruise Control Service required The symbol is extinguished	The system does not function as it should. Contact Polestar Support. Adaptive cruise control is set to standby mode.
	Radar sensor front Sensor blocked See Manual	Clean the surface of the grille in front of the radar unit.

A text message can be cleared by briefly pressing the  button, located in the centre of the steering wheel's right-hand keypad.

If you still see a message, please contact Polestar Support.

#### Related information

- Adaptive cruise control\* (p. 264)
- Polestar Support (p. 9)

<sup>81</sup> This function can be either standard or optional, depending on market.

<sup>82</sup> Adaptive Cruise Control

# Pilot Assist<sup>83</sup>

Pilot Assist can help the driver to drive the car between the lane's side markings as well as to maintain an even speed, combined with a pre-selected time interval to the vehicle ahead.

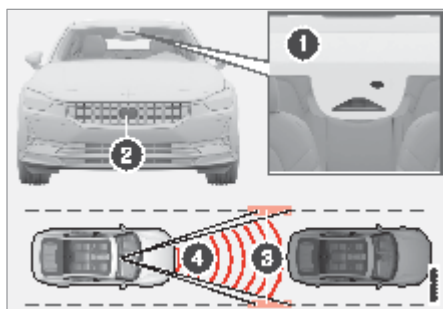

The camera and radar units measure the distance to the vehicle ahead and detect lane markings.

- ① Camera unit
- ② Radar unit
- ③ Reading lane markings
- ④ Reading the distance

## Get to know Pilot Assist

Pilot Assist helps to steer the car. You may need to drive several kilometres with Pilot Assist before you feel completely comfortable with the function. It is important to be aware of all the applications and limitations of this function so that you can use all its benefits safely.

The Pilot Assist function is primarily intended for use on motorways and similar major roads where it can contribute to more comfortable driving and a more relaxed driving experience.

The driver selects the desired speed and a time interval to the vehicle ahead. Pilot Assist scans the distance to the vehicle ahead and the lane's

lane markings on the road surface using the camera and radar units. The preset time interval is maintained with automatic speed adjustment whilst the steering assistance helps to position the car in the lane.

Pilot Assist regulates the speed with acceleration and braking. It is normal for the brakes to emit a low sound when they are being used to adjust the speed.

Pilot Assist attempts to:

- regulate the speed smoothly. In situations that demand sudden braking the driver must brake himself/herself. This applies in cases of large speed differences or if the car in front brakes suddenly. Due to the limitations of the camera and radar units, braking may come unexpectedly or not at all.
- follow the vehicle ahead in the same lane at a time interval set by the driver. If the radar unit cannot see any vehicle in front then the car will instead maintain the speed set and stored by the driver. This also takes place if the speed of the vehicle ahead increases and exceeds the stored speed.

## The position of the car in the lane

When Pilot Assist helps to steer, it attempts to place your car halfway between the visible lane markings. For a smoother drive, it is a good idea to allow the car to find a good position. The driver can always adjust the position him/herself by increasing the steering input. It is important for the driver to make sure the car is positioned safely in the lane.

If Pilot Assist does not position the car in an appropriate way in the lane, it is recommended to turn Pilot Assist off or switch to Adaptive cruise control.

## Steering assistance



The current status of steering assistance is indicated by the colour of the steering wheel's symbol:

- Illuminated steering wheel indicates active steering assistance.

tance.

- Extinguished steering wheel (as in illustration) indicates deactivated steering assistance.

Pilot Assist steering assistance takes into account the speed of the preceding car and the lane markings. The driver can at any time adjust steering intervention from Pilot Assist and steer in another direction, e.g. to change lane or avoid an obstruction on the road. In this case, resistance is felt in the steering wheel as long as steering assistance is active.

### Temporary disabling of steering assistance

When the direction indicators are used, Pilot Assist steering assistance is temporarily disengaged. When the direction indicator is switched off, steering assistance is reactivated automatically if the lane's edge markings can still be detected.

If Pilot Assist is unable to interpret the lane clearly, e.g. if the camera unit is unable to see the edge markings for the lane, Pilot Assist temporarily disables steering assistance. Functions for speed and distance regulation continue to remain active. Steering assistance is resumed when the lane can be interpreted again. In these situations, slight vibration in the steering wheel may alert the driver to the fact that steering assistance has been deactivated temporarily.

## Round bends and when the road splits

Pilot Assist interacts with the driver, who should therefore not wait for the steering assistance from Pilot Assist but should always be prepared to increase his/her own steering input, especially in bends.

When the car approaches an exit or if the lane splits, the driver should steer towards the desired lane so that Pilot Assist must detect the desired direction.

### Hands on the steering wheel



In order for Pilot Assist to function, the driver's hands must be on the steering wheel. It is important for the driver always to carry on being active and alert when driving as Pilot Assist is unable to read all situations and may toggle between off and on without prior warning.

1. If Pilot Assist detects that the driver is not keeping his/her hands on the steering wheel, the system provides a warning by means of a symbol and text message in the driver display to encourage the driver to actively steer the car.
2. If the driver's hands still cannot be detected on the steering wheel after a few seconds the prompt to actively steer the car is repeated supplemented by an audible signal.
3. If Pilot Assist cannot detect the driver's hands on the steering wheel after a further few seconds the audible signal becomes intensive and the steering function is deactivated. Pilot Assist must then be restarted using the steering wheel button .
4. In connection with Pilot Assist being switched off, additional acoustic and visual

warnings are given, as well as that the car's system brakes the car. This braking judders in order to attract the driver's attention.

5. The system continues to brake the car to standstill in its own lane and the hazard warning flashers are activated<sup>52</sup>.

### Steep roads and/or heavy load

Bear in mind that Pilot Assist is primarily intended for use when driving on level road surfaces. The function may have difficulty in keeping the correct distance from the vehicle ahead when driving on steep downhill gradients - in which case, be extra attentive and ready to brake.

Do not use Pilot Assist if the car has a heavy load or with a trailer connected to the car.

### Read all warnings before use

#### Related information

- Cruise control functions (p. 254)
- Selecting and activating the cruise control function (p. 257)
- Deactivating cruise control functions (p. 259)
- Display view for adaptive cruise control and Pilot Assist\* (p. 272)
- Standby mode for Pilot Assist\* (p. 273)
- Symbols and messages for Pilot Assist\* (p. 274)
- Setting the time interval to the vehicle ahead (p. 281)
- Setting the stored speed for cruise control functions (p. 280)
- Warning from cruise control functions in the event of a risk of collision (p. 278)

- Automatic braking with cruise control functions (p. 282)
- Change of target with cruise control functions (p. 279)
- Overtaking Assistance\* (p. 276)

## WARNING

- Pilot Assist steering assistance is automatically deactivated and is resumed without prior warning.
- Do not wait for all levels of warning and assistance from the systems, but act immediately if any warning signal is triggered.
- The function is supplementary driver support intended to facilitate driving and make it safer – it cannot handle all situations in all traffic, weather and road conditions.
- The driver is advised to read all sections in the Manual that relate to this function to learn about factors such as its limitations and what the driver should be aware of before using the system.
- Driver support functions are not a substitute for the driver's attention and judgement. The driver is always responsible for ensuring the car is driven in a safe manner, at the appropriate speed, with an appropriate distance to other vehicles, and in accordance with current traffic rules and regulations.

<sup>52</sup> Regulations for the use of hazard warning flashers may vary between countries.

## WARNING

- In certain situations, Pilot Assist steering assistance may have difficulty helping the driver in the right way or it may be automatically deactivated - in which case, the use of Pilot Assist is not recommended. Examples of such situations may be that:
  - the lane markings are unclear, worn, missing, or they cross each other, or if there are several sets of lane markings.
  - the lane division is changed, e.g. when the lanes split or merge, as well as on slip roads.
  - at roadworks and sudden changes in the roadway, e.g. when the lines may stop marking the correct route.
  - edges or other lines than lane markings are present on or near the road, e.g. kerbs, joints or repairs to the road surface, edges of barriers, roadside edges or strong shadows.
  - the lane is narrow or winding.
  - the lane contains ridges or holes.
  - weather conditions are poor, e.g. rain, snow or fog or slush or impaired view with poor light conditions, back-lighting, wet road surface etc.

The driver should also note that Pilot Assist has the following limitations:

- High kerbs, roadside barriers, temporary obstacles (traffic cones, safety barriers, etc.) are not detected. Alternatively, they may be

## WARNING

detected incorrectly as lane markings, with a subsequent risk of contact between the car and such obstacles. The driver must ensure him/herself that the car is at a suitable distance from such obstacles.

- The camera and radar sensor does not have the capacity to detect all oncoming objects and obstacles in traffic environments, e.g. potholes, stationary obstacles or objects which completely or partially block the route.
- Pilot Assist does not "see" pedestrians, animals, etc.
- The recommended steering input is force limited, which means that it cannot always help the driver to steer and keep the car within the lane.
- The car's functions have the option to use information from map data which may result in varied performance.
- Pilot Assist is switched off if the power steering for speed related steering force is working with reduced power - e.g. during cooling due to overheating.
- Pilot Assist must only be used if there are clear lane lines painted on each side of the lane. All other use involves increased risk of contact with surrounding obstacles that cannot be detected by the function.

# Display view for adaptive cruise control and Pilot Assist<sup>85</sup>

The following illustrative example shows how adaptive cruise control (ACC<sup>86</sup>) and Pilot Assist can be shown in the driver display.

## WARNING

- This is not a collision avoidance system. The driver is always responsible and must intervene if the system does not detect a vehicle ahead.
- The function does not brake for humans or animals, and not for small vehicles such as bicycles and motorcycles. Nor for low trailers, oncoming, slow or stationary vehicles and objects.
- Do not use the function in demanding situations, such as in city traffic, at junctions, on slippery surfaces, with a lot of water or slush on the road, in heavy rain/snow, in poor visibility, on winding roads or on slip roads.



## IMPORTANT

Driver support components must only be maintained at a workshop – contact Polestar Support.

## NOTE

- Pilot Assist cannot be activated if a trailer, bicycle rack or similar is connected to the car's electrical system.
- This function uses the car's camera and/or radar units, which have certain general limitations.

### Symbol indication

	Both functions are selected but not active.
	Adaptive cruise control is active. Pilot Assist is selected but not available. The conditions for the function are not met.
	Both functions are active.

### Speed



*Indication of speeds.*

<sup>85</sup> These functions can be either standard or optional, depending on market.



<sup>86</sup> Adaptive Cruise Control



# Standby mode for Pilot Assist<sup>87</sup>

- 1 Stored speed
- 2 Current speed of your car

## Time interval

	When the symbol in the driver display shows a car, the time interval to the vehicle ahead is regulated.
	When no car is shown, the functions follow the stored speed.

## Lines for Pilot Assist steering assistance

The driver display has three different display modes that are changed via the  button on the right-hand side of the steering wheel. If the Car Centric display mode is selected for the driver display, lines are shown that illustrate when Pilot Assist steering assistance is available.

- Grey lines: steering assistance unavailable
- White lines: steering assistance available
- Amber lines: steering assistance active

## Related information

- Adaptive cruise control\* (p. 264)
- Pilot Assist\* (p. 268)

Pilot Assist can be deactivated and set in standby mode. This can take place automatically or due to intervention by the driver.

Standby mode means that the function is selected in the centre display but not activated. The symbol in the driver display is extinguished and Pilot Assist does not then regulate the speed or the distance to the vehicle ahead, or provide steering assistance.

## Standby mode on driver intervention

Pilot Assist is deactivated and set to standby mode if any of the following occur.

- The foot brake is used.
- The gear selector is moved to the N position.
- The direction indicators are used for longer than 1 minute.
- The driver maintains a speed higher than the stored speed for more than 1 minute.

## Automatic standby mode

Automatic standby mode may be enabled if any of the following occur.

- Any of the systems on which Pilot Assist is dependent stops working, e.g. stability control/anti-skid (ESC<sup>88</sup>).
- Hands not holding the steering wheel.
- The driver opens the door.
- The driver takes off the seatbelt.
- The engine speed is too low/high.
- One or more wheels lose traction.
- The brake temperature is high.
- The parking brake is applied.

<sup>87</sup> This function can be either standard or optional, depending on market.

<sup>88</sup> Electronic Stability Control

# Symbols and messages for Pilot Assist<sup>89</sup>

- The camera and/or radar units are covered by e.g. snow or heavy rainfall (camera lens/radio waves are blocked).
- The speed is below 5 km/h (3 mph) and Pilot Assist is uncertain whether the vehicle ahead is a stationary vehicle or an object, such as a speed bump.
- The speed is below 5 km/h (3 mph) and the vehicle ahead turns off so that Pilot Assist no longer has a vehicle to follow.

A number of symbols and messages regarding Pilot Assist can be shown. Here are some examples.



## Related information

- Pilot Assist\* (p. 268)

### WARNING

With automatic standby mode, the driver is warned via an acoustic signal and a message in the driver display.

- The driver must then regulate the car's speed, apply the brakes as needed and maintain a safe distance to other vehicles.

Symbol	Message	Specification
	Extinguished steering wheel symbol	Indicates deactivated steering assistance. The steering wheel is illuminated when Pilot Assist is providing steering assistance.
	Symbol for hands on the steering wheel	The system cannot detect the driver's hands on the steering wheel. Place your hands on the steering wheel and actively steer the car.
	Radar sensor front Sensor blocked See Manual	Clean the surface of the grille in front of the radar unit.

A text message can be cleared by briefly pressing the  button, located in the centre of the steering wheel's right-hand keypad.

If you still see a message, please contact Polestar Support.

#### Related information

- Pilot Assist\* (p. 268)
- Polestar Support (p. 9)

# Overtaking Assistance

Overtaking Assistance can help the driver when overtaking other vehicles. The function can be used with adaptive cruise control or Pilot Assist.

When adaptive cruise control or Pilot Assist is following another vehicle and the driver indicates the intention to overtake by activating the left-hand direction indicator<sup>90</sup> the systems can help by accelerating the car towards the vehicle ahead before the car reaches the overtaking lane.

The function then delays reducing speed in order to avoid premature braking when the driver's car is approaching a slower vehicle.

The function remains active until the driver's vehicle has cleared the overtaken vehicle.

## Related information

- Driving support systems (p. 242)
- Use Overtaking Assistance\* (p. 277)
- Adaptive cruise control\* (p. 264)
- Pilot Assist\* (p. 268)

## WARNING

- The function is supplementary driver support intended to facilitate driving and make it safer – it cannot handle all situations in all traffic, weather and road conditions.
- The driver is advised to read all sections in the Manual that relate to this function to learn about factors such as its limitations and what the driver should be aware of before using the system.
- Driver support functions are not a substitute for the driver's attention and judgement. The driver is always responsible for ensuring the car is driven in a safe manner, at the appropriate speed, with an appropriate distance to other vehicles, and in accordance with current traffic rules and regulations.

## WARNING

- Be aware that this function can be activated in more situations than during overtaking, e.g. when a direction indicator is used to indicate a change of lane or exit to another road – the car will then accelerate briefly.

# Use Overtaking Assistance

Overtaking assistance can be used with adaptive cruise control or Pilot Assist.

The following conditions must exist for Overtaking Assistance to be activated:

- there must be a vehicle in front (the “target vehicle”)
- your car's current speed is at least 70 km/h (43 mph)
- the stored speed must be high enough for overtaking to take place safely.

To start the Overtaking Assistance:

- Activate the direction indicator. Use the left-hand direction indicator in a left-hand drive car, or right in a right-hand drive car.
  - > Overtaking assistance starts acceleration and shortens the time interval to the vehicle ahead for a limited time in order to facilitate overtaking. If the overtaking does not proceed, the time interval returns to the preset.

## Related information

- Overtaking Assistance\* (p. 276)
- Adaptive cruise control\* (p. 264)
- Pilot Assist\* (p. 268)
- Standby mode for adaptive cruise control\* (p. 266)
- Standby mode for Pilot Assist\* (p. 273)

## WARNING

When using the Overtaking Assistance System, the driver should be aware that there may be undesired acceleration if the conditions suddenly change.

Some situations should therefore be avoided, such as if:

- the car is approaching an exit to turn-off in the same direction as overtaking would normally occur
- the vehicle ahead slows down before the driver's car has crossed over into the overtaking lane.
- the traffic in the overtaking lane slows down.
- a right-hand drive car is driven in a county with left-hand traffic (or vice versa).

Situations of this type are avoided by setting the adaptive cruise control or Pilot Assist to standby mode.

# Warning from cruise control functions in the event of a risk of collision

The driver support systems of adaptive cruise control and Pilot Assist can warn the driver if the distance to the vehicle ahead suddenly becomes too short.

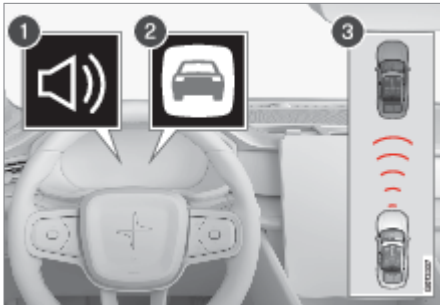

Audio and symbol for collision warning

- 1 Light signal in the event of a risk of collision
- 2 Warning signal in the event of a risk of collision
- 3 Distance measurement with the camera unit and radar unit

Adaptive cruise control and Pilot Assist use approx. 40% of the capacity of the foot brake. If the car needs to be braked more heavily than the driver support is capable of and the driver does not brake, the warning lamp and acoustic warning are activated to alert the driver that immediate intervention is required.

## Related information

- Driving support systems (p. 242)
- Adaptive cruise control\* (p. 264)
- Pilot Assist\* (p. 268)

## WARNING

The driver support systems only warn of vehicles which their radar unit has detected – hence a warning may not be given, or it may be given with a certain delay. Never wait for a warning. Apply the brakes when the situation requires.

# Change of target with cruise control functions

The driver support systems adaptive cruise control and Pilot Assist have a change of target function at certain speeds.

- Adaptive cruise control\* (p. 264)
- Pilot Assist\* (p. 268)

## Change of target

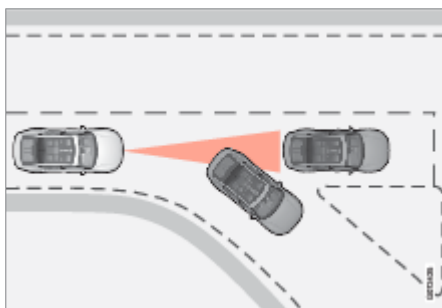

*If the target vehicle in front suddenly turns then there may be stationary traffic in front.*

When the driver supports are following another vehicle at speeds below 30 km/h (20 mph) and changes target vehicle – from a moving vehicle to a stationary vehicle – the driver supports will slow down for the stationary vehicle.

## Automatic standby mode with change of target

The driver supports are disengaged and set in standby mode:

- when the speed is below 5 km/h ((3 mph)) and the driver supports are uncertain whether the target object is a stationary vehicle or another object, such as a speed bump.
- when the speed is below 5 km/h ((3 mph)) and the vehicle ahead turns off so that the driver supports no longer have a vehicle to follow.

## Related information

- Driving support systems (p. 242)

## WARNING

When the driver supports are following another vehicle at speeds in excess of approx. 30 km/h (20 mph) and the target is changed from a moving vehicle to a stationary vehicle, the driver supports will ignore the stationary vehicle and instead accelerate to the stored speed.

- The driver must then intervene him/herself and brake.

# Setting the stored speed for cruise control functions

It is possible to set a stored speed for the speed limiter, cruise control, adaptive cruise control and Pilot Assist functions.



① **+** : Increases the stored speed

② **-** : Reduces stored speed

③ Stored speed

– Change a set speed with short presses on the steering wheel buttons **+** (1) or **-** (2) or by pressing and holding them.

- Short presses: Each press changes the speed in increments of +/- 5 km/h (+/- 5 mph).
- Press and hold: Release the button when the speed indicator (3) has moved to the desired speed.

> The speed set after the last button press is stored in the memory.

## Actuation with the accelerator pedal

If the driver increases the car's speed using the accelerator pedal before pressing the steering wheel button **+** (1), the speed stored will be the car's speed when the button is depressed, provided the driver's foot is on the accelerator

pedal at the moment when the button is depressed.

A temporary increase in speed with the accelerator pedal, e.g. during overtaking, does not affect the setting - the car returns to the last stored speed when the accelerator pedal is released.

## Possible speed

Note that the lowest programmable speed is 30 km/h (20 mph) – even though it is capable of following another vehicle down to 0 km/h, a speed lower than 30 km/h (20 mph) cannot be selected/stored.

The driver support functions can follow another vehicle at speeds from 0 km/h up to 200 km/h (125 mph).

Pilot Assist can give steering assistance from almost stationary up to 140 km/h (87 mph).

## Related information

- Driving support systems (p. 242)
- Speed limiter (p. 259)
- Cruise control (p. 262)
- Adaptive cruise control\* (p. 264)
- Pilot Assist\* (p. 268)



# Setting the time interval to the vehicle ahead

It is possible to set the time interval to the vehicle ahead to be maintained in the adaptive cruise control and Pilot Assist functions.



Control for time interval.

- ① Decrease time interval
- ② Increase time interval
- ③ Distance indicator

- Press the steering wheel button (1) or (2) to increase or decrease the time interval.
  - > The distance indicator (3) shows the current time interval.

Different time intervals to the vehicle in front can be selected and shown in the driver display as 1-5 horizontal lines - the more lines the longer the time interval. One line represents about 1 second to the vehicle in front, 5 lines represents about 3 seconds.

The adaptive cruise control allows the time interval to vary significantly in certain situations in order to allow the car to follow the vehicle in front smoothly and comfortably. At low speed, when the distances are short, the adaptive cruise control increases the time interval slightly.

## Related information

- Driving support systems (p. 242)
- Adaptive cruise control\* (p. 264)
- Pilot Assist\* (p. 268)

## WARNING

- Only use a time window that suits the current traffic conditions.
- The driver should be aware that short time windows limit the amount of time available to react and take action in an unexpected traffic situation.

## NOTE

- When the symbol in the driver display shows a car and a steering wheel, Pilot Assist follows a vehicle in front at a preset time gap.

When only one steering wheel is shown, there is no vehicle within a reasonable distance ahead.

- When the symbol in the driver display shows two cars, adaptive cruise control is following the vehicle in front at a pre-set time interval.

When only one car is shown, there is no vehicle within a reasonable distance ahead.

# Automatic braking with cruise control functions

## NOTE

- The higher the speed the longer the calculated distance in metres for a given time interval.
- Only use the time intervals permitted by local traffic regulations.
- If the driver supports do not seem to respond with a speed increase when activated, it may be because the time window to the vehicle ahead is shorter than the set time window.

The driver support systems adaptive cruise control and Pilot Assist have a special brake function in slow traffic and while stationary. In certain situations, the parking brake is applied in order to keep the car stationary.

### Brake function in slow queues and while stationary

For shorter stops in connection with inching in slow traffic or at traffic lights, driving is automatically resumed if the stops do not exceed approx. 3 seconds - if it takes longer before the vehicle in front starts moving again then the driver support function is set in standby mode with automatic braking.

- The function is reactivated in one of the following ways:
  - Press the steering wheel button .
  - Depress the accelerator pedal.
- > The function resumes following the vehicle ahead if it starts moving forward within approx. 6 seconds.

### Cessation of automatic braking

In some situations, automatic braking ceases on coming to a standstill and the function is set in standby mode. This means that the brakes are released and the car may start to roll - the driver must therefore intervene and brake the car himself/herself to keep it stationary.

This may take place in any of the following situations:

- The driver puts his/her foot on the brake pedal.
- The parking brake is applied.
- The gear selector is moved to N or R position.

- The driver sets adaptive cruise control or Pilot Assist to standby mode.

#### Automatic activation of parking brake

The parking brake is applied if the function is holding the car stationary with the foot brake and:

- The driver opens the door or takes off his/her seatbelt.
- The function has kept the car stationary for more than approx. 5 minutes.
- The brakes have overheated.

#### Related information

- Driving support systems (p. 242)
- Adaptive cruise control\* (p. 264)
- Pilot Assist\* (p. 268)
- Brake functions (p. 375)

#### NOTE

The driver supports can hold the car stationary for a maximum of 5 minutes – then the parking brake is applied and the function is disengaged.

Before the driver supports can be reactivated, the parking brake must be released.

#### WARNING

- A significant increase in speed may follow when the speed is resumed with the  steering wheel button.
- Driver support systems only warn of obstacles which their camera and radar units have detected – hence a warning may not be given, or it may be given with a certain delay.
- Never wait for a warning or intervention. Apply the brakes when the situation requires.

# Lane assistance

The function of the Lane Keeping Aid (LKA<sup>91</sup>) is to help the driver to reduce the risk of the car accidentally leaving its own lane on motorways and similar major routes.

Lane Keeping Aid steers the car back into its lane and/or alerts the driver with vibrations in the steering wheel.

Lane Keeping Aid is active within the speed range 65–200 km/h (40–125 mph) on roads with clearly visible side lines.

On narrow roads the function may be unavailable, in which case it goes into standby mode. The function becomes available again when the road is wide enough.

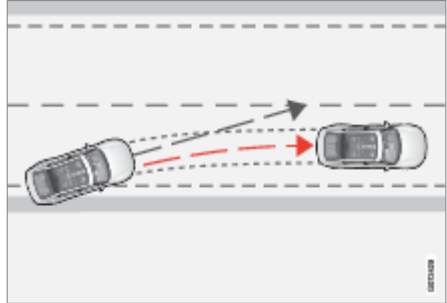

*Lane assistance steers the car back into its lane.*

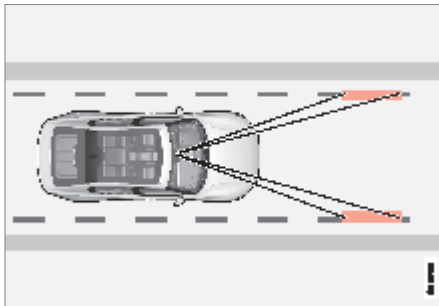

*A camera reads the side lines of the road/lane.*

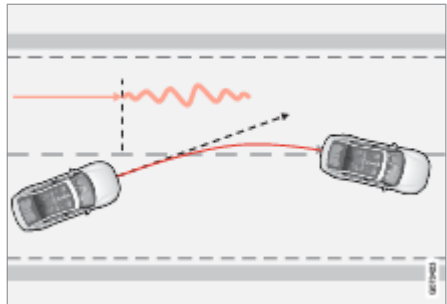

*Lane assistance warns with steering wheel vibrations.*

Depending on settings, lane assistance acts in accordance with the following:

- **Steering assistance activated:** When the car is approaching a lane line, the function will actively steer the car back into its lane by applying a slight torque to the steering wheel.
- **Warning activated:** If the car is about to cross a lane line, the driver is warned by means of vibrations in the steering wheel.

There is also an alternative where both steering assistance and warning are activated simultaneously.

### Lane assistance does not intervene

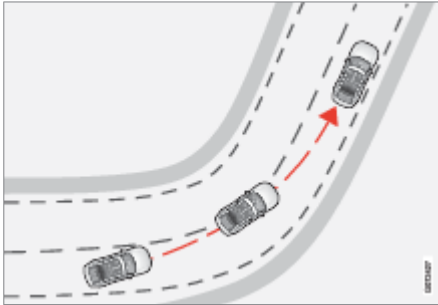

*Lane assistance does not engage on sharp inside curves.*

In some situations, lane assistance allows lane lines to be crossed without intervening with either steering assistance or a warning – e.g. when using the direction indicators or if the car is allowed to cut the corners in bends.

### Hands on the steering wheel

For steering assistance with lane assistance to work, the driver must have his/her hands on the steering wheel, which the system will continue to monitor.

If the driver does not keep his/her hands on the steering wheel, a warning signal is heard and a message encourages the driver to steer the car actively:

- Standby until steering applied Lane Keeping Aid

If the driver does not follow the advice and start to steer, a warning sound can be heard until the driver starts to steer the car again.

### Related information

- Driving support systems (p. 242)
- Activating and deactivating lane assistance (p. 286)
- Selecting assistance option for lane assistance (p. 287)
- Limitations of Lane assistance (p. 287)
- Symbols and messages for lane assistance (p. 288)
- Display mode for lane assistance (p. 289)
- Difference between Pilot Assist\* and lane assistance (p. 290)

### WARNING

- The function is supplementary driver support intended to facilitate driving and make it safer – it cannot handle all situations in all traffic, weather and road conditions.
- The driver is advised to read all sections in the Manual that relate to this function to learn about factors such as its limitations and what the driver should be aware of before using the system.
- Driver support functions are not a substitute for the driver's attention and judgement. The driver is always responsible for ensuring the car is driven in a safe manner, at the appropriate speed, with an appropriate distance to other vehicles, and in accordance with current traffic rules and regulations.

# Activating and deactivating lane assistance

## NOTE

When a direction indicator/flasher is switched on, there are no steering corrections or alerts from lane assistance.

The Lane Keeping Aid (LKA) function (LKA<sup>92</sup>) is optional – the driver can choose to activate or deactivate this function. However, steering intervention will always be active for unbroken lines.



Activate or deactivate the function using this button in the centre display under Assist.

- Button indication on – the function is activated.
- Extinguished button indication – the function is deactivated.

## Related information

- Lane assistance (p. 284)
- Selecting assistance option for lane assistance (p. 287)
- Limitations of Lane assistance (p. 287)

## Selecting assistance option for lane assistance

The driver can select how the Lane Keeping Aid (LKA<sup>93</sup>) should react if the car leaves its lane.

1. Press .
2. Press Assist.
3. Tap on **•••** for lane assistance and select the preferred setting.

### Related information

- Lane assistance (p. 284)

## Limitations of Lane assistance

In certain demanding conditions lane assistance (LKA<sup>94</sup>) may have difficulty helping the driver correctly. In such cases it is recommended to switch off this function.

Examples of such conditions are:

- road works
- winter road conditions
- poor road surface
- a very “sporty” driving style
- poor weather with reduced visibility
- roads with unclear or non-existent side markings
- sharp edges or lines other than the lane's side markings
- as the steering servo for speed-dependent steering wheel resistance is working at reduced power – e.g. when cooling due to overheating.

The function is unable to detect barriers, rails or similar obstacles at the side of the carriageway.

### Related information



- Lane assistance (p. 284)
- Speed-dependent steering force (p. 243)
- Limitations for camera unit (p. 341)
- Limitations for radar device (p. 329)

### NOTE

This function uses the car's camera and/or radar units, which have certain general limitations.

# Symbols and messages for lane assistance

A number of symbols and messages regarding lane assistance (LKA<sup>95</sup>) can be shown on the driver display. Here are some examples.

Symbol	Message	Specification
	Reduced functionality Driver support system Service required	The system does not function as it should. Contact Polestar Support.
	Windscreen sensor blocked See Manual	The ability of the camera to scan the roadway in front of the car is reduced.
	Apply steering Lane Keeping Aid	Steering assistance does not function if the driver does not have his/her hands on the steering wheel. Follow the instruction and steer the car.

A text message can be cleared by briefly pressing the  button, located in the centre of the steering wheel's right-hand keypad.

If you still see a message, please contact Polestar Support.

## Related information

- Lane assistance (p. 284)
- Display mode for lane assistance (p. 289)
- Limitations of Lane assistance (p. 287)
- Polestar Support (p. 9)



# Display mode for lane assistance

Lane assistance (LKA<sup>96</sup>) is visualised by symbols in the driver display depending on the situation.



Here are some examples of symbols and the situations in which they are shown:

Available

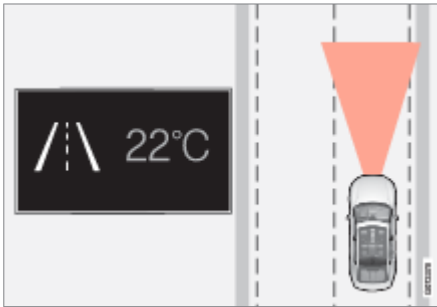

*Available — the lane lines in the symbol are white.*

Lane assistance is scanning one or both lane lines.

Unavailable

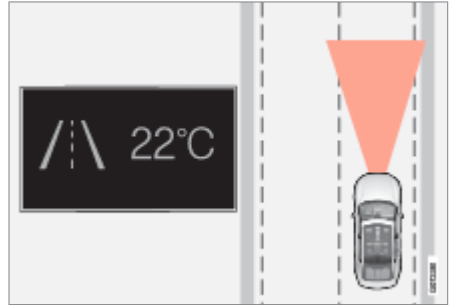

*Unavailable — the lane lines in the symbol are extinguished.*

The Lane assistance cannot detect the lane lines, the speed is too low or the road is too narrow.

Indication of steering assistance/warning

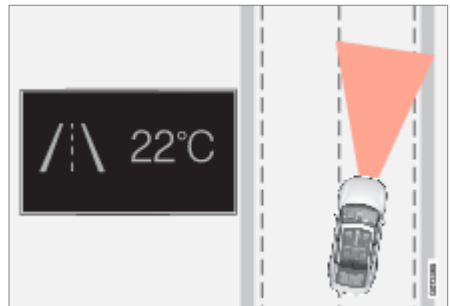

*Steering assistance/warning – the symbol turns coloured.*

Lane assistance indicates that the system is giving a warning and/or attempting to steer the car back into the lane.

# Difference between Pilot Assist and lane assistance

## Related information

- Lane assistance (p. 284)
- Limitations of Lane assistance (p. 287)

Pilot Assist is a comfort function that can help you to keep your car within its own lane and maintain a safe distance from vehicles in front of you. Lane assistance (LKA<sup>97</sup>) is a function which, in a similar way, can help you in some situations to reduce the risk of your car accidentally leaving its own lane.

## Pilot Assist



Pilot Assist can help you to steer your car between the lane markings, as well as to maintain a preset speed and time interval to the vehicle ahead. The function can also help to maintain an advantageous position in the lane using the lane's lane lines.

### What does Pilot Assist do?

- Can help to keep the car within its lane by assisting steering in some cases.
- Can help to maintain a preset speed or the distance to the vehicle ahead by means of acceleration and braking operations.

### How do I know when Pilot Assist is operational?

Symbols in the driver display in the car indicate when adaptive cruise control and Pilot Assist are operational.

	Both functions are selected but not active.
	Adaptive cruise control is active. Pilot Assist is selected but not available. The conditions for the function are not met.
	Both functions are active.



An extinguished symbol in the driver's display means that the function is running but the conditions for LKA have not been met.



A white symbol in the driver's display means that the conditions for LKA have been met and that the function is available.



A coloured symbol in the driver's display means that LKA is providing steering assistance back in to the lane and/or will provide warnings using acoustic signals or steering wheel vibration.

## Lane assistance

Lane assistance<sup>97</sup> can provide steering assistance and/or give you an alert when the vehicle is about to leave its own lane unintentionally. This function is active in the speed range 65-200 km/h (40-125 mph) on roads with clearly visible lane lines.

### What does lane assistance do?

- Lane assistance can provide the driver with steering assistance, steering the car back into its lane and/or providing warnings using acoustic signals or steering wheel vibration.

### How do I know when lane assistance is operational?

Symbols in the driver's display in the car show the status of the function.

### Related information

- Driving support systems (p. 242)
- Pilot Assist\* (p. 268)
- Lane assistance (p. 284)

## Assistance at risk of collision<sup>98</sup>

### WARNING

- The function is supplementary driver support intended to facilitate driving and make it safer – it cannot handle all situations in all traffic, weather and road conditions.
- The driver is advised to read all sections in the Manual that relate to this function to learn about factors such as its limitations and what the driver should be aware of before using the system.
- Driver support functions are not a substitute for the driver's attention and judgement. The driver is always responsible for ensuring the car is driven in a safe manner, at the appropriate speed, with an appropriate distance to other vehicles, and in accordance with current traffic rules and regulations.

Assistance at risk of collision<sup>99</sup> can assist the driver to avoid a collision via a warning, automatic braking and steering assistance.

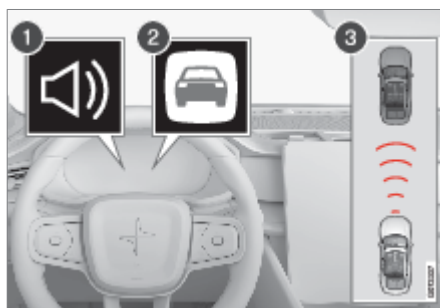

#### Function overview

- ① Light signal in the event of a risk of collision
- ② Warning signal in the event of a risk of collision
- ③ Distance measurement with the camera unit and radar unit

The driver or passengers are not normally aware of the function - it only intervenes in a situation where a collision is immediately imminent.

The function can help the driver to avoid a collision when driving in queues, e.g. when changes in the traffic ahead, combined with a lapse in attention, could lead to an incident. The function then activates a short, sharp braking procedure, normally stopping the car just behind the vehicle ahead.

The function cannot be deactivated but is always activated. However, system sensitivity can be selected.

## Subfunctions

Assistance at risk of collision can perform the following functions if necessary:

- Collision warning
- Assisted braking
- Automatic braking
- Steering assistance

### Step 1 – Collision warning

In the event of a risk of collision with a pedestrian, cyclist or vehicle, the driver's attention is alerted by means of a visual, acoustic and brake pulse warning. At lower speeds or with heavy braking or acceleration there will be no brake pulse warning as the intensity of the brake pulse varies with the speed of the car.

### Step 2 – Assisted braking

Assisted braking reinforces the driver's braking action if the system considers that the braking is not sufficient to avoid a collision.

### Step 3 – Automatic braking

If the driver has not started to take evasive action and the risk of collision is imminent then the automatic braking function is deployed - this takes place regardless of whether the driver brakes. Braking then takes place with full brake force in order to reduce collision speed, or with limited brake force if it is sufficient to avoid a collision.

The seatbelt tensioner can be activated in connection with the engagement of the automatic brake function.

The function is designed to be activated as late as possible in order to avoid unnecessary intervention. Automatic braking takes place only after or at the same time as the collision warning.

When automatic braking has prevented a collision with a stationary object, the car remains stationary in anticipation of positive action by the driver. If the car has been braked to avoid collision with a slower vehicle in front, its speed is reduced to match that of the vehicle in front.

The driver can always interrupt a braking intervention by firmly depressing the accelerator pedal.

When the function is activated and brakes, the brake lights are switched on. The driver display shows a text message to advise that the function is or has been active.

### Steering assistance

The function can help the driver reduce the risk of the car leaving its lane unintentionally or colliding with another vehicle or obstacle by actively steering the car back into its lane or swerving. Steering assistance is not part of a sequence but can be applied regardless of when the other steps occur.

After automatic engagement, the driver display indicates that this has occurred via a text message.

### Related information

- Driving support systems (p. 242)
- Obstacle detection with assistance at risk of collision (p. 294)
- Option to reduce speed with assistance at risk of collision (p. 296)
- Limitations for assistance at risk of collision (p. 297)
- Selecting sensitivity for assistance at risk of collision (p. 299)
- Assistance at risk of collision in crossing traffic (p. 300)

- Assistance at risk of collision in oncoming traffic (p. 301)
- Assistance at risk of run-off (p. 303)

## WARNING

- The function must not be used by the driver to change his/her driving style - the driver must not rely on function alone and allow it to do the braking.
- The function is supplementary driver support intended to facilitate driving and make it safer – it cannot handle all situations in all traffic, weather and road conditions.
- The driver is advised to read all sections in the Manual that relate to this function to learn about factors such as its limitations and what the driver should be aware of before using the system.
- Driver support functions are not a substitute for the driver's attention and judgement. The driver is always responsible for ensuring the car is driven in a safe manner, at the appropriate speed, with an appropriate distance to other vehicles, and in accordance with current traffic rules and regulations.

## NOTE

It is always the driver who decides how much the car should steer – the car can never take command.

# Obstacle detection with assistance at risk of collision

Assistance at risk of collision<sup>100</sup> can detect vehicles, cyclists and pedestrians.

The function can detect pedestrians, cyclists or vehicles that are stationary or moving in the same direction as the car and are ahead. The function can also detect pedestrians or cyclists that are crossing the road in front of the car.

## Vehicles

In order that the function shall be able to detect a vehicle in the dark, the vehicle's front and rear lights must be working and clearly illuminated.

## Cyclists



*Examples of what the function interprets as a cyclist — with clear body outline and bicycle outline.*

Good performance requires that the camera and radar units that detect a cyclist must receive the clearest possible information about the body and bicycle outline, requiring the ability to identify the bicycle, head, arms, shoulders, legs, upper and lower body plus a normal human pattern of movement.

If large parts of the cyclist's body or bicycle are not visible to the function's camera then the system cannot detect a cyclist.

For the function to be able to detect a cyclist, he/she must be an adult and riding a bicycle designed for adults.

## Pedestrians

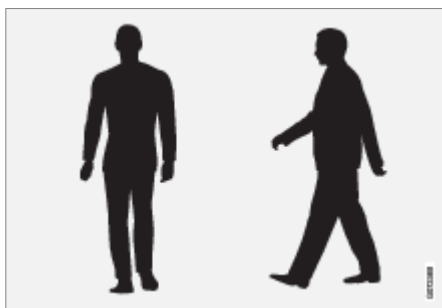

*Examples of what the function regards as pedestrians with clear body outlines.*

Good performance requires that the camera and radar units that detect a pedestrian must receive the clearest possible information about the body outline, requiring the ability to identify the head, arms, shoulders, legs, upper and lower body plus a normal human pattern of movement.

In order that it shall be possible to detect a pedestrian there must be a contrast with the background and this will be affected by such things as clothes, the background and the weather. With poor contrast the pedestrian may either be detected late or not at all, which may mean that warnings and braking are late or omitted.

The function can also detect pedestrians in the dark if they are illuminated by the car's headlamps.

## Related information

- Assistance at risk of collision (p. 292)
- Limitations for assistance at risk of collision (p. 297)

## WARNING

- The warning and application of the brake may be delayed, or not happen at all. The driver is always responsible that the vehicle is driven correctly and with a safety distance adapted to the speed.
- The function is a supplementary driver support, but it cannot detect all cyclists in all situations and, for example, cannot see:
  - partially obscured cyclists.
  - cyclists who do not stand out against the background.
  - cyclists wearing clothing that obscures the body outline.
  - bicycles loaded with large objects.

# Option to reduce speed with assistance at risk of collision

## WARNING

- The function is a supplementary driver support, but it cannot detect all pedestrians in all situations and, for example, cannot see:
  - partially obscured pedestrians, people in clothing that hides their body contour or pedestrians shorter than 80 cm (32 tum).
  - pedestrians who do not stand out against the background.
  - pedestrians who are carrying larger objects.

Assistance at risk of collision<sup>101</sup> can help to prevent a collision or reduce the collision speed.

If the speed difference between the driver's car and the obstacle is greater than the following specified speeds, the automatic brake function cannot prevent a collision but it can mitigate the consequences of a collision.

### Vehicles

For a vehicle in front, brake assistance can reduce the speed by up to 60 km/h (37 mph).

### cyclists

For a cyclist, brake assistance can reduce the speed by up to 50 km/h (30 mph).

### Pedestrians

For a pedestrian, brake assistance can reduce the speed by up to 45 km/h (28 mph).

### Related information

- Assistance at risk of collision (p. 292)
- Limitations for assistance at risk of collision (p. 297)
- Seatbelt tensioner (p. 35)



# Limitations for assistance at risk of collision

Assistance at risk of collision<sup>102</sup> has certain limitations that a driver needs to know about.

## Limitations of brake assistance

### Extra equipment

Low-hanging objects, e.g. a flag/pennant for projecting load, or accessories such as auxiliary lamps and bull bars that are higher than the car's bonnet, limit the function as they may obstruct the camera or radar unit.

### Skidding

On slippery road surfaces the braking distance is extended, which may reduce the capacity of the function to avoid a collision. In such situations, the anti-lock brakes and the stability control ESC<sup>103</sup> are designed to give the best possible braking force with maintained stability.

### Low speed

The function is not activated at very low speeds - below 4 km/h (3 mph) - and the system therefore does not intervene in situations where your car is approaching a vehicle ahead very slowly, e.g. when parking.

### Active driver

The driver's commands are always prioritised. In situations where the driver is steering and accelerating in a decisive manner, the function does not intervene, even if a collision is unavoidable. Active and aware driving behaviour can therefore delay a collision warning and intervention in order to minimise unnecessary warnings.

## Limitations of steering assistance

In certain situations the function may have limited functionality and fail to intervene in the following cases, for example:

- for small vehicles, such as motorcycles
- if the majority of the car has steered into the adjacent lane
- on roads/in lanes with unclear or non-existent lane markings
- outside the speed range 60-140 km/h (37-87 mph)
- as the steering servo for speed-dependent steering wheel resistance is working at reduced power – e.g. when cooling due to overheating.

Other demanding situations can include:

- road works
- winter road conditions
- narrow roads
- poor road surface
- a very "sporty" driving style
- poor weather with reduced visibility.

In these demanding situations the function may have difficulty in helping the driver in the right way.

## Important warnings

### Related information

- Assistance at risk of collision (p. 292)
- Limitations for camera unit (p. 341)
- Limitations for radar device (p. 329)
- Polestar Support (p. 9)

## WARNING

- Driver support systems only warn of obstacles which their camera and radar units have detected – hence a warning may not be given, or it may be given with a certain delay.
- Never wait for a warning or intervention. Apply the brakes when the situation requires.
- Automatic braking can prevent a collision or reduce collision speed, but to ensure full brake performance the driver should always depress the brake pedal – even when the car brakes automatically.
- The warning and steering assistance are only activated if there is a high risk of collision – you must therefore never wait for a collision warning or for the function to intervene.
- The function does not activate any automatic brake interventions in the event of heavy acceleration.

## WARNING

- Warnings and brake interventions could be implemented late or not at all if a traffic situation or external influences mean that the camera unit and radar unit cannot detect pedestrians, cyclists or vehicles correctly.
- For vehicles to be detected at night, their headlamps and rear lamp cluster must be switched on and shining clearly.
- Warnings for stationary and slow-moving vehicles could be disengaged due to darkness or poor visibility.
- Warnings and brake interventions for pedestrians and cyclists are deactivated at vehicle speeds exceeding 80 km/h (50 mph).
- The system can provide effective warnings and brake interventions as long as the relative speed is below 50 km/h (30 mph).
- For stationary or slow-moving vehicles, warnings and brake interventions are effective at vehicle speeds up to 70 km/h (43 mph).

## IMPORTANT

Driver support components must only be maintained at a workshop – contact Polestar Support.



# Selecting sensitivity for assistance at risk of collision

## NOTE

This function uses the car's camera and/or radar units, which have certain general limitations.

Assistance at risk of collision<sup>104</sup> is always activated but the driver can select the sensitivity for the system, which regulates the distance for activating warnings and interventions.

To change setting:

1. Tap on  in the centre display.
2. Press Assist.
3. Tap on  for assistance at risk of collision and select the desired setting.

When warnings are perceived as being too frequent then sensitivity can be reduced, which reduces the number of warnings, but also means that the function warns at a later stage. The setting with latest warning should therefore only be used in exceptional cases, such as in dynamic driving.

## Related information

- Assistance at risk of collision (p. 292)
- Limitations for assistance at risk of collision (p. 297)
- Rear Collision Warning\* (p. 305)

## Assistance at risk of collision in crossing traffic

### WARNING

- No automatic system can guarantee 100 % correct function in all situations. Therefore, never test the function by driving at people or vehicles - this may cause severe damage and injury and risk lives.
- The function warns the driver when there is a risk of a collision, but it cannot shorten the driver's reaction time.
- Even if the setting for early warning has been selected, warnings could be perceived as being late in certain situations, e.g. when there are large differences in speed or if vehicles ahead suddenly brake heavily.
- When the setting for early warning is selected, the warnings are given with more advance notice. This may mean that the warnings are given more frequently than with another setting, but it is recommended since it can make the function more effective.

Assistance at risk of collision<sup>105</sup> can help the driver when turning and crossing the path of another oncoming vehicle at an intersection.

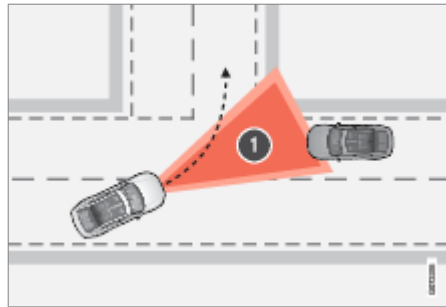

- ① Sector in which the function can detect oncoming crossing vehicles.

For the function to detect an oncoming vehicle on a collision course, the oncoming vehicle must first enter the sector in which the function can analyse the situation.

The following is also required:

- your car must be travelling at no less than 4 km/h (3 mph).
- your car must turn to the left in markets with right-hand traffic (or to the right in left-hand traffic).
- The oncoming vehicle must have its head-lamps switched on.

The function may have difficulty in assisting the driver if, for example:

- there are slippery conditions and stability control ESC intervenes.
- the oncoming vehicle is detected too late.
- the oncoming vehicle is obscured by something.

# Assistance at risk of collision in oncoming traffic

- the oncoming vehicle has headlamps switched off.
- the oncoming vehicle drives in an unpredictable manner, e.g. abruptly changes lanes at a late stage.

## Related information

- Assistance at risk of collision (p. 292)
- Limitations for assistance at risk of collision (p. 297)

## NOTE

This function uses the car's camera and/or radar units, which have certain general limitations.

Assistance at risk of collision<sup>106</sup> can assist the driver with steering assistance in order to avoid a collision with vehicles in the oncoming lane.

## If drifting over to the oncoming lane

The function can assist a distracted driver who does not notice that the car is moving across into the oncoming lane.

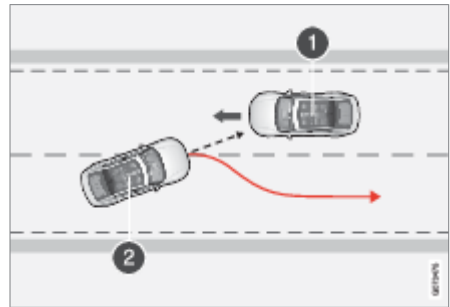

The function can assist by guiding the car back to its own lane.

- ① Oncoming vehicles
- ② Your car

The function is active within the speed range 60-140 km/h (37-87 mph) on roads with clearly visible lane markings/lines.

If the car is about to leave its own lane while an oncoming vehicle is approaching at the same time, the function can help the driver to steer the car back into its own lane.

However, the function does not intervene with steering assistance if the direction indicator is used. If the function detects that the driver is actively driving the car, activation of the function will be delayed.

>>

Driver support 301

# Assistance at risk of rear-end collision

## Related information

- Assistance at risk of collision (p. 292)
- Limitations for assistance at risk of collision (p. 297)

## WARNING

Warnings and brake interventions due to an impending collision with an oncoming vehicle always come very late.

## NOTE

This function uses the car's camera and/or radar units, which have certain general limitations.

Assistance at risk of rear-end collision<sup>107</sup> can help a driver who does not notice that the car is about to leave its own lane while an oncoming vehicle is approaching at the same time, either from behind or in the blind spot.

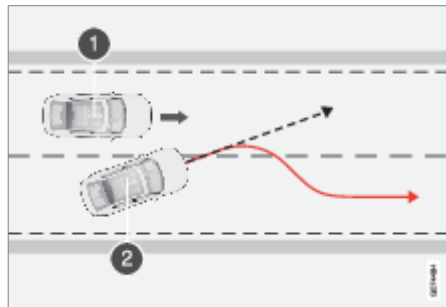

The function can assist by steering the car back to its own lane.

- ① Other vehicle in the blind spot
- ② Your car

The function can even assist if the driver intentionally changes lanes using direction indicators without noticing that another vehicle is approaching.

The function is active within the speed range 60-140 km/h (37-87 mph) on roads with clearly visible lane markings/lines.

The lamps in the door mirrors flash during steering intervention, regardless of whether BLIS<sup>108</sup> is activated. An acoustic signal can also be heard.

## Related information

- Assistance at risk of collision (p. 292)
- Limitations for assistance at risk of collision (p. 297)

# Assistance at risk of run-off

- BLIS (p. 306)

Assistance at risk of collision<sup>109</sup> can help the driver and reduce the risk of the car accidentally leaving the road by actively steering the car back onto the road.

The function has two levels for intervention:

- Steering assistance only
- Steering assistance with brake intervention

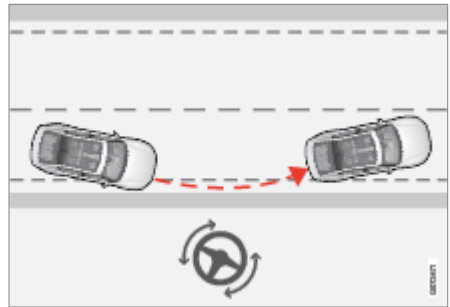

*Intervention with steering assistance*

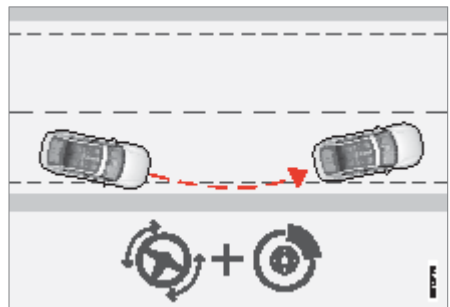

*Intervention with steering assistance and braking*

Brake intervention helps in situations where steering assistance alone is not sufficient. The brake force is adapted automatically depending on the situation at the time of road run-off.

>>

# Symbols and messages for assistance upon risk of collision

The function is active within the speed range 65-140 km/h (40-87 mph) on roads with clearly visible lane markings/lines.



The car's camera unit scans the edges of the road and the painted side markings. If the car is about to leave the side of the road, the car is steered back onto the road and if the steering intervention is not enough to avoid run-off, the brakes are also activated.

However, the function does not intervene with either steering assistance or brake intervention if the direction indicators are used. If the function detects that the driver is actively driving the car, activation of the function will be delayed.

A number of symbols and messages regarding assistance at risk of collision<sup>110</sup> control can be shown in the driver display. Here are some examples.

## Related information

- Assistance at risk of collision (p. 292)
- Limitations for assistance at risk of collision (p. 297)

Symbol	Message	Specification
	Automatic intervention Collision Avoidance	When the function is activated, a message is shown to the driver indicating that the system has been activated.
	Windscreen sensor blocked See Manual	The ability of the camera to scan the roadway in front of the car is reduced.

A text message can be cleared by briefly pressing the  button, located in the centre of the steering wheel's right-hand keypad.

If you still see a message, please contact Polestar Support.

## Related information

- Assistance at risk of collision (p. 292)
- Limitations for assistance at risk of collision (p. 297)
- Polestar Support (p. 9)



# Rear Collision Warning

The Rear Collision Warning<sup>111</sup> (RCW) function can help the driver to avoid being hit by a vehicle approaching from behind.

Drivers in vehicles behind can be warned about an imminent collision by the function flashing intensively with the direction indicators.

If, at a speed below 30 km/h (20 mph), the function detects that the car is in danger of being hit from behind, the seatbelt tensioners may tension the front seatbelts.

The Whiplash Protection System is also activated in the event of a collision.

Immediately before a collision from behind, this function may also activate the foot brake in order to reduce the forward acceleration of the car during the collision. However, the foot brake is only activated if the car is stationary. The foot brake releases immediately if the accelerator pedal is depressed.

This function is activated automatically each time the engine is started.

## Related information

- Driving support systems (p. 242)
- Limitations of Rear Collision Warning\* (p. 306)
- Whiplash Protection System (p. 30)

## WARNING

- The function is supplementary driver support intended to facilitate driving and make it safer – it cannot handle all situations in all traffic, weather and road conditions.
- The driver is advised to read all sections in the Manual that relate to this function to learn about factors such as its limitations and what the driver should be aware of before using the system.
- Driver support functions are not a substitute for the driver's attention and judgement. The driver is always responsible for ensuring the car is driven in a safe manner, at the appropriate speed, with an appropriate distance to other vehicles, and in accordance with current traffic rules and regulations.

<sup>111</sup> The function is not available in all markets.

# Limitations of Rear Collision Warning<sup>112</sup>

In certain cases the Rear Collision Warning (RCW) may have difficulty helping the driver in the event of a collision risk.

This can, for example, be if:

- the vehicle approaching from behind is detected too late
- the vehicle approaching from behind changes lane at the last moment.
- a trailer, bicycle rack or similar is connected to the car's electrical system – the function is then deactivated automatically.

## Related information

- Rear Collision Warning\* (p. 305)
- Limitations for camera unit (p. 341)
- Limitations for radar device (p. 329)

## NOTE

- In certain markets, RCW does not give a warning with the direction indicators due to local traffic regulations - in such cases, this part of the function is deactivated.
- This function uses the car's camera and/or radar units, which have certain general limitations.

# BLIS

The BLIS<sup>113</sup> function is intended to help the driver detect vehicles diagonally behind and to the side of the car so as to provide assistance in heavy traffic on roads with several lanes in the same direction.



Location of BLIS lamp

BLIS is a driver aid intended to give a warning of:

- vehicles in the car's blind spot
- quickly approaching vehicles in the left and right lanes closest to the car.

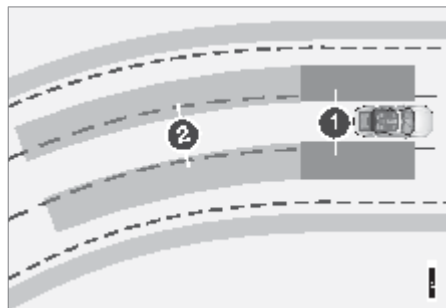

Principle of BLIS

- ① Zone in blind spot
- ② Zone for quickly approaching vehicle

The BLIS function is active at speeds above 10 km/h (6 mph).

The system is designed to react when:

- your car is overtaken by other vehicles
- another vehicle is quickly approaching your car.

When BLIS detects a vehicle in Zone 1 or a quickly approaching vehicle in Zone 2, the indicator lamp on the right or left-hand door mirror illuminates with a constant glow. If the driver activates the direction indicator on the same side as the warning, the indicator lamp will change over from a constant glow to flashing with a more intense light.

If passing vehicles drive more than 15 km/h (9 mph) faster than the driver's vehicle, BLIS will not react.

#### Related information

- Driving support systems (p. 242)
- Activating and deactivating BLIS (p. 308)
- Limitations of BLIS (p. 308)
- Messages for BLIS (p. 309)

## WARNING

- The function is supplementary driver support intended to facilitate driving and make it safer – it cannot handle all situations in all traffic, weather and road conditions.
- The driver is advised to read all sections in the Manual that relate to this function to learn about factors such as its limitations and what the driver should be aware of before using the system.
- Driver support functions are not a substitute for the driver's attention and judgement. The driver is always responsible for ensuring the car is driven in a safe manner, at the appropriate speed, with an appropriate distance to other vehicles, and in accordance with current traffic rules and regulations.

## NOTE

- The lamp illuminates on the side of the car where the system has detected the vehicle. If the car is overtaken on both sides at the same time then both lamps illuminate.
- This function uses the car's camera and/or radar units, which have certain general limitations.

## Activating and deactivating BLIS

The BLIS<sup>114</sup> function can be activated or deactivated.



Activate or deactivate the function using this button in the centre display under Assist.

- Button indication on – the function is activated.
- Extinguished button indication – the function is deactivated.

If BLIS is activated when starting the engine, the function is confirmed by the door mirror indicator lamps blinking once.

If BLIS was deactivated when the engine was switched off, it will continue to be deactivated when the engine is next started and no indicator lights will then be illuminated.

### Related information

- BLIS (p. 306)
- Limitations of BLIS (p. 308)

## Limitations of BLIS

The BLIS<sup>115</sup> function may have limitations in certain situations.



*Keep the surface indicated clean – on both the left and right-hand sides of the car.*

### Examples of limitations:

- Dirt, ice and snow covering the sensors may reduce the functions and deactivate alerts.
- The BLIS function is deactivated automatically if a trailer, bicycle rack or similar is connected to the car's electrical system.
- For good BLIS performance, bicycle racks, luggage holders or similar should not be mounted on the car's towbar.

### Related information

- BLIS (p. 306)
- Limitations for camera unit (p. 341)
- Limitations for radar device (p. 329)

# Messages for BLIS

## WARNING

- BLIS does not work on sharp bends.
- BLIS does not work when the car is reversing.

A number of messages regarding BLIS<sup>116</sup> can be shown in the driver display. Here are some examples.

## NOTE

This function uses the car's radar units, which have certain general limitations.

Message	Specification
Blind spot sensor Service required	The system does not function as it should. Contact Polestar Support.
Blind spot system off Trailer attached	BLIS and Cross Traffic Alert have been deactivated as a trailer has been connected to the car's electrical system.

A text message can be cleared by briefly pressing the  button, located in the centre of the steering wheel's right-hand keypad.

If you still see a message, please contact Polestar Support.

### Related information

- BLIS (p. 306)
- Warning and auto-brake while reversing\* (p. 312)
- Polestar Support (p. 9)

# Driver Alert Control

The Driver Alert Control (DAC) function is intended to help make the driver aware that he or she is starting to drive less consistently, e.g. if the driver becomes distracted or starts to fall asleep.

The objective of the function is to detect slowly deteriorating driving ability and it is primarily intended for major roads. The function is not intended for city traffic.

The function is activated when speed exceeds 65 km/h (40 mph) and remains active as long as the speed is over 60 km/h (37 mph).

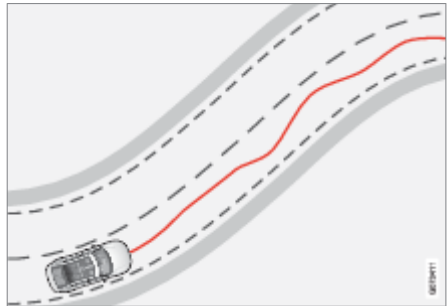

*The car is being driven erratically in the lane.*

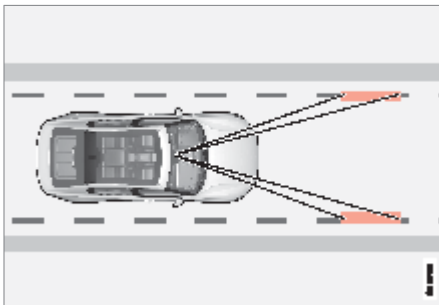

*Driver Alert Control reads the position of the car in the lane.*

A camera detects the edge markings painted on the carriageway and compares the alignment of the road with the driver's steering wheel movements.



If driving behaviour becomes noticeably inconsistent, the driver is alerted by this symbol in the driver display, combined with an acoustic signal and the text message *Time for a break Driver Alert*. The warning is

repeated after a time if driving behaviour has not improved.

## Related information

- Driving support systems (p. 242)
- Activating and deactivating Driver Alert Control (p. 311)
- Limitations of Driver Alert Control (p. 312)

## WARNING

- Driver Alert Control should not be used to extend a period of driving. The driver should instead plan for breaks at regular intervals and make sure they are well rested.

# Activating and deactivating Driver Alert Control

## WARNING

- The function is supplementary driver support intended to facilitate driving and make it safer – it cannot handle all situations in all traffic, weather and road conditions.
- The driver is advised to read all sections in the Manual that relate to this function to learn about factors such as its limitations and what the driver should be aware of before using the system.
- Driver support functions are not a substitute for the driver's attention and judgement. The driver is always responsible for ensuring the car is driven in a safe manner, at the appropriate speed, with an appropriate distance to other vehicles, and in accordance with current traffic rules and regulations.
- An alarm from Driver Alert Control should be taken very seriously, as a sleepy driver is often not aware of his/her own condition.

If the alarm sounds or you feel fatigued:

- Stop the car safely as soon as possible and rest.

Studies have shown that it is just as dangerous to drive while tired as it is to drive under the influence of alcohol or other stimulants.

The Driver Alert Control (DAC) function can be activated or deactivated.



Activate or deactivate the function using this button in the centre display under Assist.

- Button indication on – the function is activated.
- Extinguished button indication – the function is deactivated.

### Related information

- Driver Alert Control (p. 310)
- Limitations of Driver Alert Control (p. 312)

# Limitations of Driver Alert Control

The Driver Alert Control (DAC) function may have limitations in certain situations.

In some cases the system may issue a warning despite driving ability not deteriorating, for example:

- in strong side winds
- on rutted road surfaces.

## Related information

- Driver Alert Control (p. 310)
- Limitations for camera unit (p. 341)
- Limitations for radar device (p. 329)

## WARNING

In some cases, driving behaviour is not affected despite driver fatigue – e.g. when using the Pilot Assist function – resulting in the driver not getting a warning from DAC.

It is therefore important to always stop and take a break at the slightest feeling of fatigue, regardless of whether the function has given a warning.

## NOTE

This function uses the car's camera and/or radar units, which have certain general limitations.

# Warning and auto-brake while reversing

There are systems in the car that can assist the driver to detect obstacles when reversing and even brake automatically if the driver does not manage to act in time.

The Rear Auto Brake (RAB) and Cross Traffic Alert (CTA) functions are only active if the car rolls backwards or if reverse gear has been selected.

If obstacles are detected:

1. A warning signal and the parking assistance graphic illuminate to indicate the position of the obstacle.
2. If the driver does not pay attention to the warning and a collision is unavoidable, the car is auto-braked and an explanatory text message is shown for why the car was braked.

If the accelerator pedal is depressed forcefully, the car also reverses after braking automatically.

## Obstacles immediately behind

Rear Auto Brake is intended to help the driver detect stationary obstacles that may be directly behind the car when it is being reversed.

This function is primarily designed to detect stationary obstacles that are higher than the rear bumper – and not moving vehicles, for example.

Brake intervention with Rear Auto Brake is active at speeds below 10 km/h (6 mph).

Rear Auto Brake needs to be deactivated before a trailer, bicycle rack or similar is connected to the car.

## Obstacles from the side

Cross Traffic Alert is designed to help the driver detect traffic crossing behind the car when it is reversing.



This function is primarily designed to detect large moving vehicles. In favourable conditions, it may also be able to detect smaller objects, such as cyclists and pedestrians.

Brake intervention with Cross Traffic Alert is active at speeds below 15 km/h (9 mph).

Cross Traffic Alert is deactivated automatically if a trailer, bicycle rack or similar is connected to the car's electrical system.

#### Examples of detection and limitations

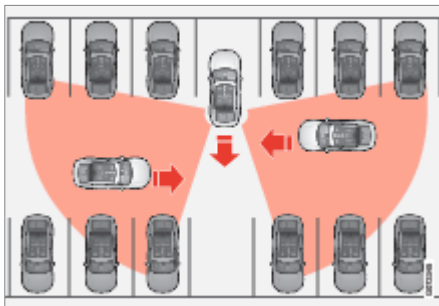

*Examples of areas where this function can assist the driver to detect obstacles during reversing.*

The function's sensors cannot detect moving traffic through other parked vehicles or bulky obstacles. Here are some examples of when approaching vehicles cannot therefore be detected until they are very close.

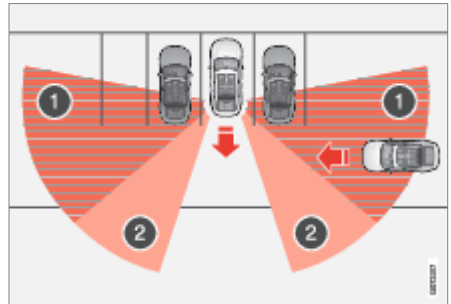

*The car is parked deep inside a parking slot.*

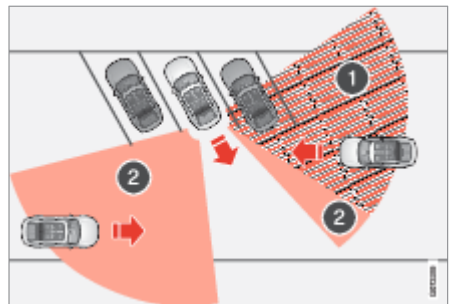

*In an angled parking slot, the sensors may be completely blocked on one side.*

- ① Blind sector
- ② Sector in which the function can detect

However, as your car slowly reverses, the angle it makes with the obstructing vehicle/object changes and the blind sector rapidly decreases.

#### Related information

- Driving support systems (p. 242)
- Activating and deactivating warning and auto-brake during reversing\* (p. 314)
- BLIS (p. 306)

>>

- Park Assist (p. 315)

## WARNING

- The functions are supplementary driver support intended to facilitate driving and make it safer – they cannot handle all situations in all traffic, weather and road conditions.
- The driver is advised to read all sections in the manual that relate to these functions in order to learn about factors such as limitations, among other things, and what the driver should be aware of before using the functions.
- Driver support functions are not a substitute for the driver's attention and judgement. The driver is always responsible for ensuring the car is driven in a safe manner, at the appropriate speed, with an appropriate distance to other vehicles, and in accordance with current traffic rules and regulations.

## NOTE

The functions use the car's detectors and radar units, which have certain general limitations.

# Activating and deactivating warning and auto-brake during reversing

The driver can choose to deactivate auto-brake with Rear Auto Brake (RAB) and Cross Traffic Alert (CTA). The warning signal can be deactivated separately.

### Warning signal



Activate or deactivate the warning signal using this button in the parking camera view.

### Auto brake



Activate or deactivate auto-brake using this button in the parking camera view.

- Button indication on – the function is activated.
- Extinguished button indication – the function is deactivated.

The functions are activated automatically each time the engine is started.

### Related information

- Warning and auto-brake while reversing\* (p. 312)
- Park assist camera (p. 321)

# Park Assist

The Park Assist Pilot function (PAS<sup>17</sup>) uses sensors to assist the driver when manoeuvring in tight spaces by indicating the distance to obstacles through acoustic signals combined with a graphic in the centre display.



Screen view showing obstacle zones and sensor sectors.

The centre display shows an overview of the relationship between the car and detected obstacles.

The highlighted sector indicates the location of the obstacle. The closer the car symbol is to a highlighted sector box at the front/back, the shorter the distance between the car and detected obstacle.

The side sectors change colour as the distance between the car and an object is reduced.



The shorter the distance to the obstacle, the faster the signal sounds. Other sound from the audio system is muted automatically.

The acoustic signal for obstacles ahead and to the sides is active when the car is moving but stops after the car has been stationary for approx. 2 seconds. The acoustic signal for obstacles behind is also active when the car is stationary.

At a distance within approx. 30 cm (1 foot) from an obstacle behind or in front of the car, the tone is constant and the active sensor field closest to the car symbol is filled.

At a distance within approx. 25 cm (0.8 foot) from an obstacle to the sides, the tone pulses intensively and the active sector field changes colour from ORANGE to RED.

The volume of the parking assistance signal can be adjusted while the signal is sounding by means of the [>||] knob on the centre console. Adjustment can also be performed in the Parking Assistance System settings.

1. Tap on  in the centre display.
2. Press Assist.
3. Tap on  for the Parking Assistance System and select the preferred setting.

## Related information

- Driving support systems (p. 242)
- Park Assist Pilot front, rear and along the sides (p. 316)
- Activating and deactivating parking assistance (p. 318)
- Symbols and messages for Park Assist Pilot (p. 320)
- Limitations for camera unit (p. 341)
- Limitations for radar device (p. 329)

## Park Assist Pilot front, rear and along the sides

### WARNING

- The function is supplementary driver support intended to facilitate driving and make it safer – it cannot handle all situations in all traffic, weather and road conditions.
- The driver is advised to read all sections in the Manual that relate to this function to learn about factors such as its limitations and what the driver should be aware of before using the system.
- Driver support functions are not a substitute for the driver's attention and judgement. The driver is always responsible for ensuring the car is driven in a safe manner, at the appropriate speed, with an appropriate distance to other vehicles, and in accordance with current traffic rules and regulations.

### NOTE

With the exception of the sector nearest to the car symbol, audible warnings are only given for objects directly in the path of the car.

Park Assist Pilot (PAS<sup>118</sup>) has different behaviour depending on which part of the car is approaching an obstacle.

#### Forwards

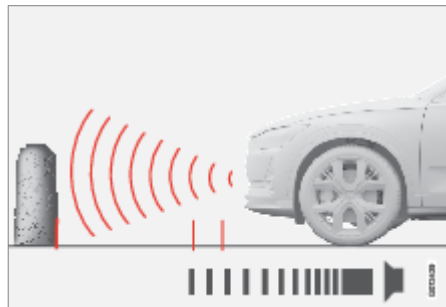

*The warning signal has a constant acoustic signal at less than approx. 30 cm (1 foot) from an obstacle.*

The Parking Assistance System's front detectors are activated automatically when the engine is started. They are active at speeds below 10 km/h (6 mph).

The measuring range is approx. 80 cm (2.5 feet) in front of the car.

## Backwards

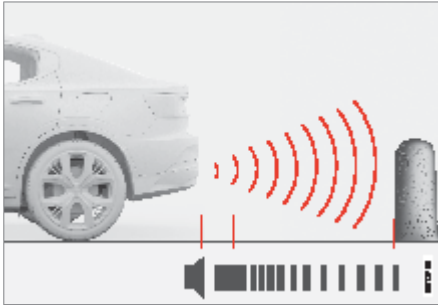

*The warning signal has a constant tone at less than approx. 30 cm (1 foot) from an obstacle.*

The sensors for reverse are activated if the car rolls backward without a gear engaged or when the gear lever is moved to reverse position.

The measuring range is approx. 1.5 metres (5 feet) behind the car.

Reversing with a trailer connected electrically to the car's electrical system automatically disables the Parking Assistance System to the rear.

## Along the sides

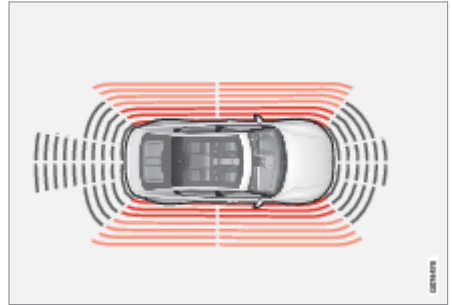

*The warning signal pulses intensively at less than approx. 25 cm (0.8 feet) from an obstacle.*

Parking assistance side sensors are activated automatically when the engine is started. They are active at speeds below 10 km/h (6 mph).

The measuring range is approx. 25 cm (0.8 feet) from the sides.

However, the detection range of the side sensors increases significantly when the steering angle of the front wheels is increased, and obstacles of up to approx. 90 cm (3 feet) located diagonally behind or in front of the car are detected when the steering wheel is turned.

## Related information

- Park Assist (p. 315)
- Sensor fields for parking assistance system (p. 326)

# Activating and deactivating parking assistance

## IMPORTANT

When auxiliary lamps are fitted: Remember that these must not obscure the sensors - the auxiliary lamps may then be perceived as an obstacle.

## NOTE

- The parking assistance system is deactivated when the parking brake is used.
- When reversing with a trailer or a bicycle rack, for example, on the towbar – without original Polestar trailer cabling – you may need to switch off the Parking Assistance System manually so that the sensors do not react to these.

The park assist function (PAS<sup>119</sup>) can be activated or deactivated.

The front and side parking assistance detectors are activated automatically when the engine is started. The rear detectors are activated if the car rolls backwards or when reverse gear is engaged.



Activate or deactivate the function using this button in the camera view.

- Button indication on – the function is activated.
- Extinguished button indication – the function is deactivated.

In cars equipped with a parking camera, the Parking Assistance System can also be activated or deactivated from the relevant camera view.

### Related information

- Park Assist (p. 315)
- Limitations of Parking assistance (p. 319)

# Limitations of Parking assistance

The parking assistance function (PAS<sup>120</sup>) cannot detect everything in all situations and may therefore have limited functionality in some cases.

A driver should be aware about the following examples of Park Assist Pilot's limitations.

## Related information

- Park Assist (p. 315)

## WARNING

- The parking sensors have blind spots where obstacles cannot be detected.
- Pay particular attention if there are people and animals near the car.
- Bear in mind that the front of the car may swing out towards oncoming traffic during the parking manoeuvre.



Pay particular attention when reversing as this symbol is displayed when a trailer, bicycle

rack or similar is attached and connected to the car's electrical system.

Extinguished symbol indicates that the park assist sensors to the rear are off, and so you will not be alerted to any obstacles.

## IMPORTANT

- Objects e.g. chains, thin glossy poles or low barriers may be in the "signal shadow" and are then temporarily not detected by the sensors – the pulsating tone may then unexpectedly stop instead of changing over to the expected constant tone.

The sensors cannot detect high objects, such as projecting loading docks.

- In such situations, pay extra attention and manoeuvre/reposition the car particularly slowly or stop the current parking manoeuvre - there may be a high risk of damage to vehicles or other objects since information from the sensors is not always reliable in such situations.
- In certain conditions the parking assistance system may produce incorrect warning signals that are caused by external sound sources with the same ultrasonic frequencies that the system works with.

Examples of such sources include horns, wet tyres on asphalt, pneumatic brakes, exhaust noises from motorcycles, etc.

# Symbols and messages for Park Assist Pilot

## NOTE

When a towbar is configured with the car's electrical system, the protrusion of the towbar is included when the function measures the distance to objects behind the car.

Symbols and messages for Park Assist Pilot (PAS<sup>121</sup>) can be shown in the driver display and/or the centre display. Here are some examples.

Symbol	Message	Specification
	If the symbol is extinguished.	The rearward parking assistance sensors are deactivated, so there are no acoustic warnings for obstacles/objects.
	Cleaning needed Park Assist System sensors blocked	One or more of the function's sensors are blocked - check and correct as soon as possible.
	Park Assist System unavailable Service required	The system does not function as it should. Contact Polestar Support.

A text message can be cleared by briefly pressing the  button, located in the centre of the steering wheel's right-hand keypad.

If you still see a message, please contact Polestar Support.

### Related information

- Park Assist (p. 315)
- Limitations of Parking assistance (p. 319)
- Polestar Support (p. 9)



# Park assist camera

The parking camera (PAC<sup>122</sup>) can assist the driver when manoeuvring in tight spaces by indicating obstacles with a camera image and graphics in the centre display.



*Example of camera view.*

- ① Settings
- ② Park assist lines
- ③ Activates all cameras to provide 360° view
- ④ Activates/deactivates parking assistance sensors
- ⑤ Activates/deactivates auto-brake while reversing

The parking camera is a support function which is activated automatically when reverse gear is selected or manually in the centre display.

## Related information

- Driving support systems (p. 242)
- Park assist camera locations and surveillance areas (p. 322)
- Park assist lines for park assist camera (p. 324)
- Sensor fields for parking assistance system (p. 326)
- Activate park assist camera (p. 327)
- Symbols and messages for Park assist camera (p. 328)
- Park Assist (p. 315)
- Warning and auto-brake while reversing\* (p. 312)
- Limitations for camera unit (p. 341)
- Limitations for radar device (p. 329)

## WARNING

- The parking sensors have blind spots where obstacles cannot be detected.
- Pay particular attention if there are people and animals near the car.
- Bear in mind that the front of the car may swing out towards oncoming traffic during the parking manoeuvre.
- Objects/obstacles may be closer to the car than they appear to be on screen.

## Park assist camera locations and surveillance areas

### WARNING

- The function is supplementary driver support intended to facilitate driving and make it safer – it cannot handle all situations in all traffic, weather and road conditions.
- The driver is advised to read all sections in the Manual that relate to this function to learn about factors such as its limitations and what the driver should be aware of before using the system.
- Driver support functions are not a substitute for the driver's attention and judgement. The driver is always responsible for ensuring the car is driven in a safe manner, at the appropriate speed, with an appropriate distance to other vehicles, and in accordance with current traffic rules and regulations.

The park assist cameras (PAC<sup>123</sup>) can display a composite 360° view and separate views for each of the four cameras: rear, front, left or right camera view. The cameras can be activated automatically or manually.

### 360° view



*Camera buttons for each direction of view. These buttons disappear after a short time without touching the screen.*

The 360° view function activates all parking cameras, whereupon the four sides of the car are shown simultaneously in the centre display, which helps the driver to observe what is around the car when manoeuvring at low speed. From the 360° view, each camera view can be activated separately. Tap on the screen to show the camera symbols and select the desired view.

## Backwards

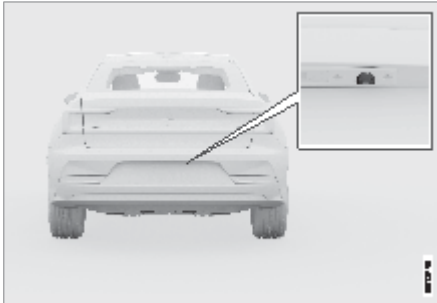

*The backwards-facing camera is fitted above the registration plate.*

The backward-facing camera shows a wide area behind the car. Part of the bumper may also be visible.

Objects shown in the centre display may appear slightly tilted — this is normal.

## Forwards

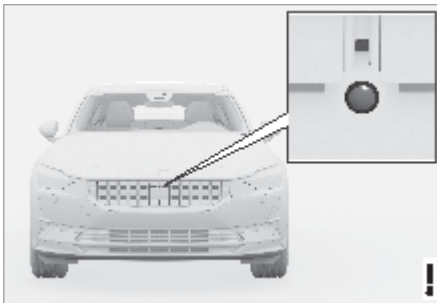

*The forwards parking camera is located in the grille.*

The front camera can be helpful on an exit road with limited visibility to the sides, e.g. when leav-

ing a garage. It is active at speeds up to 25 km/h (16 mph) - following which, the front camera is switched off.

If the car does not reach 50 km/h (30 mph) and the speed falls below 22 km/h (14 mph) within 1 minute after the forward-facing camera has been extinguished, the camera is reactivated.

## The sides

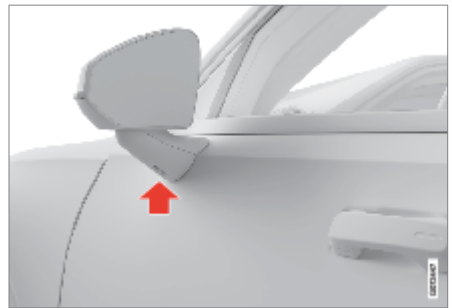

*The side cameras are positioned in each door mirror.*

The side cameras can show what is along each side of the car.

## Related information

- Park assist camera (p. 321)
- Activate park assist camera (p. 327)
- Limitations for camera unit (p. 341)
- Limitations for radar device (p. 329)

# Park assist lines for park assist camera

The parking cameras (PAC<sup>124</sup>) indicate the position of the car in relation to its surroundings by displaying lines on the screen.



*Example of park assist lines*

Park assist lines show the intended route for the car's external dimensions with the current steering wheel angle - this can facilitate parallel parking and reversing into tight spaces.

The lines on the screen are projected as if they were at ground level behind the car and respond directly to steering wheel movements, showing the driver the path the car will take - also when the car is turning.

These park assist lines include the car's most protruding parts, e.g. door mirrors and corners.

## Park assist lines in 360° view



*360° view with park assist lines*

With the 360° view, park assist lines are shown behind, in front of and at the side of the car (depending on the direction of travel):

- When driving forwards: Front lines
- When reversing: Side lines and reversing lines

With front or rear camera selected, the park assist lines appear regardless of the car's direction of travel.

With one side camera selected, the park assist lines only appear when reversing.

## Towbar park assist line



*Towbar with park assist line*

A park assist line for the towbar's intended trajectory can be shown and provide assistance when connecting a trailer. This is activated in the settings for the parking camera.

Park assist lines for the towbar and the whole of the car cannot be shown at the same time.

### Related information

- Park assist camera (p. 321)
- Park assist camera locations and surveillance areas (p. 322)
- Towbar\* (p. 397)
- Limitations for camera unit (p. 341)

- Limitations for radar device (p. 329)

## IMPORTANT

- Remember, that with the rear camera view selected, the monitor only displays the area behind the car. Be aware of the sides and front of the car when manoeuvring in reverse.
- The same applies vice versa - note what happens to the rear parts of the car when the front camera view is selected.
- Note that the park assist lines show the shortest route. Therefore, pay extra attention to the car's sides so that they do not go against/over something when the steering wheel is turned when driving forward or that the front sweeps against/over something when the steering wheel is turned when reversing.

## NOTE

- When reversing with a trailer that is not connected to the car's electrical system, the park assist lines on screen show you the route the car will take – not the trailer.
- The screen does not show park assist lines when a trailer is connected to the car's electrical system.

# Sensor fields for parking assistance system

If the car is equipped with the Parking Assistance System (PAS<sup>125</sup>) then the distance is shown in the Parking Assistance Camera (PAC<sup>126</sup>) 360° view with coloured fields for each sensor that registers an obstacle.

## Sensor fields backwards and forwards



The screen can show coloured sensor fields on the car symbol.

The fields for the sensors for forwards and reverse change colour as the distance to the

obstacle decreases – from AMBER through ORANGE to RED.

Field colour reverse	Distance in metres (feet)
Yellow	0,6-1,5 (2,0-4,9)
Orange	0,3-0,6 (1,0-2,0)
Red	0-0,3 (0-1,0)

Field colour for-wards	Distance in metres (feet)
Yellow	0,6-0,8 (2,0-2,6)
Orange	0,3-0,6 (1,0-2,0)
Red	0-0,3 (0-1,0)

For RED sensor fields, the pulsating acoustic signal changes over to a constant tone.

## Related information

- Park Assist (p. 315)
- Park assist camera (p. 321)
- Park assist camera locations and surveillance areas (p. 322)
- Limitations for camera unit (p. 341)
- Limitations for radar device (p. 329)

# Activate park assist camera

## WARNING

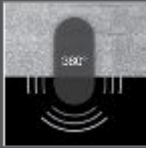

The sensor fields on the 360° symbol only show the direction of an obstacle's location. They do not show the dis-

tance to the obstacle.

The park assist cameras (PAC<sup>127</sup>) are activated automatically when reverse gear is engaged or manually with the centre display's function button.

### Camera view when reversing

When reverse gear is engaged, the screen shows the 360° view if it or any of the side views was the last used camera view, otherwise the rear view is shown.

### Camera view for manual camera activation



Activate the parking camera with this button in the upper part of the centre display.

The screen then initially shows the last used camera view.

However, after each engine start, the previously shown side view is replaced by the 360° view and the previously shown zoomed rear view is replaced by the rear view.

- Button indication on – the function is activated.
- Extinguished button indication – the function is deactivated.

### Automatic deactivation of camera

The front view extinguishes at 25 km/h (16 mph) to avoid distracting the driver – it reactivates automatically if the speed drops to 22 km/h (14 mph) within 1 minute, on the condition that the speed has not exceeded 50 km/h (31 mph).

Other camera views are extinguished at 15 km/h (9 mph) and are not reactivated.

>>



Driver support 327

# Symbols and messages for Park assist camera

## Related information

- Park assist camera (p. 321)
- Limitations of Parking assistance (p. 319)
- Limitations for camera unit (p. 341)
- Limitations for radar device (p. 329)

Symbols and messages for the park assist camera (PAC<sup>128</sup>) can be shown in the driver display and/or the centre display. Here are some examples.

Symbol	Message	Specification
	If the symbol is extinguished.	The rearward parking assistance sensors are deactivated, so there are no acoustic warnings and field marks for obstacles/objects.
		The camera is disengaged.
	Cleaning needed Park Assist System sensors blocked	One or more of the function's sensors are blocked - check and correct as soon as possible.
	Park Assist System unavailable Service required	The system does not function as it should. Contact Polestar Support.

A text message can be cleared by briefly pressing the  button, located in the centre of the steering wheel's right-hand keypad.

If you still see a message, please contact Polestar Support.

## Related information

- Park assist camera (p. 321)
- Polestar Support (p. 9)



# Radar unit

The radar unit is used by several driver support systems and has the task of sensing other vehicles.



*Location of front radar unit*

The radar unit is used by the following functions:

- Adaptive cruise control
- Pilot Assist
- Lane assistance
- Assistance at risk of collision

Modification of the radar unit could result in its use being illegal.

## Related information

- Driving support systems (p. 242)
- Limitations for radar device (p. 329)
- Limitations for camera unit (p. 341)
- Recommended maintenance for radar unit (p. 331)
- Symbols and messages for radar unit (p. 332)
- Type approval for radar device (p. 333)

# Limitations for radar device

The radar unit has certain limitations - which in turn also limits those functions that use the unit. A driver should be aware about the following examples of limitations.

## Blocked unit

The area in front of the radar unit must be cleaned on a regular basis and kept free from decals, objects, dirt, etc. – these could disrupt the radar-based functions. This may result functions being reduced, being switched off completely or giving incorrect function responses.

Wet snow or ice on the grille in front of the radar unit may disrupt radar-based functions. This may result functions being reduced, being switched off completely or giving incorrect function responses. The driver is always responsible for intervening in such a situation and maintaining a safe distance and speed.

## Vehicle speed

The radar unit's ability to detect a vehicle ahead is greatly reduced if the speed of the vehicle ahead is very different to the speed of your own car.

## Limited field of vision

The radar unit has a limited field of vision. In some situations another vehicle is not detected, or the detection is made later than expected.

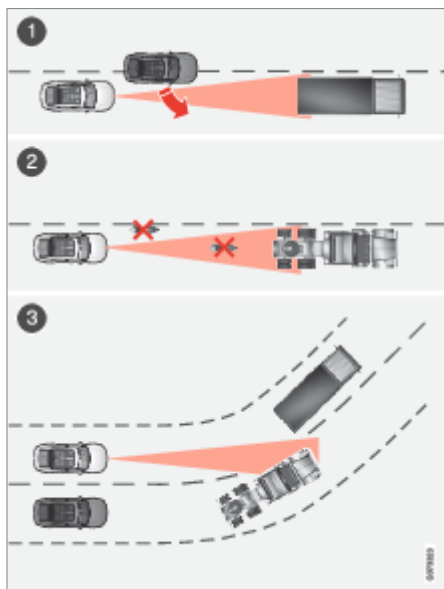

## Related information

- Radar unit (p. 329)
- Recommended maintenance for radar unit (p. 331)
- Polestar Support (p. 9)

### *The radar unit's field of vision*

- 1 Sometimes the radar unit is late at detecting vehicles at close distances - e.g. a vehicle that drives in between your car and the vehicle ahead.
- 2 Small vehicles, such as motorcycles, or vehicles not driving in the centre of the lane can remain undetected.
- 3 In bends, the radar unit may detect a different vehicle than intended or lose a detected vehicle from view.

Do not fit anything in front of the radar unit such as auxiliary lamps, decals, etc., since these may disrupt radar-based functions. This may result functions being reduced, being switched off completely or giving incorrect function responses.

# Recommended maintenance for radar unit

In order that the radar unit shall function correctly, it must be kept clear of dirt, ice and snow, and be cleaned regularly with water and car shampoo.

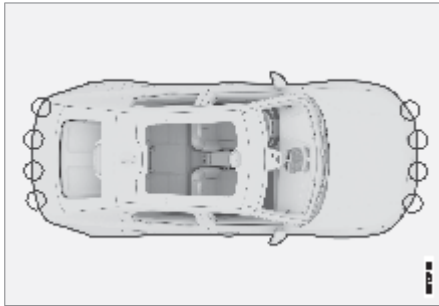

*Location of the parking sensors*



*Location of front radar units*



*Location of rear radar units*

- To ensure best possible functionality, the surfaces in front of the sensors must be kept clean.
- Do not affix any objects, tape or labels in the area of the sensors.

## Related information

- Radar unit (p. 329)
- Limitations for radar device (p. 329)
- Limitations for camera unit (p. 341)
- Polestar Support (p. 9)

## IMPORTANT

Driver support components must only be maintained at a workshop – contact Polestar Support.

# Symbols and messages for radar unit

## NOTE

Dirt, ice and snow covering the sensors may cause incorrect warning signals, reduced or no function.

Here are examples of some of the messages and symbols relating to the radar unit that may be shown in the driver display.

### Sensor blocked



If the driver display shows this symbol and the message Windscreen sensor Sensor blocked, see Manual, this means that the radar unit cannot detect other vehicles, cyclists, pedestrians and large

animals in front of the car, and that the car's camera and radar-based functions may be disrupted.

The following table presents examples of possible causes for a message being shown, along with the appropriate action:

Cause	Action
The surface in front of the radar unit is dirty or covered with ice or snow.	Clean the surface in front of the radar unit.
Thick fog and heavy rain or snow block the radar signals.	No action. Sometimes the unit does not work during heavy rain or snowfall.
Water or snow from the road surface swirls up and blocks the radar signals.	No action. Sometimes the unit does not work on a very wet or snow-covered road surface.



### Related information

- Radar unit (p. 329)
- Polestar Support (p. 9)

# Type approval for radar device

Type approvals can be found here for the car's radar units for adaptive cruise control (ACC<sup>129</sup>), Pilot Assist and BLIS<sup>130</sup>.





Market	ACC & PA	BLIS	Symbol	Type approval
Brazil	✓			Este equipamento não tem direito à proteção contra interferência prejudicial e não pode causar interferência em sistemas devidamente autorizados. 06354-19-12386
		✓		Este equipamento não tem direito à proteção contra interferência prejudicial e não pode causar interferência em sistemas devidamente autorizados. 03563-17-05364



Market	ACC & PA	BLIS	Symbol	Type approval
Europe	✓			<p>Hereby, Veoneer US, Inc. declares that the radio equipment type 77V12FLR is in compliance with Directive 2014/53/EU.</p> <p>Operational frequency band: 76-77 GHz</p> <p>Maximum Output Power: &lt;55dBm EIRP</p> <p>The full text of the EU declaration of conformity is available at the following internet address: <a href="https://www.veoneer.com/en/regulatory">https://www.veoneer.com/en/regulatory</a></p> <p>Manufacturer: Veoneer US, Inc. 26360 American Drive Southfield, MI 48034 USA Phone: +1-248-223-0600</p>
		✓		<p>Hereby, Hella KgaA Hueck &amp; Co. Declares that the radio equipment type RS4 is in compliance with Directive 2014/53/EU.</p> <p>The full text of the EU declaration of conformity is available at the following internet address: <a href="http://www.hella.com/vcc">www.hella.com/vcc</a>.</p> <p>Technical information: Frequency range: 24.05 ... 24.25 GHz Transmission power: 20 dBm (maximum) EIRP</p> <p>Manufacturer and Address: Manufacturer: Hella KGaA Hueck &amp; Co. Address: Rixbecker Straße 75, 59552 Lippstadt, Germany</p>
The United Arab Emirates (UAE)	✓			REGISTERED No: ER72325/19
		✓		DEALER No: 0020858/10 Registered No: ER53878/17 Dealer No: DA44932/15
Ghana	✓			NCA Approved: ZRO-1H-7E3-145
		✓		NCA Approved: 1R3-1M-7E1-0B7



Market	ACC & PA	BLIS	Symbol	Type approval
Indonesia		✓		<p>Certificate number: 50459/SDPPI/2017</p> <p>Country of origin Germany</p> <p>Certificate number: 53578/SDPPI/2017</p> <p>Country of origin China</p> <p>PLG ID: 6051</p>
Japan	✓			<p>This device is granted pursuant to the Japanese Radio Law under the grant ID n°: R 215-JRA003 This device should not be modified (otherwise the granted designation number will become invalid).</p> <p>本製品は、電波法に基づく特定無線設備の技術基準適合証明などを受けております。認証番号: R 215-JRA003 本製品の改造は禁止されています。(適合証明番号などが無効となります。)</p>
		✓		<p>This device is granted pursuant to the Japanese Radio Law under the grant ID n°: R 204-750001 This device should not be modified (otherwise the granted designation number will become invalid).</p> <p>本製品は、電波法に基づく特定無線設備の技術基準適合証明などを受けております。認証番号: R 204-750001 本製品の改造は禁止されています。(適合証明番号などが無効となります。)</p>
Jordan		✓		<p>Type Approval No.: TRC/LPD/2017/63</p> <p>Equipment Type: Low Power Device (LPD)</p>
Malaysia		✓		CID F 15000578

Market	ACC & PA	BLIS	Symbol	Type approval
Morocco	✓			AGREE PAR L'ANRT MAROC Numéro d'agrément: MR_20098_ANRT_2019 Date d'agrément: 2019_06_14
		✓		AGREE PAR L'ANRT MAROC NUMÉRO D'AGRÉMENT: MR 9929 ANRT 2014 DATE D'AGRÉMENT: 26/12/2014
Mexico	✓			IFT: RLVVE7719-1064  La operación de este equipo está sujeta a las siguientes dos condiciones: (1) es posible que este equipo o dispositivo no cause interferencia perjudicial y (2) este equipo o dispositivo debe aceptar cualquier interferencia, incluyendo la que pueda causar su operación no deseada.
		✓		Radar de corto alcance RS4 Hella KGaA Hueck & Co IFETEL: RLVHERS17-0286  La operación de este equipo esta sujeta a las siguientes dos condiciones: (1) es posible que este equipo o dispositivo no cause interferencia perjudicial y (2) este equipo o dispositivo debe aceptar cualquier interferencia, incluyendo la que pueda causar su operación no deseada.
Moldova	✓	✓		



Market	ACC & PA	BLIS	Symbol	Type approval
Nigeria	✓	✓		Connection and use of this communications equipment is permitted by the Nigerian Communications Commission.
Oman	✓			Registered No: R/7713/19 Dealer No: D172338
		✓		Registered No: R/3957/17 Dealer No: D080134
Paraguay	✓			NR: 2019-07-I-0397
Serbia	✓			I01119
		✓		I01117
Singapore	✓			DA 106706
		✓		DA 103238
South Africa	✓			TA-2019/1378APPROVED
		✓		TA-2016/3407APPROVED

Market	ACC & PA	BLIS	Symbol	Type approval
South Korea		✓		R-CMM-HLA-RS4 이 기기는 업무용(A급) 전자파 적합기기로서 판매자 또는 사용자는 이 점을 주의하시기 바라며, 가정외의 지역에서 사용하는 것을 목적으로 합니다
Taiwan	✓			CCA119LP2310T1 警語 經型式認證合格之低功率射頻電機,非經許可,公司、商號或使用者均不得擅自變更頻率、加大功率或變更原設計之特性及功能。低功率射頻電機之使用不得影響飛航安全及干擾合法通信,經發現有干擾現象時,應立即停用,並改善至無干擾時方得繼續使用。前項合法通信,指依電信法規定作業之無線電通信。低功率射頻電機須忍受合法通信或工業、科學及醫療用電波輻射性電機設備之干擾
		✓		CCAB17LP0470T5 警語 經型式認證合格之低功率射頻電機,非經許可,公司、商號或使用者均不得擅自變更頻率、加大功率或變更原設計之特性及功能。低功率射頻電機之使用不得影響飛航安全及干擾合法通信,經發現有干擾現象時,應立即停用,並改善至無干擾時方得繼續使用。前項合法通信,指依電信法規定作業之無線電通信。低功率射頻電機須忍受合法通信或工業、科學及醫療用電波輻射性電機設備之干擾

Market	ACC & PA	BLIS	Symbol	Type approval
Ukraine	✓			UA RF: 1VEON2FLR справжнім VEONEER US, INC. заявляє, що тип радіобладнання 77V12FLR відповідає Технічному регламенту радіобладнання; повний текст декларації про відповідність доступний на веб-сайті за такою адресою: <a href="https://www.veoneer.com/en/regulatory">https://www.veoneer.com/en/regulatory</a>
		✓		Цим HELLA GmbH & Co. KGaA заявляє, що радіотехнічне обладнання типу RS4 відповідає Технічному регламенту радіотехнічного обладнання та Директиві 2014/53/ЄС. Повний текст декларації про відповідність доступний за адресою: <a href="http://www.hella.com/vcc">www.hella.com/vcc</a> Частотний діапазон: 24,05 – 24,25 ГГц Потужність передачі: 20 дБм (макс.) EIRP
Vietnam	✓			77V12FLR
		✓		C0173191017AF04A2
Zambia	✓			ZMB/ZICTA/TA/2019/6/61
		✓		ZMB/ZICTA/TA/2017/6/7

### Type approval for radio equipment

Market	Symbol	Type approval
Europe		Polestar hereby declares that all radio equipment is in compliance with the essential requirements and other relevant provisions of Directive 2014/53/EU.

Contact Polestar Support for detailed information on type approval.

### Related information

- Radar unit (p. 329)
- Polestar Support (p. 9)

# Camera unit

The camera unit is used by several driver support systems and has the task of for example detecting lane lines or traffic signs.



*Location of the camera unit*

The camera unit is used by the following functions:

- Adaptive cruise control
- Pilot Assist
- Lane assistance
- Assistance at risk of collision
- Driver Alert Control
- Road Sign Information
- Active main beam
- Park Assist

## Related information

- Driving support systems (p. 242)
- Limitations for camera unit (p. 341)
- Limitations for radar device (p. 329)
- Recommended maintenance for camera unit (p. 343)
- Symbols and messages for camera unit (p. 344)

# Limitations for camera unit

The camera unit has certain limitations - which in turn also limits those functions that use the unit. A driver should be aware about the following examples of limitations.

## Blocked unit

The area in front of the camera unit must be cleaned on a regular basis and kept free from decals, objects, dirt, etc. – these could disrupt the camera-based functions. This may result functions being reduced, being switched off completely or giving incorrect function responses.

## High temperature

At very high temperatures the camera unit can be temporarily switched off for about 15 minutes after the engine is started so as to protect the unit's electronics. The camera unit restarts automatically when the temperature has fallen sufficiently.

## Damaged windscreen

The following is also applicable so as not to risk incorrect function of the driver supports that use the camera unit:

- If a scratch, crack or stone chip appears on the windscreen in front of any of the "windows" for the camera unit and covers an area of approx. 0.5 × 3.0 mm (0.02 × 0.12 inches.) or more, Polestar Support must be contacted so that the windscreen can be replaced.
- Polestar recommends not repairing cracks, scratches or stone chips in the area in front of the camera unit – the entire windscreen should be replaced instead.
- Before replacing a windscreen, contact Polestar Support to verify that the correct windscreen has been ordered and will be fitted.

>>

- The same type of windscreen wipers or windscreen wipers approved by Polestar must be fitted when the windscreen is replaced.
- When replacing the windscreen, the camera unit must be recalibrated by a workshop in order to ensure the functionality of all of the car's camera-based systems. Contact Polestar Support.

### Impaired vision

The cameras have limitations similar to the human eye, that is, it may "see" worse in intense snowfall or rain, dense fog, heavy dust storms or snow flurries, for example. Under such conditions, the functions of camera-dependent systems could be significantly reduced or temporarily disengaged.

Strong oncoming light, reflections in the carriageway, snow or ice on the road surface, dirty road surfaces or unclear lane markings can also significantly reduce camera function when it is used to scan the carriageway to detect pedestrians, cyclists, large animals and other vehicles.

A bicycle rack or other accessories fitted on the rear of the car may obscure the camera's view.

### Blind sectors

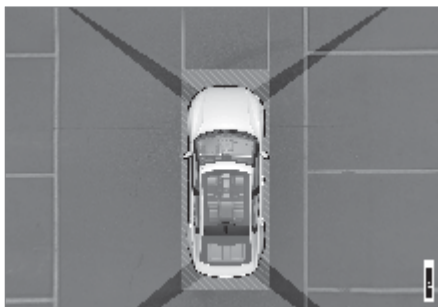

*There are "blind" sectors between the cameras' fields of vision.*

In the parking camera's 360° view, obstacles/objects may "vanish" in the gaps between the individual cameras.

### Light conditions

The camera image is adjusted automatically according to prevailing light conditions. Because of this, the image may vary slightly in brightness and quality. Poor light conditions can result in reduced image quality.

### Related information

- Camera unit (p. 341)
- Recommended maintenance for camera unit (p. 343)
- Limitations for radar device (p. 329)
- Park assist camera (p. 321)
- Polestar Support (p. 9)

## Recommended maintenance for camera unit

### WARNING

Pay attention to the possibility that, even if it only looks like a relatively small part of the image is obscured, a relatively large sector could be hidden from view. An obstacle could therefore go undetected until the car is very close to it.

### NOTE

If not rectified it can lead to reduced performance for the driver support systems that use the camera unit. This may result functions being reduced, being switched off completely or giving incorrect function responses.

In order that the camera unit shall function correctly, it must be kept clear of dirt, ice and snow, and be cleaned regularly with water and car shampoo.



*The marked area must be cleaned on a regular basis and kept free from decals, objects, dirt, etc. – these could disrupt the camera-based functions. This may result functions being reduced, being switched off completely or giving incorrect function responses.*

- To ensure best possible functionality, the surfaces in front of the sensors must be kept clean.
- Do not affix any objects, tape or labels in the area of the sensors.

### Related information

- Camera unit (p. 341)
- Limitations for camera unit (p. 341)
- Park assist camera (p. 321)
- Polestar Support (p. 9)

# Symbols and messages for camera unit

## IMPORTANT

Driver support components must only be maintained at a workshop – contact Polestar Support.

## NOTE

Dirt, ice and snow covering the sensors may cause incorrect warning signals, reduced or no function.

Here are examples of some of the messages and symbols relating to the camera unit that may be shown in the driver display.

### Sensor blocked



If the driver display shows this symbol and the message **Windscreen sensor blocked** See Manual, this means that the camera unit cannot detect other vehicles, cyclists, pedestrians and large animals in

front of the car, and that the car's camera-based functions may be disrupted.

The following table presents examples of possible causes for a message being shown, along with the appropriate action:

Cause	Action
The windscreen surface in front of the camera unit is dirty or covered with ice or snow.	Clean dirt, ice and snow from the windscreen surface in front of the camera unit.
Thick fog and heavy rain or snow block the camera view.	No action. Sometimes the unit does not work during heavy rain or snowfall.
Water or snow from the road surface swirls up and blocks the camera view.	No action. Sometimes the unit does not work on a very wet or snow-covered road surface.
Dirt has entered between the inside of the windscreen and the camera unit.	Cleaning the windscreen inside the unit cover is necessary – contact Polestar Support.
Strong oncoming light	No action. The camera unit is reset automatically in more favourable light conditions.

### Defective camera



If a camera sector is black and contains this symbol then it means that the camera is out of order.





*The car's left-hand camera is out of order.*

A black camera sector is also shown in the following instances, but then without the symbol for defective camera:

- open door
- open boot lid
- folded-in door mirror.

### Rear parking camera

#### Related information

- Camera unit (p. 341)
- Limitations for camera unit (p. 341)
- Polestar Support (p. 9)

## WARNING



Pay particular attention when reversing as this symbol is displayed when a trailer, bicycle rack or similar is

attached and connected to the car's electrical system.

Extinguished symbol indicates that the park assist sensors to the rear are off, and so you will not be alerted to any obstacles.



## Section 11

—

## Electric operation and charging

# General information on electric operation

Electric cars runs like a regular car, but certain functions differ from a car that has an internal combustion engine.

The driver display and centre display show some information that is unique to electric operation – charging information, distance to empty battery, and the high voltage battery's charge level.

For the car to function, the high voltage battery and associated electric drive systems must be at the correct operating temperature. Battery capacity may be reduced considerably if the batteries are too cold or too hot. By means of preconditioning, using the charging cable connected to the mains power circuit, the car's drive system and passenger compartment are prepared prior to departure, so that both wear and energy requirements while driving are reduced.

The high voltage battery that drives the electric motors is charged via a charging cable but can also be charged by means of smooth braking.

## Important to know

### Car without power

Bear in mind that important functions such as the servo brakes and power steering are limited when the car is without power.

### Exterior engine noise

### High-voltage current



Do not touch anything that is not clearly described in the Manual.

## Related information

- Charging the high voltage battery (p. 349)
- Start and switch off preconditioning (p. 194)
- High voltage battery (p. 504)
- Range for electric operation (p. 392)
- Gear positions (p. 385)
- Towing (p. 405)
- Activating and deactivating towing mode (p. 407)
- Economical driving (p. 394)

## WARNING

- The brake servo only works when the car is running.
- Remember that the car does not emit any engine noise when it is only powered by the electric motors and may therefore be difficult to notice by children, pedestrians, cyclists and animals. This is especially true at low speeds, such as in car parks.
- Several components in the car work with high-voltage current that could be dangerous in the event of incorrect intervention. These components, and all orange-coloured cables, must only be handled by qualified personnel.

# Charging the high voltage battery

The car is equipped with a rechargeable high voltage battery of lithium-ion type.

The high voltage battery is charged using a charging cable.

The battery can also be charged via charging stations with an integrated control device. The charging stations can be equipped with either a permanent charging cable or a socket where a special charging cable with a matching connector, known as a mode 3 charging cable, can be connected.

## Fast charging

Besides charging via a 230 V socket (alternating current), the car supports fast charging with direct current via charging stations that support the CCS (Combined Charging System) standard. A higher charging power can normally be achieved by charging with direct current, and the charging time can therefore be reduced. The maximum charging power is normally achieved when the charge level of the high voltage battery is 0-80%. When the charge level increases, the power will be reduced in order to reduce wear.

The time it takes for the high voltage battery to be charged is dependent on the charging power that is used.

## Charging cable handle and charging input socket

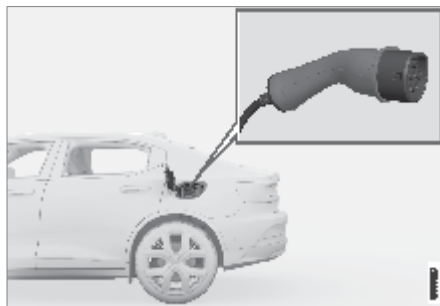

*Charging cable handle and charging input socket.*

Charging status is indicated in the following ways:

- Indicator on the charging cable's control unit.
- Indicator lamp in the car's charging input socket.
- Illustration and text in the driver display.

The 12 V battery is charged when the high voltage battery is charging and is interrupted when the high voltage battery is fully charged. It is not possible to drive the car while it is charging.

High voltage battery performance may be reduced if the temperature in the batteries is too low or too high.

Decal on the inside of the charging hatch.

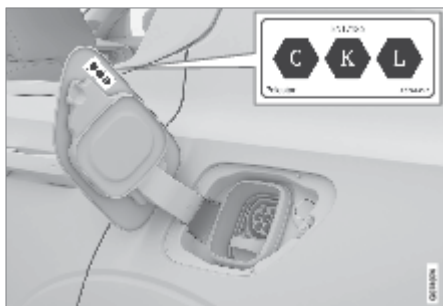

Choose charging that is approved for use in the car in accordance with the identifier<sup>131</sup> on the inside of the flap for the charging input socket.

#### Related information

- Charging cable (p. 352)
- Charging power (p. 351)
- Opening and closing the charging input socket hatch (p. 357)
- Start high voltage battery charging (p. 357)
- Stop high voltage battery charging (p. 367)
- Battery meter (p. 75)
- Charging status in the charging cable's control unit (p. 362)
- Charging status in the car's charging input socket (p. 361)
- Charging status in the car's driver display (p. 365)
- Charging in the car's centre display (p. 366)
- Symbols and messages relating to electric operation in driver display (p. 369)
- Gear positions (p. 385)
- Recommendations for long-term storage (p. 370)

- Regenerative braking (p. 384)

### WARNING

- The electrical system in the car uses high voltage electric current. Any damage to this system or to the high voltage battery may result in a risk of overheating, fire or serious personal injuries. If the car is flooded, catches fire, is involved in a collision, etc., contact Polestar Support. Prior to this inspection, the car should be parked outdoors at a safe distance away from buildings or readily flammable materials.
- The high voltage battery must only be replaced by an authorised workshop – contact Polestar Support for more information.

### IMPORTANT

The performance of the high voltage battery may be reduced if the car is left for any length of time in environments where the temperature is below  $-10^{\circ}\text{C}$  ( $14^{\circ}\text{F}$ ) or above  $40^{\circ}\text{C}$  ( $104^{\circ}\text{F}$ ). Avoid the battery becoming too hot or too cold by connecting the car to a charger.

### NOTE

- Polestar recommends a charging cable in accordance with IEC 62196 and IEC 61851 which supports temperature monitoring.

# Charging power

## NOTE

- The capacity of the high voltage battery is reduced slightly with age and use.

Charging power is used for charging the high voltage battery as well as preconditioning of the car. Charging takes place with a charging cable connected to the car's charging input socket and a 230 V socket<sup>132</sup> (alternating current) or via a charging station.

When the charging cable is activated, the driver display shows a message and a lamp in the car's charging input socket illuminates. The car's centre display is activated at the same time and shows the settings for charging. The charging power is mainly used for battery charging, but is also used for preconditioning the car. When the car's batteries are charging, the 12 V battery is also charged.

## Amperage for fast charging (direct current)

Charging power (kW)	Charging time <sup>A</sup> (minutes)
50	120
150	40

A Applies at 0-80% State Of Charge (SoC), provided that the temperature of the battery is between 20-35 °C (68-95 °F).

## Fuse

Normally several 230 V consumers are included in a fuse circuit, so additional consumers (e.g. lighting, vacuum cleaner, electric drill, etc.) can be on the same fuse.

## Related information

- Charging cable (p. 352)
- Charging status in the charging cable's control unit (p. 362)
- Charging status in the car's driver display (p. 365)

>>

# Charging cable

- Charging in the car's centre display (p. 366)
- Charging in the car's centre display (p. 366)
- Charging status in the car's charging input socket (p. 361)
- Start and switch off preconditioning (p. 194)
- Stop high voltage battery charging (p. 367)

## IMPORTANT

Never unplug the charging cable from the 230 V socket (alternating current) while charging is in progress - there is then a risk of damaging the 230 V socket. Always stop charging first before unplugging the charging cable from the car's charging input socket and then from the 230 V socket.

## NOTE

- If the weather is very hot or very cold, some of the charging current is used to heat/cool the high voltage battery and the passenger compartment, which results in a longer charging time.
- The charging time is extended if preconditioning has been selected. The time required depends mainly on the outside temperature.
- Fast charging with up to 150kW power output is possible under good conditions for high-voltage battery and charging station. The charging power is limited towards the end of fast charging.

The charging cable is used to charge the car's high voltage battery.

### Specifications, charging cable

Ambient temperature	-32 °C to 50 °C (-25 °F to 122 °F)
---------------------	------------------------------------

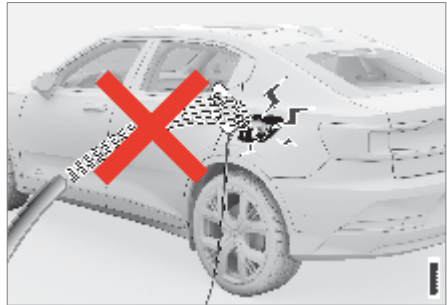

### Related information

- Charging status in the charging cable's control unit (p. 362)
- Ground fault breaker in charging cable (p. 354)
- Temperature monitoring of the charging cable (p. 356)
- Charging the high voltage battery (p. 349)

## WARNING

- Only use the charging cable provided with your car or a replacement cable recommended by Polestar.



## WARNING

- The charging cable has a built-in circuit breaker. Charging must only take place with grounded and approved sockets.
- Children should be supervised when in the vicinity of the charging cable when it is plugged in.
- High voltage in the charging cable. Contact with high voltage can cause death or serious personal injury.
- Do not use the charging cable if it is damaged in any way. Any charging cable that is damaged or not working may only be repaired by a workshop – contact Polestar Support for more information.
- Always position the charging cable so that it will not be driven over, stepped on, tripped over or damaged in some other way, or cause personal injury.
- Disconnect the charger from the wall outlet before cleaning it.
- Never connect the charging cable to an extension cord or a multiple plug socket.
- Do not use one or more adapters between the charging cable and the electrical socket.
- Do not use an external timer between the charging cable and electrical socket.

Also, refer to the manufacturer's instructions for using the charging cable and its components.

## WARNING

- The charging cable and its associated parts must not be swamped or immersed in water.

## IMPORTANT

- The charging cable is used to charge the car's high voltage battery. The charging cable has been designed to meet Polestar's safety standard. Use a Polestar-recommended charging cable that guarantees its function and safety. Polestar is not responsible for the safety of, or any damage caused by, a charging cable that is not recommended by Polestar.

- Multiple plugs, extension cables, over-voltage protection or similar devices must not be used together with the charging cable since this may involve a risk of fire, electric shocks, etc.

An adapter between the 230 V socket (alternating current) and the charging cable may only be used if the adapter is approved in accordance with IEC 61851 and IEC 62196.

- Never unplug the charging cable from the 230 V socket (alternating current) while charging is in progress - there is then a risk of damaging the 230 V socket. Always stop charging first before unplugging the charging cable from the car's charging input socket and then from the 230 V socket.

# Ground fault breaker in charging cable

## IMPORTANT

- Clean the charging cable with a clean cloth, moistened with water or a mild detergent. Do not use chemicals or solvents.
- Avoid exposing the control unit and its plug to direct sunlight. In such cases, the overheating protection in the plug is at risk of reducing or interrupting the charging of the high voltage battery.

The control unit for the charging cable charging cable has a built-in ground fault breaker that protects the car and the user from electric shocks caused by system faults.



Control unit LED<sup>133</sup> lamp.

### ① LED lamp

If the control module's built-in ground fault breaker is tripped then the LED lamp illuminates with red constant glow - check the 230 V socket (alternating current).

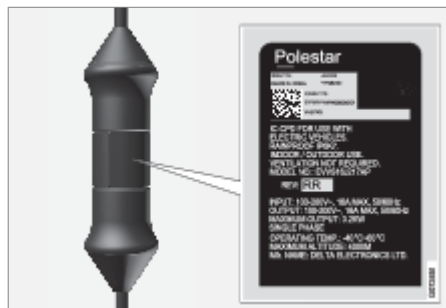

### Related information

- Charging cable (p. 352)

- Charging status in the charging cable's control unit (p. 362)

## WARNING

- Charging the high voltage battery must only take place with grounded and approved 230 V sockets (alternating current). If the capacity for the socket or fuse circuit is unknown, ask a licensed electrician to check the capacity. Charging above the capacity of a fuse circuit may lead to fire or damage the fuse circuit.
- The charging cable's overvoltage protection helps to protect the car's charging system, but cannot guarantee that overload will never occur.
- Never use visibly worn or damaged electrical sockets. This could cause fire or serious injury.
- Never connect the charging cable to a cable extension.
- Contact Polestar Support for information on maintenance or replacement of the high voltage batteries.
- Do not use a charging cable other than the recommended one.
- An external timer must not be used between the charging cable and the electrical socket.
- One or any number of adapters must not be used between the charging cable and the electrical socket.

## IMPORTANT

- The ground fault breaker does not protect the 230 V socket (alternating current)/electrical installation.
- Check the capacity of the socket.
- Other electronic equipment connected to the same fuse circuit must be disconnected if the total load is exceeded.
- Do not connect the charging cable if the socket is damaged.

# Temperature monitoring of the charging cable

For the car's high voltage battery to be charged safely every time, the control unit for the charging cable and the plug have built-in monitoring devices for the temperature.

Temperature monitoring takes place in the control unit and the plug.

## Monitoring in the control unit

Charging is switched off if the temperature of the control unit is too high. This is to protect the electronics. This may take place at a high outside temperature, for example, and/or when strong sunlight shines directly on the control unit.

## Monitoring at the plug

If the temperature at the power source to which the charging cable is connected is too high, the charging current is reduced. If the temperature exceeds a critical level, charging is stopped completely.

## Related information

- Charging cable (p. 352)
- Charging status in the charging cable's control unit (p. 362)

## NOTE

Polestar recommends a charging cable in accordance with IEC 62196 and IEC 61851 which supports temperature monitoring.

## IMPORTANT

If the temperature monitoring has automatically lowered the charging current repeatedly and charging has been interrupted then the cause of the overheating must be investigated and rectified.

## Opening and closing the charging input socket hatch

The flap for the high voltage battery's charging input socket is opened manually.

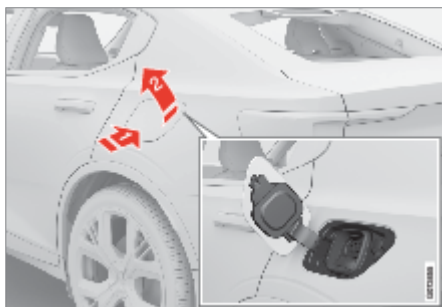

- 1 Press in the rear section of the cover and release.
- 2 Open the cover.

Close the cover for the charging input socket in reverse order.

### Related information

- Start high voltage battery charging (p. 357)
- Stop high voltage battery charging (p. 367)
- Charging the high voltage battery (p. 349)

## Start high voltage battery charging

When charging with alternating current, only use the charging cable supplied with the car or a replacement cable recommended by Polestar.

The car's high voltage battery is charged with a charging cable between the car and a 230 V socket<sup>134</sup> (alternating current) or charging station (mode 3).

Take out the charging cable. Note that the car must be switched off prior to charging.

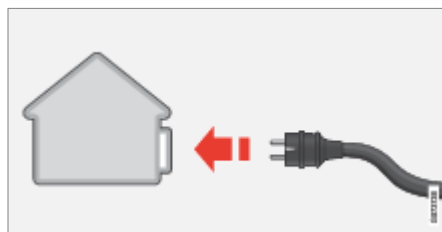

- 1 Connect the charging cable to a 230 V socket. Never use an extension cable. Set the correct charging current (for existing 230 V socket) in the centre display.



- 2 Open the charging hatch. Remove the charging handle's protective cover and make sure there are no objects in the charging input socket that could prevent charging. Then press the handle the whole way into the socket for the car.

>>

<sup>134</sup> The voltage in the socket may vary depending on market.



- 3** Clamp the charging handle's cover in place as illustrated.

4. The charging cable's charging handle is fastened/locked in, and charging starts within 5 seconds. When charging has been started, the LED lamp in the charging input socket flashes green. The driver display and the centre display show the remaining estimated charging time or whether charging is not working as intended.

Battery charging can be interrupted for a short time by pressing the button at the charging input socket – charging resumes within a few minutes.

### Fast charging (direct current)

The car's high voltage batteries can be fast-charged with direct current via charging stations that support the CCS (Combined Charging System) standard.

1. Remove the charging cable from the charging station's storage socket.
2. Open the charging hatch. Remove the protective cover on the charging input socket and then push the charging cable all the way into the car's charging input socket. The charging cable is automatically locked in the charging input socket.

3. Follow the instructions in the charging station's interface to authorise the charge. Charging begins when the charging station has executed an isolation test. This can take about a minute.

- > When charging has started, the LED lamp in the charging input socket flashes with a green glow. The driver display and the centre display show the remaining estimated charging time or whether charging is not working as intended.

Fast charging will not normally be stopped if the car is unlocked. Charging can be interrupted using the button at the charging input socket. If fast charging is stopped, it will not be possible to resume it automatically as the charging station requires charging to be re-authorised.

### Related information

- Charging the high voltage battery (p. 349)
- Opening and closing the charging input socket hatch (p. 357)
- Charging status in the car's charging input socket (p. 361)
- Charging status in the car's driver display (p. 365)
- Charging in the car's centre display (p. 366)
- Charging status in the charging cable's control unit (p. 362)
- Stop high voltage battery charging (p. 367)

## WARNING

- The high voltage battery must only be charged at maximum permitted charging current or lower in accordance with applicable local and national recommendations for charging from 230 V sockets (alternating current)/plugs.
- Charging the high voltage battery must only take place from an approved grounded 230 V socket<sup>135</sup> or from a charging station with a loose charging cable (Mode 3) supplied by Polestar.
- The control unit's ground fault breaker protects the car, but there may still be a risk of overloading the 230 V mains power circuit.
- Avoid visible worn or damaged mains sockets since they may lead to fire damage and/or personal injury if used.
- Never use an extension cable.
- Do not use one or more adapters between the charging cable and the electrical socket.

## WARNING

- The charging cable has a built-in circuit breaker. Charging must only take place with grounded and approved sockets.
- Children should be supervised when in the vicinity of the charging cable when it is plugged in.
- High voltage in the charging cable. Contact with high voltage can cause death or serious personal injury.
- Do not use the charging cable if it is damaged in any way. A damaged or inoperative charging cable must only be repaired by an authorised workshop. Contact Polestar Support for more information.
- Always position the charging cable so that it will not be driven over, stepped on, tripped over or damaged in some other way, or cause personal injury.
- Disconnect the charger from the wall outlet before cleaning it.
- Never connect the charging cable to an extension cord or a multiple plug socket.

Also, refer to the manufacturer's instructions for using the charging cable and its components.

<sup>135</sup> Or equivalent sockets with a different voltage, depending on market.

## IMPORTANT

- Never connect the charging cable when there is a risk of thunderstorm or lightning strike.
- Check that the 230 V socket (alternating current) has adequate power capacity for charging electric vehicles – in the event of uncertainty, the socket must be checked by a qualified professional. If the power capacity of the socket is unknown - use the lowest power capacity in the centre display.
- To avoid damage to the paint, e.g. in the event of high winds, position the charging handle's protective cover so that it does not touch the car.
- Never unplug the charging cable from the 230 V socket (alternating current) while charging is in progress - there is then a risk of damaging the 230 V socket. Always stop charging first before unplugging the charging cable from the car's charging input socket and then from the 230 V socket.

## NOTE

- During charging, condensation from the air conditioning may drip under the car. This is because of cooling of the high voltage batteries.
- Do not use a charging cable that is over 30 metres long for fast charging.

## NOTE

- Polestar recommends a charging cable in accordance with IEC 62196 and IEC 61851 which supports temperature monitoring.
- Charging stations that support CCS are normally clearly marked CCS or Combo. Note that the car must be switched off before charging.



# Charging status in the car's charging input socket

The charging input socket shows the charging status using an LED lamp.

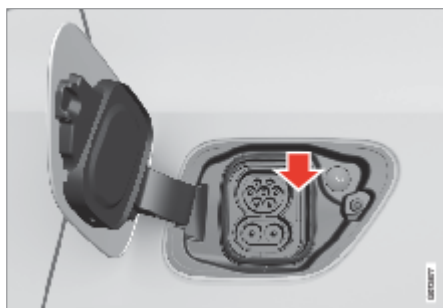

*LED lamp location in the car's charging input socket.*

The LED lamp shows the existing status while charging is in progress. If the LED lamp does not illuminate, check that the cable is firmly plugged into the wall socket and the socket in the car. The white, red or yellow lamps are activated when the passenger compartment lighting is switched on - they remain switched on for a while after the passenger compartment lighting has been switched off.

LED lamp's glow	Specification
Red	A fault has arisen.
Blue	Scheduled Charging activated.

- A Illuminates in white since the charging cable is not connected to the car.
- B For example, after a door has been opened or if the charging cable's handle is not locked in.
- C Extinguishes after a while.
- D The slower the flashing, the closer to fully charged.

## Related information

- Charging the high voltage battery (p. 349)
- Charging status in the car's driver display (p. 365)
- Charging status in the charging cable's control unit (p. 362)
- Stop high voltage battery charging (p. 367)

LED lamp's glow	Specification
White	LED light <sup>A</sup>
Yellow	Waiting mode <sup>B</sup> - waiting for charging to start.
Flashing amber	The charging process is about to be interrupted.
Green	Charging complete <sup>C</sup> .
Flashing green	Charging in progress <sup>D</sup> .

# Charging status in the charging cable's control unit

The indicator on the charging cable's control unit shows the status of ongoing charging.

① LED lamp

Control unit with indicator



Control unit LED<sup>136</sup> lamp.

LED	Status	Specification	Recommended action
Extinguished	Charging is not possible.	No power supply to the charging cable.	<ol style="list-style-type: none"> <li>1. Unplug the charging cable from the socket.</li> <li>2. Reconnect the charging cable to the socket, or use a different socket.</li> <li>3. If the problem persists – please contact Polestar Support.</li> </ol>
Illuminates in white	Charging possible.	The charging cable is ready to be plugged into the car.	<p>If the LED lamp is white but charging is not possible:</p> <ol style="list-style-type: none"> <li>1. Take the charging cable out of the charging input socket.</li> <li>2. Reconnect the charging cable to the charging input socket.</li> <li>3. If the indicator does not flash white within 10 seconds – take the charging cable out of the charging input socket and the socket. Reconnect the charging cable to the charging input socket and the socket.</li> <li>4. If the problem persists – please contact Polestar Support.</li> </ol>
Flashes white	Charging in progress.	<p>The car's electronics have started charging.</p> <p>Charging in progress.</p>	Wait until the batteries are fully charged.
Illuminates in red	Charging is not possible.	Temporary fault.	<ol style="list-style-type: none"> <li>1. Take the charging cable out of the charging input socket.</li> <li>2. Wait a moment.</li> <li>3. Reconnect the charging cable to the charging input socket.</li> <li>4. If the problem persists – please contact Polestar Support.</li> </ol>
Flashes red	Charging is not possible.	Critical fault.	Unplug the charging cable from the socket. If the problem persists – please contact Polestar Support.

### Related information

- Charging the high voltage battery (p. 349)
- Charging status in the car's charging input socket (p. 361)
- Charging status in the car's driver display (p. 365)
- Charging in the car's centre display (p. 366)
- Stop high voltage battery charging (p. 367)

# Charging status in the car's driver display

Charging status is indicated in the driver display.

Colour	Status	Specification
Flashing green	The frame of the driver display is shown with a green pulsing light.	Charging continues and an approximate time for when the batteries are estimated to be fully charged is shown.
Green	The frame of the driver display is shown with a green fixed light.	The batteries are fully charged.
Red	The frame of the driver display is shown with a red pulsing light.	A fault has occurred, check the connection of the charging cable to the car's charging input socket and to the 230 V socket <sup>A</sup> (alternating current).
Blue	The frame of the driver display is shown with a blue pulsing light.	Scheduled Charging activated.
Yellow	The frame of the driver display is shown with an amber pulsing light.	Charging is waiting to start or paused charging.

A The voltage in the socket may vary depending on market.

## Related information

- Charging the high voltage battery (p. 349)
- Symbols and messages relating to electric operation in driver display (p. 369)
- Charging status in the car's charging input socket (p. 361)
- Charging status in the charging cable's control unit (p. 362)
- Stop high voltage battery charging (p. 367)

## NOTE

If the driver display is not used for a while then it is dimmed. Reactivate the display by means of one of the following:

- depress the brake pedal
- open one of the doors
- press one of the steering wheel buttons.

# Charging in the car's centre display

From the centre display it is possible to set state of charge (SoC), unlock the charging cable and set amperage.

- Charging status in the car's charging input socket (p. 361)
- Charging status in the charging cable's control unit (p. 362)
- Stop high voltage battery charging (p. 367)

## Setting the state of charge



- 1 The battery's current charge status.
- 2 Swipe to set the preferred state of charge. The state of charge (SoC) remains unchanged until next time, unless it is changed in the centre display.

## Unlocking the charging cable

Tap on  in the centre display to interrupt ongoing charging. Charging is interrupted when the charging cable is unlocked.

## Setting the amperage

When charging with alternating current, it is possible to set the amperage using the plus or minus sign. The current amperage for charging is shown in the centre display.

## Related information

- Charging the high voltage battery (p. 349)

# Stop high voltage battery charging

Stop charging using the button next to the charging input socket or via the button in the centre display. Disconnect the charging cable from the car's charging input socket, and then from the 230 V socket<sup>137</sup> (alternating current).

- 1 Stop charging via the button next to the charging input socket – the charging cable's locked handle releases/unlocks.

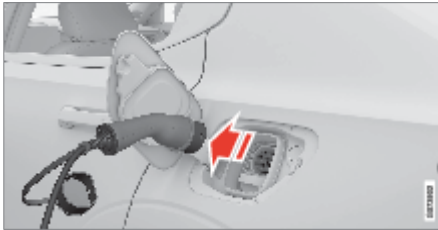

- 2 Unplug the cable from the car's charging input socket and close the hatch.

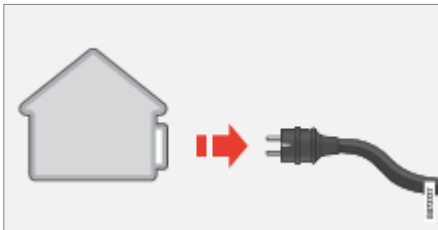

- 3 Unplug the cable from the 230 V socket. Return the charging cable to the car's storage compartment on the right of the cargo area.

## The charging cable is locked automatically

If the charging cable is not unplugged from the charging input socket, it is locked in again automatically shortly after unlocking in order to maximise charging and range, as well as to facilitate

preconditioning prior to the journey. The charging cable can be loosened using the button next to the charging input socket or via the button in the centre display.

The charging cable will not lock automatically into place during fast charging (direct current). To restart interrupted fast charging, remove the charging cable from the car's charging input socket, reconnect it and follow the instructions in the charging station's user interface.

## Fast charging (direct current)

Stop charging using the button next to the charging input socket, via the button in the centre display, or by following the instructions in the charging station's user interface. Release the charging cable from the car's charging input socket and connect it to the charging station's storage socket.

1. Stop fast charging via the button next to the charging input socket, via the button in the centre display, or via the charging station's user interface – the charging is ended and the lock in the charging input socket is automatically unlocked. This may take a couple of seconds.
2. Remove the charging cable from the car's charging input socket and close the hatch.
3. Connect the charging cable to the charging station's storage socket or hang it back in the designated location.

## Unlocking the car during fast charging

Fast charging will not normally be stopped if the car is unlocked. If fast charging is stopped, it is not resumed automatically as the charging station requires charging to be reauthorised via the user interface. The charging cable will not lock automatically into place if fast charging is stop-

>>

ped. To restart interrupted fast charging, remove the charging cable from the car's charging input socket, reconnect it and follow the instructions in the charging station's user interface.

### Interrupting charging with the mechanical emergency handle

The car is equipped with a mechanical emergency handle for when the charging cable does not release from the charging input socket, after charging is complete, via the button next to the car's charging input socket, in the centre display or via the charging station's user interface.

Use the mechanical emergency handle to interrupt charging when the charging cable cannot be released from the charging input socket.

1. Fold the backrest down on the left-hand section of the rear seat.
  - > The mechanical emergency handle is located behind the passenger seat on the left.
2. Grip the emergency handle and pull until it stops.
3. Restore the emergency handle to its original position.
  - > The emergency handle automatically returns next time charging starts.
4. Unplug the charging cable from the car's charging input socket.
5. Fold the backrest up to upright position.

### Related information

- Opening and closing the charging input socket hatch (p. 357)
- Charging cable (p. 352)

- Charging the high voltage battery (p. 349)
- Start high voltage battery charging (p. 357)
- Charging in the car's centre display (p. 366)
- Folding the backrest in the rear seat (p. 167)

## WARNING

Before using the mechanical emergency handle, check in the driver display that charging is complete. Do not use the emergency handle while charging is in progress.

## IMPORTANT

- Charging must be ended before disconnecting the charging cable from the car's charging input socket using the button located next to the charging input socket. This must be carried out even if the doors on the car are already unlocked. If the car is not unlocked, this may lead to damage to the charging cable or to the system.
- Never try to remove the charging cable from the car while charging is in progress. Always stop charging first, then disconnect the charging cable when the lock in the car's charging input socket has unlocked automatically.







## Symbols and messages relating to electric operation in driver display

### NOTE

Always end charging before the connection to the 230 V socket (alternating current) is disconnected, using the button next to the charging input socket or the button in the centre display. Note that the charging cable must be unplugged from the car's charging input socket before being unplugged from the 230 V socket, partly to avoid damage to the system and partly to avoid stopping the charging unintentionally.

If a fault should occur with the car's electric drive, a symbol and a message are shown in the driver display. Here are some examples.

Symbol	Specification
	Fault in the 12V battery. Read message in driver display. Contact Polestar support.
	Fault in the drive system. Read the message in the driver display. Contact Polestar support.
	Temporary fault in the powertrain. Read the message in the driver display.
	Information on the high voltage battery's battery level Read the message in the driver display.

### Related information

- Start high voltage battery charging (p. 357)
- Stop high voltage battery charging (p. 367)
- Charging the high voltage battery (p. 349)
- Indicator and warning symbols (p. 79)
- Battery meter (p. 75)
- Power meter (p. 76)

# Recommendations for long-term storage

During long-term storage of the car (longer than 1 month), make sure it has a suitable State Of Charge (SOC) and also make a habit of checking the State Of Charge (SOC) on a regular basis.

## Before long-term storage

Recommended State Of Charge (SOC) for long-term storage is between 40% - 50%.

- If the State Of Charge (SOC) is exceeds the recommendation – drive the car to the recommended State Of Charge (SOC).
- If the State Of Charge (SOC) is lower than the recommendation – charge the car to the recommended State Of Charge (SOC).

## During long-term storage

Check the State Of Charge (SOC) continuously and restore to a suitable State Of Charge (SOC) if it is below 20%.

If storage longer than 3 months is planned, it is recommended that the car has constant AC charging connected with maximum State Of Charge (SOC) set at 40% or 50%. Check continuously that the AC charging is working.

## Related information

- Start high voltage battery charging (p. 357)
- Battery meter (p. 75)
- High voltage battery (p. 504)
- Charging the high voltage battery (p. 349)
- Charging in the car's centre display (p. 366)

## NOTE

Choose the coolest location possible for the vehicle in order to minimise aging of the batteries during long-term storage. During summer the vehicle should preferably remain indoors or outdoors in the shade, depending on where the temperature is lowest.

## Section 12

—

## Starting and driving

# Starting the car

To start the car, a key needs to be inside the car.

Make sure the key is inside the car.

1. Put the seatbelt on.
2. Depress the brake pedal.
3. Change gear to D or R.
  - > The car is now in Drive mode.
4. Release the brake pedal.
  - > If Creep is On the car will drive slowly in the selected direction. If Hold (braking when stationary) is activated, the accelerator pedal must be depressed for the car to be able to drive in the selected direction.  
If Creep is Off the car will not drive forwards.

## Related information

- Gear positions (p. 385)
- Inching (p. 389)
- Usage modes (p. 373)
- Switching off the car (p. 373)
- Adjusting the steering wheel (p. 171)

## WARNING

- Before starting:
  - Fasten the seatbelt.
  - Adjust the seat, steering wheel and mirrors.
  - Make sure that the brake pedal can be fully depressed.

## WARNING

- Never use more than one mat at a time in the driver area. Before driving, remove the original mat in the driver area if another type of floor mat shall be used. All types of mat must be attached securely in the floor's mounting points. Make sure that the brake pedal and accelerator pedal do not become trapped in the floor mat as this can involve a major risk to safety.
- Polestar's floor mats are specially designed for the car. They must be attached securely in the floor's mounting points and must not be at risk of being trapped under the pedals.

## IMPORTANT

The car cannot be started if the charging cable is still plugged-in. Pay attention that the charging cable is unplugged from the charging input socket before starting the car.

## Switching off the car

The car is switched off automatically from drive mode when the driver leaves the car and it is parked.

### Automatic deactivation

1. Activating the parking brake.
2. Open the driver's door.
  - > The car is now not in Drive mode.

### Switching off manually via the centre display

It is possible to switch off the car manually.

1. Activating the parking brake.
2. Press .
3. Press More.
4. Select Power off.
  - > The car is now not in Drive mode.

To restart the car, press the play/pause button under the centre display.

### Related information

- Usage modes (p. 373)
- Gear positions (p. 385)
- Starting the car (p. 372)

## Usage modes

The car has three different usage modes that make various car functions available.

The car is set automatically in different modes: Passive, Comfort and Drive. The table shows which functions are available in the various modes.

Position	Functions
Passive	<p>When the car is unlocked, the following functions become available:</p> <ul style="list-style-type: none"> <li>• The driver display shows charging information, for example.</li> <li>• Odometer, clock and temperature gauge are illuminated.</li> <li>• Power seats can be adjusted.</li> </ul> <p>In this mode, the functions are controlled by time and are switched off automatically after a short while.</p>
Comfort	<p>When someone is sitting in the driver's seat or when the centre display is being used or is started via the media button in the tunnel console<sup>A</sup>:</p> <ul style="list-style-type: none"> <li>• The centre display can be used.</li> <li>• The infotainment system starts automatically (the same as when driving).</li> <li>• The climate system starts automatically (the same as when driving).</li> <li>• Power seats can be adjusted.</li> <li>• Electric windows, Bluetooth, navigation, phone and windscreen wipers can be used.</li> <li>• 12 V socket in the cargo area can be used.</li> <li>• The USB ports can be used.</li> </ul>
Drive	<p>When the driver sits in the driver seat and engages a gear:</p> <p>All functions are available and the car can be driven.</p>

<sup>A</sup> Comfort mode is switched off when someone leaves the driver's seat. Use the centre display to set the car back to Comfort mode. Comfort mode is switched off again when the front passenger door is opened.

**Related information**

- Starting the car (p. 372)

# Brake functions

The car's brakes are used to reduce the speed or prevent the car from rolling.

Besides the foot brake and parking brake, the car is equipped with several automatic brake assist functions. These can assist the driver by not needing to keep his/her foot on the brake pedal when stationary at a traffic light, or when starting on an uphill gradient.

Depending on the car's equipment, the following auto braking functions are available:

- Braking when stationary
- Auto braking after a collision
- Inching - the car is held stationary depending on the setting selected
- Assistance at risk of collision

## Related information

- Braking when stationary (p. 382)
- Foot brake (p. 375)
- Parking brake (p. 379)
- Inching (p. 389)
- Auto braking after a collision (p. 383)

# Foot brake

The foot brake is part of the brake system.

The car is equipped with two brake circuits. If a brake circuit is damaged, the brake pedal will engage deeper. Higher pressure on the pedal will therefore be needed to produce the normal braking effect.

If the foot brake is used when the car is switched off, greater pedal pressure is required to brake the car.

## Anti-lock braking system

The car has anti-lock brakes (ABS<sup>138</sup>), which prevents the wheels from locking while braking and allows maintained steering control.

A short test of the ABS system is made automatically after the car has been started when the driver releases the brake pedal. A further automatic test of the system may be made at low speed.

## Light braking charges the battery

Under light braking, the car's kinetic energy is converted into energy which is used to charge the battery. Battery charging is indicated in the driver display.

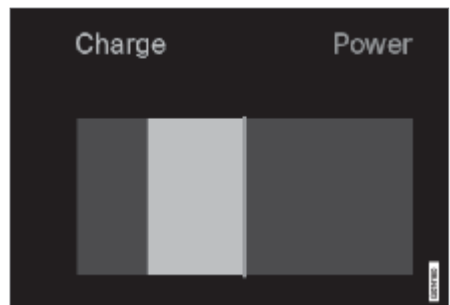





*The driver display indicates charging.*

>>

This function is active in the speed interval 150-5 km/h (93-3 mph). During heavier braking, braking is supplemented by the hydraulic brake system.

- Regenerative braking (p. 384)

### Symbols in the driver display

Symbol	Specification
	Check the brake fluid level. If the level is low, fill with brake fluid and check for the cause of the brake fluid loss.
	Fault in pedal sensor.
	Constant glow for 2 seconds when the car is started: Automatic function check.  Constant glow for more than 2 seconds: Fault in the ABS system. The car's normal brake system is still working, but without the ABS function.
	In the event of the message: Brake pedal characteristics changed Service required  The brake pedal needs to be depressed past the normal braking position using a higher pressure to brake the car.

### Related information

- Brake assistance (p. 377)
- Braking on wet roads (p. 377)
- Braking on gritted roads (p. 378)
- Brake system maintenance (p. 378)
- Brake lights (p. 139)

## WARNING

- The brake servo only works when the car is running.
- If both the warning lamps for brake fault and ABS fault illuminate at the same time, a fault may have occurred in the brake system.
  - If the level in the brake fluid reservoir is normal in this case – contact Polestar Support.
  - If the brake fluid is below the MIN level in the brake fluid reservoir, do not drive further before topping up the brake fluid. The reason for the loss of brake fluid must be investigated.



## Brake assistance

The brake assist system (BAS<sup>139</sup>) helps to increase brake force during braking, and can thereby shorten the braking distance.

The system detects the way in which the driver brakes and increases brake force where necessary. The brake force can be boosted up to the level when the ABS system is engaged. The function is suspended when the pressure on the brake pedal decreases.

### Related information

- Foot brake (p. 375)

## Braking on wet roads

When driving for a prolonged period of time in heavy rain without braking, the braking effect may be delayed slightly when next using the brakes.

This may also be the case after a car wash. It is then necessary to depress the brake pedal more forcefully. You should therefore maintain a greater distance to the vehicles in front.

Brake the car firmly after driving on wet roads or using a car wash. This warms up the brake discs, enabling them to dry faster and protecting them against corrosion. Bear in mind the current traffic situation when braking.

### Related information

- Foot brake (p. 375)
- Braking on gritted roads (p. 378)

# Braking on gritted roads

When driving on salted roads, a layer of salt may form on the brake discs and brake linings.

This may extend braking distance. You should therefore maintain a greater safety distance to vehicles in front. In addition, make sure you do the following:

- Brake now and again to remove any layer of salt. Make sure that other road users are not put at risk by the braking.
- Gently depress the brake pedal after finishing driving and before starting your next trip.

## Related information

- Foot brake (p. 375)
- Braking on wet roads (p. 377)

# Brake system maintenance

Check brake system components regularly for wear.

To keep the car as safe and reliable as possible, Polestar's service intervals as specified in the Status and Warranty booklet should be followed.

After replacing brake linings and brake discs, braking effect is only adapted after they have been "worn in" for a few hundred kilometres (miles). Compensate for the reduced braking effect by depressing the brake pedal harder. Polestar recommends only fitting brake linings that are approved for Polestar cars.

## Related information

- Foot brake (p. 375)

## IMPORTANT

The wear on the brake system's components must be checked regularly.

Contact Polestar Support for information on how to proceed.

# Parking brake

The parking brake prevents the car from rolling away from stationary by blocking both rear wheels.

A faint electric motor noise can be heard when the electrically-operated parking brake is being applied.

If the car is stationary when the parking brake is activated, it only acts on the rear wheels. If it is activated when the car is moving then the normal foot brake is used, that is, the brake acts on all four wheels. Brake function changes over to the rear wheels when the car is almost stationary.

## Related information

- Activating and deactivating the parking brake (p. 379)
- Parking on a hill (p. 381)
- In the event of a parking brake fault (p. 381)

# Activating and deactivating the parking brake

Use the parking brake to prevent the car from rolling from stationary. An activated parking brake locks both rear wheels.

## Activating the parking brake



*The parking brake button is located next to the gear selector.*

- Press the button.
  - > The symbol in the driver display illuminates when the parking brake is activated.

## Automatic activation

The parking brake is activated automatically

- if the driver unbuckles the seatbelt and/or opens the driver's door.
- when the car is switched off manually in the centre display.
- if the function Hold (braking when stationary) is activated and the car has been stationary for a while (approx. 10 minutes).

## Emergency brake

In an emergency, the parking brake can be activated when the car is in motion by pulling and holding down the button.

The car is then braked heavily with the foot brake. Braking stops when the button is released, or if the accelerator pedal is depressed.

### Deactivating the parking brake

The parking brake is deactivated automatically when a gear is selected.

1. Put the seatbelt on.
2. Depress the brake pedal.
3. Select gear position D or R
  - > The parking brake releases automatically and the symbol in the driver display extinguishes.
4. Release the brake pedal.
  - > If Inching is ON the car will drive slowly in the selected direction. If Hold (braking when stationary) is activated, the accelerator pedal must be depressed for the car to be able to drive in the selected direction.  
If Inching is OFF the car will not drive forwards.

### Symbol in the driver display

Symbol	Specification
	Constant glow: the parking brake is activated.
	Flashing: a fault has arisen with parking brake. Read the message in the driver display.

### Related information

- Activating and deactivating the parking brake (p. 379)
- Inching (p. 389)

- Braking when stationary (p. 382)
- In the event of a parking brake fault (p. 381)
- Parking brake (p. 379)
- Parking on a hill (p. 381)

### IMPORTANT

Check that the symbol for parking brake is illuminated when leaving the car.

### NOTE

- An acoustic signal sounds while emergency braking is active at high speeds.
- For deactivation, either the driver has to have buckled his/her seatbelt or the driver's door has to be closed.

## Parking on a hill

Always make sure that the parking brake has been activated when parking on a hill.

If the car is parked facing uphill:

- Turn the wheels away from the kerb.

If the car is parked facing downhill:

- Turn the wheels towards the kerb.

### Related information

- Activating and deactivating the parking brake (p. 379)

## In the event of a parking brake fault

Contact Polestar Support if it is not possible to deactivate or activate the parking brake after several attempts.

An acoustic warning signal sounds when driving with the parking brake activated.

If the car has to be parked before a possible fault can be rectified, the car must be secured to prevent it from rolling away.



The car can be secured by parking on level ground and:

- Block one or more of the wheels using suitable objects as chocks.
- Turn the front wheels towards the kerb or similar.

### Replacing the brake linings

The rear brake linings must be replaced at a workshop due to the design of the electrically-operated parking brake – contact Polestar Support.

### Symbols in the driver display

Symbol	Specification
	A fault has arisen in the brake system. Read the message in the driver display and contact Polestar Support.
	A fault has arisen in the brake system. Read the message in the driver display.
	A fault has arisen with parking brake. Read the message in the driver display.

# Braking when stationary

## Related information

- Activating and deactivating the parking brake (p. 379)
- Parking on a hill (p. 381)
- Polestar service programme (p. 494)

Braking when stationary (Hold) means that the driver can release the brake pedal while maintaining braking force when the car has stopped at a traffic light, for example.

## Activate Hold

Depress the brake pedal when stationary to activate Hold. This function is available at all times during driving and works on all inclines.

To activate Hold, make sure that

- the driver has buckled the seatbelt and/or that the driver's door is closed.
- gear position D or R is selected.

## Deactivate Hold

The function is released when the driver drives off, having selected a gear and depressed the accelerator pedal.

The parking brake is activated automatically

- if the driver unbuckles the seatbelt and/or opens the driver's door.
- if the function has been active for longer than 10 minutes.

## Symbols in the driver display

Symbol	Specification
	The function is active.

## Related information

- Foot brake (p. 375)
- Parking brake (p. 379)

# Auto braking after a collision

- Activating and deactivating the parking brake (p. 379)

## NOTE

Hold is deactivated even when the driver shifts to neutral position.

In the event of a collision in which the activation level is reached for the pyrotechnic seatbelt tensioners or airbags, or if a collision with a large animal is detected, the car's brakes are automatically applied. This function is to prevent or reduce the effects of any subsequent collision.

After a serious collision there is a risk that it is no longer possible to control and steer the car. In order to avoid or mitigate a possible further collision with a vehicle or an object in the vehicle's path, the auto braking system is activated automatically and brakes the car in a safe manner.

Brake lights and hazard warning lights are activated during braking. When the car has stopped, the hazard warning lights continue to flash and the parking brake is applied.

If braking is not appropriate, e.g. if there is a risk of being hit by following traffic, the system can be overridden by means of the driver depressing the accelerator pedal.

The function assumes that the brake system is intact after the collision.

### Related information

- Rear Collision Warning\* (p. 305)
- BLIS (p. 306)
- Brake functions (p. 375)

# Regenerative braking

The car recovers the brake energy and regenerates current to the battery when the driver releases the accelerator pedal or when the foot brake is used.

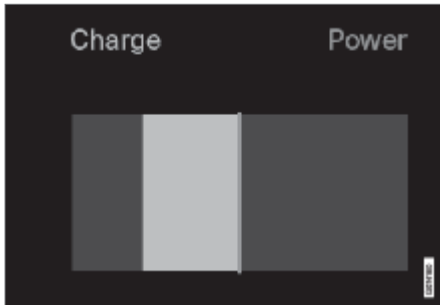

*Indication in the driver display during energy recovery.*

## NOTE

The brake lights come on if the braking force exceeds a certain level.

### Regeneration with the accelerator pedal

- Release the accelerator pedal.
  - > The car brakes with the selected braking action and charging is indicated in the driver display.

### Regeneration with the brake pedal

- Depress the brake pedal
  - > The car brakes and charging is indicated in the driver display.

### Related information

- Setting level for braking action (p. 385)
- Power meter (p. 76)



# Setting level for braking action

There are three different levels for energy recovery with the accelerator pedal that regulate braking action.

The car is set in Standard mode when it comes from the factory. Adapt the braking action based on the driving situation the car is used in, e.g. for winter road conditions.

## Settings in the centre display

1. Press .
2. Select Drive.
3. Change the desired braking action under One pedal drive.

Position	Braking action
Off	No braking force is applied and the car rolls freely.
Low	Some braking action is applied.
Standard	High braking action.

## Related information

- Regenerative braking (p. 384)

# Gear positions

Select an appropriate gear position depending on the direction in which the car is to travel.

## Changing gear

Change the gear position by pushing the spring-loaded lever forwards or back. The brake pedal must be depressed to be able to change gear.

## Gear positions



The driver display shows which gear position is currently in use.

The car has three different gear positions and a button for the parking brake:

R, N, D or the P button for parking brake.

## Parking brake – P

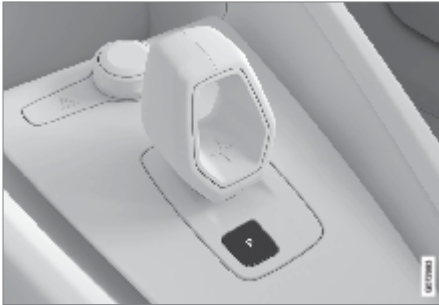

- Press the button.
  - > The symbol in the driver display illuminates when the parking brake is activated.

In an emergency, the parking brake can be activated when the car is in motion by pulling and holding down the button.

The car is then braked heavily with the foot brake. Braking stops when the button is released, or if the accelerator pedal is depressed.

## Reverse position - R

1. Put the seatbelt on.
2. Depress the brake pedal.
3. Move the lever all the way forwards.
  - > The car can now be reversed.

## Neutral position - N

1. Put the seatbelt on.
2. Depress the brake pedal.

3. Move the lever one step forward or one step back.
  - > The car now rolls freely when the brake pedal is not depressed.

## Drive position - D

1. Put the seatbelt on.
2. Depress the brake pedal.
3. Move the lever all the way back.
  - > The car can now be driven.

## Related information

- Gear selector inhibitor (p. 387)
- Symbols and messages for the gearbox (p. 388)
- Parking brake (p. 379)
- Activating and deactivating the parking brake (p. 379)
- Starting the car (p. 372)

## IMPORTANT

Check that the symbol for parking brake is illuminated when leaving the car.

## NOTE

- The parking brake must be activated in order to be able to lock the car and arm the alarm.
- An acoustic signal sounds while emergency braking is active at high speeds.

# Gear selector inhibitor

## NOTE

- It is not possible to start the car and change gear if the charging cable is connected.

The gear selector inhibitor prevents accidental switching between different gear positions.

To switch gear position, the brake pedal has to be depressed.

The lever can always be moved back and forth, but the brake pedal has to be depressed to change gear position.

### Message in the driver display



If the gear selector is inhibited, a message is shown in the driver display, e.g. Press brake pedal to activate gear lever.

### Related information

- Gear positions (p. 385)

# Symbols and messages for the gearbox

If a fault should occur in the gearbox, a symbol and a message are shown in the driver display.

Symbol	Specification
	A fault has arisen in the gearbox. Read the message in the driver display.
	Temporary fault in the powertrain. Read the message in the driver display.

### Related information

- Gear positions (p. 385)
- Gear selector inhibitor (p. 387)

# All-wheel drive

All-wheel drive (AWD<sup>140</sup>) means that the car is driving all four wheels at the same time, which improves traction.

The electric motor that drives the rear wheels enables electric all-wheel drive functionality.

### Related information

- Gear positions (p. 385)

# Drive systems

The car has two electric motors that drive the front and rear wheels.

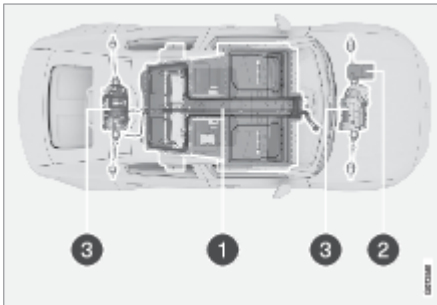

- ① High voltage battery – The car contains a high voltage battery. The function of the high voltage battery is to store energy. It receives energy when charging from the mains and under regenerative braking.
- ② 12 V battery – The car contains a 12 V battery that starts up the car's electrical systems and powers the electrical equipment in the car.
- ③ Electric motors – The car contains two electric motors that drive the car and recover brake energy to create electrical energy.

## Related information

- General information on electric operation (p. 348)
- Gear positions (p. 385)
- Range for electric operation (p. 392)

# Inching

Inching can facilitate progress at low speed, e.g. in traffic queues or in car parks.

When the function is active the car will move slowly in the selected travel direction without the accelerator pedal being used.

## Activating inching

From stationary, the brake or accelerator pedal must be depressed in order to activate the function.

1. Tap on  in the centre display.
2. Select Drive.
3. Select On under Creep.

> Inching is now activated.

## Deactivating inching

- Select Off under Creep.
- > Inching is now deactivated.

## Related information

- Starting the car (p. 372)
- Regenerative braking (p. 384)

# Damping

The shock absorbers control the car's body movements as required while also isolating uneven parts of the road. The aim of this is to provide as much comfort and function as possible while driving.

## Manually adjustable shock absorbers

The car is fitted with Öhlins adjustable shock absorbers. There are three recommended positions for front and rear shock absorber settings. Besides the factory setting Nominal, there is a harder setting, Track, and a softer setting, Comfort.

### Track

Track mode makes the car's shock absorption harder. The mode is adapted for driving on smooth roads or during active driving.

### Nominal

The Nominal mode is suitable for daily driving on public roads. The mode is the car's factory setting which is a balance between Sport and Comfort.

### Comfort

The Comfort mode provides softer damping that minimises road disruption while maintaining control.

## Related information

- Adjusting the damping setting\* (p. 390)

# Adjusting the damping setting

It is possible to adjust the settings of the shock absorbers for driving under other conditions or on specific road surfaces.

## Positioning adjusting knobs

There are four adjusting knobs, two for the front shock absorbers and two for the rear ones. The adjusting knobs are located above each wheel.

For the front wheels, the adjusting knobs are located in the bottom of the shock absorber, close to the wheel. The adjusting knobs for the rear wheels are located above each wheel in the wheel housing.

To access the adjusting knobs, the car has to be raised using a jack; see the separate section.

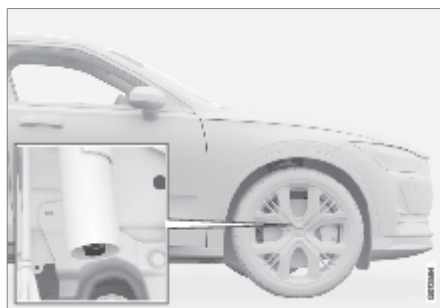

*Adjusting knob location, front wheels.*

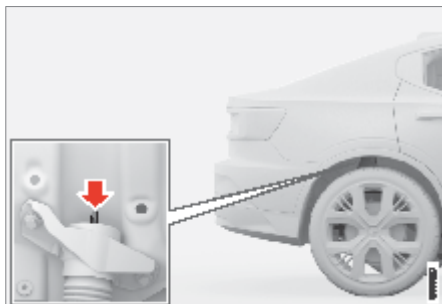

Adjusting knob location, rear wheels.

#### Adjusting the damping setting, front



Turn the adjusting knob clockwise or counterclockwise to change the adjustment position.

Angle the tyre for easier access to the adjusting knob.

1. To get to adjustment position 0, turn the adjusting knob clockwise until it reaches the stop.
2. Turn the adjusting knob counterclockwise to select the preferred adjustment position. The adjustment modes are defined with audible clicks that can be felt.
  - > Then repeat the procedure for the other damper.

#### Adjusting the damping setting, rear



The rubber cover is positioned on top of the adjusting knob.



Turn the adjusting knob clockwise or counterclockwise to change the adjustment position.

1. Remove the protective rubber cover covering the adjusting knob.
2. To get to adjustment position 0, turn the adjusting knob clockwise until it reaches the stop.
3. Turn the adjusting knob counterclockwise to select the preferred adjustment position. The adjustment modes are defined with audible clicks that can be felt.
  - > When the preferred position has been adjusted, replace the protective rubber cover. Then repeat the procedure for the other damper.

# Range for electric operation

## Recommended positions

Position	Front	Rear
Track	adjustment position 1	adjustment position 2
Nominal	adjustment position 8	adjustment position 8
Comfort	adjustment position 18	adjustment position 20

## Related information

- Damping (p. 390)
- Jack (p. 467)

### NOTE

- The closer the adjusting knob is to position 0, the harder the shock absorbers become.
- For performance that is as good as possible, Polestar recommends setting the adjusting knobs to the same position for every axle.

The car's range is dependent on a number of factors. The ability to achieve a long range varies according to the circumstances and conditions under which the car is being driven.

The certified value for the car's mileage on electric power should not be interpreted as an expected range. The certification value should primarily be used to compare values for different cars obtained during specific test cycles.

## Range in the driver display

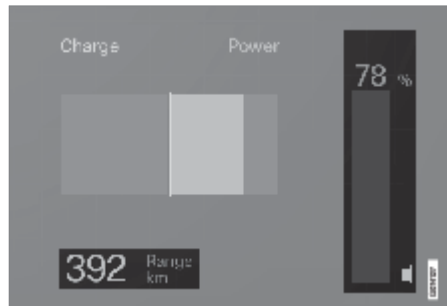

When the car comes out of the factory or after a factory reset, the range is based on the certified value

When the car has been driven a while, the range is based on historical driving patterns. The amount of history used depends on the battery's charge level. Therefore, the less charge there is in the battery, the faster the range adapts to a changed driving pattern.

## Factors that affect the range

In addition to historical trip data, there are several different factors that affect the range. The longest range is achieved under extremely favourable conditions when all factors have a positive impact.



Examples of factors that influence the range:

- speed
- climate settings
- topography
- preconditioning
- tyres and tyre pressure
- traffic situation
- temperature and weather
- road conditions.

Range based on speed and outside temperature

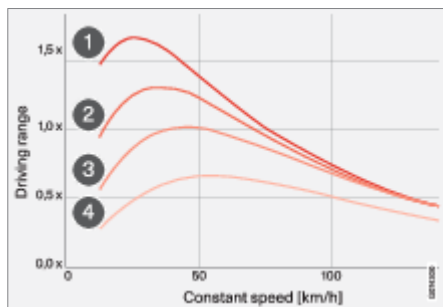

- ① 20 °C (68 °F) outside temperature and passenger compartment climate control deactivated.
- ② 20 °C (68 °F) outside temperature and passenger compartment climate control activated.
- ③ 35 °C (95 °F) outside temperature and passenger compartment climate control activated.
- ④ -10 °C (14 °F) outside temperature and passenger compartment climate control activated.

The graph shows the approximate relationship between constant speed and range, where a lower constant speed has a positive effect on range.

A higher outside temperature and deactivated climate control are also more favourable for the range.

Related information

- Economical driving (p. 394)
- Journey statistics in the centre display (p. 78)
- Checking tyre pressure (p. 456)

# Economical driving

To achieve the longest possible range, the driver should plan driving and adapt the driving method and speed to the prevailing situation.

## Before driving

- Precondition the car before driving if possible using the charging cable connected to the mains power circuit.
- If preconditioning is not possible when it is cold outside, use seat heating and steering wheel heating first of all. Avoid warming up the whole of the interior which takes energy from the battery.
- Choice of tyres and tyre pressures can affect energy consumption – seek advice on suitable tyres from Polestar Support.
- Remove unnecessary items from the car - the greater the load the higher the consumption.

## During driving

- Drive at a steady speed and keep a good distance to other vehicles and objects in order to avoid braking.
- The battery is recharged under braking by:
  - braking gently using the brake pedal.
  - releasing the accelerator pedal and making sure that regenerative brake recovery is set to Standard.
- High speed results in increased energy consumption – because the wind resistance increases with speed.
- In a cold climate, reduce electrical heating of windows, mirrors, seats and steering wheel, if possible.
- Avoid driving with open windows.

- Do not hold the car stationary on a hill using the accelerator pedal, use the brake function instead when stationary.
- When driving a short distance after preconditioning, switch off the climate control if possible.

## After driving

- If possible, park in an air-conditioned garage with a charging option.

## Related information

- Range for electric operation (p. 392)
- Regenerative braking (p. 384)
- Checking tyre pressure (p. 456)
- Journey statistics in the centre display (p. 78)
- Checking tyre pressure (p. 456)

# Preparations for a long trip

Before a driving holiday or some other type of long journey, it is important to check the car's functions and equipment particularly carefully.

Check that

- braking effect on braking works as intended
- the tyres have sufficient tread depth and pressure. Change to winter tyres when driving to areas where there is a risk of snowy or icy road surfaces
- The battery's charge is good
- the wiper blades are in good condition
- a warning triangle and high-visibility vest are located in the car - legally required in certain countries

## Related information

- Checking tyre pressure (p. 456)
- Filling washer fluid (p. 538)
- Winter driving (p. 395)
- Range for electric operation (p. 392)
- Recommendations for loading (p. 487)
- Pilot Assist\* (p. 268)
- Speed limiter (p. 259)
- Emergency puncture repair kit (p. 472)

# Winter driving

For winter driving it is important to perform certain checks of the car in order to ensure that it can be driven safely.

Check the following in particular before a cold season:

- The condition of the battery and charge level must be inspected. Cold weather places greater demands on the battery and its capacity is reduced by the cold.
- Use washer fluid with antifreeze to avoid ice forming in the washer fluid reservoir.

## Slippery driving conditions

Polestar recommends changing the setting for one pedal drive to Off or Low in order to contribute to more stable driving in slippery or icy conditions.

To achieve optimum roadholding Polestar recommends using winter tyres on all wheels if there is a risk of snow or ice.

Practise driving on slippery surfaces under controlled conditions to learn how the car reacts.

## Related information

- Setting level for braking action (p. 385)
- Winter tyres (p. 469)
- Snow chains (p. 470)
- Braking on gritted roads (p. 378)
- Braking on wet roads (p. 377)
- Filling washer fluid (p. 538)
- Replacing windscreen wiper blades (p. 536)

# Driving in water

## NOTE

The use of winter tyres is a legal requirement in certain countries. Studded tyres are not permitted in all countries.

Wading means the car being driven through water, e.g. on a flooded road. Driving in water must be performed with great caution.

Observe the following to prevent damage to the car when driving through water:

- The water level must not be higher than the floor of the car. If possible, check the depth at the deepest point before starting to drive through the water. Extra caution should be exercised when passing through flowing water.
- Do not drive faster than walking pace.
- Do not stop the car in the water. Drive forward carefully or reverse the car back out of the water.
- Remember that waves created by oncoming traffic may rise above the level for the floor of the car.
- Avoid driving through salt water (corrosion risk).

When the water has been passed, depress the brake pedal lightly and check that full brake function is achieved. Water and mud for example can make the brake linings wet resulting in delayed brake function.

## Related information

- Recovery (p. 407)

# Towbar

The car can be fitted with a towbar that makes it possible to tow a trailer, for example, after the car.

There may be different towbar variants for the car, contact Polestar Support for more information.

## Related information

- Retractable and extendable tow bar\* (p. 398)
- Driving with a trailer (p. 401)
- Hitch mounted bicycle rack\* (p. 404)
- Towbar specifications\* (p. 397)

## IMPORTANT

- When the car is switched off, the constant battery voltage to the trailer contact can be switched off automatically so as not to discharge the 12V battery.
- The towball needs to be cleaned regularly and lubricated with grease to prevent wear.

## NOTE

- The towball must not be lubricated when using a towball hitch with a vibration damper.

This is also applicable when fitting a bicycle rack that is clamped into position around the towball.

- If the car is equipped with a towbar, there is no rear mounting for a towing eye.

# Towbar specifications

## Towbar dimensions and mounting points

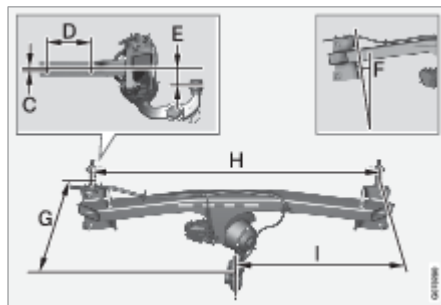
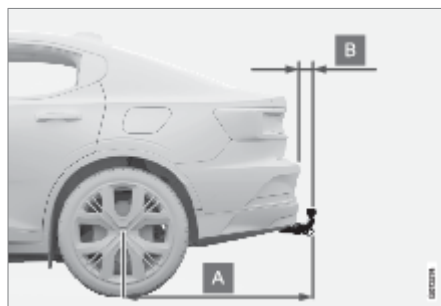

### Dimensions, mounting points in mm (inches)

A	1 082 (42,6)
B	83 (3,3)
C	6 (0,24)
D	145 (5,7)
E	67 (2,6)
F	Side member sloping 8 degrees
G	380 (15)
H	1 048 (41,3)
I	524 (20,6)

>>

# Retractable and extendable tow bar

## Related information

- Towbar\* (p. 397)
- Towing weights and towball loads (p. 545)

The tow bar is easy to extend and retract as required. When retracted, the hitch is completely concealed.

## Extend the hitch

1.

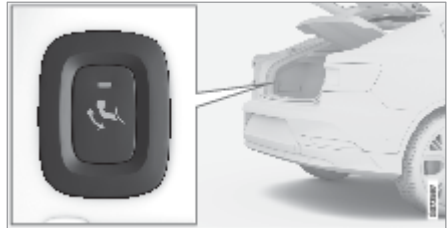

Open the tailgate. A button for retracting and extending the hitch is located on the left hand side at the back of the cargo area. An indicator lamp in the button must shine steadily for the extension function to be active.

2. Press the button and release it – holding it down for too long may cause extension not to start.



> The hitch is extended and moves down into an unlocked position – the indicator lamp flashes. The hitch is ready to continue to a locked position.

3.



Move the hitch to its end position, where it is fixed and locked – the indicator lamp shines steadily.

> The hitch is ready to be used.

2.



Lock the hitch by moving it back to its recessed position, where it is locked.

> The indicator lamp now shines steadily if the hitch is recessed correctly.

### Retracting the hitch

1. Open the tailgate. Press the button on the left-hand side at the back of the cargo area, and release it – holding it down for too long may cause retraction not to start.
  - > The hitch automatically drops down into an unlocked position – the indicator lamp by the button flashes.



### Related information

- Driving with a trailer (p. 401)
- Towbar\* (p. 397)

### WARNING

- Follow with care the instructions for retracting and extending the towbar.
- Do not tap on the extend/retract button if a trailer is connected to the towbar.

>>

## WARNING

- Avoid standing close to the bumper in the centre of the car at the rear when extending the towbar.
- Take care to attach the safety cable for the trailer in the designated mounting.

## IMPORTANT

- Make sure there is no connector or adapter in the electrical socket when retracting the towbar.
- When the towbar has been activated via pressing the button and set in unlocked position:

Wait at least 2 seconds before the towbar is moved to locked position. If the towbar does not remain in locked position, wait for a couple more seconds and try again.

Do not kick the towbar.

- The towbar must always be retracted when not in use.

## NOTE

Power save mode is activated after a while and the indicator lamp is extinguished. The system is reactivated by closing the tailgate and then reopening it. This is applicable when both extending and retracting the towbar.

If the car has detected a connected trailer electrically, the indicator lamp stops shining steadily.



# Driving with a trailer

When driving with a trailer, there are a number of things that are important to remember as regards the towbar, the trailer and how the load is placed in the trailer.

Payload depends on the car's kerb weight. The total of the weight of the passengers and all accessories, e.g. the towbar, reduces the car's load capacity by a corresponding weight.

The car is supplied with the equipment necessary for driving with a trailer.

- The towbar on the car must be of an approved type.
- Place the load in the trailer so that the pressure on the car's towbar is compliant with the specified maximum towball load. The towball load is calculated as part of the car's payload.
- Increase the tyre pressure to the recommended pressure for full load.
- The electric motor is under greater load than normal when driving with a trailer.
- Do not drive with a heavy trailer when the car is completely new. Wait until it has driven at least 1000 km (620 miles).
- Follow the applicable regulations for permitted speeds and weights.
- Maintain a low speed when driving with a trailer up a long, steep slope.
- Avoid driving with a trailer in the case of inclines steeper than 12%.

## Trailer weights

### When driving in hilly terrain and a hot climate

Under certain conditions, there may be a risk of overheating when driving with a trailer. If the electric motor and drive system overheat, a warning symbol is illuminated in the driver display and a message is shown.

### Parking on a hill

1. Depress the brake pedal.
2. Activating the parking brake.
3. Release the brake pedal.

Use chocks to chock the wheels when parking a car with a connected trailer on a slope.

### Hill starting

1. Depress the brake pedal.
2. Select gear position D or R and apply power.
  - > The parking brake releases and the symbol in the driver display extinguishes. The car can now be driven.

### Related information

- Trailer Stability Assist\* (p. 402)
- Checking trailer lights (p. 403)
- Towing weights and towball loads (p. 545)
- Retractable and extendable tow bar\* (p. 398)

## WARNING

Follow the specified trailer weight recommendations. The entire combination may otherwise be difficult to control under braking and during evasive manoeuvres.

# Trailer Stability Assist

## NOTE

The specified maximum permitted trailer weights are those permitted by Polestar. National vehicle regulations may further restrict trailer weight and speed. The towbars can be certified for higher towing weights than the car is allowed to tow.

The function for Trailer Stability Assist (TSA<sup>141</sup>) is included in the ESC<sup>142</sup> stability system, and its purpose is to stabilise a car with a trailer connected in situations where the vehicle combination has begun to fishtail. The function is added during the installation of the towbar, contact Polestar Support for more information.

### Causes of fishtailing

The phenomenon where a car with a trailer starts to fishtail may occur for all car-trailer combinations. High speeds are normally required for this to occur. But if the trailer is overloaded or the load is distributed incorrectly, e.g. too far back, there is a risk of fishtailing even at lower speeds.

Factors causing fishtailing may, for example, include the following:

- A sudden strong gust of wind from the side affects the car with the trailer.
- The car with the trailer drives along an uneven surface or into a pothole.
- Violent steering wheel movements.

Once the car has begun to fishtail, it may be difficult or impossible to stop it doing so. This makes the vehicle combination difficult to control, with a risk of it ending up in the wrong lane or leaving the roadway.

### Trailer Stability Assist function

Trailer Stability Assist constantly monitors the car's movements, particularly sideways. If fishtailing is detected, individual brake control takes place at the front wheels, which helps to stabilise the combination. This is usually enough to allow the driver to regain control of the car.

If the car is not brought back under control despite the initial input from trailer stability

# Checking trailer lights

assist, all wheels are used in tandem to brake the vehicle combination and the electric motor's drive is reduced. When fishtailing has gradually been eliminated and the combination is stable again, the system stops exerting control and the driver regains full control over the car.

Trailer Stability Assist may not intervene if the driver attempts to stop the car fishtailing by means of violent steering wheel movements, as the system is then unable to determine whether the trailer or the driver is causing the fishtailing.



When Trailer Stability Assist is operational, the ESC symbol in the driver display flashes.

## Related information

- Driving with a trailer (p. 401)
- Electronic stability control (p. 244)



## NOTE

- The stability function is deactivated if Sport mode is activated in the centre display.
- Retrofitting the towbar requires an update of the car's software, contact Polestar Support.

When connecting a trailer – check that all lights on the trailer work before departure.

## Direction indicators and brake lights on trailer

If one or more of the trailer's direction indicator or brake light bulbs is broken, the driver display shows a symbol and a message. Other lights on the trailer have to be checked manually by the driver prior to departure.

Symbol	Message
	Right trailer turn indicator malfunction
	Left trailer turn indicator malfunction
	Trailer brake light malfunction

If any of the direction indicator bulbs on the trailer is broken, the driver display symbol for the direction indicators also flashes more quickly than normal.

## Checking trailer lights

### Automatic check

After connecting a trailer electrically, it is possible to ensure that the lights on the trailer are working by means of automatic light activation. This function helps the driver to check that the lights on the trailer are working prior to departure.

1. When a trailer is connected to the towbar, the message Perform a trailer lamp check? is shown in the driver display.

# Hitch mounted bicycle rack

2. Confirm the message by pressing the right-hand steering wheel keypad's O button.
  - > The light check starts.
3. Get out of the car to check that the lights are working.
  - > All the lights on the trailer start flashing, then the lights come on one at a time.
4. Check visually to make sure that all the lights available on the trailer are working.
5. After a while, all the lights on the trailer will flash again.
  - > The check is complete.

## Checking trailer lights

To change the settings for checking trailer lights:

1. Tap on  in the centre display.
2. Press More.
3. Select Exterior lights.
4. Change the preferred settings.

## Related information

- Driving with a trailer (p. 401)

Follow the specified recommendations for using a towbar-mounted bicycle rack.

Carefully follow the instructions supplied with the bicycle rack.

- The weight of the bicycle rack plus cargo must not exceed 75 kg (165 pounds).
- The bicycle rack may be used for max. three bicycles.

The car's driving characteristics are affected when a bicycle rack is mounted on the towbar, e.g. because of:

- increased weight
- reduced acceleration
- reduced ground clearance
- altered braking.

## Recommendations when loading bicycles onto the bicycle rack

The greater the distance between the centre of gravity of the cargo and the towball, the greater the load on the towbar.

Load according to the following recommendations:

- Load the heaviest bicycle nearest to the car.
- Keep the load symmetrical and as close as possible to the centre of the car, e.g. by overlapping the bicycles if loading several bicycles.
- Remove loose parts from the bicycle, such as a basket, battery or child seat, when transporting it. The aim of this is to reduce the load on the towbar and bicycle rack, and to reduce air resistance, which affects the range.
- Do not use a protective cover on the bicycles. This may affect manoeuvring, impede visibil-

# Towing

ity and increase energy consumption. It will also result in increased load on the towbar.

## Related information

- Towbar\* (p. 397)

### WARNING

Incorrect use of the bicycle rack may result in damage to the towbar and car.

The bicycle rack may come loose from the towbar if it

- is mounted incorrectly on the towball.
- is overloaded, see the bicycle rack instructions for max. load weight
- is used for any purpose other than transporting bicycles.

It is only possible to tow the car up onto a recovery vehicle platform.

The car needs to be in towing mode to allow towing, this is set via the centre display.

## Towing types

Towing type is selected when towing mode is activated.

### Towing with assistance from a recovery vehicle

The car is hitched up onto a recovery truck which then recovers the car without any wheels rolling.

## Related information

- Activating and deactivating towing mode (p. 407)
- Fitting and removing the towing eye (p. 406)

### IMPORTANT

- Towing should only take place in active Tow mode. If the mode is not active, the car may start charging and then there is a great risk that the car's systems will be damaged.
- It is not recommended to tow at speeds higher than 30 km/h (18 mph), even if local regulations allow it.

# Fitting and removing the towing eye

Use the towing eye when towing. The towing eye is screwed into a threaded socket behind a cover on the right-hand side of the bumper, front or rear.

## Fitting the towing eye



1. Take out the towing eye, which can be found in the foam block in the front cargo area.

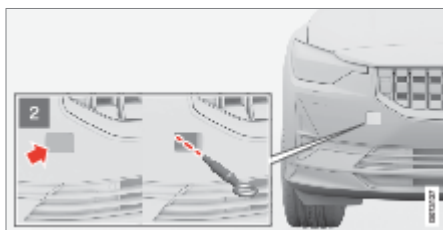

- 2** Front: Remove the cover – push on the cover.
  - > The cover pivots around its centre line and can then be removed.

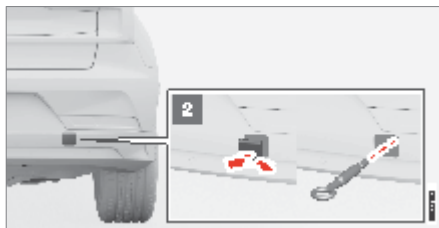

- 2** Rear: Remove the cover – use a coin, key or similar to prise out the cover.
  - > Fold out the cover entirely and take it off.

Screw in the towing eye until it reaches its end stop.

Screw the eye in firmly. For example, thread through the wheel bolt wrench and use it as a lever.

## Removing the towing eye

- Unscrew and remove the towing eye after use and return it to the foam block.
- Finish by refitting the cover onto the bumper.

## Related information

- Towing (p. 405)
- Activating and deactivating towing mode (p. 407)
- Opening and closing the bonnet (p. 501)
- Recovery (p. 407)
- Tool kit (p. 467)

## IMPORTANT

It is important that the towing eye is firmly screwed into place - right in until it stops.

# Activating and deactivating towing mode

Towing mode is used when the car needs to roll freely, e.g. in order to pull the car up onto a recovery vehicle's platform.

## Activating the towing mode

1. Tap on  in the centre display.
2. Press More.
3. Press Car status.
4. Select Tow mode.
5. Follow the instructions in the screen.
  - > The car is now in towing mode and rolls freely.

## Deactivating the towing mode

1. Make sure that the car is stationary.
2. Activating the parking brake.
  - > Towing mode is now terminated.

## Related information

- Towing (p. 405)
- Fitting and removing the towing eye (p. 406)

### IMPORTANT

It is not recommended to tow at speeds higher than 30 km/h (18 mph), even if local regulations allow it.

# Recovery

For recovery, the car is taken away with the help of another vehicle.

Call a recovery service for recovery assistance.

To recover, the car can be towed up onto a recovery vehicle platform if the car is in towing mode. Alternatively, the car can be lifted directly up onto a recovery vehicle platform.

## Related information

- Roadside assistance with Polestar Connect (p. 434)
- Towing (p. 405)
- Activating and deactivating towing mode (p. 407)
- Fitting and removing the towing eye (p. 406)

### WARNING

No one/nothing is allowed to remain behind the recovery vehicle while the car pulled up onto the flatbed platform.

### IMPORTANT

Note that the car must always be transported raised up with all the wheels on the recovery vehicle's platform.

# HomeLink®

HomeLink®<sup>143</sup> is a programmable remote control integrated in the car's electrical system.

It can remotely control up to three different devices, e.g. garage door opener or alarm system and thereby replace the remote controls for them.

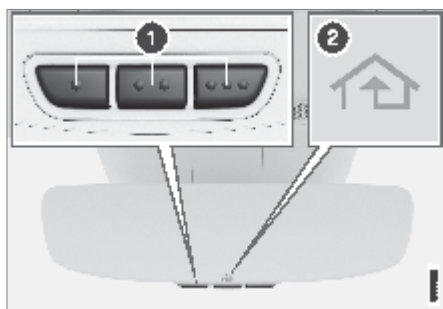

- ① Programmable buttons
- ② Indicator lamp

HomeLink® is built into the interior rearview mirror and consists of three programmable buttons and one indicator lamp in the mirror glass.

## Further information

Visit [homelink.com](http://homelink.com) or call 00 8000 466 354 65 (or the toll number +49 6838 907 277)<sup>144</sup>.

## Related information

- Using HomeLink®\* (p. 411)
- Programming HomeLink®\* (p. 409)
- Type approval for HomeLink®\* (p. 412)

## NOTE

Save the original remote controls for future reprogramming (e.g. when changing to another car or for use in another vehicle).

It is also recommended that the programming for the buttons is deleted when the car is sold.



# Programming HomeLink®

Program HomeLink®, reset programming or reprogram individual buttons.

## Programming HomeLink®

1. Aim the remote control towards the HomeLink® button to be programmed and hold it approx. 2-8 cm (approx. 1-3 inches) from the button. Do not obstruct the indicator lamp on HomeLink®.
2. Press and hold depressed both the button on the remote control and the button to be reprogrammed on HomeLink®.
3. Do not release the buttons until the indicator lamp has switched from flashing slowly (approx. once per second) to either flashing quickly (approx. 10 times per second) or illuminating with a constant glow.
  - > If the indicator lamp illuminates with a constant glow: The programming has been completed.  
Press the programmed button twice to activate.  
If the indicator lamp flashes quickly: The device being programmed to HomeLink® may have a security function that requires extra steps.  
Test by pressing the programmed button twice to see whether the programming is working. Otherwise, continue with the following steps.

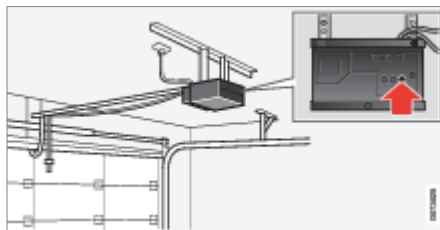

4. Locate programming button<sup>145</sup> on the receiver for the garage door or similar. It is normally located close to the antenna's bracket on the receiver.
5. Depress and release the receiver's programming button once.  
The programming must be completed within 30 seconds of the button being depressed.
6. Press and release the button on HomeLink® that you want to program. Repeat the sequence of pressing/holding/releasing a second time and, depending on the receiver model, even a third time.
  - > The programming has been completed.

## Reprogramming individual buttons

1. Press the desired button and hold it depressed for approx. 20 seconds.
2. Once the indicator lamp on HomeLink® starts to flash slowly, programming can continue as normal.

## Resetting the HomeLink® buttons

It is only possible to reset all of the HomeLink® buttons at the same time. Individual buttons can only be reprogrammed.

>>

- Press and hold depressed the outer buttons on HomeLink® for approx. 10 seconds.
  - > When the indicator lamp changes over from a constant glow to starting to flash, the buttons are reset and ready to be reprogrammed.

### Problems with programming

Visit [homelink.com](http://homelink.com) or call 00 8000 466 354 65 (or the toll number +49 6838 907 277)<sup>146</sup>.

### Related information

- Using HomeLink®\* (p. 411)
- HomeLink®\* (p. 408)
- Type approval for HomeLink®\* (p. 412)

## WARNING

While programming HomeLink®, the garage door or gate being programmed may activate. For this reason, make sure that nobody is in the vicinity of the door or gate while programming is in progress. The car should be outside the garage while a garage door opener is being programmed.

## NOTE

- The ability of some remote controls to program HomeLink® is improved at a distance of approx. 15–20 cm (approx. 6–12 inches).

## NOTE

- If the button to be reprogrammed is not programmed with a new unit, it will resume the previously saved programming.

# Using HomeLink®

Use HomeLink® instead of the separate remote controls such as for the garage door or the alarm system.

1. Depress the programmed button.
2. The garage door, gate, alarm system or similar is activated (may take a few seconds).
3. The indicator lamp illuminates or flashes when the button has been depressed.

If the button is depressed for more than 20 seconds, the reprogramming is started.

The original remote controls can still be used in parallel with HomeLink®.

## Related information

- HomeLink®\* (p. 408)
- Programming HomeLink®\* (p. 409)
- Type approval for HomeLink®\* (p. 412)

## NOTE

HomeLink® cannot be used if the car is locked and the alarm is armed from the outside.

## WARNING

- If HomeLink® is used to control a garage door or gate, ensure that nobody is near the door or gate while it is in motion.
- Do not use HomeLink® for any garage door that does not have safety stop and safety reverse.

# Type approval for HomeLink®

The type approval for HomeLink® can be read below.

Country/ Area	Type approval
USA and Canada	This device complies with FCC rules part 15 and Industry Canada RSS-210. Operation is subject to the following two conditions: (1) This device may not cause harmful interference, and (2) This device must accept any interference that may be received including interference that may cause undesired operation.
Europe	<p>Gentex Corporation hereby declares that HomeLink® Model UAHL5 complies with the Radio equipment directive 2014/53/EU.</p> <p>Wavelength within which the radio equipment functions:</p> <ul style="list-style-type: none"><li>• 433.05MHz-434.79MHz &lt;10mW E.R.P.</li><li>• 868.00MHz-868.60MHz &lt;25mW E.R.P.</li><li>• 868.70MHz-868.20MHz &lt;25mW E.R.P.</li><li>• 869.40MHz-869.65MHz &lt;25mW E.R.P.</li><li>• 869.70MHz-870.00MHz &lt;25mW E.R.P.</li></ul> <p>Certificate holder address: Gentex Corporation, 600 North Centennial Street, Zeeland MI 49464, USA</p>

For more information see [support.polestar.com](http://support.polestar.com)

## Related information

- HomeLink®\* (p. 408)

## Section 13

—

## Audio and media

## Audio and media

The car's audio system takes account of, for example, the position of the listener and the speed of the car. The centre display provides access to radio and music apps, and additional third-party apps in music and media can be downloaded via Google Play.

Connect a phone or other device via Bluetooth. Choose whether you want it as a media device to play back music and/or as a phone device to, for example, make calls and show contacts.



*Overview of audio and media*

Control the functions with your voice, steering wheel keypad or the centre display.

Charging devices via the USB ports.

### Related information

- Connecting a phone to the car (p. 420)
- Radio (p. 417)
- Bluetooth Media Player (p. 419)
- Audio settings (p. 414)
- Apps (p. 415)
- Voice control with Google Assistant (p. 124)
- Driver distraction (p. 25)



## Audio settings

Sound reproduction quality is preset, but can be adjusted as well.

### Volume

The volume is normally adjusted with the volume control below the centre display or with the right-hand steering wheel keypad. This applies, for example, during playback of music, radio, ongoing phone calls and active traffic messages.

When adjusting the volume, an expandable menu opens in the centre display. The volume for incoming calls, notifications and media player, for example, can be changed here.

For more audio settings, go to the app view , settings  and tap on Sound.

### Sound reproduction

The sound system is pre-calibrated by means of digital signal processing. This calibration takes into account speakers, amplifiers, passenger compartment acoustics, listener position, etc. There is also dynamic calibration that takes into account the position of the volume control and the speed of the car.

### Related information

- Audio and media (p. 414)

# Apps

The app view provides access to the car's pre-installed apps, as well as downloaded apps.

Tap on the app view icon  at the top of the centre display to access the app view and start e.g. the radio, navigation system and phone<sup>147</sup>.

Some basic apps are always available. More apps such as web radio and music services can be downloaded when the car is connected to the Internet.

Certain apps are only available for use if the car is connected to the Internet.

All the apps used should be updated to the latest version. This gives access to the latest updates and functions.

## Apps shut down

If an app shuts down unexpectedly, try the following:

- reopen the app
- check if there is an update available for the app
- restart the system (switch off the car, wait a few seconds and start it again)
- uninstall and reinstall the app.

If the fault persists, contact Polestar Support.

## Related information

- Audio and media (p. 414)
- Downloading apps (p. 416)
- Approval of terms and conditions and data collection (p. 21)
- Deleting apps (p. 416)
- Moving apps in centre display (p. 113)
- Storage space on hard disk (p. 430)

- Centre display's views (p. 110)
- Switching off the car (p. 373)

<sup>147</sup> The last apps used can always be accessed from the home view.

# Downloading apps

New apps can be downloaded and installed when the car is connected to the Internet.

 Google Play offers a range of different apps suitable for use in the car.

The car must be stationary in order to download apps, i.e it must be in the Comfort usage mode.

1. Open app view .
2. Press Google Play.
  - > A Google account must be linked to the current user profile in order for Google Play to open.
3. Search for the app<sup>148</sup> you want, then select it.
4. Press Install.
5. Follow the instructions on screen to complete installation.

### Related information

- Apps (p. 415)
- Usage modes (p. 373)
- Connect account to user profile (p. 121)
- Deleting apps (p. 416)
- Storage space on hard disk (p. 430)

### NOTE

The app sometimes needs to access various things, such as your address book or positioning data, so that it can work as intended. In this case, you will be asked to approve this.

# Deleting apps

It is possible to remove installed apps<sup>149</sup>.

1. Open app view .
2. Tap on and hold down the app to be deleted so that a wastepaper basket is displayed at the bottom.
3. Drag the app to the wastepaper basket, then release it.
4. Confirm the deletion.

### Related information

- Apps (p. 415)
- Downloading apps (p. 416)

<sup>148</sup> Only car-adapted apps are available.

<sup>149</sup> Apps that are supplied with the car, known as basic apps, cannot be deleted.



# Radio

It is possible to listen to both FM and DAB channels.



The radio can be operated via the centre display, the steering wheel keypad or voice control.



More radio apps can be downloaded from Google Play.

## Sorting

DAB channels sort into alphabetical order from the top, followed by the FM channels sorted by frequency.

## Quick commands

When the app is used, it can also be controlled via quick commands in the home view.

## Radio messages

Different types of radio messages, e.g. traffic news and societally important information, can be set under settings in the radio app.

## Poor reception for DAB

If the reception for a DAB channel becomes poor, you can try the equivalent FM channel, if available, in the list of radio channels for better reception.

## Related information

- Start radio (p. 417)
- Setting radio favourites (p. 418)

# Start radio

The radio app can be started via the centre display or with voice control.

## Starting from the centre display



1. Start the radio app from the home view<sup>150</sup> or app view .
2. Select the preferred radio channel from the list of available radio channels, or from your favourites.

## Starting with voice control

It is also possible to start the FM radio using voice control by stating a frequency<sup>151</sup> for one of the FM channels in the list of radio channels.

## Related information

- Radio (p. 417)
- Setting radio favourites (p. 418)
- Voice control with Google Assistant (p. 124)

<sup>150</sup> The app can be accessed from the home view if it is one of the last apps used.

<sup>151</sup> Using voice control, only FM frequencies can be stated, not names of radio channels.

# Setting radio favourites RDS radio

It is possible to add a radio channel to the list of radio favourites that are shown as a separate tab in the radio app.

## Radio Favourites

To save radio channels to your list of favourites, proceed as follows:

1. Open the radio app from the home view or app view.
2. Tap on the star  next to the radio channel that you want to add to your list of radio favourites. The star is then filled in orange to confirm the selection.
  - > The radio channel is added to your list of favourites.

DAB channels sort into alphabetical order from the top, followed by the FM channels sorted by frequency.

To delete a radio channel from your list of favourites, tap on the star again. The orange fill disappears to confirm that the radio channel has been deleted from the list of favourites.

It is also possible to select and deselect favourites via the Now playing view which is accessed by expanding the Now playing field to full screen mode.

## Related information

- Radio (p. 417)
- Start radio (p. 417)

RDS (Radio Data System) means that the radio automatically changes to the strongest transmitter. RDS provides the ability to receive e.g. traffic information and to search for certain programme types.

RDS links FM transmitters into a network. An FM transmitter in such a network sends information that gives an RDS radio the following functions:

- Switch automatically to a stronger transmitter if reception in the area is poor.
- Search for programme category, e.g. programme types or traffic information.
- Receive text information on current radio programme.

When broadcasting news or traffic messages, the radio can switch stations, interrupting the audio source currently in use. The radio returns to the previous audio source and volume when the set programme type is no longer broadcast.

## Related information

- Radio (p. 417)

## NOTE

Some radio stations do not use RDS or only selected parts of its functionality.

# Bluetooth Media Player

If a phone or other device is connected to the car via Bluetooth, media from the devices can be played back in Bluetooth Media Player.



Start the Bluetooth Media Player app from the home view or app view . When the app is used, it can also be controlled via quick commands in the home view.

Other third party apps for media playback can also be downloaded to the car.

## Related information

- Connecting a phone to the car (p. 420)
- Media playback (p. 419)
- Downloading apps (p. 416)

# Media playback

Regardless of the media app used, a Now playing field is shown in the centre display.

Among other things, it is possible to pause and change track in the Now playing field. Additional settings are possible if the Now playing field is expanded to full screen mode.

## Open the Now Playing view

Tap on the arrow in the Now Playing field to expand the field to the Now Playing view. This view gives access to more settings, which may vary depending on the type of app being used. Minimise the Now playing view by tapping on the arrow again.

## Related information

- Bluetooth Media Player (p. 419)
- Downloading apps (p. 416)

# Phone

A phone with Bluetooth can be connected wirelessly to the car.

When a phone has been connected and linked to the car as a phone device, it can be used to make calls, send/receive messages, and play back media wirelessly.

The phone is operated from the centre display, but also partly via voice control.





## Related information

- Audio and media (p. 414)
- Connecting a phone to the car (p. 420)
- Managing phone calls (p. 423)
- Managing contacts (p. 424)
- Managing text messages (p. 424)
- Disconnecting a Bluetooth-connected phone (p. 421)
- Switch between Bluetooth-connected phones (p. 422)
- Removing devices connected to Bluetooth (p. 422)
- Voice control with Google Assistant (p. 124)
- Audio settings (p. 414)

# Connecting a phone to the car

Connect a phone to the car with Bluetooth to make calls, send and receive messages and play media directly from the car, for example.

## Option 1 - search phone from car

1. Activate Bluetooth on the phone.
2. • If no phone is connected to the car – go to the app view , settings  at the bottom and tap on Bluetooth > Pair new device.
  - If a phone was connected earlier – go to the app view , settings  at the bottom and tap on Bluetooth.
    - > Available Bluetooth devices are listed. The list is updated as new devices are detected.
3. Tap on the name of the phone to be connected.
4. Check that the specified number code in the car matches that in the phone. In which case, choose to accept in both places.
5. On the phone, choose to accept or reject any options for phone contacts and messages.
  - > The phone is connected for both media and telephony as standard<sup>152</sup>.
6. Press Done.

## Option 2 - search car from phone

1. Activate Bluetooth on the phone.
2. Search on the phone for Bluetooth devices.
  - > Available Bluetooth devices are listed.
3. Select the name of the car on the phone.

<sup>152</sup> If the phone is connected as both telephony and media device it will later be possible to change between telephony and media, such as if a passenger wants to use a phone as media device to playback music.

4. A pop-up window for the connection is shown in the car. Confirm the connection.
5. Check that the specified number code in the car matches the one shown on the phone. In which case, choose to accept in both places.
6. On the phone, choose to accept or reject any options for phone contacts and messages.

#### Related information

- Phone (p. 420)
- Disconnecting a Bluetooth-connected phone (p. 421)
- Switch between Bluetooth-connected phones (p. 422)
- Removing devices connected to Bluetooth (p. 422)

#### NOTE



- The message function must be activated in certain phones.
- Not all phones are fully compatible and may therefore not show contacts and messages in the car.
- If the phone's operating system is being updated, it is possible that the connection will be interrupted. Delete the phone from the car and reconnect.

## Disconnecting a Bluetooth-connected phone

It is possible to disconnect a phone connected to Bluetooth, and it will then no longer be connected to the car.

- When the phone is out of range of the car it is automatically disconnected. If disconnection occurs during an active call, then the call will be continued on the phone.
- It is also possible to disconnect the phone by manually deactivating Bluetooth.

#### Disconnect via the centre display

1. Open app view .
2. Tap on settings  in the bottom of the display.
3. Press Bluetooth.
4. Tap on the row with the phone's name to disconnect both telephony and media.
  - > The phone is no longer connected to the car.



It is also possible to select whether the phone should be connected as only phone or media device by tapping on the respective icon.

#### Related information

- Phone (p. 420)
- Connecting a phone to the car (p. 420)
- Switch between Bluetooth-connected phones (p. 422)
- Removing devices connected to Bluetooth (p. 422)

# Switch between Bluetooth-connected phones

It is possible to switch between a number of Bluetooth-connected phones.



1. Open app view .
2. Tap on settings  in the bottom of the display.
3. Press Bluetooth.
4. Tap on the name of the phone to be connected.
5. Select whether it should be used for both telephony and media.

## Related information

- Phone (p. 420)
- Connecting a phone to the car (p. 420)
- Disconnecting a Bluetooth-connected phone (p. 421)
- Removing devices connected to Bluetooth (p. 422)

# Removing devices connected to Bluetooth

It is possible to remove phones from the list of registered Bluetooth devices, for example.

1. Open app view .
2. Tap on settings  in the bottom of the display.
3. Press Bluetooth.
4. Tap on the arrow after the phone's name.
5. Press Unpair device.
  - > The phone is no longer registered to the car.



## Related information

- Phone (p. 420)
- Connecting a phone to the car (p. 420)
- Disconnecting a Bluetooth-connected phone (p. 421)
- Switch between Bluetooth-connected phones (p. 422)

# Managing phone calls

It is possible to make and receive calls when the phone is connected to the car via Bluetooth. The phone must be connected as phone device.

## Making a call from the phone app

1. Open the phone app from the home view or app view .
2. Choose a contact from Recent or Contacts. Alternatively, enter a phone number using the keypad.
3. Tap on the contact to make a call.
4. Tap on End call or  to end the call.

## Receiving calls

Incoming phone calls are shown and managed via the centre display.

1. Tap on Answer/Decline.
2. Tap on  to end the call.

## Receiving a new call while a call is in progress



If a new call comes in during an ongoing call, the new call can be answered via the centre display. The original call is parked when the new call is answered. Switch between the calls by tapping on the symbols that represent them.

## Missed calls

Missed calls are shown in the home view where it is also possible to call back. Missed calls are also shown in the notification view at the top of the centre display.

## Switching off the microphone

Tap on Mute to switch off the microphone. The person on the call will not hear what is being said in the car.

## Toggling between car and phone speakers

Tap on Speaker to toggle the sound between the speakers in the car and the phone speaker.

## Holding a call

Tap on Hold to hold the active call.

## Using the keypad during ongoing calls



If the keypad needs to be used during an ongoing call, it can be opened by tapping on its symbol in the centre display. To exit the keypad view and return to call view, tap on the same symbol again.

## Related information

- Phone (p. 420)
- Connecting a phone to the car (p. 420)
- Enter the characters, letters and words manually in the centre display (p. 116)
- Managing contacts (p. 424)
- Managing text messages (p. 424)
- Audio settings (p. 414)

# Managing text messages

It is possible to receive and send text messages, in the form of SMS, when the phone is connected to the car.

To be able to manage text messages in the car, the phone must be connected via Bluetooth<sup>153</sup> as phone device and the user must have approved in the phone's Bluetooth settings that notifications should be shown.

## Receiving text messages

When the phone is connected to the car, a notification is shown at the top of the centre display when a new text message is received. Choose whether this message is to be read out.

It is also possible to choose to mute the conversation. In which case, no more notifications for the conversation are shown while driving.

## Replying to text messages

When a text message has been read out, it is possible to dictate a reply<sup>154</sup>. Follow the instructions in the centre display.

## Text messages are not shown

If new text messages are shown on the phone but not in the centre display, try disconnecting and reconnecting the phone.

## Related information

- Phone (p. 420)
- Connecting a phone to the car (p. 420)
- Voice control with Google Assistant (p. 124)

# Managing contacts

When a phone is connected to the car, contacts can be managed directly in the centre display.

When a phone is connected to the car using Bluetooth and is selected as phone device, contacts are shown in the phone app under their own tab.

Before the contacts are shown in the car, sharing of contacts must be accepted in the phone.

Scroll through your contacts by swiping up or down.

The contacts that are favourites in the phone are not shown as favourites in the car.

## The contacts are not shown

It may take a while before the contacts are loaded. If they are still not shown after a while, try disconnecting and reconnecting the phone.

## Related information

- Phone (p. 420)
- Connecting a phone to the car (p. 420)

## NOTE

Not all phones are fully compatible with the car. In such cases, contacts cannot be displayed in the car.



## Wireless phone charger

Under the centre display is a charging pad for wireless phone charging.



To charge your phone, it must support wireless charging (Qi). Phones that are not equipped with wireless charge receivers can often be supplemented with a case that makes wireless charging possible.

### Related information

- Phone (p. 420)
- Using a wireless telephone charger (p. 425)
- Wireless charger certificate (p. 427)

## WARNING

Wireless charging can affect the operation of an implanted pacemaker or other medical devices. If you have one, it is recommended to consult with your doctor before using the wireless charging system.

## Using a wireless telephone charger

It is possible to charge a phone on the rubber pad under the centre display without having to use a phone cable.



*Wireless phone charger in front of gear lever*

- Remove all other objects from the charging pad and place the phone in the middle of it.
  - > Phone charging is started and the  symbol is shown in the centre display.

### If the phone does not charge

- Check that the charging pad is activated.
- Check that the charging pad is clear of other objects.
- Check that the phone supports wireless charging (Qi).
- Remove any case from the phone.
- Lift the phone and place it back in the middle of the charging pad.

If the phone is positioned incorrectly or if objects are preventing the charging pad from charging, a message is shown in the centre display.

### Activating and deactivating

The charging pad can be activated and deactivated from the centre display.

>>

1. Press .
2. Press More.
3. Press Interior Controls.
4. Select the current function and desired setting.

#### Related information

- Phone (p. 420)
- Wireless phone charger (p. 425)
- Wireless charger certificate (p. 427)

#### NOTE

Some phones may get hot during wireless charging. This is normal.

#### WARNING

Wireless charging can affect the operation of an implanted pacemaker or other medical devices. If you have one, it is recommended to consult with your doctor before using the wireless charging system.

#### IMPORTANT

- Avoid storing cards with Near Field Communication (NFC), such as debit cards for contactless payment, together with the phone. This type of card can be destroyed when charging is in progress.
- Keep your phone and charging pad away from other objects while charging in order to prevent overheating.

# Wireless charger certificate

Country/ Area	
Taiwan:	<p>根據 NCC 低功率電波輻射性電機管理辦法 規定:</p> <p>第十二條 經型式認證合格之低功率射頻電機，非經許可，公司、商號或使用者均不得擅自變更頻率、加大功率或變更原設計之特性及功能。</p> <p>第十四條</p> <p>低功率射頻電機之使用不得影響飛航安全及干擾合法通信；經發現有干擾現象時，應立即停用，並改善至無干擾時方得繼續使用。</p> <p>前項合法通信，指依電信法規定作業之無線電通信。</p> <p>低功率射頻電機須忍受合法通信或工業、科學及醫療用電波輻射性電機設備之干擾。</p>
Ukraine:	<p>виробник: Ел-Джі Електронікс Інк.(LG Electronics Inc) 10, Магок'юнганг 10-ро, Гангseo-гу, Сеул, 07796, Корея</p> <p>Frequency range 111 кГц / Максимальна потужність РЧ: 42 дБмк А / м</p> <p>справжнім Ел-Джі Електронікс Інкзаявляє, що тип радіообладнання WC510MVV20 відповідає Технічному регламенту радіообладнання; повний текст декларації про відповідність доступний на веб-сайті за такою адресою: <a href="http://www.lg.com/global/support/cedoc/cedoc">www.lg.com/global/support/cedoc/cedoc</a>.</p> <p>імпортер: Віннер Імпорте Україна</p> <p>Вул. Дачна, 5-А, с.Капітанівка, Київська область, 08112, Україна</p> <p>Тел.: +38(044) 585 63 00</p> <p>Контактна особа: Alla Haidai (ahaidai@winner.ua)</p>

Country/ Area	
USA/Canada	<p>FCC ID : BEJWC510MVV20</p> <p>IC : 2703H-WC510MVV20</p> <p>This device complies with part 15 of the FCC rules and with RSS-Gen,RSS-216 rules of Canada. Operation is subject to the following two conditions:</p> <p>(1) This device may not cause harmful interference, and</p> <p>(2) This device must accept any interference received, including interference that may cause undesired operation.</p> <p>Any changed or modifications not expressly approved by the party responsible for compliance could void the user's authority to operate this equipment.</p> <p>FCC RF Radiation Exposure Statement: This equipment complies with FCC RF Radiation exposure limits set forth for an uncontrolled environment. This device and its antenna must not be co-located or operating in conjunction with any other antenna or transmitter. This equipment should be installed and operated with a minimum distance of 15cm between the radiator and your body.</p> <p>–</p> <p>IDéclaration d'avertissement ISED</p> <p>Son fonctionnement est soumis aux deux conditions suivantes:</p> <p>(1) Cet appareil ne doit pas provoquer d'interférences nuisibles, et</p> <p>(2) Cet appareil doit accepter toute interférence reçue, y compris les interférences pouvant entraîner un fonctionnement indésirable.</p> <p>Les changements ou modifications non expressement approuvés par LG Vehicle Components Company pourraient annuler l'autorité de l'utilisateur à utiliser l'équipement.</p> <p>Déclaration d'exposition aux radiations RF de l'ISED: Cet équipement est conforme aux limites d'exposition aux rayonnements RF de l'ISED définies pour un environnement non contrôlé. Cet appareil et son antenne ne doivent pas être situés ou fonctionner conjointement avec une autre antenne ou un autre émetteur.</p> <p>Cet équipement doit être installé pour fonctionner avec une distance minimale de 10cm entre le radiateur et le corps de l'utilisateur final.</p>



### Related information

- [Wireless phone charger \(p. 425\)](#)

# Storage space on hard disk

It is possible to view how much free space there is on the car's hard disk.

Check available space by:

1. Open app view .
2. Tap on settings  in the bottom of the display.
3. Continue to Storage.

## Related information

- Apps (p. 415)

Section 14

—

Polestar Connect

# Polestar Connect

Polestar Connect provides access to assistance 24 hours a day.

The functions are available via the CONNECT and SOS buttons in the car's ceiling:

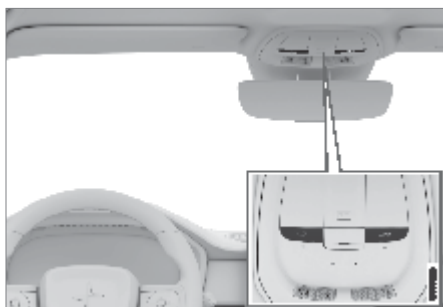

In the event of an accident, emergency assistance such as ambulance or police can be sent to the car. Roadside assistance can be called for less urgent problems, such as a puncture.

## Polestar Connect system

Polestar Connect is linked to the car's safety and alarm systems as well as other systems in the car, such as locking and climate control. The car has a built-in modem for communication with Polestar Assistance and the Polestar app. GNSS (Global Navigation Satellite System) is used to locate the car.

## Contacting Polestar Assistance

To contact Polestar Assistance, use the car's CONNECT button.

## Related information

- Personal information and Polestar Connect (p. 438)

- Approval of terms and conditions and data collection (p. 21)
- Polestar Support (p. 9)

## NOTE

The SOS button must only be used in the event of accident, illness or an external threat against the car and its passengers. The SOS function is only intended for emergency situations. Abuse may lead to supplementary charges.

The CONNECT button can be used for all other services, including roadside assistance.



# Automatic collision alarm with Polestar Connect

If a collision occurs, the car reports this automatically to the emergency call centre, which can send out emergency assistance.

When the car's safety system is triggered, e.g. in the event of an accident in which the activation level is reached for the seatbelt tensioner or airbags, the car automatically contacts the emergency call centre and a message is sent containing the car's position, among other things.

1. The emergency call centre attempts to establish verbal contact with the car's driver in order to find out about the severity of the collision and the need for assistance.
2. The emergency call centre provides the necessary assistance (police, ambulance, recovery, etc.).

## Related information

- Polestar Support (p. 9)
- Polestar Connect (p. 432)
- Polestar Connect markets (p. 435)
- Emergency assistance with Polestar Connect (p. 433)
- Roadside assistance with Polestar Connect (p. 434)
- Polestar Connect abroad (p. 436)

# Emergency assistance with Polestar Connect

Press the SOS button to contact the emergency call centre in an emergency situation.

To call for help in case of illness, external threats to the car or passengers, the emergency call centre can be alerted manually by depressing the SOS button for at least 2 seconds. The emergency call centre is notified and told of the car's position and attempts to establish verbal contact with the driver in order to agree what assistance is needed (police, ambulance, recovery, etc.).

## Related information

- Polestar Connect (p. 432)
- Polestar Connect markets (p. 435)
- Automatic collision alarm with Polestar Connect (p. 433)
- Roadside assistance with Polestar Connect (p. 434)
- Polestar Connect abroad (p. 436)
- Polestar Support (p. 9)

# Roadside assistance with Polestar Connect

If you have a puncture or your battery is discharged, for example, you can call for assistance with the CONNECT button.

If you hold down the CONNECT button in the roof for at least 2 seconds, verbal contact will be established between Polestar Assistance and the driver. The aim of this is to agree on what assistance is required.

## Roadside assistance costs

Roadside assistance costs are included for the first 3 years when you buy a new Polestar. After this time, free roadside assistance is offered in most markets if the car is serviced regularly. Polestar Support can inform you of the status of your roadside assistance agreement.

Polestar Connect can help you get back on the road, even if your Roadside Assistance agreement has expired. In this case, you will be asked to pay the cost for the service that is sent out to you.

## Related information

- Polestar Connect (p. 432)
- Automatic collision alarm with Polestar Connect (p. 433)
- Emergency assistance with Polestar Connect (p. 433)
- Polestar Connect abroad (p. 436)
- Polestar Support (p. 9)

## NOTE

- The SOS button must only be used in the event of accident, illness or an external threat against the car and its passengers. The SOS function is only intended for emergency situations. Abuse may lead to supplementary charges.

The CONNECT button can be used for all other services, including roadside assistance.

- If you do not have a valid road assistance agreement, additional recovery costs may apply.

# Customer service via Polestar Connect

Press the CONNECT button for answers to general customer questions.

For questions on using the car, the CONNECT button can be used to make contact with Polestar Assistance. An operator is available to answer 24 hours a day.

## Related information

- Polestar Support (p. 9)
- Automatic collision alarm with Polestar Connect (p. 433)
- Emergency assistance with Polestar Connect (p. 433)
- Roadside assistance with Polestar Connect (p. 434)
- Polestar Connect markets (p. 435)

# Polestar Connect markets

A list of which markets have Polestar Connect is presented here.

Belgium
Canada
China
Germany
Netherlands
Norway
Sweden
UK
USA

## Latest information

Polestar Connect is becoming available in an increasing number of locations. Contact Polestar Support for the latest information on where Polestar Connect are available.

## Related information

- Polestar Connect (p. 432)
- Polestar Support (p. 9)

## Polestar Connect abroad

Polestar Connect services may vary when driving between countries.

When you press the SOS button you are always connected to an emergency call centre in the market where the car is located.

When you press the CONNECT button you are always connected to your home country's Polestar Assistance.

In countries without a roaming agreement, there are no Polestar Connect services available.

Contact Polestar Support for more information.

### Related information

- Polestar Connect (p. 432)
- Polestar Support (p. 9)

## Buying and selling a car with Polestar Connect

In the event of change of ownership it is important to reset personal settings and user data in the car to the original factory settings.

### Closing the Polestar Connect service

Contact Polestar Support in the event of change of ownership in order to close the service. Your subscription will then be discontinued and your service history will be deleted.

In the event of change of ownership it is important to reset personal settings and user data in the car to the original factory settings. This is performed via the settings menu in the centre display.

Polestar ID is personal and does not need to be changed or deleted when the car is sold.

### Change of owner when changing country

When a car is purchased and imported to a different country, the owner should make it a priority to visit a delivery centre in the country in which the car was purchased. The delivery centre should then delete all customer data from its systems. In the country to which the car is imported, the owner should contact a delivery centre for help with starting the Polestar Connect service.

### Starting the Polestar Connect service

Buying a used car with Polestar Connect:

The new owner contacts Polestar Support, who transfers the time remaining on the subscription to the new owner. Polestar Support deletes the previous owner's information unless this has already been done.

Polestar Support notifies the new owner of the status of the car's Polestar Connect subscription.

# Standby battery for Polestar Connect

## Related information

- Resetting user data (p. 118)
- Creating a Polestar ID (p. 15)
- Polestar Support (p. 9)

If the main battery is de-energised, the Polestar Connect standby battery is used as a backup battery so that the system can still be used.

The standby battery has a limited service life. When the battery needs service or replacement, a message, Polestar Connect Service required, is shown in the driver display.

If you still see the message, please contact Polestar Support.

## Related information

- Messages in the driver display (p. 104)
- Polestar Connect (p. 432)

# Personal information and Polestar Connect

Personal data that are processed in connection with the Polestar Connect service.

Polestar is responsible for the personal data processed in connection with the service. All processing is performed in accordance with good practice and current legislation with regard to the processing of personal data.

## Purpose of the data processing

Personal data are used by Polestar with cooperating partners, both within and outside the EU/EEA, in order to provide and develop the service.

## What personal data are processed?

The personal information that is processed with regard to Polestar Connect comprises mainly of the following three categories.

- Personal data that the customer provides in connection with activation of the Polestar Connect and in other contacts with Polestar such as name, address, phone number, type of service and its duration.
- Information is sent automatically from the vehicle when a certain event covered by Polestar Connect occurs. This type of message contains vehicle ID (VIN), the time when the service is used, type of service, whether the airbags have been deployed, whether the seatbelt tensioners have been deployed, current battery level, current temperature inside and outside the vehicle, whether doors and windows are locked or opened as well as the vehicle's last six locations.
- Other information that can be linked to the customer includes phone calls with people in the vehicle, the service centre that supplied the service and records created by the service centre operator.

## Who may have access to the personal data?

Polestar uses subcontractors in order to provide the service. These subcontractors work on behalf of Polestar and may only process personal data to the extent required in order to provide the service. All subcontractors are bound by agreements requiring them to observe confidentiality and to treat personal data in accordance with current legislation.

## Screening procedures

The personal data required to supply the Polestar Connect service are stored during the agreement period and thereafter for as long as required in order for Polestar to fulfil its obligations in accordance with the law and other statutes. Data generated during events covered by Polestar Connect is deleted 100 days after the event occurred.

## Data privacy

If you have any questions concerning user rights in accordance with the Data Protection Act in relation to Polestar, please contact Polestar via [polestar.com/contact](https://polestar.com/contact). If you have any other questions on data privacy in relation to Polestar, please contact:

Personal data officer

Polestar HQ

Assar Gabrielssons väg 9

SE-405 31 Gothenburg

Sweden

## Consent to the processing of personal data

By activating the subscription in accordance with what is stated in the instructions in this document, the user agrees to the processing of

# Messages for Polestar Connect

personal data that is carried out in connection with the Polestar Connect service.

## Related information

- Polestar Connect (p. 432)
- Approval of terms and conditions and data collection (p. 21)
- Recording data (p. 20)
- Polestar Support (p. 9)

The following are examples of information messages that may appear when Polestar Connect is inoperative.

## Discharged battery

If you receive a message indicating that the car has a discharged battery and is waiting for the Polestar Connect system to wake up, this may be because the car has not been used for a while.

To save the battery when the car is not used for any length of time, set the Polestar Connect system to standby.

## Your Polestar Connect subscription is set to expire soon

45 days before your Polestar Connect subscription is set to expire, the Polestar Connect subscription expires soon message will be shown in the car's display.

## Polestar Connect has been disabled

If the Polestar Connect subscription has expired and the Polestar Connect system has been disabled, a message will be shown in the car's display which states Polestar Connect subscription has expired.

## Related information

- Polestar Connect (p. 432)
- Polestar Connect subscription (p. 440)

# Polestar Connect subscription

Polestar Connect is a subscription service. Your subscription includes emergency assistance and security services.

## Status of subscription

A 3-year subscription is included with the purchase of a new car. Contact Polestar Support to extend the subscription or for information on its expiry date. You then need to provide the car's vehicle identification number<sup>155</sup>.

## Message to indicate that your subscription will soon be expiring

45 days before your Polestar Connect subscription is set to expire, the Polestar Connect subscription expires soon message will be shown in the car's display.

## Deactivated subscription

When the subscription period has expired, you will be alerted via a message in the car's display showing the text Polestar Connect subscription has expired. This message disappears when the subscription is reactivated.

You will not be able to use the Polestar Connect services when your subscription has expired. Though, the emergency services via the SOS button and automatic collision alert will continue to function. To use Polestar Connect again, you will need to renew your subscription.

## Roadside assistance costs

Roadside assistance costs are included for the first 3 years when you buy a new Polestar. After this time, free roadside assistance is offered on most markets if the car is serviced regularly. Polestar Support can inform you of the status of your roadside assistance agreement.

Polestar Connect can help you get back on the road, even if your Roadside Assistance agreement has expired. In this case, you will be asked to pay the cost for the service that is sent out to you.

## Related information

- Showing the car's identification number (p. 24)
- Roadside assistance with Polestar Connect (p. 434)

## NOTE

If you do not have a valid road assistance agreement, additional recovery costs may apply.



# Section 15

---

## Navigation

# Google Maps

The Google Maps app includes maps and provides access to e.g. traffic information, directions and information on where to find appropriate charging stations.



It is possible to use Maps when the car is connected to the Internet and when it is not, but more services are available when you are connected to the

Internet.

## Same information in the car as on other devices

Linking a Google account to the active user profile also personalises the services. Destinations set on other devices are shown, such as home, work, favourites and last searches. If anything is changed on a device it is also changed in Maps, provided that the device and the car are logged in to the same Google account and connected to the Internet.

## Voice control

Maps can also be controlled with your voice using Google Assistant<sup>156</sup>.

## Related information

- Connect account to user profile (p. 121)
- Using Google Maps (p. 443)
- Google Maps in driver display (p. 444)
- Destinations in Google Maps (p. 444)
- Getting directions with Google Maps (p. 445)
- Voice control with Google Assistant (p. 124)

## WARNING

Observe the following.

- Direct all your attention to the road and make sure that all your concentration is on driving.
- Follow applicable traffic legislation and drive with good judgment.
- Due to weather conditions or time of year affecting the road conditions, some recommendations may be less reliable.

## NOTE

The instructions above are general descriptions and include third-party suppliers. Availability, procedure and functionality are subject to change or variation.

# Using Google Maps

Maps is shown and is operated in the centre display as well as the driver display using the steering wheel keypad. Maps can also be operated using voice control.

## Opening and closing Maps



To open Maps, tap on its icon in the centre display. To close the app, tap on the home button.

## Travel information in the navigation subview

When a route has been entered in Maps, the subview for navigation shows the following travel information for the next waypoint on the journey:

- travel time
- Distance to an intermediate destination
- Estimated time of arrival, ETA<sup>157</sup>
- The name of the next intermediate destination

It is possible to terminate ongoing guidance directly from the subview.

The information displayed relates to the next waypoint. The trip's final destination is not shown until there are no further intermediate destinations.

## Shortcuts

The navigation subview has three shortcuts, each of which initiates a search in Maps.

- Charging station
- Restaurant
- Parking

When a route has been entered in Maps, the shortcut for parking is replaced with a shortcut for terminating the ongoing guidance.

## Related information

- Getting directions with Google Maps (p. 445)
- Destinations in Google Maps (p. 444)
- Google Maps in driver display (p. 444)
- Voice control with Google Assistant (p. 124)
- Connect account to user profile (p. 121)

## WARNING

Observe the following.

- Direct all your attention to the road and make sure that all your concentration is on driving.
- Follow applicable traffic legislation and drive with good judgment.
- Due to weather conditions or time of year affecting the road conditions, some recommendations may be less reliable.

## NOTE

The instructions above are general descriptions and include third-party suppliers. Availability, procedure and functionality are subject to change or variation.

# Google Maps in driver display

The driver display can show guidance to destination with instructions as well as map. A map can also be shown if no destination is set.

Depending on selected display mode in the driver display, different amounts of map and guidance information is shown. Examples of information in the driver display:

- Arrows showing the next manoeuvre
- Distance to manoeuvre
- Name of the next road
- Road number and exit number
- Lane information

Guidance points, known as Turn-by-Turn, result in clear guidance via the driver display and minimise the need for the driver to look away from the road.

## Related information

- Google Maps (p. 442)
- Getting directions with Google Maps (p. 445)
- Driver display settings (p. 74)

# Destinations in Google Maps

It is possible to enter several destination types in Maps.

Different destination types can be entered in the search field. Besides addresses, it is possible to enter a specific destination, such as a museum, and ask for directions to get there. It is also possible to execute more general searches, e.g. for charging stations, restaurants and hotels, and then select one of the search results as a destination and get directions to there.

If a Google account is linked to the car, destinations such as home, work, favourites and last searches that are set on other devices can be shown in Maps.

## Related information

- Google Maps (p. 442)
- Connect account to user profile (p. 121)
- Getting directions with Google Maps (p. 445)

## NOTE

Poorer connection may have a negative effect on the functions.

# Getting directions with Google Maps

Enter your destination in the search field and allow Maps to create a route description.

1. Open Maps in home view or app view .
2. Enter an address or location in the search field.
  - > A route is suggested and indicated in blue on the map. Alternative routes are marked in grey. Road selection may be affected if, for example, road tolls and motorways are set to be avoided.
3. If another road is preferable, tap on the icon for route overview and select an alternative route.
4. Choose to start navigating.
  - > Instructions in the driver display and voice guidance<sup>158</sup> start.

Maps can also be controlled with voice control using Google Assistant<sup>159</sup>.

For more information, go to [g.co/mapsincar](https://g.co/mapsincar).

## Related information

- Destinations in Google Maps (p. 444)
- Google Maps in driver display (p. 444)
- Settings in Google Maps (p. 447)
- Voice control with Google Assistant (p. 124)

## WARNING

Observe the following.

- Direct all your attention to the road and make sure that all your concentration is on driving.
- Follow applicable traffic legislation and drive with good judgment.
- Due to weather conditions or time of year affecting the road conditions, some recommendations may be less reliable.

## NOTE

The instructions above are general descriptions and include third-party suppliers. Availability, procedure and functionality are subject to change or variation.

<sup>158</sup> Voice guidance can be deactivated in settings in the Maps app via the centre display.

<sup>159</sup> Google Assistant is not yet available in all languages.

# Electric car functions with Google Maps

Some functions in Maps are unique to electric cars. Some of them are listed here with a brief description.

The functions mentioned are only examples. For the latest information on which functions are available as well as how they work, go to [g.co/mapsincar](http://g.co/mapsincar).

## Battery level on arrival

Maps can show the estimated battery level on arrival at a destination.

## Estimated minimum charging time

When charging stations have been added as waypoints in an itinerary, Maps indicates the estimated minimum charging time at the charging station in question in order to clarify the total travelling time and the ETA<sup>160</sup>.

## Related information

- Connected functions with Google Maps (p. 446)
- Getting directions with Google Maps (p. 445)

## NOTE

The instructions above are general descriptions and include third-party suppliers. Availability, procedure and functionality are subject to change or variation.

# Connected functions with Google Maps

The car needs an Internet connection for full Maps functionality. A few functions that are accessible when the car is online are listed here.

The functions mentioned are only examples. For the latest information on which functions are available as well as how they work, go to [g.co/mapsincar](http://g.co/mapsincar).

## Traffic information

If the traffic is moving slowly, orange or red lines are shown, depending on how slow the traffic is moving. If the car loses its Internet connection, the coloured lines disappear after a few minutes as the information is no longer up to date. Updated traffic information is displayed again when the connection has been re-established. The map also shows information on different types of obstructions, such as roadworks or accidents.

In the event of accidents or other obstacles along the ongoing route, and if another faster route is available, Maps will suggest an alternative route.

## Alternative route

When a desired destination is set, a route is suggested, as well as alternative routes. Among other things, the suggestions are based on settings in the system, traffic information, calculated distance and travelling time. Select an alternative route in the list of suggested routes or by steering the car according to the alternative route, so-called decide by steering.

Change route while driving, Google Maps redirects you dynamically based on current traffic patterns, so that you can avoid traffic jams.

# Settings in Google Maps

## Related information

- Electric car functions with Google Maps (p. 446)
- Connect account to user profile (p. 121)
- Getting directions with Google Maps (p. 445)
- Settings in Google Maps (p. 447)

## NOTE

The instructions above are general descriptions and include third-party suppliers. Availability, procedure and functionality are subject to change or variation.

The majority of the settings for Maps are made directly in the app under settings. Here is a list of some examples.

### Level of voice guidance

Set the extent of voice guidance, e.g. if you only want to hear traffic information and not the next manoeuvre.

### Alternative route

Set so that road tolls and motorways, for example, are avoided in route descriptions.

### Satellite map

Set whether satellite map should be shown.

### Other settings

#### Volume for voice guidance

Turn the volume control under the centre display or the steering wheel's right-hand keypad. An expandable menu is opened in the centre display. Set the volume for voice guidance.

#### Language and units

If you want to use other languages or units in Maps, these can be changed from the settings in app view . This setting will change the language and units in all displays in the car, not just in Maps.

### Related information

- Getting directions with Google Maps (p. 445)
- Changing system units (p. 117)
- Changing system language (p. 117)
- Audio settings (p. 414)
- Updating Google Maps (p. 449)

# Downloading maps

- Downloading maps (p. 448)

## NOTE

- Data traffic increases when using the satellite map.
- The instructions above are general descriptions and include third-party suppliers. Availability, procedure and functionality are subject to change or variation.
- Changing the language in the centre display may mean that some information in the Manual is not compliant with national or local laws and regulations. Do not switch to a language that is difficult to understand as this may make it difficult to find your way back through the screen structure.

To ensure access to maps in Google Maps even when the car has poor or no online connection, map data is saved automatically.

Maps automatically downloads maps based on the car's current position and patterns of movement. These maps can be used when the car has no online connection in order to

- provide map data to the car's safety and navigation functions
- provide access to Maps in areas with limited or no online connection.

It is also possible to select a map area manually and download.

## Related information

- Google Maps (p. 442)
- Connected functions with Google Maps (p. 446)
- Settings in Google Maps (p. 447)

## NOTE

The instructions above are general descriptions and include third-party suppliers. Availability, procedure and functionality are subject to change or variation.



# Updating Google Maps

It is appropriate to ensure that Maps is updated to the latest version.

When an updated version of Maps is available, this will be found on Google Play. If there are differences in access rights between two versions of the app, the system will ask the user for approval.

The latest version ensures that you have the latest updates and functions. To update Maps, your car needs to be connected to the Internet and an active Google account has to be linked to the user profile.

When an update is available for Maps, a notification will be displayed where you can choose to update.

## Related information

- [Getting directions with Google Maps \(p. 445\)](#)
- [Settings in Google Maps \(p. 447\)](#)
- [Connect account to user profile \(p. 121\)](#)



## Section 16

—

## Wheels and tyres

# Tyres

The function of the tyres is to carry load, provide grip on the road surface, dampen vibration and protect the wheel from wear.

The tyres greatly affect the car's driving characteristics. The type of tyre, dimensions, tyre pressure and speed rating are important for how the car performs.

The car is fitted with tyres according to the tyre information sticker found on the driver's side door pillar (between the front door and the rear door).

## Recommended tyres

On delivery, the car is equipped with Polestar original tyres that have the VOL<sup>161</sup> marking on the side of the tyres. These tyres are carefully adapted to the car. In the event of changing tyres, it is therefore important that the new tyres also have this marking in order for the car's driving characteristics, comfort and electricity consumption to be maintained.

## New tyres

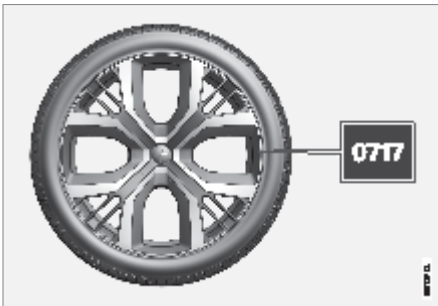

Tyres are perishable. After a few years they begin to harden at the same time as the friction capacity/characteristics gradually deteriorate. For this reason, aim to get as fresh tyres as possible

when you replace them. This is especially important with regard to winter tyres. The last four digits in the sequence mean the week and year of manufacture. This is the tyre's DOT marking (Department of Transportation), and this is stated with four digits, for example 0717. The tyre is then manufactured in week 07, year 2017.

## Tyre age

All tyres older than 6 years old should be checked by an expert even if they seem undamaged. Tyres age and decompose, even if they are hardly ever or never used. The function can therefore be affected. This applies to all tyres that are stored for future use. Examples of external signs which indicate that the tyre is unsuitable for use are cracks or discolouration.

## Tyre economy

- Maintain the correct tyre pressure.
- Avoid fast starts, heavy braking and squealing tyres.
- Tyre wear increases with speed.
- Having the correct wheel setting (four-wheel setting) is very important.
- Unbalanced wheels worsen tyre economy and travelling comfort.
- The tyres must have the same direction of rotation during their entire service life.
- The tyres on the rear wheels should have as much or more tread than the tyres on the front wheels so as to reduce the risk of oversteer under heavy braking.
- If you drive over kerbstones or deep holes you can damage the tyres and/or wheel rims permanently.

### Tyre rotation and tread depth

Switching originally fitted tyres between the front and rear axles is not possible.

Driving style, tyre pressure, climate and road condition affect how quickly the tyres age and wear. Correct tyre pressure results in more even wear.

Contact Polestar Support for a check if you are not sure about the tread depth.

### Storing wheels and tyres

When you store complete wheels (tyres fitted on wheel rims) they should be hung up or positioned lying on their sides on the floor.

Tyres not fitted on rims must be stored lying on their sides or standing upright, but not hung up.

### Related information

- Checking tyre pressure (p. 456)
- Tyres' rotation direction (p. 455)
- Tread wear indicators on the tyres (p. 456)
- System for tyre pressure monitoring (p. 459)
- Emergency puncture repair kit (p. 472)
- Dimension designation for tyre (p. 454)
- Approved wheel and tyre sizes (p. 551)
- Recommendations for loading (p. 487)

## WARNING

- A damaged tyre may lead to loss of control over the car.

## WARNING

- Wheel rim size and tyre size for your Polestar are specified to meet stringent requirements for stability and driving characteristics. Unapproved combinations of wheel rim size and tyre size may have a negative effect on the car's stability and driving characteristics.
- Any damage caused by the fitting of unapproved combinations of wheel rim size and tyre size is not covered by the new car warranty. Polestar accepts no liability for death, personal injury or any costs caused by such installations.

## IMPORTANT

Tyres should be stored in a cool, dry and dark place, and should never be stored close to solvents, petrol, oils, etc.

# Dimension designation for tyre

Designations for tyre dimension, load index and speed rating.

The car has an approval for the complete vehicle with certain combinations of wheel rims and tyres.

## Designation of dimensions

All tyres have a designation of dimensions, for example: 245/45 R19 98 W

245	Tyre width (mm)
45	Ratio between tyre wall height and tyre width (%)
R	Radial ply
19	Rim diameter in inches
98	Codes for the maximum permitted tyre load, tyre load index (LI)
W	Speed rating for maximum permitted speed, speed rating (SS). (In this case 270 km/h (168 mph).)

## Load index

Each tyre has a certain capacity to carry a load, a load index (LI).

## Speed rating

Each tyre can withstand a certain maximum speed. Tyre speed rating, SS (Speed Symbol), must at least correspond with the car's top speed. The table below shows the maximum permitted speed for each speed rating (SS). The only exception to these regulations is winter tyres<sup>162</sup>, where a lower speed rating may be used. If such a tyre is selected, the car must not be driven more quickly than the tyre is rated for. For example, cars with Q rating tyres must be driven at speeds not exceeding 160 km/h (100

mph). The road conditions and applicable road traffic rules determine how quickly the car can be driven, not the speed rating of the tyres.

Q	160 km/h (100 mph) (used only on winter tyres)
T	190 km/h (118 mph)
H	210 km/h (130 mph)
V	240 km/h (149 mph)
W	270 km/h (168 mph)
Y	300 km/h (186 mph)

## Related information

- Tyres (p. 452)
- Dimension designation for wheel rim (p. 455)
- Approved wheel and tyre sizes (p. 551)
- Minimum permitted tyre load index and speed rating for tyres (p. 552)

## WARNING

The lowest permitted tyre load index (LI) and speed rating (SS) for the tyres for each respective engine variant are shown in the specifications, which can be found in the printed Manual. If a tyre with too low a load index or speed rating is used, it may overheat and be damaged.

## NOTE

The maximum permitted speed is specified in the table.

## Dimension designation for wheel rim

Wheel and rim dimensions are designated in accordance with the examples in the table below. The car has an approval for the complete vehicle with certain combinations of wheel rims and tyres.

Example: 8Jx19x50

8	Rim width in inches
J	Rim flange profile
19	Rim diameter in inches
50	Off-set in mm (distance from wheel centre to wheel contact surface against the hub)

### Related information

- Tyres (p. 452)
- Dimension designation for tyre (p. 454)
- Approved wheel and tyre sizes (p. 551)

## Tyres' rotation direction

Tyres with a tread pattern which are designed to only turn in one direction have the direction of rotation marked with an arrow.

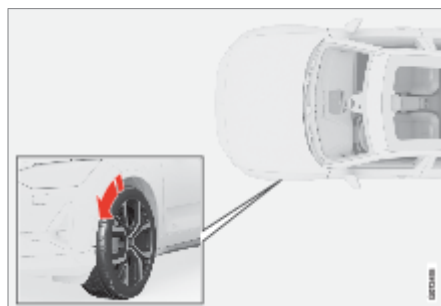

*The arrow shows the tyre's direction of rotation.*

- The tyre must always rotate in the same direction throughout its lifespan.
- If the tyres are fitted incorrectly, the car's braking characteristics and capacity to force rain and slush out of the way are adversely affected.

### Related information

- Tyres (p. 452)

### NOTE

Make sure that both pairs of wheels have the same type, dimension and make. Note that the front and rear pairs of wheels have different dimensions.

## Tread wear indicators on the tyres

Tread wear indicators show the status of the tyre's tread depth.

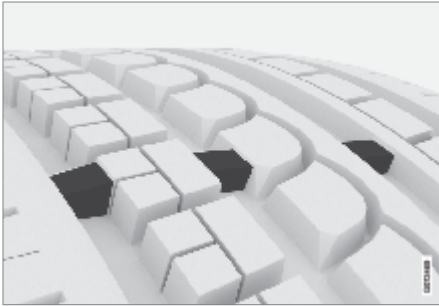

A tread wear indicator is a narrow elevation across the longitudinal grooves of the tyre's tread pattern. On the side of the tyre are the letters TWI (Tread Wear Indicator). When the tyre's tread depth is down to 1.6 mm (1/16 inch), the tread will be level in height with the tread wear indicators. Change to new tyres as soon as possible. Remember that tyres with little tread depth provide very poor grip in rain and snow.

### Related information

- Tyres (p. 452)

## Checking tyre pressure

Correct tyre pressure helps to improve driving stability, save energy consumption and extend the service life of the tyres.

Tyre pressure decreases over time, this is a natural phenomenon. Tyre pressure also varies depending on ambient temperature. Driving on tyres with tyre pressure that is too low could result in the tyres overheating and being damaged. Tyre pressure affects travelling comfort, road noise and driving characteristics.

Check the tyre pressures monthly. Use the recommended tyre pressure for cold tyres in order to maintain good tyre performance. Tyre pressure that is too low or too high may cause uneven wear on the tyres.

### Cold tyres

The tyre pressure must be checked when the tyres are cold. Tyres are considered cold when they have the same temperature as the surrounding air. This temperature is normally reached when the car has been parked for at least three hours.

After having driven approximately 1.6 km (1 mile) these tyres are considered as warm. If you have to drive further than this to inflate the tyres, first check and record the tyre pressure and inflate to a suitable tyre pressure when you arrive at the pump.

When the outside temperature changes, the tyre pressure also changes. A decrease in temperature of 10 degrees causes the tyre pressure to decrease 1 psi (7 kPa). Check the tyre pressure regularly and adjust to the correct pressure, which is specified on the car's tyre information decal or certification label.

If you check the tyre pressure when the tyres are warm then you must never release any air. The tyres are warm due to driving and it is nor-



# Adjusting tyre pressure

mal for the pressure to increase above the recommended pressure for cold tyres. A warm tyre with tyre pressure equal to or below the recommendation for cold tyres may have a pressure that is far too low.

## Related information

- Adjusting tyre pressure (p. 457)
- Recommended tyre pressure (p. 458)
- System for tyre pressure monitoring (p. 459)
- Tyres (p. 452)

## WARNING

- Tyre pressure that is too low is the most common cause of tyre failure and may result in serious cracks in the tyre, the tread loosening or the tyre exploding, with unexpected loss of control of the car and increased risk of personal injury.
- Tyres with pressure that is too low reduce the load capacity of the car.

Tyre pressure decreases over time, this is a natural phenomenon. The tyre pressure must therefore sometimes be adjusted in order to maintain the recommended tyre pressure.

Use the recommended tyre pressure for cold tyres in order to maintain good tyre performance and even tread wear.

1. Remove the cap from the valve on one tyre and then press the tyre pressure gauge firmly down onto the valve.
2. Inflate the tyres to the correct pressure, see the decal on the door pillar on the driver's side showing the recommended pressure for factory fitted tyres.
3. Refit the dust cap.
4. Check the tyres visually for any implanted nails or other objects that could puncture the tyre and cause leakage.
5. Check the sidewalls for any cavities, cuts, bumps or other irregularities.
6. Repeat this for all tyres.

## Related information

- Recommended tyre pressure (p. 458)
- Checking tyre pressure (p. 456)
- Inflating tyres with compressor from the puncture repair kit (p. 477)
- Approved tyre pressures (p. 552)

## Recommended tyre pressure

### NOTE

- To avoid incorrect tyre pressure, the pressure should be checked on cold tyres. "Cold tyres" means the tyres are the same temperature as the ambient temperature (approx. 3 hours after the car has been driven). After a few kilometres of driving, the tyres warm up and the pressure increases.
- After a tyre has been inflated, always refit the dust cap in order to avoid damage to the valve from gravel, dirt, etc.
- Only use plastic dust caps. Metal dust caps can rust and become difficult to unscrew.
- If you have over-inflated, release air by pressing in the metal pin in the centre of the valve. Then check the pressure again using the tyre pressure gauge.

Some spare tyres require a higher tyre pressure than other tyres. Check in the tyre pressure table or on the tyre pressure label.

The tyre pressure label on the driver's side door pillar shows which pressures the tyres should have at different loads and speed conditions.



*Tyre pressure label location*

The decal displays the designation for the factory-fitted tyres on the car, as well as load limits and tyre pressure.

### Improved economy with ECO pressure

For a light load (max. 3 people) and a speed of up to 160 km/h (100 mph), the ECO pressures can be chosen for more economical electricity consumption. However, the lower comfort pressures are recommended instead if improved noise and travelling comfort are desired.

### Related information

- Checking tyre pressure (p. 456)
- Approved tyre pressures (p. 552)

# System for tyre pressure monitoring

## NOTE

It is not intended that the decals illustrated in the Manual should be exact replicas of those in the car. They are included to show their approximate appearance and locations in the car. The information that applies to your particular car can be found on the decal on the car.

The tyre pressure monitoring system<sup>163</sup>, gives a warning with an indicator symbol in the driver display when the pressure in one or more of the car's tyres is too low.



This symbol illuminates to indicate low tyre pressure. Then check the tyre pressure under Car status in the centre display.

If there is a fault in the system the tyre pressure warning symbol flashes for approximately one minute and then remains illuminated.

## System description

The tyre pressure monitoring system measures differences in rotation speed between the different wheels via the ABS system in order to be able to determine whether they have the correct tyre pressure. If the tyre pressure is too low, the tyre's diameter is changed and, as a result, so is its rotation speed. By comparing the tyres with each other the system can determine whether one or more tyres have pressure that is too low.

## General information on the tyre monitoring system

In the information below, the tyre monitoring system is referred to generically as TPMS.

Each tyre, including the spare tyre, should be checked once a month. When checking, the tyre should be cold and have the air pressure recommended by the car manufacturer specified on the tyre pressure label or in the tyre pressure table. If the car has tyres of a different size than that recommended by the manufacturer, find out what the correct air pressure level is for these.

As an extra safety feature, the car is equipped with a tyre pressure monitoring system (TPMS),

>>

Wheels and tyres 459

which shows when the air pressure in one or more tyres is too low. When the indicator symbol for low air pressure is lit, stop and check the tyres as soon as possible and inflate to the correct air pressure.

Driving with tyres that have tyre pressure that is too low may cause the tyre to overheat, which can cause a tyre failure. Low tyre pressure also reduces fuel efficiency as well as tyre service life, and can affect car handling and stopping ability. Note that TPMS does not replace regular tyre maintenance. It is the driver's responsibility to maintain correct tyre pressure, even if the limit for low tyre pressure has not been reached so that the indicator symbol illuminates.

The car is also equipped with a TPMS system fault indicator, which indicates when the system is not functioning correctly. The TPMS system fault indicator is combined with the indicator symbol for low tyre pressure. When the system detects a fault, the symbol in the driver display will flash for about one minute and then remain illuminated. This procedure will be repeated when the car is started until the fault has been rectified. When the symbol is illuminated, the system's ability to detect or warn of low tyre pressure may be affected.

A TPMS system fault can occur for several reasons, such as after changing to a spare tyre, or changing tyres or wheels that prevent TPMS from functioning correctly.

Always check the indicator symbol for TPMS after changing one or more tyres in order to ensure the new tyre or wheel is working correctly with TPMS.

#### To bear in mind

- Always save a new tyre pressure in the system after changing a wheel or adjusting tyre pressure.

- If you change to tyres of a different size to the ones fitted at the factory, the system must be reset by storing a new tyre pressure for these tyres to avoid false warnings.
- If a spare wheel is used, it is possible that the tyre pressure monitoring system does not work correctly due to the differences between the wheels.
- The system does not replace the need for regular tyre inspection and maintenance.
- It is not possible to switch off the tyre pressure monitoring system.

#### Related information

- Recommended tyre pressure (p. 458)
- See tyre pressure status in the centre display (p. 462)
- Rectifying a warning for low tyre pressure (p. 463)
- Saving new reference value for tyre pressure monitoring (p. 461)
- Tyre pressure monitoring messages (p. 464)

### WARNING

- Incorrect tyre pressure may lead to tyre failure, which could result in the driver losing control of the car.
- The system cannot indicate sudden tyre damage in advance.

# Saving new reference value for tyre pressure monitoring

In order for the system for tyre pressure monitoring<sup>164</sup> to work correctly, a reference value for the tyre pressure must be saved. This must take place every time the tyres are changed or the tyre pressure is changed so that the system can warn about low pressure correctly.

For example, when driving with a heavy load or at high speed above 160 km/h (100 mph), the tyre pressure should be adjusted in accordance with Polestar's recommended tyre pressure values. The system is then reset by saving a new tyre pressure.

Perform the following procedure to store a new tyre pressure as a reference value in the system:

1. Switch off the car.
2. Inflate the tyres to the correct pressure, see the decal on the door pillar on the driver's side showing the recommended pressure for factory fitted tyres.
3. Start the car.
4. Tap on  in the centre display.
5. Press More.
6. Press Car status.
7. Press Store pressure.

A message is shown if storing fails.

## Related information

- Recommended tyre pressure (p. 458)
- Adjusting tyre pressure (p. 457)
- See tyre pressure status in the centre display (p. 462)
- Rectifying a warning for low tyre pressure (p. 463)

- System for tyre pressure monitoring (p. 459)
- Starting the car (p. 372)

# See tyre pressure status in the centre display

With the system for tyre pressure monitoring<sup>165</sup>, tyre pressure status can be viewed in the centre display.

## Checking status

Several minutes driving above 35 km/h (22 mph) are required for the system to become active.

1. Tap on  in the centre display.
2. Press More.
3. Tap on Car status to view the tyre pressure status.

- Rectifying a warning for low tyre pressure (p. 463)
- System for tyre pressure monitoring (p. 459)
- Tyre pressure monitoring messages (p. 464)

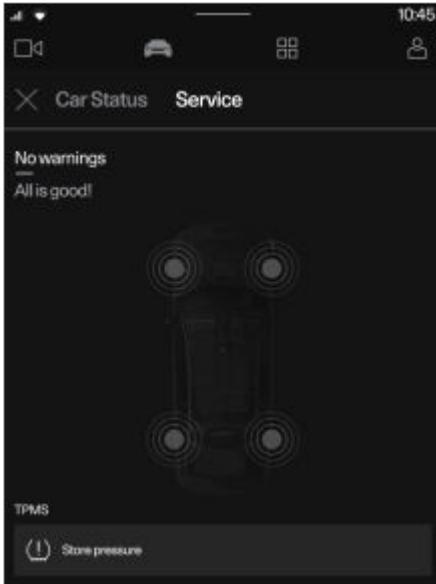

## Related information

- Saving new reference value for tyre pressure monitoring (p. 461)

# Rectifying a warning for low tyre pressure

When the system for tyre pressure<sup>166</sup> warns that tyre pressure is too low, action is required.



Check and rectify the tyre pressure when the indicator symbol for the system is illuminated and a message for low tyre pressure is shown.

1. Switch off the car.
2. Check the tyre pressure in all four tyres with a tyre pressure gauge.
3. Inflate the tyres to the correct pressure, see the decal on the door pillar on the driver's side showing the recommended pressure for factory fitted tyres.
4. Always save a new tyre pressure in the system via the centre display after the tyre pressure has been adjusted.

Note that the indicator symbol does not extinguish until the low tyre pressure has been rectified and storing a new tyre pressure has been started.

## Related information

- Recommended tyre pressure (p. 458)
- Adjusting tyre pressure (p. 457)
- Saving new reference value for tyre pressure monitoring (p. 461)
- See tyre pressure status in the centre display (p. 462)
- System for tyre pressure monitoring (p. 459)
- Inflating tyres with compressor from the puncture repair kit (p. 477)

## WARNING

- Incorrect tyre pressure may lead to tyre failure, which could result in the driver losing control of the car.
- The system cannot indicate sudden tyre damage in advance.

## NOTE

- To avoid incorrect tyre pressure, the pressure should be checked on cold tyres. "Cold tyres" means the tyres are the same temperature as the ambient temperature (approx. 3 hours after the car has been driven). After a few kilometres of driving, the tyres warm up and the pressure increases.
- After a tyre has been inflated, always refit the dust cap in order to avoid damage to the valve from gravel, dirt, etc.
- Only use plastic dust caps. Metal dust caps can rust and become difficult to unscrew.

# Tyre pressure monitoring messages

A number of messages regarding the tyre pressure monitoring system<sup>167</sup> can be displayed. Here are some examples.

Centre display: TPMS unavailable Open Car Status app to Store Pressure	The software has been updated and the tyre pressure needs to be saved again. Check the tyre pressures and inflate if necessary.
Driver display: Tyre pressure low Check Car Status app in center display	The indicator symbol switches on to indicate that there is low tyre pressure in one or more tyres. See car status in the centre display for more information.
Driver display: Tyre pressure system Temporarily unavailable	The indicator symbol flashes and changes to constant glow after approx. 1 minute. The system is currently unavailable, activated shortly.
Driver display: Tyre pressure system Service required	The indicator symbol flashes and changes to constant glow after approx. 1 minute. The system is not working correctly, contact Polestar Support.

## Related information

- System for tyre pressure monitoring (p. 459)
- Saving new reference value for tyre pressure monitoring (p. 461)
- Rectifying a warning for low tyre pressure (p. 463)
- Polestar Support (p. 9)

# Changing wheels

Wheel changes must always be performed correctly. Instructions on how to remove and fit a wheel and what is important to remember are provided below. Check that the tyre dimension is approved for use on the car.

## Removing a wheel

Read through the instructions below before you start. Take out the tools that you will be using before jacking up the car.

1. Activate the hazard warning flashers and set out a warning triangle if a wheel shall be changed in a trafficked location.
2. Ensure that the parking brake is activated.
3. Chock in front of and behind the wheels that remain on the ground. Use, for example, heavy wooden blocks or large stones.
4. Screw together the towing eye with the wheel wrench until the stop position. The towing eye must be screwed into the wheel wrench as far as it will go.





5. Depending on rim equipment:

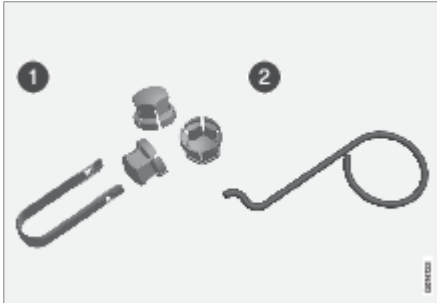

- ① Tool for removing the plastic caps on the wheel nuts.
- ② Tool for removing the wheel nut cap in the centre. Insert the tool into the hole in the middle of the wheel nut cap and pull to remove the cap.

6. With the car still on the ground, use the wheel bolt wrench/towing eye to undo the wheel bolts  $\frac{1}{2}$ -1 turn by pressing downwards (anti-clockwise).
7. Follow the instructions on how to jack up the car safely.
8. Raise the car high enough to allow the wheel to be removed to move freely. Remove the wheel bolts and lift off the wheel.

### Fitting wheels

The car needs to be raised high enough so that the wheel to be loosened can roll freely.

1. Clean the surfaces between wheel and hub.

2. Put on the wheel. Tighten the wheel bolts thoroughly.

Do not use lubricant on the threads of the wheel bolts.

3. Lower the car so that the wheels cannot rotate.
4. Tighten the wheel bolts crosswise. It is important that the wheel bolts are tightened properly. Tighten to 140 Nm (103 foot-pound). Check the tightening torque with a torque wrench.



5. Depending on tyre equipment:

- Place the wheel nut cap back over the wheel nuts by making sure it fits using guide markers, then press it into place.
- Refit the plastic caps over the wheel bolts.

6. Check the tyre pressure and save the new tyre pressure in the system for tyre pressure monitoring.

### Related information

- Raising the car (p. 498)
- Jack (p. 467)

- Wheel bolts (p. 468)
- Saving new reference value for tyre pressure monitoring (p. 461)

## WARNING

- If a wheel must be changed in a trafficked environment, passengers must stand in a safe place.
- Use a jack designed for the car when changing wheels. Use supports to secure the car for all other work.
- Never crawl under the car or reach under with a part of your body when it is raised on a jack.
- Passengers must leave the car when it is raised on the jack.
- The wheel bolts may need to be re-tightened several days after the change. Temperature differences and vibration may mean that they are not attached equally as tightly.

## IMPORTANT

- When the jack is not in use, it must be stored in its place in the foam block in the front cargo area.
- The jack included with the car is only designed for occasional, short-term use, such as when changing a wheel after a puncture. Only the jack belonging to the specific model is to be used to jack up the car. If the car is to be jacked up more often, or for a longer time than is required just to change a wheel, use of a garage jack is recommended. In this instance, follow the instructions for use that come with the equipment.

## NOTE

- After a tyre has been inflated, always refit the dust cap in order to avoid damage to the valve from gravel, dirt, etc.
- Only use plastic dust caps. Metal dust caps can rust and become difficult to unscrew.

## Tool kit

Tools that can be useful during towing, wheel changes or similar are stored in the car's storage area under the bonnet.



*Examples of tools in the car.*

- ① Jack
- ② Tool for lockable wheel bolts
- ③ Funnel for topping up fluids
- ④ Wheel wrench and towing eye

### Related information

- Changing wheels (p. 464)
- Jack (p. 467)
- Wheel bolts (p. 468)
- Emergency puncture repair kit (p. 472)
- Fitting and removing the towing eye (p. 406)

## Jack

The jack can be used to raise the car, for example, to change the wheel.

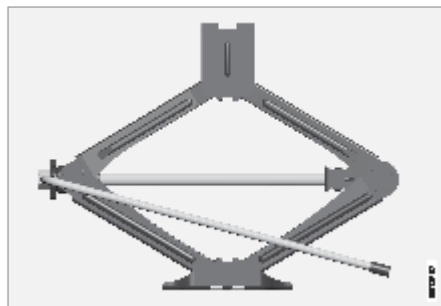

When the jack is not in use, it must be stored in its place in the storage compartment under the bonnet.

The jack needs to be cranked together to the correct position in order to have space.

### Related information

- Changing wheels (p. 464)
- Tool kit (p. 467)
- Raising the car (p. 498)

# Wheel bolts

## IMPORTANT

The jack included with the car is only designed for occasional, short-term use, such as when changing a wheel after a puncture. Only the jack belonging to the specific model is to be used to jack up the car. If the car is to be jacked up more often, or for a longer time than is required just to change a wheel, use of a garage jack is recommended. In this instance, follow the instructions for use that come with the equipment.

Wheel bolts are used to attach the wheels to the hubs.

Only use rims that are tested and approved by Polestar and which are Polestar genuine accessories.

Check the tightening torque of the wheel bolts with a torque wrench.

Do not use lubricant on the threads of the wheel bolts.

### Locking wheel bolts

To loosen or tighten the lockable wheel bolts – turn the wrench in the lock bolt until it fully engages in the code grooves. Always start with the lockable wheel bolts if the wheel shall be removed. When fitting the wheel, finish with the lock screw.

When the wheel wrench is not in use, it must be stored in its place in the storage compartment under the bonnet. It is important to remember this if the car is due to visit a workshop in order to have the tool available. If you lose the wrench, contact Polestar Support.

### Related information

- Changing wheels (p. 464)

## WARNING

The wheel bolts may need to be re-tightened several days after the change. Temperature differences and vibration may mean that they are not attached equally as tightly.

# Winter tyres

## IMPORTANT

- The wheel bolts must be tightened to 140 Nm. (103 foot-pound). Overtightening or loose tightening may damage the nuts and the bolts.
- Remember not to use bending force when you loosen/tighten the wheel bolts. This could damage the code groove in the lock bolt and the wheel wrench and so make it impossible to fit/remove the wheel.

Winter tyres are adapted for winter road conditions.

Polestar recommends winter tyres with particular dimensions. Tyre dimensions are dependent on engine variant. When driving on winter tyres, the correct type of tyres must be fitted to all four wheels.

Contact Polestar Support for advice on the most suitable rims and tyre types to use.

### Tips for changing to winter tyres

When summer and winter wheels are changed, mark which side of the car they were mounted on, for example L for left and R for right.

### Studded tyres

Studded winter tyres should be run in gently for 500-1000 km (300-600 miles), so the studs settle properly into the tyres. This gives the tyre, and especially the studs, a longer service life.

### Tread depth

Road conditions with ice, slush and low temperatures place considerably higher demands on tyres than summer conditions. Polestar therefore recommends not to drive on winter tyres that have a tread depth of less than 4 mm (0.15 inches).

### Related information

- Changing wheels (p. 464)
- Winter driving (p. 395)
- Tread wear indicators on the tyres (p. 456)
- Approved wheel and tyre sizes (p. 551)
- Polestar Support (p. 9)

# Snow chains

## NOTE

Legal regulations for the use of studded tyres may vary. Always comply with local regulations and laws.

Use of snow chains and/or winter tyres can help to improve the traction in winter conditions.

Polestar recommends that snow chains are not used on wheel dimensions greater than 20 inches.

Snow chains must only be used on the front wheels (also applies to all-wheel drive cars).

You can get more information on snow chains from Polestar Support.

## Related information

- Winter driving (p. 395)
- Polestar Support (p. 9)

## WARNING

Use Polestar genuine snow chains or equivalent chains designed for the car model, and tyre and rim dimensions. Only single-sided snow chains are permitted.

If you are not sure about the snow chains – contact Polestar Support. The wrong snow chains may cause serious damage to the car and lead to an accident.

# Punctures

## IMPORTANT

Snow chains can be used on the car with the following restrictions:

- Always follow the mounting instructions from the manufacturer carefully. Fit the chains as tensioned as possible and tension them at regular intervals.
- In some cases, snow chains must NOT be used, such as if accessory, after-market or "special" tyres and wheels are fitted that have a different size to the original tyres and wheels. Sufficient distance must be maintained between the chains and brakes, suspension and body components.
- Check local regulations with regard to using snow chains before fitting them.
- Never exceed the chain manufacturer's specified maximum speed. You must never exceed 50 km/h (30 mph) under any circumstances.
- Avoid bumps, holes or sharp turns when driving with snow chains.
- Avoid driving on bare ground as this wears out both the snow chains and tyres.
- Driving with snow chains may have a negative effect on the car's driving characteristics. Avoid fast or sharp turns, as well as braking with locked wheels.
- Some types of chain that are firmly tensioned affect brake components and must therefore NOT be used.

Activate the hazard warning flashers if the car has a puncture in a trafficked environment.

Think about safety. If possible, move the car out of danger from traffic. Call roadside assistance if necessary.

If possible, exit the car from the side with least traffic.

Put on a reflective vest and then position the warning triangle so that other road users are warned in good time.

### Dealing with a puncture

The car is equipped with an emergency puncture repair kit<sup>168</sup> for temporary tyre repair, read the instructions prior to use.

### Related information

- Hazard warning flashers (p. 140)
- Warning triangle (p. 492)
- Recovery (p. 407)
- Towing (p. 405)
- Emergency puncture repair kit (p. 472)
- Roadside assistance with Polestar Connect (p. 434)

# Emergency puncture repair kit

The emergency puncture repair kit (TMK<sup>169</sup>) is used to seal a puncture as well as to check and adjust the air pressure in the tyre.

The puncture repair kit consists of a compressor and a bottle with sealing fluid. The sealing works as a temporary repair.

## Location

The emergency puncture repair kit is located in the storage compartment under the bonnet.



## Sealing fluid expiry date

The bottle of sealing fluid must be replaced if the bottle's expiry date has passed (see the decal on the bottle). Treat the old bottle as environmentally hazardous waste.

## Related information

- Using a puncture repair kit (p. 473)
- Inflating tyres with compressor from the puncture repair kit (p. 477)
- Tyres (p. 452)

## NOTE

- The sealing fluid is effective at sealing tyres with tread punctures but should not be used to seal tyres with sidewall punctures. Do not use the emergency puncture repair kit on tyres displaying larger slits, cracks or similar damage.
- The compressor is intended for temporary emergency puncture repair and is approved by Polestar.



# Using a puncture repair kit

The emergency puncture repair kit (TMK<sup>170</sup>) can be used to seal a puncture. Read through all instructions prior to use.

## Overview

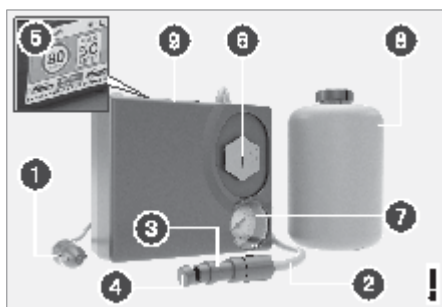

- ① Electrical cable
- ② Air hose
- ③ Pressure reducing valve
- ④ Protective cap
- ⑤ Label, maximum permitted speed
- ⑥ Bottle holder (orange cap)
- ⑦ Pressure gauge
- ⑧ Sealing fluid bottle
- ⑨ Switch

## Connecting

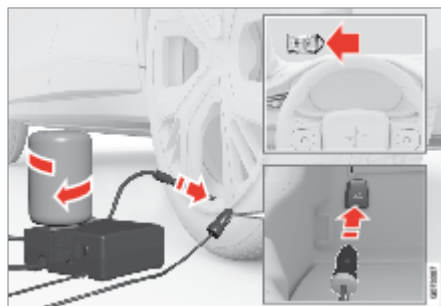

1. Preparations  
Set up the warning triangle and activate the hazard warning lights if a tyre is being sealed in a trafficked location.  
If the puncture was caused by a nail or similar, allow this to remain in the tyre. It helps to seal the hole.
2. Detach the decal for maximum permitted speed that is affixed on one side of the compressor. Affix it visibly on the windscreen as a reminder to observe the speed limit. You should not drive faster than 80 km/h (50 mph) after the emergency tyre repair kit has been used.
3. Check that the switch is in position 0 (Off), and locate the electrical cable and the air hose.
4. Unscrew the orange-coloured cap from the compressor, and unscrew the cork from the sealing fluid bottle.

5. Screw in the bottle to the bottom of the bottle holder.

The bottle and the bottle holder are equipped with a reverse catch to prevent sealant leakage. When the bottle is screwed in it cannot be unscrewed from the bottle holder again. The bottle has to be removed at a workshop – contact Polestar Support.

6. Unscrew the tyre's dust cap and screw in the air hose's valve connection to the bottom of the thread on the tyre's air valve.

Check that the pressure reducing valve on the air hose is fully screwed in.

7. Commence tyre sealing

Connect the electrical cable to the closest 12 V socket and start the car. Make sure that none of the other 12 V sockets is being used when the compressor is operating.

8. Start the compressor by flicking the switch to position I (On).

When the compressor starts, the pressure may increase to 6 bar (88 psi) but then fall again after approx. 30 seconds.

9. Inflate the tyre for 7 minutes.

10. Switch off the compressor to check the pressure on the pressure gauge. Minimum pressure is 1.8 bar (22 psi) and maximum is 3.5 bar (51 psi). Release air using the pressure reducing valve if the tyre pressure is too high.

11. Switch off the compressor and detach the electrical cable.

12. Unscrew the air hose from the tyre valve and refit the dust cap on the tyre.

13. Fit the protective cap on the air hose in order to avoid leakage of the remaining sealing fluid. Place the equipment in the cargo area.

14. As soon as possible, drive at least 3 km (2 miles) at a maximum speed of 80 km/h (50 mph) so that the sealing fluid can seal the tyre, and then perform a follow-up check.

15. Follow-up inspection

Connect the air hose on the tyre valve and screw in the valve connection to the bottom of the tyre valve's thread. The compressor must be switched off.

16. Read the tyre pressure on the pressure gauge.

- If it is below 1.3 bar (19 psi) then the tyre is insufficiently sealed. The journey should not be continued. Call roadside assistance for recovery.
- If the tyre pressure is higher than 1.3 bar (19 psi), the tyre must be inflated to the pressure specified in accordance with the tyre pressure label on the driver's side door pillar (1 bar = 100 kPa = 14.5 psi). Release air using the pressure reducing valve if the tyre pressure is too high.

Polestar recommends that the car is driven to the nearest workshop<sup>171</sup> for replacement/repair of the damaged tyre. Advise the workshop that the tyre contains sealing fluid.

The sealing fluid bottle and hose must be replaced after use – contact Polestar Support.

#### Related information

- Recommended tyre pressure (p. 458)

- Emergency puncture repair kit (p. 472)
- Inflating tyres with compressor from the puncture repair kit (p. 477)
- Polestar Support (p. 9)

## WARNING

- Please keep the following points in mind when using the tyre sealing system:
  - The sealing fluid bottle contains 1) rubber latex, natural and 2) ethane-diol. These substances are harmful if swallowed.
  - The contents of this bottle may cause allergic skin reactions or otherwise be potentially harmful to the respiratory tract, the skin, the central nervous system, and the eyes.

### Precautions:

- Store out of the reach of children.
- Harmful if ingested.
- Avoid prolonged or repeated contact with the skin. If sealing fluid has come into contact with your clothes, remove them.
- Wash thoroughly after handling.

### First aid:

- Skin: Wash affected areas of skin with soap and water. Get medical attention if symptoms occur.
- Eyes: Flush with plenty of water for at least 15 minutes, occasionally lifting the upper and lower eyelids. Get medical attention if symptoms occur.
- Inhalation: Move the exposed person to fresh air. If irritation persists, get medical attention.

## WARNING

- Ingestion: Do NOT induce vomiting unless directed to do so by medical personnel. Get medical attention.
- Disposal: Dispose of this material and its container at a hazardous or special waste collection point.
- Do not remove the bottle or air hose when the puncture repair kit is being used.
- Do not unscrew the bottle, it is equipped with a reverse catch to prevent leakage.
- Do not leave children in the car without supervision when the engine is running.
- Never stand next to the tyre when the compressor is running. If cracks or unevenness arise then the compressor must be switched off immediately. The journey should not be continued. Call roadside assistance for recovery to a tyre centre. Contacting Polestar Support is recommended.
- If the pressure is below 1.8 bar (22 psi) then the hole in the tyre is too big. The journey should not be continued. Call roadside assistance for recovery to a tyre centre. Contacting Polestar Support is recommended.
- Sealant will spurt out of the puncture during the first few rotations of the tyre. Make sure that nobody is standing near the car and gets the sealing fluid splashed onto them when the car is driven away. The distance should be at least 2 metres (7 feet).

## WARNING

- Check the tyre pressure regularly.
- Maximum mileage with tyres containing sealing fluid is 200 km (120 miles).

## IMPORTANT

The compressor must not be operated for longer than 10 minutes - risk of overheating.

## NOTE

- Do not break the bottle's seal before use. The seal is broken automatically when the bottle is screwed in.
- After a tyre has been inflated, always refit the dust cap in order to avoid damage to the valve from gravel, dirt, etc.
- Only use plastic dust caps. Metal dust caps can rust and become difficult to unscrew.
- The compressor is an electrical device. Follow local regulations related to waste management.

# Inflating tyres with compressor from the puncture repair kit

The car's original tyres can be inflated using the compressor in the emergency puncture repair kit.

1. The compressor must be switched off. Make sure that the switch is in position 0 (Off), and take out the electrical cable and the air hose.
2. Unscrew the tyre's dust cap and screw in the air hose's valve connection to the bottom of the thread on the tyre's air valve.  
Check that the pressure reducing valve on the air hose is fully screwed in.
3. Connect the electrical cable to the closest 12 V socket and start the car.
4. Start the compressor by flicking the switch to position I (On).
5. Inflate the tyre to the pressure specified on the tyre pressure label on the driver side door pillar. Release air using the pressure reducing valve if the tyre pressure is too high.
6. Switch off the compressor. Detach the air hose and the electrical cable.
7. Refit the dust cap on the tyre.

## Related information

- Recommended tyre pressure (p. 458)
- Using a puncture repair kit (p. 473)
- Emergency puncture repair kit (p. 472)

## IMPORTANT

The compressor must not be operated for longer than 10 minutes - risk of overheating.

## NOTE

- After a tyre has been inflated, always refit the dust cap in order to avoid damage to the valve from gravel, dirt, etc.
- Only use plastic dust caps. Metal dust caps can rust and become difficult to unscrew.
- The compressor is an electrical device. Follow local regulations related to waste management.

## WARNING

Do not leave children in the car without supervision when the engine is running.



## Section 17

—

Loading, storage and  
passenger  
compartment

# Passenger compartment interior

Overview of the passenger compartment's interior and storage locations.

## Front seat

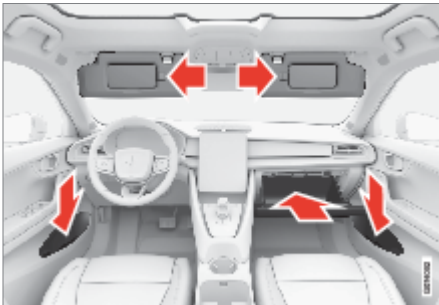

Storage in the door panel, glovebox with extendable hook and sun visor.



Storage compartment in legroom, USB ports beside the wireless phone charger, cup holder and storage under the armrest in the tunnel console.

## Rear seat

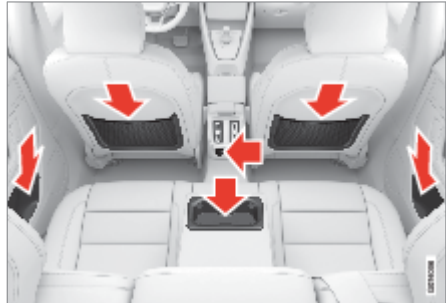

Storage compartment in the door panel, cup holder in the centre seat backrest, storage pocket on the back of the front seat and USB ports in the tunnel console.

## Related information

- Electrical sockets (p. 484)
- USB ports (p. 482)
- Using the glovebox (p. 486)
- Sun visors (p. 486)
- Tunnel console (p. 481)

## WARNING

Keep loose objects such as phones, cameras, remote controls for accessories, etc., in the glove compartment or other compartments. Otherwise they may injure people in the car in the event of sudden braking or a collision.



# Tunnel console

## IMPORTANT

Keep in mind that high gloss surfaces, for example, are easily scratched by metal objects. Do not place keys, phones and other items on sensitive surfaces.

The tunnel console is located between the front seats.



- ① Cup holder.
- ② Storage compartment with removable cup holder under the armrest. The armrest can be adjusted for length and opens with a press of the button.
- ③ Climate controls for the rear seat's climate control functions and two USB ports (type C).

### Related information

- Passenger compartment interior (p. 480)
- USB ports (p. 482)
- Electrical sockets (p. 484)
- Climate controls (p. 181)

## USB ports

### WARNING

Keep loose objects such as phones, cameras, remote controls for accessories, etc., in the glove compartment or other compartments. Otherwise they may injure people in the car in the event of sudden braking or a collision.

### IMPORTANT

Keep in mind that high gloss surfaces, for example, are easily scratched by metal objects. Do not place keys, phones and other items on sensitive surfaces.

### NOTE

- One of the detectors for the alarm is located under the tunnel console's cup holder. Avoid leaving coins, keys and other metal objects in the cup holder, since this may trigger the alarm.
- The USB ports can be used to charge a phone or tablet, for example.

There are two USB ports (type C) under the centre display. There are also two USB ports (type C) in the rear part of the tunnel console.



*USB ports (type C), front seat.*



*USB ports (type C) in tunnel console, rear seat.*

The USB ports can be used to charge a phone or tablet, for example.

### Related information

- Charging devices via USB ports (p. 483)
- Passenger compartment interior (p. 480)
- Using electrical sockets (p. 484)

# Charging devices via USB ports

The USB ports can be used to charge a phone or tablet, for example.

The USB ports can be used when the car is in Comfort or Drive mode.

The ports are switched off automatically when the driver leaves the car. If the car remains unlocked or is locked with reduced alarm level, the ports are active for approximately a further 10 minutes.

## Charging devices via USB ports

1. Fold down the cover in front of the port and connect the plug for the accessory.
2. Disconnect the plug for the accessory and fold up the cover when the port is not in use or is left unsupervised.

## Technical specification for USB-C port

- Type C port
- Version 3.1
- Voltage supply 5 V
- Current supply max. 3.0 A

## Related information

- USB ports (p. 482)
- Reduced alarm level (p. 239)
- Usage modes (p. 373)

## NOTE

Accessories that are connected to the ports may be activated even when the car's electrical system is disconnected or if preconditioning is used. For this reason, disconnect accessories when not in use.

Some devices may get hot during charging. This is normal.

## WARNING

- Position the accessory so that it is not at risk of injuring the driver or passengers in the event of heavy braking or collision.

## Electrical sockets

There is a 12 V electrical socket in the cargo area.

Contact Polestar Support if there are any problems with the electrical socket.

### 12 V electrical socket

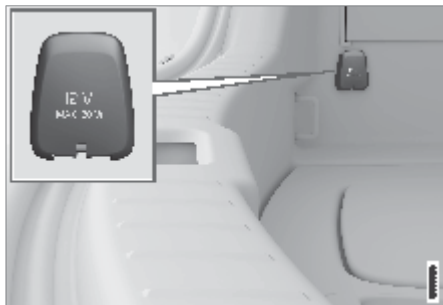

*12 V electrical socket in cargo area.*

The 12 V socket can be used for various accessories designed for this, such as cooler boxes.

### Related information

- Passenger compartment interior (p. 480)
- Using electrical sockets (p. 484)
- USB ports (p. 482)

## Using electrical sockets

The 12 V socket can be used for various accessories designed for this, such as cooler boxes.

In order for the socket to supply current, the car must be in Comfort or Drive mode.

The socket is switched off automatically when the driver leaves the car. If the car remains unlocked or is locked with reduced alarm level, the socket is active for approximately a further 10 minutes.

### Using 12 V sockets

1. Fold down the cover in front of the socket and connect the plug for the accessory.
2. Disconnect the plug for the accessory and fold up the cover when the socket is not in use or is left unsupervised.

### Related information

- Electrical sockets (p. 484)
- Passenger compartment interior (p. 480)
- USB ports (p. 482)
- Reduced alarm level (p. 239)
- Usage modes (p. 373)

## WARNING

- Do not use accessories with large or heavy connectors - they can damage the socket or come loose when driving.
- Do not use accessories that can cause interference to the car's radio receiver or electrical system for example.
- Position the accessory so that it is not at risk of injuring the driver or passengers in the event of heavy braking or collision.
- Keep an eye on connected accessories as they can generate heat that can burn passengers or the interior.
- Only use accessories that are undamaged and fault-free. The accessories must have a CE marking, UL marking or an equivalent safety marking.
- Never allow sockets, connectors or accessories to come into contact with water or other liquids. Do not touch or use the socket if it appears to be damaged or has come into contact with water or other liquid.
- Do not connect junction sockets, adapters or extension cables to the socket as these can override the socket's safety features.

Failure to follow the advice given above can lead to severe or fatal electric shocks.

## IMPORTANT

The maximum power takeoff is 120 W (10 A).

## NOTE

Accessories that are connected to the electrical socket may be activated even when the car's electrical system is disconnected or if preconditioning is used. For this reason, disconnect contacts when not in use.

## Using the glovebox

The glovebox is located on the passenger side. The printed information can be kept in the glovebox, for example. There is also space for a pen and card holder.



The hook on the glovebox can be folded out when the glovebox is open so that it can then be used when the glovebox is closed.

### Related information

- Passenger compartment interior (p. 480)
- Available information (p. 8)

### IMPORTANT

Retract the hook fully before closing the glove box, otherwise it may break.

## Sun visors

There are sun visors in the roof in front of the driver seat and the front seat passenger seat which can be folded down and angled out to the side when necessary.



The mirror light comes on automatically when the cover is opened.

There is a holder for cards or tickets, for example, on the sun visor.

### Related information

- Passenger compartment interior (p. 480)

# Luggage compartment and cargo area

## Recommendations for loading

The car has a flexible cargo area that makes it possible to transport and secure large objects. There is also a front luggage compartment under the bonnet.

### Cargo area

Folding down the backrests in the rear seat can make the cargo area very spacious. Use load retaining eyelets or bag holders to hold the load securely in place. The parcel shelf can be removed in order to provide space for bulky loads. There is an extra storage space under the cargo area floor.

### Front cargo area

There is additional storage space under the bonnet. The car's warning triangle, tool kit, towing eye and emergency puncture repair kit are also stored in the cargo area.

### Related information

- Recommendations for loading (p. 487)
- Load retaining eyelets (p. 490)
- Opening and closing the bonnet (p. 501)
- Closing and locking the tailgate with the button (p. 201)
- Folding the backrest in the rear seat (p. 167)

There are a number of things that are important to bear in mind when loading the car.

Payload depends on the car's kerb weight. The total of the weight of the passengers and all accessories reduces the car's payload by a corresponding weight.

### Loading the cargo area

Good things to remember when loading:

- Position the load firmly against the rear seat's backrest.
- Heavy objects should be placed as low as possible. Avoid placing heavy loads on lowered backrests.
- Cover sharp edges with something soft to avoid damaging the upholstery.
- Secure all loads to the load retaining eyelets with straps or web lashings.

### Extending the cargo area

The rear seat backrests can be folded down to extend the cargo area and simplify loading. Note that no objects should impede the function for the Whiplash Protection System (WHIPS) in the front seats if any of the rear seat backrests are folded down.

A through-load hatch in the rear seat can be folded down when transporting long and narrow loads.

### Related information

- Load retaining eyelets (p. 490)
- Weights (p. 544)
- Whiplash Protection System (p. 30)

## Roof load and loading on load holder

### WARNING

- The car's driving properties change depending on the weight and positioning of the load.
- A loose object weighing 20 kg (44 pounds) can, in a frontal collision at a speed of 50 km/h (30 mph) carry the impact of an item weighing 1000 kg (2200 pounds).
- Leave 10 cm (4 inches) space between the load and the side windows if the car is loaded to above the top edge of the door windows. Otherwise, the intended protection of the inflatable curtain, which is concealed in the headlining, may be compromised.
- Always secure the load. Always secure the load. During heavy braking the load may otherwise shift, causing personal injury to the car's occupants.

Cover sharp edges and sharp corners with something soft.

Use the parking brake when loading/unloading long objects.

When loading onto the roof of the car, a load holder recommended by Polestar should be used.

The aim of this is to reduce the risk of damage to the car, and to maintain safety while travelling.

Carefully follow the mounting instruction supplied with the load holder.

- Distribute the load evenly over the load holders. Place the heaviest load at the bottom.
- Check regularly to ensure that the load holders and load are secured properly. Lash the load securely using bungees.
- If the load extends beyond the front of the car – a canoe or kayak, for example – fit the towing eye in its front socket and use that to attach a bungee to.
- The larger the load, the more the car is exposed to the wind, thereby increasing its energy consumption.
- Drive gently. Avoid violent acceleration, heavy braking and hard cornering.

### Related information

- Recommendations for loading (p. 487)
- Weights (p. 544)

### WARNING

The centre of gravity and driving characteristics of the car change when carrying a load on the roof.

Comply with the car's specifications with regard to weight and maximum permitted load.



# Bag hooks

Bag hooks hold bags in position and prevent them tipping up and spreading their contents throughout the cargo area.

## Along the sides

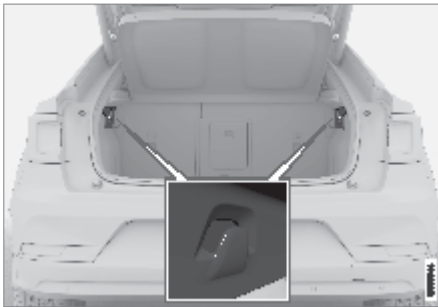

There are two bag hooks in the side panels – one on either side of the cargo area.

## Under the floor hatch



There are two bag hooks and an elastic band in the cover (part of the floor hatch) in the cargo area.

Open up the cover to be able to use the bag hooks. Secure the bags in an appropriate position using the elastic band supplied. If the bags

have handles and are of an appropriate height – hang them from the hooks.

## In the glovebox

There is also a fold-out hook in the glovebox that can be used to hang a bag on.

## Related information

- Recommendations for loading (p. 487)
- Using the glovebox (p. 486)

## IMPORTANT

A maximum weight of 5 kg (11 lbs) may be applied to the bag hooks.

## Load retaining eyelets

Use the load retaining eyelets to attach straps in order to anchor items in the cargo area.



### Related information

- Recommendations for loading (p. 487)
- Weights (p. 544)

## WARNING

Hard, sharp and/or heavy objects which protrude may cause injury under violent braking.

Always secure large and heavy objects with a seatbelt or cargo retaining straps.

## Through-load hatch in the rear seat

The hatch in the rear seat backrest can be opened in order to transport long, narrow objects such as skis.



1. In the cargo area, take hold of the handle for the hatch and fold down the hatch.
2. Fold the rear seat armrest forward.
3. Adjust the centre seat head restraint upwards so that the steel tubes do not block the hatch opening.

If the private locking function is used, the through-load hatch must be closed.

### Related information

- Recommendations for loading (p. 487)
- Load retaining eyelets (p. 490)

## Removing the parcel shelf

The parcel shelf can be removed to increase the size of the cargo area.

### Removing the parcel shelf



1 Detach the parcel shelf's lifting eyes on both sides.

2 Unhook the parcel shelf at the front edge and remove it.

Store the removed parcel shelf in a place where it will not be damaged.

### Related information

- Luggage compartment and cargo area (p. 487)

## First aid kit

The first aid kit contains first aid equipment.

Store the first aid kit in an appropriate place in the cargo area, e.g. in the mesh pocket on the right-hand side.

### Related information

- Luggage compartment and cargo area (p. 487)

# Warning triangle

Use the warning triangle to warn other road users if the car is stationary in traffic.

Also activate the hazard warning flashers.

## Storage spaces

The warning triangle is located under the floor in the front cargo area.

## Folding up the warning triangle

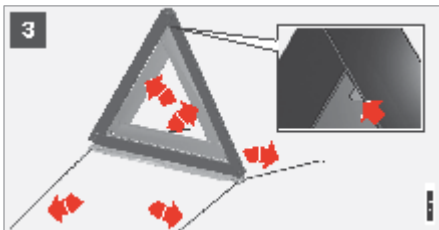
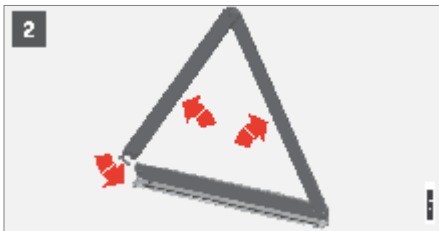

**1** The warning triangle is stored under the floor in the front cargo area.

**2** Remove the warning triangle from the case, unfold it and put the ends together.

**3** Fold out the warning triangle's support legs.

Follow the regulations for the use of a warning triangle. Position the warning triangle in a suitable place with regard to traffic.

Put the warning triangle and case back into the front cargo area after use.

## Related information

- Hazard warning flashers (p. 140)
- Opening and closing the bonnet (p. 501)

## Section 18

—

## Maintenance and service

# Polestar service programme

To keep the car as safe and reliable as possible, Polestar's service programme as specified in Status and Warranty should be followed.

Contact Polestar Support for help with finding a recommended workshop for servicing and maintenance. These workshops have the staff with the right competence, service literature, and special tools in order to provide the highest service quality.

## Service and repair

Service the car regularly. Follow Polestar's recommended service intervals.

If inspection and repair are required then only an authorised workshop designated by Polestar may carry out the work.

## Charging cable with control unit

### Related information

- Book service and repair (p. 495)
- Connection of equipment to the car's diagnostic socket (p. 23)
- Servicing the climate control system (p. 501)
- Brake system maintenance (p. 378)

## WARNING

Do not carry out any repairs of your own on your car. Electrical cables and/or components that have detached must only be rectified by an authorised workshop – contact Polestar Support.

## IMPORTANT

- Please check the Status and Warranty and comply with the specifications there, otherwise the Polestar warranty will be invalid.
- Do not modify the control unit in any way.

# Book service and repair

Contact Polestar Support if servicing or repairs are required.

Polestar will contact you when it is time for servicing, and in some cases when the car needs repairs. It is fine for you to contact Polestar Support yourself, e.g. if a message appears in the driver display or at the top of the centre display. The service date is determined by how much time has passed, hours that the engine has been running, or distance driven since the last service.

Let someone know if there is anything else you would like done during the workshop visit or any other important information to your workshop.

The message indicating that your car needs a service is switched off when a service has been carried out.

## Related information

- Messages in the driver display (p. 104)
- Polestar Support (p. 9)

# Data transfer between car and workshop via Wi-Fi

Some workshops have a specific Wi-Fi network for data transfer between your car and the workshop. Your workshop visit will be simpler and more efficient when the transfer of diagnostic information and software can take place via the workshop's network.

During a workshop visit, your service technician may want to connect your car to the workshop's network via Wi-Fi to perform fault-tracing and software download. For this type of communication, the car only connects to a workshop's network. It is not possible to connect the car to another Wi-Fi network, such as at home, in the same way as to a workshop's network.

## Connection with a key

Connection is normally handled by the service technician who then uses the key buttons. That's why it's important to take a key with buttons with you for the workshop visit. Press three times on the lock button on the key to connect the car to the workshop's network via Wi-Fi.

When the car is connected to a Wi-Fi network, the  symbol appears in the centre display.

## Related information

- Book service and repair (p. 495)

## WARNING

The car must not be driven when connected to the workshop's networks and systems.

# Managing system updates

New software will be sent to the car when an update of the systems is required. It is important to install the latest updates as soon as possible.

## Criteria

To be able to implement the system updates requires the following:

- the car is connected to the Internet<sup>172</sup>.
- approval is given for use of connected services.
- the car's doors are closed and locked.

## Choose time for updating

If there is an update available, a message is shown in the centre display when you get into the car. Then you can choose the time for installation most suitable for you:

Later	The message appears in the notification view and you can think about it later on. A new reminder about installation is received when next driving.
Install immediately	The installation is started when you exit and lock the car.
Choose time	Schedule the installation for up to a week ahead. When the time approaches, reminders will be given if the car is used. At the scheduled time, the car is updated automatically. You can change the time via the notification view.

A message will appear in the centre display when the update is done, as well as in the event of any errors. In the event that the installation

fails, the car's systems are reset to the last installed version.

## Updating while charging

Any charging of the car will be interrupted in the event of system update if the battery level is not too low. Depending on charging source, the charging will be resumed after installation.

## Information on contents

To see more information on what the updated software contains you can tap on the symbol with an "i".

## Related information

- Approval of terms and conditions and data collection (p. 21)
- Reduced alarm level (p. 239)
- Detachable key blade (p. 217)

## NOTE

- Important to know:
  - The car is not available while installation is in progress. This may also apply to functions normally used when the car is parked, e.g. parking heater.
  - If you need to enter the car while installation is in progress, you must use the key blade.
  - To avoid false alarms, the car's anti-theft alarm is disarmed while installation is in progress.

<sup>172</sup> Use of the Internet involves data transfer (data traffic), which may involve charges. Polestar meets the cost of data traffic for system updates unless a personal SIM card is installed.



## NOTE

- It is important to install new software as soon as possible in order to avoid the risks that may be associated with old software. In the event of any problem with system updates – contact Polestar Support.
- Functionality after updating may vary depending on market, model, model year and options.

# Raising the car



*The triangles in the plastic cover indicate the locations of the lifting points (marked in red).*

When raising the car, it is important that the jack is fitted in the intended points on the car's underbody.

Read through the instructions below before you start. Take out the tools that you will be using before jacking up the car.

1. Set up the warning triangle and activate the hazard warning lights if a tyre is being changed in a location where there is lots of traffic, for example.
2. Ensure that the parking brake is activated.
3. Chock in front of and behind the wheels that remain on the ground. Use, for example, heavy wooden blocks or large stones.

4. Place the jack or the lifting arms in the designated locations on the car's chassis. The triangle markings in the plastic cover indicate the locations of the jacking/lifting points. There are two jacking points on each side of the car. There is a recess for the jack at each point.

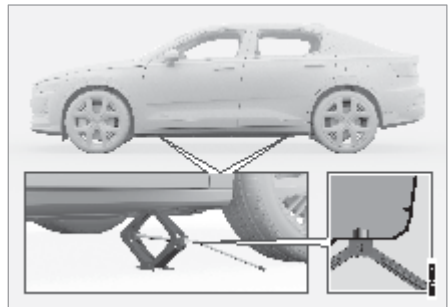

5. Position the jack on level, firm and non-slippery ground under the jacking point that will be used.

6. Crank up until it is correctly aligned and so that it makes contact with the car's jacking point. Check that the head of the jack (or lifting arms at a workshop) is correctly positioned in the jacking point so that the bump in the centre of the head fits into the jacking point hole, and check that the base of the jack is positioned vertically below the jacking point.
7. Turn the jack so that the crank is as far away from the side of the car as possible, at which point the jack's arms are perpendicular to the direction of the car.
8. Raise the car to an appropriate height, depending on what is to be done.

#### Related information

- Jack (p. 467)
- Changing wheels (p. 464)
- Tool kit (p. 467)

## WARNING

- • Check that the jack is not damaged, that the threads are thoroughly lubricated and that it is free from dirt.
- Check that the jack is resting on a firm, level surface that is not slippery and is not slanted.
- Never position anything between the ground and the jack, nor between the jack and the car's jacking point.
- Passengers must leave the car when it is raised on the jack.
- If a wheel has to be changed in an environment where there is lots of traffic, for example, passengers must remain in a safe place.
- Use a jack designed for the car when changing wheels. Use supports to secure the car for all other work.
- Never crawl under the car or reach under with a part of your body when it is raised on a jack.
- If the car is raised using a workshop jack, this must be placed beneath one of the four jacking points. Take care to position the workshop jack so that the car cannot slip off. Make sure that the jack plate is fitted with a rubber guard so that the car remains stable and is not damaged. Always use axle stands or similar.

## NOTE

Polestar recommends only using the jack that belongs to the car model in question. If a jack is selected other than the one recommended by Polestar, follow the instructions supplied with the equipment.

The normal car jack is only designed for occasional, short-term use, such as when changing a wheel after a puncture. If the car is to be jacked up more often, or for a longer time than is required just to change a wheel, use of a garage jack is recommended. In this instance, follow the instructions for use that come with the equipment.

## Servicing the climate control system

The air conditioning system must only be serviced and repaired by an authorised workshop.

### Troubleshooting and repair

The air conditioning system contains fluorescent tracing agents. Ultraviolet light must be used during leak detection.

Contacting Polestar Support is recommended if you are experiencing problems with the climate control.

Cars with R134a refrigerant

Cars with R1234yf refrigerant

### Related information

- Polestar service programme (p. 494)
- Polestar Support (p. 9)

## WARNING

- The air conditioning system contains pressurised refrigerant R134a. This system must only be serviced and repaired by an authorised workshop.
- The air conditioning system contains pressurised refrigerant R1234yf. In accordance with SAE J2845 (Technician Training for Safe Service and Containment of Refrigerants Used in Mobile A/C System), service and repair of the refrigerant system must only be performed by trained and certified technicians in order to ensure the safety of the system.

## Opening and closing the bonnet

The bonnet can be opened using the handle in the passenger compartment and a handle under the bonnet.

### Open the bonnet

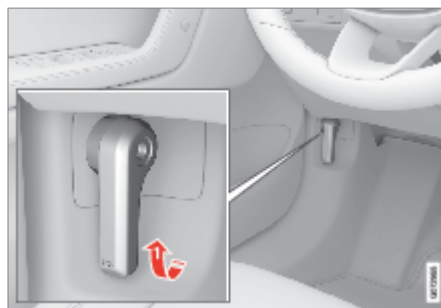

- ➔ Pull the handle to the left of the brake pedal in order to release the bonnet from fully closed position.

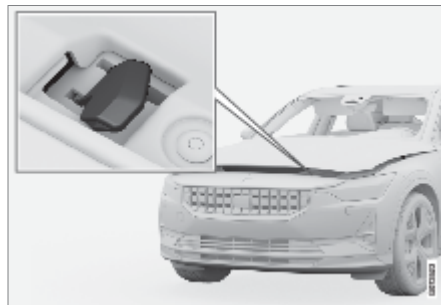

- ➔ Move the handle under the bonnet up to release the bonnet from the lock catches and lift the bonnet.

### Warning - bonnet not closed



When the bonnet is released, a warning symbol and graphics in the driver display will light up and an acoustic reminder will sound.

### Close the bonnet

1. Take hold of the bonnet and bring it down.
- 2.

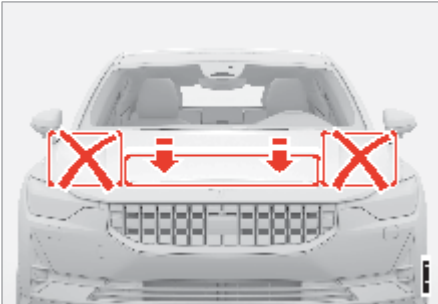

When the bonnet has stopped against the bonnet lock – press down on the bonnet with both hands according to the description in the illustration in order to fully close it. Do not load the outer edges of the bonnet.

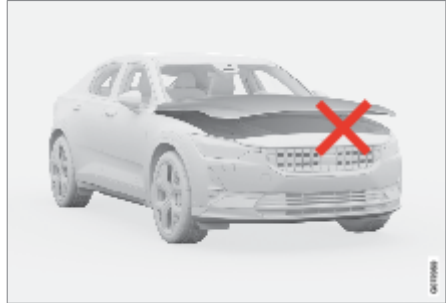

*Bonnet not completely closed.*



*Bonnet completely closed.*

### Related information

- Luggage compartment and cargo area (p. 487)
- Door and seatbelt reminder (p. 37)
- Polestar Support (p. 9)
- Filling washer fluid (p. 538)

# Coolant

## WARNING

- Risk of crushing! Ensure that the closing path under the bonnet is not obstructed, otherwise there is a risk of personal injury.
- Check that the bonnet locks properly when closed. The bonnet must engage at both sides audibly.
- Never drive with an open bonnet!

If there is any sign that the bonnet is not fully closed while driving – stop immediately and close it properly.

## IMPORTANT

Do not try to open the panel around the storage compartment under the bonnet – it may damage the panel. Contact Polestar Support if maintenance is required.

## NOTE

If the warning symbol is illuminated or you hear the warning symbol even though the bonnet is closed properly – contact Polestar Support.

The coolant ensures that the surplus heat is distributed in the circuit, such as to heat the high voltage battery or the passenger compartment.

Prescribed grade: Ready-mixed coolant approved by Polestar.

Contact Polestar Support as soon as possible in the event of a message for coolant level too low or too high.

## Related information

- Polestar service programme (p. 494)

## WARNING

Swallowing coolant is hazardous, it may cause damage to organs (kidneys). The product contains ethylene glycol, inhibitor, emetic, water, etc.

## IMPORTANT



Do not remove the panel around the storage compartment under the bonnet – it may damage the panel. Do not

open the lid of the coolant tank, and do not top up any fluid. Doing this may result in damage that is not covered by the warranty.

The coolant must only be topped up by a workshop – contact Polestar Support.

# Batteries

Your car has a number of different batteries to facilitate electric operation in various ways. The electrical system is single-pole and uses the chassis and frame as a conductor.

## High voltage battery

For operation with the electric motor, the car is equipped with a battery located in the car's chassis. This is maintenance-free and rechargeable and is of lithium-ion type.

## 12 V battery

This battery is used to start up the electrical system and drive electrical equipment in the car. The high voltage battery is used when operating the electric motor.

## Related information

- High voltage battery (p. 504)
- 12 V battery (p. 505)
- Symbols on the batteries (p. 507)
- Recycling the batteries (p. 508)
- Polestar Support (p. 9)

## NOTE

Contacting Polestar Support is recommended for replacement of batteries.

# High voltage battery

For operation with the electric motor, the car is equipped with a battery located in the car's chassis. This is maintenance-free and rechargeable and is of lithium-ion type.

Only authorised workshop personnel are allowed to handle high voltage battery parts.

The car cannot be started if the high voltage battery is discharged. If both the 12 V battery and the high voltage battery are discharged, both batteries have to be charged. It is not possible to charge just the high voltage battery first in this case. The 12 V battery needs a certain charge level so that the high voltage battery can charge.

## Positioning of the high voltage battery



## High voltage battery service life and capacity

The capacity of the high voltage battery diminishes with age and use, which may result in reduced range.

Some recommendations to increase battery service life:

- Leave the charging cable fitted when the car is parked. Primarily in particularly hot or cold climates.
- Avoid driving to a 0% state of charge.



# 12 V battery

- If the State Of Charge (SoC) is 0%, the battery should be charged as soon as possible.
- Avoid maximum charging of the battery if this is not needed for the mileage.

## High voltage battery specifications

Type: Lithium-ion

Total amount of energy: 78 kWh.

## Related information

- Batteries (p. 504)
- Charging the high voltage battery (p. 349)
- Polestar Support (p. 9)

## WARNING

The high voltage battery must only be replaced by a workshop – contact Polestar Support.

This battery is used to start up the electrical system and drive electrical equipment in the car. The high voltage battery is used when operating the electric motor.

It is a 12 V AGM battery (Absorbed Glass Mat), dimensioned to support the function of the car's electrical system.

- Never disconnect the battery when the car is switched on.
- Check that the cables to the battery are correctly connected and properly tightened.

## Location

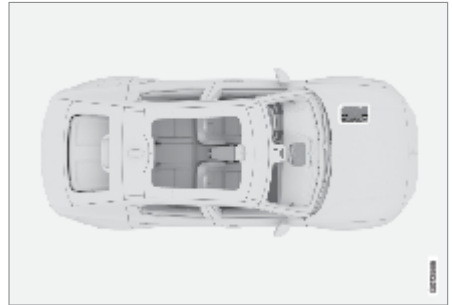

## 12 V battery specifications

Battery type	H6 AGM
Voltage (V)	12
Cold start capacity <sup>A</sup> - CCA <sup>B</sup> (A)	760
Size, L×B×H	277.70×174.40×188.50 mm (10.9×6.9×7.4 in)
Capacity (Ah)	70

A According to EN standard.

B Cold Cranking Amperes.

## Related information

- Symbols on the batteries (p. 507)
- High voltage battery (p. 504)

>>

- Reset sequence for window pinch protection (p. 147)
- Polestar Support (p. 9)

## WARNING

- The battery can generate oxyhydrogen gas, which is highly explosive. A spark can be formed if a jump lead is connected incorrectly, and this can be enough for the battery to explode.
- The battery contains sulphuric acid, which can cause serious burns.
- If sulphuric acid comes into contact with eyes, skin or clothing, flush with large quantities of water. If acid splashes into the eyes - seek medical attention immediately.
- Never smoke near the battery.
- If the 12 V battery is disconnected, the automatic opening and closing function must be reset to work properly. A reset must take place for pinch protection to work.

## IMPORTANT

- If the battery is clamped in position using a tension band, make sure that the tension band is always tightened properly.

## IMPORTANT





- If the battery is replaced, make sure you replace it with a battery with the same size, cold starting capacity and type as the original battery (see the decal on the battery).

## NOTE

Contacting Polestar Support is recommended for replacement of batteries.

# Symbols on the batteries

There are information and warning symbols on the batteries.

	Use protective goggles
	Further information in the Manual for the car
	Store the battery out of the reach of children
	The battery contains corrosive acid
	Avoid sparks and naked flames

	Risk of explosion
	Must be taken for recycling

## Related information

- Batteries (p. 504)
- High voltage battery (p. 504)
- 12 V battery (p. 505)
- Recycling the batteries (p. 508)

# Recycling the batteries

## Fuses and central electrical units

A used 12 V battery should be recycled in an environmentally sound manner – it contains lead.

Consult Polestar Support if you are not sure how this type of waste should be disposed of.

### Related information

- Batteries (p. 504)
- Symbols on the batteries (p. 507)
- Polestar Support (p. 9)

All electrical functions and components are protected by a number of fuses in order to protect the car's electrical system from damage by short circuiting or overloading.

If an electrical component or function does not work, it may be because the component's fuse was temporarily overloaded and failed. If the same fuse fails repeatedly then there is a fault in the circuit. Contacting Polestar Support for a check is recommended.

### Location of central electrical units

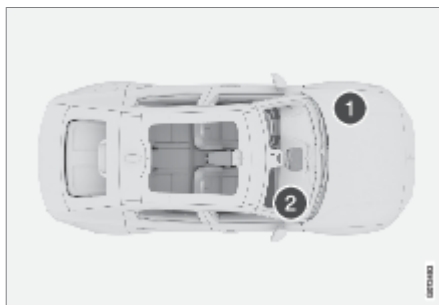

- ① Under the bonnet
- ② Under the glovebox

### Related information

- Replacing a fuse (p. 509)
- Fuses under the bonnet (p. 510)
- Fuses under glovebox (p. 514)
- Polestar Support (p. 9)

# Replacing a fuse

## WARNING

- Never use a foreign object or a fuse with an amperage higher than that specified when replacing a fuse. This could cause significant damage to the electrical system and possibly lead to fire.
- Orange-coloured cables must only be handled by qualified personnel.
- Several components in the car work with high-voltage current that could be dangerous in the event of incorrect intervention.

Do not touch anything that is not clearly described in the Manual for the car.

All electrical functions and components are protected by a number of fuses in order to protect the car's electrical system from damage by short circuiting or overloading.

1. Look in the fuse diagram to locate the fuse.
2. Pull out the fuse and check from the side to see whether the curved wire has blown.
3. If this is the case, replace it with a new fuse of the same colour and amperage.

### Related information

- Fuses and central electrical units (p. 508)
- Fuses under the bonnet (p. 510)
- Fuses under glovebox (p. 514)
- Polestar Support (p. 9)

## WARNING

- Never use a foreign object or a fuse with an amperage higher than that specified when replacing a fuse. This could cause significant damage to the electrical system and possibly lead to fire.
- Contact Polestar Support about the fuses not mentioned in the Manual. If replacing the fuse is not performed correctly, it can cause serious damage to the electrical systems.

## Fuses under the bonnet

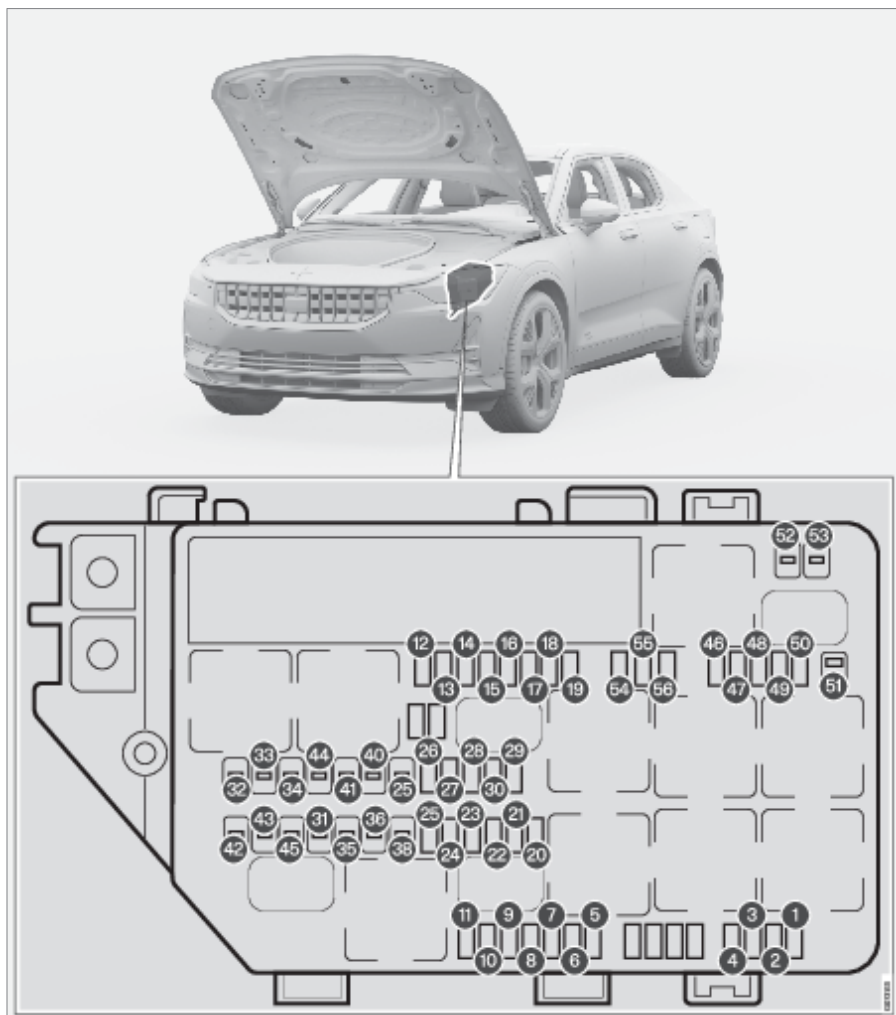

Fuses under the bonnet protect engine and brake functions, among other things.

On the inside of the cover there are tweezers that facilitate the procedure for the removal and fitting of fuses.

The fuse box also provides space for several spare fuses.

### Positions

On the inside of the cover is a label that shows the location of the fuses.

	Function	Ampere	Type
①	USB socket, tunnel console, rear	5	Micro
	Double USB sockets, tunnel console, rear	7,5	
②	12 V socket, front	15	Micro
③	-	-	Micro
④	12 V socket in luggage compartment/cargo area	15	Micro
⑤	Engine Control Module (ECM)	10	Micro
⑥	Engine cooling system	15	Micro
⑦	Valve, battery cooling system	5	Micro
⑧	Control module, front spoiler and front grille, ventilation control	10	Micro
⑨	-	-	Micro
⑩	-	-	Micro
⑪	-	-	Micro
⑫	Right-hand headlamp	20	Micro
⑬	Left-hand headlamp	20	Micro
⑭	Airbags, seat sensor, collision module	5	Micro
⑮	Accelerator pedal sensor	5	Micro
⑯	Powered when the car's electrical system is switched on: Engine control module; Transmission components; Electric steering servo; Central electronic module; Brake system control module	5	Micro
⑰	Exterior audio module	5	Micro
⑱	Alcohol lock	5	Micro
⑲	Rear lights	10	Micro
⑳	Internal relay coils	5	Micro

	Function	Ampere	Type
21	Converter for control of the supply to the rear axle's electric motor	5	Micro
22	Brake pedal sensor	5	Micro
23	Calculation unit	5	Micro
24	High voltage battery	5	Micro
25	-	-	Micro
26	Engine Control Module (ECM)	5	Micro
27	Charging unit (On Board Charger)	15	Micro
28	Converter for control of the supply to the front axle's electric motor	5	Micro
29	Horn	20	Micro
30	Siren	5	Micro
31	Windscreen wipers	30	MCase <sup>A</sup>
32	-	-	MCase <sup>A</sup>
33	-	-	MCase <sup>A</sup>
34	-	-	MCase <sup>A</sup>
35	Brake module	30	MCase <sup>A</sup>
36	-	-	MCase <sup>A</sup>
38	Right headlamp; Left headlamp	30	MCase <sup>A</sup>
39	-	-	MCase <sup>A</sup>
40	-	-	MCase <sup>A</sup>
41	Towbar control module	25	MCase <sup>A</sup>
42	Towbar control module	40	MCase <sup>A</sup>
43	-	-	MCase <sup>A</sup>
44	-	-	MCase <sup>A</sup>
45	-	-	MCase <sup>A</sup>



	Function	Ampere	Type
46	Outer heat exchanger	5	Micro
47	A/C control module, compressor, high-voltage heater control module, electric expansion valve control module, monitoring unit	5	Micro
48	High voltage batteries; Inverter generators	15	Micro
49	Coolant pump 1 for high voltage batteries	20	Micro
50	Coolant pump for electric drive system	20	Micro
51	–	–	MCase <sup>A</sup>
52	Electrically heated windscreen, right-hand side	40	MCase <sup>A</sup>
53	Electrically heated windscreen, left-hand side	40	MCase <sup>A</sup>
54	Monitoring unit	5	Micro
55	Left-hand headlamp	20	Micro
56	Right-hand headlamp	20	Micro

A This type of fuse should be replaced by a workshop – contact Polestar Support.

#### Related information

- Fuses and central electrical units (p. 508)
- Replacing a fuse (p. 509)
- Fuses under glovebox (p. 514)

### IMPORTANT

Do not try to open the panel around the storage compartment under the bonnet – it may damage the panel. Contact Polestar Support if maintenance is required.

## Fuses under glovebox

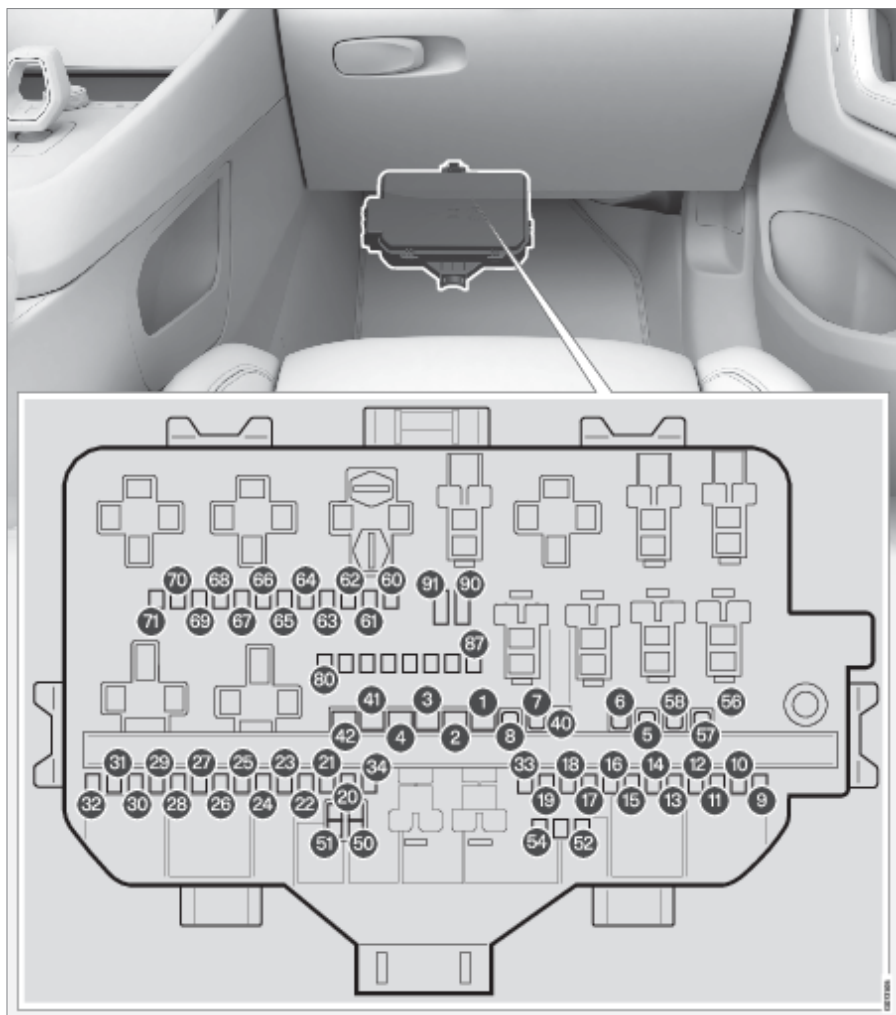

Fuses under the glovebox protect, amongst other things, electrical sockets, displays and door modules.

On the inside of the cover there are tweezers that facilitate the procedure for the removal and

fitting of fuses. The fuse box under the bonnet also has space for several spare fuses.



### Positions

On the inside of the cover is a label that shows the location of the fuses.

	Function	Ampere	Type
①	Audio control device (amplifier) <sup>A</sup>	40	MCase <sup>B</sup>
②	Central Electrical Module A: Sensors, radar units, power seats	40	MCase <sup>B</sup>
③	Central Electrical Module B: Sensors, radar units, power seats	40	MCase <sup>B</sup>
④	Fan module for climate control system, front	40	MCase <sup>B</sup>
⑤	Power operated tailgate	25	MCase <sup>B</sup>
⑥	Power seat, left	20	MCase <sup>B</sup>
⑦	Power seat, right	20	MCase <sup>B</sup>
⑧	-	-	MCase <sup>B</sup>
⑨	Right-hand rear door module	20	Micro
⑩	Left-hand rear door module	20	Micro
⑪	Left-hand front door module	20	Micro
⑫	Rear lights	15	Micro
⑬	Right-hand front door module	20	Micro
⑭	Seat heater, rear	15	Micro
⑮	Safety module (ASDM = Active safety domain master)	5	Micro
⑯	Calculation module	5	Micro
⑰	Sun sensor	5	Micro
⑱	Steering lock	7,5	Micro
⑲	Control module for climate control system	7,5	Micro
⑳	Interior motion sensors	5	Micro
㉑	Driver display	5	Micro
㉒	Keypad in centre console	5	Micro

	Function	Ampere	Type
23	Steering wheel module	5	Micro
24	Start knob module; Electronic gearing module; Electronic parking brake	5	Micro
25	Centre display	5	Micro
26	Control module for a car connected to the Internet; Control module for Connect	5	Micro
27	Module for multi-band antenna	5	Micro
28	Relay coils	5	Micro
29	Foot motion detection; Control module Digital Key	5	Micro
30	Control module, Infotainment	15	Micro
31	Diagnostic socket OBDII	10	Micro
32	Alcohol lock Extended accessory module	5	Micro
33	Electric lowering of head restraints, left	15	Micro
34	Electric lowering of head restraints, right	15	Micro
40	Rear window defroster	30	MCase <sup>B</sup>
41	Seatbelt pretensioner module, left-hand side	40	MCase <sup>B</sup>
42	Seatbelt pretensioner module, right-hand side	40	MCase <sup>B</sup>
50	-	-	Micro
51	-	-	Micro
52	Coolant pump	7,5	Micro
53	Steering wheel module for heated steering wheel	15	Micro
54	Electric air heating	5	Micro
55	Headlamp washers	25	MCase <sup>B</sup>
56	Windscreen and rear windscreen washers	25	MCase <sup>B</sup>
57	-	-	MCase <sup>B</sup>

	Function	Ampere	Type
60	-	-	MCase <sup>B</sup>
60	Communication unit	5	Micro
61	-	-	Micro
62	-	-	Micro
63	Seatbelt pretensioner module	5	Micro
64	Blind Spot Information (BLIS)	5	Micro
65	-	-	Micro
66	-	-	Micro
67	Control module, front radar	5	Micro
68	-	-	Micro
69	360° parking camera	5	Micro
70	Fuse for special vehicle	5	Micro
71	Airbag and seatbelt pretensioner control module	5	Micro
80	-	-	Micro
81	Wake-up, electronic shifting module	5	Micro
82	-	-	Micro
83	Interior lighting; Dimming of rearview mirror; Rain and light sensor; Control panels in rear doors and cargo area Transponder for road tax	7,5	Micro
84	-	-	Micro
85	Front-facing camera	5	Micro
86	Alcohol lock	5	Micro
87	Wireless mobile charger; USB socket	7,5	Micro

	Function	Ampere	Type
	-	-	Micro
	-	-	Micro

A Applicable to certain variants.

B This type of fuse should be replaced by a workshop – contact Polestar Support.

#### Related information

- Fuses and central electrical units (p. 508)
- Replacing a fuse (p. 509)
- Fuses under the bonnet (p. 510)

## Bulb replacement

This car is equipped only with LED<sup>173</sup> lamps and therefore no replaceable bulbs. Contact Polestar Support if a fault occurs in the lighting.

If a fault occurs in LED<sup>173</sup> lamps, the entire lamp unit usually must be replaced.

### NOTE

Outside lighting such as headlamps and rear lamps may temporarily have condensation on the inside of the lens. This is normal, all exterior lighting is designed to withstand this. Condensation is normally vented out of the lamp housing when the lamp has been switched on for a time.

## Cleaning the interior

Only use cleaning agents and car care products recommended by Polestar. Clean regularly, and deal with stains straight away. Vacuuming is important prior to using cleaning agents.

### Related information

- Cleaning the centre display (p. 520)
- Cleaning the driver display (p. 521)
- Cleaning fabric upholstery and headlining (p. 522)
- Cleaning the seatbelts (p. 523)
- Cleaning fabric floor carpets and inlay mats (p. 523)
- Cleaning leather upholstery\* (p. 524)
- Cleaning interior plastic, metal and wood parts (p. 525)
- Cleaning matte-painted emblems (p. 529)

# Cleaning the centre display

## IMPORTANT

- Certain items of coloured clothing (e.g. dark jeans and suede garments) may stain the upholstery. If this occurs, it is important to clean and treat these parts of the upholstery as soon as possible.
- Never use strong solvents such as washer fluid, pure petrol or white spirit or concentrated alcohol to clean the interior, since this may damage the upholstery as well as other interior materials.
- Never spray the cleaning agent directly onto components that have electrical buttons and controls. Wipe them instead using a moistened cloth containing the cleaning agent.
- Sharp objects and Velcro may damage the fabric upholstery.
- Only use cleaning agents on the type of material for which they were intended.

Dirt, stains and grease from fingers can affect the centre display's performance and readability. Clean the screen frequently with a microfibre cloth.



1. Turn off the centre display with a long press on the home button.
2. Wipe the screen with the microfibre cloth supplied or use another microfibre cloth of equivalent quality. Wipe the screen with a clean and dry microfibre cloth with small circular movements. If necessary, lightly moisten the microfibre cloth with clean water.
3. Activate the display with a long press on the home button.

### Related information

- Cleaning the interior (p. 519)
- Cleaning fabric upholstery and headlining (p. 522)
- Cleaning the seatbelts (p. 523)
- Cleaning fabric floor carpets and inlay mats (p. 523)
- Cleaning leather upholstery\* (p. 524)
- Cleaning interior plastic, metal and wood parts (p. 525)



# Cleaning the driver display

## IMPORTANT

- The microfibre cloth used to clean the centre display must be free from sand and dirt.
- When cleaning the centre display, only use gentle pressure on the screen. Heavy pressure can damage the screen.
- Do not spray any liquid or caustic chemicals directly on the centre display. Do not use window cleaning agent, other cleaning agents, aerosol spray, solvents, alcohol, ammonia or cleaning agent containing abrasive.

Never use abrasive cloths, paper towels or tissue paper, since they may scratch the centre display.

Gently wipe the display's cover glass with a clean and dry microfibre cloth. If necessary, lightly moisten the microfibre cloth.

Never use cleaning agent. A special detergent can be used in more severe cases. Contact Polestar Support for more information.

### Related information

- Cleaning the interior (p. 519)
- Driver display (p. 72)

# Cleaning fabric upholstery and headlining

It is recommended to use fabric cleaning agent when cleaning textile fabric and Nubuck textile. Clean when necessary, and treat stains straight away.

## Cleaning fabric upholstery

1. Start by vacuuming the upholstery.
2. Follow the instructions for the textile detergent.
3. When washing textiles, an upholstery washer is recommended in order to vacuum up wash fluid and deal with subsequent rinsing with water.

## Cleaning the headlining

1. Carefully brush the headlining using a soft brush.
2. Follow the instructions for the textile detergent.
3. Then use a soft, lint-free cloth to wipe the headlining.

## Related information

- Cleaning the interior (p. 519)
- Cleaning the centre display (p. 520)
- Cleaning leather upholstery\* (p. 524)
- Cleaning the seatbelts (p. 523)
- Cleaning fabric floor carpets and inlay mats (p. 523)
- Cleaning interior plastic, metal and wood parts (p. 525)

## WARNING

Never spray cleaning agent on the sides of the seats when the side airbags are fitted. Dry these instead using a cloth moistened with the cleaning agent.

## IMPORTANT

- Never scrape or rub a stain as this may destroy the upholstery.
- Never use stain removing agents or strong solvents, these may damage the upholstery.
- Some coloured clothes (such as jeans and suede garments) may discolour the fabric upholstery. It may be difficult to remove stubborn stains such as oil.
- Always clean all the upholstery, even if there are just a few individual stains on it. The aim of this is to avoid permanent watermarks.
- Careless cleaning may damage the headlining.

## NOTE

Do not remove the upholstery during cleaning.

## Cleaning the seatbelts

Contact Polestar Support for information on which detergents and car care products are recommended. Clean regularly, and deal with stains straight away. Vacuuming is important prior to using cleaning agents.

Use water and synthetic detergent, contact Polestar Support for information on special textile cleaning agents. Ensure that the seatbelt is dry before allowing it to retract.

### Related information

- Cleaning the interior (p. 519)
- Cleaning the centre display (p. 520)
- Cleaning fabric upholstery and headlining (p. 522)
- Cleaning fabric floor carpets and inlay mats (p. 523)
- Cleaning leather upholstery\* (p. 524)
- Cleaning interior plastic, metal and wood parts (p. 525)

## Cleaning fabric floor carpets and inlay mats

When cleaning carpets, using a textile detergent is recommended. Clean regularly, and deal with stains straight away. Vacuuming is important prior to using cleaning agents.

Remove inlaid carpets for separate cleaning of the floor carpet and the inlaid carpets. Each inlay mat is secured with pins.

1. Remove the inlay mat by gripping each pin in the mat and lifting straight up.
2. Use a vacuum cleaner to remove dust and dirt.
3. A textile detergent is recommended for stains on the floor carpet after vacuuming.
4. After cleaning, fit the inlay mat in place by pressing it in at each pin.

### Related information

- Cleaning the interior (p. 519)
- Cleaning the centre display (p. 520)
- Cleaning fabric upholstery and headlining (p. 522)
- Cleaning the seatbelts (p. 523)
- Cleaning leather upholstery\* (p. 524)
- Cleaning interior plastic, metal and wood parts (p. 525)

### WARNING

Only use one inlaid mat at each seat, and check before setting off that the mat by the driver's seat is firmly affixed and secured in the pins so that it does not get caught adjacent to and under the pedals.

# Cleaning leather upholstery

## NOTE

The inlay mats must not be swung around or hit against objects to remove dirt since this can crack the inlay mats.

Contact Polestar Support for information on which detergents and car care products are recommended. Clean regularly, and deal with stains straight away. Vacuuming is important prior to using cleaning agents.

Polestar's leather upholstery is treated to preserve its original appearance.

Leather upholstery is a natural product that changes and acquires a beautiful patina over time. Regular cleaning and treatment are required in order that the properties and colours of the leather shall be preserved. Contact Polestar Support for recommendations for products for cleaning and treating leather upholstery in order to maintain the protective surface of the leather.

## Cleaning the leather upholstery

1. Apply the leather cleaner to a damp sponge and squeeze until a foam is created.
2. Use the sponge on the stain in a circular motion.
3. Thoroughly dampen the stain using the sponge, allow the sponge to absorb the stain without scrubbing.
4. Wipe the stain with a soft cloth and allow the leather to dry thoroughly.

## Protecting the leather upholstery

1. Apply a small amount of leather protective agent to a cloth and then apply it to the leather in light circular motions.
2. Allow to dry for about 20 minutes.
  - > Protecting the leather upholstery makes it more resistant to the stresses from the sun's UV radiation.

# Cleaning interior plastic, metal and wood parts

## Related information

- Cleaning the interior (p. 519)
- Cleaning the centre display (p. 520)
- Cleaning fabric upholstery and headlining (p. 522)
- Cleaning the seatbelts (p. 523)
- Cleaning fabric floor carpets and inlay mats (p. 523)
- Cleaning interior plastic, metal and wood parts (p. 525)

Contact Polestar Support for information on which detergents and car care products are recommended. Clean regularly, and deal with stains straight away.

A fibrillated fibre or microfibre cloth, lightly moistened with water, is recommended for cleaning interior parts and surfaces. Contact Polestar Support for information on suitable cleaning tools.

Do not scrape or rub stains. Never use strong stain removers, either.

## Related information

- Cleaning the interior (p. 519)
- Cleaning the centre display (p. 520)
- Cleaning fabric upholstery and headlining (p. 522)
- Cleaning the seatbelts (p. 523)
- Cleaning fabric floor carpets and inlay mats (p. 523)
- Cleaning leather upholstery\* (p. 524)

## IMPORTANT

- Do not use solvent that contains alcohol when cleaning the glass for the driver display.
- Keep in mind that high gloss surfaces are easily scratched. Clean these surfaces with a clean, dry microfibre cloth using small, circular motions. If needed, dampen the microfibre cloth with a little clean water.

# Cleaning the exterior

The car should be washed as soon as it becomes dirty. This means that the car is easier to clean since the dirt does not attach as firmly. It also reduces the risk of scratches and keeps the car fresh. Carry out cleaning in a cleaning area with an oil separator, and use car shampoo.

## Related information

- Polishing and waxing (p. 526)
- Handwashing (p. 527)
- Automatic car wash (p. 530)
- High-pressure washing (p. 531)
- Cleaning wiper blades (p. 531)
- Cleaning exterior plastic, rubber and trim components (p. 532)
- Cleaning wheel rims (p. 533)
- Cleaning matte-painted emblems (p. 529)
- Rustproofing (p. 533)

# Polishing and waxing

Polish and wax the car if the paintwork is dull or to give the paintwork extra protection. The car does not need to be polished until it is at least one year old. However, the car can be waxed during this time. Do not polish or wax the car in direct sunlight, the surface being polished should be a maximum of 45 °C (113 °F).

- Wash and dry the car thoroughly before you begin polishing or waxing. Clean off asphalt and tar stains using tar remover or white spirit. More stubborn stains can be removed using fine rubbing paste designed for car paintwork.
- Polish first with a polish and then wax with liquid or solid wax. Follow the instructions on the packaging carefully. Many preparations contain both polish and wax.

## Related information

- Cleaning the exterior (p. 526)
- Handwashing (p. 527)
- Automatic car wash (p. 530)
- High-pressure washing (p. 531)
- Cleaning wiper blades (p. 531)
- Cleaning exterior plastic, rubber and trim components (p. 532)
- Cleaning wheel rims (p. 533)
- Rustproofing (p. 533)
- Cleaning matte-painted emblems (p. 529)

## IMPORTANT

- Never polish or wax the matte emblem on the car. This may destroy the matte effect and leave the surface permanently shiny.

# Handwashing

## IMPORTANT

- Avoid waxing and polishing on plastic and rubber.

When using degreasant on plastic and rubber, only rub with light pressure if it is necessary. Use a soft washing sponge.

Polishing glossy trim mouldings could wear away or damage the glossy surface layer.

Polishing agent that contains abrasive must not be used.

- Only paint treatment recommended by Polestar should be used. Contact Polestar Support for information. Other treatment such as preserving, sealing, protection, lustre sealing or similar could damage the paintwork. Paintwork damage caused by such treatments is not covered by the Polestar warranty.

The car should be washed as soon as it becomes dirty. This means that the car is easier to clean since the dirt does not attach as firmly. It also reduces the risk of scratches and keeps the car fresh. Carry out cleaning in a cleaning area with an oil separator, and use car shampoo.

### Important things to remember when washing the car by hand

- Avoid washing the car in direct sunlight. This can cause the detergent or wax to dry and have an abrasive effect.
- Remove bird droppings from the paintwork as soon as possible. They contain substances that damage and discolour paintwork very quickly. For example, use soft paper or sponge soaked in plenty of water. Contact Polestar Support for information on how to remove any stains.
- Wash the underbody, including wheel housings and bumpers.
- Rinse the entire car until the dissolved dirt has been removed so as to reduce the risk of scratches from washing. Do not spray directly onto the locks.
- If necessary, use cold degreasing agent on very dirty surfaces. Note that in this case, the surfaces must not be hot from the sun.
- Wash using a sponge, car shampoo and plenty of lukewarm water.
- Clean the wiper blades with a lukewarm soap solution or car shampoo.
- Dry the car using a clean, soft chamois or a water scraper. If you avoid allowing drops of water to dry in strong sunlight, you reduce the risk of water drying stains which may need to be polished out.
- After the car has been washed, tar from asphalt may remain. Use tar remover to get

rid of the last spots after the car has been washed.

#### Related information

- Cleaning the exterior (p. 526)
- Polishing and waxing (p. 526)
- Automatic car wash (p. 530)
- High-pressure washing (p. 531)
- Cleaning wiper blades (p. 531)
- Cleaning exterior plastic, rubber and trim components (p. 532)
- Cleaning wheel rims (p. 533)
- Rustproofing (p. 533)
- Cleaning matte-painted emblems (p. 529)

#### NOTE

- Outside lighting such as headlamps and rear lamps may temporarily have condensation on the inside of the lens. This is normal, all exterior lighting is designed to withstand this. Condensation is normally vented out of the lamp housing when the lamp has been switched on for a time.
- Be aware that the keyless locking and unlocking function may cause the car to be locked/unlocked when the car is being washed if the key is within range.

#### IMPORTANT

- To maintain the matte surface of the emblem, see the separate section.
- Dirty headlamps function less well, so clean them regularly.

Do not use any corrosive cleaning agents but use water and a non-scratching sponge instead.

- Never use polishing agent with abrasive properties on the panoramic roof.
- Never use wax on the rubber mouldings around the panoramic roof.
- Remember to remove dirt from the drain holes in the doors and in the sills after washing the car.



# Cleaning matte-painted emblems

To care for the matte-painted emblems, they should be washed by hand as soon as they have become dirty. This makes them easier to clean as the dirt does not adhere as much. Contact Polestar Support if you would like recommendations for detergents and car care products.

## Hand-washing the matt-painted emblem

1. Rinse the entire emblem until the dissolved dirt has been removed so as to reduce the risk of scratches from washing. Take extra care when using a high-pressure washer.
2. Wash the emblem with a microfibre cloth, car shampoo for matt paintwork and plenty of warm water.
3. Wipe dry with a clean and soft microfibre cloth.

## Related information

- Cleaning the exterior (p. 526)
- High-pressure washing (p. 531)
- Cleaning wiper blades (p. 531)
- Cleaning exterior plastic, rubber and trim components (p. 532)
- Cleaning wheel rims (p. 533)
- Rustproofing (p. 533)

## IMPORTANT

- Make sure that doors, windows and hatches are closed for high-pressure washing.
- Never polish a matte-painted emblem. Polishing will lead to the emblem becoming shiny.

## IMPORTANT

- Do not use paint cleaner, grinding agents, polishing products or sheen preservation, e.g. wax for high-gloss paintwork. These products are only intended for glossy surfaces. Shiny spots will appear if they are used on matt paintwork.
- The best way to remove insects, coffee stains, grease stains, oil and fingerprints is to use a special cleaning agent for matt paintwork. Apply the cleaning agent using a microfibre cloth and a gentle pressure.
- Remove asphalt stains using a vegetable-based asphalt remover. Proceed with caution and do not tap on too hard on the emblem. Contact Polestar Support for product recommendations.
- Try not to rub the emblem when washing and drying the car. This may destroy the matte effect of the paintwork and leave the emblem permanently shiny.

# Automatic car wash

The car should be washed as soon as it becomes dirty. The longer the car is left dirty, the more difficult it will be to get it completely clean and there is a risk of scratching the paintwork.

Washing the car in an automatic car wash is a simple and quick way of getting it clean but it cannot reach everywhere. Polestar recommends washing your car by hand or using an automatic car wash supplemented with washing by hand.

For car washes where the car is pulled forwards with the wheels rolling, the following rules apply:

1. Before washing the car, make sure that the automatic rain sensor is deactivated, otherwise there is a risk of it starting and potentially damaging the wiper arms.
2. Make sure that the side mirrors are folded in, any auxiliary lamps are secured and that antennas are folded in or removed, otherwise there is a risk of the automatic car wash damaging these.
3. Keep hold of the seatbelt throughout the entire car wash
4. Drive into the automatic car wash.
5. Switch to gear position N.

The car is ready for the automatic wash.

## Related information

- Cleaning the exterior (p. 526)
- Polishing and waxing (p. 526)
- Handwashing (p. 527)
- High-pressure washing (p. 531)
- Cleaning wiper blades (p. 531)
- Cleaning exterior plastic, rubber and trim components (p. 532)
- Cleaning wheel rims (p. 533)
- Rustproofing (p. 533)
- Keyless locking and unlocking (p. 198)
- Cleaning matte-painted emblems (p. 529)
- Using the rain sensor (p. 155)

## IMPORTANT

- The system will automatically activate the parking brake if the above steps are not followed. The parking brake must not be activated when in an automatic car wash.
- Do not switch off the car via the centre display. The parking brake is activated if the car is switched off.
- Do not use towing mode during automatic car washing.

## NOTE

- Polestar recommends that the car is not washed in an automatic car wash during the first few months (this is because the paintwork has not fully hardened).
- Be aware that the keyless locking and unlocking function may cause the car to be locked/unlocked when the car is being washed if the key is within range.

## High-pressure washing

The car should be washed as soon as it becomes dirty. The longer the car is left dirty, the more difficult it will be to get it completely clean and there is a risk of scratching the paintwork. Wash the car in a car wash with oil separator. Use car shampoo.

When using high-pressure washing, use sweeping movements and make sure that the nozzle does not come closer than 30 cm (13 in.) to the surface of the car. Do not spray directly onto the locks.

### Related information

- Cleaning the exterior (p. 526)
- Polishing and waxing (p. 526)
- Handwashing (p. 527)
- Automatic car wash (p. 530)
- Cleaning wiper blades (p. 531)
- Cleaning exterior plastic, rubber and trim components (p. 532)
- Cleaning wheel rims (p. 533)
- Rustproofing (p. 533)
- Cleaning matte-painted emblems (p. 529)

### IMPORTANT

To maintain the matte surface of the emblem, see the separate section.

## Cleaning wiper blades

The car should be washed as soon as it becomes dirty. The longer the car is left dirty, the more difficult it will be to get it completely clean and there is a risk of scratching the paintwork. Wash the car in a car wash with oil separator. Use car shampoo.

Asphalt, dust and salt residue on the wiper blades, as well as insects, ice etc. on the windscreen, impair the service life of the blades.

When cleaning, set the wiper blades in service position.

### Related information

- Setting the wiper blades to service position (p. 537)
- Cleaning the exterior (p. 526)
- Polishing and waxing (p. 526)
- Handwashing (p. 527)
- Automatic car wash (p. 530)
- High-pressure washing (p. 531)
- Cleaning exterior plastic, rubber and trim components (p. 532)
- Cleaning wheel rims (p. 533)
- Rustproofing (p. 533)
- Cleaning matte-painted emblems (p. 529)

### NOTE

Wash the wiper blades and windscreen regularly with a lukewarm soap solution or car shampoo. Do not use any strong solvents.

# Cleaning exterior plastic, rubber and trim components

The car should be washed as soon as it becomes dirty. The longer the car is left dirty, the more difficult it will be to get it completely clean and there is a risk of scratching the paintwork. Carry out cleaning in a cleaning area with an oil separator, and use car shampoo.

A special cleaning agent is recommended for the cleaning and care of coloured plastic parts, rubber and trim components, e.g. glossy trim mouldings. Contact Polestar Support for more information. When using such a cleaning agent the instructions must be followed carefully.

## Related information

- Cleaning the exterior (p. 526)
- Polishing and waxing (p. 526)
- Handwashing (p. 527)
- Automatic car wash (p. 530)
- High-pressure washing (p. 531)
- Cleaning wiper blades (p. 531)
- Cleaning wheel rims (p. 533)
- Rustproofing (p. 533)
- Cleaning matte-painted emblems (p. 529)

## IMPORTANT

- Avoid waxing and polishing on plastic and rubber.

When using degreasant on plastic and rubber, only rub with light pressure if it is necessary. Use a soft washing sponge.

Polishing glossy trim mouldings could wear away or damage the glossy surface layer.

Polishing agent that contains abrasive must not be used.

- To maintain the matte surface of the emblem, see the separate section.

# Cleaning wheel rims

The car should be washed as soon as it becomes dirty. The longer the car is left dirty, the more difficult it will be to get it completely clean and there is a risk of scratching the paintwork. Carry out cleaning in a cleaning area with an oil separator, and use car shampoo.

Only use rim cleaning agent recommended by Polestar. Contact Polestar Support for more information.

Strong rim cleaning agents can damage the surface and cause stains on chrome-plated aluminium rims.

## Related information

- Cleaning the exterior (p. 526)
- Polishing and waxing (p. 526)
- Handwashing (p. 527)
- Automatic car wash (p. 530)
- High-pressure washing (p. 531)
- Cleaning exterior plastic, rubber and trim components (p. 532)
- Cleaning wheel rims (p. 533)
- Rustproofing (p. 533)
- Cleaning matte-painted emblems (p. 529)

# Rustproofing

The car has protection against corrosion.

Anti-corrosion protection for the body consists of metallic protective coatings on the sheet metal, a high-quality painting process, corrosion-protected and minimised metal overlap, and shielding plastic components, abrasion protection and supplemental rust inhibitor on exposed areas. In the chassis, exposed components of the wheel suspension are made of corrosion-resistant cast aluminium.

## Inspection and maintenance

The car's anti-corrosion protection normally requires no maintenance, but a good way to reduce the risk of corrosion is to keep the car clean. Strong alkaline or acidic cleaning solutions must be avoided on glossy trim components. Any stone chips should be rectified as soon as they are discovered.

## Related information

- Cleaning the exterior (p. 526)
- Polishing and waxing (p. 526)
- Handwashing (p. 527)
- Automatic car wash (p. 530)
- High-pressure washing (p. 531)
- Cleaning wiper blades (p. 531)
- Cleaning exterior plastic, rubber and trim components (p. 532)
- Cleaning wheel rims (p. 533)
- Cleaning matte-painted emblems (p. 529)

# Car paintwork

The paintwork consists of several layers and is an important part of the car's surface protection, and should therefore be checked regularly.

The most common types of paintwork damage are stone chips, scratches, and marks on the edges of wings, doors and bumpers. Damage should be repaired immediately to prevent further impairment of the paintwork.

### Related information

- Touching up minor paintwork damage (p. 534)
- Colour codes (p. 536)

# Touching up minor paintwork damage

Paint is an important part of the car's surface protection and should therefore be checked regularly. The most common types of paintwork damage are stone chips, scratches, and marks on e.g. the edges of wings, doors and bumpers.

Damage should be repaired immediately to prevent further impairment of the paintwork.

### Materials that may be needed

- Primer – a special adhesive primer in a spray can is available for e.g. plastic-coated bumpers.
- Basecoat and clearcoat - available in spray cans or as touch-up pens/sticks<sup>174</sup>.
- Masking tape.
- Fine sand paper.

### Apply touch-up paint to a damaged area

If the damage has not reached down to the metal, the touch-up paint can be applied directly after the surface has been cleaned.

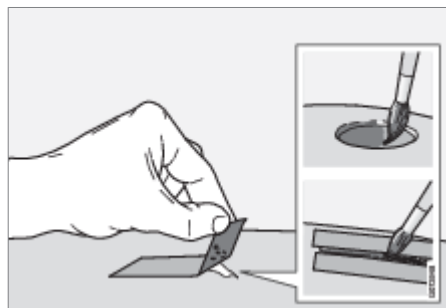

1. Apply a piece of masking tape over the damaged surface. Then remove the tape to remove any loose paint.

If the damage is down to the metal, use of a primer is appropriate. In the event of damage to a plastic surface, an adhesive primer should be used to give better results - spray into the lid of the spray can and brush on thinly.

2. Before painting, gentle polishing using a very fine polishing agent may be carried out locally if required (e.g. if there are any uneven edges). The surface is cleaned thoroughly and left to dry.

3. Stir the primer well and apply using a fine brush, a matchstick or similar. Finish off with a basecoat and clearcoat once the primer has dried.

For scratches, implement the same procedure but mask around the damaged area to protect the undamaged paintwork.

Contact Polestar Support for information on touch-up pens and spray paints for touching up paintwork damage.

#### Related information

- Car paintwork (p. 534)
- Colour codes (p. 536)

#### NOTE

- If the stone chip has not penetrated down to the metal and an undamaged layer of paint remains in place, fill in with basecoat and clearcoat as soon as the surface has been cleaned.

#### NOTE

- When paint is repaired the surface must be clean and dry. The temperature of the surface should be at least 15 °C (59 °F).

# Colour codes

The decal for the colour code is located at the bottom of the B-pillar on the right-hand side.

## Colour code

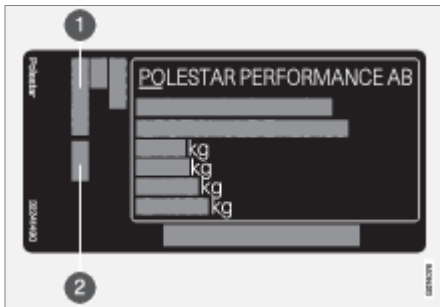

- ① Exterior colour code
- ② Any secondary exterior colour code

It is important that the correct colour is used.

## Related information

- Car paintwork (p. 534)
- Touching up minor paintwork damage (p. 534)

# Replacing windscreen wiper blades

The wiper blades sweep water away from the windscreen. Together with washer fluid, they aim to clean the windscreen and ensure visibility while driving. The wiper blades can be replaced.

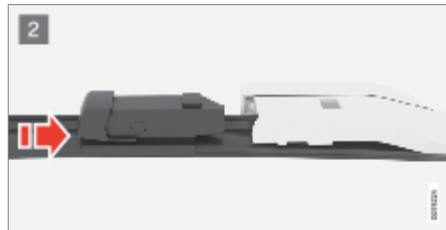
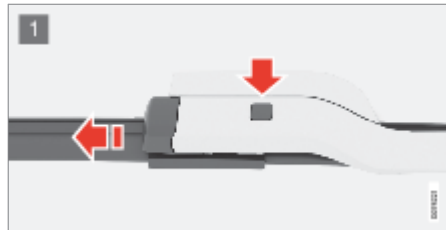

- 1 Fold up the wiper arm when it is in service position. Service position is activated/deactivated via the function view in the centre display when the car is stationary and the windscreen wipers are switched off. Press the button located on the wiper blade attachment, and pull straight out parallel to the wiper arm.
- 2 Push in the new wiper blade until you hear a clicking sound.
3. Check that the blade is firmly installed.
4. Fold the wiper arm back towards the windscreen.



# Setting the wiper blades to service position

The wiper blades are different lengths

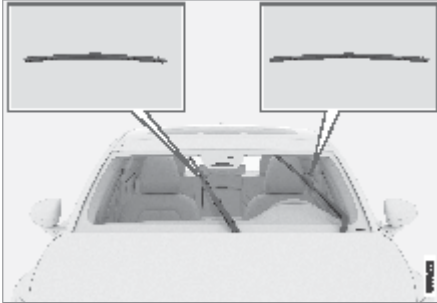

In some situations, the windscreen's wiper blades must be set in service position (vertical position), e.g. when they shall be replaced.



## Related information

- Using the rain sensor (p. 155)
- Using windscreen and headlamp washers (p. 157)
- Using the rain sensor's memory function (p. 156)
- Filling washer fluid (p. 538)
- Setting the wiper blades to service position (p. 537)
- Using windscreen wipers (p. 154)
- Wiper blades and washer fluid (p. 154)

*Wiper blades in service position.*

In order to change, clean or lift the wiper blades (e.g. for scraping off ice from the windscreen) they must be in service position.

## Activating/deactivating service mode

Service mode can be activated/deactivated when the car is stationary and the windscreen wipers are not on. Service mode is activated/deactivated via the centre display:

1. Tap on  in the centre display.
2. Then tap on More.
3. Select Mirrors & Wipers and activate/deactivate service mode for the wiper blades.

The wiper blades also exit the service position if:

- Windscreen wiping is activated.
- Windscreen washing is activated.
- The rain sensor is activated.
- The car is driven away.

## NOTE

When replacing the wiper blades, note that they have different lengths. The blade on the driver's side is longer than on the passenger side.

# Filling washer fluid

## Related information

- Using the rain sensor (p. 155)
- Using windscreen and headlamp washers (p. 157)
- Using the rain sensor's memory function (p. 156)
- Filling washer fluid (p. 538)
- Replacing windscreen wiper blades (p. 536)
- Using windscreen wipers (p. 154)
- Wiper blades and washer fluid (p. 154)

## IMPORTANT

- Before placing the wiper blades in the service position, make sure that they are not frozen down.
- If the wiper arms in service position have been folded up from the windscreen, they must be folded back down onto the windscreen before the activation of wiping, washing or the rain sensor, as well as before driving. This is to avoid damaging the paint on the bonnet.

Washer fluid is used for cleaning the headlamps and windscreen. Washer fluid with antifreeze must be used when the temperature is under the freezing point.

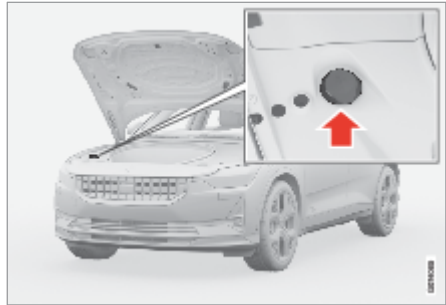

Washer fluid is filled into the reservoir with the blue cap. The reservoir is used for both windscreen washer and headlamp washers.

Prescribed grade: Washer fluid recommended by Polestar – with frost protection during cold weather and for temperatures below freezing point.

Volume:

- Cars with headlamp cleaning: 5.5 litres (5.8 qts).
- Cars without headlamp cleaning: 3.5 litres (3.7 qts).

## Related information

- Using the rain sensor (p. 155)
- Using windscreen and headlamp washers (p. 157)
- Using the rain sensor's memory function (p. 156)
- Setting the wiper blades to service position (p. 537)

- Replacing windscreen wiper blades (p. 536)
- Using windscreen wipers (p. 154)
- Wiper blades and washer fluid (p. 154)

## IMPORTANT

- Use washer fluid with a recommended pH of between 6 and 8, in working dilution (e.g. 1:1 with neutral water).
- Use washer fluid with antifreeze when the temperature is below freezing to avoid the fluid freezing inside the pump, reservoir and hoses.

## NOTE

When approx. 1 litre (1 qt) of washer fluid remains in the reservoir, the message Refill washer fluid, level low is shown in the driver display, together with the  symbol.



Section 19

—

Specifications

# Type designations

The decals in the car contain information such as chassis number, type designation, colour code, etc.

## Label location

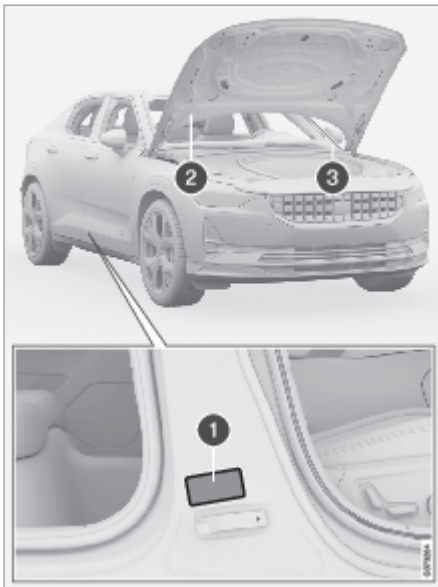

*The illustration is schematic - details may vary depending on market and model.*

Knowing the car's type designation, vehicle identification and engine numbers can facilitate all contact with Polestar Support regarding the car and when ordering spare parts and accessories.

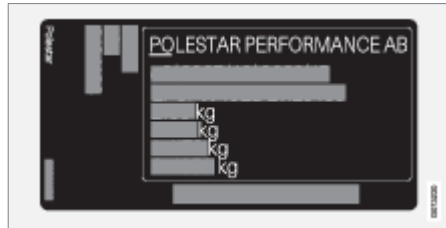

① Decal for type designation, vehicle identification number, permissible maximum weights and code designation for exterior colour and type approval number. The decal is positioned on the door pillar, and will be visible when the right-hand door is opened.



② Decal for A/C system for cars with refrigerant R1234yf.



③ Decal for the car's identification number - VIN (Vehicle Identification Number).

Further information on the car is presented in the registration document.

# Dimensions

## Related information

- Air conditioning – specifications (p. 548)

### NOTE

It is not intended that the decals illustrated in the Manual should be exact replicas of those in the car. They are included to show their approximate appearance and locations in the car. The information that applies to your particular car can be found on the decal on the car.

Measurement of car length, height, etc. can be read in the table.

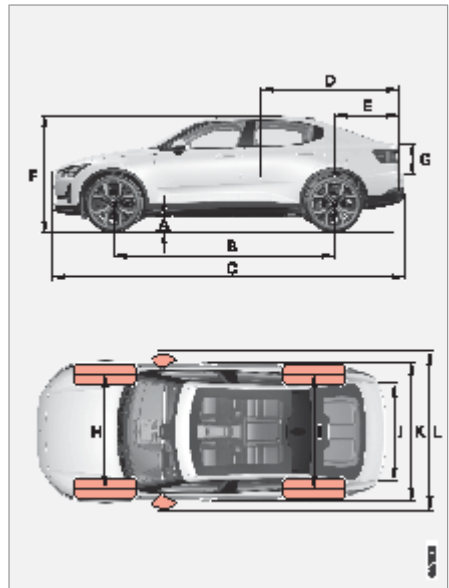

	Dimensions	mm	inches
A	Ground clearance <sup>A</sup>	151 <sup>B, C</sup>	5.9 <sup>B, C</sup>
		146 <sup>B, D</sup>	5.7 <sup>B, D</sup>
		167 <sup>E, C</sup>	6.6 <sup>E, C</sup>
		161 <sup>E, D</sup>	6.3 <sup>E, D</sup>
B	Wheelbase	2735	107,7
C	Length	4606	181,3
D	Load length, floor, folded seat	1776	69.9
E	Load length, floor	1020	40.2

>>

# Weights

	Dimensions	mm	inches
F	Height <sup>F</sup>	1482 <sup>C</sup> 1477 <sup>D</sup>	58.3 <sup>C</sup> 58.1 <sup>D</sup>
G	Load height	667	26.3
H	Front track	1602	63,1
I	Rear track	1601	63,0
J	Load width, floor	939	37.0
K	Width	1859	73,2
L	Width including door mirrors	1985	78,1

- A At kerb weight + 1 person. (Varies slightly depending on tyre dimension, chassis option, etc.)
- B Front
- C Without performance package
- D With performance package
- E Rear
- F Including roof antenna, for kerb weight.

## Related information

- Weights (p. 544)

Max. gross vehicle weight, etc. can be read on a label in the car.

The kerb weight includes the driver and all oils and fluids.

The weight of the passengers and installed accessories, plus the towball load (when there is a trailer connected) influence the load capacity and are not included in the kerb weight.

Permitted max. load = Gross vehicle weight - Kerb weight.

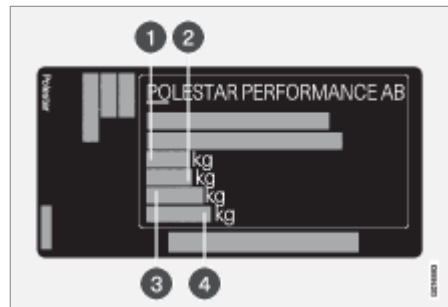

The decal is positioned on the door pillar, and will be visible when the right-hand door is opened.

- ① Max. gross vehicle weight
- ② Max. train weight (car+trailer)
- ③ Max. front axle load
- ④ Max. rear axle load

Max. load: See registration document.

Max. roof load: 75 kg.

## Related information

- Type designations (p. 542)
- Towing weights and towball loads (p. 545)



# Towing weights and towball loads

## WARNING

The car's driving characteristics change depending on how heavily it is loaded and how the load is distributed.

## NOTE

The documented kerb weight applies to cars in the standard version - i.e. a car without extra equipment or accessories. This means that for every accessory added the loading capacity of the car is reduced correspondingly by the weight of the accessory.

Examples of accessories that reduce load capacity are the different equipment levels, as well as other accessories such as towbar, load holder, space box, auxiliary lamps, GPS, heater, safety grille, carpets, cargo cover, power seats, etc.

Weighing the car is a certain way of ascertaining the kerb weight of your own particular car.

Towing weights and towball loads for driving with a trailer can be viewed in the tables.

Braked trailer	
Max. weight (kg)	1500

## Related information

- Type designations (p. 542)
- Weights (p. 544)
- Driving with a trailer (p. 401)
- Trailer Stability Assist\* (p. 402)

## IMPORTANT

When driving with a trailer, the gross vehicle weight (including towball load) is allowed to be exceeded by a maximum of 100 kg (220 lbs) as long as the speed is limited to 100 km/h (62 mph). National legal requirements such as speed, etc. for the vehicle combination must be observed.

## NOTE

Using vibration dampers on the towbar is recommended for trailers weighing more than 1800 kg.

# Engine specifications

Engine specifications (power, etc.) for each respective engine alternative can be found in the table below.

## Electric drive motor

The car is powered by two electric motors.

		Front	Rear
Engine type:		Synchronous motor with permanent magnet	Synchronous motor with permanent magnet
Engine model:		EAD 3.1	EAD 3.1
Max. output:	kW	150	150
	hp	204	204
Max. torque:	Nm	330	330

## Related information

- Type designations (p. 542)

## Transmission fluid – specifications

Under normal driving conditions, the transmission fluid does not need to be changed during the service life of the gearbox. However, it may be necessary in adverse driving conditions.

### Automatic gearbox

Prescribed transmission fluid:	BOT350 M3
--------------------------------	-----------

### Related information

- Type designations (p. 542)

## Brake fluid – specifications

The medium in a hydraulic brake system is called brake fluid, and it is used to transfer pressure from e.g. a brake pedal via a master brake cylinder to one or more slave cylinders, which in turn act on a mechanical brake.

Prescribed grade: Brake fluid that fulfils a combination of Dot 4, 5.1 and ISO 4925 class 6.

### NOTE

It is recommended that brake fluid is changed or filled by an authorised Polestar workshop.

# Air conditioning – specifications

The car's climate control system uses R1234yf freon-free refrigerant. Information about the refrigerant is printed on a decal located on the inside of the bonnet.

Prescribed grades and volumes of fluids and lubricants in the air conditioning system can be read below.

## A/C decal

### Decal for R1234yf



### Symbol explanation R1234yf

Symbol	Meaning
	Caution
	Mobile air conditioning system (MAC)
	Lubricant type

Symbol	Meaning
	A trained and certified technician is required in order to service the mobile air conditioning system (MAC)
	Flammable refrigerants

## Refrigerant

Refrigerant amount is printed on the decal located on the inside of the bonnet.

### Cars with R1234yf refrigerant



① Refrigerant amount.

## Compressor oil

Volume	Prescribed grade
110 ml (3.72 fl. oz.)	POE RB68

## Evaporator

The A/C system evaporator must never be repaired or replaced with a previously used evaporator. The new evaporator must be certified and labelled according to SAE J2842.

# The car's certified values for range and electricity consumption

## Related information

- Servicing the climate control system (p. 501)

### WARNING

The air conditioning system contains pressurised refrigerant R1234yf. In accordance with SAE J2845 (Technician Training for Safe Service and Containment of Refrigerants Used in Mobile A/C System), service and repair of the refrigerant system must only be performed by trained and certified technicians in order to ensure the safety of the system.

### IMPORTANT





The A/C system's evaporator must never be repaired or replaced with a previously used evaporator. A new evaporator must be certified and labelled in accordance with SAE J2842.

The car's range and electricity consumption are dependent on a number of factors. The ability to achieve a long range and low electricity consumption varies according to the circumstances and conditions under which the car is being driven.





The certified values for the car's range on electric power should not be interpreted as an expected range. The certification values are comparative values that are obtained by means of special drive cycles (see below) and should primarily be used to compare different cars.

The values in the table below are in accordance with WLTP (Worldwide Harmonised Light-Duty Vehicles Test Procedure), which is an international test method for vehicles equivalent to a passenger car designed for laboratory testing.

## Explanation

	Certified value for the car's potential range ("up to") in km. The value should not be interpreted as an expected range, and the range is difficult to achieve during normal driving.
	Urban and suburban driving
	Average value over all four drive cycle phases (urban, suburban, extra-urban and motorway driving)
	Certified value for the car's electricity consumption (kWh/100 km). The value is an average value over all four drive cycle phases (urban, suburban, extra-urban and motorway driving).

	Low value
	High value

	Range		kWh/EC
			
	560	470	19,3
	520	435	21,0

The values in the table above for range in electric mode and electricity consumption are based on special drive cycles (see below). The car's weight may increase depending on its equipment level. Together with how heavily the car is loaded, this affects and reduces its range in electric mode and increases electricity consumption. According to WLTP, each car has unique electric range values, depending on how the car is equipped. In many markets, you can find your car's unique electric range values in the car's registration document.

There are a number of reasons as to why the range (mileage) is shorter and electricity consumption is higher than indicated in the table values. Examples of these include:

- If the car is equipped with extra equipment that affects its weight.
- Driving style.
- If the customer chooses wheels other than those mounted as standard on the basic version of the model, this could increase rolling resistance.
- High speed, which causes increased air resistance.

- Road and traffic conditions, weather and the condition of the car.

### WLTP standard

As of 1 September 2018, a new standard was introduced for calculating electric range values in the car. The WLTP standard represents the average driving conditions for everyday driving. In comparison with the previous standard (NEDC), WLTP takes into account more varied traffic situations and speeds, but also equipment and weight classes. Optional equipment that affects electric range values is deactivated during testing, e.g. air conditioning, seat heating, etc. The new standard should provide more realistic figures when it comes to range for electric operation. The values are intended to allow comparison between different cars and not to represent your typical range for electric mode.

### Drive cycle profiles

A drive cycle simulates actual average driving of the car. The standard is based on four different drive cycle profiles. The four drive cycle profiles are:

- Urban driving – slow driving
- Suburban driving – average driving
- Extra-urban driving – fast driving
- Motorway driving – very fast driving.

Every drive cycle is determined by different conditions such as speed, time and mileage, for example.

### Related information

- Range for electric operation (p. 392)
- Economical driving (p. 394)

# Approved wheel and tyre sizes

## NOTE

If there is no range and electricity consumption data in the table, this is available in an enclosed supplement.

In certain countries not all approved sizes are indicated by the registration document or other documents. The following table shows all approved combinations of wheel rims and tyres.

Front:	245/45 R19	245/40 R20
	8x19x50	8x20x50
Rear:	245/45 R19	245/40 R20
	9x19x53	9x20x53

## Related information

- Minimum permitted tyre load index and speed rating for tyres (p. 552)
- Type designations (p. 542)
- Dimension designation for tyre (p. 454)
- Dimension designation for wheel rim (p. 455)
- Snow chains (p. 470)

## IMPORTANT

The front wheels must not switch places with the rear wheels, and vice versa.

# Minimum permitted tyre load index and speed rating for tyres

# Approved tyre pressures

The table below shows minimum permitted load index (LI) and speed rating (SS).

Approved tyre pressures for each engine alternative can be found in the table.

Minimum permitted load index (LI) <sup>A</sup>	99
Minimum permitted speed rating (SS) <sup>B</sup>	H

A The tyre's load index must be at least equal to or greater than indicated in the table.

B The tyre's speed rating must be at least equal to or greater than indicated in the table.

## Related information

- Approved wheel and tyre sizes (p. 551)
- Approved tyre pressures (p. 552)
- Type designations (p. 542)
- Dimension designation for tyre (p. 454)
- Dimension designation for wheel rim (p. 455)

Tyre size	Speed	Load, 1-3 persons		Max. load		ECO pressure <sup>A</sup>
		Front (kPa) <sup>B</sup>	Rear (kPa)	Front (kPa)	Rear (kPa)	Front/rear (kPa)
245/45 R19	0-160 km/h (0-100 mph)	280	280	280	310	280 / 310
	160+ km/h (100+ mph)	280	280	280	310	-
245/40 R20	0-160 km/h (0-100 mph)	300	280	300	310	300 / 310
	160+ km/h (100+ mph)	300	280	300	310	-

A Economical driving.

B In certain countries the "bar" unit is used alongside the SI unit "Pascal": 1 bar = 100 kPa.

## Related information

- Type designations (p. 542)
- Checking tyre pressure (p. 456)
- Approved wheel and tyre sizes (p. 551)
- Recommended tyre pressure (p. 458)

## IMPORTANT

The front wheels must not switch places with the rear wheels, and vice versa.



# Candidate list substance information (REACH Article 33)

The REACH Regulation (Reg. EC 1907/2006) Article 33.1 is aimed at enabling professional customers of supplied products to take any relevant risk management measures that may arise from the presence in these articles of Substances of Very High Concern (SVHCs) listed on the current Candidate List (CL) for Authorisation, in order to guarantee the safe use of these products.

Polestar Performance AB supports the underlying goals of REACH generally, and Article 33 specifically, which are consistent with our own commitment to promote the responsible manufacturing, handling and use of our products.

## Presence of Candidate List Substances

To the best of our knowledge based on information received from our supply chain and our own product data, the Candidate List substances present in component articles at greater than 0.1% w/w are those shown on the relevant "Candidate List Substances Table" for the specific vehicle.

## Specific Safe Use Information for Articles Containing Candidate List Substances

If applicable, Specific Safe Use Information for articles containing Candidate List substances is added to the relevant "Candidate List Substances Table" for the specific vehicle.

## General Safe Use Information for Articles

Each Polestar vehicle is provided with a Manual, which includes safe use information for owners/operators of the vehicle. Polestar's information on repair and service of vehicles and genuine parts also includes safe use information for service personnel.

Where present in parts of this vehicle, the Candidate List substances shown on the relevant "Candidate List Substances Table" for the specific vehicle are incorporated in such a way that potential exposure to the customers is minimised, and danger for humans or the environment can be excluded as long as the vehicle and its parts are used as intended, and any repairs, servicing and maintenance are carried out following technical instructions for those activities, and industry standard good practices.

An end-of-life vehicle may only be disposed of legally in the European Union at an Authorised Treatment Facility (ATF). Vehicle parts should be disposed in accordance with locally applicable laws and local authority guidance.

## Candidate List Substances Table

Candidate List substances present in articles at greater than 0.1% by weight	CAS No.
C,C'-azodi(formamide)	123-77-3
N,N-Dimethylacetamide	127-19-5
4,4'-Isopropylidenediphenol	80-05-7
Poly(oxy-1,2-ethanediyl), alpha-(nonylphenyl)-omega-hydroxy-, branched	68412-54-4
Boric acid	10043-35-3
Nonoxinol	9016-45-9
1,2-Dimethoxyethane	110-71-4
1-Methyl-2-pyrrolidone	872-50-4
Imidazolidine-2-thione	96-45-7
2,4-Di-tert-butyl-6-(5-chloro-benzotriazol-2-yl)phenol	3864-99-1

Candidate List substances present in articles at greater than 0.1% by weight	CAS No.
2-(2H-Benzotriazol-2-yl)-4,6-ditertpentylphenol	25973-55-1
1,6,7,8,9,14,15,16,17,17,18,18-Dodecachloropentacyclo[12.2.1.16,9.02,13.05,10]octadeca-7,15-diene	13560-89-9
2-ethylhexyl 10-ethyl-4,4-dioctyl-7-oxo-8-oxa-3,5-dithia-4-stannatetradecanoate	15571-58-1
Refractory ceramic fibres	142844-00-6
Disodium tetraborate, anhydrous	1330-43-4

#### Specific Safe Use Information for Articles Containing Candidate List Substances

No specific safe use information is required - follow General Safe Use Information for Articles.

# Index

1, 2, 3 ...			
<hr/>			
12 V battery	505	Aerial start and lock system	
		– location	205
		Airbag	38
		– Activating/deactivating	42
		– driver's side	39
		– passenger side	40, 42
		Airbag, see Airbag	38
		Air conditioning	192
		Air conditioning, fluid	
		– volume and grade	548
		Air conditioning system	174, 181
		– repair	501
		Air distribution	179
		– air vents	179, 180
		– change	180
		– defrosting	188
		– Recirculation	187
		Air quality	176, 178
		– allergies and asthma	177
		– passenger compartment filter	179
		Air recirculation	187
		Alarm	237
		– activate/deactivate	238
		– motion and tilt sensors	237
		– reduced alarm level	239
		Allergy and asthma inducing substances.	177
		All Wheel Drive	388
		All-wheel drive	388
		Ambience lights	144
		– adapt	144
		App menu	
		– driver display	74
		Apps	
		– download in-car apps	416
		– in-car apps	415
		– remove apps	416
		Assistance at risk of collision	292
		– brakes for oncoming vehicles	301

– cross traffic	300	Bicycle rack	
– Limitations	297	– towbar-mounted	404
– obstacle detection	294	Blind Spot Information	306
– set distance	299	BLIS	306
– speed reduction	296	– activate/deactivate	308
– Symbols and messages	304	– Limitations	308
– upon risk of rear-end collision	302	– Symbols and messages	309
– upon risk of run-off	303	Bluetooth	
Audio and media	414	– phone	420
Audio settings	414	Bluetooth Media Player	419
Auto climate control	186	Bonnet	
Automatic brake		– open and close	501
– Driver support	242	Book service and repair	495
Automatic braking		Brake assist	
– after collision	383	– after collision	383
Automatic car wash	530	Brake energy	375, 389
Automatic car washes	530	Brake fluid	
Automatic gearbox	385	– grade	547
– oil	547	Brake functions	375
Automatic main beam	134	Brakes	
Automatic relocking	199, 210	– Anti-lock braking system, ABS	375
Automatic speed limiter	260	– autobrake with adaptive cruise control	282
		– autobrake with Pilot Assist	282
		– brake assist system, BAS	377
		– brake light	139
		– brake system	375
		– emergency brake lights	140
		– foot brake	375
		– maintenance	378
		– on gritted roads	378
		– on wet roads	377
		– Parking brake	379
		Brake system	
		– fluid	547
		Braking when stationary	382
		Bulbs	
		– change	519
<b>B</b>			
Backrest			
– front seat, adjusting	164		
– rear seat, folding	167		
Bag holder	489		
Battery	504		
– 12 V battery	505		
– high voltage battery	504		
– recycling	508		
– symbols on battery	507		
Battery meter	75		

## C

Camera unit	341	Charging	
– Limitations	341	– finish charging	367
– maintenance and cleaning	343	– open and close charging flap	357
– Symbols and messages	344	– Status	362
Car care	526, 527, 530–533	Charging cable	352
– Leather upholstery	524	Charging cable temperature monitoring	356
Car functions		Charging power	351
– in centre display	112	Charging status at the car's charging input socket	361
Cargo area	487	Charging status in the car's centre display	
– electrical socket	484	– Status	366
– lighting	144	Charging status in the car's driver display	
– mounting points	490	– Status	365
– parcel shelf	491	Charging status in the charging cable's control unit	362
Cargo cover	491	Charging the high voltage battery	349
Cargo hooks	489	Child lock	207
Car holiday	395	Child safety	49
Car status		Child seat	49, 53, 55
– Tyre pressure	462	– i-Size/ISOFIX mounting points	52
Car upholstery	519, 522–525	– lower mounting points	51
Car washing	526, 527, 530–533	– overview table	57
central locking	205	– positioning/fitting	53, 55
Centre display		– table for location	58
– car function view	112	– table of i-Size	60
– cleaning	520	– table of ISOFIX	61
– climate control	181	– Upper mounting points	50
– messages	123	Cleaning	523, 525
– overview	105	– automatic car wash	530
– restore settings	118	– car washing	526, 527, 530–533
– symbols in status bar	113	– centre display	520
Centre display's views	110	– fabric upholstery	519, 522, 524
Centre display keyboard	114	– matte-painted emblem	529
Certificate	427	– rims	533
Change of owner	118	– Seatbelts	523
		– upholstery	519, 523–525
		Cleaning wheel rims	533

Cleaning wiper blades	531	Contacts	424
CleanZone	177	Controls lighting	144
Clean Zone Interior Package	177	Coolant	503
Climate control	174, 181	Cornering light	137
– auto-regulation	186	Corner Traction Control	244
– centre display	181	Crash, see Collision	28
– fan control	190	Cross Traffic Alert	312
– Parking	193	– activate/deactivate	314
– rear seat	181	Cruise control	262
– sensors	175	– activate	257
– temperature control	191	– deactivate	259
– zones	175	– standby mode	263
Climate control system		– steering wheel buttons	256
– Refrigerant	548	– stored speed	280
Clock		Cruise control functions	254
– settings	71	– activate	257
Collision	28, 32, 38, 47	– deactivate	259
Collision Avoidance	292	– steering wheel buttons	256
Collision warning		CZIP (Clean Zone Interior Package)	177
– cross traffic rear	312		
– from behind	305	<b>D</b>	
– with adaptive cruise control	278		
– with Pilot Assist	278	Damping	390
Colour code, paint	536	Data	
Colour codes	536	– transfer between car and workshop	495
Combined instrument panel	72	Data link connector	23
– settings	74	daytime running lights	131
Comfort mode	373	Deadlock	236
Condensation in headlamps	527, 530–532	Defrosting	188
conditions, data collection, data registration, user conditions	21	Diagnosis	
Connect		– via workshop Wi-Fi	495
– account	121	Dimensions	543
Connection and entertainment	18	– towbar	397
Connect key to user profile	122	dipped beam	132
Connect phone	420	Direction indicator	135
Contact Polestar	14	Direction indicators	135

direction of rotation	455	Electrical socket	484
Display		– using	484
– driver information	72	Electrical system	504
Display lighting	144	Electric drive motor	
Distance Warning		– specifications	546
– Set time interval	281	Electricity consumption	
Door mirrors	149	– certified value	549
– Dipping	150	Electric motor	389
– resetting	151	Electric operation	
– store position	162, 163	– General	348
Doors		emergency brake lights	140
– keyless locking/unlocking	199	Emergency equipment	
Driver Alert Control	310	– first aid kit	491
– activate/deactivate	311	– warning triangle	492
– Limitations	312	Emergency puncture repair kit	472
Driver display	72	– Pump up tyre	477
– app menu	74	– using	473
– cleaning	521	Engine braking	375
– electric operation-related symbols and messages	369	Engine drag control	244
– license agreement	82	Engine specifications	546
– messages	104	Environment	17
– settings	74	External dimensions	543
Driver distraction	25		
Driver performance	78	<b>F</b>	
driver support system	242	_____	
Drive systems	389	Fan	
Driving in water	396	– Air distribution	180
Driving mode	373	– air vents	180
Driving with a trailer		– Control	190
– towball load	545	Farewell light	142
– towing weight	545	First aid	491
		First aid kit	491
		Flooded road	396
<b>E</b>		Fluids, capacities	538, 548
_____		Fluids and oils	503, 547, 548
Economical driving	394		
ECO pressure	458, 552		

Fog lamp			
- front	137	Hard disk	
- rear	138	- space	430
Foot brake	375	Hazard warning flashers	140
Front seat		Headlamp	
- Climate control	181	- adjustment	130
- Fan	190	Headlamp control	128, 144
- heating	183	Headlamp pattern, adjustment	130
- Temperature	191	Heated washer nozzles	154
- ventilation	185	Heater	
Front seat, power	160	- parking heater	196
- adjusting seat	161	Heating	
- multi-function control	164	- seats	183, 184
- store position	162, 163	- steering wheel	185, 186
Fuse box	508	- Windows	189
Fuses	508	High-pressure washing	531
- changing	509	High voltage battery	504
- in the passenger compartment	514	- charging	349
- under bonnet	510	Hold	382
		HomeLink®	408
		- program	409
		- Type approval	412
		- using	411
		Home safe lighting	141
		Horn	169
<b>G</b>		<b>I</b>	
Gearbox		IAQS (Interior Air Quality System)	178
- gear selector inhibitor	387	IC (Inflatable Curtain)	46
- Symbols and messages	388	Identification number	24
Gear positions	385	Immobiliser	220
Gear selector inhibitor	387	Immobilizer	
Glass, laminated/reinforced	146	- Immobiliser	220
Global opening	208	Inching	389
Glovebox	486	Indicator symbols	79
Gross vehicle weight	544	Inflatable curtain	46
		Inflatable Curtain	46
<b>H</b>			
Handbrake	379		
Handwash	527		



Information display	72, 74	Keyless	
Infotainment system	414	– locking/unlocking	198
Instrument lighting	144	– tailgate	201
Instruments and controls	68, 69	Keyless unlocking	
Interior Air Quality System	178	– tailgate	200
Interior lighting	142	Keypad in the steering wheel	169
– adapt	144	Key system	
– auto function	143	– Type approval	220
Interior rearview mirror	149		
– Dipping	150	<b>L</b>	
Intermittent wiping	154		
Internal overview		Labels	
– left-hand drive car	68	– location	542
– right-hand drive car	69	Laminated glass	146
Internet-connected car		Lamps	
– system updates	496	– change	519
ITPMS - Indirect Tyre Pressure Monitoring System	459	– trailer	403
		Lane assistance	284
		– activate/deactivate	286
		– display mode	289
		– Limitations	287
		– select assistance option	287
		– Symbols and messages	288
		Lane Keeping Aid	
		– see Lane assistance	284
		Language	
		– settings	117
		Leather upholstery, washing instructions	524
		License agreement	
		– driver display	82
		Lifting tool	467
		Lighting	
		– active bending lights	136
		– Automatic main beam	134
		– brake light	139
		– controls	128, 142
		– controls, instruments, display	144
<b>J</b>			
Jack	467		
<b>K</b>			
Kerb weight	544		
Key	208		
– detachable key blade	217		
– locking/unlocking	210		
– lost key	217		
– range	212		
– replace the battery	213		
Key blade	208		
Keyboard	116		
– change language	115		

- cornering light	137	<b>M</b>	
- daytime running lights	131		
- dipped beam	132	Main beam	133, 134
- direction indicators	135	maintenance	
- emergency brake lights	140	- Rustproofing	533
- farewell light	142	Manage the centre display	
- fog lamp	137	- operation	109
- Hazard warning flashers	140	Manage tiles in the centre display	111
- home safe lighting	141	Manual information	8
- in the passenger compartment	142	Maps	
- main beam	133, 134	- destination	444
- position lamps	130	- electric car functions	446
- rear fog lamp	138	- in centre display	443
- settings	129	- in driver display	444
- welcome lighting	142	- map download	448
Lighting, bulb replacement	519	- navigation	442
Load holder	488	- route description	445
Loading		- settings	447
- General	487	- traffic information	446
- load retaining eyelets	490	- update	449
- long load	487	Max. roof load	544
Load retaining eyelets		Media player	419
- cargo area	490	Message in the centre display	123
Lockable wheel bolts	468	Messages	
Lock and unlock	198	- driver display	104
- doors	199	Messages and symbols	
- Key	210	- Adaptive Cruise Control	267
- with key blade	218	- Assistance at risk of collision	304
Lock confirmation	235	- BLIS	309
Locking and unlocking		- Camera unit	344
- settings	200	- Lane assistance	288
Long-term storage of vehicles with high voltage battery	370	- on batteries	507
		- Park Assist	320
		- Park assist camera	328
		- Pilot Assist	274
		- Radar unit	332

– stability and traction control system	246
– tyre pressure monitoring	464
Mileage	76
misting	
– condensation in headlamps	526, 530
Motion sensor	237
Move apps in centre display	113

## N

---

Navigation	
– destination	444
– electric car functions	446
– in centre display	443
– in driver display	444
– map download	448
– Maps	442
– route description	445
– settings	447
– traffic information	446
– update	449

## O

---

Obstacle detection	
– Assistance at risk of collision	294
One pedal drive	385
Option/accessory	10
Order more keys	217
Output	546
– Electric motor	546
outside temperature gauge	79
Overtaking Assistance	276
– activate	277

## P

---

PACOS (Passenger Airbag Cut Off Switch)	42
Paint	
– colour code	536
– damage and touch-up	534, 536
Panorama roof	153
Parcel shelf	491
Park Assist	315
– activate/deactivate	318
– forward, backward	316
– Limitations	319
– sensor fields	326
– Symbols and messages	320
Park assist camera	321
– activate	327
– Limitations	341
– location and views	322
– park assist lines	324
– Symbols and messages	328
Park Assist System	315
Parking	
– on hill	381
Parking brake	379
– activate/deactivate	379
– low battery voltage	381
Parking climate	193
– Symbols and messages	195
Parking heater	196
Passenger Airbag Cut Off Switch	42
Passenger compartment filter	179
Passenger compartment heater (Parking heater)	196
Passenger compartment interior	480
– electrical socket	484
– glovebox	486
– Sun visor	486

- tunnel console	481	- SOS button	433
- USB	482, 483	- subscription	440
Passive mode	373	Polestar ID	14
Pedestrian Protection System	31	- create	15
Phone	420	- problems with logging in	16
- connect	420	Polestar support page	9
- contacts	424	Polishing	526
- disconnect	421	Position lamp	130
- phone	423	Power meter	76
- phone book	424	Power seat	160
- remove	422	Power windows	147
- switching the phone	422	- opening and closing	148
- text message	424	- pinch protection	146
Phone charger	425	PPS (Pedestrian Protection System)	31
Pilot Assist	268	Preconditioning	193
- Auto brake	282	- start/shut-off	194
- change of target	279	Profile	
- deactivate	259	- settings	120
- display mode	272	Pump up tyre	477
- overtaking	276	Puncture	471
- Set time interval	281		
- standby mode	273	<b>R</b>	
- steering wheel buttons	256	Radar unit	329
- stored speed	280	- Limitations	329
- Symbols and messages	274	- maintenance and cleaning	331
- WARNING	278	- Symbols and messages	332
Pinch protection	146	- Type approval	333
- resetting	147	Radio	417
Play media	419	- favourites	418
Polestar Connect	432	- RDS	418
- assistance	434	- start	417
- automatic collision alarm	433	Rain sensor	155, 156
- buy/sell a car	436	Rain sensor memory function	156
- messages	439	Raising the car	498
- personal information	438	Range	392, 394
		- certified value	549

Reading the Manual	10	Residual current device in the charging cable	354
Rear Auto Brake	312	Restore settings	118
– activate/deactivate	314	Retractable power door mirrors	151
Rear Collision Warning	305	Reversing camera	321
– Limitations	306	Rims	
Rear seat	166	– cleaning	533
– Climate control	181	– dimensions	455
– folding backrest	167	Road run-off protection	303
– head restraint	168	Road Sign Information	248
– heating	184	– activate/deactivate	249
Rear seat, Backrest, Head restraint, Lowering head restraint, Backrest rear, Lowering the backrest, Lower, Lowering, Lower, Lowered, Setting	167	– activate/deactivate warnings	253
Rearview and door mirrors		– display mode	250
– angle external mirrors	151	– Limitations	254
– Dipping	150	– speed camera information	252
– door	149	– speed warning	252
– electrically retractable	151	Roll Stability Control	244
– heating	189	Roof load, max. weight	544
– interior	149	Route description	445
rear window		Rustproofing	533
– heating	189		
Recommendations during driving	395	<b>S</b>	
Recommendations for loading	487	Safety	28
Recording data	20	– pregnancy	29
Recovery	407	Safety mode	47
Refrigerant	501	– start/movement	48
– climate control system	548	Sealing fluid	472
Regenerative braking	384, 385	Seatbelt	32
– with the accelerator pedal	385	– buckle/unbuckle	33
Remote control immobiliser	220	– pregnancy	29
Replace the battery		– seatbelt reminder	37
– Key	213	– seatbelt tensioner	35
Reset		Seatbelt, see Seatbelts	32
– trip meter	77	Seatbelt reminder	37
Resetting, trip meter	77	seatbelt tensioner	35
Resetting the door mirrors	151	– Resetting	36

Seats			
– front seats	160	– sport mode	245
– heating	183, 184	– Symbols and messages	246
– power front seat	160	Stains	519, 522–525
– rear seat	166	Start high voltage battery charging	357
– store position	162, 163	Starting the engine	
– ventilation	185	– after collision	48
– whiplash protection	30	Start the car	372
sensors		Steering force level, see Steering force	243
– Air quality	178	Steering lock	170
– Camera unit	341	Steering wheel	169, 171
– Climate control	175	– heating	185, 186
– Radar unit	329	– keypad	169
Service position	537	– steering wheel adjustment	171
Service programme	494	Steering wheel force, speed related	243
Side airbag	44, 45	Stickers	
Side Impact Protection System	44–46	– location	542
SIPS (Side Impact Protection System)	44–46	Stone chips and scratches	534, 536
Skidding	395	Storage spaces	480
Ski hatch	490	– glovebox	486
Slippery driving conditions	395	– tunnel console	481
Snow chains	470	Stored speed	280
Software updates	496	Sun visor	486
Speed camera information	252	– mirror lighting	143
– activate/deactivate	253	Switch off the car	373
Speed limiter	259	Symbols	
– activate	257	– indicator symbols	79
– automatic	260	– warning symbols	79
– deactivate	259	Symbols and messages	
– steering wheel buttons	256	– electric drive related	369
– stored speed	280	– parking climate	195
Speed ratings, tyres	454	Symbols in the centre display status bar	113
Spin control	244	System units	
Stability and traction control system	244	– change	117
– activate sport mode	246	system updates	496

T			
		Trip statistics	78
		tunnel console	481
		Tunnel detection	132
Tailgate		Type approval	
– keyless unlocking	200	– HomeLink®	412
– setting max. opening	203	– radar system	333
– unlock	211	– radio equipment	340
– unlocking from the inside	206	Type designations	542
Target vehicle replacement	279	Tyre load index	454
Temperature		Tyre pressure	
– Control	191	– Adjust	457
– experienced	176	– Check	456
Thermometer	79	– label showing recommended pressure	458
Through-load hatch	490	Tyre pressure monitoring	459
Tilt detector	237	– action	463
Time interval to vehicle in front	281	– messages	464
Tools	467	– save a new tyre pressure	461
Towbar	397	– Status	462
– retractable and extendable	398	Tyre pressure table	552
– specifications	397	Tyres	
Towing	405	– age	452
– fit/remove towing eye	406	– designation of dimensions	454
Towing eye	406	– dimensions	551
Towing mode	407	– direction of rotation	455
Towing weight and towball load	545	– economy and wear	452
Traction control	244	– pressure	552
Trailer	401	– recommended	452
– Lamps	403	– remove and fit	464
Trailer Stability Assist	244, 402	– specifications	551, 552
Transmission oil		– speed rating	454
– grade	547	– Storage	452
Tread	456	– tread wear indicators	456
Tread depth	456	– tyre pressure table	552
– winter tyres	469	– winter tyres	469
Tread wear indicators	456		
Trip computer	76		
Trip meter	76		
Trip meter, resetting	77		

<b>U</b>			
<hr/>			
Usage modes	373	Warning symbols	79
USB		– Safety	28
– charging	483	Warning triangle	492
– ports (USB C)	482	Washer fluid	154, 538
– technical specifications	483	Washer nozzles, heated	154
User profile	118	Washers	
– manage	119	– headlamps	157
		– washer fluid, filling	538
		– windscreen	157
		Waxing	526
<b>V</b>		Weights	
<hr/>		– kerb weight	544
Ventilation	179, 180	Welcome lighting	142
– seats	185	Wheel bolts	468
Voice control		Wheels	
– Google Assistant	124	– remove and fit	464
– using	125	– snow chains	470
VOL marking	452	Wheels and tyres	
Volume	414	– approved dimensions	551
		– tyre load index and speed rating	552
<b>W</b>		whiplash protection	30
<hr/>		Whiplash Protection System	30
Warning lamps		WHIPS (Whiplash Protection System)	30
– Adaptive Cruise Control	278	Windows and glass	146
– Airbags – SRS	79	Windscreen washing	157
– alternator not charging	79	Windscreen wiper	154
– Fault in brake system	79	– rain sensor	155, 156
– Low oil pressure	79	Winter driving	395
– Parking brake applied	79	– snow chains	470
– Pilot Assist	278	– winter tyres	469
– seatbelt reminder	79	Wiper blades	154
– stability and traction control system	244	– changing	536
– starter battery not charging	79	– Service position	537
– WARNING	79	Wiper blades and washer fluid	154
Warning sound		WPC	425
– Parking brake	381		