



EQE

Operator's Manual +

Mercedes-Benz



Front passenger airbag warning



⚠ WARNING Risk of injury or death due to an enabled co-driver airbag

If the co-driver airbag is enabled, a child on the co-driver seat may be struck by the co-driver airbag during an accident.

- ▶ NEVER use a rearward-facing child restraint system on a seat with an ENABLED FRONT AIRBAG. DEATH or SERIOUS INJURY to the CHILD can occur.

Observe the chapter "Children in the vehicle".

Welcome to the world of Mercedes-Benz

Before your first drive, please read this Owner's Manual carefully and familiarise yourself with your vehicle. For your own safety and a longer service life of the vehicle, follow the instructions and warning notices in this Owner's Manual. Disregarding them may lead to damage to the vehicle or injury to people.

The standard equipment and product description of your vehicle may vary and depends on the following factors:

- Model
- Order
- National version
- Availability

Your vehicle may therefore differ from that shown in the descriptions and illustrations in individual cases.

The illustrations in this Owner's Manual show a left-hand drive vehicle. On right-hand drive vehicles, the layout of vehicle parts and controls differs accordingly.

Mercedes-Benz is constantly developing its vehicles further.

Mercedes-Benz therefore reserves the right to introduce changes in the following areas:

- Design
- Equipment
- Technical features

The following documents are components of the vehicle:

- Digital Owner's Manual
- Printed Owner's Manual
- Service Booklet
- Supplementary manuals relating to specific equipment
- Supplementary documents

Keep these documents in the vehicle at all times. Ensure that all documents are in the vehicle or passed on in the event of sale or rental.

Disclaimer

The following online version of the Owner's Manual describes all models as well as all the stand-

ard and optional equipment of your vehicle. Country-specific differences in the language variants are possible. Note that your vehicle may not be fitted with all features described. This is also the case for safety-relevant systems and functions.

Please contact your authorised Mercedes-Benz dealer if you would like to have a printed Owner's Manual for other vehicle models and vehicle model years. The online version is the current valid Owner's Manual version. Possible variations to your vehicle may not be taken into account as Mercedes-Benz constantly updates their vehicles and equipment to the state of the art and introduces changes in design and equipment.

Please also read the printed Owner's Manual, any supplementary documents and the digital Owner's Manual in the vehicle.

Copyright

All Rights Reserved. All texts, images, graphics, are subject to Copyright and other laws for the protection of intellectual property. They may not

be copied for commercial purposes or for transmission, nor changed and used on other websites.

Symbols	6	Help in the event of a breakdown	45	Notes on assembling the number plate on the front licence plate holder	78
Quick start and Tips	7	Expert tips	52	Declarations of conformity and notes on driving in different countries	78
Seats	7	At a glance	58	Diagnostics connection	84
Children in the vehicle	7	Cockpit (central display)	58	Qualified specialist workshop	85
DIGITAL LIGHT	8	Cockpit (MBUX Hyperscreen)	60	Vehicle registration	85
Touch-sensitive controls	9	Indicator and warning lamps (standard)	62	Correct use of the vehicle	85
Radio	10	Indicator and warning lamps (with driver camera)	64	Information on the REACH regulation	86
Wi-Fi hotspot	11	Overhead control panel	66	Notes for persons with electronic medical aids	86
Connecting a mobile phone	11	Door operating unit and seat adjustment	68	Implied warranty	87
MBUX Voice Assistant	12	Emergencies and breakdowns	70	QR code for rescue card	87
ENERGIZING Packages	12	Digital Owner's Manual	72	Data storage	87
Driving Assistance package	13	Calling up the Digital Owner's Manual	72	Copyright	90
Parking Package	13	General notes	73	Occupant safety	91
High-voltage battery AC charging (mode 2 or 3)	14	Protection of the environment	73	Brief overview of most important points	91
High-voltage battery direct current charg- ing (mode 4)	14	Take-back of end-of-life vehicles	73	Information on the automatic functions of the restraint system	98
Destination entry navigation	14	Mercedes-Benz GenuineParts	73	Purpose and function of the restraint sys- tem	102
New multimedia system features	15	Touch-sensitive controls	74	Seat belts	107
At the filling station	23	Mercedes me App	75	Airbags	107
Preparing for a holiday	27	Operating safety	76		
Luggage and loading	31				
Ice and snow	40				

Children in the vehicle	109	Steering wheel	184	Driving and parking	250
Brief overview of most important points	109	Easy entry and exit feature	186	Driving	250
Important safety notes	110	Memory function	188	DYNAMIC SELECT	266
Suitable child restraint systems for the transport of children	116	Stowage areas	190	Transmission	272
Suitable seats for attaching child restraint systems	120	Cup holders	201	Function of 4MATIC	275
Securing the child restraint system	125	Sockets	205	Charging the high-voltage battery	276
Child safety locks	130	Wireless charging of the mobile phone and connection with the exterior aerial	207	Parking	297
Occupant presence reminder	133	Fitting and removing floor mats	210	Driving and driving safety systems	303
				Trailer hitch	393
				Bicycle rack function	399
				Vehicle towing instructions	401
Opening and closing	134	Light and sight	212		
Key	134	Exterior lighting	212	Driver's display	402
Digital Vehicle Key	138	Interior lighting	224	Notes on the driver's display	402
Doors	143	Windscreen wipers and windscreen washer system	226	Notes on the range	402
Boot	155	Mirrors	229	Operating the driver's display	403
Side windows	160	Area permeable to radio waves on the windscreen	232	Driver display menus	404
Sliding sunroof	164	Infrared-reflective windscreen function	232	Head-up display	414
Anti-theft protection	168			Function of the power availability display	416
				Overview of status displays on the driver's display	416
				Overview of status displays on the driver's display (Mercedes-AMG vehicles)	417
Seats and stowing	171	Climate control	233		
Notes on the correct driver's seat position ..	171	Overview of climate control systems	233		
Notes on grab handles	171	Operating the climate control system	236		
Seats	172				

MBUX Voice Assistant	419	Telediagnosics	595	Technical data	644
Notes on operating safety	419	Engine compartment	596	Notes on technical data	644
Operation	419	Topping up the windscreen washer system ..	599	On-board electronics	644
Using MBUX voice assistant effectively	421	Cleaning and care	599	Regulatory radio information	646
Essential voice commands	422			Vehicle identification plate, VIN and engine number overview	757
		Breakdown assistance	608	Operating fluids	759
MBUX multimedia system	426	Emergency	608	Vehicle data	761
Overview and operation	426	Flat tyre	610	Trailer hitch	766
Driver camera	456	Battery (vehicle)	616		
System settings	458	Tow-starting or towing away	618	Display messages and warning/indicator lamps	770
AMG TRACK PACE	467	Electrical fuses	624	Display messages	770
Drive system settings	472			Warning and indicator lamps	858
Fit & Healthy	472	Wheels and tyres	627		
Navigation and traffic	477	Notes on noise or unusual handling char- acteristics	627	Index	876
Telephone	523	Notes on regularly inspecting wheels and tyres	627		
Online and Internet functions	561	Notes on snow chains	627		
Media	569	Activating or deactivating snow chain mode	628		
Radio	577	Tyre pressure	628		
TV	581	Wheel change	632		
Sound	588	Emergency spare wheel	642		
Maintenance and care	594				
ASSYST PLUS service interval display	594				
Maintenance Management	595				

In this Owner's Manual, you will find the following symbols:

 **WARNING** Danger due to not observing the warning notices

Warning notices draw your attention to hazards that may endanger your health or life, or the health or life of others.

 Observe the warning notices.

 **ENVIRONMENTAL NOTE** Environmental damage due to failure to observe environmental notes

Environmental notes include information on environmentally responsible behaviour or environmentally responsible disposal.

 Observe environmental notes.

 **NOTE** Damage to property due to failure to observe notes on material damage

Notes on material damage inform you of risks which may lead to your vehicle being damaged.

 Observe notes on material damage.

 These symbols indicate useful instructions or further information that could be helpful to you.

 Instruction

 (→ page) Further information on a topic

Display Display in the central display

 Highest menu level, which is to be selected in the multimedia system

 Relevant submenus, which are to be selected in the multimedia system

* Indicates a cause

Seats

Adjusting the seats

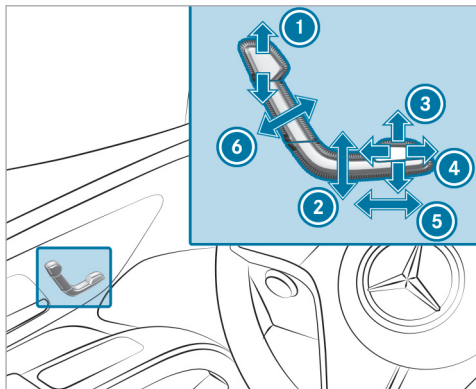

- ① Head restraint height
- ② Seat height
- ③ Seat cushion inclination
- ④ Seat cushion length

- ⑤ Seat fore-and-aft position
 - ⑥ Seat backrest inclination
- ▶ Save the settings with the memory function (→ page 189).

Children in the vehicle

Safely transporting children in the vehicle

- ▶ Always observe when children are travelling in the vehicle (→ page 110)
- ▶ Important warning notices (→ page 111)
- ▶ Recommended child restraint systems (→ page 118)
- ▶ Suitable vehicle seats for fitting a child restraint system (→ page 109)
- ▶ Approval categories for child restraint systems (→ page 116)
- ▶ Suitability of the seats for attaching ISOFIX child restraint systems (→ page 120)
 - Fitting the ISOFIX child restraint system on the rear seat (→ page 127)

- ▶ Suitability of the seats for attaching i-Size child restraint systems (→ page 122)
 - Fitting the i-Size child restraint system on the rear seat (→ page 127)
- ▶ Attaching Top Tether belt (→ page 128)
- ▶ Suitability of seats for attaching belt-secured child restraint systems (→ page 123)
 - Notes on vehicles without automatic front passenger airbag shutoff (→ page 116)
 - Notes on rearward-facing and forward-facing child restraint systems on the front passenger seat (→ page 113)
 - Securing the child restraint system with the seat belt (→ page 130)
- ▶ Automatic front passenger airbag shutoff (→ page 114)
- ▶ Child safety locks for the rear side windows (→ page 132)
- ▶ Child safety locks for the rear doors (→ page 130)

DIGITAL LIGHT

Adaptive functions of the DIGITAL LIGHT

With this system, the headlamps adapt to the driving and weather situation. It also provides extended functions for improved illumination of the road.

The system comprises the following adaptive functions:

- Active headlamps (→ page 216)
- Cornering light (→ page 216)
- Motorway mode (→ page 216)
- Enhanced fog light function (→ page 217)
- Bad weather light (→ page 217)
- City lighting (→ page 217)
- Topographical compensation (→ page 217)

▶ To activate or deactivate DIGITAL LIGHT:

- Briefly press  on the multimedia system display.
- Select **Settings**.
- Select **Lights**.

- Select **DIGITAL LIGHT**.
- Activate or deactivate **Dynamic low beam**.

▶ To activate or deactivate enhanced assistance functions:









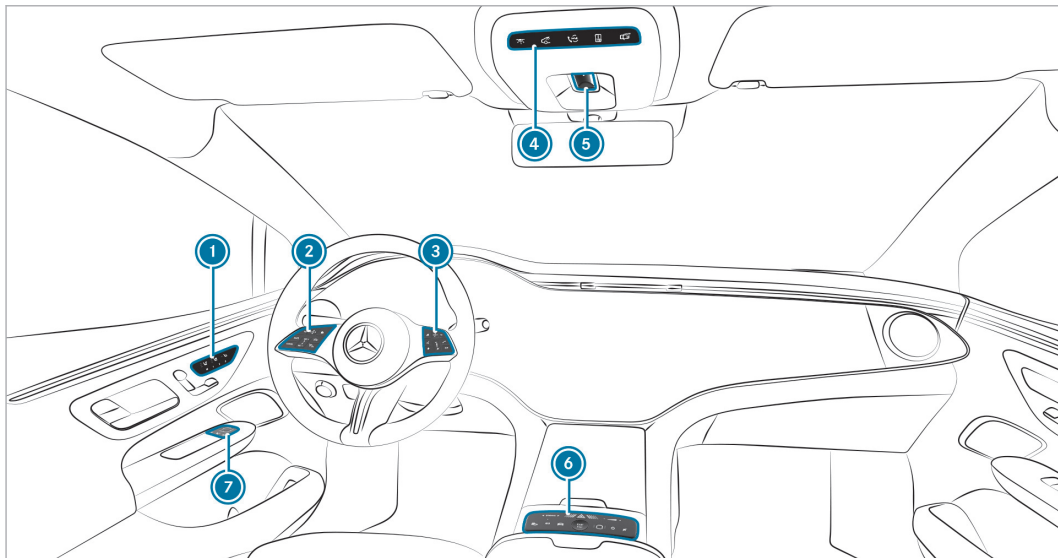

- Select **Supporting projections**.
- Activate or deactivate the desired projection.









The availability of the assistance functions is dependent on the country.

Touch-sensitive controls

Overview of touch-sensitive controls



- ① Control panel:
 -  Switches the seat heating on/off
 -  Switches the seat ventilation on/off
 -  Operates the memory function
- ② Control panel:
Driver's display
 -  Active Distance Assist DISTRONIC and variable limiter
- ③ Control panel for the MBUX multimedia system
- ④ Control panel:
 -  Switches the front interior lighting on/off
 -  Switches the rear interior lighting on/off
 -  me button
 -  Switches automatic interior lighting control on/off
- ⑤  Opens/closes the panorama sliding sunroof
 Opens/closes the roller sunblind
- ⑥ Control panel:
 -  DYNAMIC SELECT

-  Active Parking Assist
 -  Calls up the EQ menu
 -  Quick vehicle access
 -  Fingerprint sensor
 -  Switches the MBUX multimedia system on/off
 -  Switches sound on/off
 -  Adjusts the volume
 - ⑦  Operates the outside mirrors
- ▶ Observe the notes on the touch-sensitive controls (→ page 74).

Radio

Operating radio

▶ To switch to radio:



- Briefly press  on the multimedia system display.
- Tap on .

▶ To set the frequency band:



- Briefly press  on the multimedia system display.

- Tap on .
- Select a frequency band or a favourite.



▶ To set a radio station:

- Briefly press  on the multimedia system display.
- Tap on .
- Swipe to the left or right on the control element or select a radio station.



▶ To call up the radio station list:

- Briefly press  on the multimedia system display.
- Tap on .
- Select .



▶ To search for radio stations using station names or frequency entry:

- Briefly press  on the multimedia system display.
- Tap on .
- Select .
- Enter a station name or frequency.
- Select a station.

▶ To store radio stations:

- Briefly press  on the multimedia system display.
- Tap on .
- Select .

▶ To set the traffic information service volume increase:

- Briefly press  on the multimedia system display.
- Tap on .
- Select **System**.
- Select **Audio**.
- Select **Navigation & traffic announcements**.
- Set a value for **Traffic announc. vol. increase**.

Wi-Fi hotspot

Setting up a Wi-Fi hotspot

Generally, two types of Wi-Fi connection are available:

- Using the multimedia system as a Wi-Fi hotspot
The multimedia system serves as a Wi-Fi hotspot for mobile communication devices such as a smartphone or tablet PC.
The data volume of the vehicle or an already connected tethering device is used for the data connection.
Data volumes must be purchased via the Mercedes me Portal.
The use of the vehicle data tariff by external devices is not available in all countries.
- Using a mobile communication device as a Wi-Fi hotspot (tethering)
An external Wi-Fi hotspot is accessed for the Internet connection of the multimedia system.

The data tariff of the mobile communication device via **Acquired package** is used for the data connection.

Options for setting up a connection:

- QR code
The connection is set up by scanning the QR code shown on the multimedia system.
- NFC
The connection is set up by placing the mobile communication device in the NFC interface of the vehicle.
- Security key
The connection is established by entering the security key displayed on the multimedia system.

Connecting a mobile phone



Connecting a mobile phone

▶ Activating Bluetooth®:

- Make sure that the mobile phone Bluetooth® is switched on.

- Tap on  on the central display or media display.
- Select **Settings**.
- Select **System**.
- Select **Internet and Bluetooth**.
- Activate Bluetooth®.

▶ Searching for a mobile phone:

- Tap on  on the central display or media display.
- Select **Phone**.
- Select .
- Select **Devices**.
- Select **Devices**.
- Select **Connect new device**.

▶ Authorising a mobile phone:

- Select a mobile phone.

A code is displayed in the multimedia system and on the mobile phone.

- ▶ If the codes match, confirm the code on the mobile phone.

MBUX Voice Assistant

Operating the MBUX Voice Assistant

You can use the MBUX Voice Assistant to operate the following functions depending on the vehicle equipment:

- Telephone
- Text message and e-mail
- Navigation
- Radio and media
- Vehicle functions
- Online functions

Examples of possible voice commands:



- To operate the phone: Call my father.
- To manage e-mails: Show me my new e-mails.
- To operate the navigation: Search for a French restaurant in the area.
- To operate the radio: Which station am I currently listening to?
- To operate media: Play a similar track.
- To operate climate control: My feet are cold.

- To operate vehicle functions: Open the window.
- To call up the weather: Will it be sunny tomorrow?
- To ask a general knowledge question: Who painted the picture "The Scream"?

ENERGIZING Packages

Operating ENERGIZING COMFORT

▶ To start an ENERGIZING programme:

- Briefly press  on the multimedia system display.
- Select **Comfort**.
- Select **ENERGIZING COMFORT**.
- Select a programme and start with .

▶ To configure an ENERGIZING programme:

- Select a programme.
- Select **Settings**.
- Switch the functions included in the programme on or off.

▶ To start a training programme:

- Select **Training**.
- Select a programme and start with .
- To activate fragrancing for training, select **Air freshener**.

▶ To start tips:

- Select **Tips**.
- Select an area of the body and start with .

Driving Assistance package

Functions of the Driving Assistance Package

The Driving Assistance Package contains various functions that assist you when driving. For this purpose, your vehicle uses cameras and radar sensors to monitor the area in front of, behind, or beside the vehicle.

The following functions are included in the Driving Assistance Package, depending on country-specific availability:

- ▶ Active Distance Assist DISTRONIC (→ page 321)

You can watch an animation on this topic via the following link:

- ▶ Active Speed Limit Assist (country-dependent) (→ page 327)
- ▶ Route-based speed adaptation (country-dependent) (→ page 328)
- ▶ Active Brake Assist (→ page 336)
- ▶ Active Steering Assist (country-dependent) (→ page 330)

You can watch an animation on this topic via the following link:

- ▶ Active Emergency Stop Assist (country-dependent) (→ page 332)
- ▶ Active Lane Change Assist (country-dependent) (→ page 334)
- ▶ Active Stop-and-Go Assist (country-dependent) (→ page 330)
- ▶ Active Blind Spot Assist with exit warning (→ page 350)
- ▶ Active Lane Keeping Assist (→ page 354)

Parking Package

Functions of the Parking Package

Depending on country-specific availability, your vehicle may be equipped with various functions to assist you with parking and Manoeuvring. For this purpose, your vehicle uses cameras and ultrasonic sensors to monitor the area around the vehicle.

Depending on the equipment level, the following systems and functions are part of your Parking Package:

- ▶ **Reversing camera:** monitors the area to the rear of the vehicle and displays this in the driver display (→ page 364).
- ▶ **360° Camera:** a system that consists of four cameras which cover the immediate surroundings of the vehicle and display this in the driver display (→ page 366).
- ▶ **Parking Assist PARKTRONIC:** an electronic parking assistance system which monitors the area surrounding your vehicle and the distance to obstacles in the vicinity using ultrasound (→ page 371).

▶ **Active Parking Assist:** is an electronic parking assistance system which assists you when parking or leaving a parking space by changing gears, accelerating, braking and steering the vehicle (→ page 375).

▶ **Remote Parking Assist:** can park your vehicle and leave a parking space while you are outside of your vehicle (→ page 382).

You can watch an animation on this topic via the following link:

▶ **Memory Parking Assist:** can park your vehicle in and leave a previously recorded and stored parking space (→ page 389).

You can watch an animation on this topic via the following link:

High-voltage battery AC charging (mode 2 or 3)

AC charging (mode 2 or 3)

Starting and ending the charging process (combo 2 socket)

Starting and ending the charging process (combo 1 socket)

▶ More notes on charging the high-voltage battery (→ page 276)

▶ Overview of the charging cable control panel (→ page 283)

High-voltage battery direct current charging (mode 4)

Direct current charging (mode 4)

Starting and ending the charging process (combo 2 socket)

Starting and ending the charging process (combo 1 socket)

▶ More notes on charging the high-voltage battery (→ page 276)

▶ Overview of the charging cable control panel (→ page 283)

Destination entry navigation

Entering a navigation destination

▶ Briefly press  in the multimedia system display.

The zero layer is shown.

▶ Select  **Where to?.**

Select the following options for destination entry:

- Enter a POI, an address or a three-word address in the input line.
Online search results for POIs (if available) may contain additional information, for example opening times and prices. The information is provided by an online map service.
You can find further information about three-word addresses at: <https://+what3words.com>
- Select a destination suggestion directly on the zero layer.

Requirements:

The **Navigation** option is switched on in the user settings for **Suggestions**.

The multimedia system has gathered sufficient data in order to show destination suggestions.

- Select **Previous destinations**.

Select a previous destination.

You can save the destination as a favourite .

- Select **POIs**.

Select a POI category, e.g. **P** or enter a POI name or POI category in the input line.

If search results are displayed, limit them with **Filter**, for example by search position or the desired travel time.

- Select **Contacts**.

Requirements:

A mobile phone is connected to the multimedia system and contacts have been downloaded.

The contact contains a navigable address.

- Enter the geocoordinates as latitude and longitude in the input line.

Example 1: 47°58'11"N 7°57'25"E (degrees, minutes, seconds and compass direction)

Example 2: 47.969722 7.956944 (decimal degrees)

- Select a destination on the map.
- Select **Favourites**.

Requirements:

The destinations have been saved as favourites.

- Select **Received destinations**.

Requirements:

There is an Internet connection for receiving external destinations.

The destinations have been sent to the vehicle.

New multimedia system features

Information about the telephone menu



- 1 Bluetooth® device name of the currently connected mobile phone/of the mobile phone
- 2 Bluetooth® device name of the currently connected mobile phone/of the mobile phone (two phone mode)
- 3 Signal strength of the mobile phone network

- ④ Battery status of the connected mobile phone
- ⑤ Options
- ⑥ Messages
- ⑦ Calls up my devices
- ⑧ Numerical pad
- ⑨ Starts contact search

Telephone menu overview

Via the telephone menu you can use the functions in connection with your mobile phone.

The following functions can be used:

- Call lists
- Contacts
- Messages
- Device manager

Using call lists

If your mobile phone supports the PBAP Bluetooth® profile, the call lists from the mobile phone are displayed in the multimedia system.

The following functions are available:

- Making calls from the call list
- Opening contacts on the call list

Messages

In the message menu you can receive text messages and create and send them with the help of the MBUX voice assistant. In addition, you can conveniently use the read-aloud function during the journey.

Device manager

In the device manager, you can connect your mobile phone with the multimedia system.

You have the option of using your mobile phone alone in single telephone mode or together with another mobile phone in two phone mode.

Using contacts

If you permit the multimedia system to access the contacts in your mobile phone, you can use these in the vehicle. You can store up to 8,000 contacts.

The following options are available to you via the contacts menu:

- Making telephone calls (calling a contact)
- Navigation
- Composing messages with the help of the MBUX voice assistant

- Additional options

The contacts from your mobile phone can be downloaded automatically or manually.

Conducting a call

When conducting a call, additional functions are available apart from making, accepting or rejecting a call. For example, you can switch between calls, conduct a call with several participants or conference calls.

It is also possible to accept or reject waiting calls. If you receive a call while already in a call, a message is displayed.

During a call you can activate the following functions:

- Microphone off
- Fade in the numerical pad to send DTMF tones
- Add a call
- Hands-free mode to transfer the call to the front or rear passenger compartment
- Privacy mode to transfer the call to the telephone or headphones

Information about navigation

Digital map and user-specific applications



- ① Navigation module (reduced view) or EQ module (reduced view)

Route guidance active:

Navigation module shows in the reduced view the information relevant to the route, e.g. the next charging stop, the destination and a traffic delay



 ends the current route guidance

Tapping opens the navigation module in the expanded view with the **Route**

Route guidance not active:

EQ module is shown in the reduced view

Tapping opens the EQ module in the expanded view with the charging functions

- ② Enters a destination
 ③ Calls up the Control Center in the status line
 ④ Current vehicle position (vehicle symbol or arrow)
 ⑤ Display area with entertainment sources, phone, active applications and suggestions
 ⑥ Searches for POIs, e.g. charging stations  and parking facilities , as well as sets map orientation and map type
 ⑦ Navigation window shows the next manoeuvre (zoomed out view) or the route monitor (zoomed in view)

For example, with active route guidance, route sections of the route list, displays for upcoming driving manoeuvres, lane recommendations

 Switches off navigation announcements

 Switches on navigation announcements

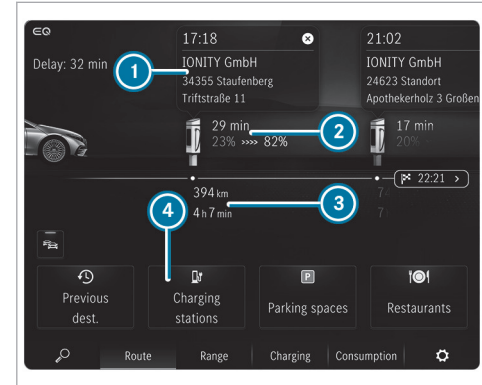

Navigation module (expanded view)



- ① Arrival time at charging stop, type of charging station
 ② Charging stop shows the charging time recommended by the navigation with Electric Intelligence as well as states of charge on arrival and onward journey for an optimal travel time

- ③ Distance from current vehicle position and remaining driving time
- ④ Searches for an additional charging station

After calling up  the digital map appears on the Zero Layer. The navigation system offers many options for destination entry, route planning and route guidance. The traffic situation is taken into account during route guidance. When using route guidance with augmented reality, additional information can be shown in a camera image before a turning manoeuvre. Services and apps help you reach the destination quickly, safely and in comfort.

You start the destination entry with  **Where to?** or in the home screen using the quick-access  beneath the application. You can enter the POI, address or contact as the destination on-board or search online using a map service. Or you select a previous destination. The destination can be stored here as a favourite or be saved as an address for home and work. If the **Allow destination suggestions** option is active, destination suggestions are available. These are determined based on your driving habits and offer a conven-

ient selection of destinations. If external destinations and routes are received from apps or services, these are also available.

A destination can be shared by scanning it using the displayed QR code.

The following options are available for route planning, for example:

- Route options:
e.g. avoid or use toll roads, tunnels, unpaved roads or areas
- Intermediate destinations
- Alternative routes
- Commuter route
- Automatic service station search

You can record and save routes then select or share them with a USB device.

Lane recommendations are shown during route guidance on multi-lane roads. When driving on a motorway, service facilities on the route ahead can be shown and used for route guidance.

The Live Traffic Information service takes the current traffic situation into account. The map can

show the current traffic flow, traffic incidents or warning messages, e.g. the end of a traffic jam in a dangerous position.

Hazardous situations on public roads are detected automatically by the vehicle via Car-to-X-Communication or these can be reported by the driver. The early warning makes it possible to adapt your driving characteristics in good time. Broken-down vehicles, accidents, weather hazards or a deployed hazard warning light are shown on the map.

The map shows map data from the database or content from an online map service. In small map scales, buildings are shown as realistic images.

Weather information and data from other services can be integrated in the map. Multi-storey car parks with the corresponding equipment, deliver data about the current occupancy and about parking charges, for example. The online map update service makes possible the updating of the map data.

The options offered vary depending on the country, vehicle equipment and available services.

Information on radio

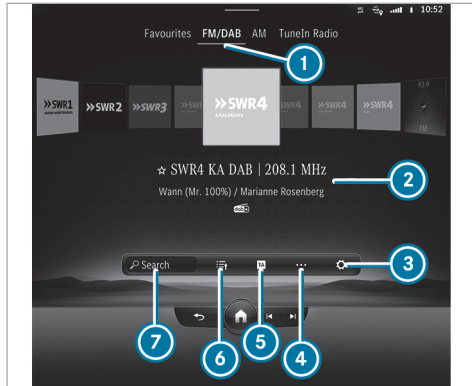

- ① Active frequency band
- ② Station name or set frequency
- ③ Settings
- ④ Additional options
- ⑤ Switches on traffic reports
- ⑥ Station list
- ⑦ Search

Using the radio menu you can play a multitude of radio stations and use the Internet Radio Tuneln. Search for your preferred stations and save these as favourites or in station lists.

❗ The function of Tuneln Internet radio is country-dependent.

Radio text: this function shows you the station name, the track and the artist for the song currently playing, for example.

DAB: with the DAB function, graphically formatted extra information about a station can be shown, e.g. logos, album covers, music tracks, programmes, news or also service information.

Traffic announcements: Traffic messages can be displayed by pressing **TA**.

Information on media

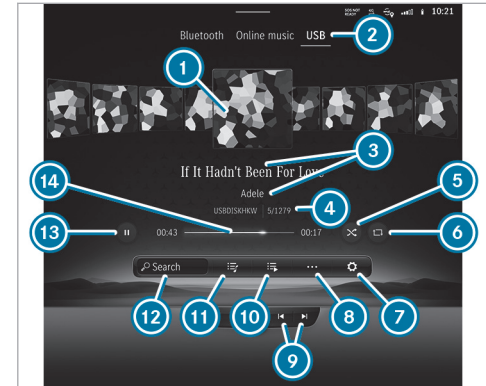

- ① Album cover
- ② Active media source
- ③ Track and artist
- ④ Active data storage medium and current track number/track in playback list
- ⑤ Random playback
- ⑥ Repeat

- 7 Settings
- 8 Additional options
- 9 Previous or next track and fast rewind or fast forward
- 10 Additional categories
- 11 Playlists and categories
- 12 Media search
- 13 Controls playback
- 14 Timeline

Using the **Media** application, you can set and use the audio and video functions of your multimedia system. You can listen to music or look at videos, for example.

USB: Using the **USB** menu, you can play back your own audio or video data from a data storage medium connected by USB.

Bluetooth®: Using the **Bluetooth** menu, you can connect Bluetooth® audio equipment with the multimedia system and play back the available tracks on the audio equipment. Connecting the device can be conveniently handled in the device manager, so you can complete all settings with just a few clicks.

Online music: The **Online music** menu allows you to access music streaming services.

Notes on comfort

The **Comfort** menu makes all the functions available that contribute to your comfort when driving or taking a break.

Seat Comfort

The **Seat** menu allows you to flexibly adjust the contours of the seats to your needs by adjusting the side bolsters and lumbar support independently. You can save these settings in your Mercedes me profile, so they can be called up each time you drive. With the **Seat kinetics** function, you can start a programme that causes slight modifications of the seat position when you are driving. These modifications promote a healthy back.

Massage

In the **Massage** menu you will find the massage programmes that are available for your vehicle. By selecting the desired program you start it directly and it runs for a period of approximately ten

minutes, depending on the program selected. With the **High intensity** function you can increase the effect of the massage programme.

Ambient light

In the **Ambient light** menu you can set the colour and brightness for your ambient lighting. Using the **Link zones** function, the ambience, accent and impression zones can be regulated separately so that you can set the lighting of your vehicle individually.

Information about smartphone integration

Using the **Smartphone Integration** menu, various applications are available that can bring the functions of your mobile phone to the multimedia system display. Operation can be carried out via the touchscreen or voice control, for example.

Only one mobile phone at a time can be connected via Smartphone Integration to the multimedia system. Also for use with two phone mode with Smartphone Integration, only one additional mobile phone can be connected using Bluetooth® with the multimedia system.

Use Android Auto for mobile phones with the Android operating system and use Apple CarPlay® with your iPhone®. The full functionality of Android Auto and Apple CarPlay® is only possible with an Internet connection.

Information on AMG Performance

Using the **AMG Performance** menu, you can call up information about the performance of your vehicle.

Depending on the vehicle the following menus are available:

- **Energy flow**

Visualisation of the energy flow in the vehicle

- **Consumption**

Display of the current and average consumption values of the vehicle

- **Vehicle**

Display of vehicle data

- **Engine**

Display of engine data such as current power and torque

- **Drive**

Display of current data of various drive elements such as current, voltage and temperature.

Information about vehicle info

You can have important vehicle information displayed in the **Info** menu. At a glance you will have an overview of vehicle and engine data or current consumption values, for example. In addition, you can call up the Digital Owner's Manual via the **Owner's Manual** menu item.

Vehicle data

The following data will be shown, for example:

- Activity of the acceleration and brake pedal
- Activity of the suspension strut
- Wheel angle
- G-force display for the linear and lateral acceleration

Engine data

The following data is shown:

- Transmission oil temperature
- Engine/coolant temperature
- Performance
- Torque
- Boost pressure

Consumption data

Depending on your driving style, this display shows the current and average fuel consumption. Together with the displays of vehicle and engine data, you can adapt your driving style to be as efficient and economical as possible.

Information about In-Car Office

Using the In-Car Office menu, you can connect your online services with the multimedia system.

You then have multiple options available:

- Organising your meetings and telephone conferences.
- Managing your e-mails and appointments.

- Have navigation to the location for a meeting.

Information about Mercedes me Apps

Using the Mercedes me Apps menu, various services and online functions are available to you:

- Managing Mercedes me services
- Using the dashcam
- Using the web browser to surf the Internet

You require a user account, and have to connect your vehicle with the user account, in order to be able to use services.

- ① If the Mercedes me App is available on a mobile phone, the vehicle connection can be accomplished using the QR code shown.

Please note that the available features are country-dependent.

Information on settings

In the **Settings** you can set the basic configuration for your multimedia system and the vehicle. You have access to all functions in this menu,

from switching the driver assistance systems on and off to display and language settings.

The settings are structured in the following menus:

- **Assistance**
- **Vehicle**
- **Lights**
- **System**

Assistance menu

With the **Assistance** menu you have direct access to the driver assistance systems which are installed in your vehicle and can either switch these on or off, or configure according to your wishes.

Vehicle menu

Here you can activate the following functions, for example:

- Automatic folding in of the outside mirrors when parking the vehicle
- Automatic adjustment of the seat and steering wheel, for comfortable entry and exit from the vehicle

- Automatic activation of the 360° camera when selecting reverse gear

Light menu

All the light settings can be carried out in the **Lights** menu. You can activate or deactivate the Intelligent Light System here, set for how long your vehicle should remain lit after parking or unlocking or switch the function off.

System menu

All important settings for the multimedia system can be carried out in the **System** menu.

You can carry out the following settings, for example:

- Setting the system language
- The configuration of Wi-Fi and Bluetooth®
- Setting of time and date

At the filling station

Topping up the windscreen washer system

⚠ WARNING Risk of fire and injury from windscreen washer concentrate

Windscreen washer concentrate is highly flammable.

▶ Avoid fire, naked flames, smoking and the creation of sparks when using windscreen washer concentrate.

Requirements

- The vehicle is unlocked.

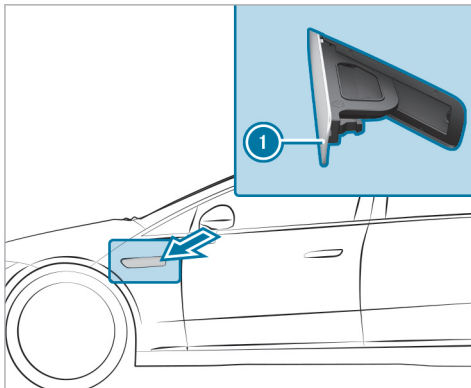

- ▶ Press on the rear area of washer fluid filler flap ①.
- ▶ Washer fluid filler flap ① will open.
- ▶ Top up the washer fluid.
- ▶ Close washer fluid filler flap ①.

You can watch an animation on this topic via the following link:

Replacing the windscreen wiper blades

⚠ WARNING Risk of becoming trapped if the windscreen wipers are switched on while wiper blades are being replaced

If the windscreen wipers begin to move while you are changing the wiper blades, you can be trapped by the wiper arm.

▶ Always switch off the windscreen wipers and vehicle before changing the wiper blades.

Moving the wiper arms into the replacement position

- ▶ Switch the vehicle on and then off again immediately.
- ▶ Within around 15 seconds, press and hold the  button on the combination switch for approximately three seconds (→ page 226). The wiper arms will move into the replacement position.

Removing the wiper blades

- ▶ Fold the wiper arms away from the wind-screen.

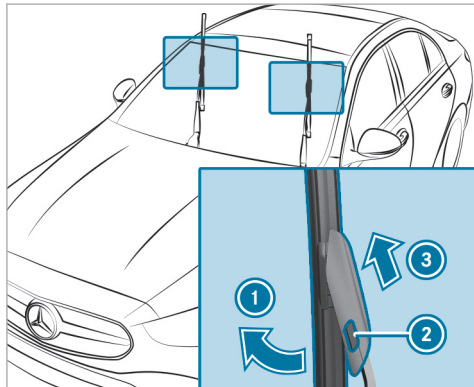

- ▶ Hold the wiper arm with one hand. With the other hand, turn the wiper blade away from the wiper arm in the direction of arrow ① as far as it will go.
- ▶ Press release button ②.

- ▶ Remove the wiper blade from the wiper arm in the direction of arrow ③.

Fitting the wiper blades

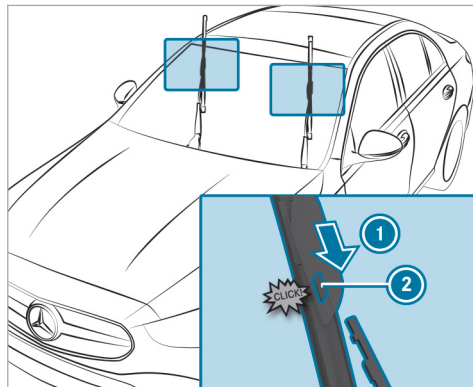

- ▶ Push the new wiper blade into the wiper arm in the direction of arrow ① until release knob ② engages.
- ▶ Make sure that the wiper blade is seated correctly.

- ▶ Fold the wiper arms back onto the wind-screen.
- ▶ Switch on the vehicle.
- ▶ Press the  button on the combination switch. The wiper arms will return to their original positions.
- ▶ Switch off the vehicle.

- ⓘ Check the condition of the wiper blades regularly and replace them in the event of visible damage or ongoing smearing.

Service indicator

There is a service indicator at the tip of the newly mounted wiper blade.

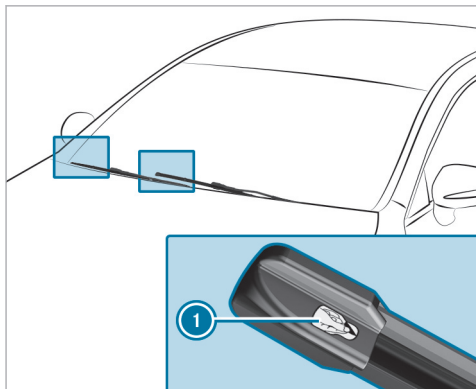

- ▶ Remove protective film ① from the service indicator.

When the colour of the service indicator changes from black to yellow, the wiper blades should be replaced.

Information on washing the vehicle in a car wash

⚠ WARNING Risk of an accident due to reduced braking power after washing the vehicle

Braking efficiency is reduced after washing the vehicle.

- ▶ After the vehicle has been washed, brake carefully while paying attention to the traffic conditions until braking power has been fully restored.

⚠ NOTE Damage from automatic braking

If one of the following functions is activated, the vehicle will brake automatically in certain situations:

- Active Brake Assist
- Active Distance Assist DISTRONIC
- HOLD function
- Active Parking Assist

To avoid damaging the vehicle, deactivate these systems e.g. during towing or in the car wash.

⚠ NOTE Damage due to unsuitable car wash

- ▶ Before driving into a car wash make sure that the car wash is suitable for the vehicle dimensions.
- ▶ Ensure there is sufficient ground clearance between the underbody and the guide rails of the car wash.
- ▶ Ensure that the clearance width of the car wash, in particular the width of the guide rails, is sufficient.

To avoid damage to your vehicle when using a car wash, ensure the following beforehand:

- Active Distance Assist DISTRONIC is deactivated.
- The HOLD function is switched off.
- The 360° camera or the reversing camera is switched off.

- The vehicle is locked and the door handles are retracted.
- The side windows and sliding sunroof are completely closed.
- The outside mirrors are folded in.
- The blower for the ventilation and heating is switched off.
- The windscreen wiper switch is in position **0**.
- The key is at a minimum distance of 6 m away from the vehicle. Otherwise, the boot lid or a door could open unintentionally.

This also applies to the Digital Vehicle Key.

- For car washes with a conveyor system:
 - Neutral **N** is engaged.
 - The vehicle is locked from the inside.

i If, after the car wash, you remove the wax from the windscreen and wiper rubbers, this will prevent smearing and reduce wiper noise.

Automatic car wash mode

In car wash mode, the vehicle is prepared for driving into an automatic car wash. Car wash mode

can be activated at a speed of up to 20 km/h (→ page 601).

When car wash mode is activated, the **Car wash mode active** message will appear on the driver's display. The following adjustments will be made:

- The outside mirrors will be folded in.
- To prevent the windscreen washer system from starting up automatically, the rain sensor will be deactivated.
- The windows and the sliding sunroof will be closed, if necessary.
- The comfort doors will be deactivated.
- Parking Assist PARKTRONIC will be deactivated.
- **Vehicles with 360° camera:** The front image will be activated after approximately eight seconds.
- **Vehicles with HANDS-FREE ACCESS:** kick detection will be deactivated.

If one of the settings cannot be selected, this will be shown by the **X** symbol next to the respective setting.

Pressing **Switch off** will cancel car wash mode. Above a speed of 20 km/h, car wash mode will be deactivated automatically.

You can also switch off car wash mode via the MBUX multimedia system (→ page 601).

The following settings will be reset when car wash mode is deactivated:

- The outside mirrors will be folded out.
- The rain sensor will be activated.
- The comfort doors will be activated.
- Parking Assist PARKTRONIC will be reset to the previously selected setting.
- The windows and the sliding sunroof will remain closed.
- **Vehicles with 360° camera:** The front image will be deactivated at speeds above 18 km/h.
- **Vehicles with HANDS-FREE ACCESS:** kick detection will be activated.

Preparing for a holiday

Notes on adjusting the lights when driving abroad

As a convenience function, the headlamps automatically adjust when the vehicle crosses the border into a country where traffic drives on the other side of the road. If necessary, the headlamps can also be adjusted manually in the **Low beam** menu (→ page 223).

The automatic light adjustment function is available:

- If Automatic is activated in the **Low beam** menu
- If the navigation and the navigation position are available

In the following cases, check the headlamp setting and change it manually if necessary:

- If the **Low beam setting (left/right-side traffic) Manual adjustment only** display message is displayed.
- If the **Check low beam setting (left/right-side traffic)** display message is displayed.

Following manual adjustment:

- Oncoming traffic will not be dazzled.
- The edge of the road will not be illuminated as far or as high.
- The "motorway mode" and "enhanced fog light" functions will not be available.

Notes on regularly inspecting wheels and tyres

⚠ WARNING Risk of injury due to damaged tyres

Damaged tyres can cause tyre pressure loss.

- ▶ Check the tyres regularly for signs of damage and replace any damaged tyres immediately.

⚠ WARNING Risk of aquaplaning due to insufficient tyre tread

Insufficient tyre tread will result in reduced tyre grip.

The risk of aquaplaning is increased on wet roads, especially when the speed of the vehicle is not adapted to suit the conditions.

- ▶ Thus, you should regularly check the tread depth and the condition of the tread across the entire width of all tyres.

Minimum tread depth for:

- Summer tyres: 3 mm
- M+S tyres: 4 mm
- ▶ For safety reasons, replace the tyres before the legally-prescribed limit for the minimum tread depth is reached.

Carry out the following checks on all wheels regularly, at least once a month or as required, for example, prior to a long journey or driving off-road:

- Check the tyre pressure (→ page 628).
- Visually inspect wheels and tyres for damage.
- Check the valve caps.
- Visual check of the tyre tread depth and the tyre contact surface across the entire width.

The minimum tread depth for summer tyres is 3 mm and for winter tyres 4 mm.

Removing the safety vest

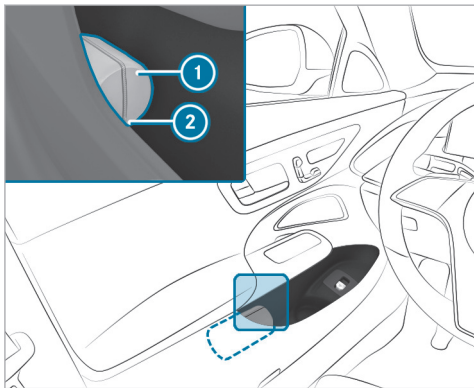

There is a high-visibility waistcoat compartment on the door shelves of all doors for storing a high-visibility waistcoat.

- ▶ To remove: pull out safety vest bag ① by loop ②.
- ▶ Open the safety vest bag ① and pull out the safety vest.
- ▶ Replace: Fold up the safety vest, roll it up and place it in the safety vest ①.
- ▶ Slide the safety vest bag ① along the lower edge of the armrest into the safety vest compartment. Ensure that the loop ② hangs out so that it is easy to reach.

- ⓘ Remove the packaging film before sliding it into the safety vest compartment for a new safety vest. Otherwise, it may cause unintentional slipping or make removing difficult. Observe the legal requirements in the individual countries.

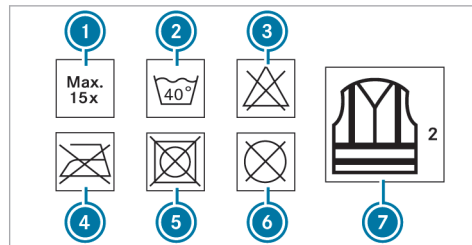

- ① Maximum number of washes
- ② Maximum wash temperature
- ③ Do not bleach
- ④ Do not iron
- ⑤ Do not tumble dry
- ⑥ Do not dry clean
- ⑦ Class 2 safety vest

The requirements defined by the legal standard are only fulfilled if the safety vest is the correct size and is fully closed.

Replace the safety vest in the following cases:

- The reflective strips are damaged or dirty

- The maximum permissible number of washes is exceeded
- The fluorescence property decreases, e.g. due to permanent exposure to sunlight.

Dispose of the safety vest in an environmentally friendly way:

- Please contact your local waste disposal company.

Removing the warning triangle

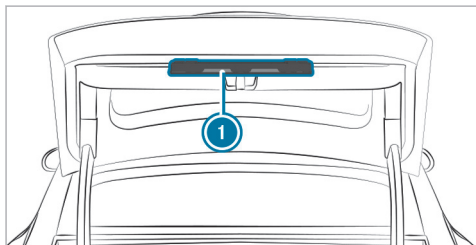

- ▶ Remove the warning triangle ①.

First-aid bag

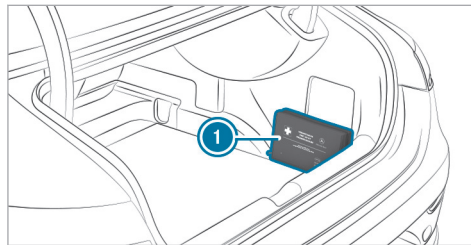

The first-aid bag ① is located on the right-hand side of the boot in the as-delivered condition.

Map data update overview

As the content of a digital road map has a short life, outdated data may have a negative effect on all navigation functions. For the best MBUX navigation experience, you should install all of the map updates offered by Mercedes-Benz.

The following options are available for the update of map data:

- Online map update

- Updates from the Mercedes me Portal
- Update at a Mercedes-Benz service centre
Additional costs can be incurred in this process.

Online map update

Requirements:

- Mercedes me connect is available.
- You have a Mercedes me user account.
- The Online Map Update service is available for your region.
- The service has been activated.

① The Online Map Update service is only available in certain countries.

Installation takes place in the background as an automatic map update.

The MBUX multimedia system installs all of the available map updates for the European regions in which the vehicle is located or is moved.

The online map update is activated at the latest after the next time the vehicle is switched on.

Updates from the Mercedes me Portal

The map data for several regions can also be updated manually. Log in with your Mercedes me user account at: <https://www.mercedes-benz.de/>

Follow the menu path **My Mercedes Me account > My vehicles > Selection of car > Online Map Update**. Select the regions to be downloaded to a storage medium.

After the map data has been copied, connect the storage medium with your vehicle. Select the notification with information about a new version of the map data and start the installation. After the MBUX multimedia system has been restarted, the updated map data is used.

Entering a POI or address

Requirements:

Observe the notes on destination entry (→ page 478).

- **For the online search:**

- There is an Internet connection.
- Mercedes me connect is available.

- The vehicle is connected with the user account and you have accepted the Mercedes me connect terms of use.
- Further information can be found at: <https://www.mercedes.me>
- The service is available and has been activated.

i If Online Search is not available, the search is performed using the data of the digital map.

Multimedia system:

→    Where to?

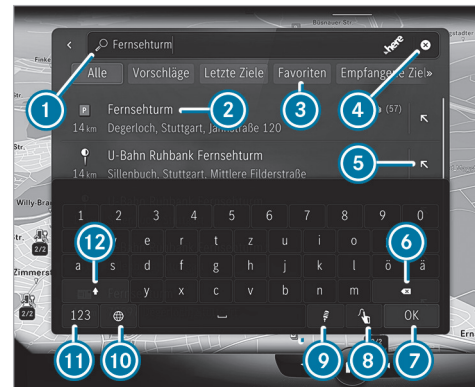

Example: entering a POI or address

- 1 Input line with current entry
- 2 Search result
- 3 Selects destination search, displays further destination searches with double arrow
- 4 Deletes an entry

- ⑤ Adopts the search result in the input line and continues the search
 - ⑥ Deletes the last character entered
 - ⑦ Hides the keypad
 - ⑧ Switches to handwriting recognition (→ page 454)
 - ⑨ Starts the MBUX voice assistant (→ page 419)
 - ⑩ Sets the written language
 - ⑪ Switches to digits and special characters
 - ⑫ Switches to upper-case or lower-case letters
- ▶ Enter a destination. The entries can be made in any order.
The search results are displayed in a list.
- ① Online search results for POIs may contain additional information, for example opening times and ratings. The information is provided by an online map service.
This online function is not available in all countries.

The following entries can be made, for example in ①:

- Town, street, house number or street, town
- Postcode
- POI name or POI category, e.g. [Restaurants](#)
- Town, POI name
- Contact name
- Geo-coordinates (→ page 482)
- Three-word addresses from what3words (→ page 482)

Entering three-word addresses is possible in the online search .

- ▶ Hide the keyboard with .
- ▶ Select the destination in the list.
The following menu shows the selected destination with the address information and a corresponding map section.
The menu enables the route to be calculated.

Searching for radio stations using station names or frequency entry

Multimedia system:



Radio

- ▶ Select .
- ▶ Enter a station name or frequency.
- ▶ Select a station.

Luggage and loading

Attaching a roof luggage rack

⚠ WARNING Risk of accident due to exceeding the maximum roof load

The vehicle centre of gravity and the usual driving characteristics as well as the steering and braking characteristics alter.

If you exceed the maximum roof load, the driving characteristics, as well as steering and braking, will be greatly impaired.

- ▶ Never exceed the maximum roof load and adjust your driving style.

You will find information on the maximum roof load in the "Technical data" section in the printed Owner's Manual.

- ! **NOTE** Damage to the vehicle due to not observing the maximum permitted headroom clearance

If the vehicle height is greater than the maximum permitted headroom clearance, the roof and other parts of the vehicle may be damaged.

- ▶ Observe the signposted headroom clearance.
- ▶ If the vehicle height is greater than the permitted headroom clearance, do not enter.
- ▶ Observe the changed vehicle height with add-on roof equipment.

- ! **NOTE** Vehicle damage from non-approved roof luggage racks

The vehicle could be damaged by roof luggage racks that have not been tested and approved by Mercedes-Benz.

- ▶ Only use roof luggage racks tested and approved for Mercedes-Benz.
- ▶ Depending on the vehicle equipment, ensure that when the roof luggage rack is fitted, the tailgate can be fully opened.
- ▶ Position the load on the roof luggage rack in such a way that the vehicle will not sustain damage even when it is in motion.

- ! **NOTE** Damage to panorama sliding sunroof caused by roof luggage rack

If the panorama sliding sunroof is opened when a roof luggage rack is fitted, the panorama sliding sunroof may be damaged by the roof luggage rack.

- ▶ Do not open the panorama sliding sunroof if a roof luggage rack is fitted.

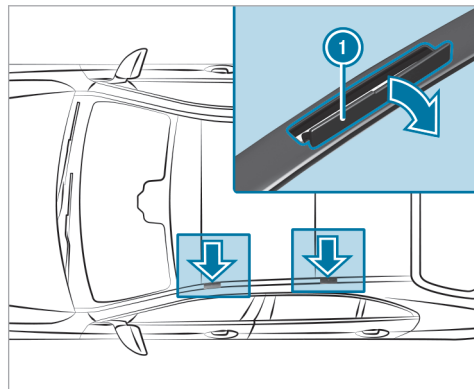

- ! **NOTE** Damage to the covers

The covers may be damaged and scratched when being opened.

- ▶ Do not use metallic or hard objects.

- ▶ Carefully fold covers ① upwards in the direction of the arrow.
- ▶ Secure the roof luggage rack to the fastening points beneath covers ①.
- ▶ Comply with the installation instructions of the roof luggage rack manufacturer.
- ▶ Secure the load on the roof luggage rack.

Folding the rear seat backrests forward

⚠ WARNING Risk of becoming trapped when adjusting the seats

When you adjust a seat, you may trap yourself or a vehicle occupant.

- ▶ When adjusting a seat, make sure that no one has any body parts in the sweep of the seat.

⚠ WARNING Risk of an accident because the seat backrest is not engaged

The seat backrest may fold forwards.

There is a risk of the following, in particular:

- The vehicle occupant may be pressed against the seat belt. The seat belt cannot protect as intended and could cause additional injury.
- A child restraint system is no longer properly supported or properly positioned and may no longer fulfil its function as intended.
- The seat backrest cannot restrain objects or goods in the boot or load compartment.

Always ensure that the seat backrest is engaged, especially:

- After the seat has been adjusted.
- After the load compartment enlargement has been folded forwards

Make sure that the red marking of the lock verification indicator is no longer visible. Otherwise, the seat backrest will not be locked.

Always ensure that all vehicle occupants have their seat belts fastened correctly and are sitting

properly. Particular attention must be paid to children.

Requirements:

- The rear seat backrest head restraints are fully inserted.
- Vehicles with a folding rear armrest: the rear armrest has been folded up.

Folding the rear outer seat backrests forward

You can fold the centre and right seat backrests forwards separately.

The left seat backrest can be folded forwards only together with the centre seat backrest.

If you no longer require the folded-down rear seat backrest as a load area, fold the backrest back into place.

- ▶ Ensure that the centre seat backrest is in an upright position and locked to the left seat backrest (→ page 198).

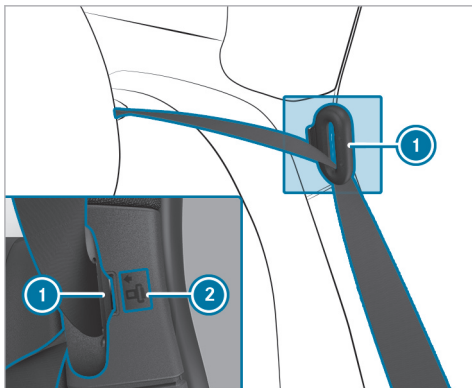

- ▶ Press the seat belt tongue of seat belt ① into marked position ②.
- ▶ Move the driver's or front passenger seat forwards, if necessary.

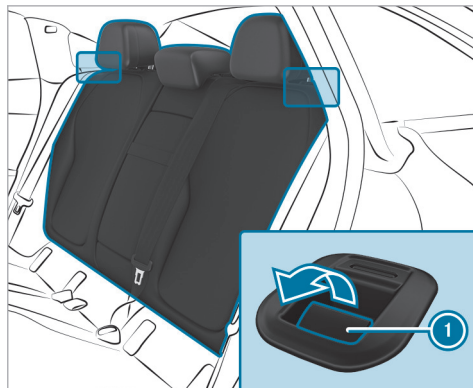

- ▶ Pull release lever ①.
- ▶ Fold the corresponding seat backrest forwards.

Folding the centre rear seat backrest forwards separately

If you no longer require the folded-down seat backrest as a loading area, fold the backrest back into place.

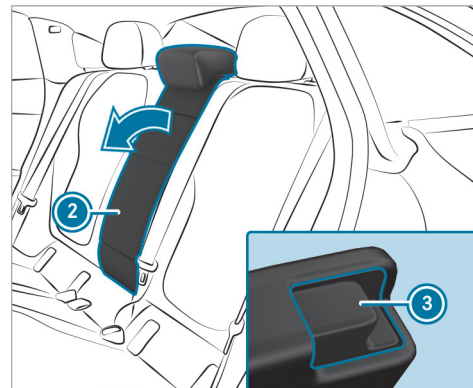

- ▶ Press release catch ③.
- ▶ Fold the seat backrest ② forwards.

Folding back the rear seat backrest

⚠ WARNING Risk of becoming trapped when adjusting the seats

When you adjust a seat, you may trap yourself or a vehicle occupant.

- ▶ When adjusting a seat, make sure that no one has any body parts in the sweep of the seat.

⚠ WARNING Risk of an accident because the seat backrest is not engaged

The seat backrest may fold forwards.

There is a risk of the following, in particular:

- The vehicle occupant may be pressed against the seat belt. The seat belt cannot protect as intended and could cause additional injury.
- A child restraint system is no longer properly supported or properly positioned and may no longer fulfil its function as intended.

- The seat backrest cannot restrain objects or goods in the boot or load compartment.

Always ensure that the seat backrest is engaged, especially:

- After the seat has been adjusted.
- After the load compartment enlargement has been folded forwards

Make sure that the red marking of the lock verification indicator is no longer visible. Otherwise, the seat backrest will not be locked.

Always ensure that all vehicle occupants have their seat belts fastened correctly and are sitting properly. Particular attention must be paid to children.

! NOTE Damage caused by trapping the seat belt when folding back the seat backrest

The seat belt could become trapped and thus be damaged when the seat backrest is folded back.

- ▶ Make sure that the seat belt is not trapped when folding back the seat backrest.

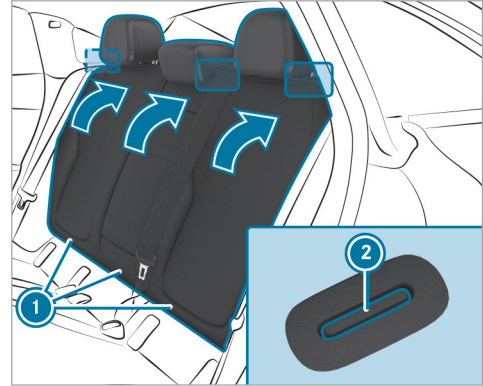

- ▶ Move the driver's or front passenger seat forwards, if necessary.
- ▶ Swivel seat backrest ① back until it engages. If the seat backrest is not engaged and locked in place, red lock verification indicator ② will be visible.

Opening the stowage space under the boot floor

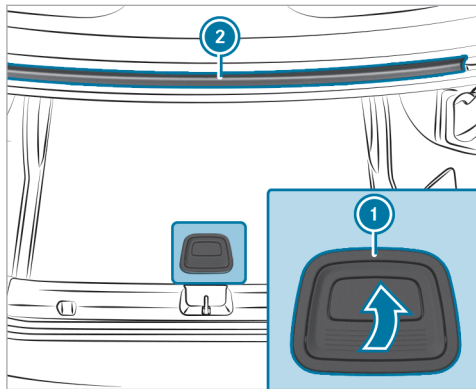

- ▶ Pull handle ① up and hook it into drip rail ②.

Folding the ball neck out and in

⚠ WARNING Risk of accident due to the ball neck not being engaged

If the ball neck is not engaged, the trailer may come loose.

- ▶ Always engage the ball neck as described.

⚠ WARNING Risk of injury from ball neck swinging outwards

The ball neck may swing outwards when unlocking or when it has not been properly engaged.

There is a risk of injury within the ball neck's range of movement!

- ▶ Unlock the ball neck only when its range of movement is unobstructed.
- ▶ Always be sure the ball neck is engaged when folding inwards.

! NOTE Increased risk of damage to property due to folded-out ball neck

- ▶ When the trailer is not coupled or the bicycle rack is attached, fold in the ball neck or, in the case of a fully electric trailer hitch, retract the ball neck.

! NOTE Damage to the vehicle due to incorrect use of the trailer hitch

If a trailer hitch is used to recover the vehicle, the vehicle or the trailer hitch itself may be damaged in the process.

- ▶ Use the trailer hitch only for pulling a trailer or attaching approved carrier systems (e.g. a bicycle rack).

Exception: Since vehicles with a trailer hitch do not have a fixture for a towing eye at the rear, towing or tow-starting is permitted.

- ▶ When towing or tow-starting with the trailer hitch, observe the information in the section "Fitting and removing the towing eye."

Folding the ball neck out

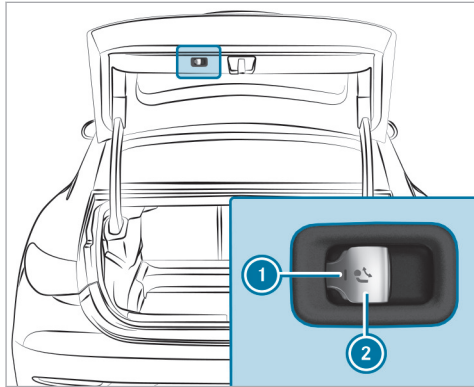

- ▶ Secure the vehicle against rolling away.
 - ▶ Keep the swivel range clear.
 - ▶ Remove the trailer cable or adapter plug.
 - ▶ Pull switch ② until the ball neck unlocks. The ball neck will fold out from under the rear bumper.
- Indicator lamp ① will flash.

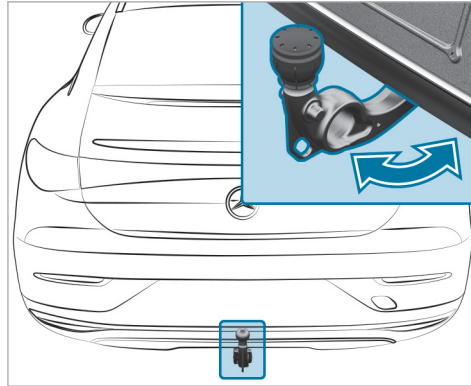

- ▶ Pull the ball neck in the direction of the arrow until it engages audibly in a vertical position. Indicator lamp ① on the ball neck release switch will go out.
- If the ball neck is not securely locked in place, a message reading **Trailer coupling Check lock** will appear on the driver's display.
- ▶ Remove the cover cap from the ball head and store it in a safe place.

Make sure that the ball on the ball neck is clean. Check that it is either greased or dry (grease-free), depending on the instructions for the trailer.

Folding the ball neck in

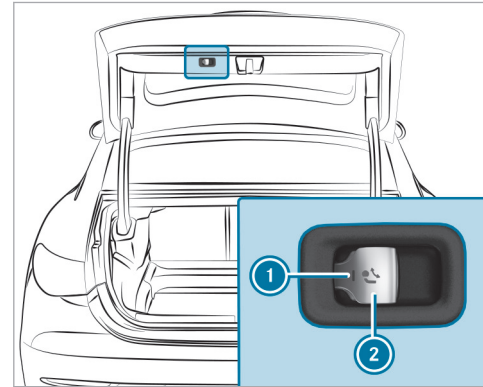

- ▶ Pull switch ② until the ball neck unlocks. The ball neck will fold up under the rear bumper.
- Indicator lamp ① will flash.

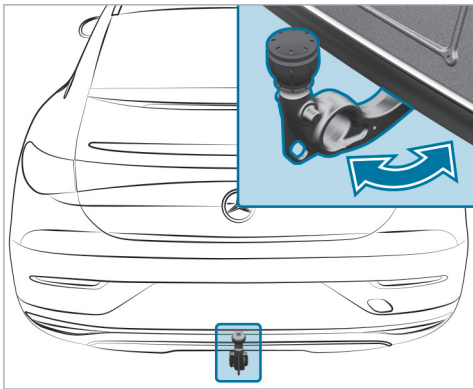

- ▶ Push the ball neck in the direction of the arrow until it engages audibly behind the bumper. Indicator lamp ❶ will go out and the message on the driver's display will disappear.

Observe the information about indicators on the driver's display:

- Indicator and warning lamps (→ page 858)
- Display messages (→ page 770)

Overview of the tie-down eyes

Observe the notes on loading the vehicle (→ page 190).

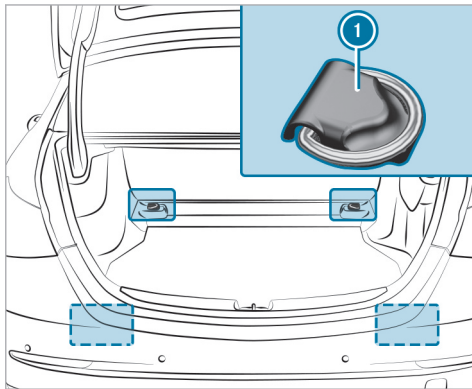

❶ Tie-down eyes

❶ Four tie-down eyes are available only in vehicles equipped with the through-loading feature in the rear bench seat (EASY-PACK Quickfold).

Overview of the front stowage compartments

⚠ WARNING Risk of injury due to objects being stowed incorrectly

If objects in the vehicle interior are stowed incorrectly, they can slide or be thrown around and hit vehicle occupants. In addition, cup holders, open stowage spaces and mobile phone brackets cannot always retain all objects they contain.

There is a risk of injury, particularly in the event of sudden braking or a sudden change in direction.

- ▶ Always stow objects in such a way that they cannot be thrown around in such situations.
- ▶ Always make sure that objects do not protrude from stowage spaces, luggage nets or stowage nets.
- ▶ Close the lockable stowage spaces before starting a journey.

- ▶ Always stow and secure heavy, hard, pointed, sharp-edged, fragile or bulky objects in the boot.

Observe the notes on loading the vehicle.

⚠ WARNING Risk of accident from objects in the driver's footwell and front-passenger footwell

Objects in the driver's footwell and front-passenger footwell may impede pedal travel or block a depressed pedal.

This jeopardises the operating and road safety of the vehicle.

- ▶ Stow all objects in the vehicle securely so that they cannot get into the driver's footwell or front-passenger footwell.
- ▶ Always fit the floor mats securely and as prescribed in order to ensure that there is always sufficient clearance for the pedals.

- ▶ Do not use loose floor mats and do not lay multiple floor mats on top of one another.

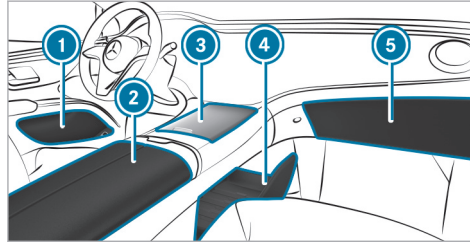

- ① Storage spaces in the doors
- ② Storage and telephone compartment beneath the armrest with multimedia and USB ports as well as stowage space, e.g. for an MP3 player
- ③ Storage compartment in the front centre console, with cup holders, USB ports and charging module for wireless charging of mobile phones depending on the vehicle version

- ④ Stowage tray below the central display of the multimedia system with USB ports
- ⑤ Glove compartment
- ⓘ The rubber mat in the stowage compartment in front centre console ③ can be removed for cleaning with clean, lukewarm water. Please comply with the notes on caring for the interior (→ page 605).
- ⓘ Use the rubber strap to securely store objects in the stowage tray under the central display.

Opening and closing the glove compartment

⚠ WARNING Risk of injury due to objects being stowed incorrectly

If objects in the vehicle interior are stowed incorrectly, they can slide or be thrown around and hit vehicle occupants. In addition, cup holders, open stowage spaces and mobile phone brackets cannot always retain all objects they contain.

There is a risk of injury, particularly in the event of sudden braking or a sudden change in direction.

- ▶ Always stow objects in such a way that they cannot be thrown around in such situations.
- ▶ Always make sure that objects do not protrude from stowage spaces, luggage nets or stowage nets.
- ▶ Close the lockable stowage spaces before starting a journey.
- ▶ Always stow and secure heavy, hard, pointed, sharp-edged, fragile or bulky objects in the boot.

Observe the notes on loading the vehicle.

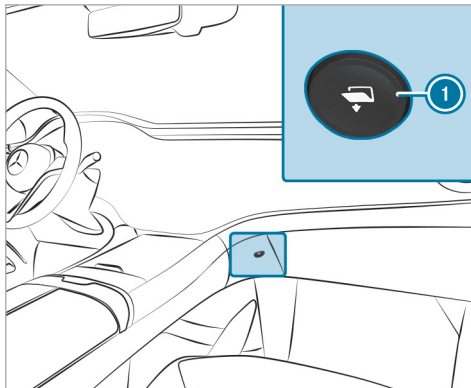

- ▶ **To open:** press button ①.
The glove compartment will open.
- ▶ **To close:** fold the glove compartment upwards.
The glove compartment will close.

Ice and snow

Notes on regularly inspecting wheels and tyres

⚠ WARNING Risk of injury due to damaged tyres

Damaged tyres can cause tyre pressure loss.

- ▶ Check the tyres regularly for signs of damage and replace any damaged tyres immediately.

⚠ WARNING Risk of aquaplaning due to insufficient tyre tread

Insufficient tyre tread will result in reduced tyre grip.

The risk of aquaplaning is increased on wet roads, especially when the speed of the vehicle is not adapted to suit the conditions.

- ▶ Thus, you should regularly check the tread depth and the condition of the tread across the entire width of all tyres.

Minimum tread depth for:

- Summer tyres: 3 mm
- M+S tyres: 4 mm

▶ For safety reasons, replace the tyres before the legally-prescribed limit for the minimum tread depth is reached.

Carry out the following checks on all wheels regularly, at least once a month or as required, for example, prior to a long journey or driving off-road:

- Check the tyre pressure (→ page 628).
- Visually inspect wheels and tyres for damage.
- Check the valve caps.
- Visual check of the tyre tread depth and the tyre contact surface across the entire width. The minimum tread depth for summer tyres is 3 mm and for winter tyres 4 mm.

Setting the speed limit for winter tyres

Multimedia system:

→  ▶ Settings ▶ Vehicle ▶ Driving ▶ Winter tyre limit

▶ Activate or deactivate **Winter tyre limit**.

Setting a speed

▶ Select **Winter tyre limit**.

▶ Select a speed.

Notes on snow chains

⚠ WARNING Risk of accident due to incorrectly fitted snow chains

If you have fitted snow chains to the front wheels, they may drag against the vehicle body or chassis components.

- ▶ Never fit snow chains to the front wheels.
- ▶ Only fit snow chains on the rear wheels in pairs.

! **NOTE** Damage to components of the vehicle body or chassis due to fitted snow chains

If you fit snow chains to the front wheels of 4MATIC vehicles, you may damage components of the vehicle body or chassis.

▶ Only fit snow chains to the rear wheels of 4MATIC vehicles.

! **NOTE** Damage to wheel trims through fitted snow chains

If you fit snow chains on aluminium wheels you could damage the wheel trims.

▶ Remove the wheel trims from the aluminium wheels before fitting snow chains.

Observe the following notes when using snow chains:

- Snow chains are only permissible for certain wheel/tyre combinations. You can obtain information about this from a Mercedes-Benz Service Centre.

- For safety reasons, only use snow chains that have been specifically approved for your vehicle by Mercedes-Benz, or snow chains with the same quality standard.
 - Comply with the installation instructions of the snow chain manufacturer.
 - If snow chains are fitted, the maximum permissible speed is 50 km/h.
 - **Vehicles with Active Parking Assist:** do not use Active Parking Assist when snow chains are fitted.
 - **Vehicles with AIRMATIC:** if snow chains are fitted, only drive at raised vehicle level (→ page 358).
 - **Vehicles with rear axle steering:** if snow chains are fitted, only drive with snow chain mode active (→ page 628).
- i** You can permanently limit the maximum speed for driving with winter tyres (→ page 321).
- i** You can deactivate ESP® to pull away (→ page 310). This allows the wheels to spin, achieving an increased driving force.

Notes on windscreen washer fluid

Observe the notes on operating fluids (→ page 759).

⚠ WARNING Risk of fire and injury from windscreen washer concentrate

Windscreen washer concentrate is highly flammable. If it comes into contact with hot components, it may ignite.

▶ Make sure that windscreen washer concentrate is not spilled near to the filler opening.

! NOTE Damage to the exterior lighting due to unsuitable windscreen washer fluid

Unsuitable windscreen washer fluids may damage the plastic surface of the exterior lighting.

▶ Only use windscreen washer fluids which are also suitable for use on plastic surfaces, e.g. MB SummerFit or MB WinterFit.

! NOTE Blocked spray nozzles caused by mixing windscreen washer fluids

▶ Do not mix MB SummerFit and MB WinterFit with other windscreen washer fluids.

Do not use distilled or de-ionised water. Otherwise, the fill level sensor may be triggered erroneously.

Recommended windscreen washer fluid:

- above freezing point: e.g. MB SummerFit
- below freezing point: e.g. MB WinterFit

For the correct mixing ratio, refer to the information on the antifreeze container.

Mix washer fluid with windscreen washer fluid all year round.

Windscreen washer system

Washer fluid reservoir capacity

Model	Filling volume
All models	Maximum 3.7 l

Topping up the windscreen washer system

⚠ WARNING Risk of fire and injury from windscreen washer concentrate

Windscreen washer concentrate is highly flammable.

▶ Avoid fire, naked flames, smoking and the creation of sparks when using windscreen washer concentrate.

Requirements

- The vehicle is unlocked.

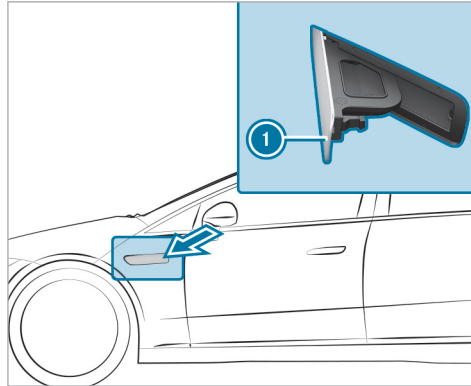

- ▶ Press on the rear area of washer fluid filler flap ①.
- ▶ Washer fluid filler flap ① will open.
- ▶ Top up the washer fluid.
- ▶ Close washer fluid filler flap ①.

You can watch an animation on this topic via the following link:

Replacing the windscreen wiper blades

⚠ WARNING Risk of becoming trapped if the windscreen wipers are switched on while wiper blades are being replaced

If the windscreen wipers begin to move while you are changing the wiper blades, you can be trapped by the wiper arm.

▶ Always switch off the windscreen wipers and vehicle before changing the wiper blades.

Moving the wiper arms into the replacement position

- ▶ Switch the vehicle on and then off again immediately.
- ▶ Within around 15 seconds, press and hold the  button on the combination switch for approximately three seconds (→ page 226). The wiper arms will move into the replacement position.

Removing the wiper blades

- ▶ Fold the wiper arms away from the wind-screen.

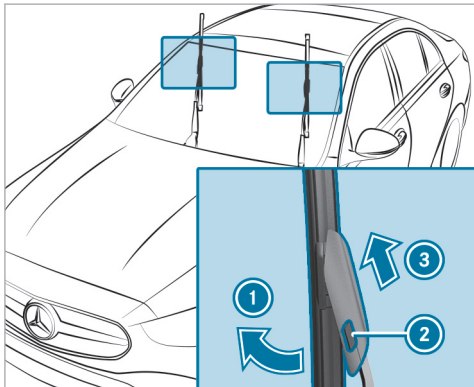

- ▶ Hold the wiper arm with one hand. With the other hand, turn the wiper blade away from the wiper arm in the direction of arrow ① as far as it will go.
- ▶ Press release button ②.

- ▶ Remove the wiper blade from the wiper arm in the direction of arrow ③.

Fitting the wiper blades

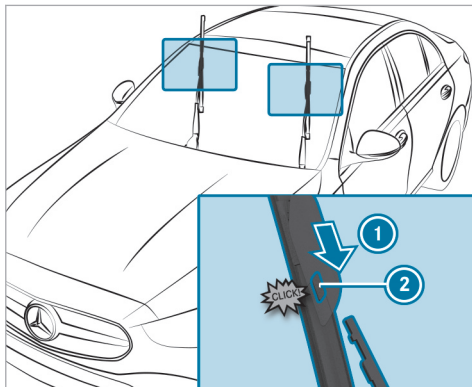

- ▶ Push the new wiper blade into the wiper arm in the direction of arrow ① until release knob ② engages.
- ▶ Make sure that the wiper blade is seated correctly.

- ▶ Fold the wiper arms back onto the wind-screen.
- ▶ Switch on the vehicle.
- ▶ Press the  button on the combination switch. The wiper arms will return to their original positions.
- ▶ Switch off the vehicle.

- ⓘ Check the condition of the wiper blades regularly and replace them in the event of visible damage or ongoing smearing.

Service indicator

There is a service indicator at the tip of the newly mounted wiper blade.

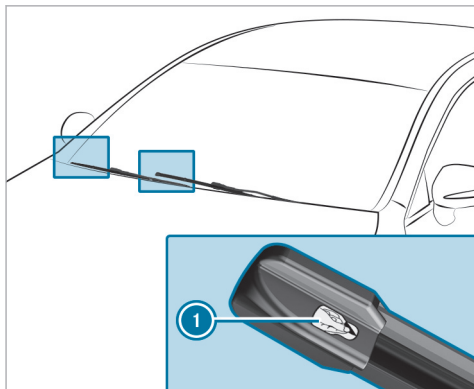

- ▶ Remove protective film ① from the service indicator.

When the colour of the service indicator changes from black to yellow, the wiper blades should be replaced.

Help in the event of a breakdown Activating/deactivating the hazard warning lights

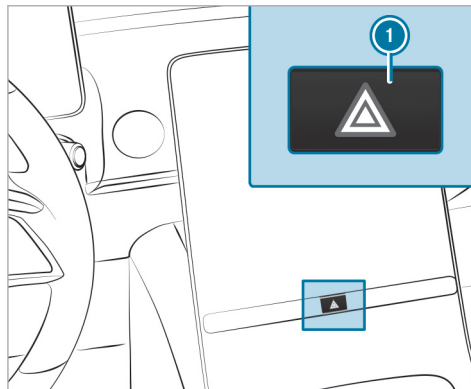

Vehicles without MBUX Hyperscreen

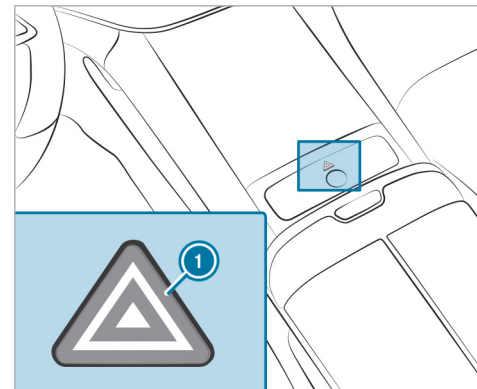

Vehicles with MBUX Hyperscreen

- ▶ Press button ①.

The hazard warning lights will switch on automatically if:

- the airbag has been deployed.
- the vehicle brakes are applied heavily from a speed of more than 70 km/h to a standstill.

When you pull away again, the hazard warning light system will switch off automatically at approximately 10 km/h. You can also switch off the hazard warning light system using the warning lamp button.

Removing the fire extinguisher

⚠ WARNING Risk of accident due to an incorrectly secured fire extinguisher in the driver's footwell

A fire extinguisher may impede pedal travel or block a depressed pedal.

This jeopardises the operating and road safety of the vehicle.

The fire extinguisher can be flung around and injure the driver or other vehicle occupants.

- ▶ Always store and secure the fire extinguisher in the bracket.
- ▶ Do not remove the fire extinguisher while driving.

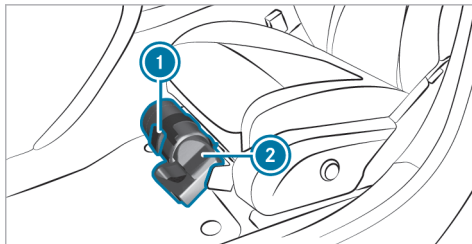

- ▶ **Left-hand drive vehicle:** pull tab ① upwards.
- ▶ **Right-hand drive vehicle:** pull tab ① downwards.
- ▶ Remove fire extinguisher ②.

Removing the safety vest

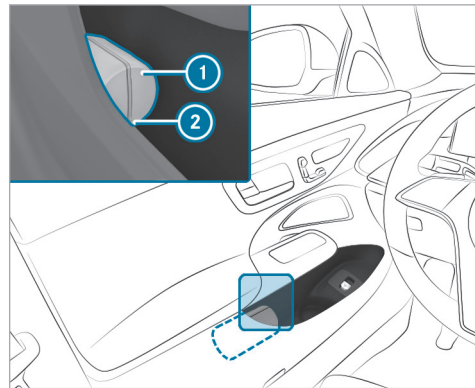

There is a high-visibility waistcoat compartment on the door shelves of all doors for storing a high-visibility waistcoat.

- ▶ To remove: pull out safety vest bag ① by loop ②.
- ▶ Open the safety vest bag ① and pull out the safety vest.
- ▶ Replace: Fold up the safety vest, roll it up and place it in the safety vest ①.

▶ Slide the safety vest bag ① along the lower edge of the armrest into the safety vest compartment. Ensure that the loop ② hangs out so that it is easy to reach.

ⓘ Remove the packaging film before sliding it into the safety vest compartment for a new safety vest. Otherwise, it may cause unintentional slipping or make removing difficult. Observe the legal requirements in the individual countries.

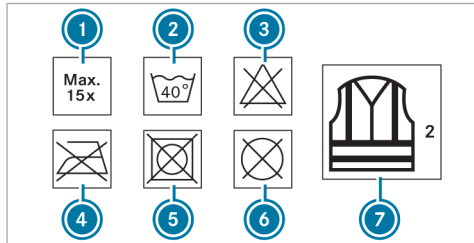

- ① Maximum number of washes
- ② Maximum wash temperature
- ③ Do not bleach
- ④ Do not iron

- ⑤ Do not tumble dry
- ⑥ Do not dry clean
- ⑦ Class 2 safety vest

The requirements defined by the legal standard are only fulfilled if the safety vest is the correct size and is fully closed.

Replace the safety vest in the following cases:

- The reflective strips are damaged or dirty
- The maximum permissible number of washes is exceeded
- The fluorescence property decreases, e.g. due to permanent exposure to sunlight.

Dispose of the safety vest in an environmentally friendly way:

- Please contact your local waste disposal company.

Removing the warning triangle

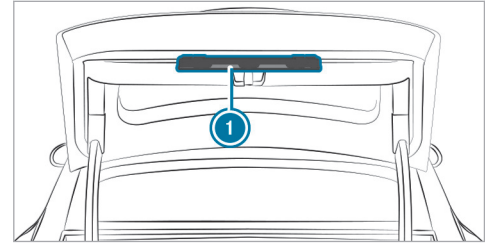

▶ Remove the warning triangle ①.

First-aid bag

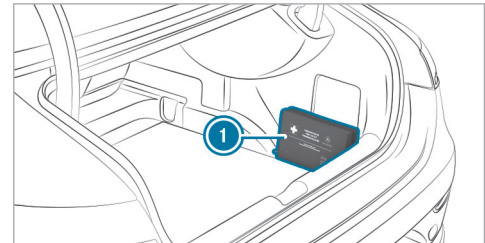

The first-aid bag  is located on the right-hand side of the boot in the as-delivered condition.

QR code for rescue card

QR codes are attached in the socket flap and on the opposite side on the B-pillar. In the event of an accident, rescue services can use the QR code to quickly find the appropriate rescue card for your vehicle. The current rescue card contains the most important information about your vehicle (e.g. the routing of the electric lines) in compact form.

Further information can be obtained at <https://www.mercedes-benz.de/qr-code>

Starting assistance and charging the 12 V battery

- ▶ Only have starting assistance provided by a qualified specialist workshop, e.g. a Mercedes-Benz Service Centre.
- ▶ Only have the battery charged at a qualified specialist workshop, e.g. a Mercedes-Benz Service Centre.

Notes on electrical fuses

 **WARNING** Risk of accident and injury due to overloaded lines

If you manipulate or bridge a faulty fuse or if you replace it with a fuse with a higher amperage, the electric line could be overloaded.

This could result in a fire.

- ▶ Always replace faulty fuses with specified new fuses containing the correct amperage.

 **NOTE** Damage due to incorrect fuses

Using incorrect fuses can result in damage to electrical components or systems or their functions being considerably restricted.

- ▶ Use only fuses approved for Mercedes-Benz with the respective specified fuse rating.

Blown fuses must be replaced with fuses of the same rating, which you can recognise by the colour and the label. The fuse ratings and further

information to be observed can be found in the fuse assignment diagram.

Fuse assignment diagram: on the fuse box in the rear passenger compartment (→ page 626).

 **NOTE** Damage or malfunctions caused by moisture

Moisture may cause damage to the electrical system or cause it to malfunction.

- ▶ When the fuse box is open, make sure that no moisture can enter the fuse box.
- ▶ When closing the fuse box, make sure that the seal of the lid is positioned correctly on the fuse box.

If the newly inserted fuse also blows, have the cause traced and rectified at a qualified specialist workshop.

Ensure the following before replacing a fuse:

- The vehicle is secured against rolling away.
- All electrical consumers are switched off.
- The vehicle is switched off.

The electrical fuses are located in various fuse boxes:

- Fuse box on the driver's side of the cockpit (→ page 625)
- Fuse box in the front passenger footwell (→ page 625)
- Fuse box in the rear passenger compartment (→ page 626)

Notes on flat tyres

⚠ WARNING Risk of accident due to a flat tyre

A flat tyre severely affects the driving characteristics as well as the steering and braking of the vehicle.

Tyres without run-flat characteristics:

- ▶ Do not drive with a flat tyre.
- ▶ Change the flat tyre immediately with an emergency spare wheel or spare wheel. Alternatively, consult a qualified specialist workshop.

Tyres with run-flat characteristics:

- ▶ Observe the information and warning notes on MOExtended tyres (run-flat tyres).

In the event of a flat tyre, the following options are available depending on your vehicle's equipment:

- **Vehicles with MOExtended tyres:** it is possible to continue the journey for a short period of time. Make sure you observe the notes on MOExtended tyres (run-flat tyres) (→ page 610).
 - **Vehicles with a TIREFIT kit:** you can seal the tyre so that it is possible to continue the journey for a short period of time. To do this, use the TIREFIT kit (→ page 612).
 - **Vehicles with Mercedes me connect:** you can make a call for breakdown assistance via the overhead control panel in the case of a breakdown (→ page 544).
 - **All vehicles:** change the wheel (→ page 636).
- i** (→ page 642) The emergency spare wheel is only available in certain countries.

Overview of the tyre-change tool kit

Apart from some country-specific variants, vehicles are not equipped with a tyre-change tool kit. Consult a qualified specialist workshop to find out which wheel change tool is necessary and approved for a wheel change on your vehicle.

You require the following tools, for example, to change a wheel:

- Jack
 - Chock
 - Wheel wrench
 - Centring pin
- i** The jack weighs approximately 3.4 kg. The maximum load capacity of the jack can be found on the sticker affixed to the jack. The jack is maintenance-free. If there is a malfunction, please contact a qualified specialist workshop.
- The tyre-change tool kit is located in tool bag **1** in the boot.
- i** When stowing the tool bag, make sure that it is adequately secured.

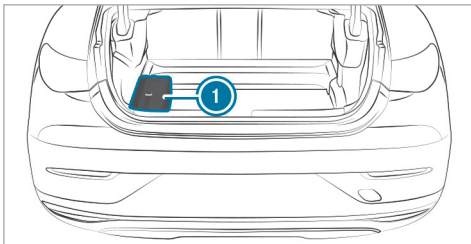

The tool bag contains:

- Jack
- Gloves
- Wheel wrench
- Centring pin
- Folding chock
- Ratchet for jack

TIREFIT kit storage location

The TIREFIT kit is located under the boot floor.

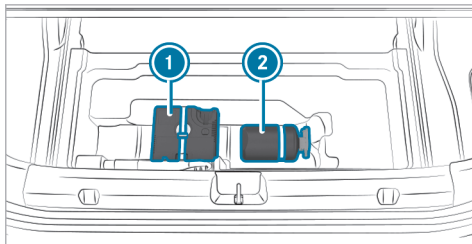

- ① Tyre inflation compressor
- ② Tyre sealant bottle

Depending on the model, the TIREFIT kit may also be located in other places under the boot floor.

- ⓘ You can find information on the power category (LK) and/or electrical data on the back of the tyre inflation compressor:
 - LK3 - 12 V/20 A, 240 W, 1 kg

At a distance of approximately 1 m to the tyre inflation compressor and approximately 1.6 m above the ground, the following sound pressure levels apply:

- Emission sound pressure level L_{PA} 84 dB(A)
- Sound power level L_{WA} 92 dB(A)

The tyre inflation compressor is maintenance-free. If there is a malfunction, please contact a qualified specialist workshop.

Towing the vehicle with both axles on the ground



- ▶ Observe the notes on the permitted towing methods (→ page 618).
- ▶ Make sure that the 12V battery is connected and charged

Observe the following points when the 12V battery is disconnected or discharged

- the drive system cannot be started
- the electric parking brake cannot be released or applied

- The selector lever cannot be put into position **N** or **P**.

Only one transport is permitted when at least one of the following conditions occur:

- If the selector lever cannot be put into position **N**.
 - if the 12V battery is disconnected or discharged.
 - if the display in the instrument cluster is not working
 - if the  **Towing not permitted See Owner's Manual** message is displayed
 - if the  **Top up coolant See Owner's Manual** message is displayed
 - if the  **Stop Switch off the vehicle** message is displayed
- ▶ In such cases, transport the vehicle (→ page 621).

! **NOTE** Damage due to towing away at excessively high speeds or over long distances

The drivetrain could be damaged when towing at excessively high speeds or over long distances.

- ▶ A towing speed of 50 km/h must not be exceeded.
- ▶ A towing distance of 50 km must not be exceeded.

! **WARNING** Risk of accident when towing a vehicle which is too heavy

If the vehicle to be tow-started or towed away is heavier than the permissible gross mass of your vehicle, the following situations can occur:

- the towing eye may become detached.
 - the vehicle/trailer combination may swerve or overturn.
- ▶ Before tow-starting or towing away, check if the vehicle to be tow-started or

towed away exceeds the permissible gross mass.

If a vehicle has to be tow-started or towed away, its permissible gross mass must not exceed the permissible gross mass of the towing vehicle.

- ▶ Information on the permissible gross mass of the vehicle can be found on the vehicle identification plate (→ page 757).

Towing away the vehicle

- ▶ Fit the towing eye (→ page 623).
- ▶ Fasten the towing device.

! **NOTE** Damage due to incorrect connection of the tow bar

- ▶ Only connect the tow rope or tow bar to the towing eyes.

- ▶ Deactivate the automatic locking mechanism (→ page 147).
- ▶ Do not activate the HOLD function.

- ▶ Deactivate tow-away protection (→ page 169).
- ▶ Deactivate Active Brake Assist (→ page 341).
- ▶ Put the selector lever into position **N**.
- ▶ Release the electric parking brake.
- ▶ Remain in the cockpit during towing and observe the display messages.
- ▶ Do not switch off the vehicle while it is being towed. Do not operate the start/stop key after moving the shift lever to position **N**.
- ▶ Do not open the driver's door or front passenger door, because otherwise the selector lever automatically switches to position **P**.

⚠ WARNING Risk of accident due to restricted safety-relevant functions during towing

Safety-relevant functions are restricted or no longer available in the following situations:

- The vehicle is switched off.

- The start-stop button was pressed after the selector lever was moved to the **N** position.
 - The brake system or the power steering is faulty.
 - The power supply or the on-board electrical system is faulty.
- ▶ Do not tow the vehicle in these situations.

▶ Transport the vehicle (→ page 621).

⚠ NOTE Damage to the drive system due to incorrect towing

The vehicle must not be towed in the following situations:

- The vehicle is switched off.
- The start-stop button was pressed after the selector lever was moved to the **N** position.

- The brake system or the power steering is faulty.
 - The power supply or the on-board electrical system is faulty.
- ▶ Do not tow the vehicle in these situations.

⚠ NOTE Damage due to excessive tractive power

If you pull away sharply, the tractive power may be too high and the vehicles could be damaged.

▶ Pull away slowly and smoothly.

Expert tips

Additional functions of buttons

■ **Opening and closing the windows using the air-recirculation button (convenience closing/opening)**

When the air-recirculation mode is activated, the side windows can be closed automatically, e.g.

before entering a tunnel. When the air-recirculation mode is deactivated, the side windows can be moved back to their original position.

⚠ WARNING Risk of entrapment due to not paying attention during convenience closing

When the convenience closing feature is operating, parts of the body could become trapped in the closing area of the side window and the sliding sunroof.

- ▶ When the convenience closing feature is operating, monitor the entire closing process and make sure that no body parts are in the closing area.

⚠ WARNING Risk of entrapment due to not paying attention during convenience closing

When the convenience closing feature is operating, parts of the body could become trapped in the closing area of the side windows.



- ▶ When the convenience closing feature is operating, monitor the entire closing

process and make sure that no body parts are in the closing area.

- ▶ **To close windows:** press and hold the button  in the climate bar in the central display or the air conditioning control panel until the windows move. The windows close and air-recirculation mode switches on.

⚠ WARNING Risk of entrapment from the convenience opening feature



During convenience opening parts of the body could be drawn in or become trapped between the side window and window frame.

- ▶ When opening, make sure that nobody is touching the side windows.
- ▶ If someone becomes trapped, immediately press the  button in the door to open the side windows. The side windows stop.
- ▶ To continue closing the side windows, pull on the  button.

- ▶ **To reopen closed windows:** press and hold  the button in the climate bar in the central display or the air conditioning control panel until the windows move. The windows move back to their original position and air-recirculation mode switches off.

Vehicles with a sliding sunroof: the sliding sunroof closes or opens simultaneously.

If body parts become entrapped in the sliding sunroof:

- ▶ **To stop:** press the  button.
- ▶ **To open:** pull the button  back.

Opening and closing the windows using the air-recirculation button (convenience closing/opening)

When the air-recirculation mode is activated, the side windows can be closed automatically, e.g. before entering a tunnel. When the air-recirculation mode is deactivated, the side windows can be moved back to their original position.

- ⚠ WARNING** Risk of entrapment due to not paying attention during convenience closing



When the convenience closing feature is operating, parts of the body could become trapped in the closing area of the side window and the sliding sunroof.

- ▶ When the convenience closing feature is operating, monitor the entire closing process and make sure that no body parts are in the closing area.

- ▶ **To close windows:** press and hold  in the climate bar in the central display until the windows move. The windows close and air-recirculation mode switches on.

- ⚠ WARNING** Risk of entrapment from the convenience opening feature



During convenience opening parts of the body could be drawn in or become trapped between the side window and window frame.

- ▶ When opening, make sure that nobody is touching the side windows.
- ▶ If someone becomes trapped, immediately press the  button in the door to open the side windows. The side windows stop.
- ▶ To continue closing the side windows, pull on the  button.

- ▶ **To reopen closed windows:** press and hold  in the climate bar in the central display until the windows move. The windows move back to their original position and air-recirculation mode switches off.

Vehicles with a sliding sunroof: the sliding sunroof closes or opens simultaneously.

If body parts become entrapped in the sliding sunroof:

- ▶ **To stop:** press the  button.
- ▶ **To open:** pull the button  back.

Resetting the climate control settings

- ▶ Press and hold the **Climate menu** entry on the climate bar of the multimedia system for four seconds. The climate control settings will be reset to the basic settings.

Activating/deactivating traffic announcements

Multimedia system:

  Radio

- ▶ Select **TA**. The traffic information is switched on or off.

Useful vehicle functions

Storing the parking position of the front-passenger outside mirror using the memory button

Requirements

- Reverse gear has not been engaged.

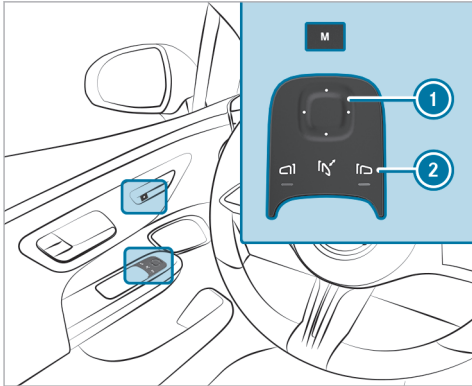

- ▶ Use button ② to select the front-passenger outside mirror.
- ▶ Move the front-passenger outside mirror into the desired parking position using button ①.
- ▶ Press the **M** button.
- ▶ Confirm immediately using button ① to store the setting.

- ❗ No more than three seconds may pass between the **M** button and button ① being pressed. The mirror adjustment will be cancelled after three seconds.



Good to know

Deactivating the key function

If you deactivate the key function, the KEYLESS-GO functions are also deactivated. With that key, access or drive authorization by KEYLESS-GO is no longer possible. Activate the function of the key so that all its functions will again be available. You can also deactivate the key's function to reduce the key's energy consumption if you do not use the vehicle or a key for an extended period of time.

If you do not use the vehicle or a key for an extended period, you can also deactivate the key's function to reduce the key's energy consumption.

- ▶ Press and hold the key button .

- ▶ With the key button  pressed, immediately press the key button  twice in quick succession. The indicator light of the key lights up once briefly and once for a long time.

- ❗ You have the following options to reactivate the key:
 - Press any key on the key.
 - Start the vehicle with the key in the centre console storage compartment. (→ page 256).

Overview of emergency call systems

Both the Mercedes-Benz emergency call system as well as the 112 emergency call system (EU eCall) can help to reduce the time between an accident and the arrival of emergency services at the site of the accident. They help locate an accident site in places that are difficult to access.

Both emergency call systems can initiate an emergency call automatically (→ page 556) or manually (→ page 556).

Only make emergency calls if you or others are in need of rescue. Do not make an emergency call in the event of a breakdown or a similar situation.

Indicators in the displays

The following messages appear on the central display or the media display of both emergency call systems:

- **SOS NOT READY:** the vehicle is not switched on or the emergency call system is malfunctioning. This does not necessarily indicate complete failure of the emergency call system. Emergency calls can still be transmitted.

The display only refers to the vehicle and does not take account of the availability of mobile phone networks and the Mercedes-Benz emergency call centre.

The functional readiness of the emergency call system on the vehicle can be seen when the **SOS NOT READY** display disappears once the vehicle is switched on.

- : the icon appears in the display during an active emergency call.

- ❗ If there is a malfunction of the emergency call system, the loudspeakers, microphone, airbag or the SOS button, for example, are faulty.

You can recognise a fault in the emergency call system by the following displays:

- A corresponding message will also appear in the driver's display.
- The SOS button lights up red continuously.

Emergency guide

In the event of an accident or breakdown, the emergency guide shows safety notes on the central display.

These include, for example:

- Recommended actions when leaving the vehicle
- Procedure for safely removing seat belts in the event of an accident whereby the vehicle comes to rest on its roof









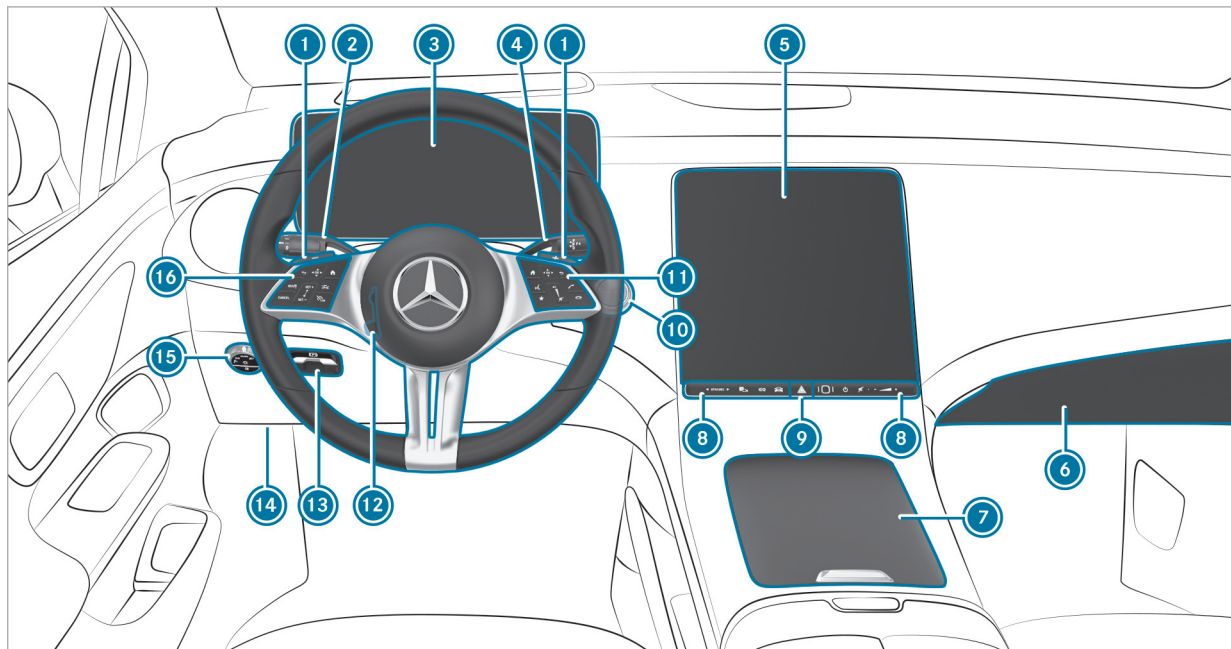



The emergency guide is activated in the following situations:

- Occupant protection system has been triggered

- An emergency call is made
- Certain breakdown situations







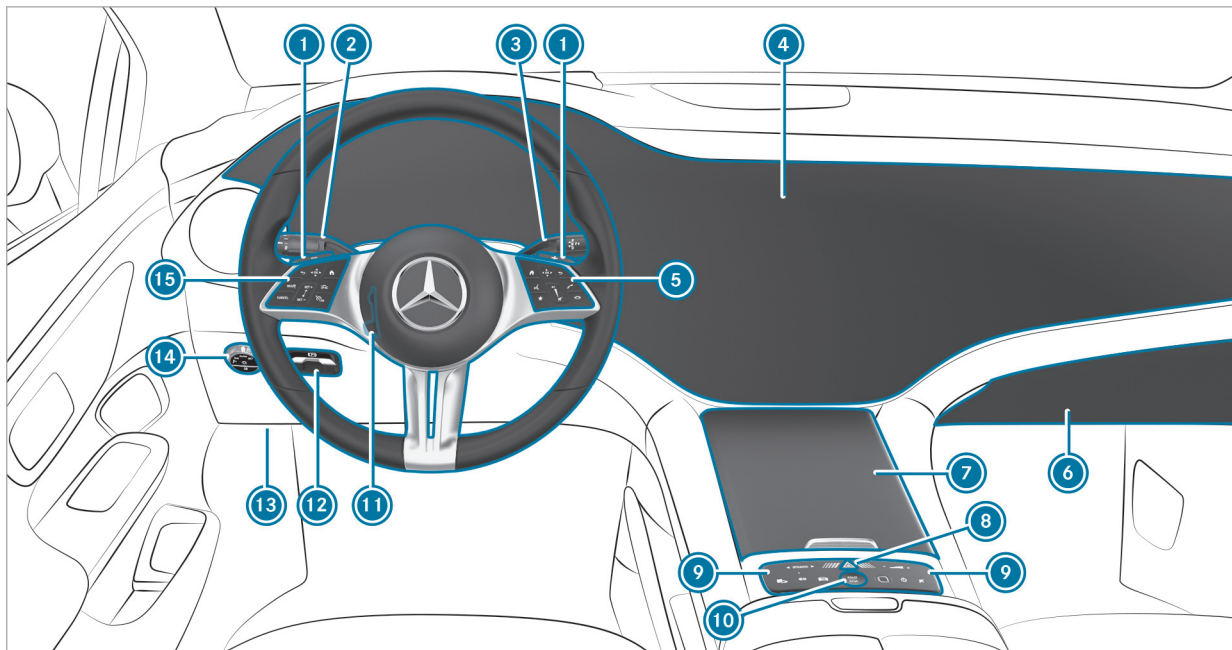





- ❗ The availability as well as the scope of the emergency guide can vary depending in the country and vehicle equipment.



①	 Increases recuperation	→	261		 Switches sound on/off	→	451
	 Reduces recuperation	→	261		 Adjusts the volume	→	453
②	Combination switch	→	214	⑨	 Hazard warning light system	→	45
③	Driver's display	→	403	⑩	Start/stop button	→	253
④	DIRECT SELECT lever	→	272	⑪	Control panel for the MBUX multimedia system	→	437
⑤	Central display	→	428	⑫	Adjusts the steering wheel	→	184
⑥	Glove compartment	→	38	⑬	 Electric parking brake	→	299
⑦	Stowage compartment	→	38	⑭	Diagnostics connection	→	84
⑧	Switch panel for:			⑮	Light switch	→	212
	 DYNAMIC SELECT button	→	268	⑯	Control panel:		
	 Active Parking Assist	→	377		Driver's display	→	403
	 Calls up the EQ menu	→	296		 Active Distance Assist DISTRONIC and variable limiter	→	324
	 Quick vehicle access						
	 Fingerprint sensor	→	439				
	 Switches the MBUX multimedia system on/off	→	428				







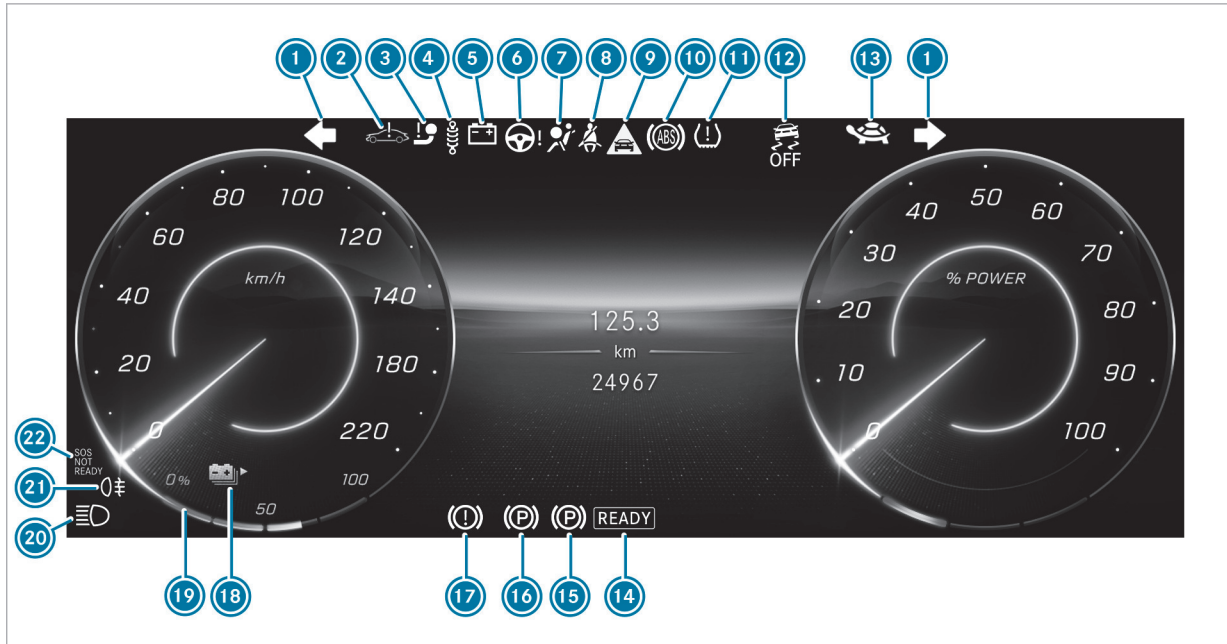























Left-hand-drive vehicles (with MBUX hyperscreen)

①	 Increases recuperation	→	261	 Quick vehicle access		
	 Reduces recuperation	→	261	 Fingerprint sensor	→	439
②	Combination switch	→	214	 Switches the MBUX multimedia system on/off	→	428
③	DIRECT SELECT lever	→	272	 Switches sound on/off	→	451
④	MBUX hyperscreen with:			 Adjusts the volume	→	453
	Driver's display	→	402	⑩ Start/stop button	→	253
	Central display	→	428	⑪ Adjusts the steering wheel	→	184
	Front passenger display	→	428	⑫  Electric parking brake	→	299
⑤	Control panel for the MBUX multimedia system	→	437	⑬ Diagnostics connection	→	84
⑥	Glove compartment	→	38	⑭ Light switch	→	212
⑦	Stowage compartment	→	38	⑮ Control panel:		
⑧	 Hazard warning light system	→	45	Driver's display	→	403
⑨	Switch panel for:			 Active Distance Assist DISTRONIC and variable limiter	→	324
	 DYNAMIC SELECT button	→	268			
	 Active Parking Assist	→	377			
	 Calls up the EQ menu	→	296			







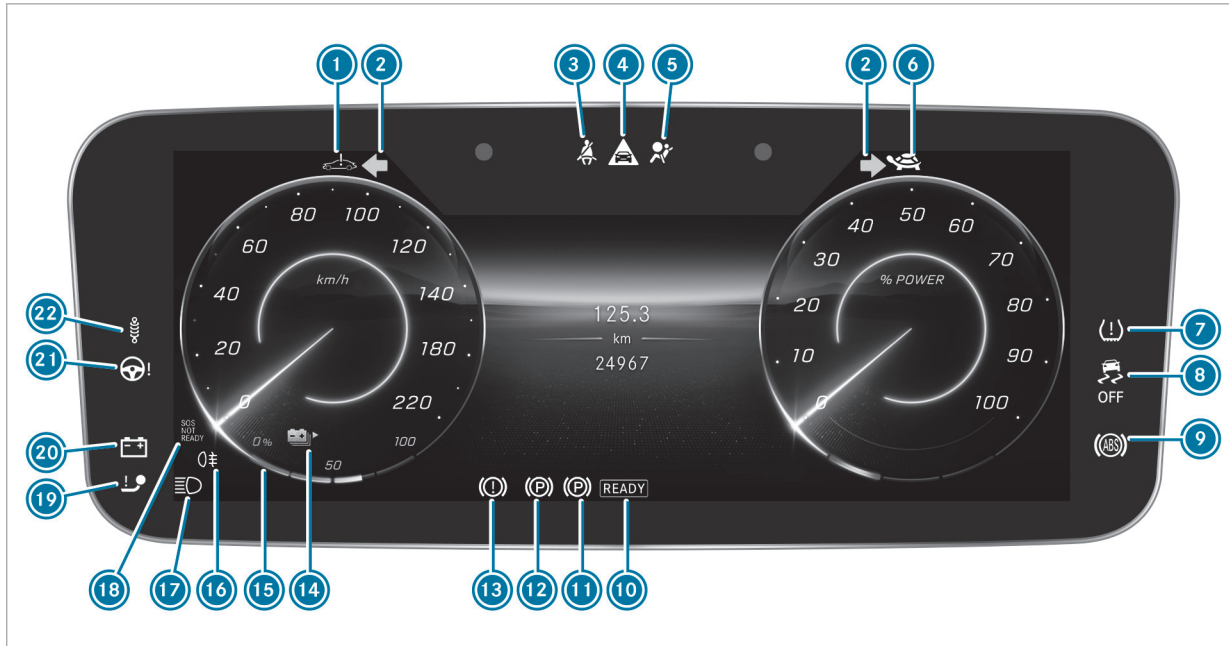

























Standard driver's display







1		Turn signal lights	→	214	12		ESP® OFF	→	867
2		System error	→	861			ESP®	→	867
3		Trailer hitch	→	862	13		Reduced power	→	861
4		Suspension (red)	→	867	14		Operational readiness of drive system	→	253
		Suspension (yellow)	→	867	15		Electric parking brake (yellow)	→	865
5		Electrical fault	→	861	16		Electric parking brake (red)	→	865
6		Power steering (red)	→	862	17		Brakes (red)	→	865
		Power steering (yellow)	→	862			Brakes (yellow)	→	865
		Rear axle steering (red)	→	862	18		Range	→	407
		Rear axle steering (yellow)	→	862	19		Charge level display	→	407
7		Restraint system	→	860	20		High beam	→	214
8		Seat belt	→	860			Low beam	→	212
9		Distance warning	→	867			Standing lights	→	212
10		ABS	→	867	21		Rear fog light	→	213
11		Tyre pressure monitoring system	→	874	22		Mercedes-Benz emergency call system	→	874

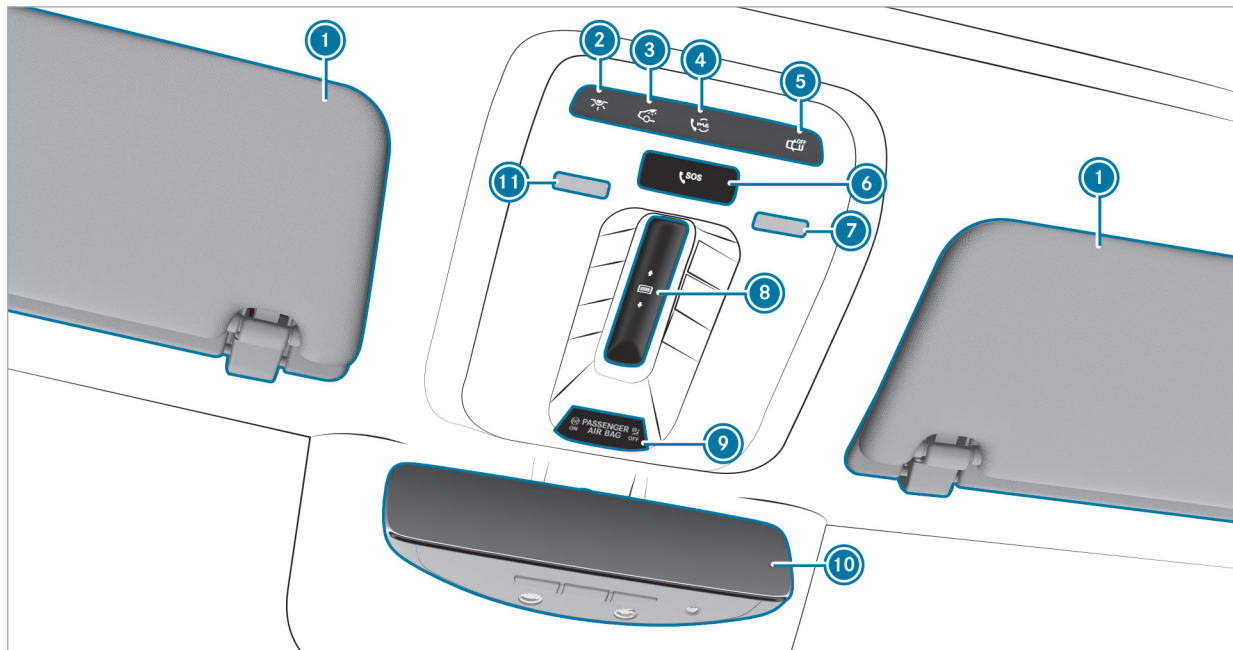









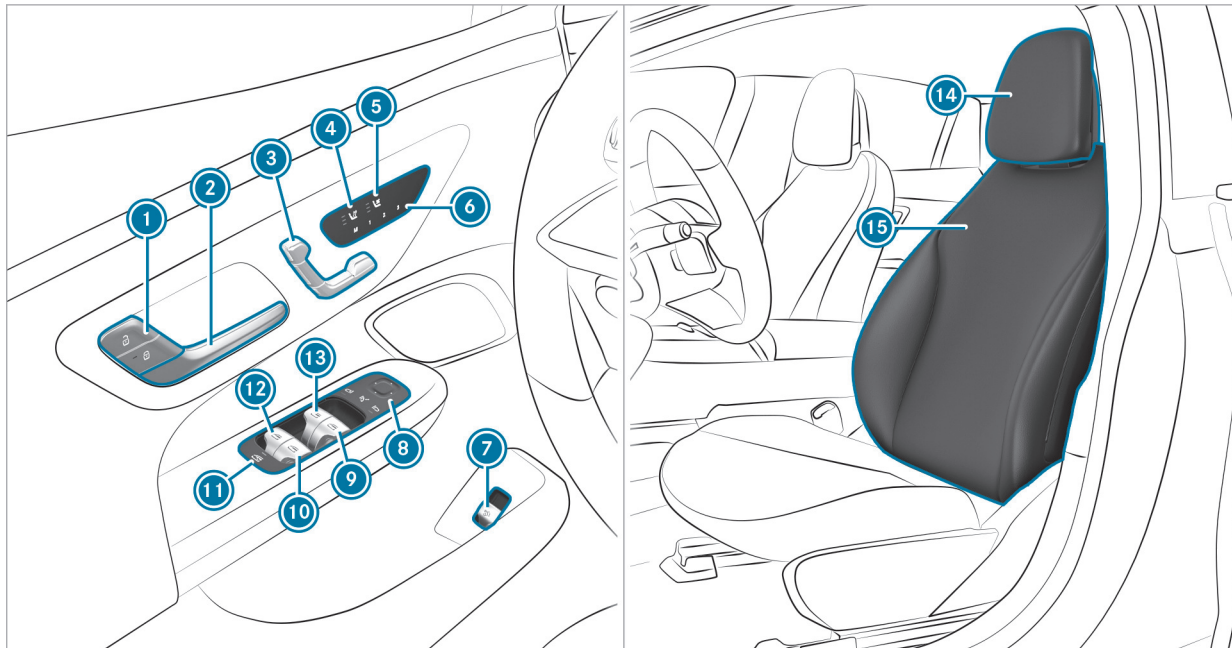



Driver's display with driver camera

1		System error	→	861	14		Range	→	407
2	 	Turn signal lights	→	214	15		Charge level display	→	407
3		Seat belt	→	860	16		Rear fog light	→	213
4		Distance warning	→	867	17		High beam	→	214
5		Restraint system	→	860			Low beam	→	212
6		Reduced power	→	861			Standing lights	→	212
7		Tyre pressure monitoring system	→	874	18		Mercedes-Benz emergency call system	→	874
8		ESP [®] OFF	→	867	19		Trailer hitch	→	862
		ESP [®]	→	867	20		Electrical fault	→	861
9		ABS	→	867	21		Power steering (red)	→	862
10		Operational readiness of drive system	→	253			Power steering (yellow)	→	862
11		Electric parking brake (yellow)	→	865			Rear axle steering (red)	→	862
12		Electric parking brake (red)	→	865			Rear axle steering (yellow)	→	862
13		Brakes (red)	→	865	22		Suspension (red)	→	867
		Brakes (yellow)	→	865			Suspension (yellow)	→	867





1	Sun visors		
2	 Switches the front interior lighting on/off	→	224
3	 Switches the rear interior lighting on/off	→	224
4	 me button	→	544
5	 Switches automatic interior lighting control on/off	→	224
6	 SOS button	→	544
7	Switches the right-hand reading lamp on/off	→	224
8	 Opens/closes the panorama sliding sun-roof	→	164
	 Opens/closes the panorama sliding sun-roof roller sunblind	→	164
9	PASSENGER AIR BAG indicator lamps	→	96
10	Inside rear-view mirror	→	230
11	Switches the left-hand reading lamp on/off	→	224

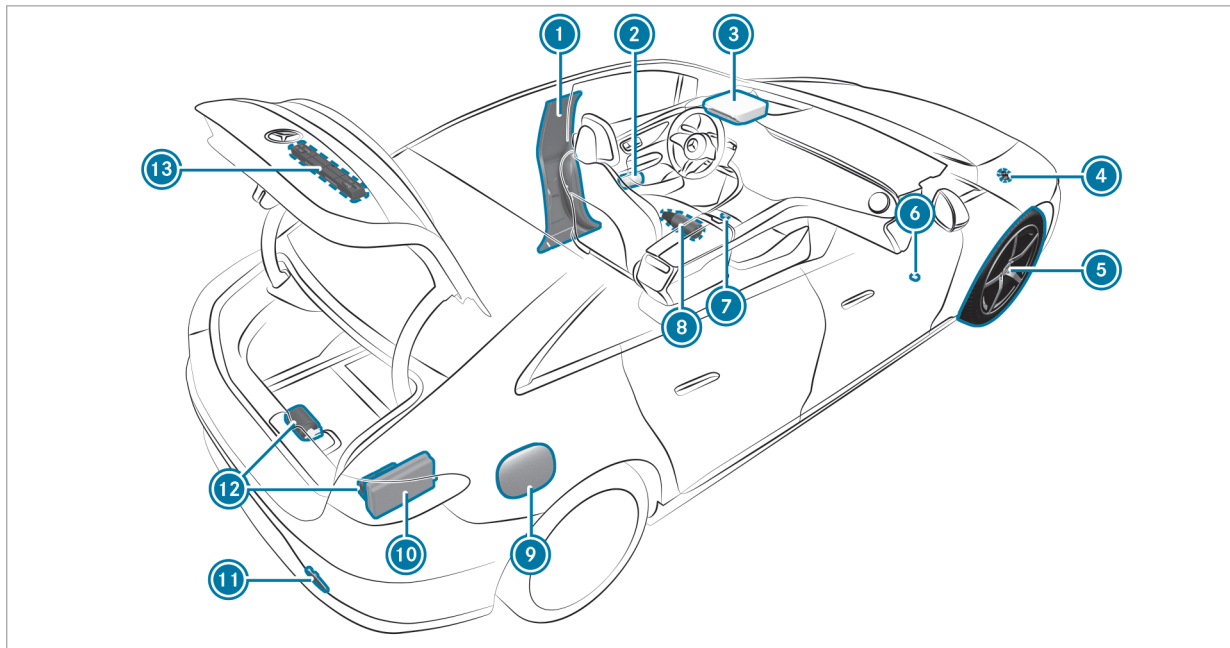

①	 	Locks/unlocks the vehicle	→	144	⑨		Opens/closes the right side window	→	160
②		Opens the door	→	144	⑩		Opens/closes the rear right side window	→	160
③		Adjusts the seats electrically	→	174	⑪		Child safety lock for the rear side windows	→	132
④		Switches the seat heating on/off	→	182	⑫		Opens/closes the rear left side window	→	160
⑤		Switches the seat ventilation on/off	→	183	⑬		Opens/closes the left side window	→	160
⑥	M	Operates the memory function	→	189	⑭		Adjusts the head restraints	→	177
⑦		Opens/closes the boot lid	→	155	⑮		Seat adjustment using the multimedia system	→	180
⑧		Operates the outside mirrors	→	229					



① B-pillar with:			
QR code for accessing the rescue card	→	48	
information label on tyre pressure	→	629	
② Safety vests	→	28	
③  me button	→	544	
 SOS button	→	544	
④ Towing away	→	618	
⑤ Flat tyre	→	49	
⑥ Operating the high-voltage disconnect device	→	250	
⑦  Hazard warning light system	→	45	
⑧ Fire extinguisher	→	46	
⑨ Socket flap with:			
QR code for accessing the rescue card	→	48	
⑩ First-aid kit (soft sided)	→	29	
⑪ Towing away	→	618	
⑫ TIREFIT kit	→	612	
⑬ Warning triangle	→	29	

Calling up the Digital Owner's Manual

Multimedia system:

- ➔  ➔ Settings ➔ Info
- ➔ Owner's Manual
- ➔ Open Digital Owner's Manual

The Digital Owner's Manual describes the functions and operation of the vehicle and the multimedia system.

▶ Select one of the following menu items in the Digital Owner's Manual:

- **Quick start:** find the first steps towards adjusting your seat (driver's side).
- **Tips:** find information that prepares you for certain everyday situations with your vehicle.
- **Animations:** watch animations of the vehicle functions.
- **Messages:** receive additional information about the messages in the driver's display.
- **Language:** select the language for the Digital Owner's Manual.

You can search for keywords using the search field **Search**, in order to find quick answers to questions about the operation of the vehicle.

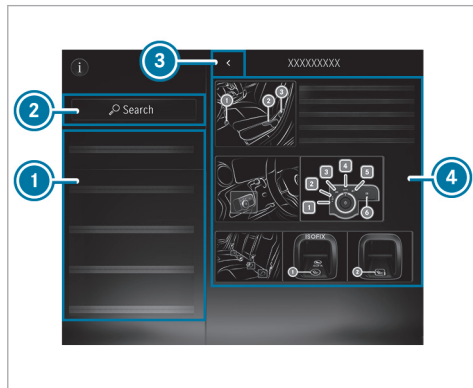

- ① Menu
- ② Search
- ③ Back
- ④ Contents section

Some sections in the Digital Owner's Manual, such as warning notes, can be expanded and collapsed.

Additional methods of calling up the Digital Owner's Manual:

Driver's display: call up brief information as display messages in the driver's display

MBUX Voice Assistant: call up via the voice control system

Global search: call up search results for contents of the Digital Owner's Manual in the home screen

For safety reasons, the Digital Owner's Manual is deactivated while driving.

Protection of the environment

 **ENVIRONMENTAL NOTE** Environmental damage due to operating conditions and personal driving style

Operate your vehicle in an environmentally responsible manner to help protect the environment. Please observe the following recommendations on operating conditions and personal driving style.

Operating conditions:

- ▶ Make sure that the tyre pressure is correct.
- ▶ Do not carry any unnecessary weight (e.g. roof luggage racks once you no longer need them).
- ▶ Monitor energy consumption.
- ▶ Adhere to the service intervals. A regularly serviced vehicle will contribute to environmental protection.
- ▶ Always have maintenance work carried out at a qualified specialist workshop.

Personal driving style:

- ▶ Drive carefully and maintain a suitable distance from the vehicle in front.
- ▶ Avoid frequent, sudden acceleration and braking.
- ▶ Drive in a way that conserves energy. Observe the ECO display for an economical driving style.

 **ENVIRONMENTAL NOTE** Environmental pollution caused by irresponsible disposal of the high-voltage battery

A high-voltage battery contains materials which are harmful to the environment.

- ▶ Dispose of faulty high-voltage batteries at a qualified specialist workshop.

Take-back of end-of-life vehicles

EU countries only:

Mercedes-Benz will take back your end-of-life vehicle for environment-friendly disposal in

accordance with the European Union (EU) End-Of-Life Vehicles Directive.

A network of vehicle take-back points and dismantlers has been established for you to return your vehicle. You can leave it at any of these points free of charge. This makes an important contribution to closing the recycling circle and conserving resources.

For further information about the recycling and disposal of end-of-life vehicles, and the take-back conditions, please visit the national Mercedes-Benz website for your country.

Mercedes-Benz GenuineParts

 **ENVIRONMENTAL NOTE** Environmental damage caused by not using recycled/reconditioned components

Mercedes-Benz AG offers recycled/reconditioned components and parts with the same quality as new parts. The same entitlement from the implied warranty is valid as for new parts.

- ▶ Recycled reconditioned components and parts from Mercedes-Benz AG.

! **NOTE** Impairment of the operating efficiency of the restraint systems from installing accessory parts or from repairs or welding

Airbags and seat belt tensioners, as well as control units and sensors for the restraint systems, may be installed in the following areas of your vehicle:

- doors
- door pillars
- Sill
- Seats
- Cockpit
- Driver's display
- Centre console
- lateral roof frame

- ▶ Do not install accessory parts such as audio systems in these areas.

- ▶ Do not carry out repairs or welding.
- ▶ Have accessories retrofitted at a qualified specialist workshop.

You could jeopardise the operating safety of your vehicle if you use parts, tyres and wheels as well as accessories relevant to safety that have not been approved by Mercedes-Benz. Safety-critical systems (e.g. the brake system) may malfunction. Use only Mercedes-Benz GenuineParts or parts of equal quality. Use only tyres, wheels and accessory parts that have been specifically approved for your vehicle model.

Mercedes-Benz tests original parts and conversion parts and accessory parts that have been specifically approved for your vehicle model for their reliability, safety and suitability. Despite ongoing market research, Mercedes-Benz is unable to assess other parts. Mercedes-Benz therefore accepts no responsibility for the use of such parts in Mercedes-Benz vehicles, even if they have been officially approved or independently approved by a testing centre.

Certain parts are officially approved for installation or modification only if they comply with legal requirements. All Mercedes-Benz GenuineParts meet the approval requirements. The use of non-approved parts may invalidate the vehicle's general operating permit.

This is the case in the following situations:

- The vehicle type is different from that for which the vehicle's general operating permit was granted.
- Other road users could be endangered.
- The noise level gets worse.

Always specify the vehicle identification number (VIN) (→ page 757) when ordering Mercedes-Benz GenuineParts.

Touch-sensitive controls

In addition to conventional switches and buttons, your vehicle is equipped with touch-sensitive controls.

These are located in the following areas of your vehicle:

- Roof and door control panel
- Climate control
- Steering wheel
- MBUX multimedia system

The controls have touch-sensitive user interface surfaces. For example, the surfaces are controlled by pressing or swiping to adjust settings or trigger functions, for example.

In the touchscreen area, you also receive haptic feedback in the form of a pulse or a vibration, or the surface structure changes on the touch-sensitive user interface surface, for example.

You receive haptic feedback in the following situations, for example:

- When pressing a button on the user interface surface
- When scrolling in a list or table
- When reaching a new area on the user interface surface, e.g. a pop-up window

When handling touch-sensitive user interface surfaces, observe the following points to avoid problems operating:

- Do not affix stickers or similar objects on the surfaces
- Do not attach a smartphone- or other holder to the surface of the central display.
- Keep the surfaces protected from moisture and wet conditions.
- Keep the surfaces free of dust and dirt (→ page 605).

Some touch-sensitive control elements have a symbol and integrated indicator lamps. When operating, make sure to press on the symbol of the control element.

Mercedes me App

Notes about the on-demand feature

You can also activate various functions (on-demand feature) subsequently via Mercedes me after purchasing your vehicle.

Information is available at any Mercedes-Benz Service Centre.

Activating on-demand feature using Mercedes me

Requirements:

- The vehicle has a wireless connection.
- The vehicle is linked to the Mercedes me user account.

Ordering and activating on-demand feature

- ▶ Add the desired on-demand feature for the vehicle to the shopping basket in the Mercedes me Store.
- ▶ Complete the order.
The on-demand feature is activated when operating the vehicle.

Speeding up activation

- ▶ Switch the vehicle off and lock it.
- ▶ Unlock the vehicle after about two minutes and switch on the vehicle.
The on-demand feature has been activated. For some features, a notification also appears in the vehicle's multimedia system.

If the activation was not successful, repeat the process.

Operating safety

⚠ WARNING Risk of accident due to malfunctions or system failures

If you do not have the prescribed service/maintenance work or any required repairs carried out, this could result in malfunctions or system failures.

- ▶ Always have the prescribed service- and maintenance work or any required repairs carried out in a qualified workshop.

⚠ WARNING Risk of accident or injury due to improper modifications to electronic components

Modifications to electronic components, their software or wiring can impair their functionality and/or the functionality of other networked components or safety-relevant systems.

This can endanger the vehicle's operating safety.

- ▶ You must not tamper with wiring, electronic components, or their software.
- ▶ Always have work on electrical and electronic devices carried out at a qualified specialist workshop.

If you modify the on-board electronics, the general operating permit is rendered invalid.

Observe the "On-board electronics" section in "Technical data".

! NOTE Impairment of the operating efficiency of the vehicle or individual components due to tampering with the on-board electronics

The vehicle is equipped by the manufacturer with various safety mechanisms that interact with each other.

If the system detects tampering with the on-board electronics due to an unauthorised modification of control units and/or their software/data, this may have the following effects:

- Individual vehicle functions are (temporarily) no longer operational.
- The overall vehicle is (temporarily) no longer operational.

- ▶ Have the vehicle checked immediately at a qualified specialist workshop and, if necessary, reset to factory settings.

! NOTE Damage to the vehicle due to driving too fast and due to impacts to the vehicle underbody and suspension components

In the following situations, in particular, there is a risk of damage to the vehicle:

- the vehicle becomes grounded, e.g. on a high kerb or an unpaved road

- the vehicle is driven too fast over an obstacle, e.g. a kerb, speed bump or pothole
- a heavy object strikes the underbody or suspension components

In situations such as these, damage to the body, underbody, suspension components, wheels or tyres and high-voltage battery components may not be visible. Components damaged in this way can unexpectedly fail or, in the case of an accident, may no longer absorb the resulting force as intended.

- ▶ Have the vehicle checked and repaired immediately at a qualified specialist workshop.

or

- ▶ If driving safety is impaired while continuing your journey, pull over and stop the vehicle immediately, while paying attention to road and traffic conditions, and contact a qualified specialist workshop.

Electric vehicles have an electric motor. The electric motor's energy supply is provided by the high-voltage on-board electrical system.

⚠ DANGER Risk of death and fire due to modified and/or damaged components of the high-voltage on-board electrical system

The vehicle's high-voltage on-board electrical system is under high voltage. If you modify component parts in the vehicle's high-voltage on-board electrical system or touch damaged component parts, you may be electrocuted. In addition, modified and/or damaged components may cause a fire.

In the event of an accident or impact to the vehicle underbody, components of the high-voltage electrical system may be damaged although the damage is not visible.

- ▶ Never make any modifications to the high-voltage on-board electrical system.
- ▶ Do not switch on or use the vehicle if its high-voltage on-board electrical system

components have been modified or damaged.

- ▶ Never touch damaged components of the high-voltage on-board electrical system.
- ▶ After an accident, do not touch any components of the high-voltage on-board electrical system.
- ▶ After an accident, have the vehicle transported away.
- ▶ Have the components of the high-voltage on-board electrical system checked at a qualified specialist workshop and replaced if necessary.

The components of the vehicle's high-voltage on-board electrical system are marked with yellow warning stickers. The cables of the high-voltage on-board electrical system are orange.

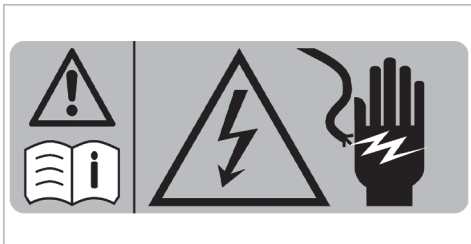

High-voltage components that can become very hot are marked with an additional warning sticker:



Example

Vehicles with an electric motor generate significantly less driving noise than vehicles with internal-combustion engines.

Therefore the vehicle may not be heard by other road users due to the significantly reduced sound produced.

For this reason the vehicle is equipped with a sound generator, which serves as an acoustic vehicle alerting system (AVAS). This protective equipment is prescribed by law.

The outside sound produced by the sound generator (AVAS) can be heard in the passenger compartment at low speeds and does not represent a malfunction.

Notes on assembling the number plate on the front licence plate holder

! **NOTE** Malfunctions and system failures due to incorrect assembly of the licence plate on the front licence plate holder

If the licence plate is incorrectly assembled on the front licence plate holder, sensors, cam-

eras or driving and safety systems may malfunction or fail.

Observe the following points when assembling the licence plate on the front licence plate holder:

- ▶ Assemble the licence plate directly on the licence plate holder without advertising media or other holders.
- ▶ Assemble the licence plate so that it does not protrude above or to the side of the licence plate adapter.

Declarations of conformity and notes on driving in different countries

Electromagnetic compatibility

The electromagnetic compatibility of the vehicle components has been checked and certified according to the currently valid version of Regulation UN-R 10.

National information for regulatory radio components

Notes when crossing national borders

You must observe the radio regulatory provisions for the country in which you are currently driving when operating the vehicle.

Only for EU and EFTA countries and countries that recognise the EU manufacturer's declaration of conformity:



The following information applies to all wireless components of the vehicle and of the information systems and communication devices integrated in the vehicle:

The manufacturers of the wireless components ensure that all wireless components installed in the vehicle comply with Directive 2014/53/EU. The full texts of the EU declarations of conformity are available at the following web address:

https://moba.i.mercedes-benz.com/markets/ece-row/baix/cars/certificates-of-conformity/en_GB/index.html



You can obtain further information from a Mercedes-Benz service centre.

For Israel only:

It is prohibited to make any change to a vehicle-installed radio component that could affect the

wireless specifications of the device, including software changes, replacement of the original antenna, or adding the option to connect the device to an external antenna, without first obtaining approval from the Communications Ministry, because of concern about wireless interference.

For the United Kingdom only:



The following information applies to all wireless components of the vehicle and of the information systems and communication devices integrated in the vehicle:

The manufacturers of the radio components declare that all radio equipment installed in the vehicle is in compliance with the relevant statutory requirements. The full texts of the declarations of conformity are available at the following web address:

https://moba.i.mercedes-benz.com/markets/ece-row/baix/cars/certificates-of-conformity/en_GB/index.html



For Brazil only:



Note on two-way radio systems in the vehicle:

These systems are not protected against harmful interference and must not cause interference in properly approved systems.

For Jamaica only:

All wireless vehicle components have received type approval from the SMA.

For Nigeria only:

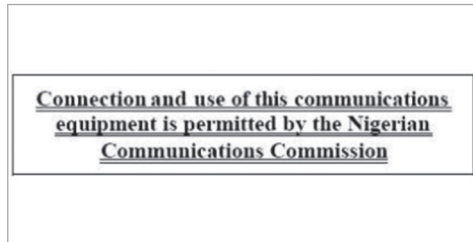

Connection and use of the radio communications equipment in this vehicle is permitted by the Nigerian Communications Commission

For Russia only:



The manufacturers of the wireless components installed in the vehicle hereby declare that all wireless components installed in the vehicle comply with the technical regulations for two-way radios. You can obtain further information from a Mercedes-Benz service centre.

For Ukraine only:



The manufacturers of the wireless components installed in the vehicle hereby declare that the wireless components installed in the vehicle comply with the technical regulations for two-way radios. You can obtain further information from a Mercedes-Benz service centre.

Jack

For EU and EFTA countries only:

Copy and translation of the original declaration of conformity:

EC declaration of conformity

1.

The undersigned, representing

Manufacturer:

BRANO a.s.

747 41 Hradec nad Moravicí, Opavská 1000,

The Czech Republic

ID No.: 64-387-5933

VAT No.: CZ64-387-5933

herewith declares under our sole responsibility that the product:

2. a)

Name:

Jack

Type, Number:

A) A 164 580 02 18, A 166 580 01 18

B) A 240 580 00 18

C) A 639 580 02 18

D) A 639 580 03 18

E) A 910 580 00 00

F) A 247 580 00 00, A 293 580 00 00

G) A 247 580 01 00, A 293 580 01 00

H) A 247 580 02 00, A 293 580 02 00

Year of manufacture: 2022

Complies with all relevant provisions

Directive No. 2006/42/EC

b)

Description and purpose of use:

Car jack is intended solely for lifting of the concrete car, in accordance with the instruction label on the car jack.

3.

References of harmonized and other standards or specifications

ISO 4063, EN ISO 14341-A, AS 2693, DBL 8230.10, DBL 7382.20, DBL 7392.10, DBL 8451.15, MBN 10435,

Technical documentation of the product is stored at the premise of the manufacturer. The person responsible for assembling the technical documentation of the product: Head of the Technical Department Brano a.s.

4.

Hradec nad Moravicí

Place

5.

14.03.2022

Date

Dipl. Engineer Michal Koberský

[Signature]

Director SBU-CJ

For the United Kingdom only:

Copy and translation of the original declaration of conformity:

UK declaration of conformity

1.

The undersigned, representing

Manufacturer:

BRANO a.s.

74741 Hradec nad Moravicí, Opavská 1000,
Czech Republic

ID No.: 64-387-5933

VAT No.: CZ64-387-5933

herewith declares under our sole responsibility
that the product:

2. a)

Name:

Jack

Type, Number:

A) A 164 580 02 18, A 166 580 01 18

B) A 240 580 00 18

C) A 639 580 02 18

D) A 639 580 03 18

E) A 910 580 00 00

F) A 247 580 00 00, A 293 580 00 00

G) A 247 580 02 00, A 293 580 02 00

Year of manufacture: 2022

Complies with all relevant provisions

Supply of Machinery (Safety) Regulations 2008

b)

Description and purpose of use:

Car jack is intended solely for lifting of the concrete car, in accordance with the instruction label on the car jack.

3.

References of harmonized and other standards or specifications

ISO 4063, EN ISO 14341-A, DBL 8230.10, DBL 7382.20, DBL 7392.10, DBL 8451.15, MBN 10435,

Technical documentation of the product is stored at the premise of the manufacturer. The person

responsible for assembling the technical documentation of the product: Head of the Technical Department Brano a.s.

4. Hradec nad Moravicí	5. 04.07.2022	[Signature] Dipl. Engineer Michal Koberský
Place	Date	Director SBU-CJ

TIREFIT kit

For EU and EFTA countries only:

Copy and translation of the original declaration of conformity:

CE

EU Declaration of Conformity

We

Dunlop Tech GmbH

Offenbacher Landstr. 8

DE-63456 Hanau

Declare under our sole responsibility that
 Product Description: Electrical Air Pump
 Serial Number: 000000001 to 999999999
 Brand: Mercedes Benz
 Model: DT 200146 (UW0851ve-IBK LK2), DT 200177 (UW0872-IBK-LK2P), 200156 (UW0867-LK3)
 Mercedes Benz Part Number: A 000 583 8205, A 000 583 8305, A 000 583 8405
 is in conformity with all relevant provisions of the directives:
 Electromagnetic Compatibility 2014/30/EU
 and complies with the following standards :
 EN IEC 55014-1: 2021
 EN IEC 55014-2: 2021
 Including (Category I)
 Dunlop Tech GmbH, Offenbacher Landstr. 8, 63456 Hanau, Germany authorized representative for the completion of the technical documentation.
 Factory name: UNIK WORLD IND. CO., LTD.

Address: NO. 110-2, Xiwei, Shanhua Dist., Tainan City 74163, Taiwan (R.O.C.)
 Name Dunlop Tech GmbH
 Authorized Representative: Bernd Schuchhardt
 Address: Offenbacher Landstraße 8, 63456 Hanau, Germany

15-07-2022	[B. Schuchhardt]
	Signature

Declaration place: Germany

For the United Kingdom only:

Copy and translation of the original declaration of conformity:
 Dunlop Tech GmbH
 UKCA Declaration of Conformity
 Product :
 Product
 Electrical Air pump
 Model / Brand

DT 200146 (UW0851ve-IBK LK2), DT 200177 (UW0872), DT 200156 (UW0867-LK3)

Mercedes Benz Part Number:

A 000 583 8205, A 000 583 8305, A 000 583 8405

Authorized Representative (UK-GB):

Name:

Address:

Contact person:

This declaration is issued under the sole responsibility of the mentioned Representative. The subject equipment under declaration is in conformity with the UK-GB Regulation(s) below:

Statutory Instruments 2016 No. 1091

The Electromagnetic Compatibility Regulations 2016

Below designated standards were taken conferring a presumption of conformity with the relevant UK-GB regulations:

BS EN IEC 55014-1: 2021

BS EN IEC 55014-2: 2021

Authorized Representative responsible for making this declaration:

Name: Dunlop Tech GmbH

Authorized Representative: Bernd Schuchhardt

Address: Offenbacher Landstraße 8, 63456 Hanau, Germany

15-07-2022	[B. Schuchhardt]
(Date)	Signature

Diagnosics connection

The diagnostics connection is a technical interface in the vehicle. It is used, for example, during repair and maintenance work or for reading out vehicle data in a specialist workshop. Diagnostic devices should therefore only be connected in a qualified specialist workshop.

⚠ WARNING Risk of accident due to connecting devices to the diagnostics connection

If you connect devices to the diagnostics connection of the vehicle, the function of vehicle systems and operating safety may be impaired.

- ▶ For safety reasons, we recommend that you only use and connect products approved by a Mercedes-Benz service centre.

⚠ WARNING Risk of accident due to objects in the driver's footwell

Objects in the driver's footwell may impede pedal travel or block a depressed pedal.

This jeopardises the operating and road safety of the vehicle.

- ▶ Stow all objects in the vehicle securely so that they cannot get into the driver's footwell.

- ▶ Always fit the floor mats securely and as prescribed in order to ensure that there is always sufficient room for the pedals.
- ▶ Do not use loose floor mats and do not place floor mats on top of one another.

! NOTE Battery discharging from using devices connected to the diagnostics connection

Using devices at the diagnostics connection drains the battery.

- ▶ Check the charge level of the battery.
- ▶ If the charge level is low, charge the battery, e.g. by driving a considerable distance.

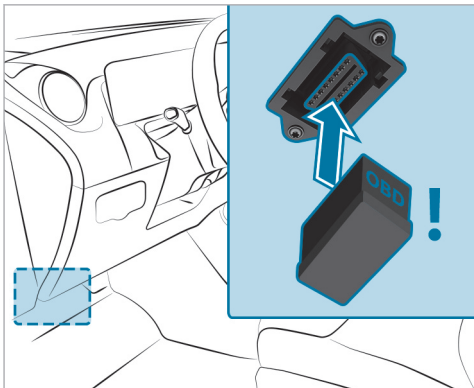

Connecting and using another device with the diagnostics connection can have the following effects:

- Malfunctions in the vehicle system
- Permanent damage to vehicle components

Please refer to the warranty terms and conditions for this matter.

Qualified specialist workshop

A qualified specialist workshop has the necessary special skills, tools and qualifications to correctly carry out any necessary work on your vehicle. This particularly applies to safety-relevant work.

Always have the following work carried out on your vehicle at a qualified specialist workshop:

- Safety-relevant work
- Service and maintenance work
- Repair work
- Modifications as well as installations and conversions
- Work on electronic components

Mercedes-Benz recommends a Mercedes-Benz service centre.

Vehicle registration

Mercedes-Benz may ask its service centres to carry out technical inspections on certain vehicles. The quality or safety of the vehicle is improved as a result of the inspection.

Mercedes-Benz can only inform you about vehicle checks if Mercedes-Benz has your registration data.

It is possible that your vehicle has not yet been registered in your name in the following cases:

- if your vehicle was not purchased at an authorised specialist dealer.
- if your vehicle has not yet been examined at a Mercedes-Benz service centre.

It is advisable to register your vehicle with a Mercedes-Benz service centre.

Inform Mercedes-Benz as soon as possible about any change in address or vehicle ownership. You can do this at a Mercedes-Benz service centre, for example.

Correct use of the vehicle

If you remove any warning stickers, you or others could fail to recognise certain dangers. Leave warning stickers in position.

Observe the following information in particular when driving your vehicle:

- the safety notes in this Owner's Manual, vehicle-specific supplements and further supplementary documents
- technical data for the vehicle
- Traffic rules and -regulations of the country you are currently in
- Motor vehicle laws and safety standards of the country you are currently in
- Radio regulatory requirements of the country you are currently in

Information on the REACH regulation

EU and EFTA countries only:

The REACH regulation (Regulation (EC) No. 1907/2006, Article 33) stipulates a duty to supply information about substances of very high concern (SVHCs).

Mercedes-Benz AG acts to the best of its knowledge to prevent these SVHCs from being used and to enable customers to safely handle these

substances. There are SVHCs known to Mercedes-Benz AG, according to supplier information and internal product information, found in individual components of this vehicle in quantities of over 0.1% by weight.

Further information can be obtained at the following addresses:

- <https://reach.mercedes-benz.com/de/home/>
- <https://reach.mercedes-benz.com/en/home/>

Notes for persons with electronic medical aids

Mercedes-Benz AG cannot, despite carefully developing vehicle systems, completely rule out the interaction of vehicle systems with electronic medical aids such as cardiac pacemakers.

In addition, there are components installed in the vehicle that, regardless of the operating status of the vehicle, can generate magnetic fields on a par with permanent magnets. These fields can be found, for example, in the area around the multi-

media and sound system or also in the area of the seats, depending on the vehicle equipment.

For this reason, the following can occur in isolated cases, depending on the aids used:

- Medical aids malfunctioning
- Adverse health effects

Observe the notes and warnings of the manufacturer of the medical aids; if in doubt, contact the device manufacturer and/or your doctor. If there is continuing uncertainty concerning the possibility of medical aids malfunctioning, Mercedes-Benz AG recommends using only few electrical vehicle systems and/or maintaining a distance from the components.

When charging the high-voltage battery, keep a distance of at least an arm's length between the medical aid and the following components:

- the power supply equipment
This includes charging stations in the form of a wallbox or a public charging point, for example.
- vehicle components carrying live voltage

This includes the charging cable and the charging control box, for example.

Only have repairs and maintenance work in the area of the following components carried out at a qualified specialist workshop:

- vehicle components carrying live voltage
- transmission aerials
- multimedia system and sound system

If you have any queries or suggestions, consult a qualified specialist workshop.

Implied warranty

! **NOTE** Damage to the vehicle arising from violation of these operating instructions.

Damage to the vehicle can arise from violation of these operating instructions.

This damage is not covered either by the Mercedes-Benz implied warranty or by the New- or Used-Vehicle Warranty.

▶ Follow the instructions in these operating instructions on proper operation of

your vehicle as well as on possible vehicle damage.

QR code for rescue card

QR codes are attached in the socket flap and on the opposite side on the B-pillar. In the event of an accident, rescue services can use the QR code to quickly find the appropriate rescue card for your vehicle. The current rescue card contains the most important information about your vehicle (e.g. the routing of the electric lines) in compact form.

Further information can be obtained at <https://www.mercedes-benz.de/qrcode>

Data storage

Data processing in the vehicle

Electronic control units

Electronic control units are fitted in your vehicle. Control units process data they receive from vehicle sensors, for example, generate themselves or exchange between themselves. Some control

units are required for the safe operation of your vehicle. For example, some assist you when driving, such as driver assistance systems, while others enable convenience or infotainment functions.

The following provides you with general information regarding data processing in the vehicle. Additional information regarding which data in your vehicle are collected, saved and transmitted to third parties and for what purpose can be found in the information directly related to the functional characteristics in question in their respective Owner's Manual. This information is available online and digitally, depending on the vehicle's equipment.

Personal data

A unique vehicle identification number identifies every vehicle. Depending on the country, this vehicle identification number can be used by, for example, governmental authorities to determine the owner's identity. There are other possibilities for using data collected from the vehicle to identify the owner or driver, such as the licence plate number.

Therefore, data generated or processed by control units may be attributable to a person or, under certain conditions, become attributable to a person. Depending on which vehicle data are available, it may be possible to make inferences about, for example, your driving behaviour, location, route or use patterns.

Legal requirements regarding the disclosure of data

If legally required to do so, manufacturers are, in individual cases, legally obliged to provide governmental entities, upon request and to the extent required, data stored by the manufacturer. For example, this may be the case during the investigation of a criminal offence.

Governmental entities are themselves authorised to read out data from the vehicle in individual cases and within the applicable legal framework. In the case of an accident, information that can help with an investigation can be taken from the airbag control unit, for example.

Operational data in the vehicle

This is data regarding the vehicle's operation, which control units have processed.

This includes the following data, for example:

- Vehicle status information such as the speed, longitudinal acceleration, lateral acceleration, number of wheel revolutions or the fastened seat belts display
- Ambient conditions, such as temperature, rain sensor or distance sensor

Generally, these are volatile data and will not be stored beyond the period of operation but will only be processed within the vehicle itself. Control units, for example, vehicle keys, often contain data memories. Their use permits the temporary or permanent documentation of technical information about the vehicle's operating state, component loads, maintenance requirements and technical events or faults.

Depending on the technical equipment, the following data are stored:

- Operating status of system components, such as fill levels, tyre pressure or battery status
- Malfunctions or faults in important system components, such as lights or brakes

- System reactions in special driving situations, such as an airbag deployment or the intervention of stability control systems
- information on events leading to vehicle damage
- Charge level of the high-voltage battery, estimated range

In certain cases, storing data that would have otherwise been temporary may be required. This may be the case if the vehicle has detected a malfunction, for example.

If you use services such as repair services and maintenance work, stored operational data and the vehicle identification number can be read out and used. Service network employees can read them out, such as workshops and manufacturers or third parties, such as breakdown services. The same is true in the case of warranty claims and quality assurance measures.

In general, the readout is performed via the legally prescribed port for the diagnostics connection in the vehicle. The operational data that are read out in technical document states of the vehicle or of individual components and assist in diagnosing

malfunctions, compliance with warranty obligations and quality improvement. To that end, these data, particularly information about component loads, technical events, malfunctions and other faults, may be transmitted along with the vehicle identification number to the manufacturer. Furthermore, the manufacturer is subject to product liability. For this reason, the manufacturer also uses operational data from the vehicle, for example, for recalls. These data can also be used to examine the customer's warranty and guarantee claims.

Fault memories in the vehicle can be reset by a service outlet or at your request as part of repair or maintenance work.

Convenience and infotainment functions

You can store the vehicle's convenience settings and individual settings and change or reset them at any time.

Depending on the vehicle equipment, this includes the following settings, for example:

- Seat and steering wheel positions
- Suspension and climate control settings
- Individual settings, such as interior lighting

Depending on the selected equipment, you can import data into vehicle infotainment functions yourself.

Depending on the vehicle equipment, this includes the following data, for example:

- Multimedia data, such as music, films or photos for playback in an integrated multimedia system
- address book data for use in connection with an integrated hands-free system or an integrated navigation system
- entered navigation destinations
- data about the use of Internet services

These data for convenience and infotainment functions may be saved locally in the vehicle or located on a device you have connected to the vehicle, such as a smartphone, USB flash drive or MP3 player. If you have entered these data yourself, you can delete them at any time.

These data are transmitted only from the vehicle to third parties at your request. This applies, in particular, when you use online services per the settings you have selected.

Smartphone integration (e.g. Android Auto or Apple CarPlay®)

If your vehicle is accordingly equipped, you can connect your smartphone or another mobile end device to the vehicle. You can then control them by employing the control elements integrated into the vehicle. Images and audio from the smartphone can be output via the multimedia system. Certain information is simultaneously transferred to your smartphone. Depending on the type of integration, this includes position data, day/night mode and other general vehicle statuses. For more information, please consult the vehicle Owner's Manual/infotainment system.

This integration allows the use of selected smartphone apps, such as navigation or music player apps. There is no further interaction between the smartphone and the vehicle; in particular, vehicle data is not directly accessible. The type of additional data processing is determined by the provider of the app being used. Which settings you can make, if any, depends on the specific app and your smartphone's operating system.

Online services

Wireless network connection

If your vehicle has a wireless network connection, it enables data to be exchanged between your vehicle and additional systems. The wireless network connection is made possible by the vehicle's own transmitter and receiver or by a mobile end device that you have brought into the vehicle, for example, a smartphone. Online functions can be used via the wireless network connection. This includes online services and applications/apps provided to you by the manufacturer or by other providers.

Manufacturer's services

Regarding the manufacturer's online services, the individual functions are described by the manufacturer in a suitable place, for example, in the Owner's Manual or on the manufacturer's website, where the relevant data protection information is also given. Personal data may be used for the provision of online services. Data are exchanged via a secure connection, such as the manufacturer's designated IT systems. Any personal data which are collected, processed and

used, other than for the provision of services, is done so exclusively on the basis of legal permission. This is the case, for example, for a legally prescribed emergency call system, a contractual agreement or when consent has been given.

You can have services and functions, some of which are subject to a fee, activated or deactivated. This excludes legally prescribed functions and services, such as an emergency call system.

Third party services

If you use online services from other providers (third parties), these services are the responsibility of the provider in question and subject to that provider's data protection conditions and terms of use. As a general rule, the manufacturer has no influence on the content exchanged.

For this reason, when services are provided by third parties, please ask the service provider in question for information about the type, extent and purpose of the collection and use of personal data.

Data protection rights

Depending on your country or the equipment and range of functions of your vehicle as well as the services you use and the services on offer, you are entitled to different data protection rights. Further information on data protection and your data protection rights can either be found on the manufacturer's website or you will receive this information as part of the various services and service offers. There you will also find the contact information for the manufacturer and its data protection officers.

At a workshop, for example, with the support of a specialist and possibly for a fee, you can have data read out which is stored only locally in the vehicle.

Copyright



Information on licences for free and open-source software used in your vehicle can be found on the data carrier in your vehicle document wallet and with updates on the following website:

<https://www.mercedes-benz.com/opensource>

Brief overview of most important points

Basic information

Make sure that the following prerequisites in particular have been met so that the components of the restraint system are able to provide the intended level of protection:

- Sit correctly (→ page 92).
- Fasten the seat belt correctly (→ page 93).
 - Function of the  seat belt warning lamp (→ page 95).
 - Function of the rear seat belt status display (→ page 95).
- The  restraint system warning lamp is not lit up after the self-test (→ page 94).
- The PASSENGER AIR BAG indicator lamps display the correct status of the front passenger airbag (→ page 96).

For clear understanding

The chapter "Occupant safety" includes information on equipment, functions and behaviours that contribute directly to safety of vehicle occupants.

The information is structured as follows:

- **The most important information in brief:** in this chapter, you are provided with an overview of the relationship between the restraint system and the correct behaviour of all vehicle occupants.
- **Specific information:** in further sections of the chapter "Occupant safety", you can find specific information on the equipment and functions of the restraint system.
- **Keyword directory:** you can also find certain subjects in this Owner's Manual using the keyword directory.

Information on the following subjects, among others, are not provided in the chapter "Occupant safety":

- Children in the vehicle (→ page 109)
- Driving and driving safety systems (→ page 303)
- Stowage areas (→ page 190)

Defining generic terms clearly

In this Owner's Manual, the following generic terms are used:

- **Occupant safety:** comprises the components and system functions which help to minimise, as much as possible, the stresses on and consequences for vehicle occupants during an accident.
- **Restraint system:** comprises those components which, along with the vehicle structure, help prevent vehicle occupants from potentially coming into contact with parts of the vehicle interior. The seat belts and airbags, for example, are components of the restraint system.
- **Child restraint system:** you can find all information on this subject in the chapter "Children in the vehicle" (→ page 109).

Be diligent

For the components of the restraint system to provide the intended level of protection, it is essential that your posture is correct and that the seat belt is correctly fastened.

Bear in mind that negligence when adjusting your sitting position and fastening the seat belt may have serious consequences. Be diligent and make sure that all vehicle occupants are sitting correctly and have fastened their seat belts properly before starting every journey (→ page 92).

Information on the correct seat position

The seat position must be correct in order for the components of the restraint system to provide the intended level of protection.

The seat position influences both the protection provided by the seat belt and the additional protection provided by the airbag.

A correct seat position in which the seat is nearly perfectly upright and a correctly fastened seat belt reduce the risks posed by the airbag when it is deployed.

Keep space considerations in mind when choosing a seat. With the seat in the correct, nearly upright position, your head should not touch the roof.

⚠ WARNING Risk of injury or death due to an incorrect seat position

If you deviate from the correct seat position, the airbag cannot provide its intended protective function.

Each vehicle occupant must make sure of the following.

- ▶ Put the seat in the correct position.
- ▶ Fasten seat belts correctly. Pregnant women must take particular care to ensure that the lap belt never lies across the abdomen.
- ▶ Observe the following information.

In order for the restraint system to provide the intended level of protection, observe the following information:

- Before starting your journey, adjust your seat correctly (→ page 171).

When doing so, make sure you are able to fasten your seat belt correctly. The shoulder belt strap must be routed forward from the seat belt outlet over the centre of your shoulder.

- Keep your distance from the airbags, especially the front airbags. Set the driver's seat and front passenger seat as far back as possible while making sure the seat belt is fastened correctly.
- If persons are sitting on the rear seats, vehicle occupants should maintain a sufficient distance to the parts of the vehicle interior in front of them.
- Make sure there are no people, animals or objects between the vehicle occupants and an airbag.
- If you are the driver, observe the following information on the correct position of the driver's seat (→ page 171).
 - Only hold the steering wheel by the steering wheel rim. This allows the driver's airbag to fully deploy.
- Assume a nearly upright sitting posture, with your buttocks positioned as far back as possible in the gap between the seat cushion and the seat backrest.
 - Your back must lie as flatly and as firmly as possible against the seat backrest.

- While driving, do not lean forward and do not lean against the door or side window. You may otherwise be in the deployment area of the airbags.
- Sit with their feet resting on the floor, if possible. Your thighs are slightly supported by the seat cushion

Do not put your feet on the cockpit, for example. Your feet may otherwise be in the deployment area of the airbag.

- Fasten the seat belt correctly (→ page 93).

Notes on wearing the seat belt correctly

Always fasten your seat belt correctly before starting a journey. A seat belt can only provide the best level of protection if it is worn correctly.

⚠ WARNING Risk of injury or death due to incorrectly fastened seat belt

If the seat belt is not worn correctly, it cannot perform its intended protective function.

In addition, an incorrectly fastened seat belt can also cause injuries, for example, in the event of an accident or when braking or changing direction suddenly.

- ▶ Always ensure that all vehicle occupants have their seat belts fastened correctly and are sitting properly.

⚠ WARNING Risk of injury or death when additional restraint systems are not used for persons with a smaller stature

Persons under 1.50 m tall cannot wear the seat belt correctly without a suitable additional restraint system.

- ▶ Always secure persons under 1.50 m tall in a suitable restraint system.

Observe the following information on the correct seat position and posture (→ page 92).

Each vehicle occupant must observe the following notes in particular:

- The seat belt must not be twisted.

- The shoulder belt strap must be routed forward from the seat belt outlet over the centre of your shoulder.
- The shoulder belt strap should neither touch your neck nor be routed under your arm or behind your back.
- The lap belt must be routed as low down across the hips as possible.

In addition, push the lap belt down as far as possible across your hips and pull tight with the shoulder belt strap. Never route the lap belt across your abdomen.

Pregnant women must also take particular care with this.

- After being tightened, the shoulder belt strap and lap belt must fit snugly against the body.
- Avoid wearing bulky clothing, e.g. a winter coat.
- Never route the seat belt across sharp, pointed, abrasive or fragile objects.
- Only one person should use each seat belt at any one time.

- Never secure objects with a seat belt if the seat belt is also being used by one of the vehicle's occupants.

Also ensure that no objects, e.g. a cushion, are ever placed between a person and the seat.

If you are driving with a child in the vehicle, observe the information in the chapter "Children in the vehicle" (→ page 109)

Observe the instructions for loading the vehicle when securing objects, luggage or loads (→ page 190).

Fastening and adjusting seat belts

If the seat belt is pulled quickly or sharply, the seat belt retractor locks. The seat belt strap cannot be pulled out any further.

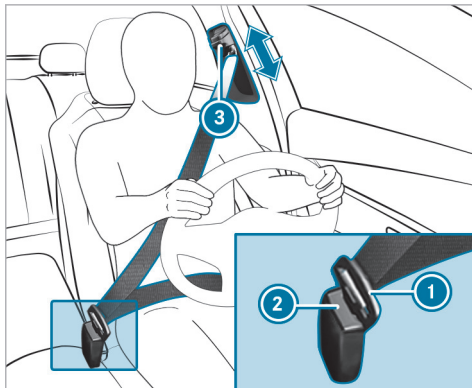

- ▶ Always engage seat belt tongue ① of the seat belt into seat belt buckle ② of the corresponding seat.
- ▶ **To adjust the seat belt height:** press button ③ on the seat belt outlet and slide the seat belt outlet to the desired position.
- ▶ **To engage the seat belt outlet:** release button ③ and ensure that the seat belt outlet engages.

! **NOTE** Deployment of components of the restraint system when the front passenger seat is unoccupied and a seat belt is buckled



When the front passenger seat is unoccupied and the seat belt tongue of the seat belt is engaged in the seat belt buckle, components of the restraint system may deploy unnecessarily on the front passenger side, e.g. the seat belt tensioner.

▶ Only buckle the seat belts as intended.

Function of the restraint system warning lamp

When the vehicle is switched on, a self-test is performed, during which the  restraint system warning lamp lights up. It goes out no later than a few seconds after the vehicle is started. The components of the restraint system are then functional.

A malfunction has occurred in the restraint system if:

- the  restraint system warning lamp does not light up when the vehicle is switched on
- the  restraint system warning lamp lights up continuously or repeatedly during a journey

If components of the restraint system have been deployed, the  restraint system warning lamp lights up continuously.

⚠ WARNING Risk of injury due to malfunctions in the restraint system

Components in the restraint system may be activated unintentionally or not deploy as intended in an accident.

- ▶ Have the restraint system checked and repaired immediately at a qualified specialist workshop.

If the restraint system is malfunctioning, the automatic high voltage emergency shutoff may not function.

⚠ DANGER Risk of fatal injury due to malfunctioning automatic high-voltage emergency shutoff

In the event of an accident, the high-voltage on-board electrical system may not be deactivated as intended.

You may receive an electric shock if you touch the damaged components of the high-voltage on-board electrical system.

- ▶ Have the automatic high-voltage emergency shutoff checked and repaired immediately at a qualified specialist workshop.
- ▶ After an accident, switch off the vehicle immediately.

Mercedes-Benz recommends that you have the vehicle towed to a qualified specialist workshop.

Function of the seat belt warning lamp

The  seat belt warning lamp in the driver's display is a reminder that all vehicle occupants must wear their seat belts correctly.

In addition, a warning tone may sound.

As soon as the driver and front passenger fasten their seat belts, the seat belt warning goes out.

Function of the rear seat belt status display

The rear seat belt status display in the driver's display is a reminder that all vehicle occupants must wear their seat belts correctly.

In addition, a warning tone may sound.

If a person unfastens a seat belt in the rear passenger compartment while the vehicle is motion, the rear seat belt status display appears again.

Display in the driver's display

Every time the vehicle is switched on, the rear seat belt status display informs you for a certain amount of time which rear seat belt is not fastened.

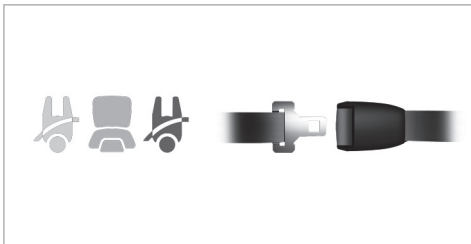

You can determine the status of the rear seat belt by the colour of the seat symbol in the driver's display as follows:

- Grey: the rear seat belt is not fastened.
- Green: the seat belt tongue of a rear seat belt is engaged in the seat belt buckle of the displayed seat.
- Red: the person in the rear seat has unfastened their seatbelt.

Function of the PASSENGER AIR BAG indicator lamps (front passenger airbag)



Vehicles without automatic front passenger airbag shutoff have a special sticker affixed to the side of the cockpit on the front passenger side (→ page 116).

The PASSENGER AIR BAG indicator lamps display the status of the front passenger airbag.

If the front passenger seat is occupied or a child restraint system is fitted on the front passenger seat, you must make sure both before, and also during the journey, that the status of the front passenger airbag is correct for the situation.

⚠ WARNING Risk of potentially fatal injuries due to objects trapped under the front passenger seat

Objects trapped under the front passenger seat may interfere with the function of the automatic front passenger airbag shutoff or damage the system.

- ▶ Do not stow any objects under the front passenger seat.
- ▶ When the front passenger seat is occupied, ensure that no objects have become trapped beneath the front passenger seat.

Self-test: when the vehicle is switched on, both the PASSENGER AIR BAG ON and OFF indicator lamps light up simultaneously for several seconds.

After the self-test, you can determine the status of the front passenger airbag as follows:

- **Front passenger airbag disabled:** PASSENGER AIR BAG OFF lights up continuously.

The front passenger airbag will not be deployed in the event of an accident. If PASSENGER AIR BAG OFF is lit, no one may use the front passenger seat.

If a rearward-facing child restraint system is fitted on the front passenger seat, PASSENGER AIR BAG OFF must be lit continuously.

- **Front passenger airbag enabled:** PASSENGER AIR BAG ON lights up for up to 60 seconds or until both the PASSENGER AIR BAG ON and OFF indicator lamps go out.

The front passenger airbag may be deployed during an accident. If the front passenger airbag is in this status, no rearward-facing child restraint system may be fitted on the front passenger seat.

- ① If you are driving with a child in the vehicle, observe the information in the chapter "Children in the vehicle" (→ page 109)

⚠ WARNING Risk of injury or death due to a disabled front passenger airbag

The front passenger airbag is disabled when the PASSENGER AIR BAG OFF indicator lamp is lit.

A person in the front passenger seat could then, for example, come into contact with the vehicle interior, especially if the person is sitting too close to the cockpit.

If the front passenger seat is occupied, always ensure that:

- the classification of the person in the front passenger seat is correct and the front passenger airbag is enabled or disabled in accordance with the person in the front passenger seat.
- the front passenger seat has been moved as far back as possible.
- the person is seated correctly.

- ▶ Both before and during the journey, ensure that the status of the front passenger airbag is correct.

Malfunction of the automatic front passenger airbag shutoff

The PASSENGER AIR BAG OFF indicator lamp and the  restraint system indicator lamp light up simultaneously.

In this case, no one may use the front passenger seat and no child restraint system may be fitted on the front passenger seat.

Have the automatic front passenger airbag shutoff checked and repaired immediately at a qualified specialist workshop.

Disabling or enabling the front passenger airbag

The automatic front passenger airbag shutoff can disable or enable the front passenger airbag according to the situation.

This happens automatically as a result of the classification of the person or child restraint system on the front passenger seat.

You cannot manually disable or enable the front passenger airbag.

Information on the child restraint system

When fitting a child restraint system, observe the notes in "Children in the vehicle" (→ page 109).

Notes on the child restraint system on the front passenger seat

⚠ WARNING Risk of injury or death due to an enabled co-driver airbag

If the co-driver airbag is enabled, a child on the co-driver seat may be struck by the co-driver airbag during an accident.

▶ NEVER use a rearward-facing child restraint system on a seat with an ENABLED FRONT AIRBAG. DEATH or SERIOUS INJURY to the CHILD can occur.

Also pay particular attention to the notes on rearward-facing or forward-facing child restraint systems on the front passenger seat (→ page 113).

Information on the automatic functions of the restraint system

Function of the automatic front passenger airbag shutoff

A person on the front passenger seat must observe the following information:

- Sit correctly (→ page 92).
- Fasten the seat belt correctly (→ page 93).

The automatic front passenger airbag shutoff can disable or enable the front passenger airbag according to the situation.

Make sure you observe the following information:

- The status of the front passenger airbag, see "Function of the PASSENGER AIR BAG indicator lamps" (→ page 96).
- When fitting a child restraint system to the front passenger seat, observe the vehicle-specific information (→ page 113).



Status of the front passenger airbag in relation to the stature of the person:

- **Front passenger airbag disabled:** PASSENGER AIR BAG OFF lights up continuously.

The front passenger airbag will not be deployed in the event of an accident. If PASSENGER AIR BAG OFF is lit, no one may use the front passenger seat.

- **Front passenger airbag enabled:** PASSENGER AIR BAG ON lights up for up to 60 seconds or until both the PASSENGER AIR BAG ON and OFF indicator lamps go out.

The front passenger airbag may be deployed during an accident. Observe the following information on the correct seat position (→ page 92).

Vehicles with rear seats: a person of smaller stature should use a rear seat.

System limits

The front passenger airbag may otherwise be disabled by mistake, for example, in the following situation:

- The front passenger transfers their weight by supporting themselves on a vehicle armrest.
- The front passenger sits in such a way that their weight is raised from the seat surface.

! **NOTE** Deployment of components of the restraint system when the front passenger seat is unoccupied

In an accident, the components of the restraint system may deploy unnecessarily on the front passenger side if:

- There are heavy objects on the front passenger seat.
- The seat belt tongue is engaged in the seat belt buckle of the front passenger seat and the front passenger seat is unoccupied.

▶ Stow objects in a suitable place.

▶ Only one person should use each seat belt at any one time.

Depending on the detected accident situation, the window airbag on the front passenger side may deploy. The airbag is deployed regardless of whether the front passenger seat is occupied.

Function of PRE-SAFE® (anticipatory occupant protection)

PRE-SAFE® is able to detect certain critical driving situations and implement pre-emptive measures to protect the vehicle occupants.

PRE-SAFE® can implement the following measures independently of each other:

- Tightening the seat belts on the driver's seat and front passenger seat.
- Closing the side windows.
- **Vehicles with sliding sunroof:** closing the sliding sunroof.
- **Vehicles with memory function:** moving the front passenger seat to a more favourable seat position.
- **Vehicles with multicontour seat:** increasing the lateral support by inflating the seat side bolsters of the seat backrest.
- **PRE-SAFE® Sound:** provided that the multimedia system is switched on, generating a brief noise signal to stimulate the innate protective mechanism of a person's hearing.

! **NOTE** Damage caused by objects in the footwell or behind the seat

The automatic adjustment of the seat position may result in damage to the seat and/or the object.

▶ Stow objects in a suitable place.

Reversing the PRE-SAFE® system measures

If an accident did not occur, the pre-emptive measures that were taken are reversed.

You will need to perform certain settings yourself.

- ▶ If the seat belt pre-tensioning is not reduced, move the seat backrest back slightly. The locking mechanism releases.

Function of PRE-SAFE® PLUS (anticipatory occupant protection plus)

PRE-SAFE® PLUS can detect certain impacts, particularly an imminent rear impact, and take pre-emptive measures to protect the vehicle occu-

pants. These measures cannot necessarily prevent an imminent impact.

PRE-SAFE® PLUS can implement the following measures independently of each other:

- Tightening the seat belts on the driver's seat and front passenger seat.
- Activating the rear hazard warning lights at a higher flashing frequency.
- Increasing brake pressure when the vehicle is stationary. This brake application is cancelled automatically when the vehicle pulls away.

If an accident did not occur, the pre-emptive measures that were taken are reversed.

System limits

The system will not initiate any action in the following situations:

- when reversing
or
- when the vehicle is towing a trailer and there is a risk of a rear impact

The system will not initiate any braking application in the following situations:

- whilst driving
or
- when entering or exiting a parking space while using Active Parking Assist

Function of PRE-SAFE® Impulse Side

If an imminent side impact is detected, PRE-SAFE® Impulse Side can pre-emptively move the front seat vehicle occupant's upper body towards the centre of the vehicle. It does this by rapidly inflating an air cushion in the outer seat side bolster of the seat backrest on the side on which the impact is anticipated. This increases the distance between the door and the vehicle occupant.

If PRE-SAFE® Impulse Side has been deployed or is faulty, the **PRE-SAFE impulse side inoperative** See Owner's Manual display message appears.

Seat belt adjustment function

Vehicles with PRE-SAFE®: after you have fastened the seat belt of the front seat, it may adjust itself against your body by pulling at the shoulder until somewhat tight. Do not hold the seat belt tightly while it is adjusting.

This function is a reminder that all vehicle occupants must wear their seat belts correctly.

You can activate and deactivate the seat belt adjustment function using the multimedia system (→ page 101).

Activating/deactivating seat belt adjustment via the multimedia system

Multimedia system:

- ➔  ➔ Settings ➔ Vehicle
- ➔ Occupant protection
- ▶ Activate or deactivate **Belt adjustment**.

Overview of the automatic measures after an accident

Depending on the type and severity of the accident, and depending on the vehicle's equipment, the following measures can be implemented, for example:

- automatic braking (post-collision brake) (→ page 101)
- activating the hazard warning lights
- triggering an automatic emergency call (→ page 55)
- switching off the drive system and high-voltage on-board electrical system
- unlocking the vehicle doors
- lowering the side windows
- displaying the emergency guide in the central display (→ page 56)
- switching on the interior lighting

Function of the post-collision brake after an accident

Depending on the accident situation, the post-collision brake can minimise the severity of a further collision or even avoid it.

If an accident is detected, the post-collision brake can initiate automatic braking. When the vehicle has come to a standstill, the electric parking brake is automatically applied.

The driver can cancel automatic braking by taking the following actions:

- braking more strongly than automatic braking
- fully depressing the accelerator pedal with force

Purpose and function of the restraint system

Overview of deployment situations (restraint system)

Make sure that the following prerequisites in particular have been met so that the components of the restraint system are able to provide the intended level of protection:

- Sit correctly (→ page 92).
- Fasten the seat belt correctly (→ page 93).
 - Function of the seat belt warning lamp (→ page 95).
 - Function of the rear seat belt status display (→ page 95).
- The  restraint system warning lamp is not lit up after the self-test (→ page 94).
- The PASSENGER AIR BAG indicator lamps display the correct status of the front passenger airbag (→ page 96).

Depending on the detected deployment situation, the components of the restraint system can be activated or deployed independently of each other:

- Seat belt tensioner: frontal impact, rear impact, side impact, rollover
- Driver's airbag, front passenger airbag: frontal impact
- Knee airbag: frontal impact
- Side airbag: side impact
- Centre airbag in the driver's seat backrest: side impact
- Window airbag: side impact, rollover, frontal impact
- PRE-SAFE® Impulse Side: side impact

The installation location of an airbag is identified by the AIRBAG symbol (→ page 107).

Observe the information on the function of the restraint system (→ page 102).

Information on how the restraint system works

How the restraint system functions depends on the severity of the impact detected and the apparent type of accident.

For more information about types of accidents, see "Overview of deployment situations" (→ page 102).

The activation thresholds for the components of the restraint system are determined based on the evaluation of the sensor values measured at various points in the vehicle. This process is pre-emptive in nature. The triggering/deployment of the components of the restraint system must take place in good time at the start of the collision.

Factors which can only be seen and measured after a collision has occurred cannot play a decisive role in airbag deployment. Nor do they provide an indication of airbag deployment.

The vehicle may be deformed significantly without an airbag being deployed. This is the case if only parts which are relatively easily deformed are affected and the rate of vehicle deceleration is not high. Conversely, an airbag may be deployed even though the vehicle suffers only minor defor-

mation. If very rigid vehicle parts such as longitudinal members are hit, this may result in sufficiently high levels of vehicle deceleration.

Depending on the apparent type of accident and the detected deployment situation, seat belt tensioners and/or airbags supplement the protection offered by a correctly worn seat belt.

When enabled, an airbag can provide additional protection for the respective vehicle occupant.

Potential protection provided by each airbag:

- Knee airbag: thigh, knee and lower leg
- Driver's airbag, front passenger airbag: head and ribcage
- Window airbag: head
- Side airbag: ribcage, also pelvis for front seat occupants
- Centre airbag: head and ribcage

However, no system available today can completely eliminate injuries and fatalities in every accident situation. In particular, the seat belt and airbag generally do not protect against objects penetrating the vehicle from the outside. It is also

not possible to completely rule out the risk of injury caused by the airbag deploying.

Mercedes-Benz recommends that you have the vehicle towed to a qualified specialist workshop after an accident. Take this into account, particularly if a seat belt tensioner is triggered or an airbag deployed.

If the seat belt tensioners are triggered or an airbag is deployed, you will hear a bang, and a small amount of powder may also be released:

- The bang will not generally affect your hearing.
- In general, the powder released is not hazardous to health but may cause short-term breathing difficulties to persons suffering from asthma or other pulmonary conditions.

Provided it is safe to do so, leave the vehicle immediately or open the window in order to prevent breathing difficulties.

Information on the limited protection provided by the restraint system

Risk due to the incorrect behaviour of vehicle occupants

Every vehicle occupant must make sure of the following in particular:

- They observe the information on the correct seat position (→ page 92).
- There are no heavy, sharp-edged or fragile objects in the pockets of their clothing. Store such objects in a suitable place.

⚠ WARNING Risk of injury or death due to incorrect seat position

The seat belt will not offer the intended level of protection if you have not moved the seat backrest to an almost vertical position.

In particular, you may slip under the seatbelt and injure yourself.

- ▶ Adjust the seat properly before beginning your journey.
- ▶ Always ensure that the seat backrest is in an almost vertical position and that

the shoulder section of your seat belt is routed across the centre of your shoulder.

Risk due to objects in the vehicle interior

Every vehicle occupant must make sure of the following in particular:

- They observe the information on the correct seat position (→ page 92).
- There are no objects between the seat, door and door pillar (B-pillar).
- There are no hard objects, e.g. coat hangers, hanging on the grab handles or coat hooks.
- There are no heavy, sharp-edged or fragile objects in the pockets of their clothing. Store such objects in a suitable place.

⚠ WARNING Risk of injury or death due to blocked seat belt buckle or seat belt anchorage

Objects next to the front seat that block the seat belt buckle or the moving seat belt

anchorage on the front seat impair the function of the seat belt tensioners.

- ▶ Before starting the journey, make sure that there are no objects around the seat belt buckle or between the front seat and door.

⚠ WARNING Risk of injury from objects in the deployment area of an airbag

Objects in the deployment area of an airbag can hinder or prevent the correct deployment of the airbag.

The airbag may then deploy in an uncontrolled manner and may even cause additional injuries to the vehicle occupants by deploying. This may be the case in particular if the airbag is integrated into the seat.

- ▶ Always stow and secure objects correctly.
- ▶ Before commencing your journey, make sure that no objects are stowed in the deployment area of an airbag.

The installation location of an airbag is identified by the AIRBAG (→ page 107) symbol.

Observe the following information:

- Notes on loading the vehicle (→ page 190)
- Information on the centre airbag in the driver's seat backrest (→ page 108)

Risk due to fitting accessories

Do not attach accessories such as mobile navigation devices, mobile phones or cup holders, within the deployment area of an airbag, e.g. on the cockpit, on the door, on the side window or on the side trim.

In addition, no connecting cables, tensioning straps or retaining straps must be routed or attached to the vehicle within the deployment area of an airbag. Always comply with the accessory manufacturer's installation instructions and, in particular, the notes on suitable places for installation.

⚠ WARNING Risk of injury or death due to unsuitable protective covers

Due to unsuitable protective covers, the airbags cannot protect vehicle occupants as they are designed to do.

- ▶ You should only use protective covers that have been approved for the corresponding seat by Mercedes-Benz.

In addition, the function of the automatic front passenger airbag shutoff could be restricted due to an unsuitable protective cover. If the front passenger seat is occupied, ensure that the PASSENGER AIR BAG indicator lamps display the correct status of the front passenger airbag (→ page 96).

Risk due to pets in the vehicle interior

⚠ WARNING Risk of accident and injury due to animals left unsecured or unattended in the vehicle

If you leave animals in the vehicle unattended or unsecured, they could press buttons or switches, for instance.

An animal may:

- activate vehicle equipment and become trapped, for example
- switch systems on or off and endanger other road users

Unsecured animals may be thrown about the vehicle in the event of an accident, or sudden steering and braking manoeuvres, and injure vehicle occupants.

- ▶ Never leave animals unattended in the vehicle.
- ▶ Always correctly secure animals while driving, e.g. using a suitable animal carrier.

Risk due to modification, damage or wear to the components of the restraint system

⚠ WARNING Risk of injury or death due to modifications to the restraint system

Vehicle occupants may no longer be protected as intended if alterations are made to the restraint system.

- ▶ Never alter the parts of the restraint system.
- ▶ Never tamper with the wiring or any electronic component parts or their software.

If it is necessary to modify the vehicle to accommodate a person with disabilities, contact a qualified specialist workshop.

Mercedes-Benz recommends that you use driving aids which have been approved for your vehicle by Mercedes-Benz.

⚠ WARNING Risk of injury or death due to damaged or modified seat belts

Seat belts cannot provide protection in the following situations:

- the seat belt is damaged, has been modified, is extremely dirty, bleached or dyed
- the seat belt buckle is damaged or extremely dirty
- modifications have been made to the seat belt tensioner, seat belt anchorage or seat belt retractor

Seat belts may sustain non-visible damage in an accident, e.g. due to glass splinters.

Modified or damaged seat belts could tear or fail in the event of an accident, for example.

Modified seat belt tensioners could accidentally trigger or fail to function as intended.

- ▶ Never modify the seat belt system, for example the seat belt, seat belt buckle, seat belt tensioner, seat belt anchorage and seat belt retractor.

- ▶ Make sure that the seat belts are undamaged, not worn and clean.
- ▶ Always have the seat belts checked immediately after an accident at a qualified specialist workshop.

Mercedes-Benz recommends that you use seat belts which have been approved for your vehicle by Mercedes-Benz.

⚠ WARNING Risk of injury due to modifications to the cover of an airbag

If you modify the cover of an airbag or affix objects such as stickers to it, the airbag can no longer function as intended.

- ▶ Never modify the cover of an airbag.
- ▶ Do not attach any objects to the cover.

The installation location of an airbag is identified by the AIRBAG symbol (→ page 107).

⚠ WARNING Risk of injury due to malfunctioning sensors in the door

The function of the airbags can be impaired due to modifications or incorrect work performed on the doors or door trim, or if the doors are damaged.

- ▶ Never modify the doors or parts of the doors.
- ▶ Always have work on the doors or door trim carried out at a qualified specialist workshop.

Risk due to components of the restraint system which have already been deployed

Mercedes-Benz recommends that you have the vehicle towed to a qualified specialist workshop after an accident.

⚠ WARNING Risk of burns from hot airbag components

The airbag parts are hot after an airbag has been deployed.

- ▶ Do not touch the airbag parts.

- ▶ Have a deployed airbag replaced at a qualified specialist workshop as soon as possible.

⚠ WARNING Risk of injury due to deployed airbag

A deployed airbag no longer offers any protection.

- ▶ Have the vehicle towed to a qualified specialist workshop in order to have the deployed airbag replaced.

Have deployed airbags replaced immediately.

⚠ WARNING Risk of injury or death from deployed pyrotechnic seat belt tensioners

Pyrotechnic seat belt tensioners that have been deployed are no longer operational and are unable to perform their intended protective function.

- ▶ Therefore, have deployed pyrotechnic seat belt tensioners immediately

replaced at a qualified specialist workshop.

Seat belts

Releasing seat belts

- ▶ Press the release button in the seat belt buckle and guide the seat belt back with the seat belt tongue.

! NOTE Damage caused by trapping the seat belt

If an unused seat belt is not fully retracted, it may become trapped in the door or in the seat mechanism.

- ▶ Always ensure that an unused seat belt is fully retracted.

Airbags

Overview of airbags

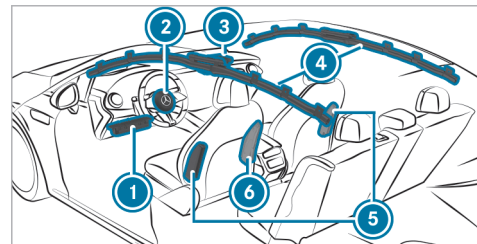

Driver's/front passenger seat:

- ① Knee airbag
- ② Driver's airbag
- ③ Front passenger airbag
- ④ Window airbag
- ⑤ Side airbag
- ⑥ Centre airbag¹

¹) Only for certain countries.

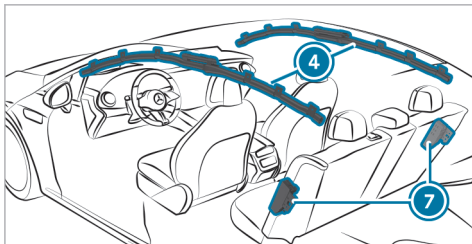

Information on the centre airbag in the driver's seat backrest

When triggered, the centre airbag deploys between the front seats. Do not stow any objects in the deployment area of the centre airbag.

Observe the notes on loading the vehicle (→ page 190).

Rear seats:

- ④ Window airbag
- ⑦ Side airbag

The installation location of an airbag is identified by the AIRBAG symbol. An additional arrow symbol ► indicates the installation location for certain airbags.

Observe the information in "Overview of deployment situations" (→ page 102).

Brief overview of most important points

Safely transporting children in the vehicle

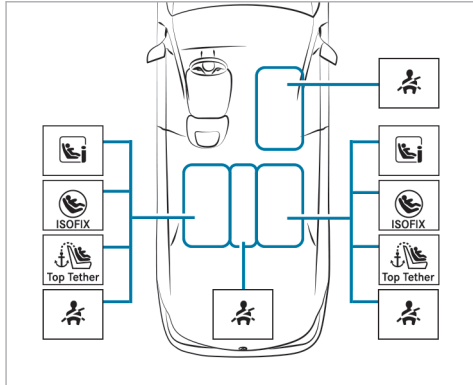

Always observe the following when transporting children:

- Never leave children unattended in the vehicle (→ page 111).

- Secure children up to a height of 1.50 m on the seat (see illustration above) properly with a suitable and approved child restraint system (→ page 116), and secure small children in a rearward-facing child restraint system.
- Observe the child restraint system manufacturer's installation instructions.

Left/right rear seat (preferred seats)

Preferred securing system:

-  LATCH-type (ISOFIX) securing rings (→ page 120)



or

-  i-Size securing rings (→ page 122)

and

-  Also secure Top Tether if present (→ page 128).

Alternative securing system:

-  Vehicle seat belt (→ page 130)
-  Additionally attach Top Tether if recommended by the manufacturer of the child restraint system (→ page 128).

The following child restraint systems within the Universal category are approved: U, UF, i-U, IU, IUF. Observe the other alternatives for use (→ page 120).

Front passenger seat

Securing system:

-  Vehicle seat belt (→ page 130)

Be sure to observe:

- If the front passenger seat is occupied, ensure that the status of the front passenger airbag is correct for the current situation (→ page 96).

The following child restraint systems within the Universal category are approved: U^(*), UF. Observe the other alternatives for use (→ page 123).

(*) rearward-facing child restraint system only in combination with automatic airbag shutoff

Centre rear seat

Securing system:

-  Vehicle seat belt (→ page 130)

The following belt-secured child restraint systems within the Universal category are approved: U, UF. Observe the other alternatives for use (→ page 130).

Important safety notes

Basic information

Be diligent

Bear in mind that negligence when securing a child in the child restraint system may have serious consequences. Always be diligent in securing a child carefully before every journey.

Never allow babies and children to travel sitting on the lap of another vehicle occupant.

To improve protection for children younger than 12 years old or under 1.50 m in height, Mercedes-Benz recommends you observe the following information:

- Always secure the child in a child restraint system suitable for this Mercedes-Benz vehicle.
- The child restraint system must be appropriate to the age, weight and size of the child.

- The vehicle seat must be suitable for the child restraint system to be fitted:
 - LATCH-type (ISOFIX) securing rings: (→ page 120)
 - i-Size securing rings: (→ page 122)
 - Securing with the vehicle seat belt: (→ page 123)

Accident statistics show that children secured on the rear seats are generally safer than children secured on the front seats. For this reason, Mercedes-Benz strongly advises that you fit a child restraint system to a rear seat.

The generic term child restraint system

The generic term child restraint system is used in this Owner's Manual. A child restraint system is, for example:

- a baby car seat
- a rearward-facing child seat
- a forward-facing child seat
- a child booster seat – Mercedes-Benz recommends using a child booster seat **with** a backrest and seat belt guide

Observe laws and legal requirements

Always observe the legal requirements when using a child restraint system in the vehicle.

Make sure that the child restraint system is approved in accordance with the valid test specifications and guidelines. Further information can be obtained at a qualified specialist workshop. Mercedes-Benz recommends that you use a Mercedes-Benz Service Centre for this purpose.

Securing systems for child restraint systems in the vehicle

Only use the following securing systems for child restraint systems:

- the ISOFIX/LATCH or i-Size securing rings
- the vehicle's seat belt system
- the Top Tether anchorages

Simply attaching to the ISOFIX/LATCH securing rings or i-Size securing rings on the vehicle can reduce the risk of fitting the child restraint system incorrectly.

When securing a child with the integrated seat belt of the ISOFIX/LATCH or i-Size child restraint system, always comply with the permissible gross

weight for the child and child restraint system (→ page 127).

Important warning notices

Always secure a child restraint system correctly

⚠ WARNING Risk of injury or death due to incorrect installation of the child restraint system

The child can then not be protected or restrained as intended.

- ▶ Be sure to comply with the manufacturer's installation instructions for the child restraint system and its correct use.
- ▶ Make sure that the entire base of the child restraint system always rests on the sitting surface of the seat.
- ▶ Never place objects (e.g. cushions) under or behind the child restraint system.
- ▶ Use child restraint systems only with the original cover designed for them.

▶ Always replace damaged covers with genuine covers.

- Always observe the vehicle-specific information.
 - Fitting an ISOFIX or i-Size child restraint system on the rear seat (→ page 127).
 - Securing the child restraint system with the seat belt (→ page 130).
- Observe the warning labels in the vehicle interior and on the child restraint system.

⚠ WARNING Risk of injury or death due to unsecured child restraint systems in the vehicle

If the child restraint system is incorrectly fitted or not secured, it can become detached.

The child cannot then be protected or restrained as intended.

The unused child restraint system can be become detached and strike vehicle occupants.

- ▶ Always comply with the manufacturer's installation instructions for the child restraint system and its correct use.
- ▶ Always fit child restraint systems correctly, even if they are transported unused in the vehicle.

Do not modify the child restraint system

⚠ WARNING Risk of injury due to modifications to the child restraint system

The child restraint system can no longer function properly. This poses an increased risk of injury.

- ▶ Never modify a child restraint system.
- ▶ Only affix accessories which have been specially approved for this child restraint system by the child restraint system's manufacturer.

Only use child restraint systems which are in proper working condition

⚠ WARNING Risk of injury or death caused by the use of damaged child restraint systems

Child restraint systems or their retaining systems that have been subjected to stress in an accident may not be able to perform their intended protective function.

It may be the case that the child cannot be properly restrained.

- ▶ Always immediately replace child restraint systems that have been damaged or involved in an accident.
- ▶ Have the securing systems for the child restraint systems checked at a qualified specialist workshop before installing a child restraint system again.

Avoid direct sunlight

⚠ WARNING Risk of burns when the child seat is exposed to direct sunlight

If the child restraint system is exposed to direct sunlight or heat, parts could heat up. Children could suffer burns from these parts, particularly on metallic parts of the child restraint system.

- ▶ Always make sure that the child restraint system is not exposed to direct sunlight.
- ▶ Protect the child restraint system with a blanket, for example.
- ▶ If the child restraint system has been exposed to direct sunlight, allow it to cool before securing a child into it.
- ▶ Never leave children unattended in the vehicle.

Observe when stopping or parking

⚠ WARNING Risk of fatal injury due to exposure to extreme heat or cold in the vehicle

If persons, particularly children, are subjected to prolonged exposure to intense heat or cold, there is a risk of severe injury or even death.

- ▶ Never leave persons, particularly children, unattended in the vehicle.

⚠ WARNING Accident- and risk of injury with unsupervised children in the vehicle

If you leave children unattended in the vehicle, they can in particular

- Open doors and thereby endanger other persons or road users.
- get out of the car and are hit by traffic.
- Operate vehicle equipment and become trapped, for example.

In addition, the children could also set the vehicle in motion, for example by:

- releasing the parking brake.
- change the gearbox setting.
- start the vehicle.

- ▶ Never leave children unattended in the vehicle.
- ▶ When leaving the vehicle, always take the SmartKey with you and lock the vehicle.
- ▶ Keep the key out of reach of children.

Overview of warning stickers in the vehicle

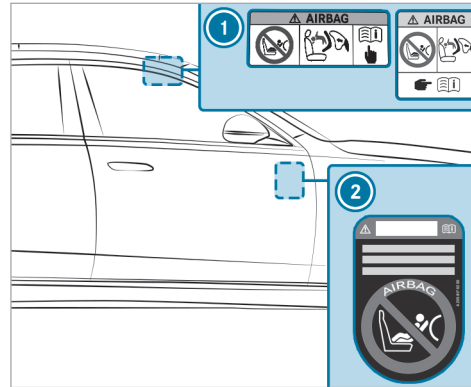

- ① Front passenger airbag warning (on the front passenger sun visor) (→ page 113)
- ② Vehicles without automatic front passenger airbag shutoff warning (visible when the front passenger door is open) (→ page 116)

Notes on rearward-facing and forward-facing child restraint systems on the front passenger seat

⚠ WARNING Risk of injury or death when using a rearward-facing child restraint system while the front passenger airbag is enabled

If you secure a child in a rearward-facing child restraint system on the front passenger seat and the PASSENGER AIR BAG OFF indicator lamp is off, the front passenger airbag can deploy in the event of an accident.

The child could be struck by the airbag.

- ▶ Always ensure that the front passenger airbag is disabled. The PASSENGER AIR BAG OFF indicator lamp must be lit.
- ▶ NEVER use a rearward-facing child restraint system on a seat with an ENABLED FRONT AIRBAG. This can result in the DEATH of or SERIOUS INJURY to the CHILD.

Observe the specific instructions for the rearward-facing and forward-facing child restraint systems (→ page 125).

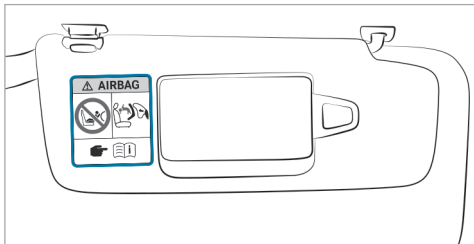

Warning notice on the front passenger sun visor

If it is absolutely necessary to install a child restraint system on the front passenger seat, always observe the additional notes.

- the notes on automatic front passenger airbag shutoff (→ page 97).
- When using a rearward-facing child restraint system on the front passenger seat, the front passenger airbag must always be disabled. This is only the case if the PASSENGER AIR

BAG OFF indicator lamp is lit continuously (→ page 96).

- The front passenger airbag is enabled when the PASSENGER AIR BAG OFF indicator lamp is not lit. The front passenger airbag may be deployed during an accident. In that case, do not use rearward-facing child restraint systems.

Information on the automatic front passenger airbag shutoff

If the front passenger seat is occupied, ensure, both before and during the journey, that the status of the front passenger airbag is correct for the current situation.

⚠ WARNING Risk of injury or death due to objects between the seat surface and the child restraint system

Objects between the seat surface and the child restraint system could affect the function of the automatic co-driver airbag shutoff.

- ▶ Do not place any objects between the seat surface and the child restraint system.
- ▶ Make sure that the entire base of the child restraint system is always resting on the seat surface of the co-driver seat.
- ▶ The backrest of the forward-facing child restraint system must, as far as possible, be resting on the seat backrest of the co-driver seat.
- ▶ It is essential to comply with the child restraint system manufacturer's installation instructions.

When fitting a child restraint system to the front passenger seat, observe the vehicle-specific information (→ page 113).

Rearward-facing child restraint system on the front passenger seat

If a rearward-facing child restraint system is fitted on the front passenger seat, the front passenger airbag must be disabled. The PASSENGER AIR BAG OFF indicator lamp must light up continuously (→ page 96).

⚠ WARNING Risk of injury or death when using a rearward-facing child restraint system while the front passenger airbag is enabled

If you secure a child in a rearward-facing child restraint system on the front passenger seat and the PASSENGER AIR BAG OFF indicator lamp is off, the front passenger airbag can deploy in the event of an accident.

The child could be struck by the airbag.

- ▶ Always ensure that the front passenger airbag is disabled. The PASSENGER AIR BAG OFF indicator lamp must be lit.
- ▶ NEVER use a rearward-facing child restraint system on a seat with an ENABLED FRONT AIRBAG. This can result in the DEATH of or SERIOUS INJURY to the CHILD.

i The front passenger airbag is enabled depending on the child restraint system and the stature of the child. The PASSENGER AIR BAG OFF indicator lamp does not light up.

The front passenger airbag may be deployed during an accident. If the front passenger airbag is in this status, no rearward-facing child restraint system may be fitted on the front passenger seat.

Instead, fit the rearward-facing child restraint system to a suitable rear seat.

Forward-facing child restraint system on the front passenger seat

If a forward-facing child restraint system is fitted on the front passenger seat, the front passenger airbag may be automatically enabled or disabled. The status of the front passenger airbag depends on the child restraint system and the stature of the child.

The PASSENGER AIR BAG OFF indicator lamp is either lit continuously, or it is not lit (→ page 96). Always observe the following information.

⚠ WARNING Risk of injury or death due to incorrect positioning of the child restraint system

If you secure a child in a forward-facing child restraint system on the co-driver seat and you position the co-driver seat too close to the dashboard, in the event of an accident, the child could:

- come into contact with the vehicle's interior if the PASSENGER AIR BAG OFF indicator lamp is lit, for example
- be struck by the airbag if the PASSENGER AIR BAG OFF indicator lamp is off

▶ Always move the co-driver seat as far back as possible. In doing so, always make sure that the shoulder belt strap is correctly routed from the seat belt outlet of the vehicle to the shoulder belt guide on the child restraint system. The shoulder belt strap must be routed forwards and downwards from the seat belt outlet. If necessary, adjust the seat belt outlet and the co-driver seat accordingly.

- ▶ Always comply with the child restraint system manufacturer's installation instructions.

Notes on vehicles without automatic front passenger airbag shutoff

Vehicles without automatic front passenger airbag shutoff have a special sticker affixed to the side of the cockpit on the front passenger side (→ page 113).

Make sure you observe the following information:

- Never fit a rearward-facing child restraint system to the front passenger seat
- Always fit a rearward-facing child restraint system to a suitable rear seat
- Notes on rearward-facing and forward-facing child restraint systems on the front passenger seat (→ page 113)

Suitable child restraint systems for the transport of children

Information on the advantage of a rearward-facing child restraint system

Transport a baby in a suitable rearward-facing child restraint system only. It is also preferable to transport a small child in a suitable rearward-facing child restraint system. In this case, the child sits in the opposite direction to the direction of travel and faces backwards.

Babies and small children have comparatively weak neck muscles in relation to the size and weight of their head. The risk of injury to the cervical spine during an accident can be reduced in a rearward-facing child restraint system.

Approval categories for child restraint systems

Only child restraint systems that meet the following UNECE standards are permitted for use in the vehicle:

- UN-R44
- UN-R129

Identification on the child restraint system

The following information, e.g., is available on the approval label on the child restraint system:

- Approval category
- Child weight group
- Authorisation number
- Child restraint size class

Approval categories in accordance with UN-R44



Example of an approval label

- **Universal:** child restraint systems in the "Universal" category are approved for installation in vehicles. They can be used, in accordance with overviews of the suitability of seats for securing child restraint systems, on seats labelled U, UF or IUF.

The identification IUF refers to ISOFIX child restraint systems in the "Universal" category.

These child restraint systems must also be secured using Top Tether or support points.

- **Semi-Universal:** child restraint systems in the "Semi-Universal" category may only be used if the vehicle and vehicle seat are listed in the child restraint system manufacturer's vehicle model list.
- **Vehicle-specific:** child restraint systems in the "vehicle-specific" category may only be used if the vehicle and vehicle seat are listed in the child restraint system manufacturer's vehicle model list.

Approval categories in accordance with UN-R129

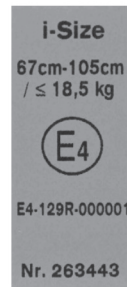

Example of an approval label

- **i-Size** child restraint systems and booster seats with backrest: suitable for attachment to i-Size mounting brackets. They can be used on the seats marked i-U.

Child restraint systems in this category can also be attached to ISOFIX bars if approved by the manufacturer of the child restraint system. i-Size booster seats with backrest can be used

on seats marked U if the seat is approved for category B2/B3.

- Belted child restraint systems and belted booster seats without backrest of the **Universal** category: suitable for attachment to the seats marked U.
- **Vehicle-specific** child restraint systems (ISO-FIX or belted attachment as well as child booster seats with and without backrest): suitable for attachment to the seats marked i-U or U if this is approved by the child restraint system manufacturer.

Observe the suitability of vehicle seats

- Suitability of the seats for attaching ISOFIX child restraint systems (→ page 120)
- Suitability of seats for securing i-Size child restraint systems (→ page 122).
- Suitability of seats for attaching belt-secured child restraint systems (→ page 123)

Overview of recommended child restraint systems

- ① Further information on the correct child restraint system can be obtained at a quali-

fied specialist workshop. Mercedes-Benz recommends that you use a Mercedes-Benz Service Centre for this purpose.

Securing with ISOFIX

Weight category 0+ (up to 13 kg and up to approximately 15 months)

Type ¹	BABY SAFE plus (including base)
Size category	E
Approval	E1 04 301 146
Order number ²	B6 6 86 8224
1 Manufacturer: Britax Römer.	2 With colour code 9H95.

Weight category I (9 to 18 kg and from approximately 9 months to 4 years)

Type ¹	DUO plus
Size category	B1
Approval	E1 04 301 133

Type ¹	DUO plus
Order number ²	A 000 970 43 02
1 Manufacturer: Britax Römer.	2 With colour code 9H95.

Securing with i-Size (R129 child restraint systems)

Weight up to 13 kg, height from 40 to 83 cm, and aged up to about 15 months

Type ¹	Baby Safe 3 i-Size
Size category	R2
Approval	E1 *129R03/04*0060 *02
Order number	A 000 970 68 02
Order number FlexBase iSense	A 000 970 73 02
1 Manufacturer: Britax Römer.	

Weight up to 18 kg, height from 61 to 105 cm, and aged from about 3 months to 4 years

Type ¹	Dualfix 3 i-Size
Size category	F2X/R2
Approval	E1*129R03/04*0060*02
Order number	A000 970 93 02
Order number FlexBase iSense	A000 970 73 02
1 Manufacturer: Britax Römer.	

Weight from 15 to 36 kg, height from 100 to 150 cm, and aged from about 3.5 to 12 years

Type ¹	KIDFIX M i-Size
Size category	B2
Approval	E1*129R03/04*0061*02

Type ¹	KIDFIX M i-Size
Order number	A 000 970 89 02
1 Manufacturer: Britax Römer.	

Weight from 15 to 36 kg, height from 100 to 150 cm, and aged from about 3.5 to 12 years

Type ¹	AMG KIDFIX M i-Size
Size category	B2
Approval	E1*129R03/04*0061*02
Order number	A 000 970 91 02
1 Manufacturer: Britax Römer.	

Securing with the vehicle seat belt

Weight category 0 (up to 10 kg and approximately 6 months) and weight category 0+ (up to 13 kg and approximately 15 months)

Type ¹	BABY SAFE plus II
Approval	E1 04 301 146
Order number ²	A 000 970 38 02
1 Manufacturer: Britax Römer.	2 With colour code 9H95.

R129 child restraint system (weight up to 13 kg, height from 40 to 83 cm, and aged up to about 15 months)

Type ¹	Baby Safe 3 i-Size
Size category	R2
Approval	E1*129R03/04*0060*02
Order number	A 000 970 68 02
1 Manufacturer: Britax Römer.	

Weight category I (9 to 18 kg and from approximately 9 months to 4 years)

Type ¹	DUO plus
Approval	E1 04 301 133
Order number ²	A 000 970 43 02
1 Manufacturer: Britax Römer.	2 With colour code 9H95.

Weight category II/III (15 to 36 kg and from approximately 3 to 12 years)

Type ¹	KIDFIX XP
Approval	E1 04 301 304
Order number ²	A 000 970 49 02
1 Manufacturer: Britax Römer.	2 With colour code 9H95.

Weight category II/III (15 to 36 kg and from approximately 3 to 12 years)

Type ¹	AMG KIDFIX XP
Approval	E1 04 301 304
Order number ²	A 000 970 33 02
1 Manufacturer: Britax Römer.	2 With colour code 9H95.

R129 child restraint systems (weight from 15 to 36 kg, height from 100 to 150 cm, and aged from about 3.5 to 12 years)

Type ¹	KIDFIX M i-Size
Size category	B2
Approval	E1*129R03/04*0061*02
Order number	A 000 970 89 02
1 Manufacturer: Britax Römer.	

R129 child restraint systems (weight from 15 to 36 kg, height from 100 to 150 cm, and aged from about 3.5 to 12 years)

Type ¹	AMG KIDFIX M i-Size
Size category	B2
Approval	E1*129R03/04*0061*02
Order number	A 000 970 91 02
1 Manufacturer: Britax Römer.	

Suitable seats for attaching child restraint systems

Overview of suitability of the seats for attaching ISOFIX child restraint systems

ISOFIX is a standardised securing system for specially designed child restraint systems.



The symbol indicates seats suitable for attaching an ISOFIX child restraint system in accordance with UN R44 (→ page 116).



ISOFIX child restraint systems can also be installed on seats with i-Size markings (→ page 122).

Attach only ISOFIX child restraint systems that are approved in accordance with UN R44 as per the following ISOFIX tables.

Carry cot

Size class – Equipment	Left/right rear seat
F – ISO/L1	X
G – ISO/L2	X
X Not suitable for an ISOFIX child restraint system in this weight group and/or size class.	

Weight group 0 (up to 10 kg and up to approx. 6 months)

Size class – Equipment	Left/right rear seat
E – ISO/R1	IL
IL Suitable for ISOFIX child restraint systems according to the table in "Overview of the recommended child restraint systems", or if the vehicle and the seat are listed on the child restraint system manufacturer's vehicle model list.	

Weight group 0+ (up to 13 kg and up to approx. 15 months)

Size class – Equipment	Left/right rear seat
E – ISO/R1	IL
D – ISO/R2, ISO/R2X	IL

Size class – Equipment	Left/right rear seat
C – ISO/R3	IL (1)
IL Suitable for ISOFIX child restraint systems according to the table in "Overview of the recommended child restraint systems", or if the vehicle and the seat are listed on the child restraint system manufacturer's vehicle model list. (1) When using a child restraint system of size class (ISO/R3), move the front seat into the highest position. Make sure that the seat backrest of the front seat does not rest against the child restraint system.	

Weight group 1 (9–18 kg and approx. 9 months to 4 years)

Size class – Equipment	Left/right rear seat
D – ISO/R2, ISO/R2X	IL
C – ISO/R3	IL (1)
B – ISO/F2	IUF
B1 – ISO/F2X	IUF

Size class – Equipment	Left/right rear seat
A – ISO/F3	IUF
<p>IL Suitable for ISOFIX child restraint systems according to the table in "Overview of the recommended child restraint systems", or if the vehicle and the seat are listed on the child restraint system manufacturer's vehicle model list.</p> <p>IUF Suitable for forward-facing ISOFIX child restraint systems of the "Universal" category in this weight group.</p> <p>(1) When using a child restraint system of size class (ISO/R3), move the front seat into the highest position. Make sure that the seat backrest of the front seat does not rest against the child restraint system.</p>	

Overview of suitability of the seats for attaching i-Size child restraint systems

i-Size is a standardised securing system for specially designed child restraint systems.

 i-Size child restraint systems can be attached to a seat with the i-Size marking (→ page 116).

Child restraint systems that are approved in accordance with the following i-Size table may be attached.

Left and right rear seat

i-Size child restraint systems (ISO/R1, ISO/R2, ISO/R2X, ISO/R3, ISO/F2, ISO/F2X, ISO/F3, ISO/B2, ISO/B3)	i-U
i-U Suitable for forward-facing and rearward-facing i-Size child restraint systems in the "Universal" category.	

Front passenger seat

i-Size child restraint systems (ISO/R1, ISO/R2, ISO/R2X, ISO/R3, ISO/F2, ISO/F2X, ISO/F3, ISO/B2, ISO/B3)	X
X Not suitable for an i-Size child restraint system in the "Universal" category.	

Overview of the suitability of seats for attaching belt-secured child restraint systems

Suitability of seats for attaching belt-secured child restraint systems

Rear seats

Weight category 0: to 10 kg	
Left/right rear seat	U, L
Centre rear seat ¹	U, L
Weight category 0+: to 13 kg	

Left/right rear seat	U, L
Centre rear seat ¹	U, L
Weight category I: 9 to 18 kg	
Left/right rear seat	U, L
Centre rear seat ¹	U, L
Weight category II: 15 to 25 kg	
Left/right rear seat	U, L
Centre rear seat ¹	U, L
Weight category III: 22 to 36 kg	
Left/right rear seat	U, L
Centre rear seat ¹	U, L
UN-R129 child restraint systems	

Left/right rear seat	U, L, B2, B3
Centre rear seat ¹	U, L, B2, B3
1 Child restraint systems with a supporting bracket are not suitable for this seat.	
U Suitable for child restraint systems of the "Universal" category in this weight category.	

L Suitable for semi-universal child restraint systems according to the table in "Recommended child restraint systems", or if the vehicle and the seat are listed in the child restraint system manufacturer's vehicle model list.	
B2, B3 Suitable for the installation of child restraint systems complying with ISO/B2 and ISO/B3 child seat cushion test equipment.	

Notes on child restraint systems on the front passenger seat

- If it is absolutely necessary for you to fit a child restraint system to the front passenger seat, be sure to observe the information on child restraint systems on the front passenger seat (→ page 113).
- Observe the specific instructions for the rearward-facing and forward-facing child restraint

systems. If the front passenger seat is occupied, ensure, both before and during the journey, that the status of the front passenger airbag is correct for the current situation (→ page 96).

Front passenger seat

Weight category 0: to 10 kg	
Front passenger airbag enabled ¹	X
Front passenger airbag disabled ^{1, 2}	U, L
Weight category 0+: to 13 kg	
Front passenger airbag enabled ¹	X
Front passenger airbag disabled ^{1, 2}	U, L
Weight category I: 9 to 18 kg	

Front passenger airbag enabled ¹	UF, L
Front passenger airbag disabled ^{1, 2}	U, L
Weight category II: 15 to 25 kg	
Front passenger airbag enabled ¹	UF, L
Front passenger airbag disabled ^{1, 2}	U, L
Weight category III: 22 to 36 kg	
Front passenger airbag enabled ¹	UF, L
Front passenger airbag disabled ^{1, 2}	U, L
UN-R129 child restraint systems	

Front passenger air-bag enabled ¹	UF, L, B2, B3
Front passenger air-bag disabled ^{1, 2}	U, L, B2, B3
1 Adjust the seat cushion inclination so that the front edge of the seat cushion is in the highest position and the rear edge of the seat cushion is in the lowest position.	
2 The vehicle is equipped with automatic front passenger air-bag shutoff. The PASSENGER AIR BAG OFF indicator lamp must be lit.	
X Not suitable for children in this weight category.	
U Suitable for child restraint systems of the "Universal" category in this weight category.	

L Suitable for semi-universal child restraint systems according to the table in "Recommended child restraint systems", or if the vehicle and the seat are listed in the child restraint system manufacturer's vehicle model list.

UF Suitable for forward-facing child restraint systems of the "Universal" category in this weight category.

B2, B3 Suitable for the installation of child restraint systems complying with ISO/B2 and ISO/B3 child seat cushion test equipment.

Securing the child restraint system



Adjusting the seat correctly

When fitting a child restraint system on the left or right rear seat, always observe the following:

- ▶ Make sure that the child's feet do not touch the front seat. If necessary, move the front seat slightly forwards.

If the head restraint of the child restraint system cannot be fully extended when it is installed in the vehicle, this will result in restrictions on the maximum size setting for certain child restraint systems. Observe the child restraint system manufacturer's installation instructions.

- ⓘ Contact with the roof when the head restraint is fully extended and locked in place will not result in any restrictions on use.

  **When fitting an ISOFIX/LATCH or i-Size child restraint system, also observe the following:**

- ▶ **When using a rearward-facing child restraint system on a rear seat:** adjust the front seat so

that it does not touch the child restraint system.

- ▶ **When using a forward-facing child restraint system with integrated child seat belt:** adjust the head restraint of the respective seat so that it does not push the child restraint system forwards. If necessary, the respective head restraint can be removed. In addition, the backrest of the child restraint system must lie as flat as possible against the backrest of the vehicle seat. After the child restraint system has been removed, replace the vehicle head restraint immediately and adjust correctly.
- ▶ The child restraint system must not be put under strain between the roof and the seat cushion and/or be fitted facing the wrong direction. Where possible, adjust the seat cushion inclination accordingly.
- ▶ Adjust the vehicle head restraints so that the child restraint system is not put under strain by the head restraint.

 **When fitting a belt-secured child restraint system, also observe the following:**

- ▶ **When using a rearward-facing child restraint system on a rear seat:** adjust the front seat so that it does not touch the child restraint system.
- ▶ **When using a forward-facing child restraint system with integrated child seat belt:** adjust the head restraint of the respective seat so that it does not push the child restraint system forwards. If necessary, the respective head restraint can be removed. In addition, the backrest of the child restraint system must lie as flat as possible against the backrest of the vehicle seat. After the child restraint system has been removed, replace the vehicle head restraint immediately and adjust correctly.
- ▶ The backrest of the forward-facing child restraint system must, as far as possible, be resting on the seat backrest of the rear seat.
- ▶ The child restraint system must not be put under strain between the roof and the seat cushion and/or be fitted facing the wrong

direction. Where possible, adjust the seat cushion inclination accordingly.

- ▶ Adjust the vehicle head restraints so that the child restraint system is not put under strain by the head restraint.
- ▶ Make sure that the child's feet do not touch the front seat. If necessary, move the front seat slightly forwards.

 **Depending on the vehicle equipment, always observe the following when fitting a belt-secured child restraint system on the front passenger seat:**

- ▶ Observe the notes on rearward-facing and forward-facing child restraint systems on the front passenger seat (→ page 113).
- ▶ **When using a forward-facing child restraint system integrated child seat belt:** remove the head restraint from the respective seat, if possible. After the child restraint system has been removed, immediately replace the head restraint and adjust correctly.
- ▶ The backrest of the forward-facing child restraint system must, as far as possible, be

resting on the seat backrest of the front passenger seat.

- ▶ The child restraint system must not be put under strain between the roof and the seat cushion and/or be fitted facing the wrong direction.
- ▶ Adjust the vehicle head restraints so that the child restraint system is not put under strain by the head restraint.
- ▶ Never place objects (e.g. cushions) under or behind the child restraint system.
- ▶ Set the front passenger seat as far back as possible and move the seat into the highest position if possible. Always make sure that the shoulder belt strap is correctly routed from the seat belt outlet of the vehicle to the shoulder belt guide on the child restraint system. The shoulder belt strap must be routed forwards from the seat belt outlet and, where possible, downwards to the child restraint system.
- ▶ Fully retract the seat cushion length adjustment.

- ▶ Adjust the seat cushion inclination so that the front edge of the seat cushion is in the highest position and the rear edge of the seat cushion is in the lowest position.
- ▶ Set the seat backrest to the most vertical position possible.

Fitting an ISOFIX or i-Size child restraint system

⚠ WARNING Risk of accident if the rear bench seat, rear seat and seat backrest are not engaged

The rear bench seat, rear seat and seat backrest may fold forwards, even while the vehicle is in motion.

- As a result, the vehicle occupant will be pressed into the seat belt with increased force. The seat belt will not be able to protect as intended and could cause additional injury.
- Objects or loads in the boot or load compartment cannot be restrained by the seat backrest.

- ▶ Make sure that the rear bench seat, the rear seat and the seat backrest are engaged before every trip.

If the rear seat backrest is not engaged and locked in place, the red lock verification indicator will be visible.

⚠ WARNING Risk of injury or death if the permissible gross mass of the child and child restraint system together is exceeded.

Too much load may be placed on the ISOFIX or i-Size child restraint systems and the child may not be restrained correctly in the event of an accident, for example.

- ▶ If the child is secured in an ISOFIX or i-Size child restraint system with integrated seat belts, the total mass of the child and child restraint system must not exceed 33 kg.

Always comply with the information about the weight of the child restraint system:

- in the manufacturer's installation and operating instructions for the child restraint system used
- on a label on the child restraint system, if present

Regularly check that the permissible gross weight of the child and child restraint system is still complied with.

When fitting a child restraint system, observe the following:

- ✓ Always observe the correct use of the seats and consider their suitability for attaching a child restraint system.

 LATCH-type (ISOFIX) securing rings (→ page 120)

or

 i-Size securing rings (→ page 122)

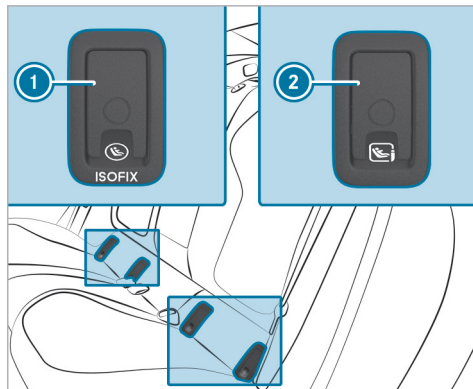

① LATCH-type (ISOFIX) securing rings

② i-Size securing rings

- ▶ Remove and stow away covers ① or ②.
- ▶ Before every journey, make sure that the ISOFIX/LATCH child restraint system or the i-Size child restraint system is engaged correctly in both securing rings in the vehicle.

! **NOTE** Damage to the seat belt for the centre seat during installation of the child restraint system

▶ Make sure that the seat belt is not trapped.

▶ Attach the ISOFIX/LATCH or i-Size child restraint system to both securing rings in the vehicle.

▶ After removing the child seat, reattach covers ① or ②.

Fastening a Top Tether

! **WARNING** Risk of injury or death if the rear seat backrests are not locked after Top Tether belts are fitted

The rear seat backrests may fold forwards when you are driving.

As a result, child restraint systems will no longer be able to perform their intended protective function. This may also cause additional injuries.

- ▶ Always lock rear seat backrests after fitting Top Tether belts.
- ▶ Observe the lock verification indicator.

If the rear seat backrest is not engaged and locked in place, the red lock verification indicator will be visible.

 If the child restraint system is equipped with a Top Tether belt:

The risk of injury may be reduced by Top Tether. The Top Tether belt enables an additional connection between the child restraint system attached with ISOFIX or i-Size and the vehicle.

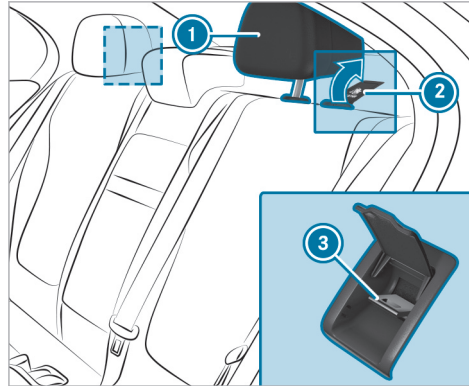

- ▶ If necessary, slide head restraint ① upwards (→ page 178).
- ▶ Fold up cover ② of Top Tether anchorage ③.
- ▶ Fit the ISOFIX or i-Size child restraint system with Top Tether. In doing so, comply with the child restraint system manufacturer's installation instructions.

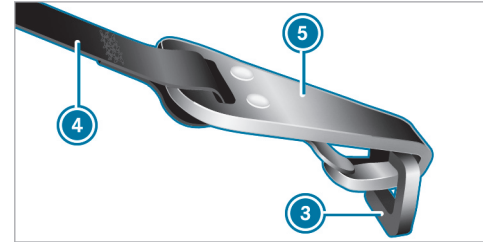

- ▶ Guide Top Tether belt ④ under head restraint ① between the two head restraint bars.
- ▶ Hook Top Tether hook ⑤ of Top Tether belt ④ into Top Tether anchorage ③ without twisting.
- ▶ Tension Top Tether belt ④. In doing so, comply with the child restraint system manufacturer's installation instructions.
- ▶ Fold down cover ② of Top Tether anchorage ③.
- ▶ If necessary, slide head restraint ① downwards (→ page 178). Make sure that you do not interfere with the correct routing of Top Tether belt ④.

Securing the child restraint system with the seat belt

⚠ WARNING Risk of accident if the rear bench seat, rear seat and seat backrest are not engaged

The rear bench seat, rear seat and seat backrest may fold forwards, even while the vehicle is in motion.

- As a result, the vehicle occupant will be pressed into the seat belt with increased force. The seat belt will not be able to protect as intended and could cause additional injury.
- Objects or loads in the boot or load compartment cannot be restrained by the seat backrest.

▶ Make sure that the rear bench seat, the rear seat and the seat backrest are engaged before every trip.

If the rear seat backrest is not engaged and locked in place, the red lock verification indicator will be visible.

▶ For a child restraint system in the "Universal" or "Semi-Universal" category, make sure that the system has been approved for the vehicle seat.

▶ Install the child restraint system. The entire base of the child restraint system must always rest on the sitting surface of the seat.

▶ Always make sure that the shoulder belt strap is correctly routed from the seat belt outlet of the vehicle to the shoulder belt guide on the child restraint system. The shoulder belt strap must be routed forwards from the seat belt outlet and, where possible, downwards to the child restraint system.

▶ **When fitting on the rear seat:** also secure Top Tether if present.

▶ **When fitting on the front passenger seat:** if necessary, adjust the seat belt outlet and the front passenger seat accordingly.

Child safety locks

Activating or deactivating the child safety lock for the rear doors

⚠ WARNING Accident- and risk of injury with unsupervised children in the vehicle

If you leave children unattended in the vehicle, they can in particular

- Open doors and thereby endanger other persons or road users.
- get out of the car and are hit by traffic.
- Operate vehicle equipment and become trapped, for example.

In addition, the children could also set the vehicle in motion, for example by:

- releasing the parking brake.
- change the gearbox setting.
- start the vehicle.

▶ Never leave children unattended in the vehicle.

- ▶ When leaving the vehicle, always take the SmartKey with you and lock the vehicle.
- ▶ Keep the key out of reach of children.

⚠ WARNING Risk of fatal injury due to exposure to extreme heat or cold in the vehicle

If persons, particularly children, are subjected to prolonged exposure to intense heat or cold, there is a risk of severe injury or even death.

- ▶ Never leave persons, particularly children, unattended in the vehicle.

⚠ WARNING Risk of accident and injury due to children left unattended in the vehicle

If children are travelling in the vehicle, they could, in particular:

- open doors, thereby endangering other persons or road users.
- get out and be struck by oncoming traffic.
- operate vehicle equipment and become trapped, for example.

- ▶ Always activate the installed child safety locks if children are travelling in the vehicle.
- ▶ Never leave children unattended in the vehicle.
- ▶ When leaving the vehicle, always take the key with you and lock the vehicle.

Vehicles for the United Kingdom: observe the important safety notes in the "Notes on the additional door lock" section.

There are child safety locks for the rear doors and the rear side windows. The child safety lock on the rear doors secures each door separately. The doors can no longer be opened from the inside.

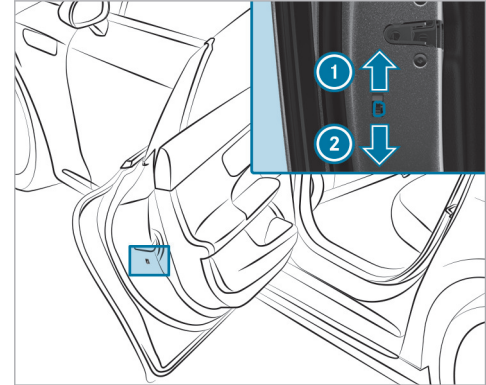

- ▶ Press the lever in direction ① (activate) or ② (deactivate).
- ▶ Check the functionality of the child lock.

Activating and deactivating the child safety lock for the rear side windows

⚠ WARNING Accident- and risk of injury with unsupervised children in the vehicle

If you leave children unattended in the vehicle, they can in particular

- Open doors and thereby endanger other persons or road users.
- get out of the car and are hit by traffic.
- Operate vehicle equipment and become trapped, for example.

In addition, the children could also set the vehicle in motion, for example by:

- releasing the parking brake.
- change the gearbox setting.
- start the vehicle.

- ▶ Never leave children unattended in the vehicle.
- ▶ When leaving the vehicle, always take the SmartKey with you and lock the vehicle.

- ▶ Keep the key out of reach of children.

⚠ WARNING Risk of fatal injury due to exposure to extreme heat or cold in the vehicle

If persons, particularly children, are subjected to prolonged exposure to intense heat or cold, there is a risk of severe injury or even death.

- ▶ Never leave persons, particularly children, unattended in the vehicle.

⚠ WARNING Risk of accident and injury due to children left unattended in the vehicle

If children are travelling in the vehicle, they could, in particular:

- open doors, thereby endangering other persons or road users.
- get out and be struck by oncoming traffic.
- operate vehicle equipment and become trapped, for example.

- ▶ Always activate the installed child safety locks if children are travelling in the vehicle.
- ▶ Never leave children unattended in the vehicle.
- ▶ When leaving the vehicle, always take the key with you and lock the vehicle.

Vehicles for the United Kingdom: observe the important safety notes in the "Notes on the additional door lock" section.

There are child safety locks for the rear doors and the rear side windows.

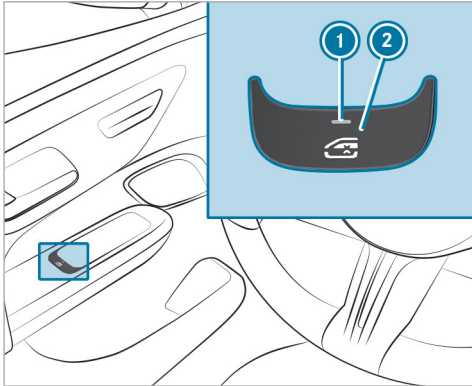

▶ **To activate/deactivate:** press button ②.

The rear side window can be opened or closed in the following cases:

- The indicator lamp ① is lit: via the switch on the driver's door
- The indicator lamp ① is off: via the switch on the corresponding rear door or driver's door

Occupant presence reminder

Function of the occupant presence reminder

The occupant presence reminder can help to remind you about a child who may have been forgotten in the rear compartment of the vehicle. It activates and deactivates automatically when the rear door is open for an extended period of time and a child, which the system presumes to be present, could enter or exit the vehicle.

When the vehicle is switched off, the **Do not leave persons or animals in the vehicle** message appears on the driver's display if the system was already automatically activated.

You can permanently deactivate the function in the multimedia system (→ page 133). When the system is deactivated, the  indicator lamp in the driver's display lights up.

Activating or deactivating the occupant presence reminder in the multimedia system

Multimedia system:

- ▶  **Settings** ▶ **Vehicle**
- ▶ **Occupant protection**
- ▶ Activate or deactivate the function.

Key

Overview of key functions

! WARNING Accident- and risk of injury with unsupervised children in the vehicle

If you leave children unattended in the vehicle, they can in particular

- Open doors and thereby endanger other persons or road users.
- get out of the car and are hit by traffic.
- Operate vehicle equipment and become trapped, foreexample.

In addition, the children could also set the vehicle in motion, for example by:

- releasing the parking brake.
- change the gearbox setting.
- start the vehicle.

▶ Never leave children unattended in the vehicle.

- ▶ When leaving the vehicle, always take the SmartKey with you and lock the vehicle.
- ▶ Keep the key out of reach of children.

This also applies to the Digital Vehicle Key.

! NOTE Damage to the key caused by magnetic fields

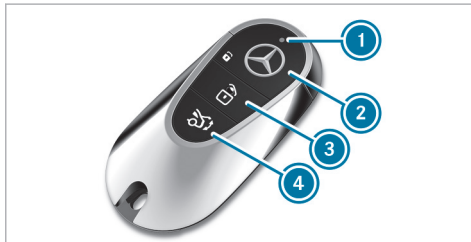

- ▶ Keep the key away from strong magnetic fields.





Vehicle key

- ① Indicator lamp
- ② Locking

- ③ Unlocks (with embossed surface)
- ④ Opens/closes the boot lid

i If indicator lamp ① does not light up after pressing the  or  button, the battery is weak or possibly discharged. Replace the battery as soon as possible.

Replace the key battery (→ page 136).

i **Vehicles with comfort doors:** If you have switched on the **Comfort doors** function in the multimedia system (→ page 152), you can open or close the driver's or front passenger's door by pressing the  or  button. Additional information on the convenience doors (→ page 148).

The key locks and unlocks the following components:

- Doors
- Socket flap
- Boot lid

If the vehicle is not opened within approximately 40 seconds after unlocking, it locks again. Anti-theft protection is primed again.

Do not keep the key together with electronic devices or metal objects. This can affect the key's functionality.

Activating/deactivating the acoustic locking verification signal

Multimedia system:

→  ► Settings ► Vehicle
► Open/close

► Activate or deactivate the **Acoustic lock**.



Please observe:

The selected setting for the acoustic locking verification signal must comply with the relevant national road and traffic regulations. In some countries, including Germany, using the acoustic locking verification signal is forbidden by traffic laws (in accordance with §16 Para. 1 and §30 Para. 1 of the German national road traffic regulations). The driver of the vehicle must comply with these regulations. In countries where the use of this function is forbidden, this function is not activated in the vehicle and must not be activated.

Changing the unlocking settings

Possible unlocking functions of the key:

- Central unlocking
- Unlocking the driver's door and socket flap

► **To switch between settings:** press the  and  buttons simultaneously for approximately six seconds until the indicator lamp flashes twice.

Options if the unlocking function for the driver's door and socket flap has been selected:

- **To unlock the vehicle centrally:** press the  button twice.
- **Vehicles with KEYLESS-GO:** if you touch the inner surface of the door handle on the driver's door, only the driver's door and the socket flap are unlocked.



Deactivating the key function

If you deactivate the key function, the KEYLESS-GO functions are also deactivated. With that key, access or drive authorization by KEYLESS-GO is no longer possible. Activate the function of the

key so that all its functions will again be available. You can also deactivate the key's function to reduce the key's energy consumption if you do not use the vehicle or a key for an extended period of time.

If you do not use the vehicle or a key for an extended period, you can also deactivate the key's function to reduce the key's energy consumption.

► Press and hold the key button .

► With the key button  pressed, immediately press the key button  twice in quick succession.

The indicator light of the key lights up once briefly and once for a long time.

 You have the following options to reactivate the key:

- Press any key on the key.
- Start the vehicle with the key in the centre console storage compartment. (→ page 256).

Removing/inserting the emergency key

Removing the emergency key

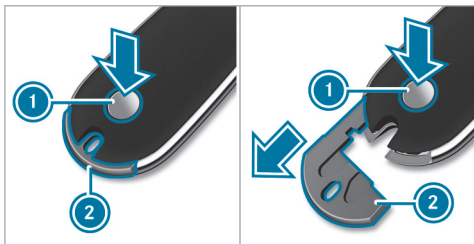

- ▶ Press the release button ①. The emergency key ② is pushed out slightly.
- ▶ Fully remove the emergency key ②.

Inserting the emergency key

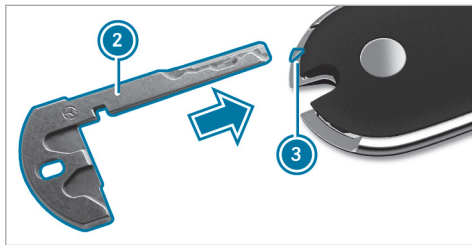

- ▶ Insert the emergency key ② at marking ③ until it engages.
- ⓘ You can use the emergency key ② to attach the key to a key ring.

Replacing the key battery

⚠ DANGER Risk of fatal injuries due to swallowing batteries

Batteries contain toxic and corrosive substances. If batteries are swallowed or otherwise

enter the body, severe internal burns can occur within two hours.

There is a risk of fatal injury.

- ▶ Keep batteries out of the reach of children.
- ▶ If the battery compartment cover and/or lid do not close securely, stop using the key and keep it away from children.
- ▶ If batteries are swallowed or otherwise enter the body, seek immediate medical attention.



ENVIRONMENTAL NOTE Environmental damage due to improper disposal of batteries



Batteries contain pollutants. It is illegal to dispose of them with the household rubbish.



Dispose of batteries in an environmentally responsible manner. Take discharged batteries to a qualified specialist workshop or to a collection point for used batteries.

Requirements

- You require a CR 2032 3 V cell battery.

Mercedes-Benz recommends that you have the battery replaced at a qualified specialist workshop.

- Remove the emergency key (→ page 136).

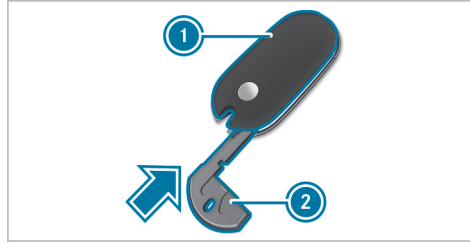

- Press emergency key (2) into the opening in the key in the direction of the arrow until cover (1) opens. When doing so, do not hold cover (1) closed.

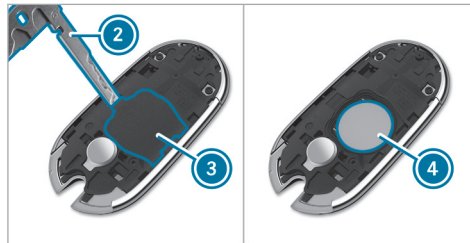

- Insert emergency key (2) into the opening and lift up covering (3) and remove it.
- Repeatedly tap the key against your palm until battery (4) falls out of the key.
- Insert the new battery with the positive pole facing upwards. Use a lint-free cloth to do so.
- Make sure that the surface of the battery is free of lint, grease and other impurities.
- Insert the front tabs of covering (3) into the housing and then press on both sides to close it.
- Make sure that covering (3) is completely closed.
- Insert the front tabs of cover (1) into the housing and then press until it is completely closed.
- Insert the emergency key again (→ page 136).

Problems with the key, troubleshooting

You can no longer lock or unlock the vehicle

Possible causes:

- The key battery is weak or discharged.
- ▶ Check the battery using the indicator lamp (→ page 134).
- ▶ Replace the key battery, if necessary (→ page 136).
- ▶ Use the replacement key.
- ▶ Use the emergency key to lock or unlock (→ page 153).
- ▶ Have key checked at a qualified specialist workshop.

There is interference from a powerful radio signal source

Possible causes if the function of the key is impaired:

- high voltage power lines
- mobile phones
- electronic devices (notebooks, tablets)

- shielding due to metal objects or induction loops for electrical gate systems or automatic barriers

▶ Make sure that there is sufficient distance between the key and the potential source of interference.

You have lost a key

- ▶ Have the key deactivated at a qualified specialist workshop.
- ▶ If necessary, have the mechanical lock replaced as well.

Digital Vehicle Key

Function of the Digital Vehicle Key

If you have activated a suitable terminal device, e.g. a smartphone, as a digital vehicle key, you can use it like a conventional vehicle key.

For information on setting up a user account and activating the "Digital Vehicle Key" service, visit <https://www.mercedes.me>.

The Digital Vehicle Key can then be used for the following functions:

- Locking/unlocking the vehicle with KEYLESS-GO (→ page 145)
- Locking and unlocking the vehicle with the NFC function (→ page 142)
- HANDS-FREE ACCESS function (→ page 158)
- Convenience closing (closing the vehicle from outside) (→ page 163)
- Anti-theft protection (→ page 168)
- Starting the vehicle (→ page 253) or parking (→ page 297)
- Starting the vehicle with the digital vehicle key in the storage compartment (emergency mode) (→ page 255)

Set up and manage the digital vehicle key:

- Registering the digital vehicle key (→ page 139)
- Manage digital vehicle key (→ page 140)
- Remove digital vehicle key (→ page 141)

- Unlocking and locking the vehicle with the digital vehicle key (→ page 142)
- Changing the Unlocking Settings for the Digital Vehicle Key (→ page 143)
- Fixing Problems with the Digital Vehicle Key (→ page 143)

Setting up the digital vehicle key

Requirements

- Create a Mercedes me user account at <https://www.mercedes.me>.
- The Mercedes me app is installed on the end device (optional).
- You have received an email from Mercedes me connect.
If you have selected the "Digital Vehicle Key" equipment, you will receive an email with information on how to set up the digital vehicle key.
- Bluetooth® is switched on at the end device and the vehicle.
- The terminal is sufficiently charged.

You have the following options for setting up a terminal as a digital vehicle key:

- via Mercedes me app
- by e-mail
- via MBUX multimedia system

Set up via the Mercedes me app

- ▶ Start the Mercedes me app.
- ▶ Select the "Digital vehicle key" menu.
- ▶ Follow the steps in the Mercedes me app.

When the message "Add key and pair with vehicle" appears:

- ▶ Place the terminal in the tray (→ page 255).
- ▶ Follow the action steps on the terminal. Your Digital Vehicle Key is now stored in your end device's Wallet-App.

Set up by e-mail

- ▶ Open the e-mail from Mercedes me connect.
- ▶ Follow the displayed action steps as described in the email. Your Digital Vehicle Key is now stored in your end device's Wallet-App.

or

- ▶ Open the link in the e-mail with the end device you want to use as a digital vehicle key.
- ▶ Follow the action steps on the terminal. **When the message "Add key and pair with vehicle" appears:**
- ▶ Place the terminal in the tray (→ page 255).
- ▶ Follow the action steps on the terminal. Your Digital Vehicle Key is now stored in your end device's Wallet-App.

or

- ▶ Set up the terminal on the vehicle.
- ▶ Place the terminal in the tray (→ page 255). Mercedes-Benz Digital Vehicle Key" is displayed on the terminal device.
- ▶ Press "Enter code". The display for entering the code appears.
- ▶ Enter the 8-digit code displayed in the e-mail. **When the message "Add key and pair with vehicle" appears:**
- ▶ Follow the action steps on the terminal. Your Digital Vehicle Key is now stored in your end device's Wallet-App.

Set up via MBUX multimedia system

- ▶ Select the menus in the multimedia system **Settings, Vehicle, Open/close**.
- ▶ Select **Digital Vehicle Key** menu.
- ▶ Follow the action steps in the multimedia system.
Your Digital Vehicle Key is now stored in your end device's Wallet-App.
- ❗ You can now use the digital vehicle key like the conventional one (→ page 142).
- ❗ Set up and manage the digital vehicle key:
 - Function (→ page 138)
 - Managing (→ page 140)
 - Remove (→ page 141)
 - Changing the Unlocking Settings for the Digital Vehicle Key (→ page 143)

Manage digital vehicle key

Requirements

- A suitable end device is activated as a Digital Vehicle Key.

- Bluetooth® is switched on at the end device (with the activated digital vehicle key) and the vehicle.
- The terminal is sufficiently charged.

You have the following options for managing a digital vehicle key:

- Switch express mode (comfort mode) off or on
- Set up other devices of family members or friends as digital vehicle keys.
- Setting up permissions for the digital vehicle keys

Switch express mode off or on

- ▶ Open the Wallet-App on the end device.
- ▶ Switch express mode off or on.
- ❗ Express mode is switched on by default. This setting allows you to make the best possible use of the Digital Vehicle Key.
If the express mode is off and the battery of the terminal is very low, you can no longer unlock the vehicle via the NFC function.

Only switch off the express mode if you do not want to use the Digital Vehicle Key function.

Setting up other terminals as digital vehicle keys

- ▶ Open the Wallet-App on the end device.
- ▶ Select the menu "Invite people to use your Mercedes-Benz key".
- ▶ Follow the action steps on the terminal.

Setting up permissions for the digital vehicle keys

You can assign the following authorisations to the Digital Vehicle Keys:

- Vehicle access and driving authorisation
- Vehicle access authorisation
- ▶ Open the Wallet-App on the end device.
- ▶ Select the menu "Invite people to use your Mercedes-Benz key".
- ▶ Select the "Configure car key access" menu.
- ▶ Follow the action steps on the terminal.
- ❗ Further information on the digital vehicle key:
 - Function (→ page 138)

- Setting up (→ page 139)
- Remove (→ page 141)
- Changing the Unlocking Settings for the Digital Vehicle Key (→ page 143)

Remove digital vehicle key

Requirements

- A suitable end device is activated as a Digital Vehicle Key.
- Bluetooth® is switched on at the end device (with the activated digital vehicle key) and the vehicle.
- The terminal is sufficiently charged.

You have the following options for removing a digital vehicle key:

- via the Wallet-App
- via iCloud
- via Mercedes me user account
- via MBUX multimedia system

i You can remove individual users or remove your digital vehicle key from the terminal.

Remove via Wallet-App

- ▶ Open the Wallet-App on the end device.
- ▶ Select the user whose Digital Vehicle Key is to be removed.
- ▶ Follow the action steps on the terminal. The selected Digital Vehicle Key is removed and can no longer be used.

Remove via iCloud

- ▶ Log in to iCloud.
- ▶ Follow the action steps. The selected Digital Vehicle Key is removed and can no longer be used.

Remove via Mercedes me user account

The following options are available:

- Remove the linked vehicle
- object to the terms of use and consents
- Delete the user account
- ▶ Log in to the Mercedes me user account.
- ▶ Select one of the above options. The selected Digital Vehicle Key is removed and can no longer be used.

Remove via MBUX multimedia system

The following options are available:

- Disconnect all digital vehicle keys
- Change the Digital Vehicle Key of the main owner
- Disconnect the owner's Digital Vehicle Key
- Remove a digital vehicle key
- ▶ Select the menus in the multimedia system **Settings, Vehicle, Open/close**.
- ▶ Select **Digital Vehicle Key** menu.
- ▶ Select one of the above options.
- ▶ Follow the action steps in the multimedia system. The selected Digital Vehicle Key is removed and can no longer be used.
- i** Further information on the digital vehicle key:
 - Function (→ page 138)
 - Setting up (→ page 139)
 - Managing (→ page 140)
 - Changing the Unlocking Settings for the Digital Vehicle Key (→ page 143)

Unlocking and locking the vehicle with the digital vehicle key

Requirements

- The "Digital Vehicle Key" function is activated via Mercedes me: <https://www.mercedes.me>.
 - A suitable end device is activated as a Digital Vehicle Key.
 - Bluetooth® is switched on at the end device and the vehicle.
 - The terminal is sufficiently charged.
- i** If the connection via Bluetooth® is disturbed or the battery of the Digital Vehicle Key is very low, you can also lock and unlock the vehicle via the NFC function or start (→ page 255). Depending on the terminal device, you can continue to use the KEYLESS-GO function for a certain time even if the battery of the digital vehicle key is very low.

The Digital Vehicle Key can be used for the following functions:

- Locking and unlocking the vehicle with the NFC function

- Locking/unlocking the vehicle with KEYLESS-GO (→ page 145)
 - HANDS-FREE ACCESS function (→ page 158)
 - Convenience closing (closing the vehicle from outside) (→ page 163)
 - Anti-theft protection (→ page 168)
 - Starting the vehicle (→ page 253) or parking (→ page 297)
 - Start the vehicle with the Digital Vehicle Key in the marked space (emergency operation mode) (→ page 255)
- i** Mercedes-Benz recommends that you carry the emergency key (→ page 136) in case of function restrictions.
- i** Mercedes-Benz recommends placing the Digital Vehicle Key in the storage compartment while driving (→ page 255).

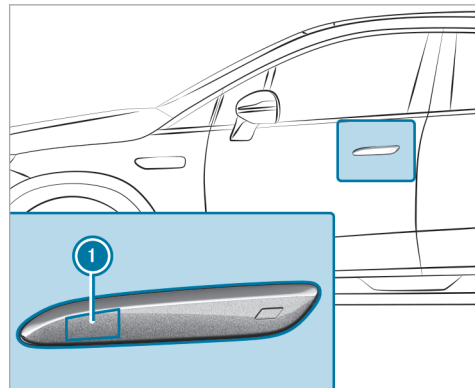

▶ **Lock and unlock the vehicle with the NFC function:** Hold the digital vehicle key against the door handle in the area of the NFC antenna **1**.

Changing the Unlocking Settings for the Digital Vehicle Key

Multimedia system:

- Settings ▶▶ Vehicle
 ▶▶ Open/close

Set selective or global unlocking

- ▶ **Unlock driver's door only** .
 Selective unlocking is activated. If this function is deactivated, the owner key unlocks the entire vehicle.

Fixing Problems with the Digital Vehicle Key

You can no longer lock and unlock the vehicle with the Digital Vehicle Key.

Possible causes:

- Bluetooth® is switched off on the Digital Vehicle Key or the vehicle.
 - The battery of the Digital Vehicle Key is low or empty.
- ▶ Switch on Bluetooth® on the digital vehicle key or the vehicle.

- ▶ Check the charge level of the Digital Vehicle Key battery.
- ▶ If necessary, charge the battery of the Digital Vehicle Key.
- ▶ Use the NFC function of the digital vehicle key to lock or unlock the vehicle. (→ page 142).
- ▶ Use the vehicle key.
- ▶ Use the emergency key to lock or unlock (→ page 153).
- ▶ Have the vehicle and the Digital Vehicle Key checked at a qualified specialist workshop.

There is interference from a powerful radio signal source

Possible causes of Digital Vehicle Key impairment:

- high voltage power lines
- mobile phones
- electronic devices (notebooks, tablets)
- shielding due to metal objects or induction loops for electrical gate systems or automatic barriers

- ▶ Ensure the sufficient distance between the Digital Vehicle Key and a potential source of interference.

You have lost a Digital Vehicle Key.

- ▶ Remove the Digital Vehicle Key (→ page 141).

Doors

Notes on the additional door lock

The additional door lock is only available for vehicles for the United Kingdom.

⚠ WARNING Risk of injury to persons inside the vehicle when the additional door lock is activated

If the additional door lock is activated, the doors can no longer be opened from the inside.

- ▶ Never leave persons, in particular children, unattended in the vehicle.
- ▶ If there are persons in the vehicle, do not activate the additional door lock.

The additional door lock is automatically activated in the following situations:

- The vehicle is locked using the key.
- The vehicle is locked using KEYLESS-GO.

If the vehicle has been locked via Mercedes me connect, the additional door lock is not activated (→ page 549).

If the additional door lock is activated, the doors cannot be opened from the inside.

i After locking you can issue a signal with the horn.

You can prevent the additional door lock from being activated by deactivating interior protection before locking the vehicle (→ page 170).

Unlocking/opening the doors from the inside

▶ **United Kingdom only:** observe the notes on the additional door lock (→ page 143).

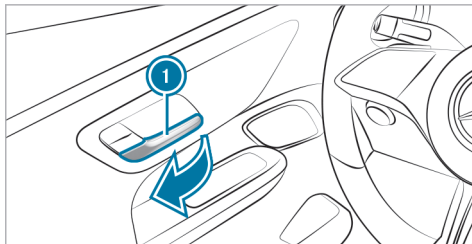

▶ Pull the door **1** handle.

Centrally locking and unlocking the vehicle from the inside

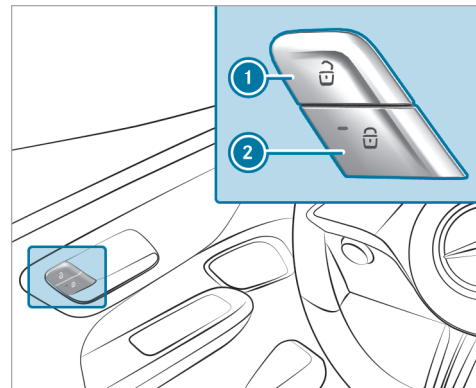

▶ **To unlock:** press **1** button.

▶ **To lock:** press button **2**.
The red indicator lamp on button **2** lights up once the vehicle is locked.

The socket flap is also locked and unlocked. The socket flap can be opened even if a key is detected in the car.

The vehicle is not unlocked:

- if you have locked the vehicle using the key
- if you have locked the vehicle using KEYLESS-GO

Recessed door handles extend or retract

The door handles extend automatically:

- when you unlock the vehicle with the key
- if you touch one of the two outer sensor surfaces of the door handle (when the vehicle is unlocked)

The door handles retract automatically:

- when you lock the vehicle with the key
- when pulling away
- after waiting for a time

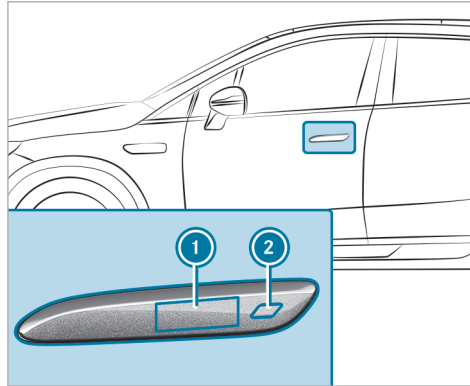

▶ **To extend the door handle:** Touch the external sensor surface ① or ②.

▶ **If the vehicle has been locked automatically and another person wants to get in:** To unlock the vehicle, press the button on the driver's door (→ page 144). The door handles extend.

Locking/unlocking the vehicle with KEYLESS-GO

Requirements

- The key is outside the vehicle.
- The distance between the key and the vehicle does not exceed 1 m.
- The driver's door and the door on which the door handle is used are closed.

ⓘ **Vehicles with Digital Vehicle Key:** You can use the Digital Vehicle Key like the conventional vehicle key.

The door handles extend automatically:

- when a vehicle key is detected (the vehicle is then not yet unlocked)
- when you unlock the vehicle with the key
- if you touch one of the two outer sensor surfaces of the door handle (when the vehicle is unlocked)

The door handles retract automatically:

- when you lock the vehicle with the key
- when you touch one of the two outer sensor surfaces of the door handle to lock it

- after comfort locking (→ page 163)
- when pulling away
- after waiting for a time

! **NOTE** Damage to the vehicle caused by unintentionally opening the boot lid or a door

- when using an automatic car wash
- when using a high pressure cleaner

▶ Deactivate the function of the key in these situations.

or

▶ Make sure that the key is at a minimum distance of 3 m (high-pressure cleaner) or 6 m (automatic car wash) away from the vehicle.

! **NOTE** Vehicle damage due to unintentional opening of the boot lid or a door

- when using an automatic car wash
- when using a high pressure cleaner

▶ In these situations, switch off the Digital Vehicle Key.

or

▶ Make sure the key is at least 3 m (pressure washer) or 6 m (car wash) away from the vehicle.

Observe the notes:

- on washing the vehicle in a car wash (→ page 25)
- on using a high-pressure cleaner (→ page 601)

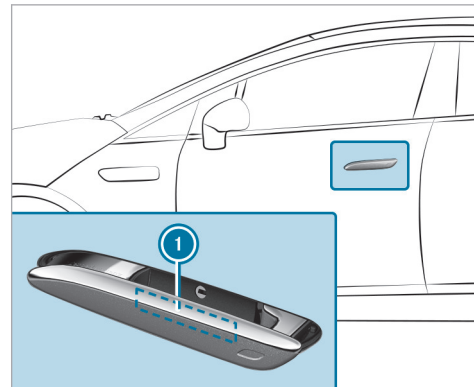

▶ **Unlocking the vehicle:** With the door handle extended, touch the inside surface **1** of the door handle.

Vehicles with digital vehicle key:

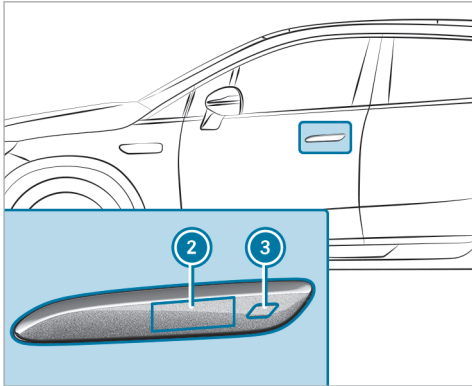

- ▶ **When the vehicle is unlocked:** touch the sensor surface ② or ③ to move the door out.
- ▶ **When the vehicle is locked:** touch the sensor surface ② or ③ to unlock.
- ▶ **To lock the vehicle:** Touch the sensor surface ② or ③.
- ▶ **Convenience closing:** touch recessed sensor surface ③ for an extended period.

i Further information on convenience closing (→ page 163).

You can watch an animation on this topic via the following link:

Problems with KEYLESS-GO, troubleshooting

You can no longer lock or unlock the vehicle using KEYLESS-GO

Possible causes:

- The function of the key has been deactivated.
 - The key battery is weak or discharged.
- ▶ Activate the function of the key (→ page 55).
 - ▶ Check the battery using the indicator lamp (→ page 134).
 - ▶ Replace the key battery, if necessary (→ page 136).
 - ▶ Use the replacement key.
 - ▶ Use the emergency key to lock or unlock (→ page 153).
 - ▶ Have the vehicle and key checked at a qualified specialist workshop.

There is interference from a powerful radio signal source

Possible causes if the function of KEYLESS-GO is impaired:

- high voltage power lines
- mobile phones
- electronic devices (notebooks, tablets)
- shielding due to metal objects or induction loops for electrical gate systems or automatic barriers

▶ Make sure that there is sufficient distance between the key and the potential source of interference.

Activating or deactivating the automatic locking feature

Multimedia system:

➔  ➔ Settings ➔ Vehicle
 ➔ Open/close

i The vehicle is locked automatically when the vehicle is switched on, and the wheels are turning faster than the walking pace.

▶ Activate or deactivate **Automatic locking**.



In the following situations, there is a danger of being locked out when the function is activated:

- The vehicle is being towed or pushed.
- If the vehicle is being tested on a roller dynamometer.

Opening and closing the front convenience doors

⚠ WARNING Risk of entrapment when automatically closing the comfort doors at the front

Parts of the body could get trapped. People or animals may be in the locking area.

- ▶ Ensure that no one is near the closing area.
- ▶ Use one of the following options to stop the closing process:
 - Press the button  or  on the key.
 - Driver's door: Step on the brake pedal.

- Pull the inner or outer door handles.
- Push against the door or pull on the door.
- Select the Cancel operation display in the multimedia system's Comfort menu.

! **NOTE** Risk of an accident when automatically opening and closing the comfort doors at the front

The view of the surroundings may be limited.

- ▶ Ensure that there are no persons, animals or objects in the swing area of the comfort doors when opening or closing them.
- ▶ When opening, pay particular attention to low objects and obstacles in the swing range of the comfort doors.
- ▶ When opening, pay particular attention to objects and obstacles in the area of the side windows.

Opening or closing the front convenience doors

The following functions are required to automatically open and close the front convenience doors:

- KEYLESS-GO (→ page 145)
- Power closing function
- Parking Package with 360° Camera (→ page 366)
or
Remote Parking Assist with Mirror Package (→ page 382)
- Active Blind Spot Assist (→ page 350)

The convenience doors can then be opened and closed automatically.

i If Active Blind Spot Assist is deactivated or unavailable, the convenience doors cannot be opened from inside.

The following options are available for opening or closing the front convenience doors:



- the key (to open and close)
- approaching the vehicle (to open the driver's door)

- depressing the brake pedal (to close the driver's door)
- the inner front door handles (to open and close)
- the outer front door handles (close)
- the multimedia system (→ page 152)

Special features of the front convenience doors:

- If, when closing, the front door has reached the first detent position, the power closing function will automatically draw the door into the lock.

▶ **Open with the key :** Press and hold the  button until the door starts to open.

- ⓘ In the multimedia system, you can set whether the driver's door, the front passenger door or no door opens when you press the  button on the key (→ page 152). The convenience opening function is carried out if no front door opens when the  button is pressed. The convenience opening function opens, for example, the side windows and the panoramic sliding sunroof. Further

information on convenience opening (→ page 162).

▶ **To close with the key:** Press and hold the key button  until the door starts to close. Both open front doors close.

▶ **Comfort locking with the key:** Press and hold the key button . All open front doors, side windows and the panoramic sliding sunroof close.

- ⓘ Press the  button on the key again to lock the vehicle.

To open the vehicle by approaching it:

! **NOTE** Vehicle damage due to unintentional opening of a door

- When passing the vehicle
 - when using an automatic car wash
 - when using a high pressure cleaner
- ▶ In these situations, deactivate the function of the key.

- ⓘ Comfort doors Deactivating with the washer mode (→ page 601).

When you approach your vehicle, and the key is detected, the vehicle is unlocked, and the driver's door opens automatically.

▶ Set the function in the multimedia system (→ page 152).

To close the driver's door with the brake pedal:

▶ Depress the brake pedal until the door starts to close.

To open or close the front convenience doors from inside:

▶ Pull and hold the door handle until the door starts to open (→ page 144).

- ⓘ The opening or closing process stops when you pull the door handle during automatic operation. If you pull the door handle again, the process continues in reverse order.

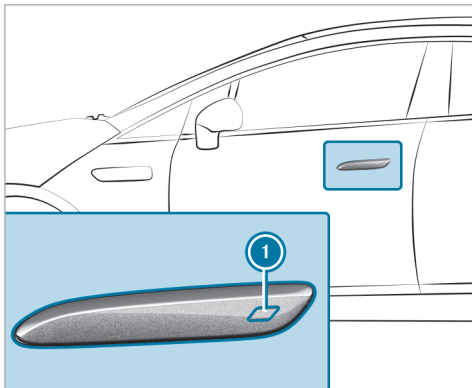

- ▶ To close the front convenience doors from outside: touch the recessed sensor surface ① on the door handle.

Object detection

Object detection uses several sensors to monitor the opening range of convenience doors to detect objects. If one of the sensors detects an object, the convenience doors are stopped, and a warning is displayed in the multimedia system.

- ▶ Manually open a door stopped in an intermediate position.

Even if the convenience doors are equipped with sensors, it cannot be guaranteed that all objects are detected. Object detection is only an aid and is not a substitute for the attention of the vehicle occupants to their immediate surroundings when opening and closing the convenience doors. The vehicle occupants are always responsible for opening and closing the doors safely.

Detection range of the sensors

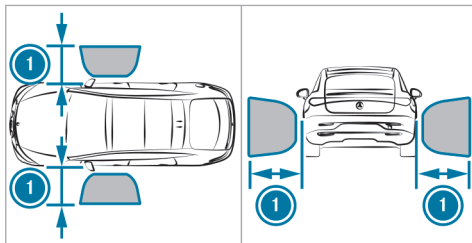

- ① approximately 1 m

- ! **NOTE** Danger of accidents due to objects in the vicinity

Object detection may not recognise certain objects at close range.

- ▶ When opening, pay particular attention to low objects and obstacles in the swing range of the comfort doors.
- ▶ When opening, pay particular attention to objects and obstacles in the area of the side windows. Object detection does not always recognise such objects at close range, especially during movement. The vehicle or other objects may otherwise be damaged.

- ! **NOTE** Risk of accident due to faulty sensors

The sensors may malfunction because of snow or due to objects that absorb ultrasonic waves.

- ▶ Make sure that the convenience doors are free from dirt, ice or slush.
- ▶ Be especially careful when opening the convenience doors if other ultrasonic sources are nearby.

! **NOTE** Risk of accidents if the detection performance of the sensors in the convenience doors is restricted

If the sensors are covered, the convenience doors cannot function reliably.

- ▶ Do not apply stickers, foils or other coatings to the outside of the convenience doors.
The sensors may otherwise be blocked and obstacles may not be detected or only detected to a limited extent.

Exit warning when opening the front doors from inside

The exit warning of Active Blind Spot Assist is used as an additional safeguard. If an obstacle is detected, the convenience function is deactivated, and the moving door will be stopped.

- ▶ Manually open a door stopped in an intermediate position.

! **WARNING** Risk of accident despite exit warning

The exit warning neither reacts to stationary objects nor to persons or road users approaching you at a greatly differing speed. The exit warning cannot warn drivers in these situations.

- ▶ Always pay particular attention to the traffic situation when opening the doors and make sure there is sufficient clearance.

The exit warning is only an aid and not a substitute for the attention of vehicle occupants. The responsibility for opening and closing the doors and leaving the vehicle remains with the occupants.

- i** Further information on Active Blind Spot Assist with exit warning (→ page 350).

Blockage detection when opening the front doors

Blockage detection will stop the door if an obstacle obstructs a door during the automatic opening process. The automatic blockage detection function is only an aid, not a substitute for your attentiveness.

- ▶ Manually open a door stopped in an intermediate position.

! **NOTE** Damage to the convenience doors despite blockage detection

Blockage detection may not be able to stop the automatic opening process of the doors in all cases. This can be the case in particular with light, soft objects.

- ▶ Therefore, make sure that there is sufficient clearance next to the vehicle.

Automatic reversing function when closing the front doors

The doors are equipped with automatic blockage detection with a reversing function. If an obstacle stops a door during the automatic closing process, it will automatically open again. The auto-

matic reversing function is only an aid, not a substitute for your attentiveness.



- ▶ During the closing process, ensure no body parts are in the area.

⚠ WARNING Risk of becoming trapped despite reversing function

The reversing function does not react:

- on soft, light and thin objects, e.g. fingers
- towards the end of the closing process

In particular, the reversing function cannot prevent someone from being trapped.

- ▶ Ensure that no body parts are in the closing area.
- ▶ If someone is trapped, use one of the following options:
 - Press the button  or  on the key.
 - Driver's door: Step on the brake pedal.
 - Pull the inner or outer door handles.

- Push against the door or pull on the door.
- Select the Cancel operation display in the multimedia system's Comfort menu.

You can watch an animation on this topic via the following link:

[Setting convenience doors](#)

Multimedia system:

  **▶▶ Settings ▶▶ Vehicle ▶▶ Comfort**

- ▶ Activate or deactivate **Comfort doors**.

Operating convenience doors

- ▶ Select .
- ▶ Select **Open door control**.
The menu for operating the doors opens. The doors can be opened or closed by sliding the control element in the central display.

- ▶ Select **Cancel process**.
The procedure is interrupted, and the door remains in the position it has reached.
- ▶ Press and hold **Close all**.
All doors are closed simultaneously.

Setting the key function for the convenience doors

- ▶ Select .
- ▶ Select **Key assignment**.
Convenience opening, windows, Front door, rightopen or **Front door, leftopen** are separately adjustable for operation by key.

Door opening on approach

- ▶ Activate or deactivate the function.
When the function is activated, the driver's door opens automatically when the vehicle is approached.

Warning of obstacles in the door area

- ▶ Activate or deactivate the function.
The vehicle warns you of obstacles in the door area with acoustic feedback and a graphic display.

Locking/unlocking the vehicle with the emergency key

Unlocking a left-hand vehicle door with the emergency key element

- ❗ Locking and opening the driver's door with the emergency key triggers the burglar alarm system.
- ❗ If you unlock the driver's door with the emergency key, the boot lid will not be unlocked.

Vehicles without KEYLESS-GO

- ▶ Remove the emergency key (→ page 136).

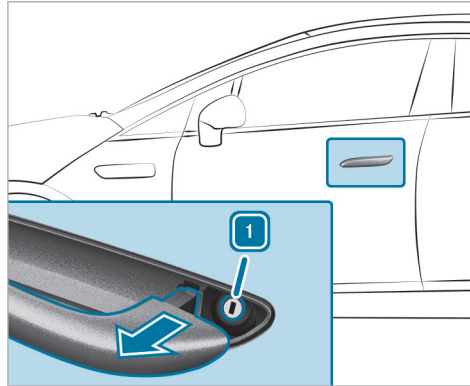

- ▶ Pull and hold the door handle.
- ▶ Insert the emergency key into the lock cylinder.
- ▶ Turn the emergency key anti-clockwise to position **1**.
- ▶ Turn the emergency key back to its starting position.

- ▶ Remove the emergency key and release the door handle.

Vehicles with KEYLESS-GO

- ▶ Remove the emergency key (→ page 136).

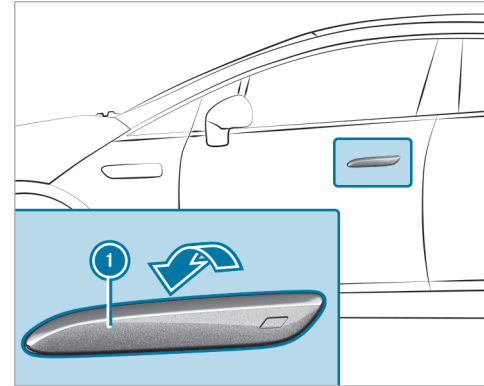

If the door handle is retracted:

- ▶ Insert a flat, non-metallic object behind the door handle ① from above and pry it slightly outward.
- ▶ Reach behind the door handle ① from below, pull it outward to the pressure point and hold it there.

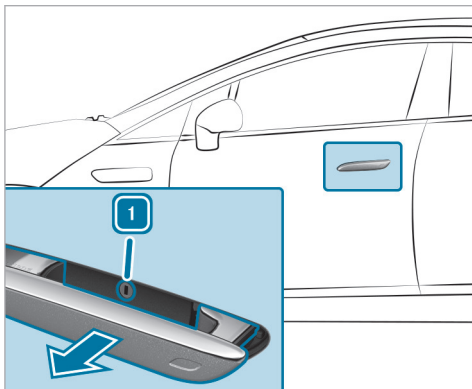

If the door handle is extended:

- ▶ Pull the door handle ① outward to the pressure point and hold it there.
- ▶ Insert the emergency key into the lock cylinder.
- ▶ Turn the emergency key anti-clockwise to position 1.
- ▶ Forcefully pull the door handle ① outward past the pressure point.
- ▶ Turn the emergency key back to its starting position.
- ▶ Remove the emergency key and release the door handle.

You can watch an animation on this topic via the following link:

Locking the doors

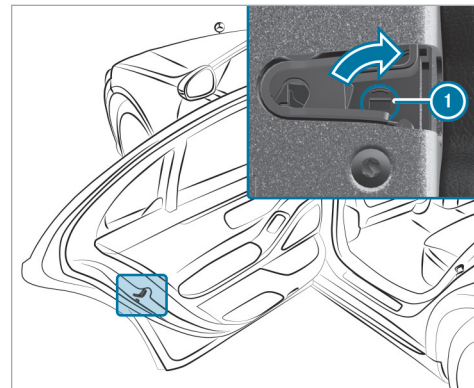

- ▶ Insert a suitable object, e.g. the emergency key, into opening ① on the door lock.
- ▶ **To lock the left-hand side of the vehicle:** turn the emergency key clockwise as far as it will go.

- ▶ **To lock the right-hand side of the vehicle:** turn the emergency key anti-clockwise as far as it will go.

If the locked door is closed, it can no longer be opened from the outside.

Boot

Opening the boot lid

- ❗ **NOTE** Damage to the boot lid by obstacles above the vehicle

The boot lid swings upwards when it is opened.

- ▶ Therefore, make sure that there is sufficient clearance above the boot lid.
- ▶ With the boot lid unlocked, press the top of the Mercedes star.
- ▶ **Vehicles with HANDS-FREE ACCESS:** make a kicking movement with your foot below the bumper (→ page 158).

Vehicles with boot lid convenience closing

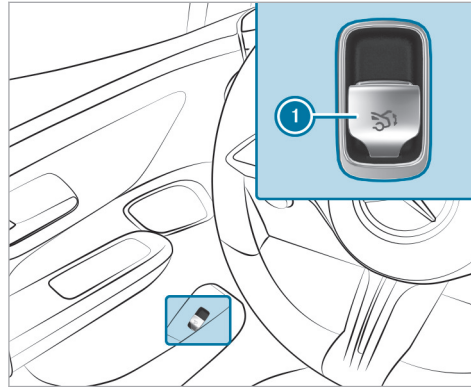

- ▶ Pull remote operating switch ① until the boot lid opens.
- or
- ▶ Press and hold the  button on the key.
- ▶ If the boot lid is stopped in an intermediate position, pull it upwards. Release it as soon as it begins to open.

- ▶ With the boot lid opening limiter activated, manually pull the stopped boot lid upwards.

If an obstacle obstructs the boot lid during the automatic opening process, blockage detection will stop the boot lid. The automatic blockage detection function is only an aid and is not a substitute for your attentiveness.

Closing the boot lid

- ⚠ **WARNING** Risk of injury from unsecured items in the vehicle

If objects, luggage or loads are not secured or not secured sufficiently, they could slip, tip over or be thrown around and thereby hit vehicle occupants.

There is a risk of injury, particularly in the event of sudden braking or a sudden change in direction.

- ▶ Always stow objects in such a way that they cannot be thrown around.

- ▶ Before the journey, secure objects, luggage or loads against slipping or tipping over.

Observe the notes on loading the vehicle.

Notes on closing the boot lid: your vehicle is equipped with automatic key recognition. If a key belonging to the vehicle is detected in the vehicle, the boot lid will not be locked and will pop open again.

Note that the boot lid will not be locked if the following situation occurs:

- You have locked the vehicle and close the boot lid while a key belonging to the vehicle is inside the vehicle.
and
- A second key belonging to the vehicle is not detected outside the vehicle.

Automatic key recognition is only an aid and is not a substitute for your attentiveness.

- ▶ Before locking, ensure that at least one key belonging to the vehicle is outside the vehicle.

- ▶ **To close the boot lid:** pull the boot lid downwards using the handle recess and push it closed.

- ⓘ **Vehicles with boot lid convenience closing:** if you lightly push the boot lid closed, the power closing function will automatically pull the boot lid into the lock.

Vehicles with boot lid convenience closing

⚠ WARNING Risk of becoming trapped during automatic closing of the boot lid

Parts of the body could become trapped. There may be people in the closing area.

- ▶ Make sure that nobody is in the vicinity of the closing area.
- ▶ Use one of the following options to stop the closing process:
 - Press the  button on the key.
 - Press or pull the remote operating switch on the driver's door.
 - Press the closing or locking button on the boot lid.

- Pull the boot lid handle.

Vehicles with HANDS-FREE ACCESS: it is also possible to stop the closing process by making a kicking movement below the rear bumper.

- ▶ Pull the boot lid handle. Release it as soon as it begins to close.
- ▶ If the boot lid is stopped in an intermediate position, push it downwards. The boot lid will continue to close.

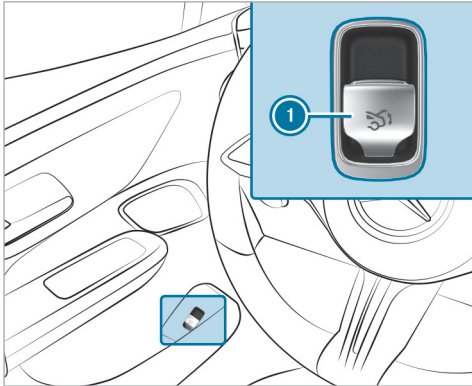

- ▶ Push remote operating switch ① until the boot lid is fully closed.

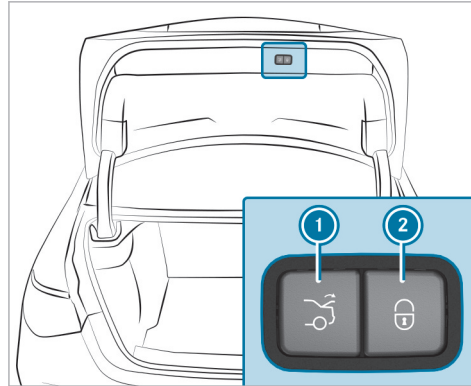

- ▶ Press closing button ① on the boot lid.

Vehicles with KEYLESS-GO

- ▶ Press locking button ② on the boot lid. If a key is detected outside the vehicle, the boot lid will close and the vehicle will be locked.

i **Vehicles with Digital Vehicle Key:** this also applies to the Digital Vehicle Key if the func-

tion is activated and the Digital Vehicle Key is connected to the vehicle.

- ▶ With the boot lid completely open, press and hold the  button on the key. The key must be in the vicinity of the vehicle.

Vehicles with HANDS-FREE ACCESS

- ▶ With the boot lid completely open, make a kicking movement with your foot below the bumper (→ page 158).

Boot lid automatic reversing function

The boot lid is equipped with automatic blockage detection with a reversing function. If an obstacle obstructs the boot lid during the automatic closing process, it will automatically open again. The automatic reversing function is only an aid and is not a substitute for your attentiveness.

- ▶ During the closing process, make sure that no body parts are in the closing area.

⚠ WARNING Risk of becoming trapped despite reversing function

The reversing function will not react:

- to soft, light and thin objects, e.g. fingers
- towards the end of the closing procedure

In these situations in particular, the reversing function cannot prevent someone being trapped.

- ▶ Ensure that no body parts are in the closing area.
- ▶ If someone is trapped, use one of the following options:
 - Press the  button on the key.
 - Press the remote operating switch on the driver's door.
 - Press the closing or locking button on the boot lid.
 - Pull the boot lid handle.

HANDS-FREE ACCESS function

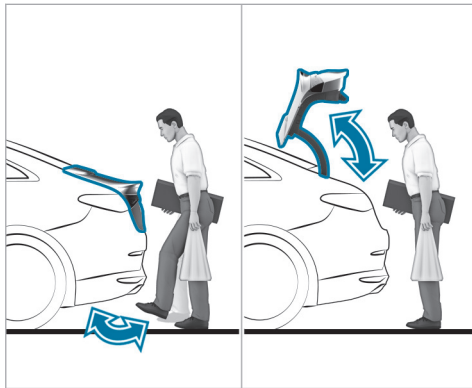

With HANDS-FREE ACCESS you can open, close or interrupt boot lid movement by performing a kicking movement under the rear bumper.

The kicking movement triggers the opening or closing process alternately.

Observe the notes when opening (→ page 155) and closing (→ page 155) the boot lid.

- ⓘ A warning tone sounds while the boot lid is opening or closing.

! **NOTE** Damage to the vehicle caused by unintentionally opening the boot lid or a door

- when using an automatic car wash
- when using a high pressure cleaner

▶ Deactivate the function of the key in these situations.

or

▶ Make sure that the key is at a minimum distance of 3 m (high-pressure cleaner) or 6 m (automatic car wash) away from the vehicle.

Vehicles with digital vehicle key:

! **NOTE** Vehicle damage due to unintentional opening of the boot lid or a door

- when using an automatic car wash
- when using a high pressure cleaner

▶ In these situations, switch off the Digital Vehicle Key.

or

▶ Make sure the key is at least 3 m (pressure washer) or 6 m (car wash) away from the vehicle.

When making the kicking movement, ensure that you stand firmly on the ground. You could otherwise lose your balance, e.g. on ice.

Observe the following notes:

- The key is behind the vehicle.
- **Vehicles with digital vehicle key:** The Digital Vehicle Key is behind the vehicle.
- Stand at least 30 cm away from the vehicle while performing the kicking movement.
- Do not come into contact with the bumper while making the kicking movement.
- Do not carry out the kicking movement too slowly.
- The kicking movement must be towards the vehicle and back again.

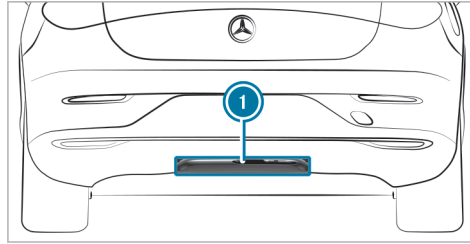

① Detection range of the sensors

If several consecutive kicking movements are not successful, wait ten seconds.

System limits

The system may be impaired or may not function in the following cases:

- The sensors are dirty, e.g. due to road salt or snow.
- The kicking movement is made using a prosthetic leg.

The boot lid could be opened or closed unintentionally, in the following situations:

- A person's arms or legs move in the sensor detection range, e.g. when polishing the vehicle or picking up objects.
- Objects are moved or placed behind the vehicle, e.g. a charging cable or luggage.
- Clamping straps, tarpaulins or other coverings are pulled over the bumper.
- A protective mat with a length reaching over the boot sill down into the detection range of the sensors is used.
- The protective mat is not secured correctly.
- Work is being done on the trailer hitch, trailers or rear bicycle racks.

Deactivate the function of the key (→ page 55) or do not carry the key about your person in such situations.

Switching separate boot locking on and off

Multimedia system:

-  ➤ Settings ➤ Vehicle
- Locking function

Switching separate boot locking on

- ▶ Select **Block boot**.
 - ▶ Create a PIN.
 - ▶ Confirm the PIN with **OK**.
 - ▶ Enter the PIN again and confirm it.
The boot will remain locked if you unlock the vehicle centrally.
-  If an accident has been detected, the boot will unlock even if separate locking is switched on.

Switching separate boot locking off

- ▶ Select **Block boot**.
- ▶ Enter the PIN.
If the PIN is correct, separate boot locking will be switched off and the PIN deleted.

Activating/deactivating the boot lid opening limiter

Multimedia system:

-  ➤ Settings ➤ Vehicle
- Other functions

- ▶ Activate or deactivate **Opening height limiter**.

This function prevents the boot lid from hitting a low garage ceiling, for example.

Side windows

Opening and closing the side windows

-  **WARNING** Risk of becoming trapped when opening a side window

When you open a side window, parts of the body could be drawn in or become trapped between the side window and window frame.

- ▶ When opening, make sure that nobody is touching the side window.

- ▶ If someone is trapped, release the button immediately or pull it in order to close the side window again.

-  **WARNING** Risk of becoming trapped when closing a side window

When closing a side window, body parts could be trapped in the closing area in the process.

- ▶ When closing, make sure that no body parts are in the closing area.
- ▶ If someone is trapped, release the button immediately or press the button in order to reopen the side window.

-  **WARNING** Risk of becoming trapped when children operate the side windows

Children could become trapped if they operate the side windows, particularly when unattended.

- ▶ Activate the child safety lock for the rear side windows.

- ▶ When leaving the vehicle, always take the key with you and lock the vehicle.
- ▶ Never leave children unattended in the vehicle.

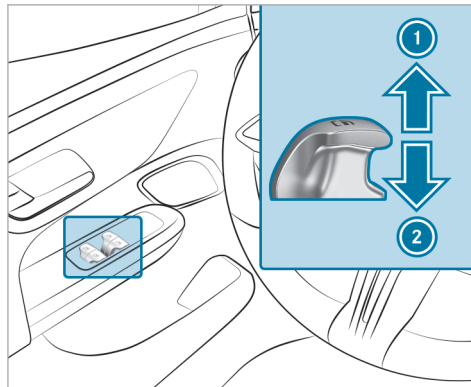

Requirements

- The power supply or the vehicle has been switched on.



- ① Closing
- ② Opening

The buttons on the driver's door take precedence.

- ▶ **To start automatic operation:** press the  button beyond the point of resistance or pull and release it.
- ▶ **To interrupt automatic operation:** press or pull the  button again.

When the vehicle is switched off, you can continue to operate the side windows.

The function is also available until the doors are closed again.

Automatic reversing function of the side windows

If an obstacle impedes a side window during the closing process, the side window will open again automatically. The automatic reversing function is only an aid and is not a substitute for your attentiveness.

- ▶ During the closing process, make sure that no body parts are in the closing area.

⚠ WARNING Risk of becoming trapped despite there being reversing protection on the side window

The reversing function does not react:

- to soft, light and thin objects, e.g. fingers.
- during resetting.

The reversing function cannot prevent someone from becoming trapped in these situations.

- ▶ During the closing process, make sure that no body parts are in the closing area.
- ▶ If someone becomes trapped, press the  button to open the side window again.

Automatic function of the side windows

In the following cases, the side windows will be closed automatically when the vehicle is switched off:

- if it starts to rain
Rain will be detected by a rain sensor on the windscreen.
- in extreme temperatures
- after a certain time (depending on the on-board electrical system voltage)
- if there is a malfunction in the power supply

The side windows will be closed as far as the ventilation position.

Vehicles with a panorama sliding sunroof: the side windows will be closed completely if the sliding sunroof is open.

If the side windows are obstructed during automatic closing, the side window concerned will open again slightly. After another automatic closing process, the automatic function may be deactivated. The automatic function will be active again the next time the vehicle is started.



Convenience opening (ventilating the vehicle before starting a journey)

 **WARNING** Risk of entrapment when opening a side window

When opening a side window, parts of the body could be drawn in or become trapped between the side window and window frame.

- ▶ When opening, make sure that nobody is touching the side window.
- ▶ Release the button immediately if somebody becomes trapped.

Requirements

- The key is near the vehicle.
- ▶ Press and hold the  button on the key.
The following functions are performed:
- The vehicle is unlocked.
 - The side windows are open.
 - The panoramic sunroof opens.
 - The seat ventilation of the driver's seat is switched on.
- ⓘ If the roller sunblind of the panoramic sliding sunroof is closed, the roller sunblind is opened first.
- ▶ **Interrupt convenience opening:** Release the key .
- ▶ **Continue convenience opening:** Press key  again and keep it pressed.

Convenience closing (closing the vehicle from outside)



⚠ WARNING Risk of entrapment due to not paying attention during convenience closing

When the convenience closing feature is operating, parts of the body could become trapped in the closing area of the side window and the sliding sunroof.

▶ When the convenience closing feature is operating, monitor the entire closing process and make sure that no body parts are in the closing area.

Requirements

- The key is near the vehicle.
- ▶ Press and hold the  button on the key.
The following functions are performed:
 - The vehicle is locked.
 - The side windows are closed.
 - The panoramic sliding roof is closed.

- ▶ **To interrupt convenience closing:** release the  button.
- ▶ **To continue convenience closing:** press and hold the  button again.
- ⓘ Convenience closing also functions with KEY-LESS-GO (→ page 145).

Resolving problems with the side windows

⚠ WARNING Risk of becoming trapped or fatally injured if reversing protection is not activated

If you close a side window again immediately after it has been blocked, the side window will close with increased or maximum force. The reversing function is then not active and body parts may become trapped.

- ▶ Make sure that no parts of the body are in the closing area.
- ▶ To stop the closing process, release the button or press the button again to reopen the side window.

A side window cannot be closed and you cannot see the cause.

- ▶ Check to see whether any objects are in the window guide.
- ▶ Adjust the side windows.

Adjusting the side windows

If a side window is obstructed during closing and reopens again immediately:

- ▶ Immediately after this, pull and hold the corresponding button again until the side window has closed and hold the button for at least one more second (re-adjustment).
The side window will be closed without the automatic reversing function.

If the side window is obstructed again and reopens again immediately:

- ▶ Immediately after this, pull and hold the corresponding button again until the side window has closed and hold the button for at least one more second (follow-up adjustment).
The side window will be closed without the automatic reversing function.

The side windows cannot be opened or closed using the convenience opening feature.

Possible causes:

- The key battery is weak or discharged.
- ▶ Check the battery using the indicator lamp (→ page 134).
- ▶ Replace the key battery, if necessary (→ page 136).

Sliding sunroof

Opening and closing the sliding sunroof

- ① The term "sliding sunroof" refers to the panoramic sliding sunroof.

⚠ WARNING Risk of becoming trapped when the sliding sunroof is being opened and closed

Body parts may become trapped in the range of movement.

- ▶ During the opening and closing process, make sure that no body parts are in the sweep of the sliding sunroof.
- ▶ If someone is trapped, release the control panel immediately.

or

- ▶ Touch the control panel during automatic operation.
The opening/closing process will be stopped.

⚠ WARNING Risk of entrapment if the sliding sunroof is operated by children

Children operating the sliding sunroof could get caught in the moving parts, particularly if unattended.

- ▶ Never leave children unattended in the vehicle.
- ▶ When leaving the vehicle, always take the key with you and lock the vehicle.

⚠ WARNING Risk of becoming trapped when the roller sunblind is being opened and closed

Body parts may become trapped between the roller sunblind and frame or sliding roof.

- ▶ During the opening or closing process, make sure that no body parts are in the roller sunblind's range of movement.
- ▶ If someone is trapped, release the control panel immediately.

or

- ▶ Touch the control panel during automatic operation.
The opening/closing process will be stopped.

! NOTE Malfunction due to snow and ice

Snow and ice may cause the sliding sunroof to malfunction.

- ▶ Open the sliding sunroof only if it is free of snow and ice.

! **NOTE** Damage caused by protruding objects

Objects that protrude from the sliding sunroof may damage the seals.

- ▶ Do not allow anything to protrude from the sliding sunroof.

! **NOTE** Damage to panorama sliding sunroof caused by roof luggage rack

If the panorama sliding sunroof is opened when a roof luggage rack is fitted, the panorama sliding sunroof may be damaged by the roof luggage rack.

- ▶ Do not open the panorama sliding sunroof if a roof luggage rack is fitted.

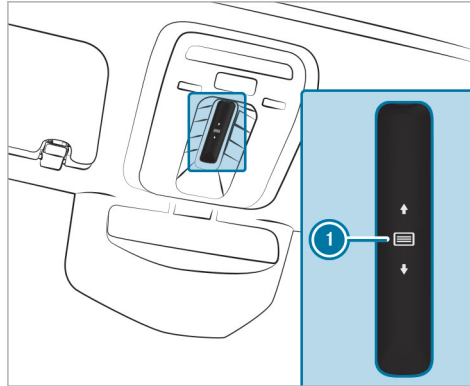

The sliding sunroof and the roller sunblind are operated using control panel ①.

The panoramic sliding sunroof can be operated only when the roller sunblind is open.

- ▶ **To open:** swipe backwards across control panel ① and hold it.
- ▶ **To close:** swipe forwards across control panel ① and hold it.

- ▶ **To raise or lower:** press control panel ① briefly.
- ▶ **To start automatic operation:** swipe forwards or backwards across control panel ①.
- ▶ **To cancel automatic operation:** press control panel ① again. The opening/closing process will be stopped.

Automatic reversing function of the sliding sunroof

If an obstacle obstructs the sliding sunroof during the closing process, the sliding sunroof will open again automatically. The automatic reversing function is only an aid and is not a substitute for your attentiveness.

- ▶ During the closing process, make sure that no body parts are in the closing area.

⚠ WARNING Risk of becoming trapped despite reversing function

The reversing function will not react:

- to soft, light and thin objects, e.g. fingers.
- towards the end of the closing procedure.

- during resetting.

▶ During the closing process, make sure that no body parts are in the closing area.

▶ If someone is trapped, release the control panel immediately.

or

▶ Touch the control panel during automatic closing.
The closing process will be stopped.

Automatic reversing function of the roller sunblind

If an obstacle obstructs the roller sunblind during the closing process, the roller sunblind will open again automatically. The automatic reversing function is only an aid and is not a substitute for your attentiveness.

▶ When closing the roller sunblind, make sure that no body parts are in the range of movement.

⚠ WARNING Risk of becoming trapped despite reversing function

In particular, the reversing function does not react to soft, light and thin objects, e.g. fingers.

▶ When closing the roller sunblind, make sure that no body parts are in the range of movement.

▶ If someone is trapped, release the control panel immediately.

or

▶ Touch the control panel during automatic closing.
The closing process will be stopped.

Automatic functions of the sliding sunroof

i The term "sliding sunroof" refers to the panorama sliding sunroof.

The sliding sunroof will be closed automatically when the vehicle has been switched off in the following situations:

- if it starts to rain

Rain is detected by a rain sensor on the windscreen.

- in extreme temperatures
- after a certain time (depending on the on-board electrical system voltage)
- if there is a malfunction in the power supply

The sliding sunroof will rise at the rear in order to continue ventilating the vehicle interior.

If the sliding sunroof is obstructed during an automatic closing procedure, it will be opened again slightly. The automatic function for the sliding sunroof and the side windows will then be deactivated.

Rain closing function when driving

Vehicles with a panorama sliding sunroof: if it starts to rain, the raised sliding sunroof will automatically be lowered while the vehicle is in motion.

Automatic lowering function

Vehicles with a panorama sliding sunroof: if the sliding sunroof is raised at the rear, it will automatically be lowered slightly at higher speeds. At low speeds, it will be raised again automatically.

⚠ WARNING Risk of becoming trapped by automatic lowering of the sliding sunroof

At higher speeds, the raised sliding sunroof will automatically be lowered slightly at the rear.

- ▶ Make sure that nobody reaches into the sliding sunroof's range of movement while the vehicle is in motion.
- ▶ If someone becomes trapped, touch the control panel.

Rectifying problems with the sliding sunroof

⚠ WARNING Risk of becoming trapped or fatal injuries when the sliding sunroof is closed again

If you close the sliding sunroof again immediately after it has been blocked or reset, the sliding sunroof will close with increased or maximum force.

There is a risk of becoming trapped or even of fatal injuries!

- ▶ Make sure that no parts of the body are in the closing area.
- ▶ If someone is trapped, release the control panel immediately.

or

- ▶ Touch the control panel during automatic closing.
The closing process will be stopped.

The sliding sunroof cannot be closed and you cannot see the cause.

i The term "sliding sunroof" refers to the panoramic sliding sunroof.

If the sliding sunroof is obstructed during closing and reopens again slightly:

- ▶ Immediately after automatic reversing, swipe forwards across the control panel (→ page 164) and hold it until the sliding sunroof is closed.
The sliding sunroof will be closed with increased force.

If the sliding sunroof is obstructed again and opens again slightly:

- ▶ Repeat the previous step.
The sliding sunroof will be closed again with increased force.

The sliding sunroof or the roller sunblind is not operating smoothly.

- ▶ Reset the sliding sunroof and the roller sunblind.

Resetting the sliding sunroof and the roller sunblind

- ▶ Swipe forwards across the control panel (→ page 164) and hold it repeatedly until the sliding sunroof is completely closed.
- ▶ Swipe across the control panel and hold it for another second.
- ▶ Swipe across and hold the control panel until the roller sunblind is completely closed.
- ▶ Swipe across the control panel and hold it for another second.
- ▶ Use automatic operation to fully open and then close the sliding sunroof.

Anti-theft protection

Function of the immobiliser

The immobiliser prevents your vehicle from being started without the correct key.

This also applies to the Digital Vehicle Key.

The immobiliser is automatically activated when the vehicle is switched off, and deactivated when the vehicle is switched on.

ATA (Anti-Theft Alarm system)

Function of the ATA system

If the ATA system is primed, a visual and audible alarm is triggered in the following situations:

- when a door is opened
- when the boot lid is opened
- when interior protection is triggered (→ page 170)
- when tow-away protection is triggered (→ page 169)

i Vehicles with Digital Vehicle Key: The EDW works with the Digital Vehicle Key similarly to the conventional vehicle key.

The ATA system is primed automatically after approximately ten seconds in the following situations:

- after the vehicle has been locked with the key
- after locking the vehicle using KEYLESS-GO
- after locking with the NFC function (**vehicles with digital vehicle key:**)

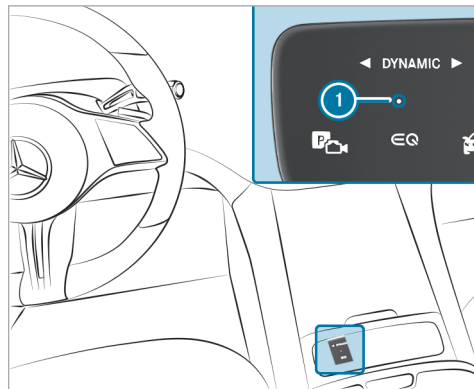

Example: with MBUX hyperscreen

The indicator lamp **1** flashes when the ATA system is primed.

The ATA system is deactivated automatically in the following situations:

- after unlocking the vehicle with the key
- after unlocking the vehicle using KEYLESS-GO

- after unlocking with the NFC function (**Vehicles with Digital Vehicle Key**)
- after pressing the start/stop button with the key in the stowage compartment (→ page 256)

Deactivating the ATA

- ▶ Press the ,  or  buttons on the key.

or

- ▶ Press the start/stop button with the key in the stowage compartment (→ page 256)
- ▶ **Vehicles with digital vehicle key:** Press the start-stop button with the digital vehicle key in the storage (→ page 255).

Deactivating the alarm using KEYLESS-GO

- ▶ With the key outside the vehicle, touch the inner surface of the door handle. This also applies to the Digital Vehicle Key.

Function of tow-away protection

An audible and visual alarm is triggered if an alteration to your vehicle's angle of inclination is detected while tow-away protection is primed.



Tow-away protection is automatically primed after approximately 60 seconds:

- after the vehicle has been locked with the key
- after locking the vehicle using KEYLESS-GO This also applies to the Digital Vehicle Key.
- after locking with the NFC function (**vehicles with digital vehicle key:**)

Tow-away protection is only primed when the following components are closed:

- Doors
- Boot lid

Tow-away protection is automatically deactivated:

- after pressing the  or  button on the key
- after pressing the start/stop button with the key in the stowage compartment (→ page 256)

- after pressing the start-stop button with the digital vehicle key in the storage compartment (**Vehicles with digital vehicle key**) (→ page 255)
- after unlocking the vehicle using KEYLESS-GO This also applies to the Digital Vehicle Key.
- after unlocking with the NFC function (**Vehicles with Digital Vehicle Key**)
- when using HANDS-FREE ACCESS

Information on collision detection on a parked vehicle (→ page 302).

Priming/deactivating tow-away protection

Multimedia system:

- ▶  ▶ Settings ▶ Vehicle
- ▶ Opening/closing ▶ Vehicle protection
- ▶ Prime or deactivate **Tow-away protection**.

Tow-away protection is primed again in the following cases:

- The vehicle is unlocked again.
- A door is opened.

- The vehicle is locked again.

Function of interior protection

When interior protection is primed, a visual and audible alarm is triggered if movement is detected in the vehicle interior.



Interior protection is primed automatically after approximately ten seconds:

- after the vehicle has been locked with the key
- after locking the vehicle using KEYLESS-GO
This also applies to the Digital Vehicle Key.
- after locking with the NFC function (**vehicles with digital vehicle key:**)

Interior protection is only primed when the following components are closed:

- Doors
- Boot lid

Interior protection is automatically deactivated:

- after pressing the  or  button on the key

- after pressing the start/stop button with the key in the stowage compartment (→ page 256)
- after pressing the start-stop button with the digital vehicle key in the storage compartment (**Vehicles with digital vehicle key**) (→ page 255)
- after unlocking the vehicle using KEYLESS-GO
This also applies to the Digital Vehicle Key.
- after unlocking with the NFC function (**Vehicles with Digital Vehicle Key**)
- when using HANDS-FREE ACCESS

The following situations can lead to a false alarm:

- when there are moving objects such as mascots in the vehicle interior
- if a side window is open
- if the panoramic sunroof is open

Priming/deactivating interior protection

Multimedia system:

  **Settings** **»** **Vehicle**
» **Opening/closing** **»** **Vehicle protection**

 Prime or deactivate **Interior motion sensor**.

Interior protection is primed again in the following cases:

- The vehicle is unlocked again.
- A door is opened.
- The vehicle is locked again.

Notes on the correct driver's seat position

⚠ WARNING Risk of accident due to adjusting the vehicle settings while the vehicle is in motion

You could lose control of the vehicle in the following situations in particular:

- if you adjust the driver's seat, the head restraint, the steering wheel or the mirror while the vehicle is in motion
- if you fasten your seat belt while the vehicle is in motion

▶ Before starting the vehicle: in particular, adjust the driver's seat, head restraint, steering wheel and mirror, and fasten your seat belt.

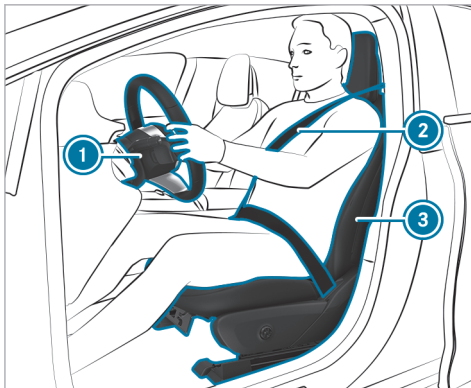

Ensure the following when adjusting steering wheel ①, seat belt ② and driver's seat ③:

- You are sitting as far away from the driver's airbag as possible, taking the following points into consideration:
- You are sitting in an upright position
- Your thighs are slightly supported by the seat cushion

- Your legs are not fully extended and you can depress the pedals properly
- The back of your head is supported at eye level by the centre of the head restraint
- You can hold the steering wheel with your arms slightly bent
- You can move your legs freely
- You can see all the displays on the driver's display clearly
- You have a good overview of the traffic conditions
- Observe the notes on correctly fastening the seat belt (→ page 93).

Notes on grab handles

⚠ WARNING Risk of injury due to excessive load on the grab handles

If you apply your full body weight to the grab handle or pull it abruptly, the grab handle may be damaged or come loose from its anchorage. This may result in injuries.

- ▶ Use the grab handles only to stabilise the seating position or to assist in getting in and out of the seat.

Seats

Adjusting the front seat manually and electrically

- ⚠ WARNING** Risk of becoming trapped if the seats are adjusted by children

Children could become trapped if they adjust the seats, particularly when unattended.

- ▶ When leaving the vehicle, always take the key with you and lock the vehicle.
- ▶ Never leave children unattended in the vehicle.

You can adjust the seats when the vehicle is switched off.

- ⚠ WARNING** Risk of becoming trapped during seat adjustment

When you adjust a seat, you or other vehicle occupants could become trapped, e.g. on the seat guide rail.

- ▶ Make sure when adjusting a seat that no one has any body parts in the sweep of the seat.

Observe the safety notes on "Airbags" and "Children in the vehicle".

- ⚠ WARNING** Risk of accident due to the driver's seat not being engaged

The driver's seat may move unexpectedly while driving.

This could cause you to lose control of the vehicle.

- ▶ Always make sure that the driver's seat is engaged before starting the vehicle.

- ⚠ WARNING** Risk of accident due to adjusting the vehicle settings while the vehicle is in motion

You could lose control of the vehicle in the following situations in particular:

- if you adjust the driver's seat, the head restraint, the steering wheel or the mirror while the vehicle is in motion
- if you fasten your seat belt while the vehicle is in motion

- ▶ Before starting the vehicle: in particular, adjust the driver's seat, head restraint, steering wheel and mirror, and fasten your seat belt.

- ⚠ WARNING** Risk of becoming trapped if the seat height is adjusted carelessly

If you adjust the seat height carelessly, you or other vehicle occupants could be trapped and thereby injured.

Children in particular could accidentally press the electrical seat adjustment buttons and become trapped.

- ▶ While moving the seats, make sure that hands or other body parts do not get under the lever assembly of the seat adjustment system.

⚠ WARNING Risk of injury due to head restraints not being fitted or being adjusted incorrectly

If head restraints have not been installed or have not been adjusted correctly, there is an increased risk of injury in the head and neck area, e.g. in the event of an accident or when braking.

- ▶ Always drive with the head restraints fitted.
- ▶ Before driving off, make sure for every vehicle occupant that the centre of the head restraint supports the back of the head at about eye level.

Adjust the head restraint fore-and-aft position so that it is as close as possible to the back of your head.

⚠ WARNING Risk of injury or death due to incorrect seat position

The seat belt will not offer the intended level of protection if you have not moved the seat backrest to an almost vertical position.

In particular, you may slip under the seatbelt and injure yourself.

- ▶ Adjust the seat properly before beginning your journey.
- ▶ Always ensure that the seat backrest is in an almost vertical position and that the shoulder section of your seat belt is routed across the centre of your shoulder.

⚠ WARNING Risk of potentially fatal injuries due to objects trapped under the front passenger seat

Objects trapped under the front passenger seat may interfere with the function of the automatic front passenger airbag shutoff or damage the system.

- ▶ Do not stow any objects under the front passenger seat.
- ▶ When the front passenger seat is occupied, ensure that no objects have become trapped beneath the front passenger seat.

! NOTE Damage to the seats when adjusting

The seats may be damaged by objects when adjusting the seats.

- ▶ When adjusting the seats, make sure that there are no objects in the footwell, under or behind the seats.

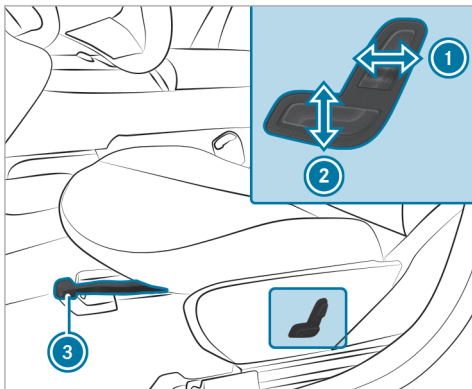

- ① Seat backrest inclination
- ② Seat height
- ③ Seat fore-and-aft position

- ▶ **To adjust the seat fore-and-aft position:** lift lever ③ and slide the seat into the desired position.
- ▶ Make sure that the seat is engaged.

Adjusting the front seat electrically

- ⚠ **WARNING** Risk of becoming trapped if the seats are adjusted by children

Children could become trapped if they adjust the seats, particularly when unattended.

- ▶ When leaving the vehicle, always take the key with you and lock the vehicle.
- ▶ Never leave children unattended in the vehicle.

You can adjust the seats when the vehicle is switched off.

- ⚠ **WARNING** Risk of becoming trapped during seat adjustment

When you adjust a seat, you or other vehicle occupants could become trapped, e.g. on the seat guide rail.

- ▶ Make sure when adjusting a seat that no one has any body parts in the sweep of the seat.

Observe the safety notes on "Airbags" and "Children in the vehicle".

- ⚠ **WARNING** Risk of accident due to adjusting the vehicle settings while the vehicle is in motion

You could lose control of the vehicle in the following situations in particular:

- if you adjust the driver's seat, the head restraint, the steering wheel or the mirror while the vehicle is in motion
- if you fasten your seat belt while the vehicle is in motion
- ▶ Before starting the vehicle: in particular, adjust the driver's seat, head restraint, steering wheel and mirror, and fasten your seat belt.

- ⚠ **WARNING** Risk of becoming trapped if the seat height is adjusted carelessly

If you adjust the seat height carelessly, you or other vehicle occupants could be trapped and thereby injured.

Children in particular could accidentally press the electrical seat adjustment buttons and become trapped.

- ▶ While moving the seats, make sure that hands or other body parts do not get under the lever assembly of the seat adjustment system.

⚠ WARNING Risk of injury due to head restraints not being fitted or being adjusted incorrectly

If head restraints have not been installed or have not been adjusted correctly, there is an increased risk of injury in the head and neck area, e.g. in the event of an accident or when braking.

- ▶ Always drive with the head restraints fitted.
- ▶ Before driving off, make sure for every vehicle occupant that the centre of the head restraint supports the back of the head at about eye level.

Adjust the head restraint fore-and-aft position so that it is as close as possible to the back of your head.

⚠ WARNING Risk of injury or death due to incorrect seat position

The seat belt will not offer the intended level of protection if you have not moved the seat backrest to an almost vertical position.

In particular, you may slip under the seatbelt and injure yourself.

- ▶ Adjust the seat properly before beginning your journey.
- ▶ Always ensure that the seat backrest is in an almost vertical position and that the shoulder section of your seat belt is routed across the centre of your shoulder.

⚠ WARNING Risk of potentially fatal injuries due to objects trapped under the front passenger seat

Objects trapped under the front passenger seat may interfere with the function of the automatic front passenger airbag shutoff or damage the system.

- ▶ Do not stow any objects under the front passenger seat.
- ▶ When the front passenger seat is occupied, ensure that no objects have become trapped beneath the front passenger seat.

! NOTE Damage to the seats when adjusting

The seats may be damaged by objects when adjusting the seats.

- ▶ When adjusting the seats, make sure that there are no objects in the footwell, under or behind the seats.

The switches for adjusting the seats do not move. You will therefore receive no direct feedback on the switch while pressing the switch. Feedback is provided only by the movement of the seat.

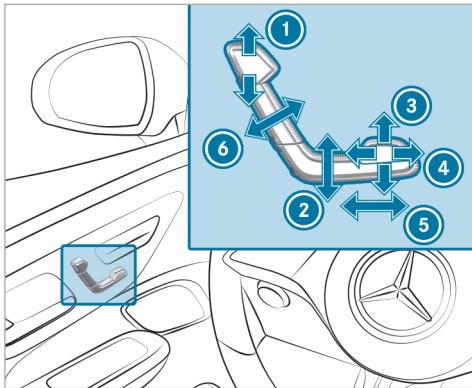

- ① Head restraint height
- ② Seat height
- ③ Seat cushion inclination
- ④ Seat cushion length

- ⑤ Seat fore-and-aft position
- ⑥ Seat backrest inclination
- ▶ Save the settings with the memory function (→ page 189).
- ⓘ The head restraint height will be adjusted automatically when you adjust the seat height or the seat fore-and-aft position.

Adjusting the 4-way lumbar support

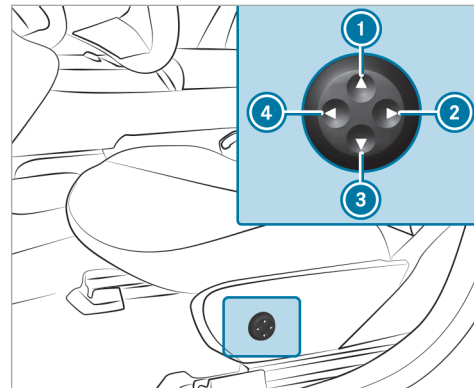

- ① Higher
- ② Softer
- ③ Lower
- ④ Firmer

- ▶ Use buttons ① to ④ to adjust the contour of the backrest.

Head restraints

Adjusting the front seat head restraints manually

⚠ WARNING Risk of accident due to adjusting the vehicle settings while the vehicle is in motion

You could lose control of the vehicle in the following situations in particular:

- if you adjust the driver's seat, the head restraint, the steering wheel or the mirror while the vehicle is in motion
- if you fasten your seat belt while the vehicle is in motion

▶ Before starting the vehicle: in particular, adjust the driver's seat, head restraint, steering wheel and mirror, and fasten your seat belt.

⚠ WARNING Risk of injury due to head restraints not being fitted or being adjusted incorrectly

If head restraints have not been installed or have not been adjusted correctly, there is an increased risk of injury in the head and neck area, e.g. in the event of an accident or when braking.

- ▶ Always drive with the head restraints fitted.
- ▶ Before driving off, make sure for every vehicle occupant that the centre of the head restraint supports the back of the head at about eye level.

Adjust the head restraint fore-and-aft position so that it is as close as possible to the back of your head.

Adjusting manually

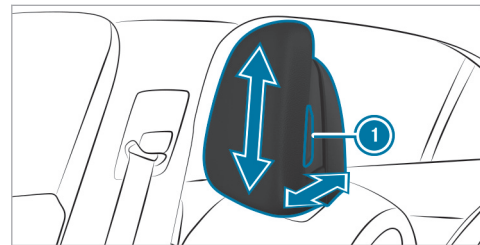

- ▶ Take hold of the head restraint on both sides and press release knob ①. The head restraint will be unlocked in all directions of movement simultaneously.
- ▶ **To raise or lower:** pull the head restraint upwards or push it downwards.
- ▶ **To move forwards or backwards:** pull the head restraint forwards or push it backwards.
- ▶ Let go of release knob ①.

Adjusting partially electrically

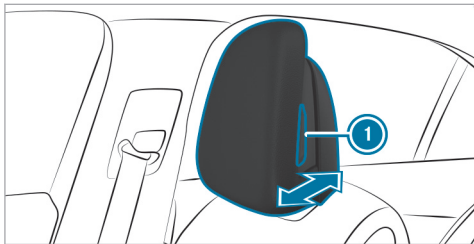

- ▶ **To raise or lower:** adjust the head restraint using the buttons on the door operating unit (→ page 174).
- ▶ **To move forwards or backwards:** take hold of the head restraint on both sides and press release knob ①.
- ▶ Pull the headrest forwards or push it backwards.
- ▶ Let go of release knob ①.

Adjusting the head restraints of the rear seats manually

⚠ WARNING Risk of injury due to incorrectly adjusted head restraints

If head restraints have not been adjusted correctly, there is an increased risk of injury in the head and neck area, e.g. in the event of an accident or sudden braking.

- ▶ Before driving off, make sure for every vehicle occupant that the centre of the head restraint supports the back of the head at about eye level.

Adjust the head restraint fore-and-aft position so that it is as close as possible to the back of your head.

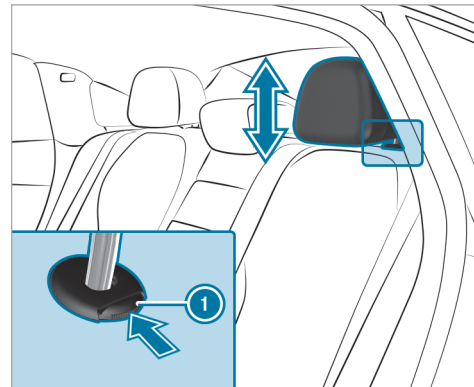

- ▶ **To set the centre head restraint in the first position:** pull the head restraint up until it engages.
- ▶ **To raise:** push release knob ① in the direction of the arrow and pull the head restraint up until it engages.
- ▶ **To lower:** press release knob ① in the direction of the arrow and push the head restraint down until it engages.

Fitting/removing the rear seat head restraints

⚠ WARNING Risk of injury due to head restraints not being fitted or being adjusted incorrectly

If head restraints have not been installed or have not been adjusted correctly, there is an increased risk of injury in the head and neck area, e.g. in the event of an accident or when braking.

- ▶ Always drive with the head restraints fitted.
- ▶ Before driving off, make sure for every vehicle occupant that the centre of the head restraint supports the back of the head at about eye level.

Adjust the head restraint fore-and-aft position so that it is as close as possible to the back of your head.

Removing

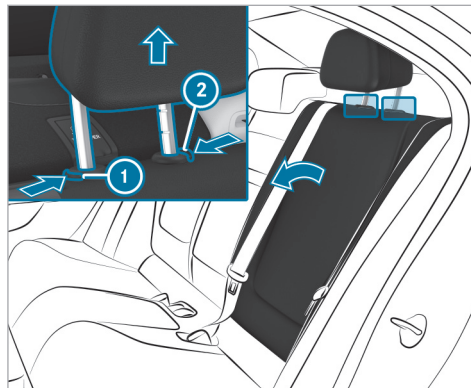

- ▶ Release the rear seat backrest and fold it forwards slightly (→ page 33).
- ▶ Press release knob ② and pull the head restraint upwards as far as it will go. Release knob ① will extend.

- ▶ Push both release knobs ① and ② at the same time in the direction of the arrow and pull out the head restraint.
- ▶ Fold the rear seat backrest back until it engages.

Fitting

- ▶ Release the rear seat backrest and fold it forwards slightly (→ page 33).
- ▶ Insert the head restraint such that the notches on the bar are on the left when viewed in the direction of travel.
- ▶ Push the head restraint down until it engages.
- ▶ Fold the rear seat backrest back until it engages.

Configuring the seat settings

Multimedia system:

  **»» Comfort »» Seat**

Adjusting the air cushions

- ▶ On the corresponding menu, adjust the air cushions for **Lumbar**, **Shoulders** or **Side bolsters**.

Setting the seat heating balance

- ▶ Select **Heating settings**.
 - ▶ Select **Seat heating balance**.
 - ▶ Adjust the heat distribution for the desired seat.
-  The seat heating balance can be set in the rear on the **Seat climate control** menu.

Coupling neck heat to seat heating

- ▶ Select **Additional neck warmer**.
- ▶ Switch the function for the desired seat on or off.
If the function is active, the neck heat of the additional cushion has been coupled to the seat heating.

Setting automatic seat adjustment

 **WARNING** Risk of becoming trapped during adjustment of the driver's seat after calling up a driver profile



Selecting a user profile may trigger an adjustment of the driver's seat to the position saved under the user profile. You or other vehicle occupants could be injured in the process.

- ▶ Make sure that when the position of driver's seat is being adjusted using the multimedia system, no people or body parts are in the seat's range of movement.

If there is a risk of someone becoming trapped, immediately stop the adjustment process by:

- ▶ a) Pressing the warning message on the central display.
- or
- ▶ b) Pressing a position button of the memory function or a seat adjustment switch in the driver's door.
The adjustment process is stopped.

Multimedia system:

  **»» Comfort »» Seat**
»» Position seat automatically

Manually adjusting driver's seat and steering wheel position to body size

The vehicle calculates a suitable driver's seat and steering wheel position on the basis of the driver's body size and sets this directly.

- ▶ **To set the unit of measurement:** select **cm** or **ft/in**.
- ▶ Set the size using the scale.
- ▶ Select **Start positioning**.
The driver's seat and steering wheel position is adjusted to the body size that has been set.

-  You can also configure these settings via the Mercedes me user account for your user profile. By synchronising the profiles in the vehicle and the Mercedes me connect profiles, you can carry over these settings for your vehicle. Further information about synchronising user profiles (→ page 444).

- i** If the driver's seat and steering wheel position calculated by the vehicle is not practical or comfortable, it can be manually adapted at any time via the control buttons. The outside mirrors are not set via this function. Instead, they have to be set manually via the operating switches.



Overview of relaxation programmes

- **Classic massage** Calming back relaxation programme.
- **Mobilizing massage** Mobilising relaxation programme with upward-moving relaxing waves. Can promote slower, deeper respiration. This can improve the supply of oxygen to cells and the brain.
- **Activating massage** Activating relaxation programme with upward-moving relaxing waves.
- **Hot Relaxing back:** Based on hot stone massage, the programme combines heat and massage. It starts by massaging the back. In addition, warm pressure points become noticeable, starting in the pelvic area.
- **Hot Relaxing shoulders** Combination of heat and relaxation. It starts by massaging the shoulders. In addition, warm pressure points become noticeable, starting in the pelvic area.
- **Wave massage** Regenerating relaxation programme via soothing waves across the back and in the seat cushion.
- **Depth waves:** Wave-like movements in the cushion can promote blood flow and metabolic processes in the lower back and legs.
- **Deep workout:** Connect the **Workout, backrest** to the **Workout, cushion**. The vibrations in the cushion intensify the effectiveness of tensing and releasing muscles when you tense against the pressure point. This supports metabolic processes and blood flow in the buttocks and legs.
- **Workout, backrest** and **Workout, cushion** These programmes require your cooperation. Alternating between tensing and releasing helps to improve blood flow to your muscles. Press against a pressure point as soon as you feel it to activate back, abdominal and leg muscles.

Selecting a massage programme for the front seats

Multimedia system:

 **Comfort** **Message**

- ▶ Select a massage programme (→ page 181).
 - ▶ Start the programme for the desired seat .
 - ▶ **To set the massage intensity:** switch **High intensity** on or off.
 - ▶ **To stop the vitalising movement:** select .
- i** The availability of this function is dependent on the vehicle's equipment.

Resetting seat settings

Multimedia system:

 **Comfort** **Seat**

- ▶ Select **Reset**.
- ▶ Select  for the desired seat. The settings for the selected seat are reset.

Switching the seat heating on/off

⚠ WARNING Risk of burns due to repeatedly switching on the seat heating

Repeatedly switching on the seat heating can cause the seat cushion and seat backrest padding to become very hot.

In particular, the health of persons with limited temperature sensitivity or a limited ability to react to high temperatures may be affected or they may even suffer burn-like injuries.

▶ Do not repeatedly switch on the seat heating.

To protect against overheating, the seat heating may be temporarily deactivated after it has been switched on repeatedly.

! NOTE Damage to the seats caused by objects or documents when the seat heater is switched on

When the seat heater is switched on, overheating may occur due to objects or docu-

ments placed on the seats e.g. seat cushions or child seats. This could cause damage to the seat surface.

▶ Make sure that no objects or documents are on the seats when the seat heater is switched on.

Requirements

- The power supply is switched on.

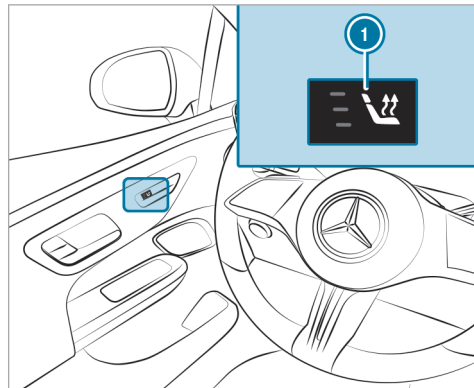

Seat heating in the door operating unit in the cockpit (example)

▶ Press button **1** for the respective seat repeatedly until the desired heating level is reached. Depending on the heating level, up to three indicator lamps will light up. If all indicator lamps are off, the seat heating is switched off.

- ① The seat heating will automatically switch down from the three heating levels after 8, 10 and 20 minutes until the seat heating switches off.
- ① If you switch the power supply off and on again within 20 minutes, the previous setting of the seat heating for the driver's seat will remain active.

Switching the seat ventilation on/off

Requirements

- The power supply is switched on.

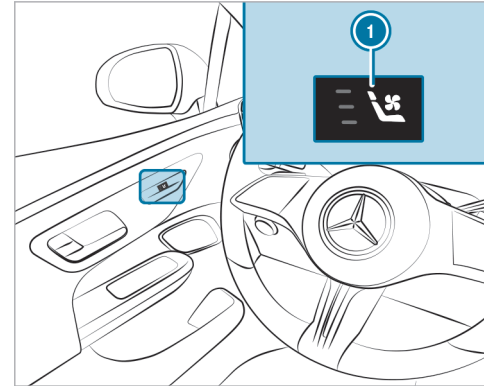
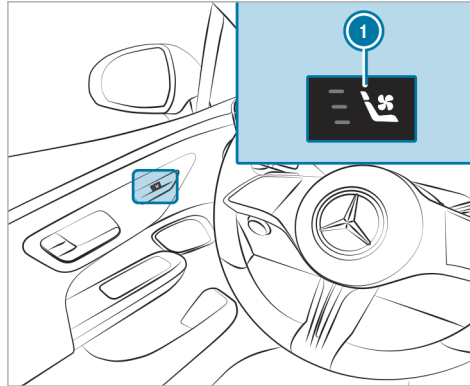

Seat ventilation in the door operating unit in the cockpit (example)

- ▶ Press button ① for the respective seat repeatedly until the desired blower setting is reached.
Depending on the blower setting, up to three indicator lamps will light up. If all indicator lamps are off, the seat ventilation is switched off.

- ⓘ If you switch the power supply off and on again within 20 minutes, the previous seat ventilation setting for the driver's seat will remain active.

Steering wheel

Adjusting the steering wheel manually

- ⚠ **WARNING** Risk of accident due to adjusting the vehicle settings while the vehicle is in motion

You could lose control of the vehicle in the following situations in particular:

- if you adjust the driver's seat, the head restraint, the steering wheel or the mirror while the vehicle is in motion
 - if you fasten your seat belt while the vehicle is in motion
- ▶ Before starting the vehicle: in particular, adjust the driver's seat, head restraint, steering wheel and mirror, and fasten your seat belt.

- ⚠ **WARNING** Risk of entrapment for children when adjusting the steering wheel

Children could injure themselves if they adjust the steering wheel.

- ▶ Never leave children unattended in the vehicle.
- ▶ When leaving the vehicle, always take the key with you and lock the vehicle.

Unlocking

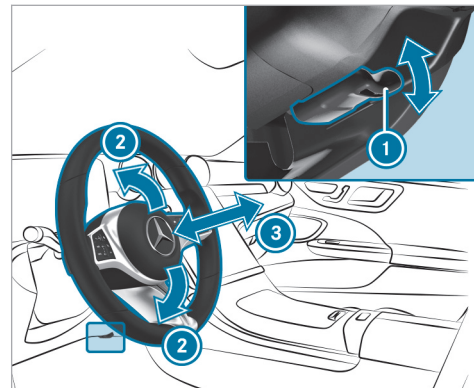

- ▶ Fold release lever ① down as far as it will go.
- ▶ Adjust height ② and distance ③ to the steering wheel.

Locking

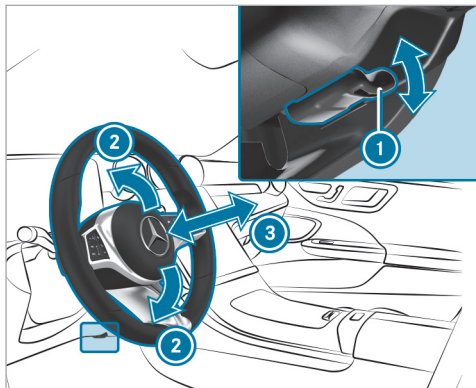

- ▶ Fold release lever ① up as far as it will go.
- ▶ Check and make sure that the steering column is locked by moving the steering wheel.

Adjusting the steering wheel electrically

⚠ WARNING Risk of accident due to adjusting the vehicle settings while the vehicle is in motion

You could lose control of the vehicle in the following situations in particular:

- if you adjust the driver's seat, the head restraint, the steering wheel or the mirror while the vehicle is in motion
- if you fasten your seat belt while the vehicle is in motion

▶ Before starting the vehicle: in particular, adjust the driver's seat, head restraint, steering wheel and mirror, and fasten your seat belt.

⚠ WARNING Risk of entrapment for children when adjusting the steering wheel

Children could injure themselves if they adjust the steering wheel.

- ▶ Never leave children unattended in the vehicle.
- ▶ When leaving the vehicle, always take the key with you and lock the vehicle.

The steering wheel can be adjusted when the power supply is disconnected.

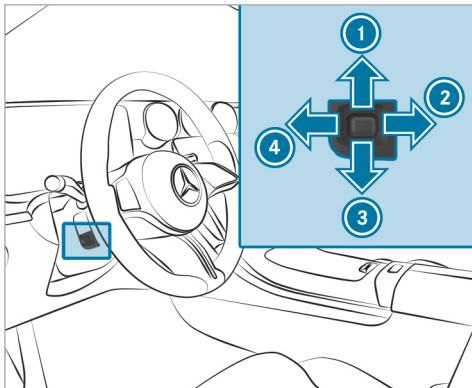

- ① To move up
- ② To move back
- ③ To move down
- ④ To move forward

▶ Save the settings with the memory function (→ page 189).

Decoupling the steering wheel heater from the seat heating

Requirements

- The power supply or the vehicle has been switched on.
- The steering wheel heater and the seat heating are linked.

Multimedia system:

→ [Home] ▶▶ Comfort ▶▶ Seat
▶▶ Heating settings

The function is active by default and the steering wheel heater will automatically be activated and deactivated when the seat heating is switched on and off.

- ▶ Tap **Additional steering wheel heater**.
The steering wheel heater will be decoupled from the seat heating.

Easy entry and exit feature

Using the easy entry and exit feature

- ⚠ **WARNING** Risk of accident when pulling away during the adjustment process of the easy entry and exit feature

You could lose control of the vehicle.

- ▶ Always wait until the adjustment process is complete before driving off.

- ⚠ **WARNING** Risk of becoming trapped when adjusting the easy entry and exit feature

You and other vehicle occupants, particularly children, may become trapped.

- ▶ Make sure that no one has any part of their body within the range of movement of the steering wheel and driver's seat.

If there is a risk of becoming trapped by the steering wheel:

- ▶ Move the steering wheel adjustment lever.
The adjustment process is stopped.

If there is a risk of becoming trapped by the driver's seat:

- ▶ Press the switch for seat adjustment.
The adjustment process is stopped.
- ▶ Never leave children unattended in the vehicle.
- ▶ When leaving the vehicle, always take the key with you and lock the vehicle.

Vehicles with memory function: you can stop the adjustment process by pressing one of the memory function position switches.

⚠ WARNING Risk of becoming trapped if children activate the easy entry and exit feature

Children could become trapped if they activate the easy entry and exit feature, particularly when unattended.

- ▶ Never leave children unattended in the vehicle.
- ▶ When leaving the vehicle, always take the key with you and lock the vehicle.

In order to use the easy entry and exit feature, the automatic seat adjustment function must have been switched on (→ page 180).

When the easy entry and exit feature is active, the steering wheel and driver's seat will move as follows:

- The steering wheel will move upwards.
- The driver's seat will move forward or backward to a position that is ideal for getting in or out of the vehicle.

This will occur in the following situations:

- You switch off the vehicle when the driver's door is open.
- You open the driver's door when the vehicle is switched off.

i The steering wheel will then move upwards only if it is not already as high as it will go.

The driver's seat will move forward or backward only if it is not already in the ideal position for getting in or out of the vehicle.

The steering wheel and the driver's seat will move back to the last driving position in the following cases:

- You switch the power supply or the vehicle on when the driver's door is closed.
- You close the driver's door when the vehicle is switched on.

The last driving position will be saved when:

- You switch off the vehicle.
- **Vehicles with memory function:** you call up the seat settings via the memory function.
- **Vehicles with memory function:** you save the seat settings via the memory function.

Vehicles with memory function: press one of the memory function position switches to stop the adjustment process.

Setting the easy entry and exit feature

Requirements

- The automatic seat adjustment has been activated (→ page 180).

Multimedia system:

→  **Settings** **» Vehicle** **» Comfort**
» Easy entry and exit feature

- Select **Steering wheel and seat, Steering wheel only** or **Off**.

 If you are using an individual user profile, this information is used for the easy entry and exit feature. This will cause the driver's seat and steering wheel to move into the correct position automatically (→ page 441).

Memory function

Function of the memory function

 **WARNING** Risk of an accident if the memory function is used while driving

If you use the memory function on the driver's side while driving, you could lose control of the vehicle as a result of the adjustments being made.

- ▶ Only use the memory function on the driver's side when the vehicle is stationary.

 **WARNING** Risk of entrapment when adjusting the seat with the memory function

When the memory function adjusts the seat, you and other vehicle occupants – particularly children – could become trapped.

- ▶ During the adjusting process of the memory function, ensure that no body

parts are in the area of movement of the seat or the steering wheel.

- ▶ If someone becomes trapped, press a preset position button or seat adjustment switch immediately. The adjustment process is stopped.

 **WARNING** Danger of entrapment when memory function is activated by children

When children activate the memory function, they can get trapped, especially if they are unsupervised.

- ▶ Never leave children unattended in the vehicle.
- ▶ When leaving the vehicle, always take the key with you and lock the vehicle.

You can use the memory function when the vehicle is switched off.

Seat adjustments for up to three people can be stored and called up using the memory function.

You can save the following settings for the front seat:

- Seat, backrest, head restraint position and contour of the seat backrest in the lumbar region
- Seat heating: distribution of the heated sections of the seat cushion and seat backrest
- Driver's side: steering wheel position and position of the outside mirrors on the driver's and front passenger sides
- Head-up display

Operating the memory function

⚠ WARNING Risk of an accident if the memory function is used while driving

If you use the memory function on the driver's side while driving, you could lose control of the vehicle as a result of the adjustments being made.

- ▶ Only use the memory function on the driver's side when the vehicle is stationary.

⚠ WARNING Risk of entrapment when adjusting the seat with the memory function

When the memory function adjusts the seat, you and other vehicle occupants – particularly children – could become trapped.

- ▶ During the adjusting process of the memory function, ensure that no body parts are in the area of movement of the seat or the steering wheel.
- ▶ If someone becomes trapped, press a preset position button or seat adjustment switch immediately. The adjustment process is stopped.

⚠ WARNING Danger of entrapment when memory function is activated by children

When children activate the memory function, they can get trapped, especially if they are unsupervised.

- ▶ Never leave children unattended in the vehicle.

- ▶ When leaving the vehicle, always take the key with you and lock the vehicle.

This also applies to the Digital Vehicle Key.

You can use the memory function when the vehicle is switched off.

Storing

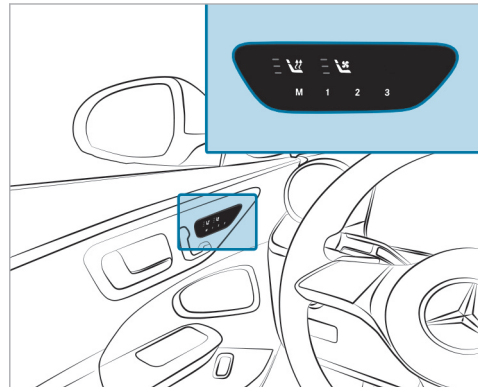

- ▶ Set the seat, the steering wheel, the head-up display and the outside mirror to the desired position.
- ▶ Press the **M** button and then release it.
- ▶ Press one of the preset position buttons **1**, **2** or **3** within three seconds. An acoustic signal sounds. The settings are stored.

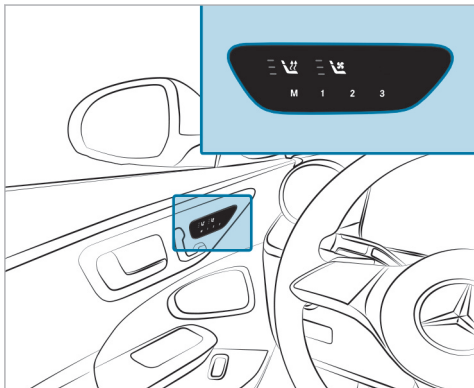

- ▶ **To call up:** press the preset position button **1**, **2** or **3**. The seat is moved to the stored position. After releasing the button, the front seat, outside mirror, head-up display and steering column move automatically into the stored position.

You can watch an animation on this topic via the following link:

Stowage areas

Notes on loading the vehicle

Objects in the deployment area of an airbag may prevent the airbag from functioning correctly. Observe the notes on airbags (→ page 107).

- ▲ **WARNING** Risk of injury from unsecured items in the vehicle

If objects, luggage or loads are not secured or not secured sufficiently, they could slip, tip over or be thrown around and thereby hit vehicle occupants.

There is a risk of injury, particularly in the event of sudden braking or a sudden change in direction.

- ▶ Always stow objects in such a way that they cannot be thrown around.
- ▶ Before the journey, secure objects, luggage or loads against slipping or tipping over.

- ▲ **WARNING** Risk of injury due to objects being stowed incorrectly

If objects in the vehicle interior are stowed incorrectly, they can slide or be thrown around and hit vehicle occupants. In addition, cup holders, open stowage spaces and mobile phone brackets cannot always retain all objects they contain.

There is a risk of injury, particularly in the event of braking manoeuvres or abrupt changes in direction.

- ▶ Always stow objects so that they cannot be thrown around in such situations.

- ▶ Always make sure that objects do not protrude from stowage spaces, luggage nets or stowage nets.
- ▶ Close the lockable stowage spaces before starting a journey.
- ▶ Stow and secure objects that are heavy, hard, pointed, sharp-edged, fragile or too large in the load compartment.

⚠ WARNING Risk of accident from objects in the driver's footwell and front-passenger footwell

Objects in the driver's footwell and front-passenger footwell may impede pedal travel or block a depressed pedal.

This jeopardises the operating and road safety of the vehicle.

- ▶ Stow all objects in the vehicle securely so that they cannot get into the driver's footwell or front-passenger footwell.
- ▶ Always fit the floor mats securely and as prescribed in order to ensure that there

is always sufficient clearance for the pedals.

- ▶ Do not use loose floor mats and do not lay multiple floor mats on top of one another.

Vehicles with automatic front-passenger airbag shutoff:

objects trapped under the front-passenger seat may interfere with the function of the automatic front-passenger airbag shutoff or damage the system. Please observe the notes on the function of the automatic front-passenger airbag shutoff (→ page 97).

! NOTE Damage to the load compartment floor due to uneven loading or jerky movements

The load compartment floor may be damaged by uneven loading or jerky movements.

- ▶ Distribute the load inside the vehicle evenly.
- ▶ Drive carefully when the vehicle is loaded. Avoid abrupt starts, braking and steering as well as rapid cornering.

- ① Leather is a natural product. It exhibits natural surface properties such as differences in structure, marks caused by growth and injury or subtle colour differences. These surface properties are characteristics of leather and not material faults. Leather is also subject to a natural ageing process during which the surface properties change.

The driving characteristics of your vehicle are dependent on the distribution of the load within the vehicle. You should bear the following in mind when loading the vehicle:

- Do not exceed the permissible total mass or the permissible axle loads of the vehicle (with the load and including occupants). information can be found on the vehicle identification plate (→ page 757).
- The load must not protrude above the upper edge of the seat backrests.
- Always place the load behind unoccupied seats if possible.
- secure the load using the lashing eyelets and distribute the load evenly.

Notes on driving with a roof load

- Distribute the roof load and the load inside the vehicle evenly, placing heavy objects at the bottom. Also comply with the notes on loading the vehicle.
 - Drive attentively, and avoid abrupt starts, braking and steering as well as rapid cornering.
 - When transporting roof loads and when the vehicle is fully loaded or fully occupied, select drive programs **E** and **C**. These are designed to focus on stability (→ page 266).
- i** For more information on stowage compartments and stowage areas, please refer to the Digital Owner's Manual.

Stowage spaces in the vehicle interior**Overview of the front stowage compartments**

⚠ WARNING Risk of injury due to objects being stowed incorrectly

If objects in the vehicle interior are stowed incorrectly, they can slide or be thrown around

and hit vehicle occupants. In addition, cup holders, open stowage spaces and mobile phone brackets cannot always retain all objects they contain.

There is a risk of injury, particularly in the event of sudden braking or a sudden change in direction.

- ▶ Always stow objects in such a way that they cannot be thrown around in such situations.
- ▶ Always make sure that objects do not protrude from stowage spaces, luggage nets or stowage nets.
- ▶ Close the lockable stowage spaces before starting a journey.
- ▶ Always stow and secure heavy, hard, pointed, sharp-edged, fragile or bulky objects in the boot.

Observe the notes on loading the vehicle.

⚠ WARNING Risk of accident from objects in the driver's footwell and front-passenger footwell

Objects in the driver's footwell and front-passenger footwell may impede pedal travel or block a depressed pedal.

This jeopardises the operating and road safety of the vehicle.

- ▶ Stow all objects in the vehicle securely so that they cannot get into the driver's footwell or front-passenger footwell.
- ▶ Always fit the floor mats securely and as prescribed in order to ensure that there is always sufficient clearance for the pedals.
- ▶ Do not use loose floor mats and do not lay multiple floor mats on top of one another.

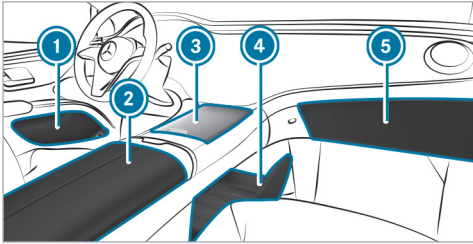

- ① Stowage spaces in the doors
- ② Stowage and telephone compartment beneath the armrest with multimedia and USB ports as well as stowage space, e.g. for an MP3 player
- ③ Stowage compartment in the front centre console, with cup holders, USB ports and charging module for wireless charging of mobile phones depending on the vehicle version
- ④ Stowage tray below the central display of the multimedia system with USB ports
- ⑤ Glove compartment

ⓘ The rubber mat in the stowage compartment in front centre console ③ can be removed for cleaning with clean, lukewarm water. Please comply with the notes on caring for the interior (→ page 605).

ⓘ Use the rubber strap to securely store objects in the stowage tray under the central display.

■ Opening and closing the stowage compartment in the front centre console

⚠ WARNING Risk of injury due to objects being stowed incorrectly

If objects in the vehicle interior are stowed incorrectly, they can slide or be thrown around and hit vehicle occupants. In addition, cup holders, open stowage spaces and mobile phone brackets cannot always retain all objects they contain.

There is a risk of injury, particularly in the event of sudden braking or a sudden change in direction.

- ▶ Always stow objects in such a way that they cannot be thrown around in such situations.
- ▶ Always make sure that objects do not protrude from stowage spaces, luggage nets or stowage nets.
- ▶ Close the lockable stowage spaces before starting a journey.
- ▶ Always stow and secure heavy, hard, pointed, sharp-edged, fragile or bulky objects in the boot.

Observe the notes on loading the vehicle.

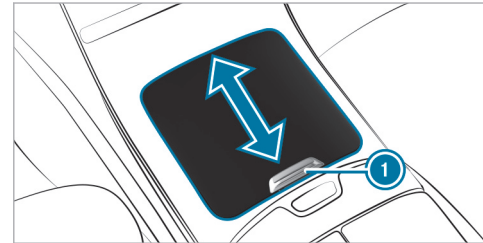

- ▶ **To open:** slide the cover of the stowage compartment in the front centre console all the way forwards in the direction of the arrow using handle ①.
- ▶ **To close:** briefly push handle ① of the open cover of the stowage compartment in the front centre console forwards. The cover will automatically close the stowage compartment in the front centre console.

Opening and closing the stowage compartment in the front armrest

⚠ WARNING Risk of injury due to objects being stowed incorrectly

If objects in the vehicle interior are stowed incorrectly, they can slide or be thrown around and hit vehicle occupants. In addition, cup holders, open stowage spaces and mobile phone brackets cannot always retain all objects they contain.

There is a risk of injury, particularly in the event of sudden braking or a sudden change in direction.

- ▶ Always stow objects in such a way that they cannot be thrown around in such situations.
- ▶ Always make sure that objects do not protrude from stowage spaces, luggage nets or stowage nets.
- ▶ Close the lockable stowage spaces before starting a journey.
- ▶ Always stow and secure heavy, hard, pointed, sharp-edged, fragile or bulky objects in the boot.

Observe the notes on loading the vehicle.

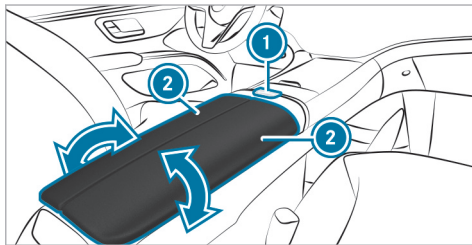

- ▶ **To open:** press release catch ① downwards. The covers of the stowage compartment in front armrest ② will open automatically in the direction of the arrow.
- ▶ **To close:** move the covers of the stowage compartment in front armrest ② inwards in the direction of the arrow. The stowage compartment in the front armrest is now closed.

Opening and closing the glove compartment

⚠ WARNING Risk of injury due to objects being stowed incorrectly

If objects in the vehicle interior are stowed incorrectly, they can slide or be thrown around and hit vehicle occupants. In addition, cup holders, open stowage spaces and mobile phone brackets cannot always retain all objects they contain.

There is a risk of injury, particularly in the event of sudden braking or a sudden change in direction.

- ▶ Always stow objects in such a way that they cannot be thrown around in such situations.
- ▶ Always make sure that objects do not protrude from stowage spaces, luggage nets or stowage nets.
- ▶ Close the lockable stowage spaces before starting a journey.
- ▶ Always stow and secure heavy, hard, pointed, sharp-edged, fragile or bulky objects in the boot.

Observe the notes on loading the vehicle.

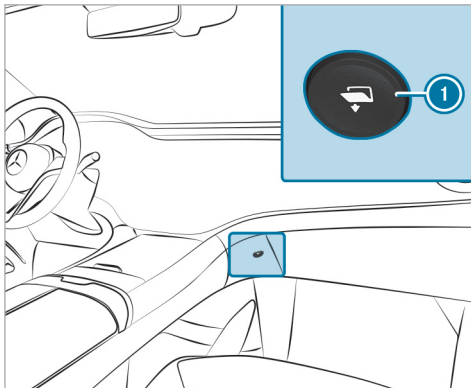

- ▶ **To open:** press button ①.
The glove compartment will open.
- ▶ **To close:** fold the glove compartment upwards.
The glove compartment will close.

Through-loading feature in the rear bench seat (EASY-PACK Quickfold)

■ Folding the rear seat backrests forward

⚠ WARNING Risk of becoming trapped when adjusting the seats

When you adjust a seat, you may trap yourself or a vehicle occupant.

- ▶ When adjusting a seat, make sure that no one has any body parts in the sweep of the seat.

⚠ WARNING Risk of an accident because the seat backrest is not engaged

The seat backrest may fold forwards.

There is a risk of the following, in particular:

- The vehicle occupant may be pressed against the seat belt. The seat belt cannot protect as intended and could cause additional injury.

- A child restraint system is no longer properly supported or properly positioned and may no longer fulfil its function as intended.
- The seat backrest cannot restrain objects or goods in the boot or load compartment.

Always ensure that the seat backrest is engaged, especially:

- After the seat has been adjusted.
- After the load compartment enlargement has been folded forwards

Make sure that the red marking of the lock verification indicator is no longer visible. Otherwise, the seat backrest will not be locked.

Always ensure that all vehicle occupants have their seat belts fastened correctly and are sitting properly. Particular attention must be paid to children.

Requirements:

- The rear seat backrest head restraints are fully inserted.

- Vehicles with a folding rear armrest: the rear armrest has been folded up.

Folding the rear outer seat backrests forward

You can fold the centre and right seat backrests forwards separately.

The left seat backrest can be folded forwards only together with the centre seat backrest.

If you no longer require the folded-down rear seat backrest as a load area, fold the backrest back into place.

- ▶ Ensure that the centre seat backrest is in an upright position and locked to the left seat backrest (→ page 198).

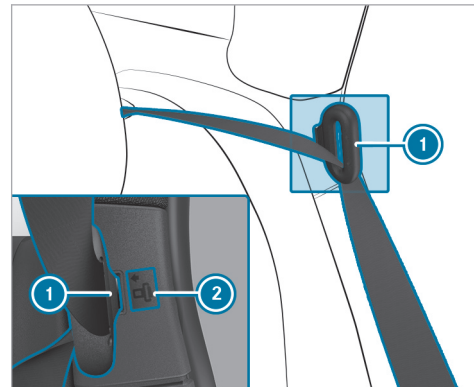

- ▶ Press the seat belt tongue of seat belt ① into marked position ②.
- ▶ Move the driver's or front passenger seat forwards, if necessary.

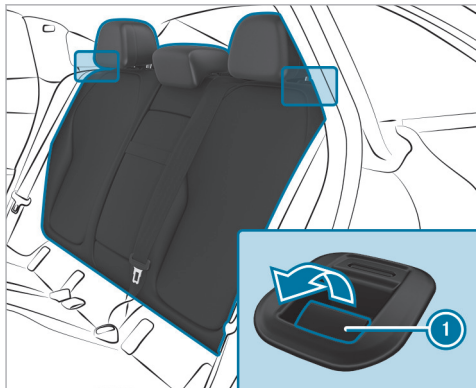

- ▶ Pull release lever ①.
- ▶ Fold the corresponding seat backrest forwards.

Folding the centre rear seat backrest forwards separately

If you no longer require the folded-down seat backrest as a loading area, fold the backrest back into place.

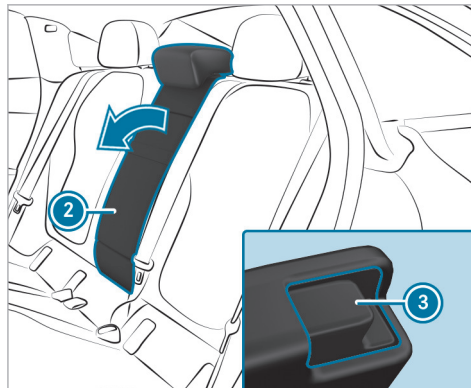

- ▶ Press release catch ③.
- ▶ Fold the seat backrest ② forwards.

Folding back the rear seat backrest

⚠ WARNING Risk of becoming trapped when adjusting the seats

When you adjust a seat, you may trap yourself or a vehicle occupant.

▶ When adjusting a seat, make sure that no one has any body parts in the sweep of the seat.

⚠ WARNING Risk of an accident because the seat backrest is not engaged

The seat backrest may fold forwards.

There is a risk of the following, in particular:

- The vehicle occupant may be pressed against the seat belt. The seat belt cannot protect as intended and could cause additional injury.
- A child restraint system is no longer properly supported or properly positioned and may no longer fulfil its function as intended.
- The seat backrest cannot restrain objects or goods in the boot or load compartment.

Always ensure that the seat backrest is engaged, especially:

- After the seat has been adjusted.

- After the load compartment enlargement has been folded forwards

Make sure that the red marking of the lock verification indicator is no longer visible. Otherwise, the seat backrest will not be locked.

Always ensure that all vehicle occupants have their seat belts fastened correctly and are sitting properly. Particular attention must be paid to children.

! **NOTE** Damage caused by trapping the seat belt when folding back the seat backrest

The seat belt could become trapped and thus be damaged when the seat backrest is folded back.

- ▶ Make sure that the seat belt is not trapped when folding back the seat backrest.

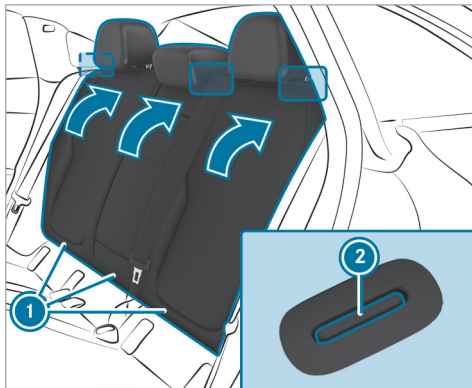

- ▶ Move the driver's or front passenger seat forwards, if necessary.
- ▶ Swivel seat backrest ① back until it engages. If the seat backrest is not engaged and locked in place, red lock verification indicator ② will be visible.

Locking and releasing the release catch of the centre rear seat backrest

! **WARNING** Risk of becoming trapped when adjusting the seats

When you adjust a seat, you may trap yourself or a vehicle occupant.

- ▶ When adjusting a seat, make sure that no one has any body parts in the sweep of the seat.

! **WARNING** Risk of an accident because the seat backrest is not engaged

The seat backrest may fold forwards.

There is a risk of the following, in particular:

- The vehicle occupant may be pressed against the seat belt. The seat belt cannot protect as intended and could cause additional injury.
- A child restraint system is no longer properly supported or properly positioned and

may no longer fulfil its function as intended.

- The seat backrest cannot restrain objects or goods in the boot or load compartment.

Always ensure that the seat backrest is engaged, especially:

- After the seat has been adjusted.
- After the load compartment enlargement has been folded forwards

Make sure that the red marking of the lock verification indicator is no longer visible. Otherwise, the seat backrest is not locked.

Always ensure that all vehicle occupants have their seat belts fastened correctly and are sitting properly. Particular attention must be paid to children.

You can lock the centre seat backrest release catch if you want to secure the boot against unauthorised access. The centre seat backrest can then be folded forwards only together with the left seat backrest.

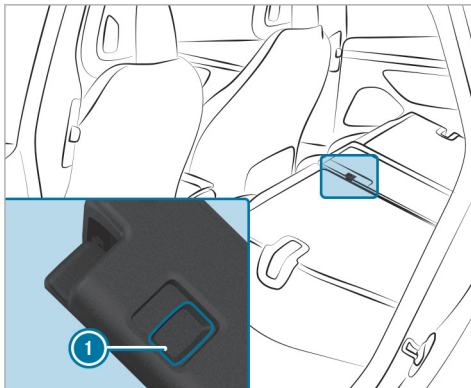

- ▶ **To lock or unlock:** slide catch ① upwards or downwards.

Overview of the tie-down eyes

Observe the notes on loading the vehicle (→ page 190).

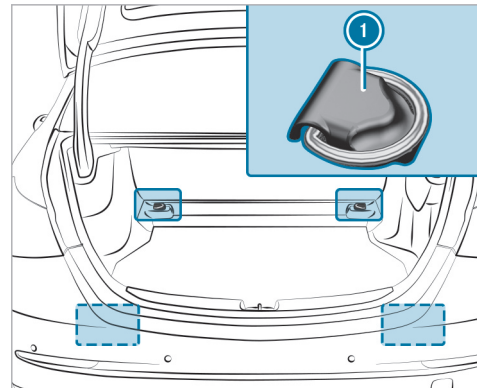

- ① Tie-down eyes
- i Four tie-down eyes are available only in vehicles equipped with the through-loading feature in the rear bench seat (EASY-PACK Quickfold).

Opening the stowage space under the boot floor

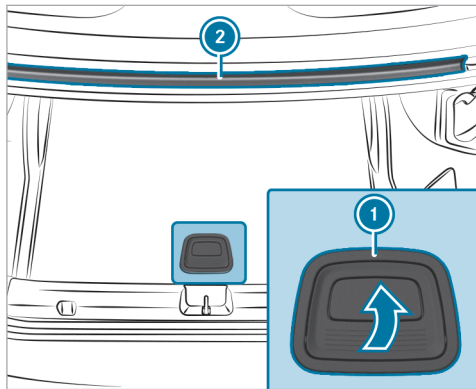

- ▶ Pull handle ① up and hook it into drip rail ②.

Attaching a roof luggage rack

⚠ WARNING Risk of accident due to exceeding the maximum roof load

The vehicle centre of gravity and the usual driving characteristics as well as the steering and braking characteristics alter.

If you exceed the maximum roof load, the driving characteristics, as well as steering and braking, will be greatly impaired.

- ▶ Never exceed the maximum roof load and adjust your driving style.

You will find information on the maximum roof load in the "Technical data" section in the printed Owner's Manual.

! NOTE Damage to the vehicle due to not observing the maximum permitted headroom clearance

If the vehicle height is greater than the maximum permitted headroom clearance, the roof and other parts of the vehicle may be damaged.

- ▶ Observe the signposted headroom clearance.
- ▶ If the vehicle height is greater than the permitted headroom clearance, do not enter.
- ▶ Observe the changed vehicle height with add-on roof equipment.

! NOTE Vehicle damage from non-approved roof luggage racks

The vehicle could be damaged by roof luggage racks that have not been tested and approved by Mercedes-Benz.

- ▶ Only use roof luggage racks tested and approved for Mercedes-Benz.
- ▶ Depending on the vehicle equipment, ensure that when the roof luggage rack is fitted, the tailgate can be fully opened.
- ▶ Position the load on the roof luggage rack in such a way that the vehicle will not sustain damage even when it is in motion.

! **NOTE** Damage to panorama sliding sunroof caused by roof luggage rack

If the panorama sliding sunroof is opened when a roof luggage rack is fitted, the panorama sliding sunroof may be damaged by the roof luggage rack.

- ▶ Do not open the panorama sliding sunroof if a roof luggage rack is fitted.

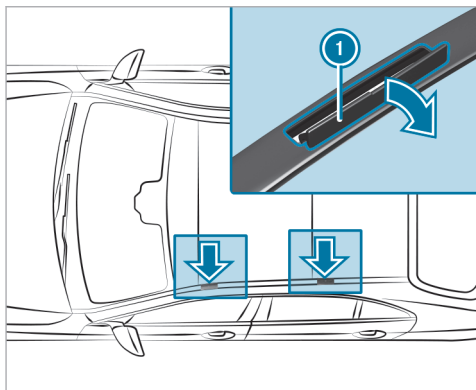

! **NOTE** Damage to the covers

The covers may be damaged and scratched when being opened.

- ▶ Do not use metallic or hard objects.
- ▶ Carefully fold covers ① upwards in the direction of the arrow.
- ▶ Secure the roof luggage rack to the fastening points beneath covers ①.
- ▶ Comply with the installation instructions of the roof luggage rack manufacturer.
- ▶ Secure the load on the roof luggage rack.

Cup holders

Fitting the cup holder in or removing it from the centre console

- !** **WARNING** - Risk of accident or injury when using the cup holder while the vehicle is in motion

The cup holder cannot hold a container secure while the vehicle is in motion.

If you use a cup holder while the vehicle is in motion, the container may be flung around and liquids could be spilled. The vehicle occupants may come into contact with the liquid and if it is hot, they could be scalded. You could be distracted from traffic conditions and you may lose control of the vehicle.

- ▶ Only use the cup holder when the vehicle is stationary.
- ▶ Only use the cup holder for containers of the right size.
- ▶ Always close the container, particularly if the liquid is hot.

- !** **WARNING** Risk of injury due to objects being stowed incorrectly

If objects in the vehicle interior are stowed incorrectly, they can slide or be thrown around and hit vehicle occupants. In addition, cup holders, open stowage spaces and mobile phone brackets cannot always retain all objects they contain.

There is a risk of injury, particularly in the event of sudden braking or a sudden change in direction.

- ▶ Always stow objects in such a way that they cannot be thrown around in such situations.
- ▶ Always make sure that objects do not protrude from stowage spaces, luggage nets or stowage nets.
- ▶ Close the lockable stowage spaces before starting a journey.
- ▶ Always stow and secure heavy, hard, pointed, sharp-edged, fragile or bulky objects in the boot.

Requirements:

- For installation: the locking catch is pushed in the direction of the cup holder.

Observe the notes on loading the vehicle (→ page 190).

To fit

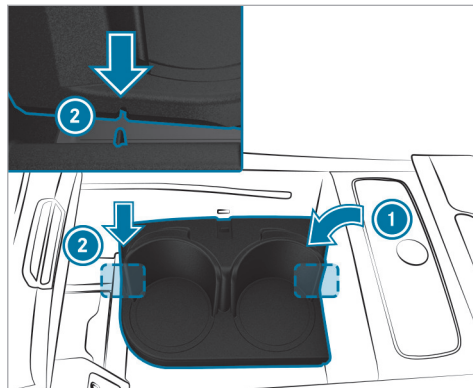

- ▶ Insert cup holder housing ① into the stowage compartment at a slight angle.
- ▶ Place cup holder housing ① in the stowage compartment, aligning the recesses with the two hubs ② so that they fit.
- ▶ Push the cup holder down.

To lock

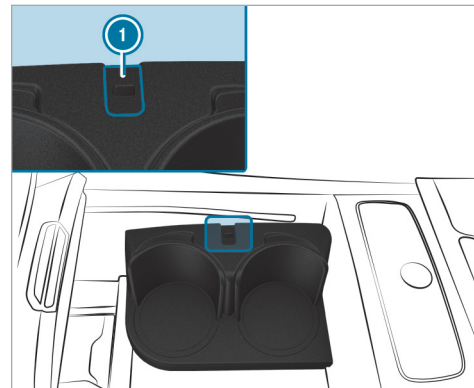

- ▶ Slide locking catch ① toward the side wall of the centre console. The cup holder will be locked.

To remove

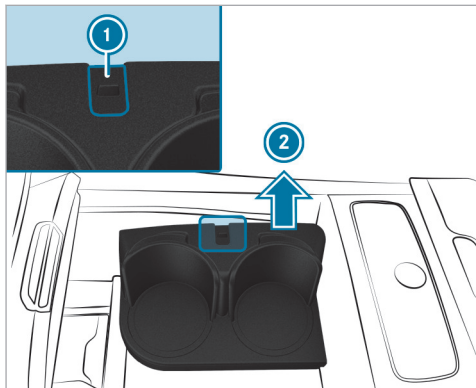

- ▶ Slide locking catch ① toward the cup holder. The cup holder will be unlocked.
- ▶ First pull the cup holder up in the direction of arrow ② and then tilt it slightly to remove it from the stowage compartment.

Using the cup holder

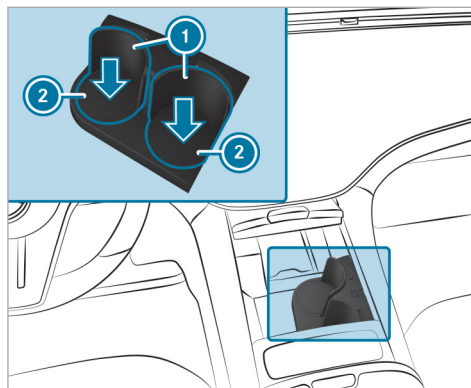

- ▶ Place a beverage container in the cup holder. Bottom ② of the cup holder will lower automatically and side walls ① of the cup holder will move forward automatically.
- ① The cup holder will automatically adjust to the size of the container placed in it.

The side walls of the cup holder can also be activated manually in different ways:

- Press the bottom down slightly with the beverage container.
 - Press on the grooved surface on the side wall of the cup holder.
- ① Check whether the beverage container is held firmly by the cup holder. Some beverage containers will not be secured adequately in the cup holder due to their shape or size.

Original position

When the cup holder is not in use, the side walls of the cup holder can be retracted manually. The bracket arms of the cup holder will automatically be retracted as well, and the cup holder's holding function will then no longer be available.

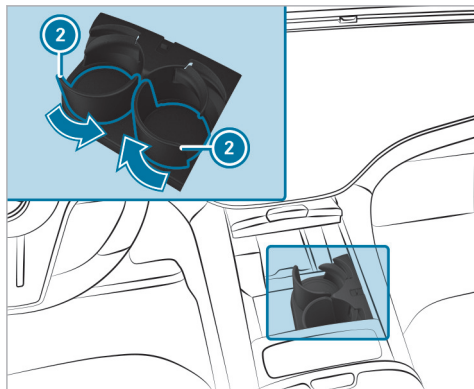

- ▶ Manually push back the side walls of cup holder ② in the direction of the arrow.

Opening or closing the cup holder and small stowage compartment in the rear armrest

⚠ WARNING - Risk of accident or injury when using the cup holder while the vehicle is in motion

The cup holder cannot hold a container secure while the vehicle is in motion.

If you use a cup holder while the vehicle is in motion, the container may be flung around and liquids could be spilled. The vehicle occupants may come into contact with the liquid and if it is hot, they could be scalded. You could be distracted from traffic conditions and you may lose control of the vehicle.

- ▶ Only use the cup holder when the vehicle is stationary.
- ▶ Only use the cup holder for containers of the right size.
- ▶ Always close the container, particularly if the liquid is hot.

! NOTE Damage to the rear armrest due to body weight

When folded out, the rear armrest can be damaged by body weight.

- ▶ Do not sit or support yourself on the rear seat armrest.

! NOTE Damage to the cup holder

The cup holder can be damaged when folding back the rear seat armrest. When open, the cup holder can be damaged by body weight.

- ▶ The rear seat armrest can only be folded back when the cup holder is closed.
- ▶ Do not sit or support yourself on the cup holder when it is open.

Opening the mobile phone holder in the rear armrest

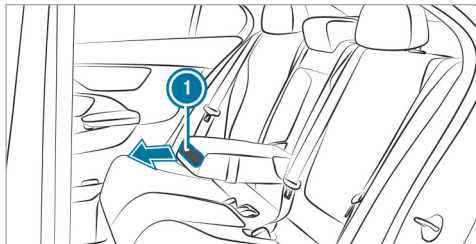

- ▶ Press cover trim ① once.
The mobile phone holder will open in the direction of the arrow.
- ▶ Place the mobile phone in or remove it from the holder.

Closing the mobile phone holder in the rear armrest

- ▶ Press cover trim ①.
The mobile phone holder and the cup holder will both open.

- ▶ Press cover trim ① a second time.
The mobile phone holder will be closed.
- ① The mobile phone holder is designed for two mobile phones or one tablet. You can also charge the devices in the holder by inserting the charging cable into the devices through the opening on the underside of the holder.
- ① Observe the notes on loading the vehicle (→ page 190).

Opening or closing the cup holders in the rear armrest

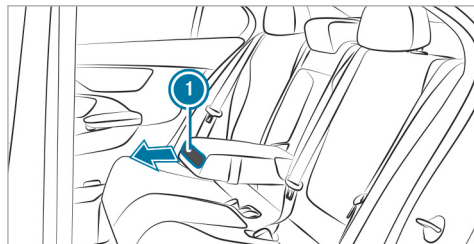

- ▶ **To open:** press cover trim ① twice.
The cup holder will open in the direction of the arrow.
- ▶ Place a container in or remove a container from the cup holder.
- ▶ **To close:** slide the cup holder back into the rear armrest.

Sockets

Using the 12 V socket

Requirements

- Only connect devices up to a maximum of 180 W (15 A).

Depending on the vehicle equipment, the vehicle has 12 V sockets in the front passenger footwell and in the load compartment.

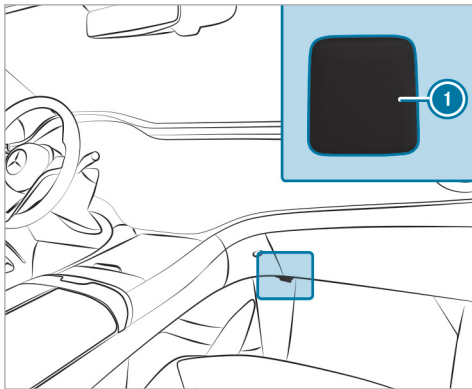

Example: 12 V socket in the front passenger footwell

- ▶ Fold up the cover on socket ①.
- ▶ Insert the plug of the device.
- ▶ Make sure that no cables are running through or secured in the airbag deployment area when using the socket. Observe the notes on the airbags (→ page 107).

USB ports

Depending on its equipment, the vehicle has the following USB ports:

- In the stowage compartment in the front centre console
- In the stowage compartment under the front armrest
- In front of the stowage tray under the central display of the multimedia system
- In the rear centre console

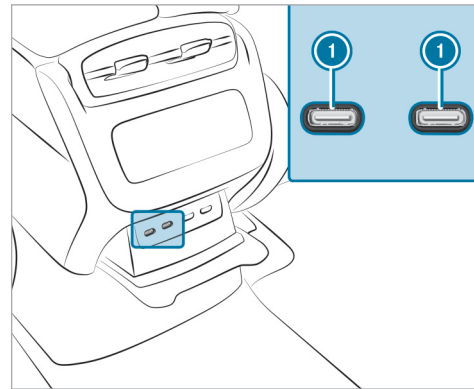

Example: USB ports in the electronics compartment in the centre console of the rear passenger compartment

You can charge a USB device, such as a mobile phone, at the USB ports using a suitable charging cable. Depending on the vehicle equipment, the devices can be charged with up to 20 V (5 A) when the vehicle is switched on.

Wireless charging of the mobile phone and connection with the exterior aerial

Notes on wirelessly charging a mobile phone

⚠ WARNING Risk of injury due to objects being stowed incorrectly

If objects in the vehicle interior are stowed incorrectly, they can slide or be thrown around and hit vehicle occupants. In addition, cup holders, open stowage spaces and mobile phone receptacles cannot always retain all objects within.

There is a risk of injury, particularly in the event of sudden braking or a sudden change in direction.

- ▶ Always stow objects so that they cannot be thrown around in such situations.
- ▶ Always make sure that objects do not protrude from stowage spaces, luggage nets or stowage nets.
- ▶ Close the lockable stowage spaces before starting a journey.

- ▶ Always stow and secure heavy, hard, pointed, sharp-edged, fragile or bulky objects in the boot/load compartment.

Observe the notes on loading the vehicle.

⚠ WARNING Risk of fire from placing objects in the mobile phone stowage compartment

Placing other objects in the mobile phone stowage compartment could constitute a fire hazard.

- ▶ Apart from a mobile phone, do not place any other objects in the mobile phone stowage compartment, especially those made of metal.

! NOTE Damage to objects caused by placing them in the mobile phone stowage compartment

If objects are placed in the mobile phone stowage compartment, these may be damaged by electromagnetic fields.

- ▶ Do not place credit cards, storage media, ski passes or other objects sensitive to electromagnetic fields in the mobile phone stowage compartment.

! NOTE Damage to the mobile phone stowage compartment caused by liquids

If liquids enter the mobile phone stowage compartment, the compartment may be damaged.

- ▶ Ensure that no liquids enter the mobile phone stowage compartment.

Always observe the notes for persons with electronic medical aids (→ page 86).

- Depending on the vehicle equipment, the mobile phone is connected to the vehicle's exterior aerial via the charging module.
- The charging function and wireless connection of the mobile phone to the vehicle's exterior aerial are only available if the vehicle is switched on.

- Small mobile phones may not be able to be charged in every position of the mobile phone stowage compartment.
- Large mobile phones which do not rest flat in the mobile phone stowage compartment may not be able to be charged or connected with the vehicle's exterior aerial.
- The mobile phone may heat up during the charging process. This may also depend on the applications (apps) currently open in the background.
- To ensure more efficient charging and connection with the vehicle's exterior aerial, remove the protective cover from the mobile phone. Protective covers which are necessary for wireless charging are an exception.

Wirelessly charging a mobile phone in the front

⚠ WARNING Risk of injury due to objects being stowed incorrectly

If objects in the vehicle interior are stowed incorrectly, they can slide or be thrown around

and hit vehicle occupants. In addition, cup holders, open stowage spaces and mobile phone brackets cannot always retain all objects they contain.

There is a risk of injury, particularly in the event of sudden braking or a sudden change in direction.

- ▶ Always stow objects in such a way that they cannot be thrown around in such situations.
- ▶ Always make sure that objects do not protrude from stowage spaces, luggage nets or stowage nets.
- ▶ Close the lockable stowage spaces before starting a journey.
- ▶ Always stow and secure heavy, hard, pointed, sharp-edged, fragile or bulky objects in the boot.

Observe the notes on loading the vehicle.

Requirements

- The mobile phone is suitable for wireless charging.

A list of compatible mobile phones can be found at: <https://www.mercedes-benz-mobile.com/>

Depending on the vehicle's equipment, the vehicle has the following options for wirelessly charging a mobile phone in the cockpit:

- In the front stowage compartment of the centre console

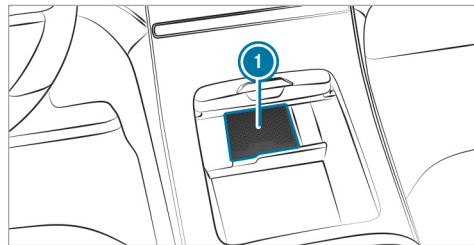

Wirelessly charging a mobile phone in the front stowage compartment (with central display)

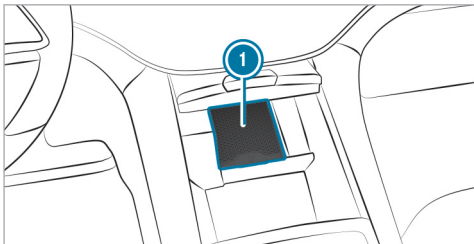

Wirelessly charging the mobile phone in the front stowage compartment (with MBUX hyperscreen)

- ▶ Place the mobile phone as close to the centre of mat ① as possible with the display facing upwards.

When the charging symbol is shown in the multimedia system, the mobile phone is being charged. In addition, malfunctions during the mobile phone's charging process are shown in the multimedia system display.

- ① The mat can be removed for cleaning, e.g. using clean, lukewarm water.

Radio equipment approval numbers for Brazil

This device operates on a secondary basis, that is to say it has no protection against harmful interference, not even from the same type of stations, and must not cause interference with systems operating on a primary basis.

This product is permitted in accordance with the procedure defined in Directive 242/2000 by the Brazilian telecommunications agency ANATEL and meets the applicable technical requirements.

Further information is available on the ANATEL website. www.anatel.gov.br

- ▶ Further information on the declaration of conformity for vehicle components which receive and/or transmit radio waves.

Wirelessly charging a mobile phone in the rear passenger compartment

⚠ WARNING Risk of injury due to objects being stowed incorrectly

If objects in the vehicle interior are stowed incorrectly, they can slide or be thrown around

and hit vehicle occupants. In addition, cup holders, open stowage spaces and mobile phone brackets cannot always retain all objects they contain.

There is a risk of injury, particularly in the event of sudden braking or a sudden change in direction.

- ▶ Always stow objects in such a way that they cannot be thrown around in such situations.
- ▶ Always make sure that objects do not protrude from stowage spaces, luggage nets or stowage nets.
- ▶ Close the lockable stowage spaces before starting a journey.
- ▶ Always stow and secure heavy, hard, pointed, sharp-edged, fragile or bulky objects in the boot.

Observe the notes on loading the vehicle.

Requirements:

- The mobile phone is suitable for wireless charging.

A list of compatible mobile phones can be found at: <https://www.mercedes-benz-mobile.com/>

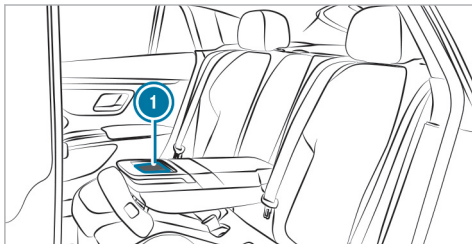

Wireless charging in the rear passenger compartment in vehicles without MBUX rear tablet

- ▶ Fold down the rear armrest.
 - ▶ Place the mobile phone as close to the centre of mat ① as possible with the display facing upwards.
- When the indicator lamp at the front of the mobile phone system lights up, the mobile phone is being charged. In addition, malfunctions during the mobile phone's charging process

are shown by the indicator lamp flashing three times.



Wireless charging in the rear passenger compartment in vehicles with MBUX rear tablet

- ▶ Fold down the rear armrest.
 - ▶ Open the stowage compartment in rear armrest ① (→ page 204).
 - ▶ Place the mobile phone as close to the centre of mat ② as possible with the display facing upwards.
- When the indicator lamp at the front of the mobile phone system lights up, the mobile phone is being charged. In addition, malfunc-

tions during the mobile phone's charging process are shown by the indicator lamp flashing three times.

- ⓘ Observe the notes on loading the vehicle (→ page 190).

Fitting and removing floor mats

⚠ WARNING Risk of accident due to objects in the driver's footwell

Objects in the driver's footwell may impede pedal travel or block a depressed pedal.

This jeopardises the operating and road safety of the vehicle.

- ▶ Stow all objects in the vehicle securely so that they cannot get into the driver's footwell.
- ▶ Always fit the floor mats securely and as prescribed in order to ensure that there is always sufficient room for the pedals.
- ▶ Do not use loose floor mats and do not place floor mats on top of one another.

Fitting floor mats

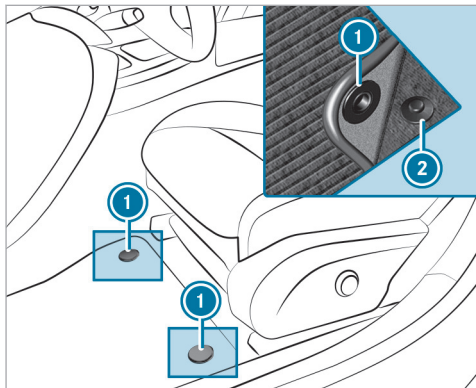

- ▶ Slide the corresponding seat backwards and lay the floor mat in the footwell such that it fits.
- ▶ Press studs ① onto holders ②.
- ▶ Adjust the corresponding seat.

Removing floor mats

- ▶ Slide the corresponding seat backwards and pull the floor mat off holders ②.
- ▶ Adjust the corresponding seat.

Exterior lighting

Notes on adjusting the lights when driving abroad

As a convenience function, the headlamps automatically adjust when the vehicle crosses the border into a country where traffic drives on the other side of the road. If necessary, the headlamps can also be adjusted manually in the **Low beam** menu (→ page 223).

The automatic light adjustment function is available:

- If Automatic is activated in the **Low beam** menu
- If the navigation and the navigation position are available

In the following cases, check the headlamp setting and change it manually if necessary:

- If the **Low beam setting (left/right-side traffic) Manual adjustment only** display message is displayed.
- If the **Check low beam setting (left/right-side traffic)** display message is displayed.

Following manual adjustment:

- Oncoming traffic will not be dazzled.
- The edge of the road will not be illuminated as far or as high.
- The "motorway mode" and "enhanced fog light" functions will not be available.

Information about lighting systems and your responsibility



The various lighting systems of the vehicle are only aids. The driver of the vehicle is responsible for correct vehicle illumination in accordance with the prevailing light and visibility conditions, legal requirements and traffic situation.

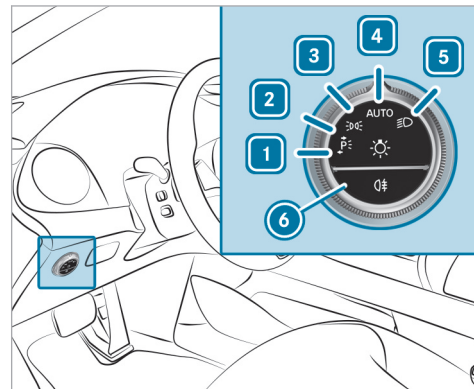

Light switch

Operating the light switch



- | | | |
|---|--|--|
| 1 | | Left-hand parking lights |
| 2 | | Right-hand parking lights |
| 3 | | Standing lights and licence plate lighting |
| 4 | | Automatic driving lights (preferred light switch position) |

- 5  Low beam/high beam
- 6  Switches the rear fog light on/off.

When low beam is activated, the  indicator lamp for the standing lights will be deactivated and replaced by the  low-beam indicator lamp.

- ▶ Always park your vehicle safely using sufficient lighting, in accordance with the relevant legal stipulations.

! **NOTE** Battery discharging by operating the standing lights

Do not have the standing lights switched on over a period of several hours.

For vehicles that are wider than 2 m or longer than 6 m, single-sided parking lighting is not permitted in some countries. In this case, the standing lights are also switched on in the parking lights position.

If the battery is insufficiently charged, the standing lights or parking lights will be switched off automatically to facilitate the next engine start.

The exterior lighting (except standing and parking lights) will switch off automatically when the driver's door is opened.

- Observe the notes on locator lighting (→ page 224).

Automatic driving lights function

When the vehicle is switched on, the standing lights, low beam and daytime running lights will be switched on automatically depending on the light conditions.

! **WARNING** Risk of accident when the dipped beam is switched off in poor visibility

When the light switch is set to **AUTO**, the dipped beam may not be switched on automatically if there is fog, snow or other causes of poor visibility such as spray.

- ▶ In such cases, turn the light switch to .

The automatic driving lights are only an aid. You are responsible for the vehicle lighting.

Switching the rear fog light on/off

Requirements

- The light switch is in the  or **AUTO** position.

- ▶ Press button .

Please observe the country-specific laws on the use of rear fog lamps.

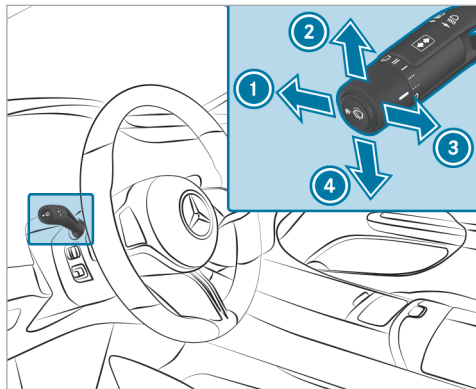

Operating the combination switch for the lights



- ① High beam
- ② Turn signal light, right
- ③ Headlamp flashing
- ④ Turn signal light, left

▶ Use the combination switch to select the desired function.

Switching on high beam

- ▶ Turn the light switch to the  or **AUTO** position.
- ▶ Push the combination switch in the direction of arrow ①. When high beam is activated, the indicator lamp for low beam  will be deactivated and replaced by the indicator lamp for high beam .

Switching off high beam

- ▶ Push the combination switch in the direction of arrow ① or pull it in the direction of arrow ③.

Headlamp flashing

- ▶ Pull the combination switch in the direction of arrow ③.

Turn signal light

- ▶ **To indicate briefly:** push the combination switch briefly to the point of resistance in the direction of arrow ② or ④. The corresponding turn signal light will flash three times.

▶ **To indicate permanently:** push the combination switch beyond the point of resistance in the direction of arrow ② or ④.

Vehicles with Active Lane Change Assist:

- A turn signal indicator activated by the driver may continue to operate for the duration of the lane change.
- If the driver indicated directly beforehand but a lane change was not immediately possible, the turn signal indicator may activate automatically.

Activating/deactivating the hazard warning lights

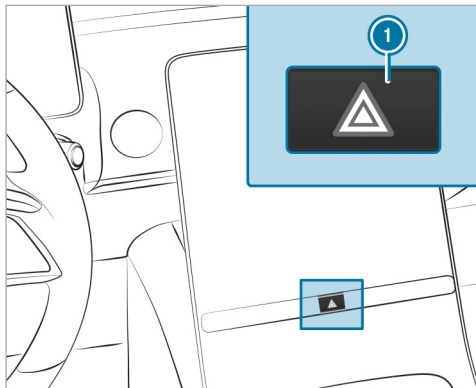

Vehicles without MBUX Hyperscreen

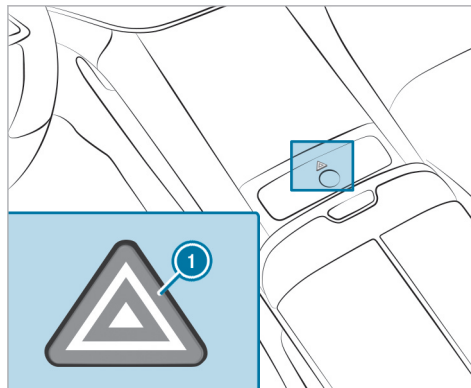

Vehicles with MBUX Hyperscreen

▶ Press button ①.

The hazard warning lights will switch on automatically if:

- the airbag has been deployed.
- the vehicle brakes are applied heavily from a speed of more than 70 km/h to a standstill.

When you pull away again, the hazard warning light system will switch off automatically at approximately 10 km/h. You can also switch off the hazard warning light system using the warning lamp button.

DIGITAL LIGHT adaptive functions

Function of Dynamic Low Beam

You can watch an animation on this topic via the following link:

With this system, the headlamps adapt to the driving and weather situation. It also provides extended functions for improved illumination of the road.

The system comprises the following functions:

- Active headlamps (→ page 216)
- Cornering light (→ page 216)
- Motorway mode (→ page 216)
- Enhanced fog light function (→ page 217)
- Bad weather light (→ page 217)
- City lighting (→ page 217)
- Topographical compensation (→ page 217)

The system is active only when it is dark.

■ Active headlamps function

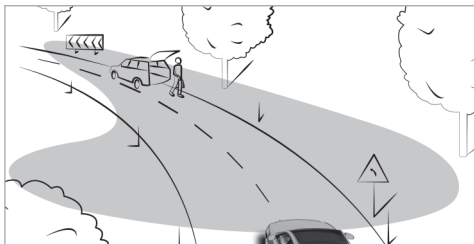

- The headlamps will follow your steering movements.
- Relevant areas will be better illuminated during a journey.

The functions will be active when low beam is switched on.

Depending on the vehicle's equipment, the course of the lane in which you are driving will also be evaluated and the active headlamps function will adjust the light in advance.

■ Cornering light function

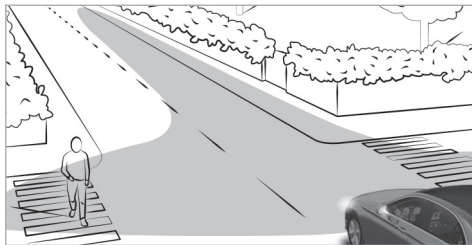

The cornering light improves the illumination of the carriageway over a wide angle in the turning direction, enabling better visibility on tight bends, for example. The cornering light will be activated only when low beam is switched on.

The function will be active in the following cases:

- At speeds below 40 km/h when the turn signal light is switched on or the steering wheel is turned
- At speeds between 40 km/h and 70 km/h and when the steering wheel is turned

Roundabout and junction function: the cornering light will be activated on both sides based on an evaluation of the vehicle's current navigation position. It will remain active until after the vehicle has left the roundabout or junction.

■ Motorway mode function

Motorway mode increases the range and brightness of the cone of light, enabling better visibility.

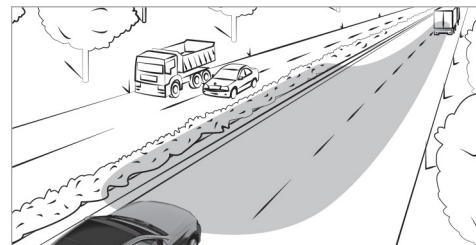

The function will be active if a motorway journey is detected by means of:

- the vehicle's speed
- the multifunction camera
- the navigation system

The function will not be active in the following cases:

- at speeds below 80 km/h

■ Enhanced fog light function

The enhanced fog light function reduces self-dazzling and improves the illumination of the edge of the carriageway.

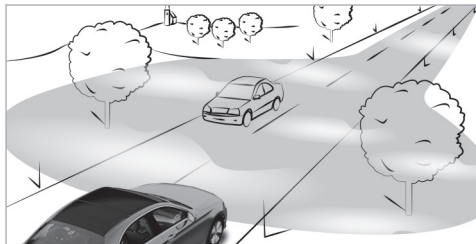

The function will be activated automatically in the following circumstances:

- At speeds below 70 km/h and when the rear fog light is switched on.

The function will be deactivated automatically in the following circumstances:

- When speeds greater than 100 km/h are reached.
- When the rear fog light is switched off.

■ Function of the bad weather light

The bad weather light reduces reflections in rainy conditions by dimming individual areas of the headlamps. There will be less glare for the driver and other road users as a result.

■ The city lighting function

City lighting improves the illumination of roadsides in urban areas using a broad distribution of light.

The function will be active in the following cases:

- At low speeds
- In illuminated parts of urban areas

■ Function of the topographical compensation

Based on available map data, the lighting system responds pre-emptively to different road heights. This means that the headlamp range will remain virtually constant when you are driving uphill or downhill.

- ① Only vehicles with a multimedia system with navigation have this function.

■ Assistance functions of DIGITAL LIGHT

DIGITAL LIGHT visually expands on the driver assistance systems by projecting the assistant displays in front of the vehicle while it is in motion. DIGITAL LIGHT can therefore help the driver in critical situations.

- ① The availability of the functions is country-dependent.
- ① The assistance functions of DIGITAL LIGHT may be an on-demand feature (→ page 75).

The system will be active in the following cases:

- The light switch is in the **AUTO** position.
- High beam is switched on.
- ① Depending on the country in which you are currently driving, certain functions may be disabled due to different legal requirements, even if they are enabled in the multimedia system. When you cross a border, the vehicle will automatically adapt to the applicable requirements.

Spotlight

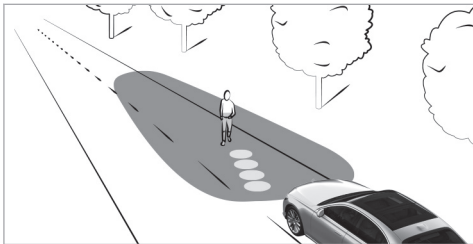

The spotlight function runs in the background and flashes the headlamps in four short bursts at persons detected within the lane markings. You will also be made aware of the position of the person by a projected symbol.

The function will be active in the following circumstances:

- You are driving outside illuminated areas.
- The system detects a lane marking.

Warnings

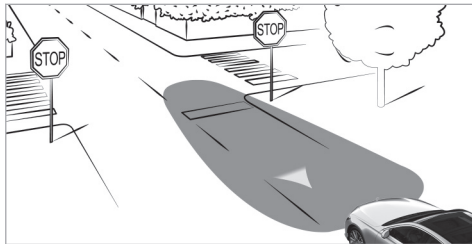

If Traffic Sign Assist detects a corresponding situation, a triangle will be projected onto the road in the following cases at speeds of at least 30 km/h:

- You are driving in the opposite direction to the permissible direction of travel, e.g. on a motorway slip road.
- You are driving towards a stop sign without reducing your speed.
- You are driving towards a red traffic light without reducing your speed.

Observe the system limitations of Traffic Sign Assist (→ page 345).

Notes

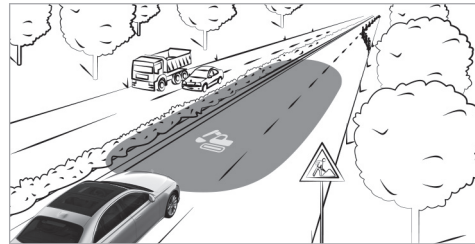

If Traffic Sign Assist detects a roadworks zone, the system will provide support as follows:

- A corresponding symbol will be projected onto the road when you enter a roadworks zone.
- When you drive through a roadworks zone, guide lines that roughly match the width of the vehicle will be projected onto the road. The guide lines will be switched off temporarily on tight bends.

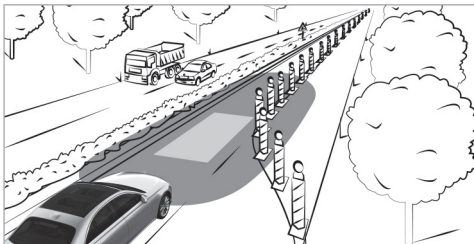

Observe the system limitations of Traffic Sign Assist (→ page 345).

Collision warning

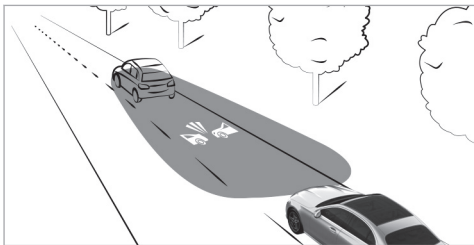

If you fall below the safe distance at speeds of at least 30 km/h, a collision warning symbol will be projected onto the road.

Observe the system limitations of Active Brake Assist (→ page 336).

Lane change warning

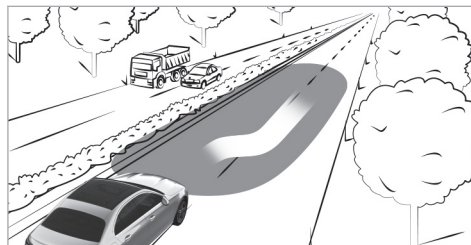

During assisted lane changes at speeds of at least 30 km/h, the course of the lane change as displayed will be brighter. This enables you to identify possible dangers in the new lane at an early stage.

Observe the system limitations of Active Lane Change Assist (→ page 334).

Lane keeping and blind spot warning



At speeds of at least 30 km/h, a triangle that indicates a lane correction and its direction will be projected onto the road in the following cases:

- You leave the lane unintentionally.
Observe the system limitations of Active Lane Keeping Assist (→ page 354).
- You switch on the turn signal light while an object or obstacle is in your blind spot.
Observe the system limitations of Active Blind Spot Assist (→ page 350).

Switching the Intelligent Light System on/off

Requirements



- The vehicle is switched on.

Multimedia system:

→  **Settings** **▶▶ Lights**
▶▶ DIGITAL LIGHT

▶ Activate or deactivate **Dynamic low beam**.

Activating or deactivating enhanced assistance functions

-  The availability of the functions is dependent on the country.
-  This function is an on-demand feature (→ page 75).

▶ Select **Supporting projections**.

▶ Activate or deactivate the desired projections.

▶ Switch **Projection for greeting/farewell** on or off.

If the locator lighting or the exterior switch-off delay time is activated, a high-resolution greeting or farewell scene will be played back for a short period of time when the vehicle is

opened or switched off. You can choose between the **Digital Rain** and **Particle Flow** sequences.

-  More information on locator lighting (→ page 224)
 More information on the exterior switch-off delay time (→ page 224)

Adaptive Highbeam Assist

Adaptive Highbeam Assist function

 **WARNING** Risk of accident despite Adaptive Highbeam Assist

Adaptive Highbeam Assist does not react to:

- road users without lights, e.g. pedestrians
- road users with poor lighting, e.g. cyclists
- road users whose lighting is obstructed, e.g. by a barrier

On very rare occasions, Adaptive Highbeam Assist may fail to recognise other road users with their own lighting, or may recognise them too late.

In these, or in similar situations, the automatic high beam will not be deactivated or will be activated despite the presence of other road users.

▶ Always observe the road and traffic conditions carefully and switch off the high beam in good time.

Adaptive Highbeam Assist cannot take into account road, weather or traffic conditions.

Detection may be restricted in the following cases:

- in poor visibility, e.g. fog, heavy rain or snow
- if there is dirt on the sensors or the sensors are obscured

Adaptive Highbeam Assist is only an aid. You are responsible for adjusting the vehicle's lighting to the prevailing light, visibility and traffic conditions.

-  Adaptive Highbeam Assist is available on demand (→ page 75).

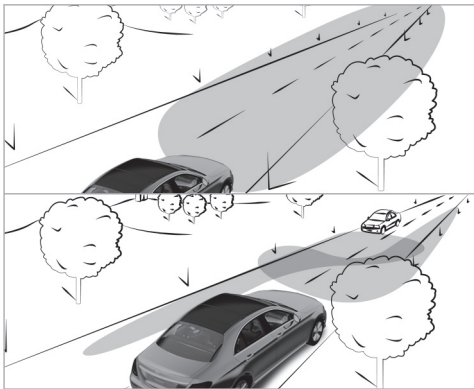

Adaptive Highbeam Assist automatically switches between the following types of light:

- Low beam
- High beam

At speeds greater than 30 km/h:

- If no other road users are detected, high beam will switch on automatically.

High beam will switch off automatically in the following cases:

- At speeds below 25 km/h
- If other road users are detected
- If street lighting is sufficient

i The system's optical sensor is located behind the windscreen near the overhead control panel.

Switching Adaptive Highbeam Assist on/off

⚠ WARNING Risk of accident despite Adaptive Highbeam Assist

Adaptive Highbeam Assist does not react to:

- road users without lights, e.g. pedestrians
- road users with poor lighting, e.g. cyclists
- road users whose lighting is obstructed, e.g. by a barrier

On very rare occasions, Adaptive Highbeam Assist may fail to recognise other road users with their own lighting, or may recognise them too late.

In these, or in similar situations, the automatic high beam will not be deactivated or will be activated despite the presence of other road users.

- ▶ Always observe the road and traffic conditions carefully and switch off the high beam in good time.

Switching on

- ▶ Turn the light switch to the **AUTO** position.
- ▶ Switch on high beam using the combination switch.
If Adaptive Highbeam Assist is activated, the **A** indicator lamp will light up on the driver's display.

Switching off

- ▶ Switch off high beam using the combination switch.

Adaptive Highbeam Assist Plus

Adaptive Highbeam Assist Plus function

⚠ WARNING Risk of accident despite Adaptive Highbeam Assist Plus

Adaptive Highbeam Assist Plus does not react to:

- road users without lights, e.g. pedestrians
- road users with poor lighting, e.g. cyclists
- road users whose lighting is obstructed, e.g. by a barrier

On very rare occasions, Adaptive Highbeam Assist Plus may fail to recognise other road users with their own lighting, or may recognise them too late.

In these, or in similar situations, the automatic high beam will not be deactivated or will be activated despite the presence of other road users.

▶ Always observe the road and traffic conditions carefully and switch off the high beam in good time.

Adaptive Highbeam Assist Plus cannot take into account road, weather or traffic conditions.

Detection may be restricted in the following cases:

- in poor visibility, e.g. fog, heavy rain or snow
- if there is dirt on the sensors or the sensors are obscured

Adaptive Highbeam Assist Plus is only an aid. You are responsible for adjusting the vehicle's lighting to the prevailing light, visibility and traffic conditions.



Adaptive Highbeam Assist Plus automatically switches between the following types of light:

- Low beam
- Partial high beam
- High beam

Partial high beam does not include other road users in the high beam area. It does not dazzle them but enables full high-beam illumination for

the driver apart from the excluded vehicles. Highly reflective signs are also illuminated with reduced brightness.

At speeds below 25 km/h or when there is sufficient street lighting:

- Partial high beam and high beam will be switched off automatically.

At speeds greater than 30 km/h:

- If no other road users are detected, high beam will switch on automatically.
- If other road users are detected, partial high beam will switch on automatically.

 The system's optical sensor is located behind the windscreen near the overhead control panel.

Switching Adaptive Highbeam Assist Plus on/off

 **WARNING** Risk of accident despite Adaptive Highbeam Assist Plus

Adaptive Highbeam Assist Plus does not react to:



- road users without lights, e.g. pedestrians
- road users with poor lighting, e.g. cyclists
- road users whose lighting is obstructed, e.g. by a barrier

On very rare occasions, Adaptive Highbeam Assist Plus may fail to recognise other road users with their own lighting, or may recognise them too late.

In these, or in similar situations, the automatic high beam will not be deactivated or will be activated despite the presence of other road users.

- ▶ Always observe the road and traffic conditions carefully and switch off the high beam in good time.

Switching on

- ▶ Turn the light switch to the  position.
- ▶ Switch on high beam using the combination switch.
If Adaptive Highbeam Assist Plus is activated, the  indicator lamp will light up on the driver's display. When partial high beam or high beam is active, the corresponding blue indicator lamp will also light up.

Switching off

- ▶ Switch off high beam using the combination switch.

Setting low beam

Multimedia system:

  **Settings**  **Lights**
 **DIGITAL LIGHT**  **Low beam**

- ▶ Select **Right-side traffic**, **Left-side traffic** or **Automatic**.

Setting the exterior lighting switch-off delay time

Multimedia system:

- ➔  ➔ Settings ➔ Lights
- ➔ Interior/exterior lighting
- ➔ Exterior lighting delayed switch off

- ▶ Set the switch-off delay time.
When the vehicle's engine is switched off, the exterior lighting will be activated for the set time.

Activating/deactivating the locator lighting

Multimedia system:

- ➔  ➔ Settings ➔ Lights
- ➔ Interior/exterior lighting



- ▶ Activate or deactivate **Locator lighting**.

When the function is activated, the exterior lighting will light up for 40 seconds after the vehicle is unlocked or the driver's door is opened when the vehicle is parked and not locked. When you start the vehicle, the locator lighting will be deactivated and the automatic driving lights activated.

Interior lighting

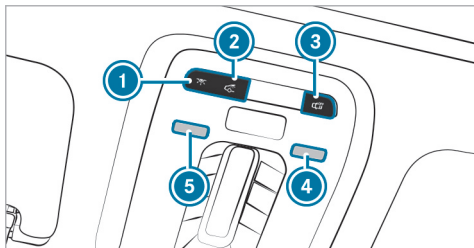
Adjusting the interior lighting



- ①  Switches the front interior lighting on/off.
- ②  Switches the rear interior lighting on/off.
- ③  Switches automatic interior lighting control on/off.

- ▶ **To switch reading lamps on/off:** touch respective reading lamp ④ or ⑤.

Operating unit in the rear passenger compartment

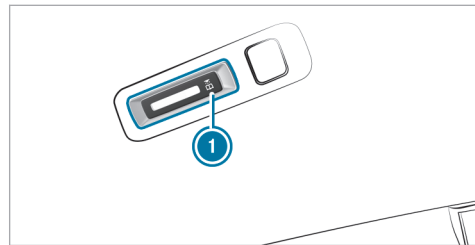

- ①  Rear reading lamp

- ▶ **To switch on or off:** press button ①.

Adjusting the ambient lighting

Multimedia system:

- ➔  ➔ Comfort ➔ Ambient light

Setting the colour

- ▶ Select **Colour**.
- ▶ Select **Monochrome** or **Multi-colour**.
- ▶ Set the desired colour or colour scheme.

Energy Shine

- The interactive Energy Shine colour world shows the different phases during the journey. Depending on the type of driving condition (speed, boost effect or recuperation), this is shown in colour by the active ambient lighting.

Adjusting the brightness

- ▶ Select **Brightness**.
- ▶ Adjust the brightness.
- ⓘ Depending on the ambient light conditions, the ambient lighting will automatically switch between day and night modes.

Activating the brightness for zones

- ▶ Select **Brightness**.
- ▶ Switch off **Link zones**.
The **Direct**, **Indirect** and **Accents** zones can be set separately.
- ⓘ The **Light strip** zone can also be set in vehicles with active ambient lighting.

Activating effects

⚠ WARNING Risk of accident if ambient lighting and active ambient lighting effects are not switched on

The warning support effects are fully active only if the respective driving or driving safety systems are switched on on the driving assistance menu.

- ▶ Ensure that the respective driving or driving safety systems are switched on.

- ⓘ Observe the notes on driving systems and your responsibility; you may otherwise fail to recognise dangers (→ page 303).

- ▶ Select **Effects**.
- ▶ Activate the desired effect.

- ⓘ Depending on the vehicle equipment, different effects are available.

Operating feedback effects

- **Climate**: If changes are made to the temperature setting in the vehicle, the colour of the ambient lighting will change briefly.

- **Voice assistant**: For vehicles with active ambient lighting, the voice assistant is visually animated.
- **Greeting**: When you get into the vehicle, a special colour animation will play.
- **Charging sequence**: The ambient lighting provides visual feedback on the different states of charge when the vehicle is connected to or disconnected from the charging station.

Warning assistance effects

- **Warning when exiting**: If an object is detected in the blind spot while you are getting out of the vehicle, the ambient lighting in the affected door will flash red.
Further information on the exit warning (→ page 350).
- **Active Lane Keeping Assist**: If there is a warning from Active Lane Keeping Assist, the active ambient lighting will flash red.
Further information on Active Lane Keeping Assist (→ page 354).

- **Active Brake Assist:** If there is an Active Brake Assist warning, the active ambient lighting in the centre of the cockpit will flash bright red. Further information on the Active Brake Assist (→ page 336).
- **Active Blind Spot Assist:** In vehicles with active ambient lighting, the ambient lighting on the affected side will flash red if there is a warning from Active Blind Spot Assist. Further information on Active Blind Spot Assist (→ page 350).
- **Parking Assist PARKTRONIC:** The information from the parking sensors during parking manoeuvres is displayed in colour. Further information on Parking Assist PARKTRONIC: (→ page 371)

Multi-colour animation

- The chosen colour combination will change at predefined intervals.
- i** In vehicles with active ambient lighting, an animation will be played.

- i** The desired operating feedback and warning assistance can be activated or deactivated via the  symbol. Depending on the equipment, different operating feedback and warning assistance effects are available.
- i** If the brightness is set to a low level, warning animations will be displayed at a higher basic brightness.

Switching the interior lighting switch-off delay time on/off

Multimedia system:

-  ► Settings ► Lights
- Interior/exterior lighting
- Interior lighting delayed switch off

- Activate or deactivate **Interior lighting delayed switch off**.

If this function is active, the interior lighting will be switched on for a short time after the end of the journey.

Windscreen wipers and windscreen washer system

Switching the windscreen wipers on/off

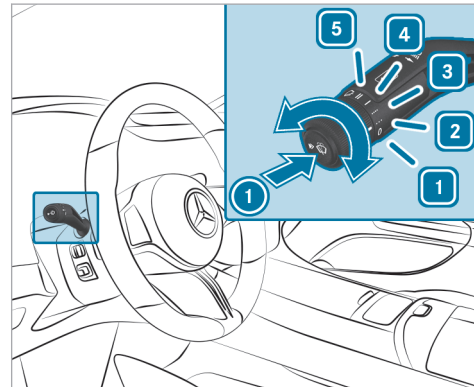



- 1** **0** Windscreen wipers off
- 2** **...** Automatic wiping, normal
- 3** **....** Automatic wiping, frequent

4  Continuous wiping, slow

5  Continuous wiping, fast

▶ Turn the combination switch to the corresponding position **1** - **5**.

▶  **Single wipe:** press button **1** as far as the point of resistance.

▶  **Wiping with washer fluid:** press button **1** beyond the point of resistance.

i Observe the notes on washing the vehicle in a car wash (→ page 25).

Replacing the windscreen wiper blades

⚠ WARNING Risk of becoming trapped if the windscreen wipers are switched on while wiper blades are being replaced

If the windscreen wipers begin to move while you are changing the wiper blades, you can be trapped by the wiper arm.

▶ Always switch off the windscreen wipers and vehicle before changing the wiper blades.

Moving the wiper arms into the replacement position

- ▶ Switch the vehicle on and then off again immediately.
- ▶ Within around 15 seconds, press and hold the  button on the combination switch for approximately three seconds (→ page 226). The wiper arms will move into the replacement position.

Removing the wiper blades

- ▶ Fold the wiper arms away from the windscreen.

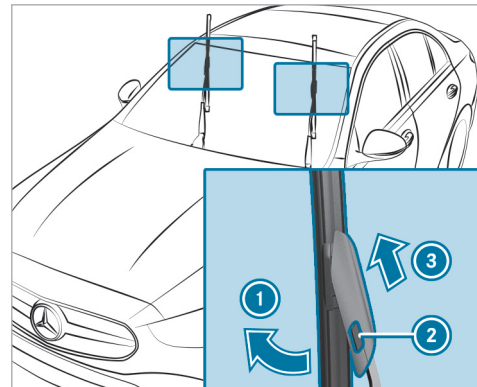

- ▶ Hold the wiper arm with one hand. With the other hand, turn the wiper blade away from the wiper arm in the direction of arrow **1** as far as it will go.
- ▶ Press release button **2**.
- ▶ Remove the wiper blade from the wiper arm in the direction of arrow **3**.

Fitting the wiper blades

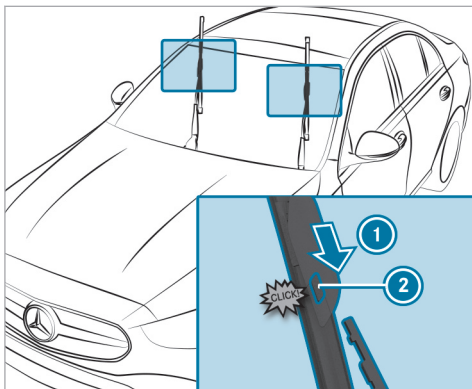

- ▶ Push the new wiper blade into the wiper arm in the direction of arrow ① until release knob ② engages.
- ▶ Make sure that the wiper blade is seated correctly.
- ▶ Fold the wiper arms back onto the wind-screen.

- ▶ Switch on the vehicle.
 - ▶ Press the  button on the combination switch. The wiper arms will return to their original positions.
 - ▶ Switch off the vehicle.
- ⓘ Check the condition of the wiper blades regularly and replace them in the event of visible damage or ongoing smearing.

Service indicator

There is a service indicator at the tip of the newly mounted wiper blade.

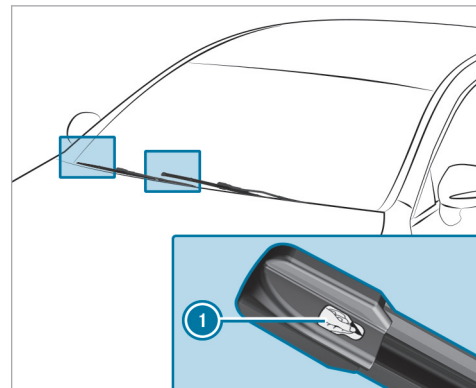

- ▶ Remove protective film ① from the service indicator.

When the colour of the service indicator changes from black to yellow, the wiper blades should be replaced.

Mirrors

Operating the outside mirrors

⚠ WARNING Risk of accident due to adjusting the vehicle settings while the vehicle is in motion

You could lose control of the vehicle in the following situations in particular:

- if you adjust the driver's seat, the head restraint, the steering wheel or the mirror while the vehicle is in motion
- if you fasten your seat belt while the vehicle is in motion

▶ Before starting the vehicle: in particular, adjust the driver's seat, head restraint, steering wheel and mirror, and fasten your seat belt.

⚠ WARNING Risk of accident due to misjudgement of distance when using the outside mirror

The outside mirrors reflect objects on a smaller scale. The objects in view are in fact closer than they appear.

▶ Therefore, always look over your shoulder in order to ensure that you are aware of the actual distance between you and the road users driving behind you.

Adjusting the outside mirrors

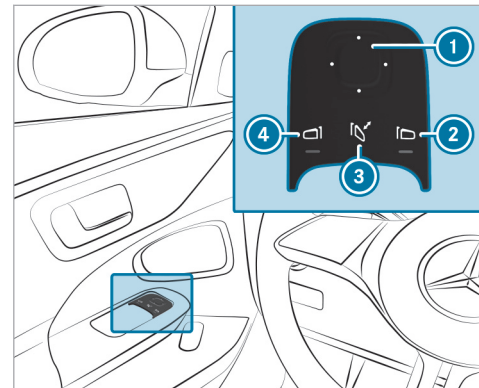

- ▶ Use button ② or ④ to select the desired mirror.
- ▶ Use button ① to adjust the position of the selected mirror.

Folding the outside mirrors in/out (vehicles with electrically folding outside mirrors)

- ▶ Briefly press button ③.

- ❗ If the battery has been disconnected or has discharged, the outside mirrors must be moved briefly using button ③. Only then will the automatic mirror folding function work properly.

Engaging the outside mirrors

If an outside mirror has been forcibly disengaged, proceed as follows.

- ▶ Vehicles without electrically folding outside mirrors: manually move the outside mirror into the correct position until it audibly engages.
- ▶ Vehicles with electrically folding outside mirrors: press and hold button ③. You will hear a click and the mirror will audibly engage. The outside mirror will now be set to the correct position.

Automatic anti-dazzle mirrors function

⚠ WARNING Risk of acid burns and poisoning due to the anti-dazzle mirror electrolyte

Electrolyte may escape if the glass in an automatic anti-dazzle mirror breaks.

The electrolyte is hazardous to health and causes irritation. It must not come into contact with your skin, eyes, respiratory organs or clothing or be swallowed.

- ▶ If you come into contact with electrolyte, observe the following:
 - Immediately rinse the electrolyte from your skin with water and seek medical attention.
 - If electrolyte comes into contact with your eyes, immediately rinse them thoroughly with clean water and seek medical attention.
 - If the electrolyte is swallowed, immediately rinse your mouth out thoroughly. Do not induce vomiting. Seek medical attention immediately.

- Immediately change out of clothing which has been contaminated with electrolyte.
- If an allergic reaction occurs, seek medical attention immediately.

The inside rearview mirror and the outside mirror on the driver's side will automatically go into anti-dazzle mode if light from a headlamp hits the sensor on the inside rearview mirror.

System limits

The system will not go into anti-dazzle mode if:

- The vehicle is switched off.
- Reverse gear is engaged.
- The interior lighting is switched on.

Front-passenger outside mirror parking position function

The parking position makes parking easier.

The front-passenger outside mirror will swivel downwards in the direction of the rear wheel on the front passenger's side when:

- the parking position is stored (→ page 231).
- the front-passenger mirror is selected.
- reverse gear is engaged.

The front-passenger outside mirror will move back to its original position when:

- you shift the transmission to another transmission position.
- you are travelling at a speed greater than 15 km/h.
- you press the button for the outside mirror on the driver's side.

Storing and calling up the parking position of the front-passenger outside mirror using reverse gear

Storing

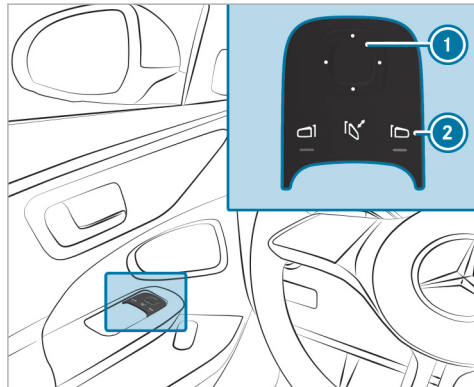

- ▶ Select the front-passenger outside mirror using button ②.
- ▶ Engage reverse gear.
- ▶ Move the front-passenger outside mirror into the desired parking position using button ①.

Calling up

- ▶ Select the front-passenger outside mirror using button ②.
- ▶ Engage reverse gear. The front-passenger outside mirror will move into the stored parking position.

Activating/deactivating the automatic mirror folding function

Multimedia system:

- ▶  [Settings](#) ▶ [Vehicle](#)
- ▶ [Open/close](#)
- ▶ Activate or deactivate [Automatic mirror fold-in](#).

Area permeable to radio waves on the wind-screen

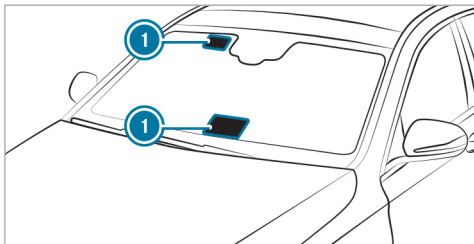

Radio-controlled equipment such as toll systems can be mounted only on areas ① of the wind-screen that are permeable to radio waves.

Areas permeable to radio waves ① are best visible from outside the vehicle when the windscreen is illuminated with an external light source.

Note this position for vehicles with:

- Windscreen heater
- Infra-red reflective windscreen

Infrared-reflective windscreen function

The infrared-reflective windscreen is coated and reduces the build-up of heat in the vehicle interior. The coating shields the vehicle interior from radio waves.

Overview of climate control systems

Notes on climate control

An interior filter in combination with the prefilter in the engine compartment must always be used so that the air conditioning system, pollution level monitoring and the air filtration work correctly. Use filters recommended and approved by Mercedes-Benz. Always have maintenance work carried out at a qualified specialist workshop.

Overview of the THERMATIC climate bar

The indicator lamps indicate that the corresponding functions are activated.

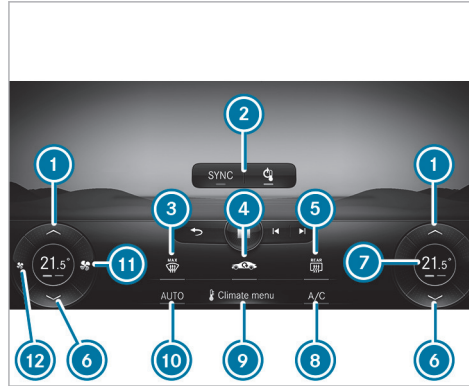

Front climate bar on the central display (example)

- ① Increases the temperature
- ② Upper display area of the climate bar with the examples of switching climate control on/off (→ page 236) and **SYNC** synchronisation function (→ page 240)
- ③ Demists the windscreen (→ page 237)

- ④ Switches air-recirculation mode on/off (→ page 241) or Fine particle prefilter status display (→ page 237)
- ⑤ Switches the rear window heater on/off
- ⑥ Reduces the temperature
- ⑦ Depending on vehicle equipment and settings: temperature display, display for the demist function, airflow, pre-entry climate control or climate mode
- ⑧ Activates/deactivates the A/C function (→ page 238)
- ⑨ Calls up the air conditioning menu (→ page 237)
- ⑩ Sets climate control to automatic mode (→ page 238)
- ⑪ Increases the airflow or switches on climate control (→ page 236)
- ⑫ Reduces the airflow or switches off climate control (→ page 236)
- ⓘ The climate bar is visible even when the vehicle is parked or the air conditioning is switched off (→ page 236).

- i** The availability of individual functions depends on the country and equipment.

Overview of the THERMOTRONIC climate bar

The indicator lamps indicate that the corresponding functions are activated.

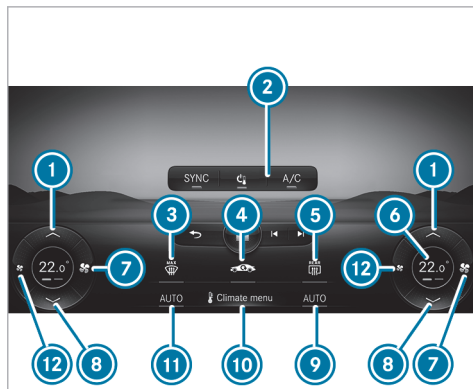

Front climate bar on the central display (example)

- 1** Increases the temperature
- 2** Upper display area of the climate bar with the examples of switching off climate control (→ page 236), switching the A/C function on/off (→ page 238) and synchronisation function (→ page 240)
- 3** Demists the windscreen

- 4** Switches air-recirculation mode on/off (→ page 241) or Fine particle prefilter status display (→ page 237)
- 5** Switches the rear window heater on/off
- 6** Depending on vehicle equipment and settings: temperature display, display for pre-entry climate control or climate mode
- 7** Increases the airflow or switches on climate control (→ page 236)
- 8** Reduces the temperature
- 9** **AUTO** Sets climate control to automatic mode, right (→ page 238)
- 10** Calls up the air conditioning menu (→ page 237)
- 11** **AUTO** Sets climate control to automatic mode, left (→ page 238)
- 12** Reduces the airflow or switches off climate control (→ page 236)
- i** The climate bar will remain visible even when the vehicle is parked or the air conditioning is switched off (→ page 236).

- ⓘ The availability of individual functions depends on the country and equipment.

Overview of the rear operating unit

The rear operating unit is available only for vehicles with the THERMOTRONIC air conditioning control panel.

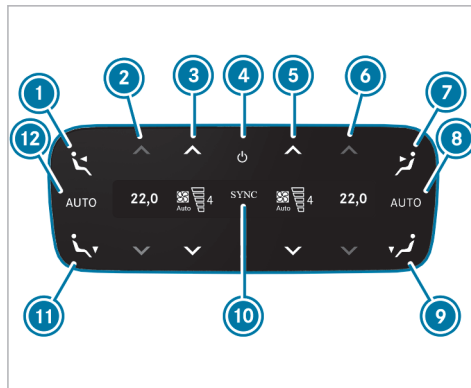

- ① Sets the air distribution to the centre air vents in the rear passenger compartment, left
- ② Sets the temperature in the rear passenger compartment, left
- ③ Sets the airflow in the rear passenger compartment, left, or switches climate control on/off (→ page 236)
- ④ Switches climate control on/off (→ page 236)

- ⑤ Sets the airflow in the rear passenger compartment, right, or switches climate control on/off (→ page 236)
- ⑥ Sets the temperature in the rear passenger compartment, right
- ⑦ Sets the air distribution to the centre air vents in the rear passenger compartment, right
- ⑧ Sets rear climate control to automatic mode, right (→ page 238)
- ⑨ Sets the air distribution to the right rear footwell vents
- ⑩ Synchronisation is activated (→ page 240)
- ⑪ Sets the air distribution to the rear left footwell vents
- ⑫ Sets rear climate control to automatic mode, left (→ page 238)

Depending on the equipment, the settings for the second row of seats can be adjusted using the following devices:

- on the rear operating unit
- on an MBUX high-end rear entertainment system display
- on the rear tablet

- on the front passenger display (CDD co-driver display)
- on the central display

Operating the climate control system

Switching climate control on/off

Switching on climate control

▶ Set the airflow to level 1 or higher via  on the climate bar on the central display.

or

▶ Press **AUTO**, ,  or **MENU**.

Switching off climate control

▶ Set the airflow to level 0 via  on the climate bar on the central display

or

▶ Press .

If climate control is switched off, the windows may mist up more quickly. Switch climate control off only briefly.

i If climate control is switched off via , **OFF** will be shown on the climate bar.

i When the range maximisation function is activated, certain climate control functions are restricted and the window and mirror heaters are switched off. This can lead to windows misting up and reduced visibility due to weather conditions. To quickly reactivate the climate control functions, press the  button on the climate bar on the central display.

Switching climate control on/off via the rear operating unit

Switching on

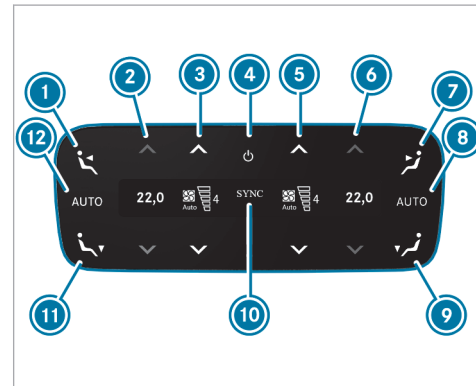

▶ Press button **4**.

or

▶ Set the airflow to level 1 or higher using buttons **3** and **5**.



or



- ▶ Press buttons , ,  or .

Switching off

- ▶ Press button .

or

- ▶ Set the airflow to level 0 using buttons  and .

-  If rear climate control is switched off via button , **OFF** will be shown on the displays.

Activating/deactivating the A/C function via the climate bar

Requirements

- THERMATIC automatic climate control is fitted.

The A/C function heats, cools and dehumidifies the vehicle's interior air.

- ▶ Press  on the climate bar on the central display.

-  Switch off the A/C function only briefly; otherwise, the windows may mist up more quickly. Condensation may drip from the underside of the vehicle when cooling mode is active. This is not indicative of a fault.

Calling up the air conditioning menu using the climate bar

The air conditioning menu can be called up via the climate bar. The climate bar is always shown on the lower edge of the central display.

- ▶ Select the **Climate menu** entry in the air conditioning bar. The **First row of seats** menu is opened.

Jumping directly to the Air quality menu

- ▶ Select the  fine particle prefilter status display in the air conditioning bar. The **Air quality** menu is opened. An animation of the automatic air cleaning taking place is shown.

-  The fine particle prefilter status display is on the home screen next to the temperature dis-

play on the right and it informs you of the current particulate levels inside and outside of the vehicle.



The measurement values are shown with the $\mu\text{g}/\text{m}^3$ units (microgrammes per cubic metre).

Defrosting the windscreen via the climate bar

Switching on

- ▶ Press  on the climate bar on the central display.

Switching off

- ▶ Press , **AUTO** or  on the climate bar on the central display.

or

- ▶ Set the airflow to 0.

-  When the defrost function is activated, some functions (e.g. the temperature setting) will automatically be deactivated.

Activating/deactivating the A/C function via the air conditioning menu

Multimedia system:

➔ Climate menu ➔ First row of seats

Depending on the external conditions, support for improved cooling and dehumidification of the interior air will be provided when the A/C function is activated. If it is not possible to operate the A/C function on the climate bar on the central display, switch the function on or off in the climate menu of the central display.

▶ Select **A/C** (A/C).

Switch off the A/C function only briefly; otherwise, the windows may mist up more quickly.

Condensation may drip from the underside of the vehicle when cooling mode is active. This is not indicative of a fault.

Setting climate control to automatic mode via the climate bar

In automatic mode, the set vehicle interior temperature is controlled automatically and maintained at a constant level by the air supply.

▶ Press **AUTO** on the climate bar on the central display.

ⓘ You can increase or reduce the airflow by pressing  on the climate bar on the central display.

▶ **To switch to manual operation:** switch off automatic mode or adjust an aspect of air distribution, e.g. .

Setting climate control to automatic mode via the rear operating unit

In automatic mode, the temperature is automatically regulated by the temperature of the dispersed air and the airflow.

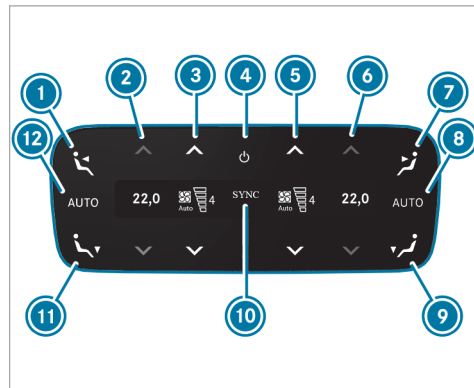

▶ Press button  or .

Selecting climate modes via the air conditioning menu



Multimedia system:

→ Climate menu → First row of seats

It is possible to switch between different climate modes on the Climate menu.

If ECO or ECO+ mode is activated, certain climate control functions will be restricted to conserve energy and extend the vehicle's range.

The following modes are available on the Climate menu:

- **Comfort:** maximum climate comfort
- **ECO:** while heating and cooling output are limited, it remains possible to operate climate control without restriction. If you activate , the system will automatically switch to Comfort mode.
- **ECO+:** mode using only the blower and waste heat, if applicable. The temperature can no longer be adjusted. If you activate , the system will automatically switch to Comfort mode.

- ① The windows may mist up more when ECO or ECO+ mode is activated.
- ① ECO+ climate mode can also be switched on and off via the range maximisation button in the EQ menu under **Range**. When the range maximisation function is deactivated, the system will automatically switch to the last selected climate mode. Pressing the temperature or blower display on the climate bar of the central display allows direct access to the air conditioning menu when ECO or ECO+ mode is active. The climate mode can be changed by pressing the ECO button.
- ① The vehicle's climate control automatically detects seat occupancy. If the vehicle detects unoccupied seats, the climate control functions will be restricted. If you activate , the climate control will automatically switch to Comfort mode.
- ① If the vehicle is parked in the ECO or ECO+ mode for a short period, the previously selected mode will still be activated the next time the vehicle is started. If the vehicle is parked in ECO or ECO+ mode for a longer period of time, the system will automatically switch to



Comfort mode the next time the vehicle is started.

- ▶ Tap on **ECO**.
- ▶ Select **Comfort**, **ECO** or **ECO+**.

If an ECO mode is selected via the air conditioning menu, two LEDs will appear on the temperature display on the climate bar. When ECO mode is switched on, one LED will light up green on the temperature display. When ECO+ mode is switched on, both LEDs will light up green and the ECO+ display will appear.

Overview of the air distribution settings



The symbols on the central display indicate the vents through which the airflow is being directed:

-  Demister vents
-  Centre air vents
-  Footwell vents

Setting air distribution using the air conditioning menu

Multimedia system:

→ Climate menu

- ▶ Select **First row of seats** or **Second row of seats**.
- ▶ To set the air distribution: select ,  or .
- ▶ Set the airflow.

i When the air conditioning system is switched on, at least one zone is always active. However, several air distribution options can be selected at the same time, for example to set the climate control for the interior and the footwells simultaneously. In doing so, the  climate control for the windscreen can only be selected for the first seat row. When automatic mode is active, the buttons for setting the air distribution are automatically deactivated. When the air conditioning system is switched off, the buttons remain operable and the last setting is saved.

Setting rear climate control using the air conditioning menu



Multimedia system:

→ Climate menu



Setting the temperature

- ▶ Select **Second row of seats**.
- ▶ Set the temperature.

Setting the airflow

- ▶ Select **Second row of seats**.
- ▶ Set the air flow with  or .

Controlling the rear climate control automatically

- ▶ Select **AUTO**.
- i** When the defrost function is activated, some functions (e.g. the temperature setting) will be deactivated automatically. To deactivate the defrost function, press either , **AUTO** or  set the air flow to level 0 (→ page 237).

Switching the synchronisation function on/off via the air conditioning menu

Multimedia system:

→ Climate menu ▶▶ **First row of seats**

The synchronisation function controls the climate control centrally. The driver's settings for temperature, airflow and air distribution are automatically adopted for each climate zone.

- ▶ Select **SYNC** (SYNC).

Demisting the windows

Windows misted up on the inside

- ▶ Press **AUTO** on the climate bar on the central display.
- ▶ If the windows remain misted up: press  on the climate bar on the central display.

Windows misted up on the outside

- ▶ Switch on the windscreen wipers.
- ▶ Press **AUTO** on the climate bar on the central display.

Switching air-recirculation mode on/off via the climate bar

Requirements:

- No fine particle prefilter is installed in the vehicle.
- ▶ Press  on the climate bar on the central display.
The interior air will be recirculated.

Air-recirculation mode will automatically switch to fresh air mode after a while.

- ⓘ If air-recirculation mode is switched on, the windows may mist up more quickly. Switch on air-recirculation mode only briefly.

Switching the air-recirculation mode on/off via the air conditioning menu

Requirements:

- A fine particle prefilter is installed in the vehicle.

Multimedia system:

↳ Climate menu ▶▶ Air quality

- ▶ Press  in the upper display area of the climate bar.
The interior air will be recirculated.

Air-recirculation mode will automatically switch to fresh air mode after a while.

- ⓘ If air-recirculation mode is switched on, the windows may mist up more quickly. Switch on air-recirculation mode only briefly.
- ⓘ By selecting the fine particle status display  on the climate bar, you can jump directly to the air quality menu.

Activating or deactivating ionisation via the air conditioning menu

Multimedia system:

↳ Climate menu ▶▶ Air quality

When ionisation is activated, the indoor air is enriched with negatively charged oxygen ions. These can promote the well-being of the occupants.

- ▶ Select **Ionisation**.

- ⓘ The function can only be performed if the AUTO mode is activated or the air distribution is set to the side air vent. The function is restricted if the side air vent on the driver's side is closed.

Fragrance system

Activating/deactivating the fragrance system using the multimedia system

Requirements

- Automatic climate control is activated.
- The glove compartment will close.
- A flacon is inserted.

Multimedia system:

↳ Climate menu ▶▶ Air quality

The fragrance system distributes a pleasant fragrance throughout the vehicle interior from a flacon located in the glove box.

- ▶ Navigate down until the climate control bar is active.

- ▶ Select **Air freshener**.
- ▶ Activate or deactivate fragrancing.

■ **Setting the fragrance system using the multimedia system**

Requirements

- A flacon is inserted.
- The glove compartment will close.
- Climate control is activated.

Multimedia system:

➔ **Climate menu** ➔ **Air quality**

The fragrance system distributes a pleasant fragrance throughout the vehicle interior from a flacon located in the glove compartment.

- ▶ Select **Air freshener**.
- ▶ Keep pressing until the desired intensity is reached.

■ **Inserting or removing the flacon of the fragrance system**

⚠ WARNING Risk of injury from liquid perfume

If children open the flacon, they could drink the liquid perfume or it could come into contact with their eyes.

- ▶ Do not leave children unattended in the vehicle.
- ▶ Consult a doctor immediately if liquid perfume has been drunk.
- ▶ If liquid perfume comes into contact with your eyes or skin, rinse your eyes with clean water.
- ▶ If symptoms continue, consult a doctor.



ENVIRONMENTAL NOTE Environmental damage due to improper disposal of full flacons



: Full flacons may not be disposed of with household waste.



Full flacons must be handed in at a pollutant collection point.

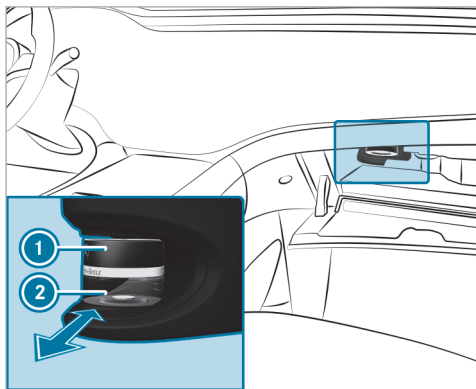

- ① Cap
- ② Flacon

- ▶ **To insert:** slide the flacon into the holder as far as it will go.
- ▶ **To remove:** after opening the glove box, wait for approximately seven seconds and pull out the flacon.

If you do not use genuine Mercedes-Benz interior perfumes, observe the manufacturers' safety notices on the perfume packaging.

Dispose of the genuine Mercedes-Benz interior perfume flacon when it is empty and do not refill it.

Refillable flacon

- ▶ Unscrew the cap of the empty flacon.
- ▶ Fill the flacon with a maximum of 15 ml.
- ▶ Screw the cap back onto the flacon.

Always refill the empty refillable flacon with the same perfume. Observe the separate information sheet with the flacon.

Information on the windscreen heater

⚠ WARNING Risk of burns from touching the windscreen when the windscreen heater is switched on

The windscreen can become very hot when the windscreen heater is switched on.

The health of persons with limited temperature sensitivity or a limited ability to react to high temperatures may be affected or they may even suffer burn-like injuries.

- ▶ Do not touch the windscreen while the windscreen heater is switched on.
- ▶ Allow the windscreen to cool down before touching it.

The windscreen heater will be enabled automatically if  is activated on the climate bar on the central display.

After the vehicle is started, the windscreen heater will be switched on automatically as required.

- ⓘ If the on-board electrical system voltage is low, the function of the windscreen heater may be impaired.

Pre-entry climate control when the vehicle is unlocked

Function of pre-entry climate control when the vehicle is unlocked

You can watch an animation on this topic via the following link:

The seats can be briefly pre-warmed or pre-cooled before you get into the vehicle.

Depending on the vehicle's equipment, the following functions will be activated as needed during pre-cooling:

- Automatic climate control
- Blower
- Seat ventilation

Depending on the vehicle's equipment, the following functions will be activated as needed during pre-warming:

- Automatic climate control
- Blower
- Seat heating
- Steering wheel heater

- Mirror heater
- Rear window heater
- Windscreen heater
- Wiper park position heater

Depending on the vehicle's equipment, the following functions will also be adjusted during pre-entry climate control if they have already been switched on during regular vehicle operation:

- Fragrancing
- Ionisation

Setting pre-entry climate control when the vehicle is unlocked in the multimedia system

Multimedia system:

↳ Climate menu ▶▶ Pre-entry climate ctrl

▶ Activate or deactivate the function.

Selecting seats

▶ Select **Driver**, **Passenger**, **Rear left** or **Rear right**.

The seat-specific functions of pre-entry climate control, such as seat heating, will be performed for the selected seats.

If pre-entry climate control is enabled, an LED on the climate bar of the central display will light up blue for a cooled vehicle and red for a heated vehicle.

Activating/deactivating pre-entry climate control when the vehicle is unlocked

Requirements

- The high-voltage battery is charged sufficiently.
- The function has been activated via the multimedia system.

▶ **To switch on:** unlock the vehicle. The climate control functions are activated for up to five minutes for pre-heating and pre-cooling.

Pre-entry climate control via unlocking cannot be activated more than three times in succession when the vehicle is switched off.

▶ **To switch off:** press  on the climate bar on the central display.

The following functions will remain active once the vehicle has been started:

- Seat heating
- Seat ventilation

Depending on the vehicle's equipment, the following functions will also be adjusted during pre-entry climate control if they have already been switched on during regular vehicle operation:

- Fragrancing
- Ionisation

Pre-entry climate control for departure time

■ Pre-entry climate control for departure time function

⚠ WARNING Risk of fatal injury due to exposure to extreme heat or cold in the vehicle

If persons, particularly children, are subjected to prolonged exposure to intense heat or cold, there is a risk of severe injury or even death.

- ▶ Never leave persons, particularly children, unattended in the vehicle.

⚠ WARNING Risk of burns due to repeatedly switching on the seat heating

Repeatedly switching on the seat heating can cause the seat cushion and seat backrest padding to become very hot.

In particular, the health of persons with limited temperature sensitivity or a limited ability to react to high temperatures may be affected or they may even suffer burn-like injuries.

- ▶ Do not repeatedly switch on the seat heating.

To protect against overheating, the seat heating may be temporarily deactivated after it has been switched on repeatedly.

You can watch an animation on this topic via the following link:

The air inside the vehicle can be heated, ventilated or cooled to the set temperature when the vehicle is parked.

When the vehicle is connected to power supply equipment, priority will be given to charging the high-voltage battery to a specified minimum charge.

The running time of pre-entry climate control may be reduced in the following circumstances:

- The vehicle is not connected to power supply equipment.
- The high-voltage battery is not fully charged.

With active pre-entry climate control, the state of charge of the high-voltage battery may be reduced, even if the charging cable connector is connected.

If present, seat ventilation will be activated in cooling and ventilation modes.

If present, the following functions will be activated in heating mode:

- Seat heating
- Steering wheel heater
- Mirror heater
- Rear window heater
- Windscreen heater
- Wiper park position heater

When the set temperature is changed, the climate control mode will automatically be updated. It will

be switched from heating mode to ventilation or cooling mode, from cooling mode to ventilation or heating mode or from ventilation mode to heating or cooling mode.

Depending on the vehicle's equipment, the following functions will also be adjusted during pre-entry climate control if they have already been switched on during regular vehicle operation:

- Fragrancing
- Ionisation

Setting pre-entry climate control for departure time via the climate bar

Multimedia system:

→ Climate menu → Pre-entry climate ctrl

Setting the departure time

i The set departure times are used for the vehicle's pre-entry climate control and for predictions regarding the approximate state of charge and range at the time selected. Additional information on the charging settings (→ page 296).

▶ Select **Edit departure time** .

▶ Select a departure time or set a new departure time.

i If the range maximisation function is activated, an approximate time for reaching the desired state of charge will be determined automatically during a charging stop. This is used as an approximate departure time for pre-entry climate control and is set automatically. Departure times previously set cannot be edited when the function is switched on. The automatically determined departure time can be activated or deactivated via the air conditioning menu.

Setting the repeat days

▶ Select **Edit departure time** .

▶ Set the desired departure time and select the corresponding weekdays on which this departure time is to apply.

▶ Press **OK** to confirm.

Selecting seats

▶ Select **Driver, Passenger, Rear left** or **Rear right**.

Pre-entry climate control will take place for the selected seats.

If a departure time is set, a yellow LED will appear on the climate bar of the central display. In addition, an LED on the climate bar will indicate when pre-entry climate control is activated. It will light up blue when the vehicle is being cooled and red when it is being heated.

Activating/deactivating pre-entry climate control for departure time

⚠ WARNING Risk of fatal injury due to exposure to extreme heat or cold in the vehicle

If persons, particularly children, are subjected to prolonged exposure to intense heat or cold, there is a risk of severe injury or even death.

▶ Never leave persons, particularly children, unattended in the vehicle.

⚠ WARNING Risk of burns due to repeatedly switching on the seat heating

Repeatedly switching on the seat heating can cause the seat cushion and seat backrest padding to become very hot.

In particular, the health of persons with limited temperature sensitivity or a limited ability to react to high temperatures may be affected or they may even suffer burn-like injuries.

- ▶ Do not repeatedly switch on the seat heating.

To protect against overheating, the seat heating may be temporarily deactivated after it has been switched on repeatedly.

Requirements

- The high-voltage battery is charged sufficiently.
- The function has been activated via the multimedia system.

▶ **To activate:** set the departure time (→ page 246).

Pre-entry climate control for departure time will switch on a maximum of 55 minutes before the selected departure time. It will remain active for another five minutes if departure is delayed.

▶ **To deactivate the pre-entry climate control for departure time early:** press  on the climate bar on the central display or switch off the preselection of the time in the climate menu.

Depending on the vehicle equipment, the following functions will remain active once the vehicle has been started:

- Seat heating
- Seat ventilation

Depending on the vehicle's equipment, the following functions will also be adjusted during pre-entry climate control if they have already been switched on during regular vehicle operation:

- Fragrancing
- Ionisation

Operating immediate pre-entry climate control via the climate bar

⚠ WARNING Risk of fatal injury due to exposure to extreme heat or cold in the vehicle

If persons, particularly children, are subjected to prolonged exposure to intense heat or cold, there is a risk of severe injury or even death.

- ▶ Never leave persons, particularly children, unattended in the vehicle.

⚠ WARNING Risk of burns due to repeatedly switching on the seat heating

Repeatedly switching on the seat heating can cause the seat cushion and seat backrest padding to become very hot.

In particular, the health of persons with limited temperature sensitivity or a limited ability to react to high temperatures may be affected or they may even suffer burn-like injuries.



- ▶ Do not repeatedly switch on the seat heating.

To protect against overheating, the seat heating may be temporarily deactivated after it has been switched on repeatedly.

Requirements

- The vehicle is switched off.

Air conditioning of the vehicle interior can continue for up to 50 minutes, e.g. if the journey is interrupted.

- ▶ Press the  button on the climate bar on the central display.
- ▶ Set the temperature using the  and  arrows on the climate bar on the central display.

An LED on the climate bar on the central display indicates when pre-entry climate control is activated. It will light up blue when the vehicle is being cooled and red when it is being heated.

Air vents

Adjusting the front air vents

⚠ WARNING Risk of burns or frostbite due to being too close to the air vents

Very hot or very cold air can flow from the air vents.

- ▶ Make sure that all vehicle occupants always maintain a sufficient distance from the air vents.
- ▶ If necessary, direct the airflow to another area of the vehicle interior.

To guarantee the flow of fresh air through the air vents into the vehicle interior, note the following:

- Always keep the vents and ventilation grilles in the vehicle interior clear.
- Keep the air inlet grilles free of residue build-up (→ page 599).

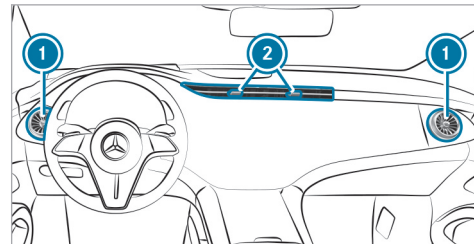

- ▶ **To open or close the side air vents:** hold the outer ring of side air vent **①** and turn it to the left or right as far as it will go.
- ▶ **To open or close the centre air vents:** move controller **②** inwards or outwards as far as it will go.
- ▶ **To adjust the airflow direction of the side air vents:** hold the centre of side air vent **①** and move it up or down or to the left or right.
- ▶ **To adjust the airflow direction of the centre air vents:** hold the controller of centre air vent **②** and move it up or down or to the left or right.

Adjusting the rear air vents

⚠ WARNING Risk of burns or frostbite due to being too close to the air vents

Very hot or very cold air can flow from the air vents.

- ▶ Make sure that all vehicle occupants always maintain a sufficient distance from the air vents.
- ▶ If necessary, direct the airflow to another area of the vehicle interior.

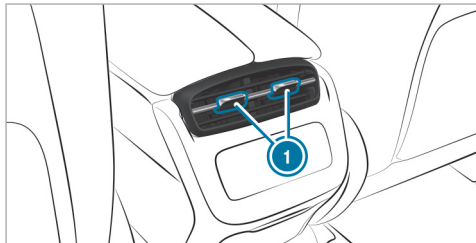

- ▶ **To open or close the rear air vents:** hold the controller of rear air vent ① and move it inwards or outwards as far as it will go.
- ▶ **To set the airflow direction of the rear air vents:** hold controller ① and move it up or down or to the left or right.

Driving

Notes on electric mode

⚠ WARNING Risk of chemical burns and poisoning from damaged high-voltage battery

If the housing of the high-voltage battery has been damaged, electrolyte and gases may leak out.

- ▶ Avoid contact with the skin, eyes or clothing.
- ▶ Immediately rinse electrolyte splashes off with water and seek medical attention straight away.

⚠ DANGER Risk of fire and explosion from excessive internal pressure of the high-voltage battery

In the event of a vehicle fire, flammable gas can escape and ignite.

- ▶ Stop the charging process immediately in case of unusual odours, smoke or burn marks.

- ▶ Leave the danger zone immediately. Secure the danger zone at a sufficient distance.
- ▶ Call the fire service.

Observe the following notes on vehicle noise emissions and the acoustic vehicle alerting system:

- The vehicle is equipped with an all-electric drive system and produces considerably lower vehicle noise emissions than a vehicle with a combustion engine.

For this reason the vehicle is equipped with a sound generator, which serves as an acoustic vehicle alerting system (AVAS). This safety device is prescribed by law.

The external noise of the sound generator is perceptible in the vehicle interior at low speeds and does not represent a malfunction.

- The sound generator generates a stationary noise and speed-dependent vehicle noise emissions at a speed of up to around 30 km/h when the vehicle is driving both forwards and in reverse.

This helps other road users, particularly pedestrians and cyclists, to hear your vehicle better.

- When you drive at speeds above 20 km/h the acoustic vehicle alerting system will gradually switch off.
- Despite the sound generator, the vehicle still may not be heard by other road users. Adapt your driving style accordingly.
- The sound generator will be off when the vehicle is stationary.

Manually disconnecting the high-voltage on-board electrical system

⚠ DANGER Risk of death and fire due to modified and/or damaged components of the high-voltage on-board electrical system

The vehicle's high-voltage on-board electrical system is under high voltage. If you modify component parts in the vehicle's high-voltage on-board electrical system or touch damaged

component parts, you may be electrocuted. In addition, modified and/or damaged components may cause a fire.

In the event of an accident or impact to the vehicle underbody, components of the high-voltage electrical system may be damaged although the damage is not visible.

- ▶ Never make any modifications to the high-voltage on-board electrical system.
- ▶ Do not switch on or use the vehicle if its high-voltage on-board electrical system components have been modified or damaged.
- ▶ Never touch damaged components of the high-voltage on-board electrical system.
- ▶ After an accident, do not touch any components of the high-voltage on-board electrical system.
- ▶ After an accident, have the vehicle transported away.
- ▶ Have the components of the high-voltage on-board electrical system checked at a

qualified specialist workshop and replaced if necessary.

Requirements

Only disconnect the high-voltage on-board electrical system manually in the following situations:

- The  restraint system warning lamp lights up in the driver's display, e.g. after an accident.
- The vehicle is badly damaged, e.g. after an accident, and the restraint system components have not been triggered.

Operating the high-voltage disconnect device

Only disconnect the high-voltage on-board electrical system manually in the above-mentioned situations.

- ▶ Switch off the vehicle.
- ▶ Switch the transmission to position **P**.
- ▶ Apply the electric parking brake.
- ▶ Secure the vehicle against rolling away.

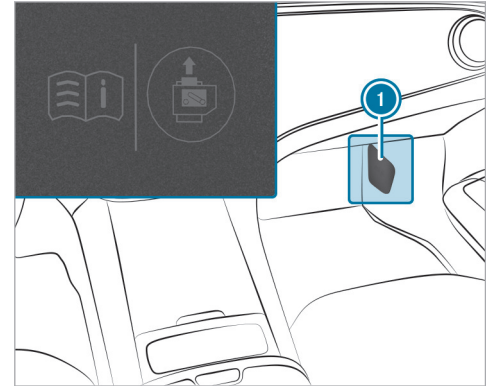

- ▶ Carefully remove flap **1** of the fuse box in the front passenger footwell. High-voltage disconnect device **3** is on the rear side of flap **1**.

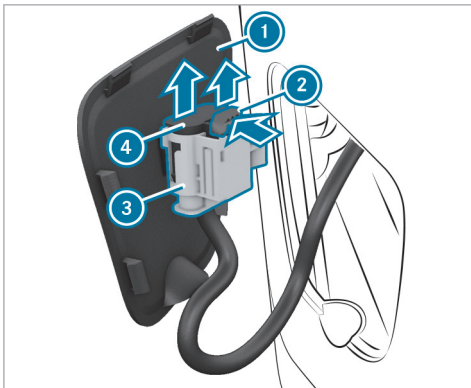

- ▶ Press release tab ② on high-voltage disconnect device ③ in the direction of the arrow and pull it out.
- ▶ Pull connector ④ in the direction of the arrow until it engages.
The high-voltage on-board electrical system is switched off.

All work on the drive system (including after disconnecting the high-voltage on-board electrical

system manually) may only be carried out in a qualified specialist workshop.

Switching on the power supply or the vehicle

⚠ WARNING Accident- and risk of injury with unsupervised children in the vehicle

If you leave children unattended in the vehicle, they can in particular

- Open doors and thereby endanger other persons or road users.
- get out of the car and are hit by traffic.
- Operate vehicle equipment and become trapped, for example.

In addition, the children could also set the vehicle in motion, for example by:

- releasing the parking brake.
- change the gearbox setting.
- start the vehicle.

▶ Never leave children unattended in the vehicle.

- ▶ When leaving the vehicle, always take the SmartKey with you and lock the vehicle.
- ▶ Keep the key out of reach of children.

This also applies to the Digital Vehicle Key.

Requirements

- The key is in the vehicle and is recognised.
- **Vehicles with Digital Vehicle Key:** a Digital Vehicle Key with drive authorisation is detected.
- The brake pedal is not depressed.

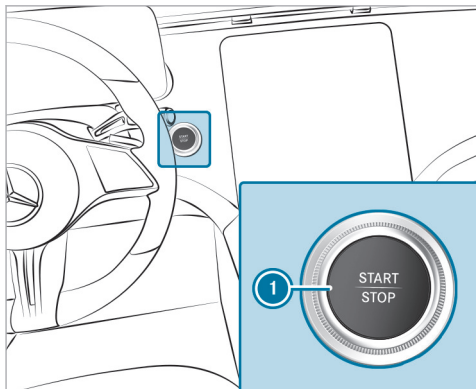

Vehicles with central display

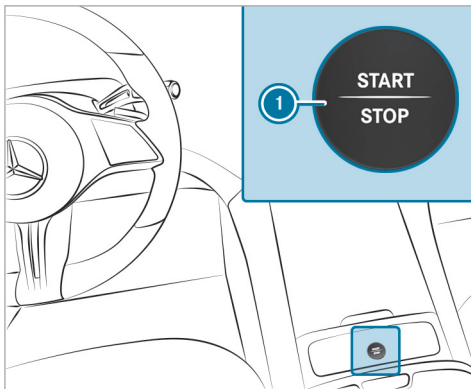

Vehicles with MBUX Hyperscreen

- ▶ **To switch on the power supply:** press button ① once.
You can, for example, switch on the wind-screen wipers.

The power supply will be switched off again if the following conditions are met:

- You open the driver's door.

- You press button ① twice more.

- ▶ **To switch on the vehicle:** press button ① twice.
Indicator and warning lamps will light up on the driver's display.

The vehicle will be switched off again if one of the following conditions is met:

- You do not start the vehicle within 15 minutes and the transmission is in position **P** or the electric parking brake is applied.
- You press button ① once.

Starting the vehicle

Starting the vehicle with the start/stop button

⚠ WARNING Accident- and risk of injury with unsupervised children in the vehicle

If you leave children unattended in the vehicle, they can in particular

- Open doors and thereby endanger other persons or road users.

- get out of the car and are hit by traffic.
- Operate vehicle equipment and become trapped, for example.

In addition, the children could also set the vehicle in motion, for example by:

- releasing the parking brake.
- change the gearbox setting.
- start the vehicle.

- ▶ Never leave children unattended in the vehicle.
- ▶ When leaving the vehicle, always take the SmartKey with you and lock the vehicle.
- ▶ Keep the key out of reach of children.

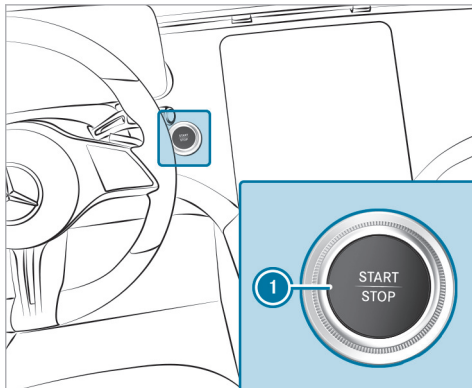

Vehicles with central display

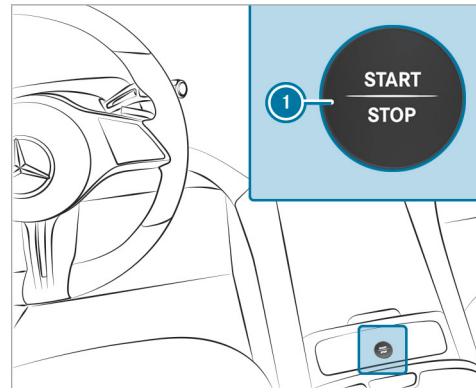

Vehicles with MBUX Hyperscreen

This also applies to the Digital Vehicle Key.

Requirements

- The key is in the vehicle and is recognised.
- **Vehicles with Digital Vehicle Key:** a Digital Vehicle Key with drive authorisation is detected.

- ▶ Shift the transmission to position **P** or **N**.
- ▶ Depress the brake pedal and press button **1** once.
 - The vehicle will be started.
 - The **READY** display appears on the driver's display: the vehicle can be driven.

- ▶ If the vehicle does not start: switch off non-essential consumer equipment and press button ① once.
- ▶ If the vehicle still does not start and the **Place the key in the marked space** See **Owner's Manual** display message appears on the driver's display: start the vehicle with the key in the marked space (emergency operation mode) (→ page 256).
- ① You can switch off the vehicle while driving. To do this, press and hold button ① for about three seconds or press button ① three times within three seconds. The transmission will shift to neutral **N** automatically. When you press button ① again, the vehicle will start again and you can engage drive position **D** again. Be sure to observe the safety notes concerning this under "Driving tips" (→ page 257).

Observe any information regarding display messages that may be shown on the driver's display.

Starting the vehicle with the Digital Vehicle Key in the marked space (emergency operation mode)

⚠ WARNING Accident- and risk of injury with unsupervised children in the vehicle

If you leave children unattended in the vehicle, they can in particular

- Open doors and thereby endanger other persons or road users.
- get out of the car and are hit by traffic.
- Operate vehicle equipment and become trapped, foreexample.

In addition, the children could also set the vehicle in motion, for example by:

- releasing the parking brake.
- change the gearbox setting.
- start the vehicle.

- ▶ Never leave children unattended in the vehicle.
- ▶ When leaving the vehicle, always take the SmartKey with you and lock the vehicle.

- ▶ Keep the key out of reach of children.

This also applies to the Digital Vehicle Key.

Requirements

- The vehicle is equipped with the "Digital Vehicle Key" pre-installation.
- A suitable end device is activated as a Digital Vehicle Key.
- ① Mercedes-Benz recommends that you carry the emergency key in case of function restrictions.

If the vehicle does not start and the display message reading **Searching for key in stowage tray or Digital Vehicle Key in inductive charging bracket...** See **Owner's Manual** appears on the driver's display, you can start the vehicle in emergency operation mode.

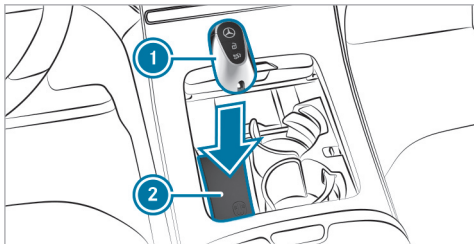

▶ Place key ① in storage compartment ②.

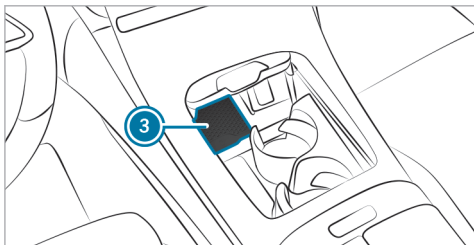

▶ Place the Digital Vehicle Key in marked space ③.

- ▶ Depress the brake pedal and start the vehicle using the start/stop button. It may take a few seconds until the vehicle starts.
- ▶ When the **Key not detected** display message appears on the driver's display, press the start/stop button again.

When the **READY** display appears on the driver's display, the vehicle is ready to drive.

■ Starting the vehicle with the key in the marked space (emergency operation mode)

⚠ WARNING Accident- and risk of injury with unsupervised children in the vehicle

If you leave children unattended in the vehicle, they can in particular

- Open doors and thereby endanger other persons or road users.
- get out of the car and are hit by traffic.
- Operate vehicle equipment and become trapped, for example.

In addition, the children could also set the vehicle in motion, for example by:

- releasing the parking brake.
- change the gearbox setting.
- start the vehicle.

- ▶ Never leave children unattended in the vehicle.
- ▶ When leaving the vehicle, always take the SmartKey with you and lock the vehicle.
- ▶ Keep the key out of reach of children.

This also applies to the Digital Vehicle Key. If the vehicle does not start and the **Place the key in the marked space** See Owner's Manual display message appears on the driver's display, you can start the vehicle in emergency operation mode.

Vehicles with Digital Vehicle Key: If the vehicle does not start and the **Searching for key in stowage tray or Digital Vehicle Key in inductive charging bracket...** See Owner's Manual display message appears on the driver's display, you can start the vehicle in emergency operation mode.

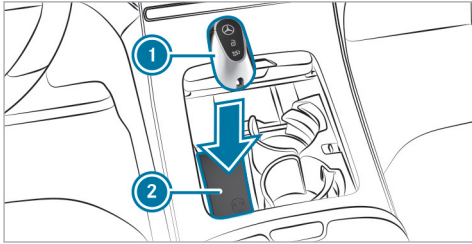

- ▶ Make sure that marked space ② is empty.
 - ▶ Remove key ① from the key ring.
 - ▶ Place key ① on symbol in marked space ②. The vehicle will start after a short time.
- If you remove key ① from marked space ②, the vehicle can still be driven. For further engine starts, however, key ① must be located on symbol in marked space ② during the entire journey.
- ▶ Have key ① checked at a qualified specialist workshop.

If the vehicle does not start:

- ▶ Place key ① in marked space ② and leave it there.
 - ▶ Depress the brake pedal and start the vehicle using the start/stop button.
- ⓘ You can switch on the power supply or the vehicle with the start/stop button.

Observe any information regarding display messages that may be shown on the driver's display.

Running-in notes

- In certain handling and driving safety systems, the sensors adjust automatically while a certain distance is being driven after the vehicle has been delivered or after repairs. Full system effectiveness is only reached when this teaching-in process has concluded.
- Brake pads, brake disks and tyres that are either new or have been replaced only achieve optimum braking effect and grip after driving several hundred kilometres. Compensate the reduced braking effect by applying greater force to the brake pedal.

Notes on driving

⚠ WARNING Risk of accident due to objects in the driver's footwell

Objects in the driver's footwell may impede pedal travel or block a depressed pedal.

This jeopardises the operating and road safety of the vehicle.

- ▶ Stow all objects in the vehicle securely so that they cannot get into the driver's footwell.
- ▶ Always fit the floor mats securely and as prescribed in order to ensure that there is always sufficient room for the pedals.
- ▶ Do not use loose floor mats and do not place floor mats on top of one another.

⚠ WARNING Risk of accident due to incorrect footwear

Incorrect footwear includes, for example:

- shoes with platform soles

- shoes with high heels
- slippers

There is a risk of an accident.

- ▶ Always wear suitable footwear so that you can operate the pedals safely.

⚠ WARNING Risk of accident if the vehicle is switched off while driving

If you switch off the vehicle while driving, safety functions are restricted or no longer available.

This may affect the power steering system and the brake force boosting, for example.

You will need to use considerably more force to steer and brake, for example.

- ▶ Do not switch off the vehicle while driving.

⚠ WARNING Risk of accident due to the brake system overheating

If you leave your foot on the brake pedal when driving, the brake system may overheat.

This increases the braking distance and the brake system can even fail.

- ▶ Never use the brake pedal as a footrest.
- ▶ Do not depress the brake pedal and the accelerator pedal at the same time while driving.

! NOTE Damage to the vehicle due to not observing the maximum permitted headroom clearance

If the vehicle height is greater than the maximum permitted headroom clearance, the roof and other parts of the vehicle may be damaged.

- ▶ Observe the signposted headroom clearance.

- ▶ If the vehicle height is greater than the permitted headroom clearance, do not enter.

- ▶ Observe the changed vehicle height with add-on roof equipment.

- i** Please bear in mind that all the speed values stated in this Owner's Manual are approximate and are subject to a certain tolerance.

Notes on driving with a roof load, trailer or fully laden vehicle

When driving with a loaded roof luggage rack or trailer as well as with a fully laden or fully occupied vehicle, the vehicle's driving and steering characteristics change.

You should bear the following in mind:

- Do not exceed the permissible roof load and towing capacity. Also observe the information in the Technical Data.
- Distribute the roof load and the load inside the vehicle evenly, placing heavy objects at the bottom. Also comply with the notes on loading the vehicle (→ page 190).

- Drive attentively, and avoid abrupt starts, braking and steering as well as rapid cornering.

Advice on driving on salt-strewn roads

The braking effect is limited on salt-strewn road surfaces.

Therefore, observe the following notes:

- Due to salt build-up on the brake disks and brake pads, the braking distance can increase considerably or result in one-sided braking.
- Maintain a much greater safety distance to the vehicle travelling ahead.

Remove salt build-up as follows:

- Brake occasionally, paying attention to the traffic conditions
- Carefully depress the brake pedal at the end of the journey and when starting the next journey

Notes on aquaplaning

Aquaplaning can take place if a certain depth of water has built up on the road surface.

Observe the following notes during heavy precipitation or in conditions in which aquaplaning may occur:

- Reduce speed
- Avoid tyre ruts
- Avoid sudden steering movements
- Brake carefully

i Also observe the notes on regularly checking wheels and tyres (→ page 27).

Notes on driving through water on the road

Water ingress can damage the drive system, electronics and transmission.

Observe the following if you have to drive through water:

- The water, when calm, may reach no higher than the lower edge of the vehicle body.
- Drive at walking pace at most; water can otherwise enter the vehicle interior.
- Vehicles travelling ahead, or oncoming vehicles, can create waves which may exceed the maximum permissible depth of the water.

The braking effect of the brakes is reduced after fording. Brake carefully, paying attention to the traffic conditions, until braking power has been fully restored.

Function of rear axle steering

The rear axle steering is an electromechanical auxiliary steering on the rear axle which adjusts the steering of the rear wheels according to the position of the front wheels, depending on the speed. This results in greater mobility and improved driving stability for the vehicle.

Rear axle steering has the following characteristics:

- reduced steering effort and turning circle resulting in reduced parking effort
- more direct steering resulting in improved control of the vehicle
- improved cornering of the vehicle

Observe the notes on snow chains and snow chain mode (→ page 628).

ECO display function

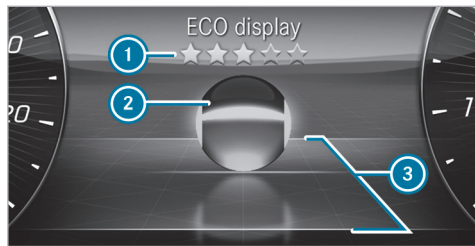

The ECO display shows an evaluation of your driving style on the driver's display depending on the situation. This enables you to check the efficiency of your driving style and adjust it if necessary. The **ECO display** menu shows a ball ② that will roll forwards or backwards on a stylized road in the direction of travel according to the driving characteristics.

Above and below the road, lines mark the area for an efficient driving style ③. Ball ② will light up in green if it is rolling within these lines. Outside the lines, the ball will light up in orange.

The ECO display assesses the following criteria for an economical driving style:

- Coasting at the right times
- Consistent speed
- Moderate acceleration

The overall assessment of your driving style "from start" is indicated using stars ①. It starts with five empty stars, which you can fill one after the other if you drive efficiently. When all five stars are filled, a glow will appear in the background.

① You can call up the **ECO display** function via the **Classic** menu (→ page 404).

Regenerative brake system

Function of the regenerative brake system

Depending on the selected recuperation level, the electric motors are operated as an alternator when in overrun mode and during braking in order to charge the high-voltage battery while driving. As soon as you take your foot off the accelerator pedal when the vehicle is in motion and in transmission position **D**, recuperation in overrun mode is initiated.

The higher the recuperation, the more sharply the vehicle is braked when coasting and the more electrical energy is fed into the high-voltage battery.

The deceleration in overrun mode may not be sufficient depending on the driving conditions. Also brake with the service brake if necessary. Always adapt your speed to the driving conditions and keep a sufficient distance.

The recuperative brake system has the following characteristics:

- supports braking with electronically controlled brake force boosting
 - converts the kinetic energy of the vehicle into electric energy
- ① If you brake hard, the mechanical brake is also used. This means that the maximum recuperative energy cannot be recovered. The more you accelerate and brake in an anticipatory manner, the more efficiently energy can be recuperated.

System limits

The braking effect of the electric motor during recuperation in overrun mode may be reduced or may not be available at all in the following situations:

- when the high-voltage battery charge level increases
- if the high-voltage battery is not yet at a normal operating temperature

In these cases, the desired deceleration is set by the brake control system.

You can watch an animation on this topic via the following link:

Manually setting recuperative deceleration

You can use the steering wheel gearshift paddles to manually adjust the intensity of recuperation in overrun mode.

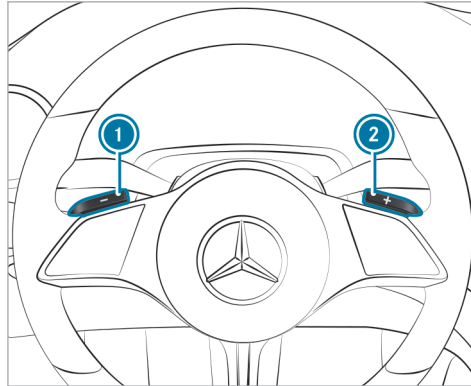

i When the vehicle is started again, **D** is automatically set as the recuperation level.

The following recuperation levels are available:

- **D** **AUTO** Intelligent and anticipatory recuperation with ECO Assist (→ page 261)
- **D** **+** No recuperation: the vehicle coasts, rolls freely
- **D** Normal recuperation (standard setting)

- **D** **-** Increased recuperation: increased deceleration in overrun mode

- ▶ **To increase recuperation:** briefly pull gearshift paddle ①.
- ▶ **To reduce recuperation:** briefly pull gearshift paddle ②.
- ▶ **To select **D** **AUTO**:** pull and hold gearshift paddle ① or ②.

The driver's display shows the currently selected recuperation level next to the transmission position display.

ECO Assist

ECO Assist function

ECO Assist is only an aid. It is not a substitute for you paying attention to your surroundings and does not relieve you of your responsibility pertaining to road traffic law. The driver is responsible for keeping a safe distance from the vehicle in front, for vehicle speed and for braking in good time.

⚠ WARNING Risk of accident if ECO Assist does not provide sufficient deceleration

ECO Assist only brakes your vehicle when you take your foot off the gas pedal. If vehicles are detected late, e.g. after tight curves, or if you do not react immediately to the ECO Assist display, the deceleration may not be sufficient.

- ▶ React promptly to the ECO Assist recommendation and take your foot off the gas pedal.
- ▶ Adjust your speed to the driving conditions and maintain a suitable distance from the vehicle in front.
- ▶ Brake the vehicle yourself and/or take evasive action.

ECO Assist is active only in **D** **AUTO** (→ page 261).

Depending on the vehicle's equipment, ECO Assist analyses data for the vehicle's expected route. This allows the system to optimally adjust the driving style for the route ahead, use minimal energy and recuperate as much as possible. If the system has detected an event ahead or a vehicle

in front and the vehicle is approaching the event, ECO Assist will calculate an optimised speed profile based on the distance, speed and available route information.

If you release the accelerator pedal in this case, intelligent recuperation will start in overrun mode. If ECO Assist has detected a vehicle travelling in front or a stationary vehicle ahead, it can brake your vehicle to a standstill. This may be the case, for example, at the end of a traffic jam or if the detected vehicle ahead stops in front of you.

If the deceleration provided by ECO Assist is not sufficient, you must also brake with the service brake. This is especially the case if, for example, you pull away again in slow-moving traffic and the distance to the vehicle in front is very short.

Depending on the vehicle equipment and at low speeds, e.g. in a multi-storey car park or on play streets, no adjustment will be made for stationary vehicles and therefore there will be no display.

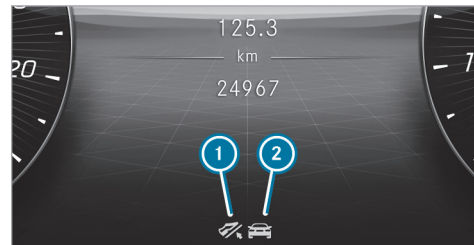

- ① "Foot off the accelerator" recommendation
- ② Route event ahead
- ⓘ ECO Assist can also be shown on the head-up display.



If a route event that requires an adjustment of your driving style is detected ahead, corresponding symbol ② and the  symbol (grey) will be displayed.





If you release the accelerator pedal, the  symbol will turn green and recuperation in overrun mode will be initiated. If the deceleration is not sufficient, also apply the service brake.

If ECO Assist intervenes for a route event ahead and you press the accelerator pedal, you end ECO Assist's control. This does not apply in the case of a vehicle in front.

The ECO Assist display is hidden again in the following cases:

- You do not react to the ECO Assist recommendation for a long time.
- You press the accelerator pedal while ECO Assist is intervening because of a route event ahead. This does not apply in the case of a vehicle in front.
- ECO Assist cannot identify any further recommendations from the route ahead.

In addition to a vehicle in front , ECO Assist can detect the following route events  depending on the vehicle's equipment:

-  Roundabout
-  S-bend
-  Sharp bend
-  T-junction
-  Downhill gradient

Speed limit

ECO Assist can also react to other intersections or junctions if you activate the turn signal indicator in good time.

-  On roads with an obligation to drive in a lane as far to the right as possible, vehicles driving in the lane to your left will also be recognised as vehicles ahead of you.

To enable ECO Assist to react to future route events, the equipment-dependent speed adaptation functions of Active Distance Assist must be active (→ page 329).

System limits

If the calculated route is adhered to when route guidance is active, ECO Assist will operate with greater accuracy. The basic function is also available without active route guidance. Not all information and traffic situations can be foreseen. The quality depends on the map data.

-  ECO Assist will be available after driving off, as soon as the sensor check is completed.

The system may be impaired or may not function in the following situations:

- If there is poor visibility, e.g. due to insufficient illumination of the road, highly variable shade conditions, rain, snow, fog or heavy spray.
- If there is glare, e.g. from oncoming traffic, direct sunlight or reflections.
- If the windscreen is dirty in the vicinity of the multifunction camera.
- If the multifunction camera is misted up, damaged or obscured.
- If road signs are hard to detect, e.g. due to dirt, snow or insufficient lighting, or because they are obscured.
- If the information in the navigation system's digital map is incorrect or out of date.
- If signs are ambiguous, e.g. road signs in roadworks or in adjacent lanes.
- If the radar sensors are dirty or obscured.
- When you drive on roads with steep uphill or downhill gradients.
- If there are narrow vehicles in front, such as bicycles or motorcycles.

You can watch an animation on this topic via the following link:

Function of the haptic accelerator pedal

The haptic accelerator pedal features an additional point of resistance to help you drive as efficiently as possible in drive program .

Range maximisation

Range maximisation function



The range maximisation function enables a maximum range gain. To achieve this, the function partially or completely switches off convenience systems that are not relevant to driving and activates efficiency-enhancing driving functions.

The range maximisation function controls the restrictions of the following function groups:

- **Climate control**

- Restricting climate control functions and deactivating front windscreen, rear window and mirror heaters

- **Interior**

- Switching off ambient lighting, displays and certain charging functions
- **Seating comfort**
 - Deactivating the steering wheel heater, seat heating and ventilation and deactivating the massage function
- **ECO drive functions**
 - Changing to the  drive program, activating ECO Assist and the   recuperation level

If necessary, you can deactivate the restrictions of individual function groups again. This will reduce the maximum range gain by the value specified for the function group.

If you switch on a deactivated function while range maximization is activated, all restrictions of the corresponding function group will be removed and the maximum range gain will be reduced accordingly. For example, if you switch on the seat heating again, all restrictions of the "Seating comfort" function group will be deactivated.

This does not apply to the "ECO driving functions" group, as the range gain in this case depends

mainly on your personal driving style. The activated ECO driving functions help you to drive in an energy-efficient manner. The specified range gain for the ECO drive functions can be achieved only if you observe the driving instructions and recommendations displayed and drive without kickdown.

Activating/deactivating range maximisation

Multimedia system:

  Settings  EQ  Range

- ▶ Activate or deactivate **Maximum range**. All function groups concerned will be activated or deactivated.

or

- ▶ Individually activate or deactivate the individual subsystems of the four function groups **Climate control**, **Interior**, **Seat comfort** and **ECO drive functions**.

AMG Active Sound

Selecting supporting sound characteristic with the steering-wheel button

- ① You can select a comfortable (Balanced), a sporty (Sport) or a very sporty (Powerful) supporting sound characteristic for interior and drive noises using the steering-wheel button or the multimedia system (→ page 271).

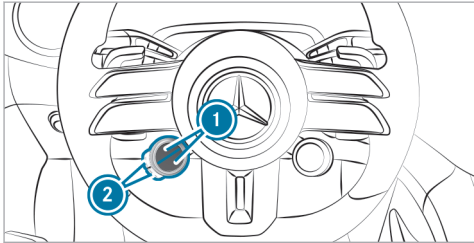

- ▶ Press the upper or lower ① display button repeatedly, until it displays the  symbol.

- ① If the display button does not show the symbol, then it is hidden. How functions are displayed and the order in which they are dis-

played can be set in the multimedia system (→ page 266).

- ▶ Press the corresponding button ②.

The colour of the symbol  indicates the supporting sound characteristic currently selected:

- **Blue:** Balanced – comfortable
- **Orange:** Sport – sporty
- **Red:** Powerful – very sporty



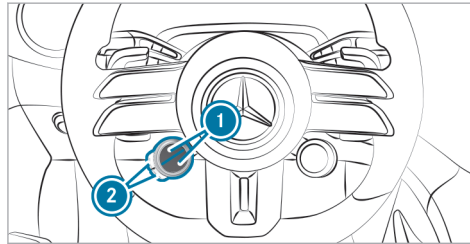

Function of the AMG steering-wheel buttons



The AMG steering-wheel buttons are an additional control element with two buttons on the steering wheel.

You can assign two vehicle functions of your choice to the control element. You can change between the available functions for the corresponding button ② by pressing the upper or lower part of the display button ① repeatedly. The display buttons ① show each function selected.

The following functions are available depending on the equipment:

-  ESP® (→ page 308)
-  AMG RIDE CONTROL + (→ page 359)
-  Camera views (→ page 366)
-  AMG DYNAMICS (→ page 267)
-  AMG Active Sound (→ page 265)

In addition, all the functions you have saved in the multimedia system as favourites are available for selection. Information on favourites

i Individual functions may not be shown. How functions are displayed and the order in which they are displayed can be set in the multimedia system (→ page 266).

If you have assigned a function to one of the display buttons **1**, you can operate this function with the corresponding button **2**.

The assignment of the display buttons **1** remains stored even after the vehicle is started again. The operating status of the respective function is, however, reset to the basic setting.

Setting the AMG steering wheel buttons

Multimedia system:

→  **Settings** **System**

Control elements

AMG steering-wheel buttons

i The **SETTINGS SELECT** menu can also be called up using the AMG button in the centre console or by pressing and holding the respective display button.

The left display buttons on the steering wheel can be set in the **SETTINGS SELECT** menu.

▶ Select the upper or lower display button in the central display and switch to editing mode by pressing and holding it.

▶ Press **+** and select the desired function from the list.
The selected function is assigned to the corresponding display button and can now be called up directly by simply pressing it.

Deleting button assignment

▶ Select the upper or lower display button and switch to editing mode by pressing and holding it.

▶ Press  to delete the selected display button assignment.

DYNAMIC SELECT

Function of DYNAMIC SELECT

DYNAMIC SELECT allows a drive program to be selected quickly according to the current driving situation or the desired vehicle characteristics (→ page 268, 269).

Depending on the drive program selected, the following vehicle characteristics will change:

- Drive
- **Vehicles with AIRMATIC:** suspension (→ page 357)
 - Suspension and damping
 - Vehicle level (speed-dependent)
- Steering
- ESP[®]
- Point of resistance in the haptic accelerator pedal

i In drive program , an additional pressure point is activated in the haptic accelerator pedal.

- First point of resistance: at approx. 60% of pedal travel (only in )
- Second point of resistance: transition to kickdown (always available)

Available drive programs

I* (Individual)

- The following vehicle characteristics are individually adjustable:
 - Drive
 - Suspension
 - Steering
 - ESP®

S (Sport)

- Sporty and dynamic driving characteristics
- Suitable only for good road conditions, a dry surface and a clear stretch of road

C (Comfort)

- Comfortable driving style
- Recommended for all road conditions
- Best balance between efficiency and performance for all driving situations

E (Eco)

- Economical setting of vehicle functions
- Recommended for all road conditions

- Additional first point of resistance in the haptic accelerator pedal indicates an efficient, economical driving style

The ESP® settings in the drive programs **E** and **C** are designed for stability. Therefore, choose one of these drive programs especially when transporting roof loads, in trailer operation and when the vehicle is fully loaded or fully occupied.

Function of the DYNAMIC SELECT (Mercedes-AMG vehicles)

DYNAMIC SELECT allows a driving program to be selected quickly according to the current driving situation or the desired vehicle characteristics.

You can select the following drive programs:

- **Slippery**
 - Power level 1
 - With limited power release for optimised pulling away and driving characteristics in wintry and slippery road conditions
 - Kickdown not available

- **C** **Comfort**

- Power level 2
- With a moderate power release for comfortable driving and maximum range

- **I*** **Individual**

- For individual drive, suspension, steering, ESP® and sound settings in the vehicle interior

- **S** **Sport**

- Power level 3
- With a somewhat limited power release for sporty driving



- **S*** **Sport+**



- Power level 4
- Maximum power availability for particularly sporty driving



Depending on the drive program selected, the following vehicle characteristics will change:

- Drive and power availability

- The power release for the drive is selected automatically depending on the drive program.
- The four power levels are designed to provide constant power over as long a period as possible in the respective drive program.
- AMG Dynamics
 - The three agility functions Basic, Advanced and Pro are automatically selected depending on the drive program.
 - The steering, all-wheel drive and stabilisation functions are adapted to the selected drive program.
- Suspension
- Steering
- AMG Active Sound sound characteristic

The ESP® settings in the drive programs  and  are designed for stability. Therefore, choose one of these drive programs especially when transporting roof loads, in trailer operation and when the vehicle is fully loaded or fully occupied.

If you depress the accelerator pedal beyond the pressure point (kickdown), the maximum power is always available in all drive programs with the exception of the drive program . Kickdown is not available in the drive program .

-  You can set the vehicle characteristics using the multimedia system (→ page 271).
-  You can also adjust the agility functions of AMG Dynamics using the AMG steering-wheel buttons.

Selecting a drive program

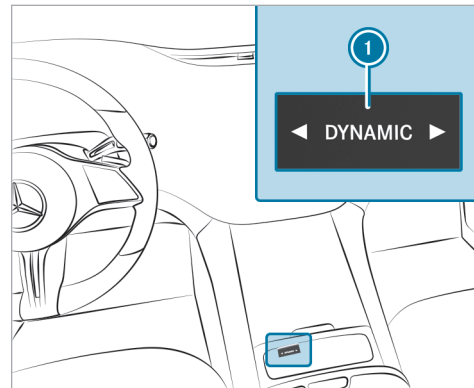

- ▶ Press the DYNAMIC SELECT button  on the left or right.
The drive program selected will appear on the driver's display.

Selecting a drive program (Mercedes-AMG vehicles)

Selection with right-hand steering-wheel button

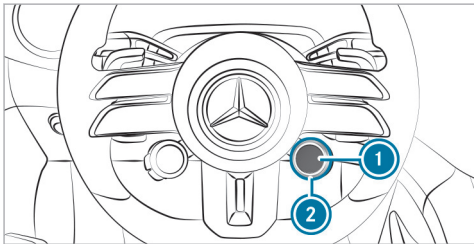

- ▶ Turn the rotary switch ②. The selected drive program will appear on display button ① and on the driver's display.
- ⓘ Individual drive programs may not be shown. How drive programs are displayed and the order in which they are displayed can be set in the multimedia system (→ page 271).
- ▶ To select the  drive program **directly**: press display button ①.

Selection via the central display (multimedia system)

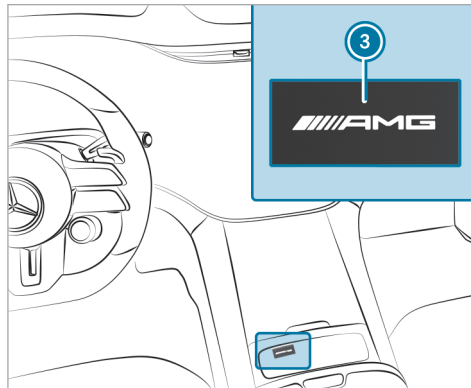

- ▶ Press button ③ and select the drive program via the central display (→ page 271).

Configuring DYNAMIC SELECT in the multimedia system

Multimedia system:

→  Settings ▶ Vehicle
▶ DYNAMIC SELECT

Setting drive program I

- ▶ Select  **Individual**.
- ▶ Select and set a category.
- ⓘ A sporty ESP mode can be set in conjunction with a sporty suspension mode.

Switching the reset display on/off

- ▶ Activate or deactivate **Ask when starting**.
- ⓘ This function must be activated for each user profile separately. Only when this function is activated will the drive program and ECO start/stop setting for the previous journey be saved for the respective user profile.

Function on: the next time the vehicle is started a prompt appears asking whether the last active drive program should be restored. If the ECO start/stop function was deactivated, an additional

prompt appears asking if the function should remain deactivated.

- ① The prompt only appears if the previously active settings deviate from the standard settings.

Function off: the next time the vehicle is started the  drive program is set automatically. The ECO start/stop function is activated automatically.

Configuring DYNAMIC SELECT in the MMS (plug-in hybrid or electric vehicles)

Multimedia system:

-   Settings  Vehicle
-  DYNAMIC SELECT

Setting drive program I

-  Select  Individual.
-  Select and set a category.

Setting the C drive program (electric vehicles)

-  Select Comfort.

-  Select **Route-based** or **Standard**.
If route guidance is active and the **Route-based** option has been switched on, the electrical energy is distributed intelligently in both urban and non-urban areas over the entire route.

With the **Standard** option, the vehicle drives in its standard drive program ( **Comfort**). There is no distribution of electrical energy over the entire route. The high-voltage battery is exhausted.

Switching the reset display on/off

-  Activate or deactivate **Ask when starting**.
- ① This function must be activated for each user profile separately. The drive program for the respective user profile of the last driver is only stored if this function is activated.

Function on: the next time the vehicle is started a prompt appears asking whether the last active drive program should be restored.

- ① The prompt only appears if the previously active settings deviate from the standard settings.

Function off (electric vehicles): the next time the vehicle is started the  drive program is set automatically.

Displaying vehicle data

Multimedia system:

-   Info

-  Select **Vehicle**.
The vehicle data is displayed.

Calling up the fuel consumption indicator

Multimedia system:

-   EQ

-  Select **Consumption**.
The current and average fuel consumption will be displayed.

Setting AMG DYNAMIC SELECT in the MBUX multimedia system

Multimedia system:

→  → Settings → Vehicle
 → DYNAMIC SELECT

Overview of the AMG DYNAMIC SELECT menu



(Example of representation) Representation and arrangement of content is equipment-dependent.

- ① AMG drive program settings
- ② Drive programs
- ③ ESP® (→ page 308)

- ① Depending on the equipment, the AMG menu **DYNAMIC SELECT** can also be called up using the AMG button in the centre console.
- ▶ Select the appropriate drive program.

The settings of the drive programs can be adjusted individually.

- ▶ Select the desired tab on the left and make the relevant setting.

Setting options for the drive programs (equipment-dependent):

- AMG DYNAMICS:
Basic/Advanced/Pro
- Suspension:
Comfort/Sport/Sport+
- Sound:
Balanced/Sport/Powerful
- Drive (can only be set in the  drive program):
Reduced/Moderate/Sport/Dynamic

Transmission

DIRECT SELECT lever

Function of the DIRECT SELECT lever

⚠ WARNING Accident- and risk of injury with unsupervised children in the vehicle

If you leave children unattended in the vehicle, they can in particular

- Open doors and thereby endanger other persons or road users.
- get out of the car and are hit by traffic.
- Operate vehicle equipment and become trapped, for example.

In addition, the children could also set the vehicle in motion, for example by:

- releasing the parking brake.
- change the gearbox setting.
- start the vehicle.

▶ Never leave children unattended in the vehicle.

- ▶ When leaving the vehicle, always take the SmartKey with you and lock the vehicle.
- ▶ Keep the key out of reach of children.

Use the DIRECT SELECT lever to switch the transmission position. The current transmission position will be shown on the driver's display.

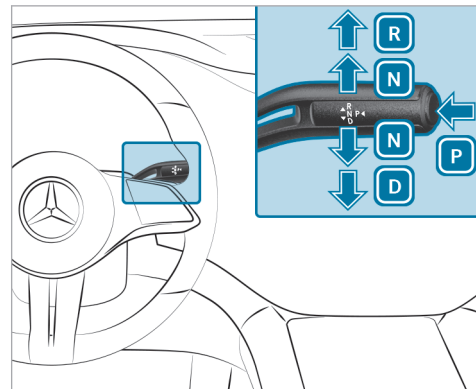

- P** Park position
- R** Reverse gear
- N** Neutral
- D** Drive position

Engaging reverse gear R

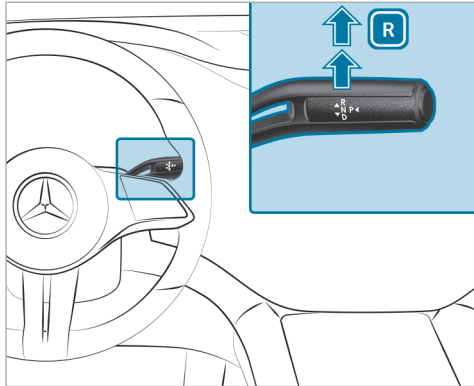

- ▶ Depress the brake pedal and push the DIRECT SELECT lever upwards past the first point of resistance.

Engaging neutral N

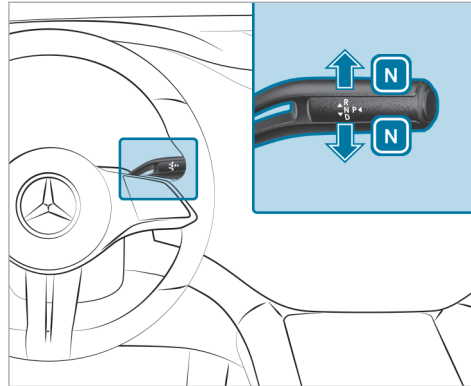

- ▶ Depress the brake pedal and push the DIRECT SELECT lever up or down to the first point of resistance, holding it there until the transmission position **N** is shown on the driver's display.

Subsequently releasing the brake pedal will allow you to move the vehicle freely, e.g. to push it or tow it away.

If you want the transmission to remain in neutral N even if the vehicle is switched off:

- ▶ Start the vehicle.
- ▶ Depress the brake pedal and engage neutral **N**.
- ▶ Release the brake pedal.
- ▶ Switch off the vehicle.
- ⓘ If you then exit the vehicle leaving the key in the vehicle, the transmission will remain in neutral **N**.

Engaging park position P

⚠ WARNING Accident- and risk of injury with unsupervised children in the vehicle

If you leave children unattended in the vehicle, they can in particular

- Open doors and thereby endanger other persons or road users.

- get out of the car and are hit by traffic.
- Operate vehicle equipment and become trapped, for example.

In addition, the children could also set the vehicle in motion, for example by:

- releasing the parking brake.
- change the gearbox setting.
- start the vehicle.

- ▶ Never leave children unattended in the vehicle.
- ▶ When leaving the vehicle, always take the SmartKey with you and lock the vehicle.
- ▶ Keep the key out of reach of children.

! **NOTE** Damage due to engaging park position **P** while the vehicle is rolling

If you shift the transmission into park position **P** while the vehicle is rolling, the transmission may be damaged.

- ▶ If the vehicle is rolling, do not open a door.
- ▶ Only engage the park position **P** when the vehicle is stationary.

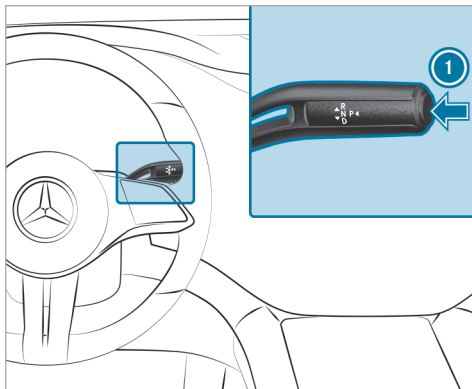

- ▶ Observe the notes on parking the vehicle (→ page 297).

- ▶ Depress the brake pedal until the vehicle comes to a standstill.

- ▶ When the vehicle is stationary, press button **1**.

When the transmission position display shows **P**, the park position is engaged. If the transmission position display **P** is not shown, apply the parking brake and secure the vehicle to prevent it from rolling away.

- i** Depending on the situation, it may take a short time until **P** is engaged. Therefore, always pay attention to the transmission position display.

Park position **P** will be engaged automatically if one of the following conditions is met:

- You switch the stationary vehicle off in transmission position **D** or **R**.
- You open the driver's door when the vehicle is stationary in transmission position **D** or **R**.
- When the vehicle is rolling, you switch it off in transmission position **D** or **R** and bring it to a standstill.

- When the vehicle is rolling, you shift to transmission position **N**, bring the vehicle to a standstill and open the driver's door when the vehicle is stationary.
 - Engaging park position **P** automatically is required by the vehicle.
- i** To manoeuvre with an open driver's door, open the driver's door while the vehicle is stationary and engage transmission position **D** or **R** again.

Engaging drive position D

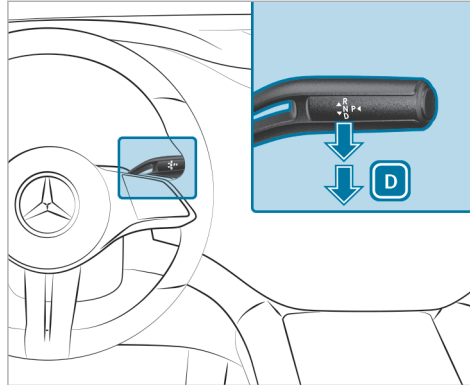

- ▶ Depress the brake pedal and push the DIRECT SELECT lever down past the first point of resistance.

Function of 4MATIC

The flexible all-wheel distribution of the 4MATIC means the drive is always ideally distributed

between both axles. Depending on the situation, only the front axle or only the rear axle can be driven, or the drive can be distributed continuously between both axles.

This means that recuperation can be used even more effectively and the range of the vehicle can be increased (→ page 260).

Together with ESP[®] and 4ETS, 4MATIC improves the traction of your vehicle whenever a driven wheel spins due to insufficient traction.

If you fail to adapt your driving style, 4MATIC can neither reduce the risk of an accident nor override the laws of physics. It cannot take into account road, weather or traffic conditions. 4MATIC is only an aid. You are responsible especially for maintaining a safe distance from the vehicle in front, for vehicle speed, for braking in good time and for staying in lane.

- i** In wintry road conditions, the maximum effect of the flexible all-wheel distribution can be achieved only if you use winter tyres (M+S tyres), with snow chains if necessary.

Charging the high-voltage battery

Notes on charging the high-voltage battery

! **NOTE** High-voltage battery damage due to leaving the vehicle idle for lengthy periods of time

Lithium-ion batteries experience a natural self-discharge.

Exhaustive discharging can therefore occur if the vehicle is idle for several months. This can damage the high-voltage battery.

▶ To avoid damage, please observe the following recommendations when handling the high-voltage battery.

! **NOTE** Accelerated ageing of the high-voltage battery due to not observing the following recommendations

As a result of its basic characteristics, the storage capacity of, and the amount of energy available from, the high-voltage battery decreases over the course of its life. As a

result, the maximum electrical range that can be achieved by the vehicle is reduced and its maximum electrical output can be impaired.

The following factors could accelerate the ageing of the high-voltage battery:

- frequently fully charging (charge level 100%) the high-voltage battery, especially when this process is not directly followed by a journey
- frequent rapid charging with direct current (mode 4)
- leaving the vehicle idle for lengthy periods at high ambient temperatures

▶ To avoid accelerated ageing, please observe the following recommendations when handling the high-voltage battery.

Recommendations when handling the high-voltage battery:

- Every six months, when the outside temperature is above 10°C, park the vehicle overnight with a charge level below 20%.

- Only charge the high-voltage battery with direct current (mode 4) if necessary.
- Charge the high-voltage battery on average to a charge level of 80%. Beyond a charge level of 80%, the charging time is considerably prolonged.
- If leaving the vehicle idle for lengthy periods, park up the vehicle with a high-voltage battery charge level between 30% and 50%. Do not keep the high-voltage battery continuously connected to power supply equipment.
- If leaving the vehicle idle for lengthy periods of time avoid, if possible, high ambient temperatures.
- Check the high-voltage battery's charge level every six weeks (→ page 295).
- Charge the high-voltage battery if the charge level is below 20%.
- Do not disconnect the 12 V battery even if the vehicle is left idle for a lengthy period. Otherwise, the condition of the vehicle's high-voltage battery cannot be monitored.

You can contribute to reducing the vehicle's energy consumption in the following ways:

- An anticipatory driving style (→ page 260)
- Reduced use of electrical consumers
- Having the vehicle regularly maintained

The charging time of the high-voltage battery may change over the course of its life.

- i** Depending on the national version, your vehicle is equipped with one of the following vehicle sockets.

You can charge the high-voltage battery with both alternating current (mode 2/3) and direct current (mode 4).

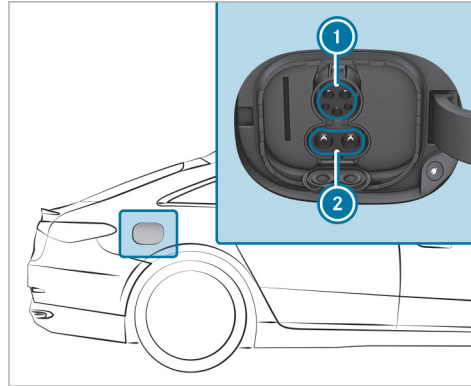

Combo 1 vehicle socket

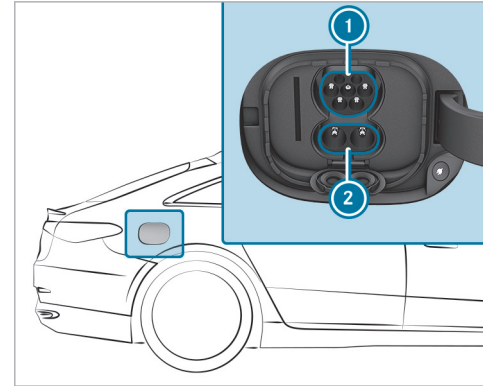

Combo 2 vehicle socket

- 1** Type 1 or type 2 connection for charging with alternating current
- 2** Socket extension for charging with direct current

i When using a CCS (Combined Charging System) charging cable to charge with direct current at a combo vehicle socket, both vehicle socket connections **1** and **2** are used for charging.

Depending on the equipment, the lower DC charging connection is protected with a socket cover or a hinged cover.

Charging options for the high-voltage battery (mode 2, 3 or 4):

- Charging through recuperation while the vehicle is in motion
- Charging with alternating current when stationary:
 - at a mains socket (mode 2)
 - at a wallbox or charging station (mode 3)
- Charging with direct current when stationary:
 - at a rapid charging station (mode 4)

Depending on the country-specific vehicle equipment and your vehicle's charging cable, single phase AC charging is also possible.

Observe the different grid requirements of your current location when charging. Only use charging

cables which conform to the grid requirements. Consult a qualified electrician or your local grid operator if you have any questions.

It is recommended that you charge the high-voltage battery at a wallbox or charging station due to the improved charging performance and better charging efficiency offered.

System limits

The power output of the high-voltage battery may be impaired by the following:

- High or low outside temperatures
- Electrical auxiliary consumers in the vehicle being switched on, e.g. operating the air conditioning system
- Extended periods without charging

The charging time or the charging capacity of the high-voltage battery may be increased in particular by the following:

- High or low outside temperatures
- A low or high state of charge on the high-voltage battery

- The maximum available charge current of the charging facility
- The settings of the charging process in the multimedia system (→ page 296)

You can watch an animation on this topic via the following link:

Stowing the charging cable

Always stow the vehicle's charging cable in the charging cable bag provided, and secure the charging cable bag in the boot or load compartment with the included retaining strap. Otherwise, the charging cable bag with the charging cable is not sufficiently secured.



Example: charging cable bag in the boot/load compartment

As delivered, charging cable bag ① with retaining strap ② is located in the boot or load compartment. To secure the charging cable bag, the retaining strap must be attached to tie-down eye ③. Do not use bag hooks to attach the retaining strap.

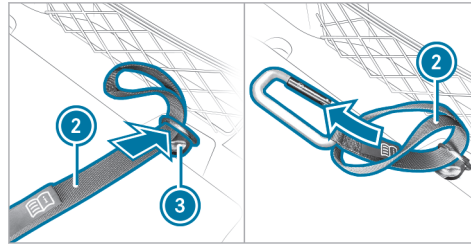

- ▶ Feed the loop end of retaining strap ② through tie-down eye ③ into the boot or load compartment.
- ▶ Feed the end with the snap hook through the loop of retaining strap ②.



- ▶ Tighten retaining strap ② so that the knot around tie-down eye ③ is tight and secure.
- ▶ Hook the snap hook of retaining strap ② in a tie-down eye of charging cable bag ①.

Notes on charging the high-voltage battery at the mains socket (mode 2)

⚠ DANGER Risk of fatal injury from incorrectly installed component parts

Connecting the charging cable to a mains socket using incorrectly installed component parts could cause a fire or an electric shock, for example.

- ▶ Only connect the charging cable to a mains socket that:
 - Has been properly installed and
 - Has been inspected by a qualified electrician
- ▶ For safety reasons, only use the charging cable supplied with the vehicle or an original Mercedes-Benz charging cable.
- ▶ Purchase these parts at a Mercedes-Benz Service Centre and obtain advice there.

Mercedes-Benz thoroughly tests these original charging cables for their suitability for high-voltage charging of your vehicle.

- ▶ Never use a damaged charging cable.
- ▶ Do not use:
 - Extension cables
 - Extension reels
 - Multiple sockets
- ▶ Never use socket adapters to connect the charging cable to the mains socket. The only exception being if the adapter has been tested and approved by the manufacturer for charging the high-voltage battery of an electric vehicle.
- ▶ Observe the safety notes in the operating instructions for the socket adapter.

Only the following charging cables may be used:

- The charging cable supplied with the vehicle.
- A charging cable that has been approved for the vehicle.

The charging process can vary depending on the power supply equipment. The charging times when charging the high-voltage battery at the mains socket are considerably longer than when charging at a wallbox or charging station.

When doing so, always observe the local information.

Do not leave the charging cable controls hanging loose from a mains socket.

Do not lift the controls by the following component parts:

- the charging cable connector
- the mains plug

When charging, protect the charging cable control element from excessive heat such as direct sunlight. Otherwise, the charging process may be cancelled.

Notes on charging the high-voltage battery at a wallbox or charging station (mode 3)

⚠ DANGER Risk of fatal injury from incorrectly installed component parts

Connecting the charging cable to a wallbox using incorrectly installed component parts could cause a fire or an electric shock, for example.

- ▶ Only connect the charging cable to a wallbox that:
 - Has been properly installed and
 - Has been inspected by a qualified electrician
- ▶ For safety reasons, only use charging cables that have been tested and approved by the manufacturer for charging the high-voltage battery in an electric vehicle.
- ▶ Never use damaged charging cables.
- ▶ Do not extend the charging cable.
- ▶ Do not use adapters.

- ▶ Observe the safety notes in the operating instructions for the wallbox.

If charging at a wallbox without pre-installed cable, use the optionally available charging cable for wallbox and charging station (mode 3). The charging cable is stowed in a bag in the boot/luggage compartment.

Only use charging cables that have been tested and approved by the manufacturer for charging the high-voltage battery in an electric vehicle.

⚠ DANGER Risk of fatal injury due to damaged components

Connecting the vehicle to a charging station using damaged component parts could cause a fire or an electric shock, for example.

- ▶ Perform a visual check of the charging station for obvious defects, for example damage to the housing or charging cable connection.
- ▶ Never use damaged charging cables.

- ▶ Do not use an extension for the charging cable.
- ▶ Do not use adapters.
- ▶ Always observe the safety instructions on the charging station.

Most charging stations must be activated before the charging process, e.g. using an RFID card or via Plug-and-Charge. Observe the on-site operator's instructions for the charging station and the notes on Mercedes me Charge (→ page 489).

The amount of energy dispensed for the charging process, shown by the charging station, may be higher than the amount of energy actually absorbed by the high-voltage battery. This is the result of different levels of charging losses and is described as recharge efficiency. Charging losses occur, for example, due to heat that builds up when the vehicle is charging or from auxiliary consumers that are switched on. Further information on recharge efficiency can be obtained at a qualified specialist workshop.

Notes on charging the high-voltage battery at a rapid charging station (mode 4)

⚠ DANGER Risk of fatal injury due to damaged components

Connecting the vehicle to a charging station using damaged component parts could cause a fire or an electric shock, for example.

- ▶ Perform a visual check of the charging station for obvious defects, for example damage to the housing or charging cable connection.
- ▶ Never use damaged charging cables.
- ▶ Do not use an extension for the charging cable.
- ▶ Do not use adapters.
- ▶ Always observe the safety instructions on the charging station.

⚠ DANGER Risk of fatal injuries when carrying out maintenance work during the charging process

During the charging process, the high-voltage on-board electrical system is under high voltage.

- ▶ Do not perform any maintenance work during the charging process.

Most charging stations must be activated before the charging process, e.g. using an RFID card or via Plug-and-Charge. Observe the on-site operator's instructions for the charging station and the notes on Mercedes me Charge (→ page 489).

The charging cable for the vehicle must not be longer than 30 m due to the legal requirements in some countries. This is to prevent the interference of signals being received by radio communication devices in the vehicle or in close proximity to the charging station. Be aware that parts of the charging cable may be routed underground. If in doubt, ask the charging station operator if this is the case before charging the high-voltage battery.

The amount of energy dispensed for the charging process, shown by the charging station, may be higher than the amount of energy actually absorbed by the high-voltage battery. This is the result of different levels of charging losses and is described as recharge efficiency. Charging losses occur, for example, due to heat that builds up when the vehicle is charging or from auxiliary consumers that are switched on. Further information on recharge efficiency can be obtained at a qualified specialist workshop.

Setting the maximum permissible charging current for charging at a mains socket

! NOTE Overloading the mains socket due to excessive charging current

If the charging current is too high, the fuse could be tripped or the external mains supply could overheat.

- ▶ Ensure that the external mains supply has been designed to handle the charging current provided.

- ▶ For safety reasons, only use the charging cable supplied with the vehicle or an original Mercedes-Benz charging cable. Mercedes-Benz thoroughly tests these original charging cables for their suitability for high-voltage charging of your vehicle.
- ▶ Purchase these parts at a Mercedes-Benz Service Centre and obtain advice there.
- ▶ Check the maximum charging current using the charging capacity shown in the driver's display.

The charging cable supplied is set to a country-specific maximum charging current value. When charging abroad, the maximum value may exceed the permitted value for that country.

- ▶ Before charging at a mains socket, have the maximum permissible charging current for the relevant mains socket or the building inspected by a qualified electrician.
- ▶ When abroad, observe the country-specific laws when charging.

If you have questions concerning the charging current or if there is a malfunction, please contact a qualified specialist workshop.

Overview of the charging cable control panel

The charging cable control panel shows the current status of the charging process.

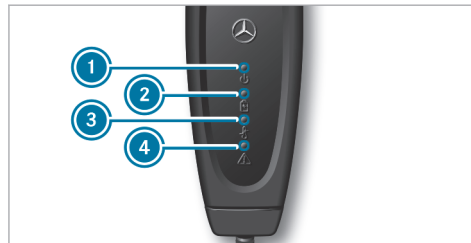

- ① Supply voltage indicator
- ② Charging process indicator
- ③ Temperature monitor indicator
- ④ Safety system indicator

Supply voltage indicator ①

Display	Meaning
Lights up white	The supply voltage is connected.

Charging process indicator ②

Display	Meaning
Flashes green	The high-voltage battery is charging.

Temperature control indicator ③

Display	Meaning
Lights up red	The green LED flashes simultaneously: over-temperature – the charging performance is reduced. The green LED does not flash: overtemperature – the charging process is stopped.
Flashes red	Overtemperature at the mains plug – the charging process is stopped.

Safety system indicator ④

Display	Meaning
Flashes red	Charging cable malfunction – cannot carry out the charging process, reset the charging cable operating unit.
Lights up red	White LED is off: power supply malfunction – cannot carry out the charging process, replace the mains socket. White LED is on: vehicle malfunction – cannot carry out the charging process, reset the charging cable operating unit.

When all four displays light up, the charging cable operating unit performs a self-test.

If temperature monitor ③ indicates a malfunction, it may help to protect the charging cable from direct sunlight.

To reset the charging cable operating unit: if safety system ④ indicates a charging cable malfunction or a vehicle malfunction, first reset the charging cable operating unit. To do this, disconnect the charging cable from the vehicle and from the mains socket and wait for approximately five seconds. If the malfunction persists after the charging cable is reconnected, charging at the mains socket is not possible. The charging cable must be replaced or the vehicle plug must be checked at a qualified specialist workshop, depending on the indicator.

Functions of the indicator lamp on the vehicle socket

The socket flap is centrally locked and unlocked together with the vehicle.

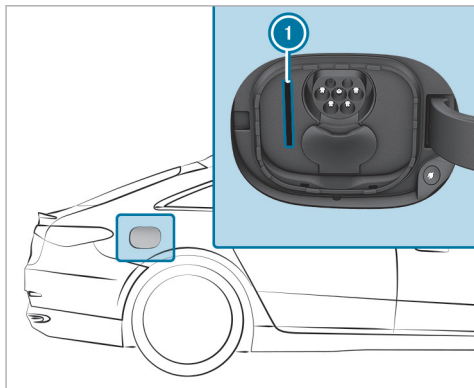

Example: Combo 2 vehicle socket

The colour and signalling of status display ❶ have the following meanings:

Locking status

- Lights up white: vehicle socket unlocked; insert or remove charging cable
- Flashes white: disconnection or malfunction during locking or unlocking

Charge status

- Lights up blue (for approx. 90 s): charging process completed
- Flashes blue: charging; active energy flow
- Lights up orange (for approx. 90 s): charging break
- Flashes orange: connection is being established
- Flashes red (for approx. 90 s): malfunction in vehicle; charging not possible

❶ **Vehicles with active ambient lighting:** when the charging sequence is activated, the charge level is also accompanied by ambient lighting (→ page 224).

Starting the alternating current charging process (mode 2/3)

⚠ DANGER Risk of death when charging at a damaged socket

The charging process uses high voltage.

If the charging cable, the vehicle socket or the mains socket are damaged, you could receive an electric shock.

- ▶ Only use an undamaged charging cable.
- ▶ Avoid mechanical damage such as crushing, abrading or driving over the cable.
- ▶ Have a damaged vehicle socket replaced at a qualified specialist workshop as soon as possible.
- ▶ Never connect the charging cable to a damaged vehicle socket.

! **NOTE** Damage due to overheating of charging cable and charge port

During the charging process, the charging cable and charge port can heat up within the permissible limits.

The permissible limit values are influenced by the following factors:

- the power supply system and the charging cable are not damaged

- the instructions for handling the charging cable and the control element on the charging cable have been observed

- ▶ If the charging cable or charge port becomes too hot, have the power supply system checked.

! **NOTE** Damaged or dirty vehicle socket when the socket flap is open

- ▶ Always keep the socket cover and the socket flap closed when there is no charging cable connected. This protects the vehicle socket from dirt and damage.
- ▶ Make sure that the socket cover is closed properly before closing the socket flap. This can otherwise result in damage which may prevent the socket flap from being opened again.

! **NOTE** Damage to the vehicle socket or the charging cable connector due to incorrect handling

Do not use excessive force (maximum 300 N) to insert the charging cable connector into the vehicle socket to the stop. You may otherwise damage the vehicle socket, the charging cable connector or their contacts.

- ▶ If you feel there is increased resistance, pull the charging cable connector out of the socket and reinsert it.

Requirements

- The transmission is in position **P**.
- The vehicle is unlocked or the vehicle is locked and the distance between the key and the vehicle does not exceed 1 m.
- The vehicle has not been started. The **READY** display in the driver's display is off.
- The charging cable is not taut.

i Depending on the national version, the vehicle is equipped with one of the following vehicle sockets.

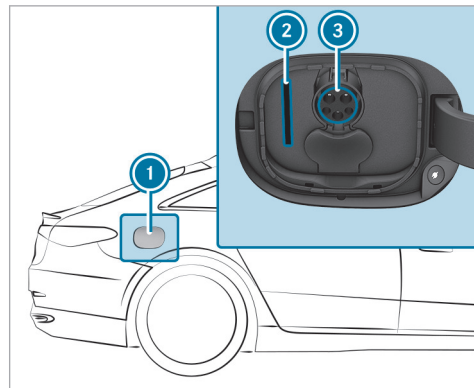

Combo 1 vehicle socket

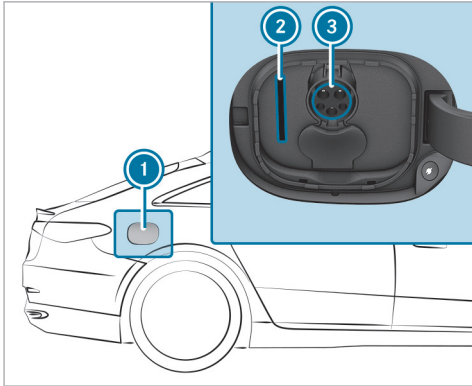

Combo 2 vehicle socket

▶ Open socket flap ① via the EQ module of the multimedia system (→ page 434).

or

▶ Press the centre rear section of socket flap ①.
Socket flap ① swings open and status display ② lights up white.

Vehicles with an electrical socket flap: if an obstacle impedes the socket flap while it is opening, the socket flap will close again automatically.

① When the vehicle is started (the **READY** display is lit in the driver's display), socket flap ① cannot be opened.

① Only upper connection ③ is required for the charging cable connector.

▶ To charge at a mains socket, insert the mains plug into the mains socket of the external power source as far as it will go.

▶ Insert the charging cable connector into vehicle socket connection ③ to the stop. If the wallbox/charging station is not equipped with a charging cable, insert the plug of the vehicle's charging cable into the wallbox/charging station socket to the stop.
Make sure that the charging cable is not taut when inserted.

Status display ② flashes orange and, as soon as the high-voltage battery is charged, blue.

① When the charging sequence for the ambient lighting is activated, the ambient lighting lights

up for approximately 30 seconds as with status display ② (→ page 224).

When Sound Experience is activated, different situations, for example the charging cable connector being inserted or the beginning of the charging process, are accompanied by selected sounds (→ page 592).

Vehicles with an electric socket flap: if a charging cable is not connected to the vehicle after the socket flap has been opened, the socket flap will close automatically after approx. 60 seconds.

When the charging cable is connected to the vehicle, the vehicle cannot be started or moved.

At the start of the charging process, the charge level display is shown in the driver's display with a charging prediction. The charging prediction refers to the time at which the high-voltage battery will be fully charged.

① Depending on the temperature, the fan and battery cooling system may audibly switch on during the charging process.

- i** If the vehicle is idle for lengthy periods and connected to the mains supply, the high-voltage battery will be recharged automatically as needed or when electrical consumers are activated (e.g. the pre-entry climate control).

Ending the alternating current charging process (mode 2/3)

⚠ DANGER Risk of death when charging at a damaged socket

The charging process uses high voltage. If the charging cable, the vehicle socket or the mains socket are damaged, you could receive an electric shock.

- ▶ Only use an undamaged charging cable.
- ▶ Avoid mechanical damage such as crushing, abrading or driving over the cable.
- ▶ Have a damaged vehicle socket replaced at a qualified specialist workshop as soon as possible.
- ▶ Never connect the charging cable to a damaged vehicle socket.

! **NOTE** Damage due to overheating of charging cable and charge port

During the charging process, the charging cable and charge port can heat up within the permissible limits.

The permissible limit values are influenced by the following factors:

- the power supply system and the charging cable are not damaged
- the instructions for handling the charging cable and the control element on the charging cable have been observed

- ▶ If the charging cable or charge port becomes too hot, have the power supply system checked.

! **NOTE** Damaged or dirty vehicle socket when the socket flap is open

- ▶ Always keep the socket cover and the socket flap closed when there is no charging cable connected. This protects the vehicle socket from dirt and damage.

- ▶ Make sure that the socket cover is closed properly before closing the socket flap. This can otherwise result in damage which may prevent the socket flap from being opened again.

Requirements

- The vehicle is unlocked or the vehicle is locked and the distance between the key and the vehicle does not exceed 1 m.
- i** Depending on the national version, the vehicle is equipped with one of the following vehicle sockets.

Combo 1 vehicle socket

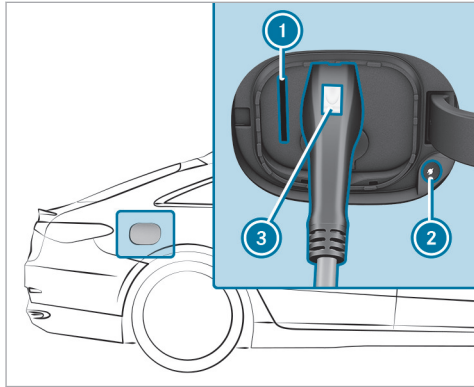

- ▶ Press charging interruption button ②. The charging process is ended. Status display ① lights up white. The vehicle socket is unlocked.
- ❗ Alternatively, it is possible to unlock the vehicle with the vehicle key in order to end the charging process, but only if charging inter-

ruption button ② is not functioning. To do so, press the  button once on the vehicle key. When status display ① lights up white, the vehicle socket is unlocked for approx. 30 seconds.

- ▶ Press and hold button ③ on the charging cable connector and remove the charging cable connector from the vehicle socket.
- ❗ If you cannot remove the charging cable connector, repeat the unlocking procedure. If the charging cable connector is still locked, contact a qualified specialist workshop.
- ▶ Close the socket flap.
For vehicles with an electric socket flap, observe the notes at the end of the section.
- ▶ Remove the charging cable connector from the mains socket, or from the socket on the wallbox/charging station, and stow the vehicle's charging cable safely in the vehicle (→ page 278).

Combo 2 vehicle socket

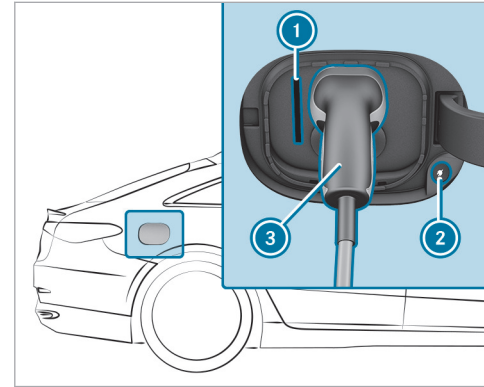

- ▶ Press charging interruption button ②. The charging process is ended. Status display ① lights up white. The vehicle socket is unlocked.

① Alternatively, it is possible to unlock the vehicle with the vehicle key in order to end the charging process, but only if charging interruption button ② is not functioning. To do so, press the  button once on the vehicle key. When status display ① lights up white, the vehicle socket is unlocked for approx. 30 seconds.

▶ Remove charging cable connector ③ from the vehicle socket.

① If you cannot remove the charging cable connector, repeat the unlocking procedure. If the charging cable connector is still locked, contact a qualified specialist workshop.

① Status display ① remains lit for some time after the charging cable connector has been removed and then goes out.

▶ Close the socket flap.
For vehicles with an electric socket flap, observe the following notes on closing the socket flap.

▶ Remove the charging cable connector from the mains socket, or from the socket on the wallbox/charging station, and stow the vehi-

cle's charging cable safely in the vehicle (→ page 278).

The electric socket flap closes automatically in the following situations:

- shortly after the charging cable connector has been removed
- after the socket flap has been tapped in the direction to close it
- after transmission position **N**, **D** or **R** has been engaged

Automatic reversing function of the electric socket flap

If an obstacle impedes the electrical socket flap while it is closing, the socket flap will open again automatically.

▶ When closing the socket flap, make sure that no body parts or objects are in the closing area.

Starting the direct current charging process (mode 4)

⚠ DANGER Risk of death when charging at a damaged socket

The charging process uses high voltage.

If the charging cable, the vehicle socket or the mains socket are damaged, you could receive an electric shock.

- ▶ Only use an undamaged charging cable.
- ▶ Avoid mechanical damage such as crushing, abrading or driving over the cable.
- ▶ Have a damaged vehicle socket replaced at a qualified specialist workshop as soon as possible.
- ▶ Never connect the charging cable to a damaged vehicle socket.

! **NOTE** Damage due to overheating of charging cable and charge port

During the charging process, the charging cable and charge port can heat up within the permissible limits.

The permissible limit values are influenced by the following factors:

- the power supply system and the charging cable are not damaged
- the instructions for handling the charging cable and the control element on the charging cable have been observed

▶ If the charging cable or charge port becomes too hot, have the power supply system checked.

! **NOTE** Damaged or dirty vehicle socket when the socket flap is open

▶ Always keep the socket cover and the socket flap closed when there is no charging cable connected. This protects the vehicle socket from dirt and damage.

▶ Make sure that the socket cover is closed properly before closing the socket flap. This can otherwise result in damage which may prevent the socket flap from being opened again.

! **NOTE** Damage to the vehicle socket or the charging cable connector due to incorrect handling

Do not use excessive force (maximum 300 N) to insert the charging cable connector into the vehicle socket to the stop. You may otherwise damage the vehicle socket, the charging cable connector or their contacts.

▶ If you feel there is increased resistance, pull the charging cable connector out of the socket and reinsert it.

Requirements

- The transmission is in position **P**.
- The vehicle is unlocked or the vehicle is locked and the distance between the key and the vehicle does not exceed 1 m.

- The vehicle has not been started. The **READY** display in the driver's display is off.
 - The charging cable is not taut.
- i** Depending on the national version, the vehicle is equipped with one of the following vehicle sockets.

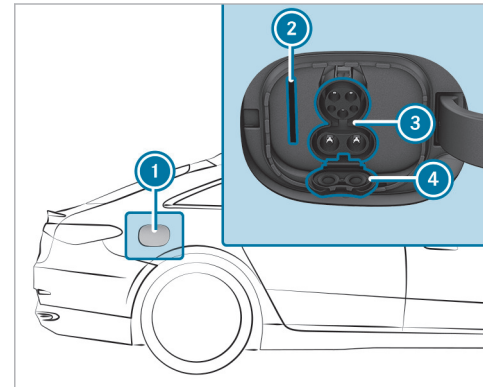

Combo 1 vehicle socket

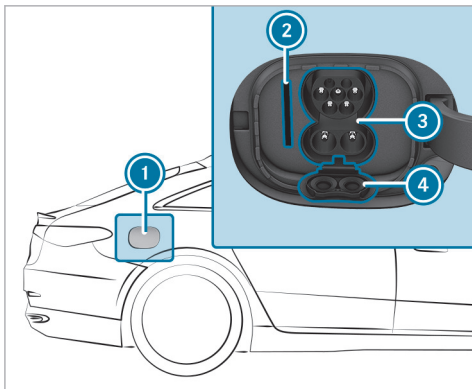

Combo 2 vehicle socket

- ▶ Open socket flap ① via the EQ module of the multimedia system (→ page 434).
- or
- ▶ Press the centre rear section of socket flap ①. Socket flap ① swings open and status display ② lights up white.

Vehicles with an electrical socket flap: if an obstacle impedes the socket flap while it is opening, the socket flap will close again automatically.

- ① When the vehicle is started (the **READY** display is lit in the driver's display), socket flap ① cannot be opened.
 - ▶ Open socket cover ④ of the lower connection of vehicle socket ③ until it engages.
 - ① The CCS charging cable connector requires both vehicle socket connections ③.
 - ▶ Insert the charging cable connector into vehicle socket ③ to the stop. Make sure that the charging cable is not taut when inserted.
- Status display ② flashes orange and, as soon as the high-voltage battery is charged, blue.
- ① When the charging sequence for the ambient lighting is activated, the ambient lighting lights up for approximately 30 seconds as with status display ② (→ page 224). When Sound Experience is activated, different situations, for example the charging cable connector being inserted or the beginning of

the charging process, are accompanied by selected sounds (→ page 592).

Vehicles with an electric socket flap: if a charging cable is not connected to the vehicle after the socket flap has been opened, the socket flap will close automatically after approx. 60 seconds.

When the charging cable is connected to the vehicle, the vehicle cannot be started or moved.

At the start of the charging process, the charge level display is shown in the driver's display with a charging prediction. The charging prediction refers to the time at which the high-voltage battery will be fully charged.

- ① Depending on the temperature, the fan and battery cooling system may audibly switch on during the charging process.
- ① If the vehicle is idle for lengthy periods and connected to the mains supply, the high-voltage battery will be recharged automatically as needed or when electrical consumers are activated (e.g. the pre-entry climate control).

Ending the direct current charging process (mode 4)

⚠ DANGER Risk of death when charging at a damaged socket

The charging process uses high voltage.

If the charging cable, the vehicle socket or the mains socket are damaged, you could receive an electric shock.

- ▶ Only use an undamaged charging cable.
- ▶ Avoid mechanical damage such as crushing, abrading or driving over the cable.
- ▶ Have a damaged vehicle socket replaced at a qualified specialist workshop as soon as possible.
- ▶ Never connect the charging cable to a damaged vehicle socket.

! **NOTE** Damage due to overheating of charging cable and charge port

During the charging process, the charging cable and charge port can heat up within the permissible limits.

The permissible limit values are influenced by the following factors:

- the power supply system and the charging cable are not damaged
 - the instructions for handling the charging cable and the control element on the charging cable have been observed
- ▶ If the charging cable or charge port becomes too hot, have the power supply system checked.

! **NOTE** Damaged or dirty vehicle socket when the socket flap is open

- ▶ Always keep the socket cover and the socket flap closed when there is no charging cable connected. This protects the vehicle socket from dirt and damage.

- ▶ Make sure that the socket cover is closed properly before closing the socket flap. This can otherwise result in damage which may prevent the socket flap from being opened again.

Requirements

- The vehicle is unlocked or the vehicle is locked and the distance between the key and the vehicle does not exceed 1 m.
- i** Depending on the national version, the vehicle is equipped with one of the following vehicle sockets.

Combo 1 vehicle socket

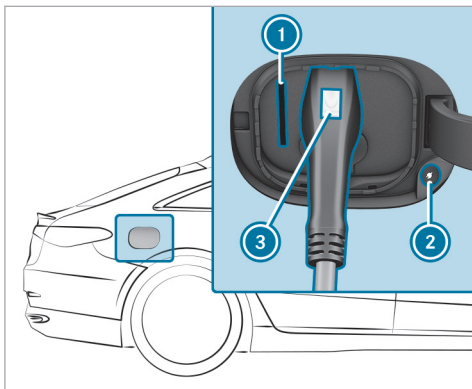

- ▶ Press charging interruption button (2). The charging process is ended. Status display (1) lights up white. The vehicle socket is unlocked.

- ⓘ Alternatively, it is possible to unlock the vehicle with the vehicle key in order to end the charging process, but only if charging inter-

ruption button (2) is not functioning. To do so, press the  button once on the vehicle key. When status display (1) lights up white, the vehicle socket is unlocked for approx. 30 seconds.

- ▶ Press and hold button (3) on the charging cable connector and remove the charging cable connector from the vehicle socket. The hinged socket cover opens upward and locks the lower connection on the vehicle socket.
- ⓘ If you cannot remove the charging cable connector, unlock the vehicle and repeat the procedure. If the charging cable connector is still locked, contact a qualified specialist workshop.
- ⓘ Status display (1) remains lit for some time after the charging cable connector has been removed and then goes out.
- ▶ Close the socket flap. For vehicles with an electric socket flap, observe the notes at the end of the section.

Combo 2 vehicle socket

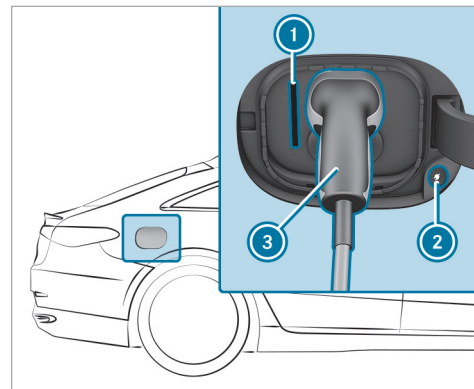

- ▶ Press charging interruption button (2). The charging process is ended. Status display (1) lights up white. The vehicle socket is unlocked.

❗ Alternatively, it is possible to unlock the vehicle with the vehicle key in order to end the charging process, but only if charging interruption button ❷ is not functioning. To do so, press the  button once on the vehicle key. When status display ❶ lights up white, the vehicle socket is unlocked for approx. 30 seconds.

▶ Remove charging cable connector ❸ from the vehicle socket. The hinged socket cover opens upward and locks the lower connection on the vehicle socket.

❗ If you cannot remove the charging cable connector, unlock the vehicle and repeat the procedure. If the charging cable connector is still locked, contact a qualified specialist workshop.

❗ Status display ❶ remains lit for some time after the charging cable connector has been removed and then goes out.

▶ Close the socket flap.
For vehicles with an electric socket flap, observe the following notes on closing the socket flap.

The electric socket flap closes automatically in the following situations:

- shortly after the charging cable connector has been removed
- after the socket flap has been tapped in the direction to close it
- after transmission position **N**, **D** or **R** has been engaged

Automatic reversing function of the electric socket flap

If an obstacle impedes the electrical socket flap while it is closing, the socket flap will open again automatically. The automatic reversing function is only an aid and is not a substitute for your attentiveness.

▶ When closing the socket flap, make sure that no body parts or objects are in the closing area.

Function of the charge level display in the driver's display

❗ The data shown in the illustration is example data.

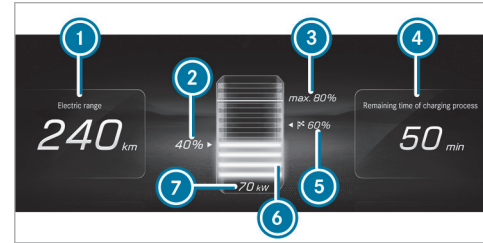

- ❶ Range at current charge level
- ❷ Current state of charge of the high-voltage battery
- ❸ Maximum state of charge (depending on the setting)
- ❹ Time remaining until completely charged (until the selected maximum charge level is reached)

- ⑤ Charge level recommended by Range Assistant to reach the next destination
 - ⑥ Dynamic charge level display
 - ⑦ Current charging capacity
- ① Specified remaining range ① may vary due to different factors, e.g. driving style or topography.

When the vehicle is connected to the mains supply and is switched off, the driver's display shows the charge level display for approximately two minutes.

- ① The value of current charging capacity ⑦ can differ from the display on the charging station. At a charging capacity of 10 kW or higher, the value in the charge level display is rounded off and shown without a decimal place.

The value in ④ varies depending on the setting of the charging process. It displays the charging prediction, e.g. the time at which the selected charge level will be reached or the charge level at the pre-selected departure time.

Configuring the charging settings

Multimedia system:



Setting the charging program

You can watch an animation on this topic via the following link:

- ▶ Select [Home](#), [Work](#) or [Standard](#).

Opening and closing the socket flap using the MMS

- ▶ Press [Open socket flap](#) to open the socket flap.
- ▶ The charging process can be interrupted using [Cancel charging](#). The charging process is ended and the charging cable is unlocked.
- ▶ Press [Close socket flap](#) to close the socket flap. The socket flap also closes automatically when the transmission is shifted out of position **P**. The socket flap also closes automatically after one minute if it has been opened but no plug has been inserted, and ten to fifteen seconds after the plug has been removed.

- ① Closing the socket flap via the MMS is only available on vehicles with an electric socket flap.
- ① Further notes on charging with alternating current: (→ page 285) or direct current: (→ page 290).

Unlocking the charging cable (mode 3 or 4)

- ① When the function is active, the charging cable is unlocked when the maximum charge level is reached.

- ▶ Select [Home](#) or [Work](#).
- ▶ Activate or deactivate [Unlock charging cable](#).

Activating or deactivating location-based charging

- ▶ Select [Charge at home](#) or [Charge at work](#).
- ▶ Activate or deactivate [Select based on location](#).

When the function is activated, the vehicle's current position is saved as one of the selected options. When the address is reached again, the charging program is automatically switched over as soon as parking position **P** is engaged.

Activating or deactivating ECO charging

- ▶ Activate or deactivate the function.

The **ECO charging** function limits the charging current at charging stations to conserve the vehicle's battery.

Setting the departure time

The set departure times are used for the vehicle's pre-entry climate control and for predictions regarding the approximate state of charge and range at the time selected.

DC charging: the charging process always starts without delay.

AC charging: if the ECO charging function is activated, the charging process pauses and is resumed as late as possible depending on the set charge level. The charging process is time-based.

- ▶ Select **Departure time**.

The following charging times can be selected:

- individual charging times
- a **Week profile**

Setting an individual departure time

- ▶ Select **Add new time** and set a new departure time.

or

- ▶ Select  and adapt an existing departure time.

Setting the repeat days

- ▶ Select **Add new time** and set a new departure time.

- ▶ Mark the relevant weekdays for which the departure time will apply and confirm with .

or



- ▶ Select  and edit existing repeat days.

Setting a break in the charging process (alternating current only)

Up to four breaks in the charging process can be set during which the vehicle is not charged, even if it is connected to a charging station.

- ▶ Select **Charging interruptions**.

- ▶ Select **Add new time** and then set and save the times for the beginning and end of the break.
- ▶ Activate or deactivate the charging breaks that have been set.

Set charging breaks can be edited with the  button or deleted with the  button.

Parking

Parking the vehicle

- ⚠ **WARNING** Risk of accident and injury caused by an insufficiently secured vehicle rolling away

If the vehicle is not securely parked sufficiently, it can roll away in an uncontrolled way even at a slight downhill gradient.

- ▶ On uphill or downhill gradients, turn the front wheels so that the vehicle rolls towards the kerb if it starts moving.
- ▶ apply the parking brake.
- ▶ Switch the transmission to position .

⚠ WARNING Accident- and risk of injury with unsupervised children in the vehicle

If you leave children unattended in the vehicle, they can in particular

- Open doors and thereby endanger other persons or road users.
- get out of the car and are hit by traffic.
- Operate vehicle equipment and become trapped, for example.

In addition, the children could also set the vehicle in motion, for example by:

- releasing the parking brake.
- change the gearbox setting.
- start the vehicle.

- ▶ Never leave children unattended in the vehicle.
- ▶ When leaving the vehicle, always take the SmartKey with you and lock the vehicle.
- ▶ Keep the key out of reach of children.

This also applies to the Digital Vehicle Key.

! NOTE Damage to the vehicle due to it rolling away

- ▶ Always secure the vehicle against rolling away.

! NOTE Damage caused by vehicle being lowered

Vehicles AIRMATIC: The vehicle can be lowered due to differences in temperature or extended non-operational times. This can cause damage to parts of the body.

- ▶ When stopping the vehicle and when driving off, make sure that there are no obstacles such as kerbs under or in the immediate vicinity of the body.

i If you park the vehicle for a long period, observe the following notes:

- Make sure the high-voltage battery has a sufficient state of charge, especially at very low outside temperatures. That way, you can avoid any problems when the vehicle is subsequently started.

- If possible, avoid parking spaces in direct sunlight.

Observe the notes on charging the high-voltage battery (→ page 276).

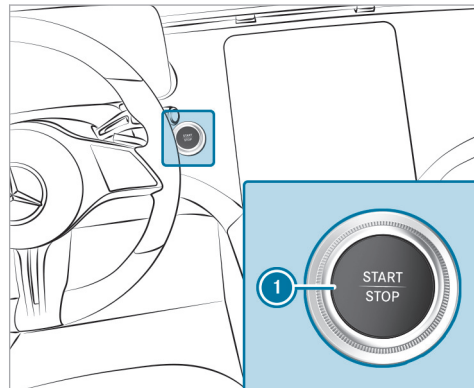

Vehicles with central display

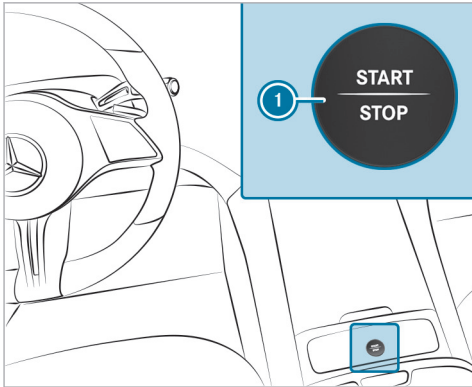

Vehicles with MBUX Hyperscreen

- ▶ Bring the vehicle to a standstill by depressing the brake pedal.
- ▶ On uphill or downhill gradients, turn the front wheels so that the vehicle rolls towards the kerb if it starts moving.
- ▶ Apply the electric parking brake.

- ▶ Engage transmission position **P** in a stationary vehicle with the brake pedal depressed (→ page 273).
 - ▶ Switch off the vehicle by pressing button ①.
 - ▶ Release the service brake slowly.
 - ▶ Get out of the vehicle and lock it.
- ① When you park the vehicle, you can still operate the side windows and the panoramic sliding sunroof for approximately four minutes if the driver's door is closed.

Electric parking brake

Function of the electric parking brake (applying automatically)

⚠ WARNING Accident- and risk of injury with unsupervised children in the vehicle

If you leave children unattended in the vehicle, they can in particular

- Open doors and thereby endanger other persons or road users.

- get out of the car and are hit by traffic.
- Operate vehicle equipment and become trapped, for example.

In addition, the children could also set the vehicle in motion, for example by:

- releasing the parking brake.
 - change the gearbox setting.
 - start the vehicle.
- ▶ Never leave children unattended in the vehicle.
 - ▶ When leaving the vehicle, always take the SmartKey with you and lock the vehicle.
 - ▶ Keep the key out of reach of children.

This also applies to the Digital Vehicle Key.

The electric parking brake is applied if the transmission is in position **P** and one of the following conditions is fulfilled:

- The vehicle is switched off.

- The seat belt tongue is not inserted in the seat belt buckle of the driver's seat and the driver's door is opened.

 To prevent application: pull the handle of the electric parking brake (→ page 300).

In the following situations, the electric parking brake is also applied:







- The HOLD function is keeping the vehicle stationary.
- Active Parking Assist is keeping the vehicle stationary.
- Active Distance Assist DISTRONIC is bringing the vehicle to a standstill.
- **In addition, one of the following conditions must be fulfilled:**
 - The vehicle is switched off.
 - The seat belt tongue is not inserted in the seat belt buckle of the driver's seat and the driver's door is opened.
 - There is a system malfunction.
 - The power supply is insufficient.

- The vehicle is stationary for a lengthy period.

When the electric parking brake is applied, the red  indicator lamp lights up in the driver's display.

■ Function of the electric parking brake (releasing automatically)

The electric parking brake is released when the following conditions are fulfilled:

- The driver's door is closed.
- The vehicle has been started.
- The transmission is in position  or  and you depress the accelerator pedal or you shift from transmission position  to  or  when on level ground.
- If the transmission is in position , the boot lid must be closed.
- The seat belt tongue is inserted into the seat belt buckle of the driver's seat.

If the seat belt tongue is not inserted into the seat belt buckle of the driver's seat, one of the following conditions must be fulfilled:

- You shift from transmission position .
- or
- You have previously driven at speeds greater than 3 km/h.

When the electric parking brake is released, the red  indicator lamp in the driver's display goes out.

■ Applying/releasing the electric parking brake manually

 **WARNING** Accident- and risk of injury with unsupervised children in the vehicle

If you leave children unattended in the vehicle, they can in particular

- Open doors and thereby endanger other persons or road users.
- get out of the car and are hit by traffic.
- Operate vehicle equipment and become trapped, for example.

In addition, the children could also set the vehicle in motion, for example by:

- releasing the parking brake.
- change the gearbox setting.
- start the vehicle.

- ▶ Never leave children unattended in the vehicle.
- ▶ When leaving the vehicle, always take the SmartKey with you and lock the vehicle.
- ▶ Keep the key out of reach of children.

This also applies to the Digital Vehicle Key.

Applying

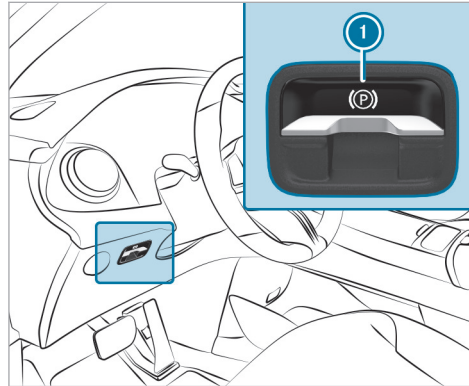

- ▶ Push handle ①.
The red (P) indicator lamp lights up in the driver's display.
- ⓘ The electric parking brake is only securely applied if the red (P) indicator lamp is lit continuously.

Releasing

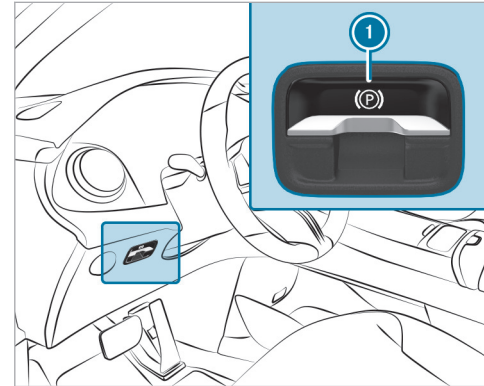

- ▶ Switch on the vehicle.
- ▶ Pull handle ①.
The red (P) indicator lamp in the driver's display goes out.

Emergency braking

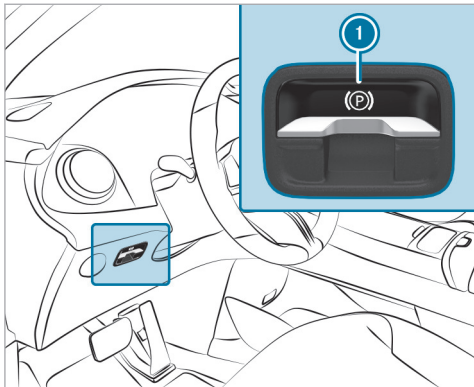

- ▶ Press and hold handle ①.
As long as the vehicle is in motion, the **Release parking brake** message is displayed and the red **(P)** indicator lamp flashes.
- When the vehicle has been braked to a standstill, the electric parking brake is applied. The

red **(P)** indicator lamp lights up in the driver's display.

Information on collision detection on a parked vehicle

If a collision is detected on the locked vehicle when towing protection is switched on, and the collision detection is switched on, when the vehicle is switched on, you will receive a message in the multimedia system.

You will receive information about the following points:

- The area of the vehicle that may have been damaged.
- The force of the impact.

The following situation can lead to inadvertent activation:

- Foreexample, the parked vehicle is moved to a two-storey garage.
- ① Deactivate tow-away protection to prevent accidental activation. If you deactivate tow-

away protection, collision detection will also be deactivated.

You can permanently deactivate collision detection via the multimedia system (→ page 303).

System limits

Detection may be restricted in the following situations:

- the vehicle is damaged without impact, foreexample, if an outside mirror is torn off or the paint is damaged by a key
 - an impact occurs at low speed
 - the electric parking brake is not applied
- ① You are responsible for your vehicle. Convince yourself that your vehicle is free of damage and roadworthy.

Setting collision detection on a parked vehicle

Multimedia system:

→  ► Settings ► Vehicle
► Open/close ► Vehicle protection

► Activate or deactivate the function via **Collision notification**.

- ⓘ A maximum of three incidents can be registered. Up to 15 photos are taken for every incident. In the event of another incident, the photos of the first incident will be overwritten if they have not been deleted already.

Activating or deactivating the collision photos function

Note possible legal restrictions in some countries regarding automatic recording of the vehicle surroundings.

► Activate or deactivate **Collision photos**.

Transferring the collision photos with the Mercedes me App

- Select **Upload collision photos**.
- Select **Upload automatically**.

► Scan the generated QR code on the central display with the Mercedes me App. The encrypted collision photos will then be uploaded to Mercedes me.

- ⓘ Any device that can scan QR codes can be used to view the collision photos in the Mercedes me App.

Copying the collision photos to a USB flash drive

- Connect a USB flash drive (→ page 572).
- Select **Manage collision photos**.
- Select **Copy (USB)**.
All collision photos are copied to the USB flash drive.

- ⓘ Only use FAT32 or exFAT formatted USB storage devices to ensure secure operation.

Deleting collision photos

- Select **Manage collision photos**.
- Select **Delete**.
All collision photos will be deleted.

Driving and driving safety systems

Driving systems and your responsibility

Your vehicle is equipped with driving systems which assist you in driving, parking and manoeuvring the vehicle. The driving systems are only aids. They are not a substitute for you paying attention to your surroundings and do not relieve you of your responsibility pertaining to road traffic law. The driver is always responsible for maintaining a safe distance to the vehicle in front, for vehicle speed, for braking in good time and for staying in lane. Pay attention to the traffic conditions at all times and intervene when necessary. Be aware of the limitations regarding the safe use of these systems.

Driving systems can neither reduce the risk of accident if you fail to adapt your driving style nor override the laws of physics. They cannot always take into account road, weather or traffic conditions.

- ⓘ Some driving systems can regulate or limit the speed to a previously set value. Draw attention to the stored speed when changing drivers.

Information on vehicle sensors and cameras

Some driving and driving safety systems use cameras as well as radar or ultrasonic sensors to monitor the area in front of, behind or next to the vehicle.

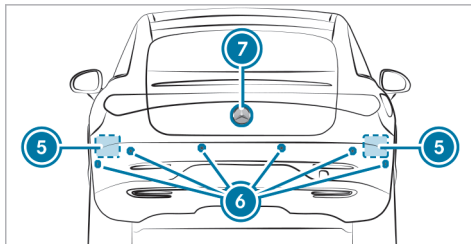
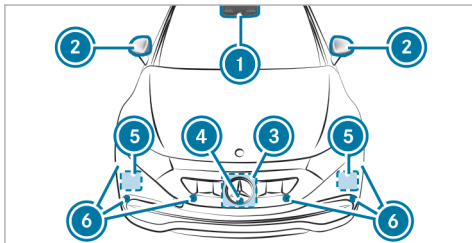

- ① Multifunction camera
- ② Cameras in the outside mirrors
- ③ Front radar
- ④ Front camera
- ⑤ Corner radars
- ⑥ Ultrasonic sensors
- ⑦ Reversing camera

⚠ WARNING Risk of accident due to restricted detection performance of vehicle sensors and cameras

If the area around vehicle sensors or cameras is covered, damaged or dirty, certain driving and safety systems cannot function correctly. There is a risk of an accident.

- ▶ Keep the area around vehicle sensors or cameras clear of any obstructions and clean.
- ▶ Have damage to the bumper, radiator grille or stone chipping in the area of the front and rear windows repaired at a qualified specialist workshop.

Particularly, keep the areas around the sensors and cameras free of dirt, ice or slush (→ page 604). The sensors and cameras must not be covered and the detection ranges around them must be kept free. Do not attach additional licence plate brackets, advertisements, stickers, foils or foils to protect against stone chippings in the detection range of the sensors and cameras.

Make sure that there are no overhanging loads protruding into the detection range.

If there is damage to a bumper or the radiator grille, or after an impact, have the function of the sensors checked at a qualified specialist workshop. Have damage or stone chipping in the area of the cameras on the front and rear windows repaired at a qualified specialist workshop.

i The reversing camera can extend and retract automatically for the purpose of calibration, even though there is no camera image in the display.

Overview of driving systems and driving safety systems

- ABS (→ page 306)
- BAS (→ page 306)
- ESP® (→ page 307)
- ESP® (Mercedes-AMG vehicles) (→ page 308)
- ESP® Crosswind Assist (→ page 310)
- ESP® trailer stabilisation (→ page 310)

- EBD (→ page 312)
- STEER CONTROL (→ page 312)
- HOLD function (→ page 312)
- Hill Start Assist (→ page 313)
- Adaptive Brake Lights (→ page 314)
- Valet service mode (→ page 314)
- Beginner driver mode (→ page 314)
- ATTENTION ASSIST (→ page 315)
- Cruise control (→ page 317)
- Limiter (→ page 318)
- Speed Limit Assist (country-dependent) (→ page 342)
- Traffic Sign Assist (→ page 345)
- Traffic light view (→ page 350)
- AIRMATIC (→ page 357)
- AMG RIDE CONTROL + (→ page 359)
- RACE START (→ page 362)

Driving Assistance Package

i The availability of some functions or sub-functions of the Driving Assistance Package is

equipment- or country-specific. The functions of your Driving Assistance Package may differ from the functions listed here.

Active Distance Assist DISTRONIC, Active Blind Spot Assist, Active Brake Assist, Active Lane Keeping Assist and Active Emergency Stop Assist are also available without the Driving Assistance Package, albeit with restricted functionality.

- Active Distance Assist DISTRONIC (→ page 321)
- Active Speed Limit Assist (→ page 327)
- Route-based speed adaptation (→ page 328)
- Active Brake Assist (→ page 336)
- Active Steering Assist (→ page 330)
- Active Emergency Stop Assist (→ page 332)
- Active Lane Change Assist (→ page 334)
- Active Stop-and-Go Assist (→ page 330)
- Active Blind Spot Assist with exit warning (→ page 350)
- Active Lane Keeping Assist (→ page 354)
- PRE-SAFE® Impulse Side (→ page 100)

Parking Package

- ① The availability of individual functions depends on the country and equipment.
- Reversing camera (→ page 364)
- 360° Camera (→ page 366)
- Parking Assist PARKTRONIC (→ page 371)
- Active Parking Assist (→ page 375)
- Remote Parking Assist (→ page 382)
- Memory Parking Assist (country-dependent) (→ page 389)

Information about the AMG DYNAMIC PLUS package

- ① The AMG DYNAMIC PLUS package is on-demand equipment (→ page 75).

! **NOTE** Vehicle and tyre damage caused by non-approved tyre types

Driving at increased maximum design speed is only approved for a specific types of tyres.

▶ Before using the functions, observe the information on approved tyre types. You

could otherwise fail to recognise dangers.

You will find the information on the approved tyre types in the "Wheels and tyres" section" (→ page 632).

The AMG DYNAMIC PLUS package includes the following functions:

- Raising of the maximum design speeds (→ page 763)
- RACE START with boost function (→ page 362)
- Additional Performance Sound Experience for a particularly sporty driving experience(→ page 593)

Function of ABS

The Anti-lock Brake System (ABS) regulates the brake pressure in critical driving situations:

- During braking, for instance, at maximum full-stop braking or if there is insufficient tyre traction, the wheels are prevented from locking.

- Vehicle steerability while braking is ensured.

If ABS intervenes when braking, you will feel a pulsing in the brake pedal. The pulsating brake pedal can be an indication of hazardous road conditions and can serve as a reminder to take extra care while driving.

System limits

- ABS is active from speeds of approximately 5 km/h.
- ABS may be impaired or may not function if a malfunction has occurred and the yellow  ABS warning lamp lights up continuously after the vehicle is started.

Function of BAS

! **WARNING** Risk of an accident caused by a malfunction in BAS (Brake Assist System)

If BAS is malfunctioning, the braking distance in an emergency braking situation is increased.

- ▶ Depress the brake pedal with full force in emergency braking situations. ABS prevents the wheels from locking.

The Brake Assist System (BAS) supports your emergency braking situation with additional brake force.

If you depress the brake pedal quickly, BAS is activated:

- BAS automatically boosts the brake pressure.
- BAS can shorten the braking distance.
- ABS prevents the wheels from locking.

The brakes will function as usual once you release the brake pedal. BAS is deactivated.

Function of ESP®

⚠ WARNING Risk of skidding if ESP® is deactivated

If you deactivate ESP®, ESP® cannot carry out vehicle stabilisation.

- ▶ ESP® should only be deactivated in the following situations.

The Electronic Stability Program (ESP®) can monitor and improve driving stability and traction in the following situations within physical limits:

- When pulling away on wet or slippery carriageways.
- When braking.

If the vehicle deviates from the direction desired by the driver, ESP® can stabilise the vehicle by intervening in the following ways:

- One or more wheels are braked.
- The drive system output is adapted according to the situation.

When ESP® is deactivated, the  warning lamp lights up continuously:

- Driving stability will no longer be improved.
- The drive wheels could spin.
- ETS/4ETS traction control is still active.

- ⓘ When ESP® is deactivated, you are still assisted by ESP® when braking.

When the  warning lamp flashes, one or several wheels has reached its grip limit:

- Adapt your driving style to suit the current road and weather conditions.
- Do not deactivate ESP®.
- Only depress the accelerator pedal as far as is necessary when pulling away.

Deactivate ESP® in the following situations to improve traction:

- When using snow chains.
- In deep snow.
- On sand or gravel.

- ⓘ Spinning the wheels results in a cutting action, which enhances traction.

If the  warning lamp lights up continuously, ESP® is not available due to a malfunction.

Observe the following information:

- Warning and indicator lamps (→ page 858)
- Display messages (→ page 770)

ETS/4ETS (Electronic Traction System)

ETS/4ETS traction control is part of ESP® and makes it possible to pull away and accelerate on a slippery carriageway.

ETS/4ETS can improve the vehicle's traction by intervening in the following ways:

- The drive wheels are braked individually if they spin.
- More drive torque is transferred to the wheel or wheels with traction.

Influence of drive programs on ESP®

The drive programs enable ESP® to adapt to different weather and road conditions as well as the driver's preferred driving style. Depending on the selected drive program, the appropriate ESP® mode will be activated (→ page 268, 269).

Function of ESP® (Mercedes-AMG vehicles)

You can select between the following modes of the Electronic Stability Program (ESP®):

- ESP® ON
- ESP® SPORT

- ESP® OFF

Characteristics when ESP® is activated

ESP® monitors and improves driving stability and traction, particularly in the following situations:

- When pulling away on wet or slippery carriageways.
- When braking.
- **Vehicles with trailer hitch:** in trailer operation from speeds of 65 km/h, if the vehicle/trailer combination begins to sway from side to side.
- When there is a strong crosswind of 80 km/h or more.

ESP® can stabilise the vehicle by intervening in the following ways:

- One or more wheels are braked.
- The drive system output is adapted according to the situation.

ESP® is activated every time the vehicle is started, regardless of whether ESP® SPORT or ESP® OFF was selected before the vehicle was parked.

When the  warning lamp flashes, one or several wheels has reached its grip limit:



- Adapt the driving style to suit the prevailing road and weather conditions.
- Do not deactivate ESP® under any circumstances.
- Only depress the accelerator pedal as far as necessary.

Characteristics of ESP® SPORT

⚠ WARNING Risk of skidding if ESP® SPORT is used incorrectly

When you activate ESP® SPORT, there is an increased risk of skidding and having an accident.

▶ Activate ESP® SPORT only in the circumstances described below.

When ESP® SPORT is selected, the  and  warning lamps light up continuously.

Select ESP® SPORT when the vehicle's own oversteering and understeering characteristics are desired, e.g. on cordoned-off roads.

Driving with ESP® SPORT or with ESP® deactivated requires an extremely qualified and experienced driver.

If ESP® SPORT is activated and one or more wheels start to spin, the  warning lamp flashes. ESP® then only stabilises the vehicle to a limited degree.

ESP® SPORT also has the following characteristics:

- ESP® only improves driving stability to a limited degree.
- ETS/4ETS traction control is still active.
- The power of the drive system is only slightly limited according to the situation and the drive wheels can spin.
The spinning of the wheels results in a cutting action for better traction on loose surfaces.
- ESP® continues to provide assistance when the brakes are firmly applied.



- **Vehicles with trailer hitch:** stabilisation of the vehicle/trailer combination is no longer active.
- Crosswind Assist is no longer active.

Characteristics when ESP® is deactivated

 **WARNING** Risk of skidding if ESP® is deactivated

If you deactivate ESP®, ESP® cannot carry out vehicle stabilisation.

 ESP® should only be deactivated in the following situations.



When ESP® is deactivated, the  and  warning lamps light up continuously.

Deactivating ESP® has the following effects:

- Driving stability will no longer be improved.
- The drive wheels could spin.
- ETS/4ETS traction control is still active.
- **Vehicles with trailer hitch:** stabilisation of the vehicle/trailer combination is no longer active.

- Crosswind Assist is no longer active.
-  Even when ESP® is deactivated, you are still assisted by ESP® when braking hard.

It may be best to activate ESP® SPORT or deactivate ESP® in the following situations:

- When using snow chains.
- In deep snow.
- On sand or gravel.
-  Spinning the wheels results in a cutting action, which enhances traction.
-  Activate ESP® as soon as the situations described above no longer apply. ESP® will otherwise not be able to stabilise the vehicle if the vehicle starts to skid or a wheel starts to spin.

If the  warning lamp lights up continuously, ESP® is not available due to a malfunction.

Observe the display messages, warning lamps and indicator lamps, which are shown.

- Indicator and warning lamps (→ page 858)
- Display messages (→ page 770)

ETS/4ETS (Electronic Traction System)

ETS/4ETS traction control is part of ESP®.

ETS/4ETS can improve the vehicle's traction by intervening in the following ways:

- The drive wheels are braked individually if they spin.
- More drive torque is transferred to the wheel or wheels with traction.

Function of ESP® Crosswind Assist

ESP® Crosswind Assist detects sudden gusts of side wind and helps the driver to keep the vehicle in the lane:

- ESP® Crosswind Assist is active at vehicle speeds between approx. 80 km/h and 200 km/h when driving straight ahead or cornering slightly.
- The vehicle is stabilised by means of individual brake application on one side.

Function of ESP® trailer stabilisation

⚠ WARNING Risk of accident in poor road and weather conditions

In poor road and weather conditions, the trailer stabilisation cannot prevent lurching of the vehicle/trailer combination. Trailers with a high centre of gravity may tip over before ESP® detects this.

▶ Always adapt your driving style to suit the current road and weather conditions.

When driving with a trailer, ESP® can stabilise your vehicle if the trailer begins to swerve from side to side:

- ESP® trailer stabilisation is active above speeds of 65 km/h.
- Slight swerving is reduced by means of a targeted, individual brake application on one side.
- In the event of severe swerving, the operating energy output is also reduced and all wheels are braked.

ESP® trailer stabilisation may be impaired or may not function if:

- The trailer is not connected correctly or is not detected properly by the vehicle.

Activating or deactivating ESP® (Electronic Stability Program)

Multimedia system:



- ▶ Select **ESP**.
- ▶ Select **On** or **Off**.

ESP® is deactivated if the  ESP® OFF warning lamp lights up continuously in the driver's display.

Observe any information on warning lamps and display messages which may be shown in the driver's display.

Setting ESP® with the steering-wheel button

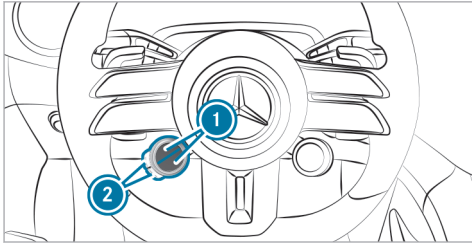

- ⓘ You can also adjust ESP® via the multimedia system (→ page 311).





▶ **To set ESP®:** press upper or lower display button ① repeatedly, until it displays the  symbol.

① If the display button does not show the symbol, then it is hidden. How functions are displayed and the order in which they are displayed can be set in the multimedia system (→ page 266).



The lane colour of the  button symbol indicates the current setting:

-  (blue): ESP® ON
-  (yellow): ESP® SPORT
-  (red): ESP® OFF



▶ **To set ESP® SPORT:** briefly press button ② when ESP® is activated. The road in the  button symbol lights up yellow.

The  and  warning lamps appear in the driver's display.

▶ **To deactivate ESP®:** select ESP® SPORT and then press and hold button ②. The road in the  button symbol lights up red.

The  and  warning lamps appear in the driver's display.

▶ **To activate ESP®:** briefly press button ② when ESP® SPORT is selected or ESP® is deactivated. The road in the  button symbol lights up blue.

The  and  or  warning lamps go out.

If the  symbol is shown with a red ! on the display button, ESP® is malfunctioning. Observe the information on warning lamps and display messages which are shown in the driver's display.

F295 0041 02



Setting ESP® in the multimedia system





Multimedia system:

→  ▶ Settings ▶ Vehicle
▶ DYNAMIC SELECT



① Depending on the equipment, the AMG menu **DYNAMIC SELECT** can also be called up using the AMG button in the centre console.

ESP is always activated when the vehicle is started. The road in the  button symbol lights up blue.

▶ **To set ESP SPORT:** when ESP is activated, briefly press  to change to the **Sport** program. The road in the  button symbol lights up yellow.

▶ **To deactivate ESP:** set the ESP SPORT program and press and hold  to deactivate ESP. The road in the  button symbol lights up red. The  and  warning lamps appear in the driver's display.

▶ **To activate ESP:** briefly press  in ESP SPORT or if ESP is deactivated. The road in the  button symbol lights up blue.

The  and  or  warning lamps go out.

ⓘ You can also adjust ESP via the steering-wheel button (→ page 310).

Function of EBD

Electronic Brakeforce Distribution (EBD) is characterised by the following:

- Monitoring and regulating the brake pressure on the rear wheels.
- Improved driving stability when braking, especially on bends.

Function of STEER CONTROL

STEER CONTROL assists you by transmitting a noticeable steering force to the steering wheel in the direction required for vehicle stabilisation.

This steering recommendation is given in the following situations:

- Both right wheels or both left wheels are on a wet or slippery road surface when you brake.
- The vehicle starts to skid.

System limits

STEER CONTROL may be impaired or may not function in the following situations:

- ESP[®] is deactivated.
- ESP[®] is malfunctioning.
- The steering is malfunctioning.

If ESP[®] is malfunctioning, you will be assisted further by the power steering.

HOLD function

■ HOLD function

The HOLD function holds the vehicle at a stand-still without requiring you to depress the brake pedal, e.g. while waiting in traffic.

The HOLD function is only an aid. The responsibility for the vehicle safely standing still remains with the driver.

System limits

The HOLD function is only intended to provide assistance when driving and is not a sufficient means of safeguarding the vehicle against rolling away when stationary.

- The incline must not be greater than 30%.

■ Activating/deactivating the HOLD function

⚠ WARNING Risk of an accident due to the HOLD function being active when you leave the vehicle

If the vehicle is only braked with the HOLD function it could, in the following situations, roll away:

- If there is a malfunction in the system or in the power supply.
- If the HOLD function is deactivated by depressing the accelerator pedal or brake pedal, e.g. by a vehicle occupant.

- ▶ Always secure the vehicle against rolling away before you leave it.

Requirements

- The vehicle is stationary.
- The driver's door is closed or the seat belt on the driver's side is fastened.
- The vehicle has been started.
- The electric parking brake is released.
- Active Distance Assist DISTRONIC is deactivated.
- The transmission is in position **D**, **R** or **N**.

Activating the HOLD function

- ▶ Depress the brake pedal, and after a short time quickly depress further until the **HOLD** display appears in the driver's display.
- ▶ Release the brake pedal.

Deactivating the HOLD function

- ▶ Depress the accelerator pedal to pull away.
or

- ▶ Depress the brake pedal until the **HOLD** display disappears from the driver's display.

The HOLD function is deactivated in the following situations:

- Active Distance Assist DISTRONIC is activated.
- The transmission is shifted to position **P**.
- The vehicle is secured with the electric parking brake.

In the following situations, the vehicle is held by transmission position **P** and/or by the electric parking brake:

- The seat belt is unfastened and the driver's door is opened.
- The vehicle is switched off.
- There is a system malfunction.
- The power supply is insufficient.

In addition, the **Brake immediately** message may appear in the driver's display and a horn tone may sound at regular intervals.

- ▶ Immediately depress the brake pedal firmly until the warning message disappears. The HOLD function is deactivated.
- ▶ Additionally secure the vehicle against rolling away.

Function of Hill Start Assist

Hill Start Assist holds the vehicle for a short time when pulling away on a hill under the following conditions:

- The transmission is in position **D** or **R**.
- The electric parking brake is released.

This gives you enough time to move your foot from the brake pedal to the accelerator pedal and depress it before the vehicle begins to roll away.

⚠ WARNING Risk of accident and injury due to the vehicle rolling away

After a short time, Hill Start Assist no longer holds the vehicle.

- ▶ Swiftly move your foot from the brake pedal to the accelerator pedal. Do not

leave the vehicle when it is being held by Hill Start Assist.

Function of Adaptive Brake Lights

Adaptive Brake Lights warn following traffic in an emergency braking situation with the following actions:

- flashing the brake lamps
- activating the hazard warning lights (→ page 45)

If the vehicle is braked sharply from speeds above 50 km/h, the brake lamps flash rapidly. This provides traffic travelling behind you with an even more noticeable warning.

Valet service mode

Function of the valet service mode

- ⓘ This function is an on-demand feature (→ page 75).

In valet service mode, the vehicle acceleration is limited to reduce the risk of damage to and

improper use of the vehicle when it is handed over to third parties.

Valet service mode is characterised by the following:

- Power output is reduced.
- In principle, a maximum speed of 80 km/h can be reached.
- The sporty drive programs and the drive program  are not available.
- ESP® cannot be deactivated.
- Profiles that are still logged in are logged out and unprotected profiles are secured.

Activating or deactivating valet service mode

Requirements

- For activation: the vehicle is stationary.
- For deactivation: park position  is engaged.

Multimedia system:

   **Apps**  **Valet service mode**

- ⓘ This function is an on-demand feature (→ page 75).

▶ Activating or deactivating the function. If valet service mode is activated, an indicator lamp in the driver's display lights up.

- ⓘ Alternatively, valet service mode can be activated or deactivated via the Mercedes me connect App. Further information on Mercedes me connect (→ page 549)
- ⓘ Valet service mode is protected from deactivation by third parties only in combination with Mercedes me connect. If the vehicle is connected to Mercedes me connect, only the profile that activated the mode or the established main user can deactivate it again.
- ⓘ Valet service mode remains active even following a change of profile or after the vehicle is switched on or off, and must be deliberately deactivated by the authorised user.

Beginner driver mode

Function of the beginner driver mode

- ⓘ This function is an on-demand feature (→ page 75).

In beginner driver mode, the vehicle acceleration is limited to increase safety for inexperienced drivers.

Beginner driver mode is characterised by the following:

- Power output is reduced.
- In principle, a maximum speed of 120 km/h can be reached.
- The sporty drive programs and drive program  are not available.
- ESP® cannot be deactivated.

■ Activating or deactivating beginner driver mode

Requirements

- For activation: the vehicle is stationary.
- For deactivation: park position  is engaged.

Multimedia system:

   **Apps**  **Beginner driver mode**

- ① This function is an on-demand feature (→ page 75).

▶ Activate or deactivate the function. If beginner driver mode is activated, an indicator lamp in the driver's display lights up.

- ① Alternatively, beginner driver mode can be activated or deactivated via the Mercedes me connect app. Further information on Mercedes me connect (→ page 549)
- ① Beginner driver mode is protected from deactivation by third parties only in combination with Mercedes me connect. If the vehicle is connected to Mercedes me connect, only the profile that activated the mode or the established main user can deactivate it again.
- ① Beginner driver mode remains active even following a change of profile or after the vehicle is switched on or off, and must be deliberately deactivated by the authorised user.

ATTENTION ASSIST

■ Function of ATTENTION ASSIST

- ① Depending on the country and equipment, ATTENTION ASSIST has microsleep detection

and distraction detection sub-functions. These functions are only available in conjunction with the driver camera in the driver display (→ page 456).

ATTENTION ASSIST assists you on long, monotonous journeys, e.g. on motorways and trunk roads. If indicators of fatigue or increasing lapses in concentration on the driver's part are detected, the system suggests taking a break.

ATTENTION ASSIST is only an aid. It cannot always detect fatigue or lapses in concentration in time. The system is not a substitute for a well-rested and attentive driver. On long journeys, take regular breaks in good time that allow for adequate recovery.

You can choose between two settings:

- **Standard:** normal system sensitivity.
- **Sensitive:** higher system sensitivity. The driver was warned earlier, and the attention level detected by ATTENTION ASSIST has adapted accordingly.

If fatigue or increasing inattention is detected, the warning appears in the driver display: **ATTEN-**

ATTENTION ASSIST: Take a break! you can acknowledge the message and take a break if necessary. If you do not take a break and ATTENTION ASSIST continues to detect increasing lapses in concentration, you will be warned again after a minimum of 15 minutes.

If the ATTENTION ASSIST is unable to calculate the attention level and cannot issue a warning, the message **System suspended** appears.

If the driver display shows a warning, a service area search is offered in the multimedia system. You can select a rest area and start navigation to this rest area.

When you restart the vehicle, ATTENTION ASSIST is automatically switched on. The last selected sensitivity level remains stored.



The following information is displayed in the driver's display:

- The journey time since the last break
- The attention level determined by ATTENTION ASSIST:
 - The more segments ② of the circle displayed, the higher the detected attention level.
 - As the attention level decreases ②, fewer segments are displayed in the circle.
- The status of microsleep and distraction detection ①:
 - Deactivated: display ① is hidden.

- Activated but not operational: display ① is grey.
- Activated and operational: display ① is green.

Microsleep detection

If the system, which uses the driver camera, detects indicators of microsleep, the **ATTENTION ASSIST Microsleep Take a break!** warning message appears in the driver's display, and a warning tone sounds simultaneously. This warning message must be confirmed by Touch Control. It is recommended that you take a break immediately.

The system can initiate an emergency stop if the driver does not react to the microsleep warning (→ page 332).

Distraction detection

ATTENTION ASSIST can use the driver's camera to detect when the driver is distracted by averting his or her gaze from the road ahead.

If the system detects driver distraction, the white message **ATTENTION ASSIST Remain alert!** appears after a few seconds and a warning tone sounds. If the driver does not return his or her

gaze to the traffic scene, the message is displayed in yellow, and a continuous warning tone sounds.

The system can initiate an emergency stop if the driver does not react to the warning (→ page 332).

System limits

ATTENTION ASSIST is active in the 60 km/h to 200 km/h speed range.

The microsleep detection function is available at a speed of 20 km/h and above.

If the system is unavailable due to a fault, the ATTENTION ASSIST  warning light continuously illuminates the driver display.

Particularly in the following situations, ATTENTION ASSIST only functions in a restricted manner and warnings may be delayed or not occur:

- If you have been driving for less than approximately 30 minutes.
- If the road condition is poor (uneven road surface or potholes).
- If there is a strong side wind.
- If you adopt a sporty driving style (high cornering speeds or high acceleration rates).

- If the Steering Assist function of Active Distance Assist DISTRONIC is active.
- If the clock is set to the incorrect time.
- If you change lanes and vary your speed frequently in active driving situations.

In addition, microsleep and distraction detection does not function when the driver camera cannot detect the driver's eyes, for example as a result of the following factors:

- The driver's eyes are covered due to the steering column position, for example.
- Poor lighting conditions.
- Some types of spectacles or sunglasses.
- The driver's line of vision is outside the driver camera's field of vision.

Also, observe any information regarding display messages in the driver's display.

The ATTENTION ASSIST drowsiness or alertness assessment is reset and restarted when continuing the journey in the following situations:

- You switch off the vehicle.

- If you unfasten your seat belt and open the driver's door (e.g. to change drivers or take a break).

Setting ATTENTION ASSIST

Multimedia system:

  Settings  Assistance
 Assistance  ATTENTION ASSIST

Setting the sensitivity

- ▶ Select  next to ATTENTION ASSIST.
- ▶ Select **Standard** or **Sensitive**.

Activating/deactivating the microsleeep warning

- ▶ Activate or deactivate **Microsleeep warning**.

Cruise control and limiter

Function of cruise control

Cruise control regulates the speed to the value selected by the driver.

For example, the stored speed is not deleted if you accelerate to overtake. If you remove your foot from the accelerator pedal after overtaking, cruise

control will resume speed regulation back to the stored speed.

You can store any speed above 20 km/h up to the maximum design speed, up to the speed recommended by range monitoring or up to the set winter tyre limit.

Observe the notes on driving systems and your responsibility; you may otherwise fail to recognise dangers (→ page 303).

Mercedes-AMG vehicles: cruise control is available up to a maximum speed of 250 km/h.

Displays in the driver's display



Grey: cruise control is selected but not yet active or temporarily passive.



Green: cruise control is active.

A stored speed appears under the  display and is indicated in the speedometer.

System limits

Cruise control may be unable to maintain the stored speed on uphill gradients. The stored speed is resumed when the gradient evens out.

Increase recuperation in good time on long and steep downhill gradients. Take particular note of this when driving a laden vehicle. Doing so will use the electric motor's braking effect to charge the high-voltage battery. This relieves the load on the brake system and prevents the brakes from overheating and wearing too quickly.

Do not use cruise control in the following situations:

- In traffic situations which require frequent changes of speed, e.g. in heavy traffic, on winding roads
- , and slippery roads. Accelerating can cause the drive wheels to lose traction, and the vehicle could skid.
- when visibility is poor

Function of the limiter

The limiter restricts the speed of the vehicle. The limiter automatically applies the brakes to reduce the speed to the set speed.

You can limit the speed in the following ways:

- **Variable:** for short-term limitation of the driving speed, e.g. in built-up areas

- **Permanent:** for a longer-term speed restriction, e.g. in winter tyre mode

You can store any speed above 20 km/h up to the maximum design speed or up to the set winter tyre limit. You can also perform settings while the vehicle is stationary if the vehicle has been started.

Observe the notes on driving systems and your responsibility; you may otherwise fail to recognise dangers (→ page 303).

Mercedes-AMG vehicles: the limiter is available up to a maximum speed of 250 km/h.

Displays in the driver's display



Grey: variable limiter is selected but not yet activated.



Flashing grey: variable limiter is temporarily passive.



Green: variable limiter is activated.

A stored speed appears under the  display and is indicated in the speedometer.

If you depress the accelerator pedal beyond the pressure point (kickdown), the variable limiter

switches to passive mode. The message appears in the driver's display **LIM** *passive*, and the indicator **LIM** flashes.

The variable limiter is reactivated in the following situations:

- The speed travelled falls below the stored speed.
- The stored speed is recalled.
- If you store a new speed.

Operating cruise control or the variable limiter

⚠ WARNING Risk of accident due to stored speed

If you call up the stored speed and this is lower than your current speed, the vehicle decelerates.

▶ Take into account the traffic situation before calling up the stored speed.

Requirements

Cruise control

- Cruise control is selected.

- ESP® must be activated but not intervening.
- The vehicle speed is at least 20 km/h.
- The transmission is in position **D**.

Variable limiter

- The variable limiter is selected.

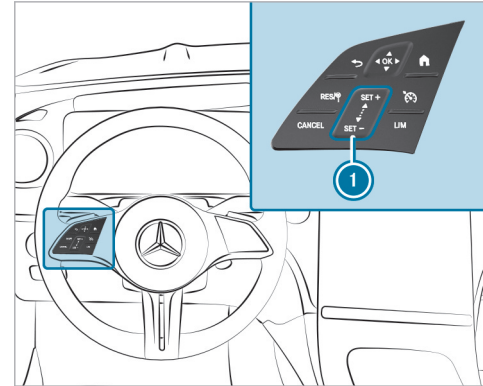



Steering wheel control panel for cruise control and variable limiter

- RES/+** Adopts the stored/detected speed
- CANCEL** Deactivates cruise control/the variable limiter
- OK** Selects cruise control
- LIM** Selects the variable limiter
- 1** Control panel to increase/decrease speed

Operating cruise control and the variable limiter



- ▶ Press the corresponding button with only one finger or swipe on the control panel.

Switching between cruise control and the variable limiter

- ▶ **To select cruise control:** press .
- ▶ **To select the variable limiter:** press .

- ⓘ Vehicles with Active Distance Assist DISTRONIC: the variable limiter is selected by a different button (→ page 324).

Activating cruise control or the variable limiter



- ▶ Press  or  on the control panel . The current vehicle speed is stored and maintains this speed (cruise control) or does not exceed it (variable limiter).

- or
- ▶ Press . The last stored speed is called up, and the vehicle maintains this speed (cruise control) or does not exceed it (variable limiter).



The current vehicle speed is stored if the last stored speed has been deleted.

- ⓘ When you switch off the vehicle, the last speed stored is deleted. When you activate cruise control or Active Distance Assist DISTRONIC, the last speed stored for the variable limiter is deleted.



Increasing/decreasing the stored speed

- ▶ To increase the stored speed: swipe upwards from the bottom of the control panel .
 - The stored speed is increased by 1 km/h.
- ▶ To decrease the stored speed: swipe downwards from the top of the control panel .
 - The stored speed is decreased by 1 km/h.



or

- ▶ Briefly press  or  on the control panel . The stored speed is increased or decreased to the next increment of ten (e.g. to 50 km/h or 60 km/h).

or

- ▶ Press and hold  or  on the control panel . The stored speed is increased or decreased to the next increment of ten and afterwards by increments of 10 km/h.

or

- ▶ Accelerate the vehicle to the desired speed.
- ▶ Press  on the control panel .
- ⓘ When the variable limiter is switched to passive mode, you cannot increase or decrease its stored speed in increments of 1 km/h.

Adopting a detected speed

If cruise control/variable limiter is activated and Traffic Sign Assist has detected a speed restriction sign with a maximum permissible speed, this is displayed in the driver's display:

- ▶ Press . The maximum permissible speed shown by the traffic sign is stored, and the vehicle maintains or does not exceed this speed.

Deactivating cruise control or the variable limiter

- ▶ Press .

 If you brake, deactivate ESP[®] or cruise control is deactivated if ESP[®] intervenes. The variable limiter is not deactivated.

 When you switch off the vehicle, the last speed stored is deleted. When you activate cruise control or Active Distance Assist DISTRONIC, the last speed stored for the variable limiter is deleted.

Information on the permanent limiter

If the vehicle should never exceed a specific speed (e.g. for driving in winter tyre mode), you can set this speed with the permanent limiter.

You do this by limiting the speed between 160 km/h and 240 km/h in the multimedia system (→ page 41).

Shortly before the set speed is reached, it appears on the driver's display. When you confirm the message, display messages no longer appear until you switch off the vehicle. The speed will only be displayed again once the vehicle has been restarted or if the set speed is changed.

The permanent limiter does not switch to passive mode even during kickdown and the driven speed remains below the set speed.

Setting the speed limit for winter tyres

Multimedia system:

  Settings  Vehicle  Driving
 Winter tyre limit

 Activate or deactivate **Winter tyre limit**.

Setting a speed

 Select **Winter tyre limit**.

 Select a speed.

Active Distance Assist DISTRONIC



Function of Active Distance Assist DISTRONIC

DISTRONIC Active Distance Assist maintains the set speed when driving freely. If vehicles are detected ahead, the set distance is maintained, if necessary, until the vehicle comes to a standstill. The vehicle accelerates or brakes depending on the distance to the vehicle in front and the set speed. The speed and distance to the vehicle in front are set and saved using the steering wheel.

Available speed range:

- **Vehicles without Driving Assistance Package:**
20 km/h - 160 km/h

- **Vehicles with Driving Assistance Package:**
20 km/h - 210 km/h

-  The adjustable set speed may differ if a limit speed (, e.g. winter tyre limit) (→ page 321) is stored.
-  If Active Distance Assist DISTRONIC is active and the range monitor recommends a lower driving speed, this is automatically adopted as the new set speed. If necessary, the set speed can be increased again manually.

Other features of Active Distance Assist DISTRONIC:

- Adjusts the driving style depending on the selected drive program (energy-saving, comfortable or dynamic) (→ page 266)
- Initiates acceleration to the stored speed if the turn signal indicator is switched on to change to the overtaking lane
- **Vehicles with Driving Assistance Package:**
 - Reacts to stationary vehicles detected in urban speed ranges (except bicycles and motorcycles)

- Takes one-sided overtaking restrictions into account on motorways or multi-lane roads with separate carriageways (country-dependent)

i In the DYNAMIC SELECT menu, it is possible to set the driving mode of the Active Distance Assist DISTRONIC. Depending on which drive program is selected, the driving characteristics can be geared towards energy economy, comfort or dynamic performance. In the Active Distance Assist menu, the driving style can be permanently set to Comfort or Dynamic (→ page 329).

Vehicles with Active Parking Assist and Driving Assistance Package: if Active Distance Assist DISTRONIC has braked the vehicle to a standstill, it can automatically follow the vehicle in front when driving off again within 30 seconds if the system detects that the driver is touching the steering wheel. If a critical situation is detected in the surrounding area when driving off, such as a person in the vehicle path, a visual and acoustic warning indicates that the driver must now take control of the vehicle. The vehicle is not accelerated any further.

Observe the notes on driving systems and your responsibility; you may otherwise fail to recognise dangers (→ page 303).

Display in the driver's display in the Assistance menu

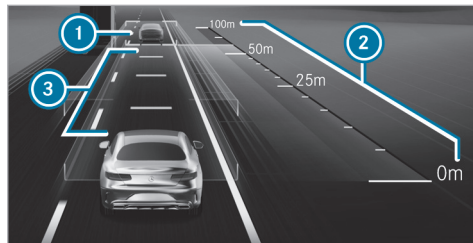

- ① Vehicle in front
- ② Distance indicator
- ③ Set specified distance

The vehicle detected in front ① is highlighted in green. It may also be in the lane to the left of your vehicle in situations where it is not permitted to overtake on the right, for example, on motorways.

Permanent status display



- Grey:** Active Distance Assist DISTRONIC selected but not yet active
- Green speedometer, grey vehicle:** Active Distance Assist DISTRONIC active, speed set
- Green:** Active Distance Assist DISTRONIC active and vehicle detected

The stored speed is shown under the permanent status display and highlighted on the speedometer. Active Distance Assist DISTRONIC's status display is greyed out when passive.

If the speed of the vehicle in front or the speed adjustment is less than the stored speed due to the route event ahead, the segments in the speedometer light up.

The display appears briefly if you increase or decrease the set target distance .

- i** The green vehicle symbol is displayed cyclically when the vehicle is ready to pull away.

-  The system is switched to passive mode if you depress the accelerator pedal beyond the Active Distance Assist DISTRONIC setting. The following message appears briefly in the driver's display  **suspended**.

System limits

The system may be impaired or inoperative in the following situations, for example:



- In snow, rain, fog, heavy spray, if there is glare, in direct sunlight or in greatly varying light conditions.
- The windscreen in the camera's area is dirty, misted, damaged or covered.
- If the radar sensors are dirty or covered.
- In multi-storey car parks or on roads with steep uphill or downhill gradients.
- If there are narrow vehicles in front, such as bicycles or motorcycles.

In addition, on slippery roads, braking or accelerating can cause one or several wheels to lose traction, and the vehicle could then skid.

Do not use Active Distance Assist DISTRONIC in these situations.



 **WARNING** Risk of accident from acceleration or braking by Active Distance Assist DISTRONIC

Active Distance Assist DISTRONIC may accelerate or brake in the following cases, for example:

- If the vehicle pulls away using Active Distance Assist DISTRONIC.
 - If the stored speed is called up and is considerably faster or slower than the currently driven speed.
 - If Active Distance Assist DISTRONIC no longer detects a vehicle in front or does not react to relevant objects.
-  Always carefully observe the traffic conditions and be ready to brake at all times.
-  Take into account the traffic situation before calling up the stored speed.

 **WARNING** Risk of accident due to insufficient deceleration by Active Distance Assist DISTRONIC

Active Distance Assist DISTRONIC brakes your vehicle with up to 50% of the possible deceleration. If this deceleration is not sufficient, Active Distance Assist DISTRONIC alerts you with a visual and acoustic warning.

-  Adjust your speed and maintain a suitable distance from the vehicle in front.
-  Brake the vehicle yourself and/or take evasive action.

 **WARNING** Risk of accident if detection function of Active Distance Assist DISTRONIC is impaired

Active Distance Assist DISTRONIC does not react or has a limited reaction:

- when driving on a different lane or when changing lanes

- to pedestrians, animals, bicycles or stationary vehicles, or unexpected obstacles
- to complex traffic conditions
- to oncoming vehicles and crossing traffic

As a result, Active Distance Assist DISTRONIC may neither give warnings nor intervene in such situations.

- ▶ Always observe the traffic conditions carefully and react accordingly.

You can watch an animation on this topic via the following link:

Operating Active Distance Assist DISTRONIC and the variable limiter

- ⚠ **WARNING** Risk of accident if detection function of Active Distance Assist DISTRONIC is impaired

Active Distance Assist DISTRONIC does not react or has a limited reaction:

- when driving on a different lane or when changing lanes
- to pedestrians, animals, bicycles or stationary vehicles, or unexpected obstacles
- to complex traffic conditions
- to oncoming vehicles and crossing traffic

As a result, Active Distance Assist DISTRONIC may neither give warnings nor intervene in such situations.

- ▶ Always observe the traffic conditions carefully and react accordingly.

- ⚠ **WARNING** Risk of accident from acceleration or braking by Active Distance Assist DISTRONIC

Active Distance Assist DISTRONIC may accelerate or brake in the following cases, for example:

- If the vehicle pulls away using Active Distance Assist DISTRONIC.
- If the stored speed is called up and is considerably faster or slower than the currently driven speed.
- If Active Distance Assist DISTRONIC no longer detects a vehicle in front or does not react to relevant objects.

- ▶ Always carefully observe the traffic conditions and be ready to brake at all times.
- ▶ Take into account the traffic situation before calling up the stored speed.

⚠ WARNING Risk of accident due to insufficient deceleration by Active Distance Assist DISTRONIC

Active Distance Assist DISTRONIC brakes your vehicle with up to 50% of the possible deceleration. If this deceleration is not sufficient, Active Distance Assist DISTRONIC alerts you with a visual and acoustic warning.

- ▶ Adjust your speed and maintain a suitable distance from the vehicle in front.
- ▶ Brake the vehicle yourself and/or take evasive action.

⚠ WARNING Risk of accident due to Active Speed Limit Assist adapting the vehicle's speed

The speed adopted by Active Speed Limit Assist may be too high or incorrect in some individual cases, such as:

- at speed limits below 20 km/h
- in wet conditions or in fog

- when towing a trailer
- ▶ Ensure that the driven speed complies with traffic regulations.
- ▶ Adjust the driving speed to suit current traffic and weather conditions.

Requirements

Active Distance Assist DISTRONIC:

- The electric parking brake is released.
- ESP® is activated and is not intervening.
- The transmission is in position **D**.
- All the doors are closed.
- A check of the radar sensor system has been completed.
- Snow chain mode is not active (→ page 628).

Variable limiter:

- The variable limiter is selected.

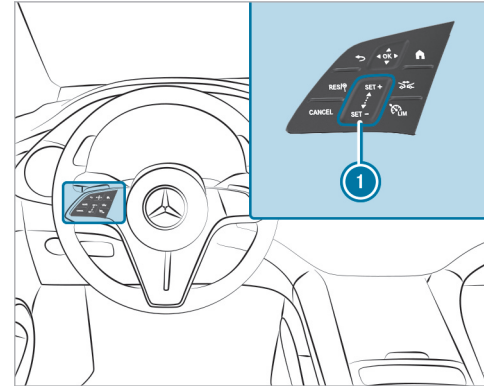



- RES/SET+** Adopts the stored/detected speed
- CANCEL** Deactivates Active Distance Assist DISTRONIC/ the variable limiter
- 1** Increases/decreases the speed
- ↔** Increases/decreases the specified distance
- LM** Switches between the variable limiter and Active Distance Assist DISTRONIC

- ▶ **To operate Active Distance Assist DISTRONIC or the variable limiter:** press the respective button with only one finger or swipe on the control panel.

Switches between the variable limiter and Active Distance Assist DISTRONIC

- ▶ Press .

Activating the variable limiter or Active Distance Assist DISTRONIC



- ▶ **To activate without a stored speed:** press ,  or . **Active Distance Assist DISTRONIC:** remove your foot from the accelerator pedal. The speed currently being driven is stored and maintained by the vehicle using DISTRONIC Active Distance Assist or limited by the variable limiter.

or



- ▶ **To activate with a stored speed:** press . **Active Distance Assist DISTRONIC:** remove your foot from the accelerator pedal. The last stored speed is recalled and held by the vehicle using DISTRONIC Active Distance Assist or limited by the variable limiter. The current vehicle speed is stored if the stored speed has been deleted.

- ⓘ When you switch off the vehicle, the stored speed is deleted. When you activate Active Distance Assist DISTRONIC, the last speed stored for the variable limiter is deleted.



Increasing or reducing the speed

- ▶ To increase the stored speed: swipe upwards from the bottom of the control panel .
 - The stored speed is increased by 1 km/h.
- ▶ To decrease the stored speed: swipe downwards from the top of the control panel .
 - The stored speed is decreased by 1 km/h.



or

- ▶ Briefly press  on the upper section or  on the lower section of the control panel . The stored speed is increased or reduced by 10 km/h.



or

- ▶ Press and hold  on the upper section or  on the lower section of the control panel . The stored speed is increased or reduced in increments of 10 km/h.

or

- ▶ Accelerate the vehicle to the desired speed.
- ▶ Press  on the upper section of the control panel .

Adopting the limit speed shown in the driver's display

- ▶ Activate Active Distance Assist DISTRONIC or the variable limiter: press ,  or .

- ▶ Accept the displayed speed limit: press . The limit speed in the driver's display is adopted as the stored speed. The vehicle adapts its speed to the vehicle in front, but only up to the stored speed, or limits its speed accordingly.

- ⓘ A speed limit shown in the driver display is only adopted while driving, not when stationary.



Pulling away with Active Distance Assist DISTRONIC

- ▶ Activate Active Distance Assist DISTRONIC and remove your foot from the brake pedal.
- ▶ Press .

or

- ▶ Depress the accelerator pedal briefly with force. The functions of the Active Distance Assist DISTRONIC are still active.

Reducing or increasing the specified distance from the vehicle in front

- ▶ Press . The  display appears. The specified distance is reduced by one level. The selection jumps to the highest level if the lowest level is already selected.

Deactivating Active Distance Assist DISTRONIC or the variable limiter

⚠ WARNING Risk of an accident due to Active Distance Assist DISTRONIC being active when you leave the driver's seat

If you leave the driver's seat while the vehicle is being braked by Active Distance Assist DISTRONIC only, the vehicle can roll away.

- ▶ Always deactivate Active Distance Assist DISTRONIC and secure the vehicle to prevent it from rolling away before you leave the driver's seat.

- ▶ Press .

- ⓘ If you brake, deactivate ESP[®], or Active Distance Assist DISTRONIC is deactivated if ESP[®] intervenes. The variable limiter is not deactivated.

Function of Active Speed Limit Assist

If a changed speed limit is detected and the automatic adoption of speed limits is switched on, this is automatically adopted as the stored speed (→ page 329). Speed limits below 20 km/h are not accepted.

The adjustment of the driven speed begins at the latest at the height of the traffic sign. In the case of signs indicating entry into an urban area, the speed is adapted according to the speed permitted within the metropolitan area. The speed limit display in the driver's display is always updated when the vehicle is level with the traffic sign.

If you are driving on German motorways with no speed limit, the system uses the speed stored for a stretch of road with no speed limit as the set speed. If you do not alter the stored speed on a stretch of road with no speed limit, the recommended speed of 130 km/h is adopted.

If Active Distance Assist DISTRONIC has been put into passive mode by pressing the accelerator pedal, only speed limits higher than the set speed are adopted.

The maximum permissible speed does not consider the road condition and current weather and traffic conditions. Adjust your speed accordingly when necessary.

Observe the notes on driving systems and your responsibility; you may otherwise fail to recognise dangers (→ page 303).

System limits

The system limits of Traffic Sign Assist apply to the detection of traffic signs (→ page 345).

Speed limits below 20 km/h are not automatically adopted by the system as the stored speed. Temporary speed restrictions (e.g. for a specific time or due to weather conditions) cannot be appropriately detected by the system.

The system does not detect the maximum permissible speed for a vehicle with a trailer.

Adjust the speed in these situations.

⚠ WARNING Risk of accident due to Active Speed Limit Assist adapting the vehicle's speed

The speed adopted by Active Speed Limit Assist may be too high or incorrect in some individual cases, such as:

- at speed limits below 20 km/h
- in wet conditions or in fog
- when towing a trailer

▶ Ensure that the driven speed complies with traffic regulations.

▶ Adjust the driving speed to suit current traffic and weather conditions.

Function of route-based speed adaptation

When Active Distance Assist DISTRONIC is activated, the vehicle speed will be adapted accordingly to the route events ahead. Depending on the drive program selected, the vehicle negotiates a route event ahead in an energy-saving, comfortable or dynamic manner. When the route event has been passed, the vehicle accelerates again to the stored speed. The set distance to the vehicle in

front, vehicles detected ahead and speed restrictions ahead are taken into account.

Route-based speed adaptation can be activated in the multimedia system (→ page 329).

The following route events are taken into account:

- Bends
- Roundabouts
- T-junctions
- Turns and exits
- Traffic jams ahead (only with Live Traffic (→ page 506))

Also, the speed is reduced if the turn signal indicator is switched on and one of the following situations is detected:

- Turning at junctions
- Driving on slowing-down lanes
- Driving on lanes adjacent to slowing-down lanes

The driver is responsible for choosing the right speed and observing other road users. This applies in particular to junctions, roundabouts and

traffic lights, as route-based speed adaptation does not brake the vehicle to a standstill.

Speed adaptation is cancelled in the following cases:

- If the turn signal indicator is switched off before the route event and it is therefore assumed that the route event is not relevant to the driver.
- If the driver depresses the accelerator or brake pedal during the process.

System limits

Route-based speed adaptation does not take right of way regulations into account. The driver is responsible for complying with road traffic regulations and driving at a suitable speed.

In difficult conditions, the speed selection made by the system may not always be suitable. This applies to the following situations, foreexample:

- the road's course not clearly visible
- Road narrowing
- varying maximum permissible speeds in individual lanes, foreexample at toll stations
- wet road surfaces, snow or ice

- If transport equipment, foreexample a trailer or bicycle rack, is attached to the trailer hitch and the electrical connection has been correctly established.

In these situations the driver must intervene accordingly.

WARNING Risk of accident in spite of route-based speed adaptation

Route-based speed adaptation can malfunction or be temporarily unavailable in the following situations:

- If the driver does not follow the calculated route
- If map data is not up-to-date or available
- In the event of roadworks
- In bad weather or road conditions
- If the accelerator pedal is depressed
- In the event of electronically displayed speed limitations

 Adapt the speed to the traffic situation.

■ Setting Active Distance Assist DISTRONIC driving styles

Requirements

- Active Distance Assist DISTRONIC is activated.

Multimedia system:

  **» Settings » Assistance**
» Driving » Active Distance Assist

Selecting a driving style

 Select **Based on DYNAMIC SELECT**, **Dynamic** or **Comfortable**.

 Further information about Active Distance Assist DISTRONIC (→ page 324).

Setting speed adaptation

 Select **Adopt speed limit** or **Route-based speed adjustment**.

When these functions are active, the vehicle speed is adjusted depending on the route events ahead.

- ❗ When one of the following systems is active, the detected speed can be manually adopted as the speed limit:
 - Active Distance Assist DISTRONIC
 - Variable limiter
- ❗ Further information on Speed Adjustment (→ page 328).

■ Function of Active Stop-and-Go Assist

Active Stop-and-Go Assist helps you in traffic jams on multi-lane roads with separate carriage-ways by automatically pulling away within up to 60 seconds and with moderate steering manoeuvres. It orients itself using the vehicle in front and lane markings. Active Stop-and-Go Assist automatically maintains a safe distance from the vehicle in front and vehicles cutting in.

Active Stop-and-Go Assist requires you, as the driver, to keep your hands on the steering wheel at all times so that you can intervene at any time to correct the course of the vehicle and keep it in the lane.

Observe the notes on driving systems and your responsibility; you may otherwise fail to recognise dangers (→ page 303).

If all of the following conditions are met, Active Stop-and-Go Assist activates automatically:

- You are in a traffic jam on a motorway or major high-speed road.
- Active Distance Assist DISTRONIC is activated and active (→ page 324).
- Active Steering Assist is activated and active (→ page 332).
- You are travelling no faster than 60 km/h.

When Active Stop-and-Go Assist is active, the  status display appears in the driver's display.

System limits

The system limitations of Active Distance Assist DISTRONIC and Active Steering Assist apply to Active Stop-and-Go Assist (→ page 330).

Active Steering Assist

■ Function of Active Steering Assist

Active Steering Assist is only available up to a speed of 210 km/h. The system helps you stay in the centre of the lane by using moderate steering interventions. Active Steering Assist uses the vehicles ahead and lane markings as a reference depending on the speed driven.

- ❗ Depending on the country, Active Steering Assist can use the surrounding traffic in the lower speed range as a reference. Active Steering Assist can also assist the centre of the lane if necessary.

If the detection of lane markings and vehicles ahead is impaired, Active Steering Assist switches to passive mode. The system provides no support in this case.

Permanent status display in the driver's display





Grey: activated and passive



Green: activated and active



Red, flashing: prompt the driver to confirm or transition from active to passive status actively, system limit detected

① The  symbol is enlarged and flashing during the transition from active to inactive status. Once the system is passive, the  symbol is shown as grey in the driver's display.

Contact detection

The driver is required to keep their hands on the steering wheel at all times and be able to intervene at any time to correct the course of the vehicle and keep it in the lane. The driver must expect a change from active to passive mode or vice versa.



If the system detects that the driver has not steered the vehicle for a considerable time or

removed their hands from the steering wheel, an optical warning is given first. Display ① appears in the driver's display. If the driver still does not steer the vehicle or gives no confirmation to the system, a warning tone sounds in addition to the visual warning message.

An emergency stop is initiated if the driver does not react to this warning for a considerable period (→ page 332).

The warning is not issued or is stopped as soon as the system detects that the driver has touched the steering wheel.

The touch detection may be limited or without function if there is no direct contact between the hand and the steering wheel, e.g. when wearing gloves or if there is a steering wheel cover on the steering wheel.

If Active Steering Assist detects that a system limit has been reached, a visual warning is issued, and a warning tone sounds.

Observe the notes on driving systems and your responsibility; you may otherwise fail to recognise dangers (→ page 303).

System limits

Active Steering Assist has a limited steering torque for lateral guidance. In some cases, the steering intervention is insufficient to keep the vehicle in the lane.

The system may be impaired or may not function in the following instances:

- There is poor visibility, e.g. due to snow, rain, fog, heavy spray, greatly varying light conditions or strong shadows on the carriageway.
- There is glare, e.g. from oncoming traffic, direct sunlight or reflections.
- Insufficient road illumination.
- The windscreen is dirty, misted up, damaged or covered in the vicinity of the camera, e.g. by a sticker.
- No, or several unclear lane markings are present for one lane, or the markings change quickly, for example, in a construction area or junctions.
- The lane markings are worn away, dark or covered up, e.g. by dirt or snow.

- If the distance to the vehicle in front is too short and thus the lane markings cannot be detected.
- The road is narrow and winding.
- There are obstacles on the lane or projecting out into the lane, such as object markers.
- If transport equipment, for example, a trailer or bicycle rack, is attached to the trailer hitch and the electrical connection has been correctly established.

The system does not assist in the following conditions:

- On very tight bends and when turning.
- When crossing junctions.
- At roundabouts or toll stations.
- When actively changing lanes without switching on the turn signal indicator.
- When the tyre pressure is too low.

⚠ WARNING Risk of accident if Active Steering Assist unexpectedly stops functioning

If the system limits of Active Steering Assist are reached there is no guarantee that the system will remain active or will keep the vehicle in lane.

- ▶ Always keep your hands on the steering wheel and observe the traffic carefully.
- ▶ Always steer the vehicle paying attention to traffic conditions.

⚠ WARNING Risk of accident if Active Steering Assist unexpectedly intervenes

The detection of lane markings and objects may malfunction and cause unexpected steering interventions.

- ▶ Steer according to traffic conditions.

You can watch an animation on this topic via the following link:

■ [Activating/deactivating Active Steering Assist](#)

Requirements

- ESP® is activated, but is not intervening.
- Active Distance Assist DISTRONIC is activated.

Multimedia system:

  [▶▶ Settings ▶▶ Assistance](#)
[▶▶ Driving](#)

 Activate or deactivate [Active Steering Assist](#).

[Function of Active Emergency Stop Assist](#)

Active Emergency Stop Assist monitors the steering wheel, accelerator, and brake pedals. If the system detects a lack of driver activity and the vehicle threatens to leave the lane, a warning can be issued, and an emergency stop initiated.

Vehicles without Driving Assistance Package: The system is available from a speed of approx. 60 km/h.

Vehicles with Driving Assistance package: If Active Steering Assist is switched off, the system is available from a speed of approx. 60 km/h.

If the system detects the vehicle threatening to leave the lane, a warning can be issued, and an emergency stop initiated.

- The driver does not touch the steering wheel for a longer period, or no steering movement can be measured for longer (depending on the vehicle equipment).
- Neither the accelerator nor the brake pedal is depressed.

- i Vehicles with Driving Assistance package:** if Active Steering Assist is switched on and active, the system only monitors the steering wheel. If the driver does not touch the steering wheel for longer, a warning may be given despite pedal actuation. Also, observe the instructions on the contact detection of Active Steering Assist (→ page 330).



Active Emergency Stop Assist issues the following warnings in order:

- Display message **1** appears in the driver's display.
- In addition to displaying **1**, a warning tone sounds.
- The message **Beginning emergency stop** will appear on the driver's display. A continuous warning tone will sound, the vehicle will no longer accelerate, and, if necessary, slight belt tensioning will be produced.
- The vehicle speed is reduced in increments until it is at a standstill. Sharp brake impulses are also produced.

- i Vehicles with Driving Assistance Package:** If Active Distance Assist DISTRONIC is active and the driver unfastens the seat belt and driver's door, an emergency stop can be initiated immediately.

Vehicles with Driving Assistance Package:

Depending on the country, a lane change is made to the adjacent lane if possible. It is possible to change lanes across one lane and only to the outside lane, not to the hard shoulder.

When automatic braking is initiated, Active Distance Assist DISTRONIC is deactivated. Depending on the country, the hazard warning light system is switched on.

When the vehicle is stationary, the following actions are carried out:

- The vehicle is secured with the electric parking brake.
- The vehicle is unlocked.
- If possible, an emergency call is placed to the Mercedes-Benz emergency call centre.

Before automatic braking is initiated, you can cancel Active Emergency Stop Assist by steering.

You can cancel the intervention by Active Emergency Stop Assist after automatic braking is initiated by one of the following actions:

- Accelerating or braking: the emergency stop is cancelled, but the warning message, warning tone and power steering remain active
- Steering: power-assisted steering is cancelled, the warning message and warning tone remain active, and the vehicle continues to be braked

i Active Emergency Stop Assist can initiate an emergency stop a maximum of three times within a driving cycle. After that, Active Steering Assist and Active Emergency Stop Assist are disabled until the vehicle has been restarted.

System limits

For the detection of vehicles and other obstacles, observe the system limits of the following functions:

- Active Distance Assist DISTRONIC (→ page 321)
- Active Steering Assist (→ page 330)
- Active Lane Change Assist (→ page 334)

- Active Brake Assist (→ page 336)

Vehicles without Driving Assistance Package:

Active Emergency Stop Assist is inactive in the following cases:

- Active Lane Keeping Assist has reached a system limit.
- Active Lane Keeping Assist is not operational (grey status display) or deactivated (white status display) (→ page 354).

Active Lane Change Assist

■ Function of Active Lane Change Assist

Active Lane Change Assist supports the driver when changing lanes and is activated by indicating briefly.

The following conditions must be met:

- You are driving on a motorway or motorway-like road.
- The speed travelled ranges from about 80 km/h to 180 km/h.
- A dashed boundary marking separates the adjacent lane.

- No vehicle or obstacle is detected in the adjacent lane.
- The sensors have detected a vehicle with sufficient distance behind the own vehicle once since the last vehicle started.
- Active Lane Change Assist is selected in the multimedia system.
- Active Distance Assist DISTRONIC and Active Steering Assist are activated on the motorway.

In the following cases, the system is not available and must be reactivated:

- The Active Distance Assist DISTRONIC and the Active Steering Assist were already activated before the vehicle entered the motorway.
- The system briefly no longer recognises the road being travelled on as a motorway or motorway-like road, e.g. at a motorway junction.

As soon as Active Lane Change Assist detects a suitable road, you can reactivate it with the buttons **RES**, **SET/+** or **SET/-**.

Display in the driver's display in the Assistance menu

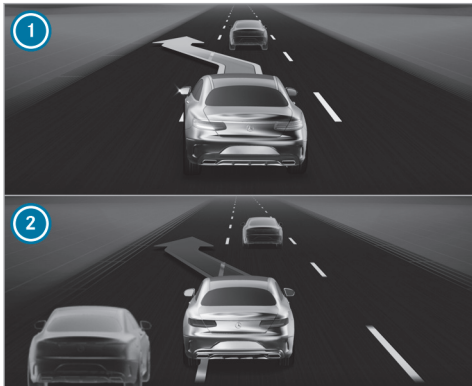

- ① Green arrow: lane change initiated
- ② Red arrow: Lane change aborted

If Active Lane Change Assist is available, the indicator  with green arrows appears in the driver display. If the system has been activated

but is not currently available, the display  with grey arrows appears in the driver's display.

If no vehicle or obstacle is detected in the adjacent lane and a lane change is permitted, the lane change begins after the driver flashes briefly. The lane change is indicated to the driver by a green flashing arrow next to the steering wheel symbol . A green arrow **Assistance** to the respective neighbouring lane is shown in the menu ① in the driver's display. The message, for example, also appears **Lane change to the left**.

Active Lane Change Assist can be cancelled in the following situations, among others:

- The environmental conditions change (e.g. obstacle detected).
- The driver takes his hands off the steering wheel.
- The driver steers too hard or in the opposite direction.
- The driver switches on the direction indicator in the opposite direction.
- Active Distance Assist DISTRONIC or Active Steering Assist are deactivated.

- The lane change cannot be driven by the vehicle as planned.

A cancellation of Active Lane Change Assist is displayed as follows:

- The arrow in the selected direction of travel turns red.
- A corresponding message appears in the driver's display.
- In certain circumstances a warning tone sounds.

⚠ WARNING Risk of accident when changing lane to an occupied adjacent lane

Lane Change Assist cannot always clearly detect if the adjacent lane is free.

The lane change might be initiated although the adjacent lane is not free.

- ▶ Before changing lanes, make sure that the neighbouring lane is free and there is no danger to other road users.
- ▶ Monitor the lane change.

⚠ WARNING Risk of accident if Lane Change Assist unexpectedly stops functioning

If the system limitations for Lane Change Assist have been reached, there is no guarantee that the system will remain active.

Lane Change Assist cannot then assist you by applying steering torque.

- ▶ Always monitor the lane change and keep your hands on the steering wheel. Observe the traffic conditions and steer and/or brake if necessary.

System limits

For Active Lane Change Assist, the system limits of Active Steering Assist (→ page 330) apply.

In addition, the system may be impaired or without function in the following situations:

- The sensors are damaged, covered or dirty (→ page 304).
- The exterior lighting indicates a defect.
- The system does not recognise a suitable road, e.g. in narrow bends or shortly after an on-ramp.

- The vehicle is on a construction site.

- ⓘ The Active Lane Change Assist sensors adjust automatically while a certain distance is being driven after the vehicle has been delivered. Active Lane Change Assist is unavailable or only partially available during this teach-in process, and no arrows are displayed next to the  Active Steering Assist symbol.

Observe the notes on driving systems and your responsibility; you may otherwise fail to recognise dangers (→ page 303).

Setting Active Lane Change Assist

Multimedia system:

→  » Settings » Assistance
» Driving » Active Lane Change Assist

- ▶ Select **Active Lane Change Assist**.
- ▶ Select between the **On** or **Off** setting options.
- ⓘ If **Active Steering Assist** has been deactivated, **Active Lane Change Assist** cannot be operated.

Active Brake Assist

Function of Active Brake Assist

Active Brake Assist consists of the following functions:

- Distance warning function
- Collision warning
- Autonomous braking function
- Situation-dependent brake force boosting
- **Vehicles with Driving Assistance Package and Active Steering Assist:** Evasive Steering Assist
- **Vehicles with Driving Assistance Package:** Evasive Steering Assist
- **Vehicles with Driving Assistance Package:** intersection start-off function

Active Brake Assist can help you to minimise the risk of a collision with vehicles, cyclists or pedestrians or to reduce the effects of such a collision.

If Active Brake Assist has detected a risk of collision, a warning tone sounds and the  distance warning lamp lights up.

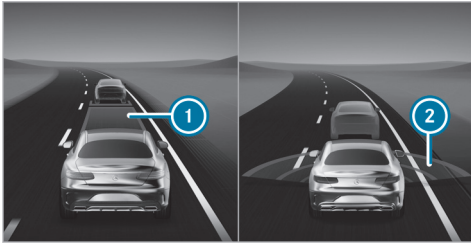

In the **Assistance** menu, an insufficient distance ① to the vehicle in front is displayed in red. If you further reduce the distance, the vehicle in front is also highlighted in red. When the system detects a risk of collision, red radar waves ② appear in front of the vehicle.

- ① **Vehicles with PRE-SAFE®:** depending on the country, an additional haptic warning occurs in the form of slight, repeated tensioning of the seat belt.
- ② **Vehicles with active ambient lighting:** if **Warning assistance** is activated, the Active Brake Assist warning is also accompanied by ambient lighting (→ page 224).

If you do not react to the warning, autonomous braking can be initiated in critical situations.

In particularly critical situations, Active Brake Assist can also initiate autonomous braking directly. In this case, the warning tone sounds and the  distance warning lamp lights up simultaneously with the brake application.

If you apply the brake yourself in a critical situation or apply the brake during autonomous braking, situation-dependent brake force boosting occurs. The brake pressure increases up to maximum full-stop braking if necessary.



If autonomous braking or situation-dependent brake force boosting has occurred, pop up ①

appears in the driver's display and then automatically goes out after a short time.

If the autonomous braking function or situation-dependent brake force boosting is triggered, additional preventive measures for occupant protection (PRE-SAFE®) may also be initiated.

⚠ WARNING Risk of an accident caused by limited detection performance of Active Brake Assist

Active Brake Assist cannot always clearly identify objects and complex traffic situations.

In such cases, Active Brake Assist might:

- Give a warning or brake without reason
- Not give a warning or not brake

Active Brake Assist is only an aid. The driver is responsible for maintaining a sufficiently safe distance to the vehicle in front, vehicle speed and for braking in good time.

▶ Always pay careful attention to the traffic situation; do not rely on Active Brake Assist alone.

- ▶ Be prepared to brake or swerve if necessary.

If Active Brake Assist is deactivated or the functions are restricted, e.g. due to activation of another driving system, the  Active Brake Assist warning lamp appears in the driver's display.

If the system is unavailable due to dirty or damaged sensors or due to a fault, or if the functions are restricted, the  Active Brake Assist warning lamp appears in the driver's display.

Also observe the system limits of Active Brake Assist.

The individual subfunctions are available in the following speed ranges:

Distance warning function

You are warned by the distance warning function from approximately 30 km/h if, over several seconds, the distance maintained to the vehicle travelling in front is insufficient for the driven speed. In this case, the  distance warning lamp in the driver's display lights up. If the distance to the vehicle in front continues to decrease at higher

speeds, the  distance warning lamp begins to flash.

Collision warning

The collision warning can assist you in the following situations from approximately 7 km/h with an intermittent warning tone and the  distance warning lamp.

Vehicles without Driving Assistance Package:

- at speeds up to approximately 250 km/h when approaching vehicles ahead
- at speeds up to approximately 80 km/h when approaching stationary vehicles, pedestrians walking in the direction of travel and cyclists ahead
- at speeds up to approximately 70 km/h when approaching crossing pedestrians and cyclists
- at speeds up to approximately 60 km/h when approaching stationary pedestrians and cyclists

Vehicles with Driving Assistance Package:

- at speeds up to approximately 250 km/h when approaching vehicles ahead

- at speeds up to approximately 120 km/h when approaching crossing vehicles, pedestrians and cyclists
- at speeds up to approximately 100 km/h when approaching stationary vehicles
- at speeds up to approximately 80 km/h when approaching cyclists ahead
- at speeds up to approximately 70 km/h when approaching stationary pedestrians and cyclists

Autonomous braking function

If the vehicle is travelling at speeds above approximately 7 km/h, the autonomous braking function may intervene in the following situations:

Vehicles without Driving Assistance Package:

- at speeds up to approximately 250 km/h when approaching vehicles ahead
- at speeds up to approximately 80 km/h when approaching cyclists ahead, pedestrians walking in the direction of travel and stationary vehicles
- at speeds up to approximately 70 km/h when approaching crossing pedestrians and cyclists

Vehicles with Driving Assistance Package:

- at speeds up to approximately 250 km/h when approaching vehicles ahead
- at speeds up to approximately 120 km/h when approaching crossing vehicles, pedestrians and cyclists
- at speeds up to approximately 100 km/h when approaching stationary vehicles
- at speeds up to approximately 80 km/h when approaching cyclists ahead
- at speeds up to approximately 70 km/h when approaching stationary pedestrians and cyclists

Situation-dependent brake force boosting

If the vehicle is travelling at speeds above approximately 7 km/h, situation-dependent brake force boosting may intervene in the following situations.

Vehicles without Driving Assistance Package:

- at speeds up to approximately 250 km/h when approaching vehicles ahead
- at speeds up to approximately 80 km/h when approaching cyclists ahead, pedestrians walk-

ing in the direction of travel and stationary vehicles

- at speeds up to approximately 70 km/h when approaching crossing pedestrians and cyclists
- at speeds up to approximately 60 km/h when approaching stationary pedestrians and cyclists

Vehicles with Driving Assistance Package:

- at speeds up to approximately 250 km/h when approaching vehicles ahead
- at speeds up to approximately 120 km/h when approaching crossing vehicles, pedestrians and cyclists
- at speeds up to approximately 100 km/h when approaching stationary vehicles
- at speeds up to approximately 80 km/h when approaching cyclists ahead
- at speeds up to approximately 70 km/h when approaching stationary pedestrians and cyclists

Cancelling a brake application of Active Brake Assist

You can cancel a brake application of Active Brake Assist at any time by:

- Fully depressing the accelerator pedal or with kickdown.
- Releasing the brake pedal.

Active Brake Assist may cancel the brake application when one of the following conditions is fulfilled:

- you manoeuvre to avoid the obstacle
- there is no longer a risk of collision
- an obstacle is no longer detected in front of your vehicle

Reaction to oncoming road users (only vehicles with Driving Assistance Package)

Active Brake Assist can also react to detected oncoming road users:

- Reaction up to speeds of approximately 100 km/h

- Warning for oncoming road users through acoustic warning and the  distance warning lamp
- Autonomous braking application in order to reduce the severity of an accident

Intersection start-off function (only vehicles with Driving Assistance Package)

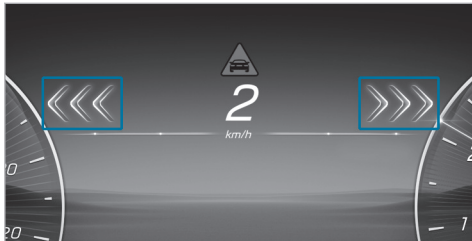

If, when pulling away or driving at a walking pace, the risk of collision with other crossing vehicles is detected, three red arrows pointing in the direction of the crossing road user light up one by one along with the  distance warning lamp in the driver's display. If the situation is particularly critical, the arrows flash. A warning tone will also

sound. If you do not react to the warning in critical situations, acceleration may be restricted or autonomous braking may be initiated. Autonomous braking can also prevent the vehicle from pulling away and hold it at a standstill. In particularly critical situations, Active Brake Assist can also initiate autonomous braking directly. In this case, the  distance warning lamp lights up and the warning tone sounds simultaneously with the brake application.

If autonomous braking or situation-dependent brake force boosting has occurred, a pop up appears in the driver's display and then automatically goes out after a short time.

In the **Late** setting of Active Brake Assist, the purely visual warning level and the limitation of possible acceleration is deactivated. If the situation is particularly critical, a visual warning may continue to be displayed, a warning tone may sound and autonomous braking may be initiated.

Evasive Steering Assist

 **WARNING** Risk of accident despite Evasive Steering Assist

Evasive Steering Assist cannot always recognise objects or complex traffic situations clearly.

Moreover, the steering support provided by Evasive Steering Assist is not sufficient to avoid a collision.

- ▶ Always pay careful attention to the traffic situation; do not rely on Evasive Steering Assist alone.
- ▶ Be prepared to brake or swerve if necessary.
- ▶ End the support by actively steering in non-critical situations.
- ▶ Drive at an appropriate speed if there are pedestrians close to the path of your vehicle.

Evasive Steering Assist has the following characteristics:

- Detection of pedestrians, cyclists and vehicles.
- Assistance through power-assisted steering if it detects a swerving manoeuvre.
- Activation by an abrupt steering movement during a swerving manoeuvre.
- Assistance during swerving and straightening of the vehicle.
- Reaction from a speed of approximately 20 km/h up to a speed of approximately 110 km/h.

The steering support of Evasive Steering Assist can be cancelled at any time by counter steering.

System limits

Full system performance is not available for a short time after switching on the vehicle or after driving off. As long as the functions are restricted, the  Active Brake Assist warning lamp can also be shown in the driver's display. Depending on the environmental conditions, it may take a

few minutes before full system performance is available.

The system may be impaired or may not function, particularly in the following situations:

- In snow, rain, fog, heavy spray, if there is glare, in direct sunlight or in greatly varying light conditions.
- If the sensors are dirty, misted up, damaged or covered. (→ page 304)
- If the sensors are impaired due to interference from other radar sources, e.g. strong radar reflections in multi-storey car parks.
- If a loss of tyre pressure or a defective tyre has been detected and displayed.
- In complex traffic situations where objects cannot always be clearly identified.
- If pedestrians, cyclists or vehicles move quickly into the sensor detection range.
- If road users are hidden by other objects or are located close to other objects.
- If the typical outline of a pedestrian or cyclist cannot be distinguished from the background.

- If a pedestrian or cyclist is not detected as such, e.g. due to special clothing or other objects.
- If the driver's seat belt is not fastened.
- On bends with a tight radius.

Setting Active Brake Assist

Requirements

- The vehicle is switched on.



Multimedia system:

  **» Settings** **» Assistance**
» Collision avoidance

 Activate or deactivate the function.

 It is recommended that you always leave Active Brake Assist activated.

When Active Brake Assist is deactivated, the distance warning function, the collision warning, the autonomous braking function and Evasive Steering Assist are deactivated.

 If Active Brake Assist is deactivated, the  symbol appears in the status bar of the driver's display, and the system is reactivated the next time the vehicle is started.

Setting the time of the warnings

- ▶ Select  next to **Active Brake Assist**.
 - ▶ Select **Early**, **Medium** or **Late**.
- i** If ATTENTION ASSIST has detected indications of fatigue or a microsleep, the system can issue a warning earlier than the set time (country-dependent). Further information about ATTENTION ASSIST (→ page 315).

Speed Limit Assist

Function of the Speed Limit Assistant

- i** The Speed Limit Assistant uses Open Street Map data provided under the Open Database Licence (ODbL) terms. For more information, see: <https://www.osmfoundation.org/wiki/licence>.

Speed Limit Assist detects speed limits with the multifunction camera and displays them in the driver's display and optionally in the head-up display. The camera also detects speed limits with a restriction indicated by an additional sign (e.g. when wet).

Observe the notes on driving systems and your responsibility; you may otherwise fail to recognise dangers (→ page 303).

Notes on trailer operation

- i** Also, observe the notes on towing a trailer (→ page 393).

If a trailer or bicycle carrier is connected correctly, the central display shows the query about the type of trailer and its maximum permitted speed (→ page 398).

The driver must manually adjust the maximum permitted speed in the **small or large trailer** category.

In particular, the country-specific laws must be taken into account, e.g. on:

- maximum design speed or speed limit for which the vehicle is approved
- maximum permissible laden mass with or without towing vehicle
- required number of years with a corresponding driving licence
- Type and condition of the road used

- the weather conditions

The maximum permissible speed adapted to the vehicle/trailer combination can be transferred to the manual or automatic speed transfer during the journey (depending on the equipment).

On the system side, relevant additional signs for speed limits and clear road category traffic rules can be considered for the vehicle combination (depending on the country).

The multimedia system can select no maximum permitted speed for a bicycle carrier. When using a bicycle carrier, observe the specifications for the maximum permissible speed in the manufacturer's operating instructions.

Warning when the maximum permissible speed is exceeded

The system can warn you if you unintentionally exceed the maximum permissible speed. Depending on the country, you can set how much the maximum permitted speed may be exceeded in the multimedia system before giving a warning. You can set whether the warning should be visual (by flashing the traffic sign in the driver display) or visual and audible. The selection of the type of

warning is confirmed country-specifically by an indication in the driver display.

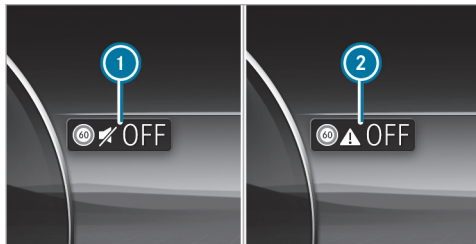

- ① Warning only visual
- ② WARNING off
- ③ The type, duration and activation threshold of the speed warning, as well as the possibility of setting the activation threshold above which the warning is to be triggered, are subject to the country-specific legislation of the country of delivery of the vehicle.

Indication in the driver display

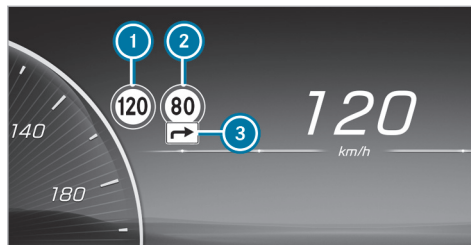

- ① Permissible speed
- ② Permissible speed when there is a restriction
- ③ Additional sign with restriction
- ④ Traffic signs that affect the maximum permitted speed, e.g. indicating the beginning or end of motorways can also be detected.

The system can simultaneously show up to two traffic signs on the driver's display. The system always prioritises displaying speed limits. The head-up display shows up to one traffic sign with a maximum permissible speed. Suppose two-speed signs are shown in the driver's display,

forexample, when speed limits are detected. In that case, the left-hand speed limit ① value is transmitted to the limiter, cruise control or Active Distance Assist DISTRONIC for adoption and is shown in the head-up display.

If the speed limit assistant cannot determine the currently permissible maximum speed, e.g. due to missing signage, the following display appears in the driver display:



This display is permanent if the vehicle is in a country where Speed Limit Assist is not supported. Speed Limit Assist is not available in all countries.

If the system is temporarily or permanently unavailable due to a technical fault or soiling of the windscreen, a corresponding display message appears in the driver display. Depending on the country, the Speed Limit Assist warning light  also lights up in the driver display.

 Please also note the information on the display messages (→ page 770).

System limits

The system may be impaired or may not function, particularly in the following situations:

- If visibility is poor, e.g. due to insufficient illumination of the road, highly variable shade conditions, rain, snow, fog, swirling dust or heavy spray.
- If there is glare, e.g. from oncoming traffic, direct sunlight or reflections.
- If there is dirt on the windscreen in the vicinity of the multifunction camera or if the camera is misted up, damaged or obscured.
- If the traffic signs are difficult to see because, for example, they are dirty, obscured, faded, iced over, damaged, inconveniently positioned, insufficiently illuminated or distorted.
- Active traffic signs with LED displays may not be detected correctly or at all due to technical factors, such as transmission frequency.
- If the signs, road markings or road layout are ambiguous, e.g. in the case of traffic signs on

construction sites, at exits and driveways, in the case of adjacent lanes or parallel roads, in the case of pedestrian crossing markings at traffic lights



- If the signage or road markings do not comply with the standard
- If the signage, road markings, or road guidance is country-specific and deviates from the navigation system's route guidance, e.g. in or after road works
- after sharp turns and tight bends, traffic signs are outside the camera's field of vision.
- If you overtake vehicles with traffic signs affixed or attached to them.
- If transport devices are used that are attached to the trailer hitch, e.g. bicycle racks, the system may react to restrictions for trailers.

Setting Speed Limit Assist

Multimedia system:

  **» Settings** **» Assistance**
» Assistance **» Speed Limit Assist**

Activating or deactivating the speed warning

-  The speed warning is switched on by default (depending on the country).
-  Switch off **Speed limit warning**.
The speed warning remains off according to country-specific legislation until the next time the vehicle is switched on or off and (depending on the equipment) the driver's door is opened.
-  The audible speed warning can also be switched off and on by quick access, by pressing and holding the mute button on the steering wheel, by pressing the speed icon in the status line of the central display or via a voice control command (functions are available depending on the country).

Change the type of speed warning

-  Change the warning to **Visual** or **Visual & audible**.

Switching the advisory tone for a new speed limit on or off

- ❗ The advisory tone for a new speed limit is switched off at the factory.

The function determines whether each change of the displayed speed in the driver's display is supported with a subtle, non-intrusive sound.

- ▶ Activate or deactivate the function.
- ❗ The availability of the function is dependent on the country.

Setting the warning threshold

This value determines the speed at which a warning is issued when exceeded.

- ▶ Set the desired speed under Warning Threshold.

The availability of the function is subject to country-specific legislation.

When one of the following systems is active, the detected speed can be manually adopted as the speed limit:

- Active Distance Assist DISTRONIC
- Cruise control

- Variable limiter
- ❗ Further information about Active Distance Assist DISTRONIC (→ page 324).

Traffic Sign Assist

Function of Traffic Sign Assist

Traffic Sign Assist detects the traffic signs with the multifunction camera and compares them with the information on the digital road map of the navigation system. It supports you by showing detected speed limits and overtaking bans in the driver's display. Speed limits can also be shown in the head-up display.

The system can issue a warning when you exceed the maximum permissible speed.

In some countries, the system can provide you with further functions and can warn you when you are approaching pedestrian crossings or when you are about to drive past stop signs or red lights unintentionally.

The camera also detects and analyses traffic signs with a restriction indicated by an additional sign (e.g. when wet).

Traffic Sign Assist portrays only selected signs in the driver's display. Actual traffic signs and speed limits have priority over traffic signs and speed limits shown in the driver's display.

Notes on trailer operation

- ❗ Also, observe the notes on towing a trailer (→ page 393).

If a trailer or bicycle carrier is connected correctly, the central display shows the query about the type of trailer and its maximum permitted speed (→ page 398).

The driver must manually adjust the maximum permitted speed in the **small or large trailer** category.

In particular, the country-specific laws must be taken into account, e.g. on:

- maximum design speed or speed limit for which the vehicle is approved
- maximum permissible laden mass with or without towing vehicle
- required number of years with a corresponding driving licence
- Type and condition of the road used

- the weather conditions

The maximum permissible speed adapted to the vehicle/trailer combination can be transferred to the manual or automatic speed transfer during the journey (depending on the equipment).

On the system side, relevant additional signs for speed limits and clear road category traffic rules can be considered for the vehicle combination (depending on the country).

The multimedia system can select no maximum permitted speed for a bicycle carrier. When using a bicycle carrier, observe the specifications for the maximum permissible speed in the manufacturer's operating instructions.

Also, observe the following information:

- Select a speed adapted to the traffic, surroundings and weather conditions
- Observe actual traffic signs
- Observe applicable traffic rules and regulations

Observe the notes on driving systems and your responsibility; you may otherwise fail to recognise dangers (→ page 303).

Displays in the driver's display

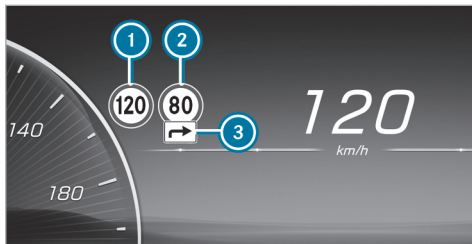

- 1 Permissible speed
- 2 Permissible speed when there is a restriction
- 3 Additional sign with restriction

The system can simultaneously show up to two traffic signs on the driver's display. The system always prioritises displaying speed limits. The head-up display shows up to one traffic sign with a maximum permissible speed. If two-speed signs are shown in the driver's display, for example, when speed limits are detected, the value of the left-hand speed limit 1 is transmitted to the limiter, cruise control or Active Distance Assist

DISTRONIC for adoption and is shown in the head-up display.

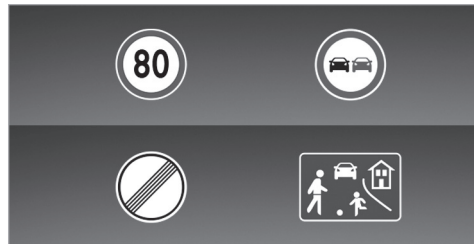

Examples of traffic signs which can be displayed

Traffic Sign Assist can detect and display following traffic signs 1:

- speed limits
- end of the speed limit
- overtaking restrictions
- play streets
- depending on the country: signs showing the start or end of motorways and dual carriageways

Traffic Sign Assist can detect following additional signs ③ and, if necessary, analyse the relevance of the restrictions using other vehicle sensors:

- when wet
- slippery road surfaces
- in fog
- temporary restrictions
- exits
- restrictions for car/trailer combinations

Traffic Sign Assist also uses data from the digital street map in the navigation system. When you leave or enter a municipality or change roads, on a motorway exit or slip road for example, or after you turn at a junction, the display in the driver's display can thus be updated without a traffic sign having been detected.

- ① Regularly update the digital road map of the navigation system so that the traffic sign assistant can work optimally (→ page 29).

Depending on vehicle equipment and country, the system can also display speed restrictions ahead in the driver and head-up displays. The driver's display can also show the distance to an upcoming

lower limit speed. For this purpose, information from the digital road map of the navigation system is used. The Assistance menu can also display a dynamic visualisation of the speed limits ahead.

If Traffic Sign Assist cannot determine the currently applicable maximum permissible speed (e.g. due to missing signs), the following display appears in the driver's display:



Traffic Sign Assist is not available in all countries. This is displayed continuously if the vehicle is in a country where Traffic Sign Assist is not supported. If Traffic Sign Assist is temporarily or permanently unavailable due to a technical fault or soiling of the windscreen, the warning light  appears on the driver display.

- ① Please also note the information on the display messages of the traffic sign assistant (→ page 770).

Warning when the maximum permissible speed is exceeded

The system can warn you if you unintentionally exceed the maximum permissible speed. Depending on the country, you can set how much the maximum permitted speed may be exceeded in the multimedia system before giving a warning. You can switch off the warning or set whether the warning should be visual (by flashing the traffic sign in the driver display) or visual and audible. The selected setting is confirmed by an indication in the driver's display.

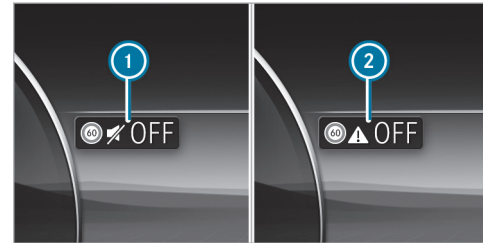

- ① Warning only visual
- ② WARNING off

i The type, duration and activation threshold of the speed warning, as well as the possibility of setting the triggering threshold above which the warning is to be triggered, are subject to the country-specific legislation of the country of delivery of the vehicle.

Additional functions of Traffic Sign Assist (country-specific)

Warning for no-entry signs: Traffic Sign Assist can warn you if you drive the wrong way down a section of road, for example, on motorway slip roads or one-way streets.

Warning at pedestrian crossings: if you approach pedestrian crossings, provided that pedestrians are in the danger zone or are moving towards it, Traffic Sign Assist can warn you up to a speed of approximately 70 km/h.

Warning at stop signs: Traffic Sign Assist can warn you up to a speed of approximately 70 km/h if you are about to drive past a stop sign unintentionally. For this to be possible, the signs must be clear. For example, if the system detects more than one stop sign, a stop sign can be confirmed

using the digital navigation map. No warning can be issued if several different signs are detected.

Warning at red lights: Traffic Sign Assist can warn you up to a speed of approximately 70 km/h if you are about to drive through a red light unintentionally.

The following conditions must be fulfilled:

- Several traffic lights have been detected.
- All traffic lights detected are red.
- At least one of the red traffic lights detected is on the front passenger side beside the vehicle's lane.
- The traffic lights are in the following sequence (from top to bottom): red, yellow, and green.

i If the function is available, you can activate or deactivate the warnings at pedestrian crossings, stop signs and red lights in the Traffic Sign Assist menu under [Further warnings](#) (→ page 349).

System limits

The system may be impaired or may not function, particularly in the following situations:

- If visibility is poor, e.g. due to insufficient illumination of the road, highly variable shade conditions, rain, snow, fog, swirling dust or heavy spray.
- If there is glare, e.g. from oncoming traffic, direct sunlight or reflections.
- If there is dirt on the windscreen in the vicinity of the multifunction camera or if the camera is misted up, damaged or obscured.
- If the traffic signs are difficult to see because, for example, they are dirty, obscured, faded, iced over, damaged, inconveniently positioned, insufficiently illuminated or distorted.
- Active traffic signs with LED displays may not be detected correctly or at all due to technical factors, such as transmission frequency.
- If the information on the navigation system's digital map is incorrect, incomplete or out of date.

- If the signs, road markings or road layout are ambiguous, e.g. in the case of traffic signs on construction sites, at exits and driveways, in the case of adjacent lanes or parallel roads, in the case of pedestrian crossing markings at traffic lights
- If the signage or road markings do not comply with the standard
- If the signage, road markings, or road guidance is country-specific and deviates from the navigation system's route guidance, e.g. in or after road works
- after sharp turns and tight bends, traffic signs are outside the camera's field of vision.
- If you overtake vehicles with traffic signs affixed or attached to them.
- If you use transport equipment secured to the vehicle with a trailer coupling, such as a bicycle rack, restrictions for car/trailer combinations may be considered valid if applicable.



Setting Traffic Sign Assist

Multimedia system:

- 

 ► Settings ► Assistance
 ► Assistance ► Traffic Sign Assist

Activating or deactivating the speed warning



-  The speed warning is switched on by default (depending on the country).
-  Switch off **Speed limit warning**.
 In accordance with country-specific legislation, the speed warning remains switched off until the next time the vehicle is switched on or off and the driver's door is opened (depending on equipment).
-  The audible speed warning can also be switched off and on by quick access, by pressing and holding the mute button on the steering wheel, by pressing the speed icon in the status line of the central display or via a voice control command (functions are available depending on the country).

Change the type of speed warning

-  Change the warning **Visual** to or **Visual & audible**.

Setting the warning threshold



This value determines the speed at which a warning is issued when exceeded.

-  Set the desired speed under Warning Threshold.
-  The availability of the function is subject to country-specific legislation.

Switching the advisory tone for a new speed limit on or off

-  The advisory tone for a new speed limit is switched off at the factory.

The function determines whether a subtle, non-intrusive sound supports each change of the displayed speed in the driver's display.

-  Activate or deactivate the function.
-  The availability of the function is dependent on the country.

Activating or deactivating further functions of Traffic Sign Assist

-  Switch further warning contents on or off.
 The available functions are switched on or off.

Set the type of warning for other functions

- ▶ Select [Visual](#) or [Visual & audible](#).

Traffic light view

Information about the traffic light view

The traffic light view supports the driver when waiting in front of a red light by displaying the camera image on the central display. The camera image is displayed when the driver is the first vehicle in front of the red light and faded out when the vehicle drives off.

Displaying traffic light view

Requirements:

- The [Traffic light view](#) option is switched on.
- A traffic light view is available.



Multimedia system:

- ▶  ▶▶ [Settings](#) ▶▶ [Assistance](#)
- ▶▶ [Assistance](#) ▶▶ [Traffic light view](#)

- ⓘ This function is not available in all countries.

If the vehicle is in first position at a traffic light, the camera image with traffic light view is shown on the central display.

When the vehicle pulls away, the camera image is faded out.

- ▶ Activate  or deactivate  [Traffic light view](#).

Using other available functions

- ▶ Select .

- ▶ Select [On request](#) or [Automatic](#).

If [On request](#) is set and a traffic light view is available, the [Please tap here for traffic light view](#) message is displayed. The camera image is shown after confirmation of the message.

When [Automatic](#) is set, the camera image is automatically displayed when the traffic light view is available.

Blind Spot Assist and Active Blind Spot Assist

Function of Blind Spot Assist and Active Blind Spot Assist with exit warning

Blind Spot Assist and Active Blind Spot Assist use radar sensors to monitor the area up to 40 m behind and 3 m next to your vehicle.

The system can detect vehicles travelling from speeds of approximately 12 km/h and issue a warning if they move into the monitoring range.

Status display in the driver's display



Grey: the system is activated but inoperative.



Green: the system is activated and operational.

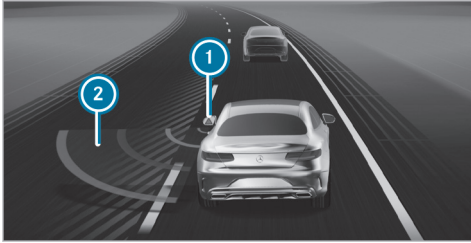

Display in the driver's display in the menu **Assistance**

If a vehicle is detected at speeds above approximately 12 km/h and this vehicle enters the warning range immediately afterwards, the warning lamp in the corresponding outside mirror lights up red. In the **Assistance** menu, the lamp in outside mirror ① also lights up red, and the lane in which the vehicle is detected is hatched out.

If a vehicle is detected in the warning range and you switch on the turn signal indicator in the corresponding direction, a double warning tone sounds once, and the warning lamp flashes red in the corresponding outside mirror. Red radar

waves ② are displayed next to your vehicle in the assistance graphic.

If the turn signal indicator remains on, the display in the outside mirror flashes for all other detected vehicles, but no further warning tone sounds. If you overtake a vehicle quickly, no warning is given.

i **Vehicles with active ambient lighting:** if **Warning assistance** is activated, the warning is additionally highlighted by the ambient lighting (→ page 224).

Observe the notes on driving systems and your responsibility; you may otherwise fail to recognise dangers (→ page 303).

⚠ WARNING Risk of accident despite Blind Spot Assist

Blind Spot Assist does not react to vehicles approaching and overtaking you at a greatly different speed.

Blind Spot Assist cannot warn drivers in this situation.

▶ Always pay careful attention to the traffic situation and maintain a safe distance at the side of the vehicle.

⚠ WARNING Risk of accident despite Active Blind Spot Assist

Active Blind Spot Assist does not react to the following:

- if you overtake a vehicle too closely so that it is in the blind spot area
- if vehicles travelling at a much faster speed approach and then overtake

Active Blind Spot Assist may not give warnings or intervene in such situations.

▶ Always pay careful attention to the traffic situation and maintain a safe distance at the side of the vehicle.

Exit warning

The exit warning is an additional function of Blind Spot Assist and Active Blind Spot Assist and can warn vehicle occupants attempting to leave a stationary vehicle about approaching vehicles.

⚠ WARNING Risk of accident despite exit warning

The exit warning neither reacts to stationary objects nor to persons or road users approaching you at a greatly differing speed.

The exit warning cannot warn drivers in these situations.

- ▶ Always pay particular attention to the traffic situation when opening the doors and make sure there is sufficient clearance.

If a vehicle is detected in the monitoring range, the red warning lamp lights up in the corresponding outside mirror.

If a vehicle occupant pulls the door handle on the side of the warning, a warning tone sounds twice and the ambient lighting in the respective door and the warning lamps in the corresponding outside mirror flash red.

i Vehicles with ambient lighting or active ambient lighting: the **Warning assistance** of the ambient lighting can be activated and deactivated (→ page 224).

i The warning assistance can differ depending on the equipment and may vary according to the setting.

This exit warning is only available when Blind Spot Assist or Active Blind Spot Assist is active.

After the vehicle is switched off, the exit warning continues to function for a few minutes. If a door is opened while the vehicle is switched off, the exit warning is active again for a few minutes. When the outside mirror warning lamp flashes three times, the exit warning is no longer available.

The exit warning is only an aid and not a substitute for the attention of vehicle occupants. The responsibility for opening and closing the doors and for leaving the vehicle remains with the vehicle occupants.

System limits

Blind Spot Assist and Active Blind Spot Assist may be limited in the following situations, in particular:

- if there is dirt on the sensors or the sensors are obscured

- in poor visibility, e.g. due to fog, heavy rain or snow
- if there are narrow vehicles, e.g. bicycles or motorbikes
- if the road has very wide or narrow lanes
- if vehicles are not driving in the middle of their lane

Warnings may be issued in error when driving close to crash barriers or similar continuous lane borders. Always make sure that there is sufficient distance to the side for other traffic or obstacles.

Warnings may be interrupted when driving alongside long vehicles, for example lorries, for a prolonged time.

Blind Spot Assist and Active Blind Spot Assist are not operational when reverse gear is engaged.

Blind Spot Assist and Active Blind Spot Assist are not operational if transport equipment, for example a trailer or bicycle rack, is attached to the trailer hitch and the electrical connection has been correctly established.

Additionally, the exit warning may be limited in the following situations:

- when the sensors are covered by adjacent vehicles in narrow parking spaces
- when people approach the vehicle
- in the event of stationary or slowly moving objects

Function of the brake application of Active Blind Spot Assist

- ① The brake application function is only available for vehicles with a Driving Assistance Package.

If Active Blind Spot Assist detects a risk of a side impact in the monitoring range, a course-correcting brake application is carried out. This is designed to help you avoid a collision.

The course-correcting brake application is available in the speed range between approximately 30 km/h and approximately 200 km/h.

⚠ WARNING Risk of accident despite brake application of Active Blind Spot Assist

A course-correcting brake application cannot always prevent a collision.

- ▶ Always steer, brake or accelerate yourself, especially if Active Blind Spot Assist warns you or makes a course-correcting brake application.
- ▶ Always maintain a safe distance at the sides.

⚠ WARNING Risk of accident despite Active Blind Spot Assist

Active Blind Spot Assist does not react in the following situations:

- If you overtake vehicles at a high speed.
- If vehicles approach and overtake you at a greatly different speed.

Active Blind Spot Assist may not give warnings or intervene in such situations.

- ▶ Always pay careful attention to the traffic situation and maintain a safe distance at the side of the vehicle.



If a course-correcting brake application occurs, the red warning lamp flashes in the outside mirror and a warning tone sounds. In addition, a display ① indicating the danger of a side collision appears in the driver's display.

In rare cases, the system may make an inappropriate brake application. This brake application may be interrupted at any time if you steer slightly in the opposite direction or accelerate.

System limits

Note the system limitations of Active Blind Spot Assist; you may otherwise not recognise the dangers (→ page 350).

Either a course-correcting brake application appropriate to the driving situation, or none at all, may occur especially in the following situations:

- Vehicles or obstacles, e.g. crash barriers, are located on both sides of your vehicle.
- A vehicle approaches too closely on the side.
- You have adopted a sporty driving style with high cornering speeds.
- You brake or accelerate significantly.
- A driving safety system intervenes, e.g. ESP® or Active Brake Assist.
- ESP® is deactivated.
- A loss of tyre pressure or a defective tyre is detected.
- Transport equipment, for example a trailer or bicycle rack, is attached to the trailer hitch and the electrical connection has been correctly established.

■ Activating/deactivating Blind Spot Assist or Active Blind Spot Assist

Multimedia system:

→  → Settings → Assistance
 → Collision avoidance

▶ Activate or deactivate **Active Blind Spot Assist**.

Active Lane Keeping Assist

■ Function of Active Lane Keeping Assist

Active Lane Keeping Assist monitors the area in front of your vehicle by means of the multifunction camera (→ page 304) and can warn you before you leave your lane unintentionally. The system can guide you back into your lane through a course-correcting steering intervention and additionally warns you with vibration pulses in the steering wheel. Active Lane Keeping Assist is available in the speed range between 60 km/h and 200 km/h.

The system can intervene in the following situations:

- Active Lane Keeping Assist detects a lane marking.
- One of your front wheels goes over a lane marking.

If you activate the turn signal indicator, a steering intervention does not occur on the corresponding side.

If you leave the lane without activating the turn signal indicator, but danger of a collision with a moving obstacle is detected in your lane, a steering intervention does not occur.

Vehicles with Blind Spot Assist or Driving Assistance Package: if the system detects an obstacle, such as another vehicle in the adjacent lane, a steering intervention will occur regardless of the turn signal indicator.

In the following situations (country-dependent), Active Lane Keeping Assist may already react from a speed of approximately 45 km/h:

- If your own vehicle is overtaken by another road user and the danger of a collision is

detected, a lane-correcting steering intervention occurs

- If you drive over a detected lane marking, the system warns you with vibration pulses in the steering wheel.



Display ❶ will appear in the driver's display and a warning tone will sound in the following situations:

- A steering intervention by Active Lane Keeping Assist lasts longer than approximately ten seconds.
- The system carries out two or more steering interventions within approximately three minutes without any steering intervention from the driver.

In the Active Lane Keeping Assist settings, you can set the sensitivity of the system and set the level of support. Additionally, you can set whether the system should react to discontinuous lane markings or only continuous lane markings (→ page 357).

If ATTENTION ASSIST has detected indications of fatigue or a microsleep, the most sensitive setting is automatically selected (→ page 315).

Status displays for Active Lane Keeping Assist



White: Active Lane Keeping Assist is deactivated.

If ESP® is deactivated or a tire pressure loss warning is displayed, Active Lane Keeping Assist is automatically deactivated.



Yellow: there is a malfunction. Please also observe the display messages.



Grey: Active Lane Keeping Assist is activated, but not operating.



Green: Active Lane Keeping Assist is activated and operating. If the system is opera-

tional on only one side, the lane marking is shown in green on the corresponding side.



Red: Active Lane Keeping Assist has guided you back into your lane with a course-correcting steering intervention. The status display will flash if there is also a haptic warning in the steering wheel. The lane marking is shown in red only on the side for which there is a warning.

Vehicles without Driving Assistance Package: if both lane markings are simultaneously shown in red in the status display, Active Lane Keeping Assist has initiated an emergency stop (→ page 332).

Active Lane Change Assist display in the "Assistance" menu



If the front wheel of the vehicle drives over a detected lane marking, this will be highlighted red in the **Assistance** menu in the driver's display.

i **Vehicles with active ambient lighting:** if **Warning assistance** is activated, the Active Lane Keeping Assist warning is also accompanied by ambient lighting (→ page 224).

System limits

In the following situations, a lane-correcting steering intervention may not occur but rather a warning may be given on the steering wheel, depending on the situation:

- You clearly and actively steer, brake or accelerate.
- If a driving safety system intervenes, such as ESP®, Active Brake Assist or Active Blind Spot Assist.
- You have adopted a sporty driving style with high cornering speeds or high rates of acceleration.
- If transport equipment, for example a trailer or bicycle rack, is attached to the trailer hitch and the electrical connection has been correctly established.

The system may be impaired or may not function particularly in the following situations:

- If there is poor visibility, e.g. due to insufficient illumination of the road, highly variable shade conditions, rain, snow, fog or heavy spray.

- If there is glare, e.g. from oncoming traffic, the sun or reflections.
- If there is dirt on the windscreen in the vicinity of the multifunction camera or if the camera is misted up, damaged or obscured.
- If there is dirt on the bumper in the area of the radar sensors, or if they are damaged or covered.
- If there are no lane markings, or several unclear lane markings are present for one lane, e.g. around roadworks.
- If the lane markings are worn, dark or covered.
- If the distance to the vehicle in front is too short and thus the lane markings cannot be detected.
- If the lane markings change quickly, e.g. lanes branch off, cross one another or merge.
- If the carriageway is very narrow and winding.

Observe the notes on driving systems and your responsibility; you may otherwise fail to recognise dangers (→ page 303).

■ Activating/deactivating Active Lane Keeping Assist

Multimedia system:

- ➔  ➔ Settings ➔ Assistance
- ➔ Collision avoidance
- ➔ Active Lane Keeping Assist

- ▶ Activate or deactivate the function.

Alternatively, Active Lane Keeping Assist can be activated and deactivated via the  quick vehicle access.

- ⓘ After starting the vehicle, the settings are country-specific.

■ Setting Active Lane Keeping Assist

Multimedia system:

- ➔  ➔ Settings ➔ Assistance
- ➔ Collision avoidance
- ➔ Active Lane Keeping Assist

Setting the sensitivity

- ▶ Select .
- ▶ Select **Early**, **Med.** or **Late**.

The last selected setting will be adopted the next time the vehicle is started.

- ⓘ The standard setting for this function is dependent on the country.

Activating or deactivating assistance on discontinuous lane markings

- ▶ Select **Advanced support**.

The last selected setting will be adopted the next time the vehicle is started.

- ⓘ The standard setting for this function is dependent on the country.
- ⓘ This function must be activated in vehicles without Driving Assistance Package, so that Emergency Stop Assist is fully available. Further information on Emergency Stop Assist (→ page 332)



AIRMATIC

■ Function of AIRMATIC

AIRMATIC is an air suspension system with variable damping for improved driving comfort. The all-round level control system ensures the best possi-

ble suspension and constant ground clearance, even with a laden vehicle. When driving at speed, the vehicle is lowered automatically to improve driving safety and to reduce energy consumption. You also have the option of manually adjusting the vehicle level.

AIRMATIC includes the following components and functions:

- air suspension with automatic all-round level control
- ADS PLUS (Adaptive Damping System with constant adjustment of damping characteristics)
- speed-dependent lowering of the vehicle level
- increased vehicle level for greater ground clearance, selected via the multimedia system
- a comfortable suspension setting in drive programs  and 
- a firmer, sporty suspension setting in drive program 
- lowering the vehicle at speeds above 120 km/h in order to reduce energy consumption

When driving at speeds below 80 km/h, the vehicle is raised again to the normal level.

- i** **Operation with a trailer or bicycle rack:** if transport equipment, such as a trailer or a bicycle rack, is attached to the trailer hitch and the electrical connection has been correctly established, the vehicle remains at normal level irrespective of speed or the drive program selected.

■ Setting the vehicle level

- ⚠ WARNING** Risk of accident because vehicle level is too high

Driving characteristics may be impaired.

The vehicle can drift outwards, for example, when steering or cornering.

- ▶ Choose a vehicle level which is suited to the driving style and the road surface conditions.

- ⚠ WARNING** Risk of becoming trapped due to the vehicle lowering

When lowering the vehicle, persons may become trapped if body parts are between the vehicle body and the tyres or underneath the vehicle.

- ▶ Make sure nobody is underneath the vehicle or in the immediate vicinity of the wheel arches when you lower the vehicle.

- ⚠ WARNING** Risk of becoming trapped due to the vehicle lowering

Vehicles with AIRMATIC or level control: when you unload luggage or leave the vehicle, the vehicle first rises slightly and then returns to the set level shortly afterwards.

You or anyone else in the vicinity of the wheel arches or the underbody could thus become trapped.

The vehicle can also be lowered after being locked.

- ▶ When leaving the vehicle, make sure that nobody is in the vicinity of the wheel arches or the underbody.

- ! NOTE** Damage due to vehicle lowering

Parts of the body could be damaged when the vehicle is lowered.

- ▶ Make sure that there are no obstacles such as kerbs underneath or in the immediate vicinity of the body when the vehicle is being lowered.

Requirements

- The vehicle has been started.
- The vehicle is not moving faster than 40 km/h.
- When the trailer socket is contacted (trailer/ bicycle rack): the vehicle is not moving faster than 30 km/h.

Multimedia system:



Raising the vehicle

▶ Select .

The indicator lamp lights up continuously.

The vehicle is raised to high level +1.

Your selection is saved. High level +1 set remains stored even after the vehicle has been switched off.

The vehicle is lowered again in the following situations:

- When driving faster than 50 km/h.
- When the trailer socket is contacted (trailer/bicycle rack): the vehicle is moving faster than 30 km/h.

GPS-based raising

If the function is activated, it is possible to save the vehicle position when the vehicle level is raised.

▶ Confirm the prompt.
The position of the vehicle is stored. When the previously stored position is reached again, a

prompt appears in the Zero Layer as to whether the vehicle level should be raised again.

 Settings for GPS-based raising (→ page 359).

 Function of the Zero Layer (→ page 431).

Lowering the vehicle

▶ Select .

The indicator lamp goes out.

The vehicle is adjusted to the normal level.

 Use the normal level in trailer operation. High-level driving is not permitted in trailer operation on public roads.

Setting GPS-based raising of the vehicle

Multimedia system:



▶ Select **Positions saved on request**, **Always save positions** or **Delete all saved positions**.

AMG RIDE CONTROL +

Function of AMG RIDE CONTROL +

AMG RIDE CONTROL + is an air suspension system with variable damping for improved driving characteristics. The all-round level control system ensures the best possible suspension and constant ground clearance, even with a laden vehicle. When driving at speed, the vehicle is lowered automatically to improve driving safety and to reduce energy consumption. You also have the option of manually adjusting the vehicle level.

The damping is set individually for each wheel and is affected by the following factors:

- The drive program selected
- Driving style, e.g. sporty
- Road condition, e.g. bumps
- The individual selection of **SPORT**, **SPORT +** or **COMFORT**

AMG RIDE CONTROL + includes the following components and functions:

- Air suspension with variable spring rate and automatic level control



- Speed-dependent lowering to reduce energy consumption
- Increased vehicle level for greater ground clearance, selected via the multimedia system
- Adaptive Damping System with constant damping force adjustment

Suspension setting and vehicle level per drive program

Drive programs  and :

- The suspension setting is comfortable.
- The vehicle is set to the normal level.
- The vehicle is lowered while you are driving in the following cases:
 - You are driving faster than 120 km/h for at least 20 seconds.
 - You are driving faster than 160 km/h.
- The vehicle is raised to the normal level again in the following cases:
 - You are driving slower than 100 km/h for at least one minute.
 - You are driving slower than 80 km/h.

Drive programs  and :

- The suspension setting is firm ().
- The suspension setting is even firmer ().
- The vehicle is set to low level.
- The vehicle is not lowered any further if you are travelling at higher speeds.

When the vehicle is started again, the **COMFORT** setting is activated automatically.

Selecting the suspension setting





 You can also adjust the suspension setting via the multimedia system (→ page 271).

You can select from three different suspension settings:

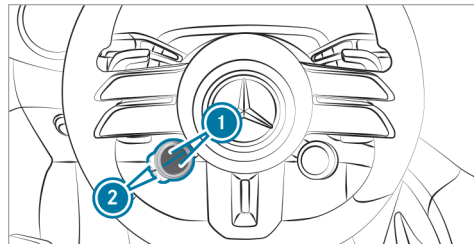

- **COMFORT** ensures a comfortable suspension setting. Select this suspension setting if you prefer a comfortable driving style.
- **SPORT** lowers the vehicle to the lowest level and ensures a firmer suspension setting. Select this suspension setting when employing a sporty driving style, e.g. on winding country roads.

- **SPORT +** lowers the vehicle to the lowest level and ensures a very firm suspension setting.



- ▶ Press upper or lower display button  repeatedly, until it displays the  symbol.
-  If the display button does not show the symbol, then it is hidden. How functions are displayed and the order in which they are displayed can be set in the multimedia system (→ page 266).
- ▶ Press corresponding button . The selected suspension setting is shown in the driver's display as a message.

The  symbol indicates the currently selected mode:

-  (blue): COMFORT
-  (yellow): SPORT
-  (red): SPORT +

■ Setting the vehicle level

⚠ WARNING Risk of accident because vehicle level is too high

Driving characteristics may be impaired.

The vehicle can drift outwards, for example, when steering or cornering.

- ▶ Choose a vehicle level which is suited to the driving style and the road surface conditions.

⚠ WARNING Risk of becoming trapped due to the vehicle lowering

When lowering the vehicle, persons may become trapped if body parts are between the vehicle body and the tyres or underneath the vehicle.

- ▶ Make sure nobody is underneath the vehicle or in the immediate vicinity of the wheel arches when you lower the vehicle.

⚠ WARNING Risk of becoming trapped due to the vehicle lowering

Vehicles with AMG RIDE CONTROL+ or level control system: when you unload luggage or leave the vehicle, the vehicle first rises slightly and then returns to the set level shortly afterwards.

You or anyone else in the vicinity of the wheel arches or the underbody could thus become trapped.

The vehicle can also be lowered after being locked.

- ▶ When leaving the vehicle, make sure that nobody is in the vicinity of the wheel arches or the underbody.

Multimedia system:



Raising the vehicle

Requirements for raising the vehicle:

- The vehicle has been started.
- The vehicle is not moving faster than 40 km/h.
- When the trailer socket is contacted (trailer/bicycle rack): the vehicle is not moving faster than 30 km/h.

- ▶ Select .

The indicator lamp lights up continuously.

The vehicle is raised to high level +1.

Your selection is saved. High level +1 set remains stored even after the vehicle has been switched off.

The vehicle is lowered again in the following situations:

- When driving faster than 70 km/h.

- When the trailer socket is contacted (trailer/ bicycle rack): the vehicle is moving faster than 30 km/h.

GPS-based raising

If the function is activated, it is possible to save the vehicle position when the vehicle level is raised.

▶ Confirm the prompt.
The position of the vehicle is stored. When the previously stored position is reached again, a prompt appears in the Zero Layer as to whether the vehicle level should be raised again.

- ① Settings for GPS-based raising (→ page 359)
- ① Zero Layer function (→ page 431)

Lowering the vehicle

▶ Select .
The indicator lamp goes out.
The vehicle is adjusted to the normal level.

- ① Use the normal level in trailer operation. High-level driving is not permitted in trailer operation on public roads.

RACE START

Information about RACE START

- ① RACE START is available only for Mercedes-AMG vehicles.

RACE START enables optimal vehicle acceleration from a standstill. A suitably high-grip road surface is required for this, and the tyres and vehicle must also be in good condition.

- ① RACE START must not be used in normal road operation. RACE START may be activated and used only on dedicated race circuits, not on public roads.
Read the safety notes and information on ESP® (→ page 308).

⚠ WARNING Risk of skidding and having an accident from wheels spinning

If you use RACE START, depending on the ESP® mode selected, there is an increased risk of skidding and having an accident.

- ▶ Make sure that no persons or obstacles are in the close vicinity of your vehicle.

RACE START with boost function

The boost function for RACE START is available only for vehicles with the **AMG DYNAMIC PLUS package** (→ page 306).

If the activation conditions are fulfilled, the additional engine output will be added automatically during RACE START. In this case, vehicle acceleration from a standstill will be even more dynamic.

Activating RACE START

⚠ WARNING Risk of skidding and having an accident from wheels spinning

If you use RACE START, depending on the ESP® mode selected, there is an increased risk of skidding and having an accident.

- ▶ Make sure that no persons or obstacles are in the close vicinity of your vehicle.

Requirements

- The vehicle is switched on and at normal operating temperature.
- The state of charge of the high-voltage battery is sufficient.

- The driver's door is closed.
 - The front wheels are in a straight-ahead position.
 - The vehicle is on level ground.
 - The vehicle is stationary, the brake pedal is depressed (left foot) and the parking brake is released.
 - The transmission is in position **D**.
 - One of the drive programs **S** or **S+** is selected (→ page 267).
- i** RACE START must not be used in normal road operation. RACE START may be activated and used only on dedicated race circuits, not on public roads. Read the safety notes and information on ESP® (→ page 308).
- ▶** Rapidly depress the accelerator pedal fully. The drive noise will become louder and the vehicle will vibrate. The seat belts on the driver's and front passenger seats will be pre-tensioned.

- i** If the activation conditions are not fulfilled, RACE START cannot be used. The **RACE START not possible See Owner's Manual** message will appear on the driver's display.

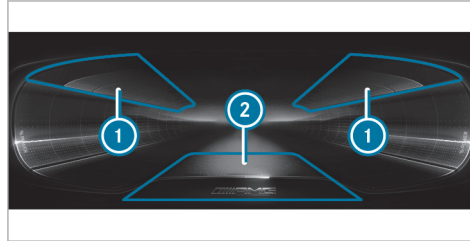

- 1** RACE START display area activated
 - 2** Boost function display area available
- i** What is shown in display area **1** varies according to the selected menu for the driver's display.

- ▶** Display areas **1** flash red on the driver's display and the **RACE START Release brake to start** message will appear. **RACE START with boost function:** if RACE START with boost function is activated, the race start messages will be supplemented with the information **Boost active**. In addition, lower centre display area **2** will flash red (vehicles with AMG DYNAMIC PLUS package).
- i** If the brake pedal is not released after a short while, RACE START will be cancelled. The **RACE START cancelled** message will appear on the driver's display.
- ▶** Take your foot off the brake, but keep the accelerator pedal depressed. The vehicle will pull away at maximum acceleration. The **RACE START active** message will appear on the driver's display.

RACE START will be deactivated immediately if you release the accelerator pedal during RACE START or if any of the activation conditions are no longer fulfilled. The **RACE START cancelled** message will appear on the driver's display.

- ⓘ After using it several times in quick succession, RACE START will be unavailable until a certain distance has been driven.

Reversing camera

Function of the reversing camera

The reversing camera is only an aid. It is not a substitute for your attention to your surroundings. You are always responsible for safe manoeuvring and parking. Ensure that there are no persons, animals or objects etc., in the manoeuvring area while manoeuvring and parking.

- ⓘ The area behind the vehicle is displayed as a mirror image, as in the inside rear view mirror.

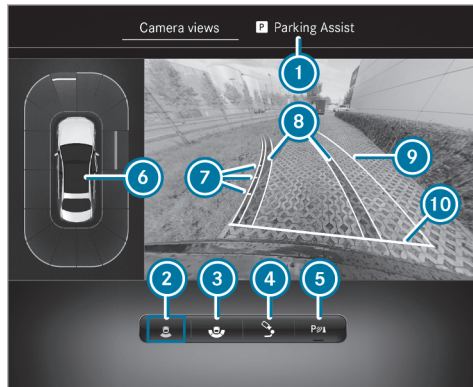

Menu **Camera views** (top view)

- ① Menu **Parking Assistance**
- ② Reversing camera with top view
- ③ Wide-angle view
- ④ Trailer view
- ⑤ Activating/deactivating Parking Assist PARKTRONIC (→ page 375)

- ⑥ Warning display of Parking Assist PARKTRONIC (→ page 371)
- ⑦ Guidelines at a distance of approximately 0.5 m, 1.0 m, 1.5 m and 3.0 m from the rear area
- ⑧ Lane marking the course the tyres will take with the current steering angle (dynamic)
- ⑨ Driven surface depending on the current steering angle (dynamic)
- ⑩ Guideline at a distance of approximately 0.3 m from the rear area
- ⓘ When Active Parking Assist is active, lanes ⑧ display in green (→ page 375).

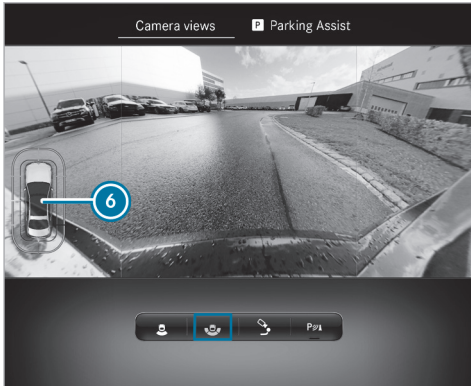

Wide-angle view

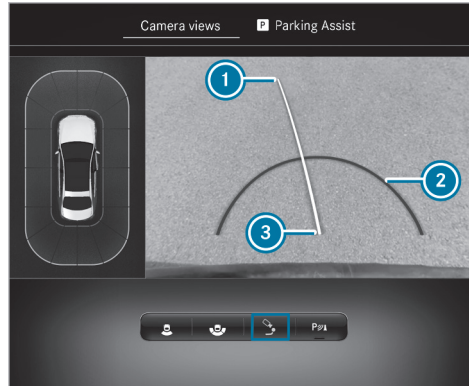

Trailer view

- ① Yellow guide line, locating aid
- ② Red guide line at a distance of approximately 0.3 m from the ball head of the trailer hitch
- ③ Ball head of the trailer hitch

System limits

If the system is not ready for operation, the **System inoperative** message appears on the central display.

The reversing camera will not function or will only partially function in the following situations:

- You are driving forwards at speed greater than approximately 16 km/h.
- The tailgate is open.
- The weather conditions are poor, e.g. heavy rain, snow, fog, storm or spray.
- The light conditions are poor, e.g. at night or if a light is shining into the camera.
- The camera lens is obstructed, dirty or misted up. Observe the notes on cleaning the reversing camera (→ page 604).
- The camera or rear of your vehicle is damaged. In this case, check the camera's position and setting at a qualified specialist workshop.

i Do not use the reversing camera in these types of situations. You could otherwise injure others or collide with objects when parking the vehicle.

The field of vision and other functions of the camera system may be restricted due to additional attachments on the vehicle (e.g. licence plate bracket, bicycle rack).

i The display's contrast may be impaired by direct sunlight or other light sources, e.g. when driving out of a garage. In this case, pay particular attention.

i Have the display repaired or replaced if, for example, pixel errors considerably restrict its use.

Also, observe the information on vehicle sensors and cameras (→ page 304).

360° Camera

Function of the 360° Camera

The 360° camera is a system consisting of four cameras that capture the immediate vehicle envi-

ronment. The cameras support you, for example, when parking or when exits are difficult to see.

The 360° camera includes the following cameras and evaluates their images:

- Rearview camera
- Front camera
- Two side cameras in the exterior mirrors

The cameras are only aids and may show obstacles distorted in perspective, not correctly or not at all. They cannot replace your attention to the environment. You are always responsible for safe manoeuvring and parking. Ensure that there are no persons, animals or objects etc., in the manoeuvring area while manoeuvring and parking.

Menu **Camera views** overview

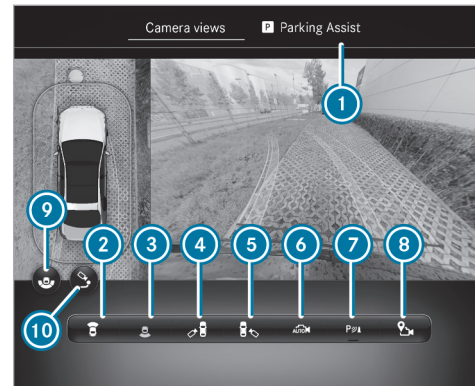

- 1 Menu **Parking Assistance**
- 2 Top view with the image from the front camera
- 3 Top View with the image from the rearview camera
- 4 3D view left side of the vehicle
- 5 3D view right side of the vehicle

- ⑥ 3D auto view
- ⑦ Activating/deactivating Parking Assist PARKTRONIC (→ page 375)
- ⑧ Set the GPS activation point (→ page 371)
- ⑨ To switch between standard and wide-angle view
- ⑩ To switch between standard and trailer view
- ⓘ The warning display of the PARKTRONIC parking assistant is shown in all views (→ page 371).

Function of the guidelines

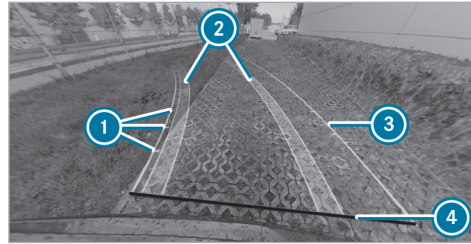

- ① Guidelines at a distance of approximately 0.5 m, 1.0 m, 1.5 m and 3.0 m from the rear area
- ② Lane marking the course the tyres will take with the current steering angle (dynamic)
- ③ Driven surface depending on the current steering angle (dynamic)
- ④ Guideline at a distance of approximately 0.3 m from the rear area
- ⓘ When Active Parking Assist is active, lanes and guidelines display green instead of yellow (→ page 375).

Top view with the image from the front or reversing camera

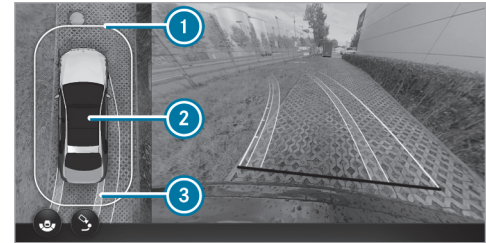

- ① Warning display of Parking Assist PARKTRONIC (→ page 371)
- ② Your vehicle from above
- ③ Lane indicating the route the vehicle will take at the current steering angle

3D view, left/right-hand side of the vehicle

! **NOTE** Risk of accident due to objects being severely distorted in the display or not displayed at all

Due to the projection of the cameras, objects in the 3D views may be severely distorted when displayed or not displayed at all.

▶ Make sure that there are no persons, animals or objects etc. in the manoeuvring area while manoeuvring and parking.



① Display of Parking Assist PARKTRONIC (→ page 371)

In the 3D view, left-/right-hand side of the vehicle, the virtual camera moves to the respective side of the vehicle. When you change the transmission position, the view is automatically adapted.

3D auto view

① The area behind the vehicle is , not, displayed as a mirror image as is usual in the 3D views.

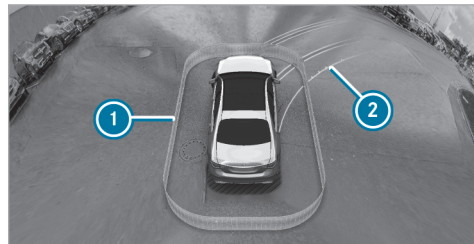

① Display of Parking Assist PARKTRONIC (→ page 371)

② Guidelines

In the 3D auto view, the virtual camera moves to the standard perspective, facing forward from the rear above the roof. The view changes automatically when approaching obstacles.

If you touch the touchscreen, the view changes to a 3D view with free rotation. You can turn, tilt and zoom the views by touch.

Wide-angle view



- ① Display of Parking Assist PARKTRONIC (→ page 371)
- ② To switch between standard and wide-angle view

Trailer view

- ① In trailer mode, the guidelines are shown at the level of the trailer hitch.

If you select the trailer view and no trailer is coupled to the vehicle, the following display appears:

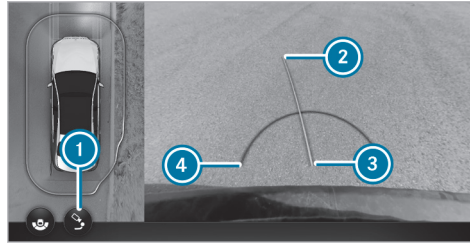

Trailer view: locating aid

- ① To switch between standard and trailer view
- ② Yellow locating aid
- ③ Ball head of the trailer hitch
- ④ Red guide line at a distance of approximately 0.3 m from the ball head of the trailer hitch

The display changes to the side camera view when the electrical connection is established between the vehicle and the trailer.

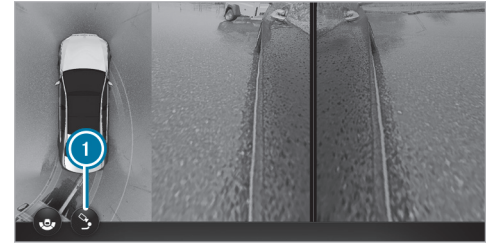

Trailer view: side view of the mirror cameras

- ① To switch between standard and trailer view

System limits

If the system is not ready for operation, the **System inoperative** message appears on the central display.

The 360° Camera will not function or will only partially function in the following situations:

- You are driving forwards at speed greater than approximately 16 km/h.
- The doors are open.
- An outside mirror is not completely folded out.
- The boot lid is open.

- The weather conditions are poor, e.g. heavy rain, snow, fog, storm or spray.
- The light conditions are poor, e.g. at night or if a light is shining into the camera.
- The camera lens is obstructed, dirty or misted up. See the notes on cleaning the 360° Camera (→ page 604).
- If cameras or vehicle components in which the cameras are fitted are damaged. In this event, have the cameras, their positions and their setting checked at a qualified specialist workshop.

i Do not use the 360° Camera under such circumstances. You could otherwise injure others or collide with objects when parking the vehicle.

For technical reasons, the standard height of the vehicle may be altered if the vehicle is carrying a heavy load which can result in inaccuracies in the guidelines and the display of the generated images.

The field of vision and other functions of the camera system may be restricted due to additional

attachments on the vehicle (e.g. licence plate bracket, bicycle rack).

- i** The display's contrast may be impaired by abrupt, direct sunlight or other light sources, e.g. when driving out of a garage. In this case, pay particular attention.
- i** Have the display repaired or replaced if, for example, pixel errors considerably restrict its use.

Also, observe the information on vehicle sensors and cameras (→ page 304).

Calling up the 360° Camera views using the button

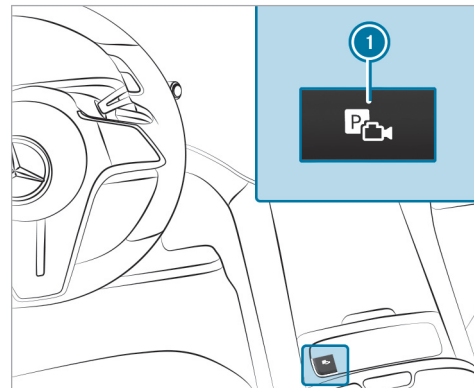

- i** Depending on the vehicle's equipment, the button ① may also be located at a different position in the centre console.
- ▶ Press the button ①.
- ▶ Select **Camera views** menu.

- ▶ Select the desired view in the multimedia system (→ page 366).

■ Selecting a view for the 360° Camera (reverse gear)

Requirements

- The **Activation in R** setting is activated in the multimedia system .
- ▶ Engage reverse gear.
- ▶ Select the desired view in the multimedia system (→ page 366).

■ 360° Camera with GPS - managing activation positions

Multimedia system:

- ▶  ▶ Settings ▶ Assistance
- ▶ ▶ Camera

Renaming an activation position

- ① You can determine activation positions in the **Camera views** menu. (→ page 366)
- ▶  Select for the desired activation position.

- ▶ Select **Edit**.
- ▶ Enter a name and confirm.
The activation position is saved under the new name.

Deleting an activation position

- ▶  Select for the desired activation position.
- ▶ Select **Delete entry**.
- ▶ Confirm the prompt.
The activation position is deleted.

■ Opening the camera cover

Multimedia system:

- ▶  ▶ Settings ▶ Assistance
- ▶ ▶ Camera

- ▶ Select **Open camera cover**.
- ① The camera cover closes automatically after some time or after the vehicle is switched on or off.

Parking Assist PARKTRONIC

■ Function of Parking Assist PARKTRONIC

Parking Assist PARKTRONIC is an electronic parking assistance system that monitors the area surrounding your vehicle and visually and audibly shows you the distance between the vehicle and a detected obstacle.

The passive side impact protection also warns you of obstacles to the side. These must be detected beforehand by the sensors in the front or rear bumper while driving by them. If you steer in the direction of a detected obstacle and there is a risk of a lateral collision, a warning is issued. Passive side impact protection can be activated and deactivated via the multimedia system.

For front or rear obstacles to the side to be displayed, the vehicle must first travel a distance of at least half a vehicle length. Once the vehicle has travelled one vehicle length, obstacles on all sides can be shown.

Parking Assist PARKTRONIC is only an aid. It is not a substitute for your attention to your surroundings. The responsibility for safe manoeuvring and parking remains with you. Ensure that there

are no persons, animals or objects in the manoeuvring area while manoeuvring and parking in/exiting parking spaces.

Displays in the central display

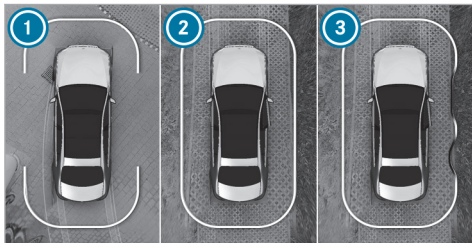

Vehicles with 360° Camera

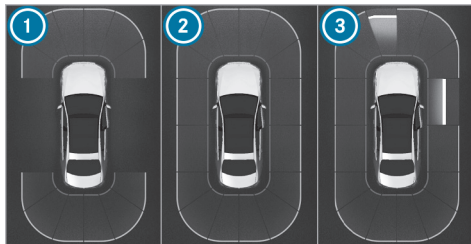

Vehicles with reversing camera

As soon as PARKTRONIC Parking Assist is ready for display, the respective areas of the display are shown in blue.

- ① Ready for display at the front and rear
- ② Ready for display all round
- ③ All-round display readiness and obstacle detection

The colour of the display changes depending on the distance to the detected obstacle:

- **Blue:** > 1 m (no obstacles detected)
- **Yellow:** approx. 1 m - 0.7 m

- **Orange:** approx. 0.7 m - 0.4 m
- **Red:** < 0.4 m

Vehicles with 360° Camera: the boundary line shifts dynamically depending on the position and distance of the obstacles detected.

An intermittent warning tone also sounds depending on the distance to the obstacle detected. You can set the timing of the warnings in the multimedia system. In the **Warn early** setting, the system warns you from a distance of 1 m. In the standard setting, only from 0.4 m.



Vehicles with 360° Camera



Vehicles with reversing camera

If you are not in the **Camera & parking** menu and an obstacle in the vehicle path is detected, a pop-up window ① appears in the central display if the following requirements are met:

- **Vehicles without Active Parking Assist:** when driving no faster than 12 km/h.

- **Vehicles with Active Parking Assist:** when driving no faster than 18 km/h.

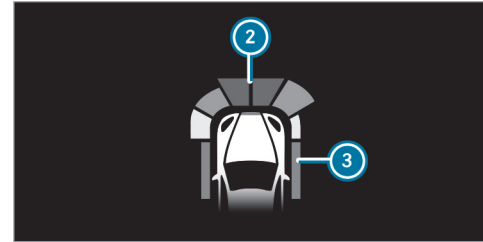

Optionally, obstacles detected by Parking Assist PARKTRONIC from a distance of approximately 1.0 m in front ② and 0.7 m on sides ③ can also be displayed in the head-up display.

Vehicles with active ambient lighting and Parking Package with remote parking functions

When **Warning assistance** is activated, the Parking Assist PARKTRONIC display is also accompanied by ambient lighting. If an obstacle is detected, the ambient lighting lights up in the same colour as the central display.

The ambient lighting which accompanies the Parking Assist PARKTRONIC display is only intended to accentuate the display in the central display and does not replace it.

More information on ambient lighting:
(→ page 224)

- i** A display message for the ambient lighting does not occur in the area of the driver's display or the rear compartment.
- i** Depending on the selected setting, other functions may supersede the ambient lighting effects of Parking Assist PARKTRONIC. In this case, the ambient lighting effects of Parking Assist PARKTRONIC do not occur.

System limits

Parking Assist PARKTRONIC does not necessarily take into account the following obstacles:

- Obstacles below the detection range, e.g. persons, animals or objects.
- Obstacles above the detection range, e.g. overhanging loads, overhangs or loading ramps of lorries.

- Pedestrians or animals approaching the vehicle from the side.
- Objects placed next to the vehicle

Obstacles on the sides are not shown in the following situations, for example:

- You park the vehicle and switch it off.
- You open the doors.

After the engine is restarted, obstacles must be detected again by driving past them before a new warning can be issued.

Also, observe the system limits of the following systems:

- Reversing camera (→ page 364)
- 360° Camera (→ page 366)

Observe the information on vehicle sensors and cameras; the system otherwise cannot function properly (→ page 304).

Vehicles with towbar: If a transport device, e.g. trailer or bicycle carrier is attached to the towbar, and the electrical connection is correctly established. PARKTRONIC Parking Assist is deactivated for the rear zone.

Problems with Parking Assist PARKTRONIC

If the Parking Assist PARKTRONIC display lights up red for approximately three seconds and then goes out, and the  symbol appears in the driver's display, the system may have been deactivated due to signal interference. Start the vehicle again and check if Parking Assist PARKTRONIC works at a different location.

If a warning tone also sounds, it may be due to one of the following causes:

- **The sensors are dirty:** clean the sensors and observe the notes on the care of vehicle parts (→ page 604).
- **Parking Assist PARKTRONIC has been deactivated due to a malfunction:** restart the vehicle. If the problem persists, consult a qualified specialist workshop.

■ Activating/deactivating Parking Assist PARKTRONIC

! **NOTE** Risk of an accident from objects at close range

Parking Assist PARKTRONIC may not detect certain objects at close range.

- ▶ When parking or manoeuvring the vehicle, pay particular attention to any objects which are above or below the sensors, e.g. flowerpots or drawbars. The vehicle or other objects could otherwise be damaged.

Requirements

- The camera menu is open.
 - Or: the PARKTRONIC pop-up window appears.
- ▶ Press  in the central display.

If the indicator lamp is lit, Parking Assist PARKTRONIC is active. If the indicator lamp does not light up or the symbol  is displayed, PARKTRONIC Parking Assist is not active.

i Parking Assist PARKTRONIC is automatically activated when the vehicle is started.

Parking Assist PARKTRONIC can be activated or deactivated in the quick access menu.

■ Setting the warning tones of Parking Assist PARKTRONIC

Multimedia system:

- ▶  ▶ Settings ▶ Assistance
- ▶ ▶ Parking

Setting warning tones

- ▶ Select **Set warning tones**.
- ▶ Set the desired level under **Volume** or **Tone pitch**.

Activating/deactivating audio fadeout

- ▶ Select **Audio fadeout** and switch **Audio fade for warnings** on or off.
- The volume of the currently playing media source is reduced during a Parking Assist PARKTRONIC warning tone.

or

- ▶ Select **Audio fadeout** and switch **Audio fade-out in trans. position R** on or off.
- The volume of the currently playing media source is reduced when reverse gear is engaged.

Setting the time of the warnings

- ▶ Select **Time of warning**.
- ▶ Activate or deactivate **Side warning**.
- ▶ Set the desired warning time for **Front** or **Rear**.

Active Parking Assist

■ Function of Active Parking Assist

Active Parking Assist is an electronic parking assistance system which uses ultrasound with the assistance of the reversing camera and 360° Camera. When you are driving forwards up to approximately 35 km/h, the system automatically measures parking spaces on both sides of the vehicle.

Active Parking Assist offers the following functions:



Vehicles with reversing camera

- Parking in parking spaces parallel to the road
- Reversing into parking spaces perpendicular to the road

Vehicles with 360° Camera

- Parking in parking spaces parallel to the road
- Parking in parking spaces perpendicular to the road (optionally either forwards or reverse)
- Parking in parking spaces that can only be detected as such due to markings (forexample at the roadside)
- Exiting parking spaces if you have parked using Active Parking Assist

Active Parking Assist is only an aid. It is not a substitute for your attention to your surroundings. The responsibility for safe manoeuvring and parking remains with you. Ensure that no persons, animals, objects, etc., are in the manoeuvring range.



If Active Parking Assist is available, the  message appears in the driver's display. When the system detects parking spaces,  appears. The arrows show on which side of the road free

parking spaces are located. These are then shown in the central display.

When Active Parking Assist is activated, the turn signal indicators are activated based on the calculated path of your vehicle. The procedure is assisted by acceleration, braking, steering, and gear changes when entering or exiting a parking space.

To start the parking procedure, press the  button (→ page 377).

Active Parking Assist will be cancelled in the following situations:

- You press the  button again.
- You begin steering.
- You engage the park position .
- ESP® intervenes.
- You open the driver's door.

System limits

If the exterior lighting is malfunctioning, Active Parking Assist is not available.

Also, observe the system limits of the following systems:

- Reversing camera (→ page 364)

- 360° Camera (→ page 366)

Objects above or below the detection range of Active Parking Assist, e.g. protruding loads, overhangs or loading ramps of trucks or parking spaces' boundaries are not detected when measuring the parking space. These are also then not taken into account when calculating the parking procedure. In some circumstances, Active Parking Assist may prematurely guide you into the parking space or brake too late.

Certain environmental conditions, such as snowfall or heavy rain, may lead to a parking space being measured inaccurately. Parking spaces partially occupied by trailer drawbars might not be identified as such or measured incorrectly. Only use Active Parking Assist on level, high-grip ground.

⚠ WARNING Risk of accident due to objects located above or below the detection range of Active Parking Assist

If there are objects above or below the detection range, the following situations may arise:

- Active Parking Assist may steer too early.

- The vehicle may not stop in front of these objects.

There is a danger of collision!

- ▶ In these situations, do not use Active Parking Assist.

Active Parking Assist can also display unsuitable parking spaces, e.g. parking spaces in which parking is not permitted or parking spaces on unsuitable surfaces.

Do not use Active Parking Assist in the following situations:

- In extreme weather conditions such as ice, packed snow or heavy rain.
- When transporting a load that protrudes beyond the vehicle.
- If the parking space is on a steep downhill or uphill gradient.
- When snow chains are fitted.
- When a trailer or bicycle rack is attached.
- Directly after a tyre change or when spare tyres are fitted.

- If the tyre pressure is too low or too high.
- If the suspension is out of alignment, e.g. after bottoming out on a kerb.
- On steep inclines of more than approximately 15 %.

Parking with Active Parking Assist

⚠ WARNING Risk of accident due to objects located above or below the detection range of Active Parking Assist

If there are objects above or below the detection range, the following situations may arise:

- Active Parking Assist may steer too early.
- The vehicle may not stop in front of these objects.

There is a danger of collision!

- ▶ In these situations, do not use Active Parking Assist.

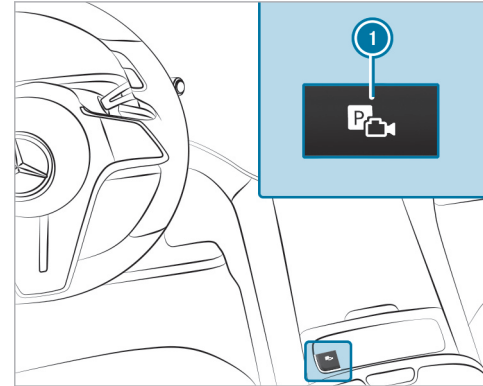

i Depending on the vehicle's equipment, the button **1** may also be located at a different position in the centre console.

- ▶ Press the button **1**.

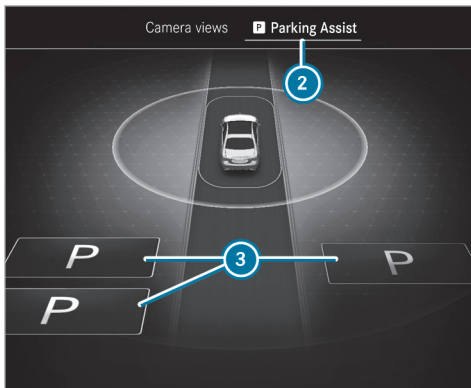

▶ Select **2** Parking Assistance menu.

Parking spaces **3** detected by the system are shown in the central display.

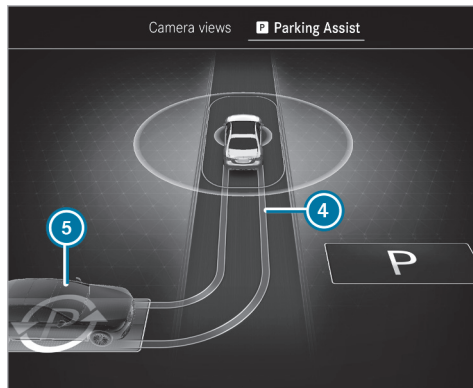

When the vehicle is stationary, indicated vehicle path **4** into the currently selected parking space **5** also appears.

- ▶ If a parking space is displayed: stop the vehicle.
- ▶ If necessary, select another parking space.

- ▶ **Vehicles with 360° Camera:** to change the parking direction, tap the selected parking space again.
- ▶ **To start the parking procedure:** press button **1** again.
- ▶ Take your hands off the steering wheel. The vehicle drives into the selected parking space.

The turn signal indicator is switched on automatically when the parking procedure begins. You are responsible for selecting the turn signal indicator following the traffic conditions. If necessary, select the turn signal indicator accordingly.

⚠ WARNING Risk of accident due to vehicle swinging out while parking or pulling out of a parking space

While parking or exiting a parking space, the vehicle swings out and can drive onto areas of the oncoming lane.

This could cause you to collide with objects or other road users.

- ▶ Pay attention to objects and other road users.
- ▶ Where necessary, stop the vehicle or cancel the parking procedure with Active Parking Assist.

On completion of the parking procedure, the **Active Parking Assist finished** display message appears.

- ▶ Secure the vehicle against rolling away. When required by legal requirements or local conditions: turn the wheels towards the kerb.
- ❗ You can stop the vehicle and change the transmission position during parking. The system then calculates a new vehicle path. If no new vehicle path is available, the transmission position can be changed, or the process can be cancelled.

Immediate parking via the **Camera views** menu



- ▶ Select the **Camera views** menu.
- ▶ When the vehicle is stationary and in transmission position **[R]**, and symbol **6** appears in the camera image: press the button **1** again. The parking procedure is initiated for the detected parking space.
- ❗ The parking space and parking direction cannot be changed in immediate parking.

Exiting a parking space with **Active Parking Assist**

⚠ WARNING Risk of accident due to objects located above or below the detection range of Active Parking Assist

If there are objects above or below the detection range, the following situations may arise:

- Active Parking Assist may steer too early.
- The vehicle may not stop in front of these objects.

There is a danger of collision!

- ▶ In these situations, do not use Active Parking Assist.

Requirements

- The vehicle is equipped with a 360° Camera.
- The vehicle has been parked with Active Parking Assist.
- ▶ Start the vehicle.

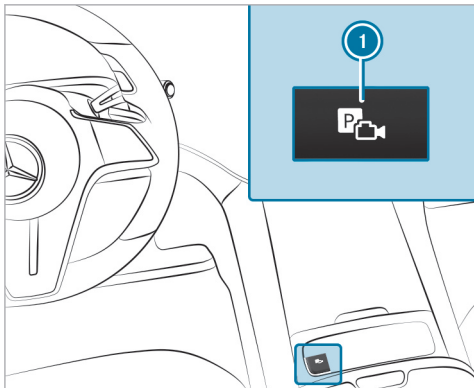

① Depending on the vehicle's equipment, the button ① may also be located at a different position in the centre console.

▶ Press the button ①.

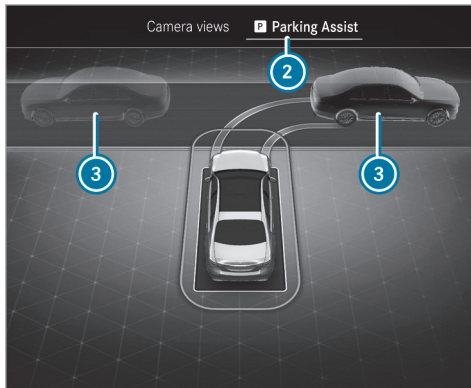

- ▶ Select **Parking Assistance** ② menu.
- ▶ If necessary, change the direction of the exit ③.
- ▶ **To start exiting the parking space:** press the button ① again.
- ▶ If necessary, change the gearbox setting. Observe any messages displayed in the driver's display and central display. The vehicle moves out of the parking space.

The turn signal indicator is automatically switched on when exiting a parking space begins and switched off when it is completed. You are responsible for selecting the turn signal indicator following the traffic conditions. If necessary, select the turn signal indicator accordingly.

⚠ WARNING Risk of accident due to vehicle swinging out while parking or pulling out of a parking space

While parking or exiting a parking space, the vehicle swings out and can drive onto areas of the oncoming lane.

This could cause you to collide with objects or other road users.

- ▶ Pay attention to objects and other road users.
- ▶ Where necessary, stop the vehicle or cancel the parking procedure with Active Parking Assist.

After the parking space has been exited, a warning tone and the message  **Active Parking Assist finished, take control of vehicle** prompt

you to take control of the vehicle. You have to accelerate, brake, steer and change gears yourself again.

If you do not react to the prompt to take control of the vehicle, the system will brake the vehicle to a standstill.

■ Pausing Active Parking Assist

⚠ WARNING Risk of accident due to objects located above or below the detection range of Active Parking Assist

If there are objects above or below the detection range, the following situations may arise:

- Active Parking Assist may steer too early.
- The vehicle may not stop in front of these objects.

There is a danger of collision!

- ▶ In these situations, do not use Active Parking Assist.

You can interrupt the parking or exiting procedure of Active Parking Assist by performing one of the following actions, foreexample:

- ▶ Depress the brake pedal.
- ▶ Open the passenger door, a rear door or the tailgate.
- ▶ Apply the electric parking brake or activating the HOLD function.
- ▶ **To resume the parking or exiting procedure:** gently depress the accelerator pedal.
- ⓘ If the electric parking brake was applied before Active Parking Assist was activated, depress the accelerator pedal lightly to start the parking or exiting procedure.

Check the area around your vehicle again before resuming a paused parking procedure. Ensure that persons, animals or objects are no longer in the manoeuvring range. Also, observe the system limitations of Active Parking Assist.

■ Automatic braking function of Active Parking Assist

⚠ WARNING Risk of accident due to objects located above or below the detection range of Active Parking Assist

If there are objects above or below the detection range, the following situations may arise:

- Active Parking Assist may steer too early.
- The vehicle may not stop in front of these objects.

There is a danger of collision!

- ▶ In these situations, do not use Active Parking Assist.

Persons or objects detected in the manoeuvring range could cause the vehicle to brake sharply and interrupt the parking or exiting procedure. The vehicle will then be held at a standstill. The parking or exiting procedure is resumed if you depress the accelerator pedal.

Check the area around your vehicle again before resuming the parking or exiting procedure. Ensure

that persons, animals or objects are no longer in the manoeuvring range. Also, observe the system limitations of Active Parking Assist.

Remote Parking Assist

Function of Remote Parking Assist

i Remote Parking Assist is an additional function of Active Parking Assist. Comply with local traffic laws and regulations when using Remote Parking Assist on public roads.

If it is prescribed to steer the wheels in the direction of the kerb, you must not use the Remote Parking Assist.

Please note that you may only operate the Remote Parking Assist if you have a valid driving licence and are fit to drive.

Remote Park Assist parks or releases your vehicle while you are outside your vehicle. You can control the manoeuvring and parking process on your mobile phone.

With Remote Park Assist, you can perform all the parking and unparking operations of Active Park Assist. In addition, you can position the vehicle

directly in front of a garage or driveway and then park it in or park it out with Remote Park Assist.

The Remote Park Assist takes over starting, braking and steering. While Remote Parking Assist is active, the vehicle is locked.

Remote Parking Assist is only an aid. It is not a substitute for your attention to your surroundings. The responsibility for safe manoeuvring and parking remains with you. Interrupt or terminate the parking procedure if necessary. Ensure that no persons, animals, objects, etc., are in the manoeuvring range. Ensure to also pay attention to other vehicles.

System limits

If the system detects a malfunction or system limit during the manoeuvring or parking process, the process is aborted:

- The vehicle is brought to a standstill.
- Transmission position **P** is selected and the electric parking brake is applied automatically.
- The vehicle is switched off.
- The vehicle is still locked.

If the parking process is cancelled, a corresponding message is displayed on the mobile phone.

Depending on the situation, you can then take control of the procedure, manoeuvre the vehicle back to the starting position or manually take control of the vehicle.

The system limits of Active Parking Assist apply (→ page 375).

Certain environmental conditions, such as snowfall or heavy rain, may lead to a parking space being measured inaccurately or to connection problems with the mobile phone. Only use Remote Parking Assist on level, high-grip ground.

During parking, your distance from the vehicle should not exceed approx. 3.0 m. At longer intervals, the process is aborted and a corresponding message is displayed on the mobile phone. When you approach the vehicle again, you can continue the process.

You can watch an animation on this topic via the following link:

■ Operating Remote Parking Assist

Requirements

For the Remote Park Assist function you need:

- a Mercedes me user account
- the current Remote Park Assist app for your vehicle type
- a mobile phone

 A list of compatible phones can be found at: <https://www.mercedes-benz-mobile.com/>

The following operating systems are supported:

- Android™
- Apple® iOS

 **WARNING** Risk of accident due to objects located above or below the detection range of Active Parking Assist

If there are objects above or below the detection range, the following situations may arise:

- Active Parking Assist may steer too early.
- The vehicle may not stop in front of these objects.

There is a danger of collision!

- ▶ In these situations, do not use Active Parking Assist.

Objects located above the detection range of Active Parking Assist will not be detected when the parking space is measured. These are not taken into account when the parking procedure is calculated, e.g. overhanging loads, overhangs or loading ramps of goods vehicles. In some circumstances, Active Parking Assist may therefore guide you into the parking space prematurely.

 **WARNING** Danger due to insufficient view of the vehicle surroundings

If you manoeuvre, park or exit a parking space with the vehicle using Remote Parking Assist, observe the following:

- ▶ Make sure that you have the best view possible of the vehicle and the vehicle's surroundings.
- ▶ Make sure that no persons, animals or objects are in the path of your vehicle.

- ▶ Make sure that you maintain a suitable distance to the vehicle and that neither you nor other road users could be endangered.

- ▶ Be aware of the vehicle's surroundings at all times and identify possible dangers.
- ▶ If necessary, cancel the parking procedure.

No persons or pets are permitted to remain in the vehicle during the parking procedure. Observe the system limits at all times. If necessary, cancel the parking procedure. Always ensure that vehicle access by other road users is maintained.

- ▶ Activate the "Remote Parking Assist" service e.g. via the Mercedes me homepage.
- ▶ Authorise the mobile phone using the Remote Parking Assist App in the vehicle (→ page 385).

Selecting the parking manoeuvre in advance while inside the vehicle

- ▶ Stop the vehicle and select transmission position **P**.

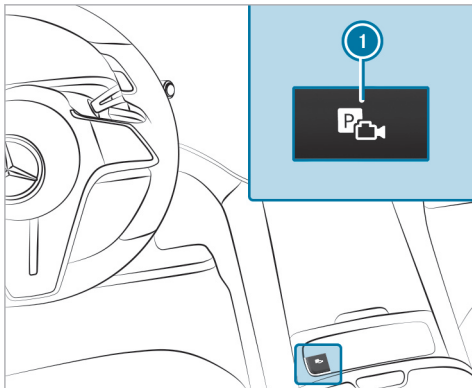

i Depending on the vehicle's equipment, button **1** may also be located at a different position in the centre console.

▶ Press button **1**.

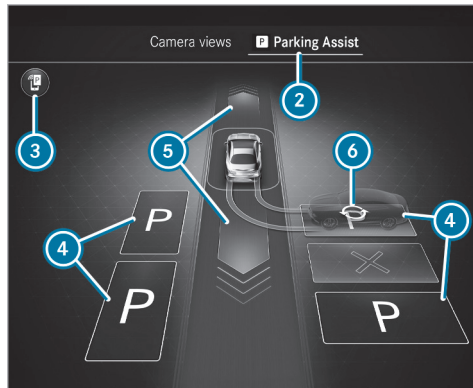

▶ Select **2** **Parking Assistance** menu.

▶ For further information on Remote Parking Assist: select **3**.

▶ If necessary, select another parking space or select **5** to drive straight ahead into a garage, for example.

▶ If necessary, change parking direction **6**.

i Alternatively, you can begin parking with Active Parking Assist (→ page 377) and continue with the Remote Parking Assist from any vehicle position. To do this, stop the parking process and adjust the gearbox setting **P**.

▶ Switch off the vehicle and exit it with the key.

Starting the parking procedure without selecting in advance

▶ Stop the vehicle and select transmission position **P**.

▶ Switch off the vehicle and exit it with the key.

Starting the parking procedure while outside the vehicle

▶ Unlock the vehicle.

Carrying out a parking procedure with Remote Parking Assist

i Keep the vehicle key with you during the parking procedure. You can cancel the parking procedure and bring the vehicle to a standstill by pressing a button on the key.

i On completion of the parking procedure, the vehicle is locked.

If you have started the parking procedure as described above, the vehicle is ready to connect to your mobile phone for a limited time.

- ▶ Start the Remote Parking Assist App on the mobile phone and connect to the vehicle.
 - ▶ Follow the instructions of the Remote Parking Assist App.
- ⓘ The turn signal indicator is automatically switched on when starting parking and switched off when it is completed.
 - ⓘ If the connection between the vehicle and the mobile phone is interrupted while a parking manoeuvre is being performed, the manoeuvre can be continued if the connection is re-established within a short time.

⚠ WARNING Risk of accident due to vehicle swinging out while parking or pulling out of a parking space

While parking or pulling out of a parking space, the vehicle swings out and can drive onto areas of the oncoming lane.

This could cause you to collide with objects or other road users.

- ▶ Pay attention to objects and other road users.
- ▶ Where necessary, stop the vehicle or cancel the parking procedure with Remote Parking Assist.

- ▶ After ending the parking procedure, ensure that all vehicle doors, windows and the boot are closed. Secure the vehicle against rolling away.

Cancelling the parking procedure

You can cancel the parking procedure of Remote Parking Assist at any time and bring the vehicle to a standstill.

- ▶ Cancel the parking procedure in the Remote Parking Assist App.
or
- ▶ Press a button on the vehicle key.
or
- ▶ Pull a door handle.

■ Authorising/de-authorising a mobile phone for Remote Parking Assist

Multimedia system:

- ▶  ▶ Settings ▶ Assistance
- ▶ Parking ▶ Remote Parking Assist

Authorising a new mobile phone

You must authorise your mobile phone to use the Remote Parking Assist function. You can authorise up to ten mobile phones.

- ▶ Select **Remote Parking Assist**.
- ▶ IN the open window select **Authorise a new device**.
Remote Parking Assist is ready to connect.
- ▶ Start the Remote Parking Assist App and additionally start the authorisation process.
A connection prompt is displayed.
- ▶ Scan the QR code on the central display.
The mobile phone is authorised.

De-authorising mobile phones

- ▶ Select **Remote Parking Assist**.
- ▶ In the opened window, select the device to be deauthorised.

- ▶ **To de-authorise a mobile phone:** Select a mobile phone and confirm with **Yes**.
The mobile phone is deleted from the device list.
- ▶ **To de-authorise all mobile phones:** Select **Deauthorise all devices** and confirm with **Yes**.
All mobile phones are deleted from the device list.

Manoeuvring assistant

Function of Drive Away Assist

Drive Away Assist can reduce the severity of an impact when pulling away. If the system detects an obstacle in the direction of travel, the vehicle's speed is briefly reduced to approximately 2 km/h.

A risk of collision may occur in the following situations, for example:

- If the driver mixes up the accelerator and brake pedals.
- If the driver engages an incorrect gear.
- If the driver depresses the accelerator pedal with too much force.

Drive Away Assist is active under the following conditions:

- If the vehicle was stationary, the transmission position was changed to **R** or **D**.
- If the vehicle has rolled less than approximately 1.0 m since being at a standstill.
- If the detected obstacle is less than approx. 1.0 m away.

The **Drive-away Assist** can be deactivated or activated in the **Manoeuvring assistance** menu (→ page 389).

If a critical situation is detected, the  symbol appears in red in the selected view in the menu **Camera & parking**.

i If the Drive Away Assist is not available, the  symbol appears in grey. If the **Camera & parking** menu is not open in the central display, the symbol appears together with the PARKTRONIC parking assistant pop-up.

Drive Away Assist is only an aid. It is not a substitute for your attention to your surroundings. The responsibility for safe manoeuvring and parking

remains with you. Ensure that no persons, animals, objects, etc., are in the manoeuvring range.

▲ WARNING Risk of accident caused by limited detection performance of Drive Away Assist

Drive Away Assist cannot always clearly identify objects and traffic situations.

- ▶ Always pay careful attention to the traffic situation; do not rely on Drive Away Assist alone.
- ▶ Be prepared to brake or swerve as necessary, provided the traffic situation permits and that it is safe to take evasive action.

System limits

The system limits of Active Parking Assist apply (→ page 375).

On uphill gradients, the performance of Drive Away Assist is restricted.

If a transport device, e.g. trailer or bicycle carrier is attached to the hitch, and the electrical con-

nection is correctly established. The drive-away assistance is not available when reversing.

■ Function of cross traffic warning

The cross-traffic warning can warn you of crossing traffic when exiting a parking space. The radar sensors in the bumper also monitor the area adjacent to the vehicle.

The cross traffic warning is active under the following conditions:

- **Warning for crossing traffic behind:** the vehicle is driving in reverse at speed slower than approx. 10 km/h.
- **Warning for crossing traffic ahead:** the vehicle is driving forwards at speed slower than approx. 10 km/h and the camera image is shown in the central display (→ page 370).

The **Warning for crossing traffic ahead** can be deactivated or activated in the **Manoeuvring assistance** menu.

Depending on the country, the **Warning for crossing traffic behind** can also be deactivated or activated (→ page 389).

If a critical situation is detected, the  symbol appears in red in the selected view in the menu **Camera & parking**.

Warning for crossing traffic behind

- The vehicle can be braked automatically when crossing traffic is detected.
- If the **Camera & parking** menu is not opened and a critical situation is detected, a warning appears in the central display together with the PARKTRONIC Parking Assist pop-up.

Warning for crossing traffic ahead

- If Active Parking Assist is active, the vehicle can be braked automatically when crossing traffic is detected.
- A warning appears if Active Parking Assist is not active, but the menu **Camera & parking** is open.
- If the menu **Camera & parking** is not open, the system cannot react to crossing traffic.

The cross-traffic warning is only an aid, not a substitute for your attention to the surroundings. The responsibility for safe manoeuvring and parking

remains with you. Ensure that no persons, animals, objects, etc., are in the manoeuvring range.

⚠ WARNING Risk of accident caused by limited detection performance of the cross traffic warning

The cross traffic warning cannot always clearly identify objects and traffic situations.

- ▶ Always pay careful attention to the traffic situation; do not rely on the cross traffic warning alone.
- ▶ Be prepared to brake or swerve as necessary, provided the traffic situation permits and that it is safe to take evasive action.

System limits

i If the cross traffic warning is not available, the  symbol appears in grey.

The system limits of Active Parking Assist apply (→ page 375).

Detection is impossible if the radar sensors are obstructed by vehicles or other objects.

In the following situations, the cross traffic warning is not available:

- on inclines
- **Warning for crossing traffic behind:** if a transport device, e.g. trailer or bicycle carrier is attached to the hitch, and the electrical connection is correctly established.

Manoeuvring brake function



The manoeuvring brake function can prevent collisions with pedestrians when the vehicle reverses at slow speeds. If the reversing camera detects a person in the vehicle's path, the vehicle can be braked to a standstill.

The manoeuvring brake function can intervene under the following conditions:

- The vehicle is reversing at a speed slower than 10 km/h.
- The camera image is shown in the central display (→ page 370).

Depending on the country, you can activate and deactivate the manoeuvring brake function in the **Manoeuvring assistance** menu (→ page 389)

When a marshalling brake is triggered, the symbol  appears in red in the selected view in the menu **Camera & parking**.

 If the shunt braking is not available, the symbol  appears in grey.

The manoeuvring brake function is only an aid. It is not a substitute for your attention to your surroundings. The responsibility for safe manoeuvring and parking remains with you. Ensure that no persons, animals, objects, etc., are in the manoeuvring range.

 **WARNING** Risk of accident caused by limited detection by the manoeuvring brake function

The manoeuvring brake function cannot always clearly detect people. Other obstacles are not detected by the function.

In these cases, the function may brake unnecessarily or not brake at all.

 Always pay careful attention to the traffic situation; do not rely on the manoeuvring brake function alone.

 Be ready to brake.

System limits

Observe the system limits of the following functions:

- Active Parking Assist (→ page 375)
- 360° Camera (→ page 366)
- Reversing camera (→ page 364)

The manoeuvring brake function is not available in the following situations:

- on inclines
- If transport equipment, for example, a trailer or bicycle rack, is attached to the trailer hitch and the electrical connection has been correctly established.

■ Activating/deactivating manoeuvring assistance

Multimedia system:

→  ► Settings ► Assistance
►► Parking

- ⓘ This function is an on-demand feature (→ page 75).
- ⓘ The Activating/deactivating Manoeuvring assistance function is not available in all countries.
- Select **Manoeuvring assistance**.
- Activate or deactivate the desired manoeuvring assistance.

Memory Parking Assist

■ Function of Memory Parking Assist

Memory Parking Assist can park your vehicle using a previously stored parking space. You can store parking procedures with a total distance of up to 500 m (100 m per parking or exiting procedure).

During parking or exiting, the system can travel a previously stored path of up to approximately 100 m to or out of the desired parking space, for example, from the driveway entrance into the garage.

Within a radius of approx. 150 m, only one parking or exiting procedure can be recorded.

Only use Memory Parking Assist on private property. Use on public roads, e.g. in public parking spaces is not permitted.

Memory Parking Assist is only an aid. It is not a substitute for your attention to your surroundings. The responsibility for safe manoeuvring and parking remains with you. Ensure that no persons, animals, objects, etc., are in the manoeuvring range.

System limits

Observe the system limitations of Active Parking Assist (→ page 375).

⚠ WARNING Risk of accident due to objects located above or below the detection range of Memory Parking Assist

If there are objects above or below the detection range, the following situations may arise:

- Memory Parking Assist may steer too early.
- The vehicle may not stop in front of these objects.

This result in a collision.

► In these situations, do not use Memory Parking Assist.

Objects located above or below the detection range of Memory Parking Assist may not be detected during the parking procedure.

Drawbars of parked trailers may not be detected, among other objects that protrude into the parking space.

Do not use Memory Parking Assist in the following situations, for example:

- In extreme weather conditions such as ice, packed snow or heavy rain.
- When transporting a load that protrudes beyond the vehicle.
- If the parking space is on a steep downhill or uphill gradient.
- When snow chains are fitted.

You can watch an animation on this topic via the following link:

Recording a parking procedure using Memory Parking Assist

Requirements

- The entire route is, for example, within your property and not on public roads.
- The system needs reference points in the surroundings to orient itself, such as fences, walls or trees. Therefore, a certain distance must first be driven after starting the vehicle. If not enough reference points are detected in the

surrounding area, no new route can be recorded.

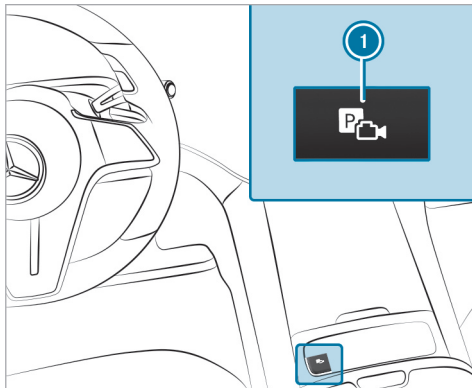

- ▶ Press the button **1**. The **Camera & parking** view opens on the central display.



- ▶ Select **2** **Memory Parking Assist** menu.
- ▶ Brake the vehicle to a standstill at the desired starting point of the assisted parking procedure, e.g. a driveway entrance.
- ▶ **Start recording:** Tap on **3**.
- i** If not all conditions for a recording are met, symbol **3** is greyed out.

- ▶ Park the vehicle in the desired parking space. Do not exceed 8 km/h.
- ▶ **Stop recording:** Stop the vehicle and tap ③ again. The recording is stored.
- ① You can delete and rename stored parking procedures in the Memory Parking Assist settings.

■ Parking with Memory Parking Assist

Requirements

- A parking procedure has been recorded.

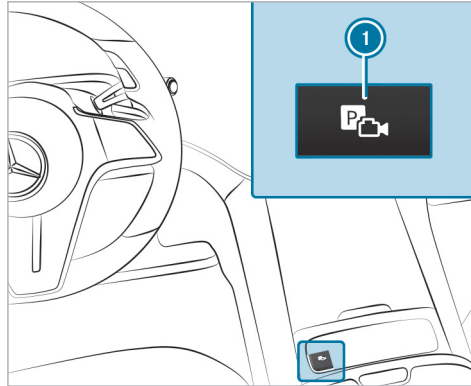

- ▶ Press the button ①. The **Camera & parking** view opens on the central display.



- ▶ Select **Memory Parking Assist** ② menu.
- ▶ Brake the vehicle to a standstill at the starting point of the stored parking procedure.
- ▶ **To start the parking procedure:** press .
- ▶ Select the stored parking procedure from the list.

- ▶ Follow the instructions on the central display. The vehicle drives into the selected parking space.

i The turn signal indicator is not switched on automatically. You are responsible for selecting the turn signal indicator following the traffic conditions.

- ▶ After completion of the parking procedure, safeguard the vehicle against rolling away.

Exiting a parking space with Memory Parking Assist

Requirements

- The exiting procedure was recorded with the respective parking procedure and stored separately within one driving cycle.
- The vehicle was parked using Memory Parking Assist.

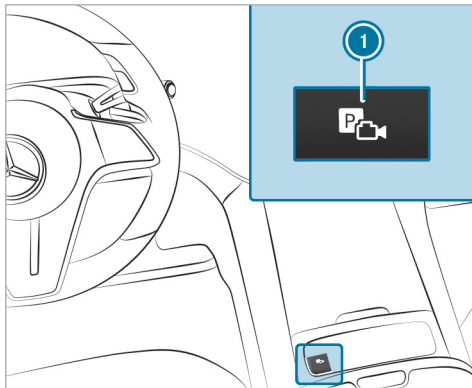

- ▶ Press the button **1**. The **Camera & parking** view opens on the central display.



- ▶ Select **Memory Parking Assist 2** menu.

Starting the exiting procedure

- ▶ Press **▶**.
- ▶ Confirm the saved exiting procedure.
- ▶ Follow the instructions on the central display. The vehicle drives the recorded route.

 The turn signal indicator is not switched on automatically. You are responsible for selecting the turn signal indicator following the traffic conditions.





 Take control of the vehicle after the exiting procedure has been completed.

Setting Memory Parking Assist



Multimedia system:

 **Settings** **Assistance**
Parking **Memory Parking Assist**

Renaming a recording

-  Select **Memory Parking Assist**.
-  Select  next to the desired recording.
-  Enter a name and confirm with **OK**.

Deleting a recording

-  Select **Memory Parking Assist**.
-  Select  next to the desired recording. The selected recording will be deleted.

Deleting all recordings

-  Select **Memory Parking Assist**.

 Select **Delete all tracks**.

 Alternatively, you can delete all data in Memory Parking Assist by resetting the multimedia system (→ page 467).

Trailer hitch

Notes on trailer operation

 **NOTE** The operating permit may be invalidated due to the illegal installation of trailer hitches



The installation – including retrofitting – of a non-folding or non-removable trailer hitch that even partially conceals the license plate or the lighting system is prohibited.

 Observe the applicable legal regulations for the installation of trailer hitches.

 **WARNING** Risk of accident due to car/trailer combination swerving

If you drive too fast in trailer operation, the car/trailer combination may start to swerve.

This could cause you to lose control of the car/trailer combination. The car/trailer combination may even overturn.

-  Under no circumstances should you try to straighten the car/trailer combination by increasing your speed.
-  Reduce the speed and do not counter-steer.
-  Brake if necessary.

Retrofitting a trailer hitch is permissible only if a trailer load is specified in your vehicle documents. If this is not the case, the vehicle is not approved for trailer operation.

Further information can be obtained at a qualified specialist workshop.

Observe the following notes on the tongue weight:

- Do not use a tongue weight that exceeds or falls below the permissible tongue weight
- Use a tongue weight as close as possible to the maximum tongue weight

Do not exceed the following values:

- Permissible towing capacity
- Permissible rear axle load of the towing vehicle
- Permissible gross weight of the towing vehicle
- Permissible gross weight of the trailer
- Maximum permissible speed of the trailer

Ensure the following before starting a journey:

- The tyre pressure on the rear axle of the towing vehicle is set for a maximum load
- The lighting of the connected trailer is operational

In the event of increased rear axle load, the car/trailer combination must not exceed a maximum speed of 100 km/h for reasons concerning the operating permit. This also applies in countries in which the permissible maximum speed for car/trailer combinations is above 100 km/h.

Vehicles with AIRMATIC: If the socket of the trailer hitch is occupied, e.g. by a trailer or rear bicycle rack, the vehicle will be set to the normal level at

speeds greater than 30 km/h, regardless of the drive program.

Folding the ball neck out and in

⚠ WARNING Risk of accident due to the ball neck not being engaged

If the ball neck is not engaged, the trailer may come loose.

- ▶ Always engage the ball neck as described.

⚠ WARNING Risk of injury from ball neck swinging outwards

The ball neck may swing outwards when unlocking or when it has not been properly engaged.

There is a risk of injury within the ball neck's range of movement!

- ▶ Unlock the ball neck only when its range of movement is unobstructed.

- ▶ Always be sure the ball neck is engaged when folding inwards.

! NOTE Increased risk of damage to property due to folded-out ball neck

- ▶ When the trailer is not coupled or the bicycle rack is attached, fold in the ball neck or, in the case of a fully electric trailer hitch, retract the ball neck.

! NOTE Damage to the vehicle due to incorrect use of the trailer hitch

If a trailer hitch is used to recover the vehicle, the vehicle or the trailer hitch itself may be damaged in the process.

- ▶ Use the trailer hitch only for pulling a trailer or attaching approved carrier systems (e.g. a bicycle rack).
Exception: Since vehicles with a trailer hitch do not have a fixture for a towing eye at the rear, towing or tow-starting is permitted.

- ▶ When towing or tow-starting with the trailer hitch, observe the information in the section "Fitting and removing the towing eye."

Folding the ball neck out

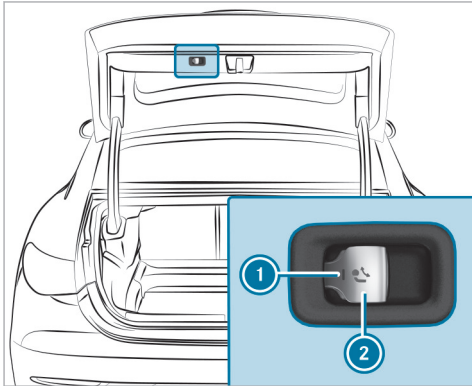

- ▶ Secure the vehicle against rolling away.
- ▶ Keep the swivel range clear.

- ▶ Remove the trailer cable or adapter plug.
- ▶ Pull switch ② until the ball neck unlocks. The ball neck will fold out from under the rear bumper.

Indicator lamp ① will flash.

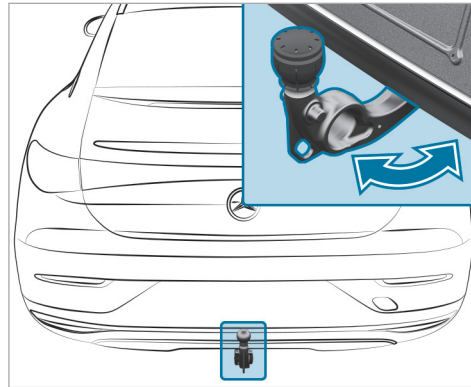

- ▶ Pull the ball neck in the direction of the arrow until it engages audibly in a vertical position. Indicator lamp ① on the ball neck release switch will go out.

If the ball neck is not securely locked in place, a message reading **Trailer coupling Check lock** will appear on the driver's display.

- ▶ Remove the cover cap from the ball head and store it in a safe place.

Make sure that the ball on the ball neck is clean. Check that it is either greased or dry (grease-free), depending on the instructions for the trailer.

Folding the ball neck in

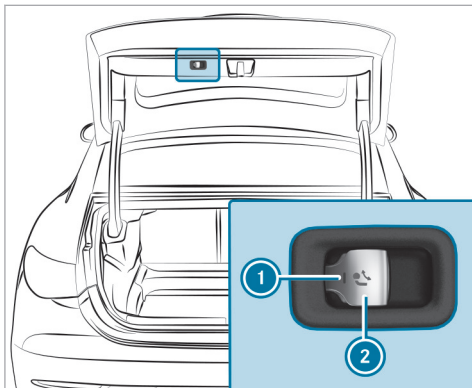

- ▶ Pull switch ② until the ball neck unlocks. The ball neck will fold up under the rear bumper.

Indicator lamp ① will flash.

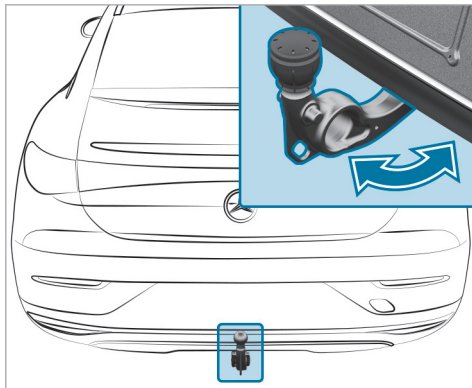

- ▶ Push the ball neck in the direction of the arrow until it engages audibly behind the bumper. Indicator lamp ① will go out and the message on the driver's display will disappear.

Observe the information about indicators on the driver's display:

- Indicator and warning lamps (→ page 858)
- Display messages (→ page 770)

F295 0041 02

Coupling up/uncoupling a trailer

- ⚠ **WARNING** Risk of injury due to a change in vehicle level

Vehicles with AIRMATIC: the vehicle level may be changed unintentionally, e.g. by other persons. If you couple or uncouple the trailer during this time, you may become trapped. In addition, other people could become trapped if their limbs are between the vehicle body and the tyres or underneath the vehicle.

Observe the following when coupling or uncoupling:

- ▶ Do not open or close any doors or the boot lid.
- ▶ Do not initiate the level control system and do not operate DYNAMIC SELECT.
- ▶ Do not lock or unlock the vehicle.

The trailer will be correctly detected by the vehicle only if the following conditions are met:

- The ball neck is extended and engaged in a securely locked position.

- **Vehicles with AIRMATIC:** ensure the vehicle is at the normal level (→ page 358).

Use the normal level in trailer operation. High-level driving is not permitted in trailer operation on public roads.

Trailers with a 7-pin plug can be connected to the vehicle with the following adapters:

- Adapter plug
- Adapter cable

The trailer will be correctly detected by the vehicle only if the following conditions are met:

- The trailer is connected correctly.
- The trailer lighting system is in working order.

A correctly connected trailer influences, among other things, the functions of the following systems:

- ESP® trailer stabilisation
- Active Lane Keeping Assist
- Parking Assist PARKTRONIC
- Active Parking Assist
- Blind Spot Assist or Active Blind Spot Assist

- Drive Away Assist
- Cross traffic warning
- Manoeuvring brake function
- Reversing camera
- 360° camera
- AIRMATIC

Coupling up a trailer

! **NOTE** Damage to the starter battery due to full discharge

Charging the trailer battery using the power supply of the trailer can damage the starter battery.

▶ Do not use the vehicle's power supply to charge the trailer battery.

- ▶ Secure the vehicle against rolling away.
- ▶ Remove the cover cap from the ball head and store it in a safe place.
- ▶ Position the trailer on a level surface behind the vehicle and couple it up to the vehicle.



- ▶ Open the socket cap.
- ▶ Insert the plug with lug 1 into groove 3 on the socket.
- ▶ Turn bayonet coupling 2 to the right as far as it will go.
- ▶ Let the cap engage.
- ▶ Secure the cable to the trailer with cable ties (only if you are using an adapter cable).
- ▶ Make sure that the cable is always slack for ease of movement during cornering.

In the following circumstances, a message may appear on the driver's display even if the trailer has been connected correctly:

- LEDs have been installed in the trailer lighting system.
 - The current has fallen below the trailer lighting system's minimum current (50 mA).
- i** Accessories can be connected to the permanent power supply up to 180 W and to the power supply that is switched on via the ignition lock.

Uncoupling a trailer

⚠ WARNING Risk of being crushed and becoming trapped when uncoupling a trailer

When uncoupling a trailer with an engaged inertia-activated brake, your hand may become trapped between the vehicle and the trailer drawbar.

- ▶ Do not uncouple trailers with an engaged overrun brake.

! **NOTE** Damage during uncoupling with an engaged overrun brake

The vehicle may be damaged if you uncouple with an engaged overrun brake.

- ▶ Do not uncouple trailers with an engaged overrun brake.

⚠ WARNING Risk of becoming trapped when disconnecting the trailer cable

Vehicles with AIRMATIC: the vehicle may lower when you disconnect the trailer cable.

This could result in other people becoming trapped if their limbs are between the vehicle body and the tyres or underneath the vehicle.

- ▶ Make sure nobody is underneath the vehicle or in the immediate vicinity of the wheel arches when you disconnect the trailer cable.

- ▶ Secure the vehicle against rolling away.
- ▶ Disconnect the electrical connection between the vehicle and the trailer.

- ▶ Uncouple the trailer.
- ▶ Place the cover cap on the ball head.

i **Trailers with LED lighting:** after uncoupling the trailer, switch the vehicle on and then off again.

Making settings for trailer operation

Multimedia system:

- 
[Settings](#)

[Vehicle](#)

[Driving](#)

[Trailer type](#)

Making settings for a trailer

- ▶ Select the desired trailer type.
- ▶ Enter the maximum permissible speed of the selected trailer.
- ▶ **To save changes:** select **Confirm**.

Bicycle rack function

⚠ WARNING Risk of an accident if the bicycle rack is used incorrectly

The bicycle rack may become detached from the vehicle in the following cases:

- the permissible load capacity of the trailer hitch is exceeded.
- the bicycle rack is used incorrectly.
- the bicycle rack is secured to the ball neck beneath the ball head.

Observe the following for your own safety and that of other road users:

- always adhere to the permissible load capacity of the trailer hitch.
- always observe the permissible rear axle load of the towing vehicle.
- use the bicycle rack only to transport bicycles.

- always mount the bicycle rack properly by attaching to the ball head and the ball neck guide pin, if possible.
- when transporting four bicycles, always use bicycle racks that have additional support on the ball neck guide pin.
- use only bicycle racks approved by Mercedes-Benz.
- always observe the bicycle rack operating instructions.

⚠ NOTE Damage to or breakage of the trailer hitch due to unsuitable or improperly used bicycle rack.

▶ Only use bicycle racks approved by Mercedes-Benz properly as described below.

⚠ NOTE Increased risk of damage to property due to folded-out ball neck

▶ When the trailer is not coupled or the bicycle rack is attached, fold in the ball

▶ neck or, in the case of a fully electric trailer hitch, retract the ball neck.

⚠ NOTE The operating permit may be invalidated due to the illegal installation of trailer hitches

The installation – including retrofitting – of a non-folding or non-removable trailer hitch that even partially conceals the license plate or the lighting system is prohibited.

▶ Observe the applicable legal regulations for the installation of trailer hitches.

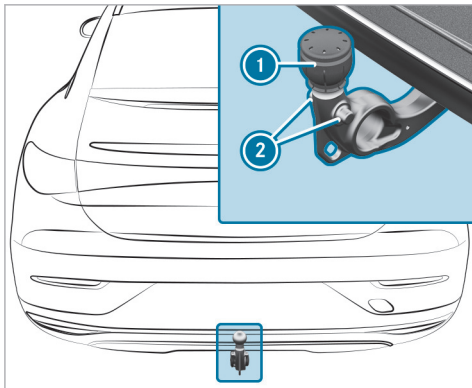

Trailer hitch with additional guide pin

Depending on the bicycle rack's design, different numbers of bicycles can be transported.

The following bicycle rack designs are possible:

- When mounted by attaching to ball head ①, the maximum load capacity is 75 kg. You can transport up to three bicycles.

- When mounted on ball head ① and guide pin ②, the maximum load capacity is 100 kg. You can transport up to four bicycles.

The maximum load capacity is calculated from the weight of the bicycle rack and the bicycle rack load.

Observe the notes on driving with a roof load, trailer or fully laden vehicle (→ page 257).

When using a bicycle rack, set the tyre pressure for increased load on the rear axle of the vehicle. Further information on the tyre pressure can be found in the tyre pressure table (→ page 629).

Notes on loading

The larger the distance between the load's centre of gravity and the ball head, the greater the load on the trailer hitch.

Observe the following notes:

- mount heavy bicycles as close to the vehicle as possible
- always distribute the load on the bicycle rack as evenly as possible across the vehicle's longitudinal axis

Mercedes-Benz recommends removing all detachable parts from bicycles (e.g. baskets, child seats, rechargeable batteries) before loading them onto the bicycle rack. This will improve the aerodynamic resistance and centre of gravity of the bicycle rack.

Always secure the bicycles to prevent them from moving around and check them at regular intervals to ensure that they are secure.

Do not use tarpaulins or other covers. The handling and rear view may be impaired. In addition, aerodynamic resistance and the load on the trailer hitch will increase.

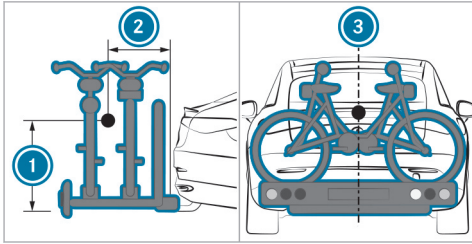

Load distribution on the bicycle rack

- ① Vertical distance between centre of gravity and ball head
- ② Horizontal distance between centre of gravity and ball head
- ③ The centre of gravity is on the vehicle's centre axis.

Observe the following information when loading the bicycle rack:

Loading the bicycle rack

	3 bicycles	4 bicycles
Total weight of bicycle rack and load	Up to 75 kg	Up to 100 kg
Max. distance ①	420 mm	420 mm
Max. distance ②	300 mm	400 mm

When transporting four bicycles or a total weight between 75 kg and 100 kg, always use bicycle racks with additional support on both trailer hitch guide pins.

Vehicle towing instructions

The vehicle is not suitable for the use of tow bar systems that are used for flat towing or dinghy towing, for example. Attaching and using tow bar systems may result in damage to the vehicle. When you are towing a vehicle with tow bar systems, safe driving characteristics cannot be guar-

anteed for the towing vehicle or the towed vehicle. The vehicle-trailer combination may swerve from side to side.

Observe the following information:

- Permitted towing methods (→ page 618)
- The notes on towing the vehicle with both axles on the ground (→ page 50)

Notes on the driver's display

⚠ WARNING Risk of accident if the driver display fails

If the driver display has failed or is malfunctioning, function restrictions in systems relevant to safety cannot be detected.

The operating safety of your vehicle may be impaired.

- ▶ Drive on carefully.
- ▶ Have the vehicle checked immediately at a qualified specialist workshop.

If the operating safety of your vehicle is impaired, park the vehicle immediately and safely. Contact a qualified specialist workshop.

The driver's display shows the following basic information:

- Speed and power meter level
- Range according to average consumption, personal driving style or high-consumption driving style
- State of charge of the high-voltage battery

- Indicator and warning lamps

Additional functions available include the following:

- Different menus, e.g. for assistance and navigation
- Status displays for the driving systems
- Display messages

Some menu content and settings can be customised (→ page 405).

Notes on the range

The range in general

- All ranges shown are assumptions based on various calculation bases. The actual range achieved may differ from the range displayed.
- Outside temperatures, climate control settings, vehicle interior temperatures, road conditions, driving style etc. directly influence the achievable range.
- Pay attention to the charging prompts at all times.

Range according to personal driving style

- Your previous personal consumption will be taken into account when the range is being calculated.
- While the navigation system or commuter route is active, additional information about the route ahead can be included in the range calculation.

Range with low consumption

- The maximum range shows the potential range when consumption is low, e.g. as a result of economical driving or having the air conditioning system turned off.

Range with high consumption

- The minimum range shows the range when consumption is high, e.g. as a result of a sporty driving style or having the air conditioning system turned on.
- This range is determined based on past and current consumption figures.

Electric energy consumption

- The **From start** and **From reset** consumption figures take into account all active consumer equipment when it comes to the drive system's operational readiness **READY**.
- i** If the range maximisation function is switched on, the range on the speedometer may increase depending on the potential range (→ page 264).

Operating the driver's display

⚠ WARNING Risk of distraction from information systems and communications equipment

If you operate information systems and communication devices integrated in the vehicle when driving, you could be distracted from the traffic situation. This could also cause you to lose control of the vehicle.

- ▶ Only operate this equipment when the traffic situation permits.

▶ If you cannot be sure of this, stop the vehicle whilst paying attention to road and traffic conditions and operate the equipment with the vehicle stationary.

Observe the legal requirements for the country in which you are currently driving when operating the driver's display.

Scrolling on the menu bar

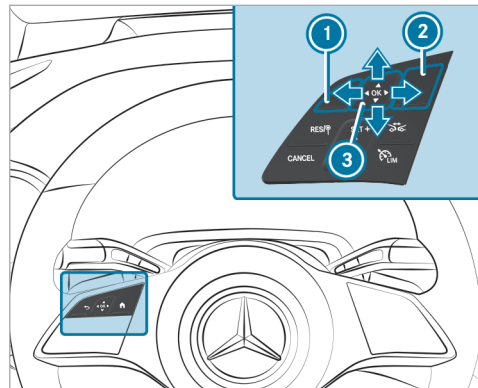

- ① Back button
- ② Main menu button
- ③ Touch Control

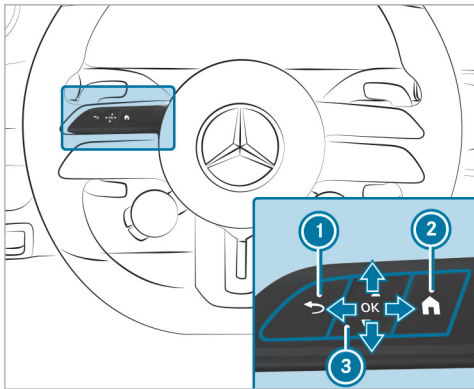

Mercedes-AMG vehicles

- ① Back button
- ② Main menu button
- ③ Touch Control

The content on the driver's display is controlled using the control elements on the left side of the steering wheel. You can use Touch Control ③ to navigate vertically and horizontally by swiping with

one finger. Confirm your selection by pressing the Touch Control.

① To operate Touch Control ③ in the most effective way, use the tip of your thumb if possible. You can also set the sensitivity of the Touch Control on the central display (→ page 438).

- ▶ Briefly press main menu button ②.
- ▶ Select a menu by swiping to the left or right on Touch Control ③.
- ▶ **To confirm:** press Touch Control ③.

You can watch an animation on this topic via the following link:

Driver display menus

Notes on menus on the driver's display

⚠ WARNING Risk of distraction from information systems and communications equipment

If you operate information systems and communication devices integrated in the vehicle when driving, you could be distracted from the traffic situation. This could also cause you to lose control of the vehicle.

- ▶ Only operate this equipment when the traffic situation permits.
- ▶ If you cannot be sure of this, stop the vehicle whilst paying attention to road and traffic conditions and operate the equipment with the vehicle stationary.

Observe the legal requirements for the country in which you are currently driving when operating the driver's display.

The following menus can be called up via the menu bar on the driver's display:

- **Understated**
- **Sport**
- **Classic**
- **Navigation**
- **Assistance**
- **Service**
- Mercedes-AMG vehicles: **Supersport**
- Mercedes-AMG vehicles: **TRACK PACE**

On some of these menus, you can choose between different display content on the centre display area.

On most of the menus, you can use **Options** to configure further settings for the menu-specific display content.

You can watch an animation on this topic via the following link:

Calling up and operating menus on the driver's display

Calling up a menu via the driver's display menu bar

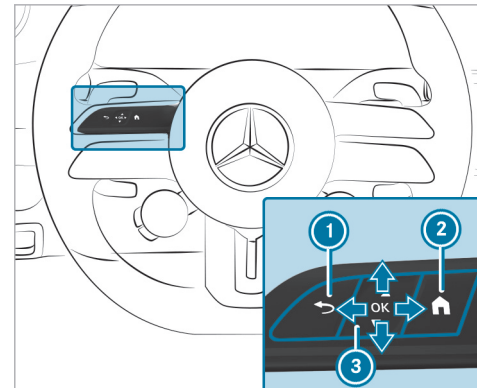
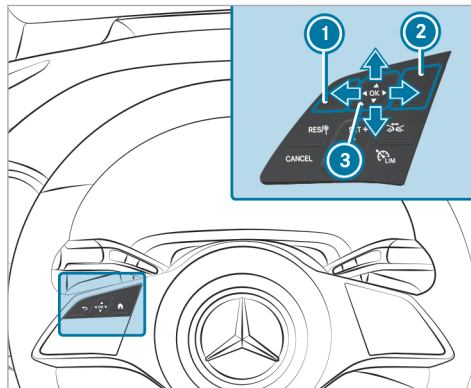

Mercedes-AMG vehicles

- ① Back button
- ② Main menu button
- ③ Touch Control

- ▶ Press main menu button ② on the steering wheel.
The driver's display menu bar will open.



Mercedes-AMG vehicles

- ▶ Swipe to the left or right on left-hand Touch Control **3** and select a menu (e.g. the **Classic** menu) on the menu bar.

- ▶ **To confirm:** press left-hand Touch Control **3**.

Calling up or exiting the **Options** submenu

- ▶ **To call up:** press left-hand Touch Control **3**.
- ▶ **To exit:** press back button **1**.

Browsing through display content or lists

- ▶ Swipe up, down, left or right on left-hand Touch Control **3**.
- i** Within different menus, icons will also appear at the right edge of the centre display section to indicate the current position on a list.

Setting display content as the standard display

You can set custom-configured menu display content as the standard display.

- ▶ Press and hold left-hand Touch Control **3** until the bar display is completely filled. The **Set direct entry?** prompt will appear.
- ▶ Swipe left on left-hand Touch Control **3** and select **Yes**.
- ▶ **To confirm:** press left-hand Touch Control **3**.
- ▶ **To call up standard displays:** press back button **1** on the upper level of a menu.

- i** Pressing back button **1** on the standard display will call up the previous menu.

Resetting values

- ▶ **To call up the Options submenu:** press left-hand Touch Control **3**.
- ▶ Select **Yes**.
- ▶ **To confirm:** press left-hand Touch Control **3**.

Configuring settings on the Classic or Understated menus

Driver's display:

→ Classic

Selecting display content in the centre display section of the **Classic** menu

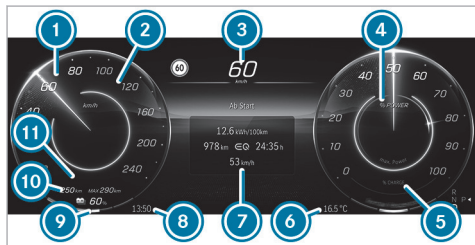

- ① Speedometer
- ② Recommended maximum speed when range monitoring and route guidance are active
- ③ Digital speedometer
- ④ Display range of the output

- ⑤ Display range of recuperated power (recuperation)
- ⑥ Outside temperature
- ⑦ Centre display content (example: trip computer)
- ⑧ Time
- ⑨ Charge level display
- ⑩ Range with low consumption (→ page 402)
- ⑪ Range according to personal driving style (→ page 402)

Depending on the vehicle equipment, the following display content will be shown in centre display area ⑦:

- Trip and total distance
- Distance **From start** and **From reset**
- ECO display
- Range trend display
- Current consumption
- ATTENTION ASSIST
- Audio

- Navigation (with changing navigation instructions)

The following values are shown in trip computer display content ⑦:

- Distance covered in electric mode
- Electric energy consumption
- Driving time
- Average speed

▶ Swipe upwards or downwards on the left-hand Touch Control and select the desired display content.

Observe the following notes on the **Classic** menu:

- Recommended maximum speed ② ensures that the destination is reached with active route guidance. The state of charge that is desired and entered is taken into account. If it becomes necessary to limit the vehicle's speed to reach the destination safely with the specified state of charge, the recommended maximum speed will be displayed on the speedometer. A message will also appear on the driver's display.

Please note that despite recommended maximum speed ②, the maximum permissible speed must not be exceeded.

- Display ⑤ will change when intelligent recuperation is activated (→ page 261).

Changing the radio station or track on the station or track list

You can change radio stations or tracks on the station or track list in the audio display content.

The following functions can be used in the MBUX multimedia system:

- Configuring the radio station and track lists.
- Switching between tracks
- Setting the frequency band

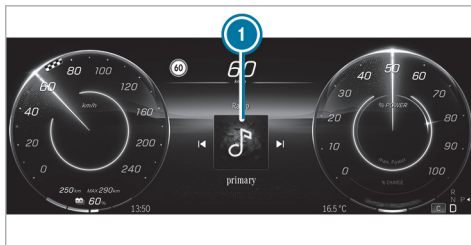

Track list for the audio display content in the centre display section (example)

- ▶ **To change radio stations or tracks:** swipe left or right on the left-hand Touch Control and select a radio station or track on station or track list ①.

① The radio station or track displayed when the vehicle is started depends on the user profile used on the previous trip.

The following functions may be available on the **Options** submenu, for example:

- Navigation: selecting and adjusting zoom, route guidance and map settings

- Resetting the trip odometer
- Resetting the trip computer **From start**
- Resetting the trip computer **From reset**
- Resetting the ECO display values

Changing colour settings on the **Understated** menu

- ▶ Call up the **Understated** menu via the driver's display menu bar.
- ▶ **To call up the colour list:** press the left-hand Touch Control.
- ▶ **To select colour settings:** swipe upwards or downwards on the left-hand Touch Control and select the desired colour setting.
- ▶ Press the left-hand Touch Control to confirm.
- ▶ **To exit the colour list:** press the back button .

- ① Depending on the equipment, the selected colour adjustment will be adopted for the ambient lighting and the MBUX multimedia system. When you select the **Understated** menu on the driver's display, the content in the MBUX multimedia system will also be reduced.

Calling up the Service menu

Driver's display:

↪ **Service**

The current status of the vehicle is shown on the **Service** menu.

▶ **To call up the menu:** press the left-hand Touch Control.

The following display content is available on the **Service** menu (equipment-dependent):

- Information about how many messages are in the message memory
- **Tyre pressure:**
 - Check the tyre pressure with the tyre pressure monitor (→ page 631)

- Restart the tyre pressure monitor (→ page 631)
- **ASSYST PLUS:** calling up the service due date (→ page 594)
- Mercedes-AMG vehicles: temperature display (high-voltage battery, front and rear high-voltage motors)

The following functions are available on the **Options** submenu:

- Tyre pressure (→ page 631)
- Message memory (→ page 770)

Calling up the assistant display (Assistance menu)

Driver's display:

↪ **Assistance**

Various driver assistance systems and navigation instructions are shown on the assistant display.

▶ **To call up the display:** select **Assistance** on the driver's display.

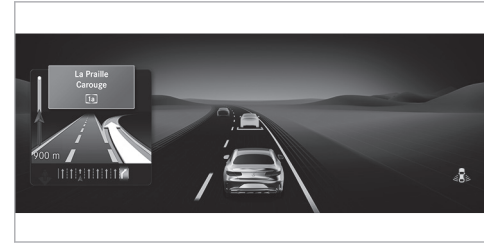





Active Distance Assist DISTRONIC display on the assistant display (example)

The following displays may vary depending on the driving situation:

- The navigation instructions in the left-hand display section
- The traffic light view in the right-hand display section
- The display of the driver assistance systems
- The level of detail on the assistant display

The following status displays are available on the assistant display:

-  Green: pedestrian detection active
-  Grey: pedestrian detection enabled
-  Green radar waves next to vehicle: Active Blind Spot Assist is enabled and ready for operation
-  Grey radar waves next to vehicle: Active Blind Spot Assist is enabled but not ready for operation

The content on the assistant display will adapt to the following situations:

- Number of lanes detected
- Change of direction, e.g. lane change
- Current road conditions
- Road users detected

-  The assistant display does not display other detected obstacles with the exception of road users.

The following functions are available on the **Options** submenu:

- Starting route guidance
- With active route guidance: end route guidance
- Call up previous destinations and favourites
- Start new route guidance to a recent destination
- Start new route guidance to a favourite

Configuring settings on the Supersport menu

Requirements

- For Mercedes-AMG vehicles only.

Driver's display:

Supersport

- ▶ **To call up the menu:** press the left-hand Touch Control.
- ▶ **To select:** swipe upwards or downwards on the left-hand Touch Control and select the desired display content.

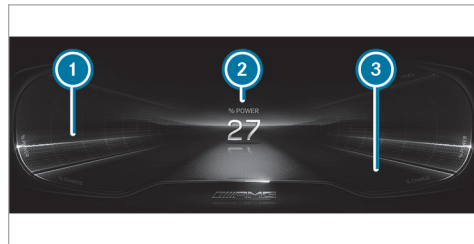

- ① Display range of the output
- ② Centre display content (example: power display)
- ③ Display range of recuperated power (recuperation)
-  The displays for output ① and recuperated power ③ are given either as percentages or as absolute values.

Centre display area ② of the **Supersport** menu shows the following display content:

- Power display (electrical drive support)
- Temperature display (high-voltage battery and front and rear high-voltage motors)

- Setup (drive, AMG DYNAMICS, suspension and sound)
- G-force
- Trip and total distance
- Distance **From start** and **From reset**
- Current consumption
- Audio
- Navigation

i Depending on the vehicle equipment, AMG-specific content regarding temperature, engine data and setup will be displayed. The settings for the setup display content can be configured either via the buttons on the multi-function steering wheel or via the MBUX multimedia system (→ page 271).

Depending on the selected display content in centre display area **2**, the following will be displayed in the outer area of the menu:

- Power display as a percentage
- Current engine output and current torque

Calling up the Track Pace menu

Requirements

- For Mercedes-AMG vehicles only.

Driver's display:

→ **TRACK PACE**

The Track Pace function is intended for use on designated race tracks. Do not use this function on public roads, and adapt your driving style to your personal capabilities and the ambient conditions.

The following options will be displayed on the **TRACK PACE** menu:

- G-meter
- Race track selected
- Braking and acceleration procedure
- Gear currently selected

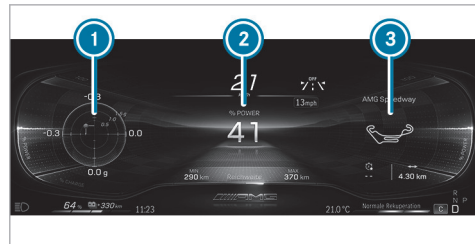

Displays on the Track Pace menu (example)

- 1** G-meter
- 2** Centre display content (example: electric drive support display)
- 3** Telemetry display (example: selected race track)

▶ To call up the menu: press the left-hand Touch Control.

The display content of the **TRACK PACE** menu will adapt to the selected settings on the central display:

- Gear display
- Electric drive support display

412 Driver's display

- Recuperated power display
- G-meter
- Braking points
- Acceleration
- Quarter-miles
- Race track selected on the central display
- Current race
- Record route

While the vehicle is in motion, the G-meter shows the forces that are exerted on the vehicle occupants both laterally and in the direction of travel. The maximum values appear in red in the coordinate system.

Calling up the Sport menu

Driver's display:



Information on electric mode is displayed on the **Sport** menu.

To call up the menu: press the left-hand Touch Control.

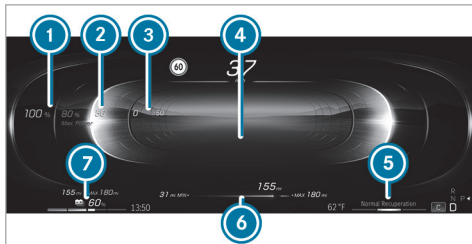

- 1 Maximum available output
- 2 Current output
- 3 Recuperative braking
- 4 G-force display
- 5 Selected recuperation level
- 6 Range trend display
- 7 State of charge of the high-voltage battery

The range indicator on the driver's display will vary depending on the menu selected.

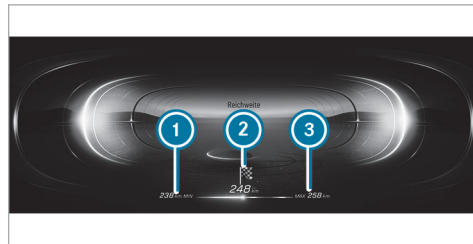

Display content for range

- 1 Range with high consumption (→ page 402)
- 2 Range according to personal driving style (→ page 402)
- 3 Range with low consumption (→ page 402)

Calling up navigation instructions on the driver's display

Driver's display:



To call up the menu: press the left-hand Touch Control.

Changing the scale of the selected map view



- ① Distance to the change of direction
 - ② Road to which the change of direction leads
 - ③ Display of traffic incident
 - ④ Currently selected route
 - ⑤ Indicator showing vehicle's current position
 - ⑥ Change-of-direction symbol
 - ⑦ Recommended lane (white)
 - ⑧ Lane not recommended (grey)
 - ⑨ Current lane
- ① The level of detail in the navigation instructions in the left-hand display section may vary.
- ▶ **To zoom in and out on the map directly:** swipe upwards or downwards on the left-hand Touch Control.
- ① If no operation is performed within a short time of the autozoom being activated, the set

map scale of the map view already selected will appear.
 You can set the permanent map scale display in the MBUX multimedia system (→ page 513).

The following functions are available on the **Options** submenu:

- With active route guidance: end route guidance
 - Select route guidance
 - **Map settings**
- ① If the current route guidance is ended on the **Navigation** menu of the driver's display, it will also be ended in the MBUX multimedia system.

On the **Options** submenu, you can use other functions in the **Destinations** and **Map settings** categories.

You can use the following functions in the **Destinations** category:

- Call up previous destinations and favourites
- Start new route guidance to a favourite

- ① The two options **Work** and **Home** will be displayed in **Favourites** even if no address is stored.

You can use the following functions in the **Map settings** category:

- Activate auto zoom
- Set the map view, satellite view and route overview.

The following map views are available on the **Navigation** menu:

- Entire route
- 2D direction of travel
- 2D north-up
- 3D map

- ① There is an additional navigation view on the front passenger display. The front passenger can thus assist the driver with route guidance (→ page 500).

Head-up display

Function of the head-up display

The head-up display projects various content into the driver's field of vision, for example.

You can use the head-up display menu bar to select various contexts, e.g.:

- Mercedes-AMG vehicles: Supersport
- Mercedes-AMG vehicles: **TRACK PACE**
- Mercedes-AMG vehicles: Race
- Minimal
- Sport
- Standard
- ECO display (depending on model and equipment) (→ page 260)
- Settings
- Head-up display on/off

Head-up display content with navigation (9x3°)

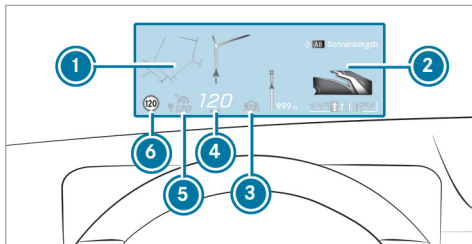

- 1 Navigation instructions
- 2 Navigation instructions (distance to the next route event)
- 3 Steer Assist status
- 4 Current speed
- 5 Speed set in the driving system (e.g. cruise control)
- 6 Detected traffic signs (Traffic Sign Assist)

When you receive a call, the  **Call waiting** message will appear on the head-up display and the driver's display.

Head-up display on the Supersport menu (AMG vehicles)

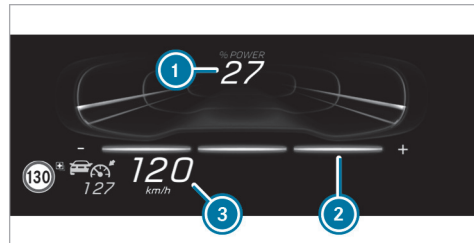

- 1 Output obtained as a percentage
- 2 Setting of the recuperation behaviour
- 3 Current speed, speed set in the driving system (e.g. cruise control), detected traffic signs (Traffic Sign Assist)

When you receive a call, the  **Call waiting** message will appear on the head-up display and the driver's display.

System limits

Visibility is particularly influenced by the following conditions:

- Seat position
- Image position setting
- Light conditions
- Wet road surfaces
- Objects on the display cover
- Polarisation in sunglasses

Operating the head-up display

Selecting display content of the head-up display via the menu bar of the driver's display

- ▶ Press the  main menu button on the left.
- ▶ **To select the menu bar of the head-up display:** swipe upwards on the left-hand Touch Control.





Switching between display content on the head-up display

- ▶ Swipe to the left or right on the left-hand Touch Control. A preview of the selected display content will appear on the head-up display.
- ▶ **To confirm:** press the  button.

Switching back to the driver's display

- ▶ Press the  or  button.

Setting the position and brightness

- ▶ Swipe to the left or right on the left-hand Touch Control and select **Settings** on the menu bar of the head-up display.
- ▶ Press the left-hand Touch Control. The current position and brightness settings will be displayed as graphics on the head-up display as well as on the driver's display.
- ▶ **To adjust the position:** swipe upwards or downwards on the left-hand Touch Control.
- ▶ **To adjust the brightness:** swipe to the left or right on the left-hand Touch Control. The settings configured for position and brightness will be saved automatically.
- ▶ Press the  or  button to exit the settings.

Switching the head-up display on/off

Driver's display:



Switching on

- ▶ Swipe upwards on the left-hand Touch Control.
- ▶ Press left-hand Touch Control .

Switching off

- ▶ Swipe upwards on the left-hand Touch Control.
- ▶ Swipe on the left-hand Touch Control and select [Head-up display](#).
- ▶ Press left-hand Touch Control .

Function of the power availability display

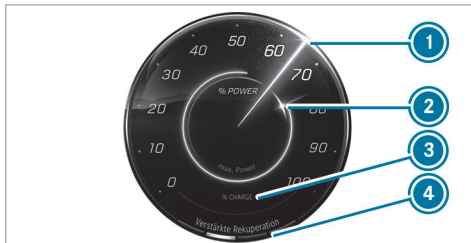

- ① Current output
- ② Available operating energy output
- ③ Recuperated energy (recuperation)
- ④ Recuperation level set

The maximum operating energy output is available in normal operating status.

In the following cases, the operating energy output available may deviate from the maximum value:

- When the outside temperatures are very high or low

- In the event of very high output requests for a longer period of time
- When the high-voltage battery's state of charge is very low
- When the drive system is malfunctioning

The values displayed serve only as orientation. The displayed operating energy output value can deviate from the actual value.



When the maximum recuperated power ③ is reached, the additional desired deceleration is set via the brake control system. Also brake with the service brake if necessary.



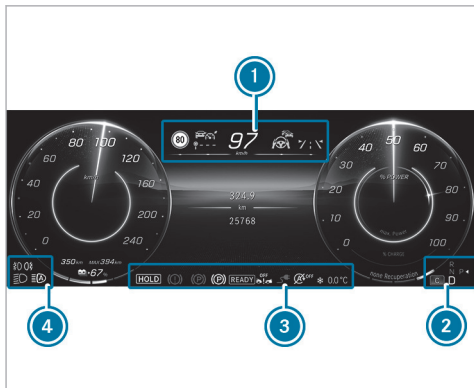











Overview of status displays on the driver's display





The status displays for the driving and driving safety systems can be found in display sections ① to ④.



i The number, positions and presentation of the status indicators on the driver's display depend on which systems are activated or deactivated.

-  Pedestrian detection (on assistant display only)
-  Active Parking Assist is available (→ page 377)

-  Active Parking Assist has recognised a parking space (→ page 377)
-  Parking Assist PARKTRONIC deactivated (→ page 375)
-  Cruise control (→ page 317)
-  Limiter (→ page 318)
-  Active Distance Assist DISTRONIC (→ page 321)
-  Specified distance for Active Distance Assist DISTRONIC (→ page 321)
-  Active Brake Assist switched off (→ page 341)
-  Active Brake Assist impaired or not functioning (→ page 341)
-  Active Steering Assist (→ page 330)
-  Active Lane Change Assist (→ page 334)
-  Active Lane Keeping Assist (→ page 354)
-  Active Blind Spot Assist (on assistant display only) (→ page 353)
-  Haptic accelerator pedal (→ page 264)
-  HOLD function (→ page 312)

-  Adaptive Highbeam Assist (→ page 220)
Adaptive Highbeam Assist Plus (→ page 222)
-  Maximum permissible speed exceeded (for certain countries only)
-  Active Stop-and-Go Assist (→ page 330)
-  Slippery road surface warning

Vehicles with Speed Limit Assist: detected instructions and traffic signs (→ page 342)



Vehicles with Traffic Sign Assist: detected instructions and traffic signs (→ page 345)



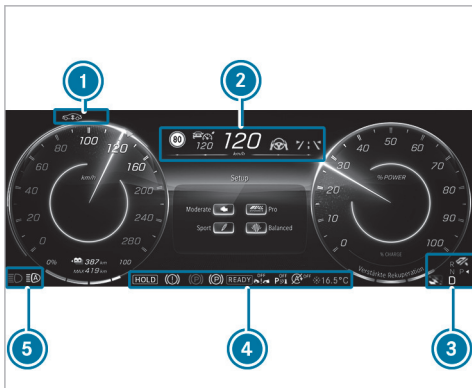











Overview of status displays on the driver's display (Mercedes-AMG vehicles)







The status displays for the driving and driving safety systems in Mercedes-AMG vehicles can be found in display sections **1** to **5**.



i The number, positions and presentation of the status indicators on the driver's display depend on which systems are activated or deactivated.

-  Pedestrian detection (only on assistant display)
-  Active Parking Assist is available (→ page 377)

-  Active Parking Assist has recognised a parking space (→ page 377)
-  Parking Assist PARKTRONIC deactivated (→ page 375)
-  Cruise control (→ page 317)
-  Limiter (→ page 318)
-  Active Distance Assist DISTRONIC (→ page 321)
-  Specified distance for Active Distance Assist DISTRONIC (→ page 321)
-  Active Brake Assist switched off (→ page 341)
-  Active Brake Assist impaired or not functioning (→ page 341)
-  Active Steering Assist (→ page 330)
-  Active Lane Change Assist (→ page 334)
-  Active Lane Keeping Assist (→ page 354)
-  Active Blind Spot Assist (only on assistant display) (→ page 353)
-  HOLD function (→ page 312)
-  Adaptive Highbeam Assist (→ page 220)

-  Adaptive Highbeam Assist Plus (→ page 222)
-  Maximum permissible speed exceeded (for certain countries only)
-  Active Stop-and-Go Assist (→ page 330)
-  Slippery road surface warning
-  AMG RIDE CONTROL + (→ page 359)
-  AMG Active Sound (→ page 265)
-  AMG DYNAMICS (→ page 267)

Vehicles with Speed Limit Assist: detected instructions and traffic signs (→ page 342)

Vehicles with Traffic Sign Assist: detected instructions and traffic signs (→ page 345)

Notes on operating safety

For your own safety, always observe the following points when operating mobile communications equipment and especially your voice control system:

- Observe the legal requirements for the country in which you are driving.
- If you use the voice control system in an emergency your voice can change and your telephone call, e.g. an emergency call, can thereby be delayed.
- Familiarise yourself with the voice control system functions before starting the journey.

i The voice control system does not replace the Owner's Manual.

The answers from the voice control system do not provide the complete scope of information contained in the Owner's Manual. The voice control system also does not give detailed warning or damage information. Therefore read the Owner's Manual so that you are fully informed about the functions and the safe operation of the vehicle.

Operation

Function of the MBUX Voice Assistant

You can watch an animation on this topic via the following link:

Using the MBUX Voice Assistant, vehicle functions and various areas of the MBUX multimedia system can be operated by voice input, e.g. Navigation or Telephone. The MBUX Voice Assistant is operational about half a minute after switching on the vehicle and can be operated from all seats (depending on the special equipment).

Conducting a dialogue

Requirements:

- Voice activation is activated in the multimedia system (→ page 420).
- For corrections during output, the **Voice barge-in** option must be activated in the multimedia system (→ page 420).

Starting a dialogue

- ▶ Say **Hey Mercedes** to activate the MBUX voice assistant.

or

- ▶ Press the  button on the multifunction steering wheel. A wave appears in the MBUX multimedia system. The dialogue can be started.

For the dialogue with the MBUX voice assistant, you can use complete sentences of colloquial language as voice commands. Voice activation can also be combined directly with a voice command, e.g. **Hey Mercedes, how warm is it outside?**

Interrupting the dialogue

- ▶ During the dialogue say **Pause**. The dialogue is interrupted.
- ▶ Say **Hey Mercedes** to continue the dialogue.

Correcting an entry

- ▶ During the dialogue say **Correction**.

or

- ▶ Interrupt the system's voice output.

Changing dialogue level

- ▶ During the dialogue, say **Back**. The MBUX voice assistant jumps back to the previous dialogue step.

- ▶ During the dialogue, say **From the beginning again**. The MBUX voice assistant jumps to the highest dialogue level.

Navigating in the selection list

If a voice command does not achieve a clear result, a selection list is shown.

- ▶ Say the line number or the content to select an entry or to have further details shown.
- ▶ Say **Next page** or **Previous page** to browse the selection list.

Calling up help

- ▶ **For information about the MBUX voice assistant:** say **Hey Mercedes, what can you do?** .
- ▶ **Current application:** say **Help**. You will receive suggestions and information about operation of the MBUX voice assistant for the current application.
- ▶ **Specific function:** call up the voice command for the required function, for example with **Hey Mercedes, I need help with the radio**.

- ▶ **Digital Owner's Manual:** say **Show me the Owner's Manual**. The full extent of the Digital Owner's Manual is available on the central display when the vehicle is stationary.

Overview of the operable functions of the MBUX voice assistant

You can use the MBUX voice assistant to operate the following functions depending on the vehicle equipment:

- Telephone
- Text message and e-mail
- Navigation
- Radio and media
- Vehicle functions
- Online functions

Full functionality of the voice control system is only available for you with activation of online voice control (→ page 420).

Information on the language setting

You can change the language of the MBUX voice assistant via the system language settings (→ page 462). If the set system language is not supported by the MBUX voice assistant, English will be selected.

Setting functions of MBUX voice assistant using the multimedia system

Multimedia system:



 ▶▶ Settings ▶▶ System
 ▶▶ Voice assistant

Switching voice activation of MBUX voice assistant on or off

- ▶ Select **Hey Mercedes**. When the function is active, the **Hey Mercedes** voice command can activate the dialogue.

Switching direct commands on or off

- ▶ Select .

- ▶ Activate or deactivate the function. If the function is active, some commands can be used without Hey Mercedes, for example Next track.

Switching voice activation for individual seats on or off

- ▶ Select .
- ▶ Switch the function for the desired seats on or off.

Switching voice interruption on or off

- ▶ Select [Further settings](#).
- ▶ Select [Voice barge-in](#). If the function is active, a command can be interjected during voice output of the system.

Switching proactivity on or off

- ▶ Select [Further settings](#).
- ▶ Select the desired situation, e.g. [Activate your profile](#) or [Don't forget your phone](#). When the function is active, the voice assistant proactively provides information in specific situations.

Activating or deactivating online voice control

- ▶  Online voice control is activated at the factory.

- ▶ Select [Online recognition](#).
- ▶ Activate or deactivate the function. If the function is activated and a Mercedes me user account is linked to the vehicle, additional results are available through the provision of external information, e.g. information on POIs. By clicking the symbol in the wave, more information about the online voice control can be displayed.

Activating or deactivating contacts for online use

- ▶ Select [Contact upload for online recognition](#). When the function is active, contacts will be found more easily and accurately using voice input.

Using MBUX voice assistant effectively

Notes on optimum use of MBUX voice assistant

- The MBUX voice assistant is operational half a minute after switching on the vehicle and can

be operated from all seats, depending on the equipment installed. The system recognises from which seat the command was spoken and performs actions according to the seat position.

- When a dialogue is ended, the MBUX voice assistant continues to be active for as long as the wave is displayed in the multimedia system. You can say another voice command without saying **Hey Mercedes**.
- Using the direct command **Change language to English**, the system language can be changed to English without **Hey Mercedes**. Direct commands must be activated for this.
- If a user profile has been stored and is active, the MBUX voice assistant can make suggestions based on the habits of the user. If the voice commands are not clear, the system selects an action. The action can be corrected with a new voice command.

Say **Hey Mercedes, load my personal profile**, to activate the profile. The user's voice must first be learned by the system and assigned to a profile.

Further information on user profiles (→ page 442).

- With the MBUX voice assistant, incoming calls can be accepted or rejected without the keyword **Hey Mercedes**.

Information on the MBUX online voice assistant

The online voice control facilitates recognition and thanks to external information makes additional results available.

Therefore, Mercedes-Benz recommends that you activate online voice control (→ page 420).

You will need a Mercedes me user account for this. If you do not yet have a user account you have to create one and connect it with your vehicle (→ page 551).

Then call up your Mercedes me user account. The Mercedes me services are shown and can be activated (→ page 551).

By clicking on the symbols displayed in the wave, further information on the online status is displayed.

When online voice control is active, additional functions are available such as:

- Weather
 - General knowledge
 - Public holidays and school holidays
 - Smarthome
 - Messages
 - Time, date and time zones
 - Pocket and currency calculator
 - Football results and fixture lists
 - Share prices
 - Calendar
 - ChitChat
 - Horoscope
 - Geo Quiz
- i** The availability of these functions is country and equipment-dependent.
- i** Text content is taken from Wikipedia in accordance with the CC BY-SA 3.0 licence.

Essential voice commands

Notes on voice commands

It is not necessary to use exact voice commands to call up a specific function. The MBUX Voice Assistant also understands you when you use your colloquial speech. Some examples are listed below. For some languages however these examples are only available to a limited extent.

Examples of voice commands:

- Navigation (→ page 422)
- Telephone (→ page 423)
- Radio and TV (→ page 423)
- Media player (→ page 423)
- Messages (→ page 423)
- Vehicle functions (→ page 424)
- Online functions (→ page 424)

Examples of navigation voice commands

You can operate the navigation system using the MBUX voice assistant. The following list offers just a small selection of the possible navigation com-

mands. You will receive additional suggestions if you say Help for navigation.

- Drive me home.
- Where is the nearest service station?
- Is there a service area along the route?
- Set Central Park as intermediate destination.
- Cancel the route guidance.
- Show my last destination.
- I want to buy juice.
- Search for a French restaurant in Manhattan.

Examples of telephone voice commands

You can operate phones connected with MBUX multimedia system the using the MBUX voice assistant. The following list offers just a small selection of the possible telephone commands. You will receive additional suggestions if you say Help for phone.

- Call Peter Miller on the mobile phone.
- Dial 07 11 17 0.
- Call my father.

- Accept call
- Reject call
- Search for the contact Peter Miller.
- Switch to address book
- Show me the incoming calls.
- Switch the phone

Examples of radio and TV voice commands

Depending on the vehicle equipment, you can operate the radio and TV using the MBUX voice assistant. The following list offers just a small selection of the possible radio or TV voice commands. You will receive additional suggestions if you say Help for radio or Help for TV.

- Play the radio station Heart FM.
- Next station.
- Previous station.
- Show me the list of radio stations
- Save the station
- What am I listening to?

Examples of media voice commands

You can operate connected media sources and online music using the MBUX voice assistant. The following list offers just a small selection of the possible media voice commands. You will receive additional suggestions if you say Help for media or Help for player.

- Play Michael Jackson.
- Play "Yellow Submarine" by the Beatles.
- Next track.
- Previous track.
- Play similar track.
- Repeat this track.
- Switch on random playback.
- Mute the music.
- Switch to USB.

Examples of message voice commands

Messages can be created, edited and listened to using the MBUX voice assistant. The following list offers just a small selection of the possible mes-

sage commands. You will receive additional suggestions if you say **Help** for messaging.

- Write a text message to Jane Doe: When will the next meeting take place?
- Show me my new e-mails.
- Write an e-mail to Jane Doe.
- Read me my new text messages.
- Show all new text messages.
- Write an e-mail to John Doe in English

Examples of vehicle voice commands

You can operate vehicle settings and vehicle functions using the MBUX voice assistant. The following list offers just a small selection of the possible vehicle voice commands.

i If no seat is mentioned for commands, the action is carried out automatically for the seat from which the command was spoken or for the function which is closest to that seat.

- Switch the seat heating to level 2.
- My feet are cold.
- Start the Refresh programme.

- Switch the massage function on.
- I would like to set the ambient light to blue
- Switch on the reading lamp.
- Open all the windows.
- Tell me my next service appointment
- How warm is it outside?
- Show me the charging options
- Select the Home charging programme.
- Set the charging limit to 80%.
- To what percentage will the battery be charged?
- Set my weekend departure time for 10 a.m..
- With how many kilowatts will the battery be charged?
- How much longer do I have to charge?

Information about the vehicle can also be requested:

- Information about individual items of the vehicle equipment
 - Hey Mercedes, which massage programmes do you have?

- Hey Mercedes, do I have Blind Spot Assist?
- Hey Mercedes, where is the warning triangle?
- Information about functioning of the systems and components installed in the vehicle
 - Hey Mercedes, what is DISTRONIC?
 - Hey Mercedes, what do I need ESP for?
 - Hey Mercedes, what is MBUX?
- Information about operating the systems and components installed in the vehicle
 - Hey Mercedes, how do I connect my smartphone?
 - Hey Mercedes, how can I turn on the main-beam headlights?
 - Hey Mercedes, how do I stop the ionization function?

Examples of online functions

Depending on the country, language and vehicle equipment, additional functions are available when online voice control is active. The system

accesses external information and can, as a result, answer general knowledge questions and make calculations, for example.

- Is the sun shining in Manchester?
- Is it raining at my location?
- What are the skiing conditions on the Zugspitze?
- What's the time in Sydney now?
- In which country do you pay with dollars?
- How many Swiss franks make 25 euros?
- How long now until the holidays?
- What day is it tomorrow?
- What is 20% of 29?
- What does my horoscope say?
- What is the price of Mercedes-Benz Group shares?
- Let's play Geo Quiz.
- I'm bored.
- Who is the current prime minister?
- What do you know about the Globe Theatre in London?

- Who painted the picture "The Scream"?
- What's the status in the Premier League?
- Create a calendar entry tomorrow at 9 am.
- What's my next task?
- Tell me a joke.
- How many languages do you speak?
- What is your favourite animal?
- Are there any updates?
- Is the light still on in the kitchen?
- Switch off all the devices in my house.
- Please set the temperature in the living room to 24 degrees.

Direct command examples

With direct commands, some functions can be operated without first saying the voice command **Hey Mercedes**. To use direct commands, the function must be activated in the multimedia system (→ page 420).

- Next TV channel
- Previous TV channel

- Next radio station
- Previous radio station
- Next station
- Previous station
- Next track
- Previous track
- Start dashcam recording
- Stop dashcam recording
- Show the map
- 3D map
- 2D map
- Align map to north
- Align map in direction of travel
- Show all routes
- Show traffic
- Navigate to work
- Navigate home
- Repeat driving instruction
- Cancel route guidance
- Change language to English

Overview and operation

Overview of the MBUX multimedia system (Mercedes-AMG vehicles)

⚠ WARNING Risk of distraction from information systems and communications equipment

If you operate information systems and communication devices integrated in the vehicle when driving, you could be distracted from the traffic situation. This could also cause you to lose control of the vehicle.

- ▶ Only operate this equipment when the traffic situation permits.
- ▶ If you cannot be sure of this, stop the vehicle whilst paying attention to road and traffic conditions and operate the equipment with the vehicle stationary.

You must observe the legal requirements for the country in which you are currently driving when operating the multimedia system.

! NOTE Increased surface temperature due to direct sunlight on the central display/ front passenger display

The surface of the display is very dark.

If the display is exposed to direct sunlight, the surface may heat up considerably.



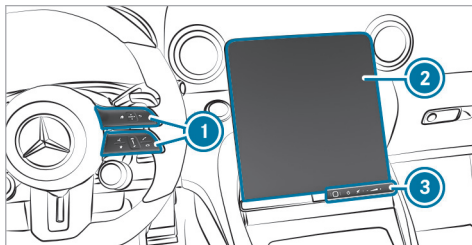

- ▶ If the display has been exposed to direct sunlight, allow it to cool down before touching it for a longer period of time.



Example: Vehicles with central display

- ① Touch Control and control panel for the MBUX multimedia system



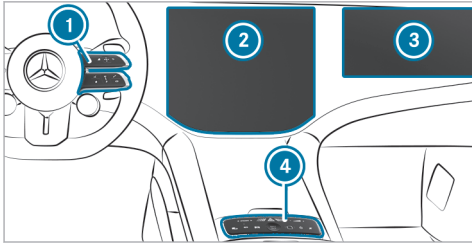

MBUX stands for Mercedes-Benz User Experience.

- Operating Touch Control (→ page 437)
- ② Central display with touch functionality
 - Overview of the Zero Layer (→ page 432)
 - Calling up and operating the Zero Layer (→ page 434)
 - Home screen overview (→ page 437)
 - Operating the touchscreen (→ page 438)
- ③ Switch panel with:
 -  Fingerprint sensor
 -  Switches the MBUX multimedia system on or off, switches the central display off
 -  Switches sound on or off
 -  Adjusts the volume



Example: Vehicles with MBUX Hyperscreen

- ① Touch Control and control panel for the MBUX multimedia system
 - Operating Touch Control (→ page 437)
- ② Central display with touch functionality for the driver
 - Overview of the Zero Layer (→ page 432)
 - Calling up and operating the Zero Layer (→ page 434)
 - Home screen overview (→ page 437)
 - Operating the touchscreen (→ page 438)
- ③ Front passenger display with touch functionality
- ④ Switch panel with:

-  Fingerprint sensor
-  Switches the MBUX multimedia system on or off
-  Switches sound on or off
-  Adjusts the volume

- ① To connect the passenger's mobile phone to the MBUX multimedia system, a QR code is shown in front passenger display ③. If possible, the QR code should be scanned with the mobile phone when the vehicle is stationary, e.g. after entering the vehicle.
- ① Alternatively, the MBUX voice assistant allows voice dialogue. Operation with natural speech starts after the wake-up call "Hey Mercedes" (→ page 419). You can start a voice navigation, for example, with the input of a 3 word address from what3words.

Numerous application, online services, services and apps are available for you.

In the zero layer, entertainment sources as well as telephone, active applications and suggestions are directly available to you. You can conveniently call up and add your favourites using the 

button on the steering wheel. Quick-access in the home screen and in the applications serve to select functions more quickly.

If you use the learning function of the multimedia system, phone numbers dialled during operation, active massage programmes or vehicle functions are suggested to you. Suggestions are displayed on the zero layer based on context and your user behaviour. The configuration of the suggestions is completed in the system settings. You can compile your user profile from various vehicle settings and settings of the multimedia system. Some functions and services are protected by a PIN. You can teach in biometric procedures to identify yourself with these instead of the four-digit Mercedes me PIN.

The Notifications Centre collects incoming notifications, e.g. about an available software update. Depending on the type of notification it offers various actions. The call is made via the Control Center.

With the global search, you can search on the home screen via categories, e.g. in the navigation, and on the Internet.

Anti-theft protection

This device is equipped with technical provisions to protect it against theft. More detailed information about anti-theft protection can be obtained at a qualified specialist workshop.

Front passenger display (only vehicles with MBUX Hyperscreen)

⚠ WARNING Risk of accident and injury due to distraction when the driver is looking at the front passenger display

If you look at the front passenger display while driving, you may be distracted from the traffic. This could also cause you to lose control of the vehicle. The front passenger display is intended exclusively for the front passenger.

- ▶ Keep the actual traffic situation constantly in view.
- ▶ Avoid looking at the front passenger display while driving.

The front passenger display is an additional touchscreen specifically for the front passenger.

Requirements for displaying content on the front passenger display while driving:

- The passenger is sitting on the passenger seat.
- The driver camera is switched on (→ page 458).

In the status line of the central display is shown as a  white symbol.

- The driver camera detects the driver's head and line of sight.

It displays content from the MBUX multimedia system independently of the central display. Depending on the application, operation is independent of the driver. Depending on the market, extended content, e.g. playback of media content, is also available while driving.

For the playback of certain content on the front passenger display, e.g. moving images, the pairing of Bluetooth® headphones is necessary.

If the driver keeps their eyes on the front passenger display for too long, content, e.g. moving images, will be hidden. An intelligent, camera-based blocking concept is used for this purpose.

- ① When the vehicle is parked, the front passenger can use the front passenger display under the following conditions:
 - The passenger is sitting on the passenger seat.
 - There is interaction with the MBUX multimedia system.

If the driver has left the vehicle briefly, e.g. to go shopping, the front passenger display can also be operated.

- ① If no front passenger is present, a digital decorative image can be shown on the front passenger display (→ page 458).

Overview of the MBUX multimedia system

⚠ WARNING Risk of distraction from information systems and communications equipment

If you operate information systems and communication devices integrated in the vehicle when driving, you could be distracted from the

traffic situation. This could also cause you to lose control of the vehicle.

- ▶ Only operate this equipment when the traffic situation permits.
- ▶ If you cannot be sure of this, stop the vehicle whilst paying attention to road and traffic conditions and operate the equipment with the vehicle stationary.

You must observe the legal requirements for the country in which you are currently driving when operating the multimedia system.

! **NOTE** Increased surface temperature due to direct sunlight on the central display/ front passenger display

The surface of the display is very dark.



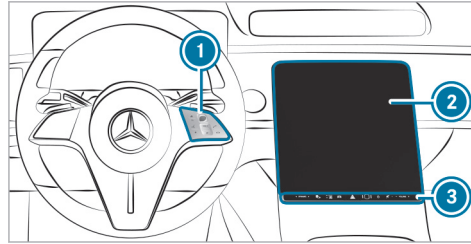

If the display is exposed to direct sunlight, the surface may heat up considerably.

- ▶ If the display has been exposed to direct sunlight, allow it to cool down before touching it for a longer period of time.



Vehicles with central display



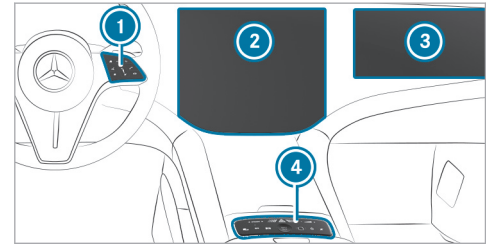

- ① Touch Control and control panel for the MBUX multimedia system
MBUX stands for Mercedes-Benz User Experience.
 - Operates Touch Control (→ page 437)
- ② Central display with touch functionality
 - Overview of the zero layer (→ page 432)
 - Calls up and operates the zero layer (→ page 434)
 - Home screen overview (→ page 437)
 - Operates the touchscreen (→ page 438)
- ③ Switch panel with:

-  Fingerprint sensor
-  Switches the MBUX multimedia system on or off, switches the central display off
-  Switches sound on or off
-  Adjusts the volume



Vehicles with MBUX Hyperscreen

- ① Touch Control and control panel for the MBUX multimedia system
 - Operates Touch Control (→ page 437)
- ② Central display with touch functionality for the driver
 - Overview of the zero layer (→ page 432)

- Calls up and operates the zero layer (→ page 434)
 - Home screen overview (→ page 437)
 - Operates the touchscreen (→ page 438)
- ③ Front passenger display with touch functionality
 - ④ Switch panel with:
 -  Fingerprint sensor
 -  Switches the MBUX multimedia system on or off, switches the central and front passenger displays on or off
 -  Switches sound on or off
 -  Adjusts the volume
 - ① Various MBUX multimedia system apps offer the option of linking via QR code. Scan this QR code with your mobile phone before starting the journey.
 - ① Alternatively, the MBUX voice assistant allows voice dialogue. Operation with natural speech starts after the wake-up call "Hey Mercedes" (→ page 419). You can start voice navigation, for example, with the input of a three-word address from what3words.

Numerous application, online services, services and apps are available for you. These can be called up via the home screen.

In the zero layer, entertainment sources as well as telephone, active applications and suggestions are directly available to you. You can conveniently call up your favourites using the  button on the steering wheel. Quick-access in the home screen and in the applications serve to select functions more quickly.

If you use the learning function of the multimedia system, phone numbers dialled during operation, active massage programmes or vehicle functions are suggested to you, for example. Suggestions are displayed on the zero layer based on context and your user behaviour. The configuration of the suggestions is completed in the system settings. You can compile your user profile from various vehicle settings and settings of the multimedia system. Some functions and services are protected by a PIN. You can teach in biometric procedures to identify yourself with these instead of the four-digit Mercedes me PIN.

The Notifications Centre collects incoming notifications, e.g. about an available software update.



Depending on the type of notification it offers various actions. The call is made via the Control Centre.

With the global search, you can search on the home screen via categories, e.g. in the navigation, and on the internet.

Front passenger display (only vehicles with MBUX Hyperscreen)

 **WARNING** Risk of accident and injury due to distraction when the driver is looking at the front passenger display

If you look at the front passenger display while driving, you may be distracted from the traffic. This could also cause you to lose control of the vehicle. The front passenger display is intended exclusively for the front passenger.

-  Keep the actual traffic situation constantly in view.
-  Avoid looking at the front passenger display while driving.

The front passenger display is an additional touchscreen specifically for the front passenger.

Requirements for displaying content on the front passenger display while driving:

- The front passenger is sitting on the front passenger seat.
- The driver camera is switched on (→ page 458).

In the status line of the central display is shown as a  white symbol.

- The driver camera detects the driver's head and line of sight.

It displays content from the MBUX multimedia system independently of the central display. Depending on the application, operation is independent of the driver. Depending on the market, extended content, e.g. playback of media content, is also available while driving.

If the driver keeps their eyes on the front passenger display for too long, content, e.g. moving images, will be hidden. An intelligent, camera-based blocking concept is used for this purpose.

- ⓘ When the vehicle is parked, the front passenger can use the front passenger display under the following conditions:
 - The front passenger is sitting on the front passenger seat.
 - There is interaction with the MBUX multimedia system.

If the driver has left the vehicle briefly, e.g. to go shopping, the front passenger display can also be operated.

- ⓘ If no front passenger is present, a digital decorative image can be shown on the front passenger display (→ page 458).

Anti-theft protection

This device is equipped with technical provisions to protect it against theft. More detailed information about anti-theft protection can be obtained at a qualified specialist workshop.

Zero layer

Function of the zero layer

The zero layer provides you with dynamic content from the MBUX multimedia system and is used to quickly access and control the applications you use. When you select  on the central display, the digital map with the applications appears in the lower display area. Compared to the home screen with a classic menu, the steps required to call up the applications are reduced. You can switch between the zero layer and the home screen with a classic menu.

The applications can be hidden from the display area and shown again.

The zero layer provides the following modules and applications:

- EQ module and navigation module

The EQ module is always shown on the digital map. In the expanded view, charging settings and navigation functions are offered.
- Entertainment (media, radio) and telephone

When the lower display area is shown, the entertainment sources are always displayed.

A mobile phone must be connected to the MBUX multimedia system for the phone to be displayed.

- Active applications

The lower display area shows an active message programme, for example.

- Suggestions

Suggestions are displayed on the lower display area based on context and your user behaviour. Here are a few examples:

- Latest calls
- Active message programs
- Vehicle functions
- Online voice applications

- Online voice applications

In the lower display area, context-dependent services that can be executed via voice are available for direct access.

The applications are first displayed in a reduced view. By tapping on them, you can operate them or open the associated menu (expanded view).

A long press on a suggestion opens a context menu in which further functions are available.

The learning function can be switched on and off for the options (→ page 463).

■ Overview zero layer

Digital map and user-specific applications (example)

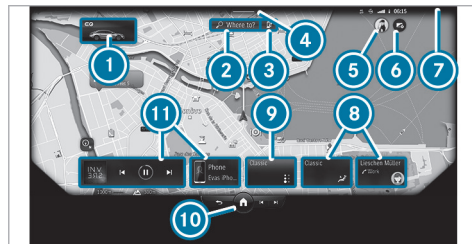

- ① EQ module (reduced view)
- ② Enters a destination (→ page 30)
- ③ Searches for a charging station
- ④ Calls up the Control Centre: pull the bar down
- ⑤ Calls up user profile settings

- ⑥ Content sharing menu (→ page 449)
- ⑦ Status line
- ⑧ Suggestions
Requirement: suggestions are activated (→ page 463).
- ⑨ Active application, e.g. message programme
- ⑩  Press briefly: displays all applications and the global search (→ page 434)
Press and hold: calls up the home screen with classic menu (→ page 437)
- ⑪ Entertainment sources (media, radio) and telephone
Requirement for phone: the mobile phone is connected to the MBUX multimedia system.

The zero layer shows the digital map and the user-specific applications.

The following user-specific applications are displayed in the lower display area:

- Suggestions ⑧
- Active applications ⑨
- Entertainment sources and telephone ⑪

- Online voice applications

The lower display area can be hidden and shown (→ page 434).

Information about entertainment sources

You can operate the applications in the reduced view or in the menu (expanded view) (→ page 434).

Examples:

- Control a media source, e.g. pause/play, next track, set a station
- Select tracks from the current playlist or stations from the station list
- Select a media source

The media source must be connected to the MBUX multimedia system.

Information about the telephone

To use the functions, your mobile phone must be connected with the MBUX multimedia system.

Requirement for suggestions: the [Calls & messages](#) option is activated in the suggestions.

Examples:

- Answer a call and call a missed call
The missed calls are displayed for the mobile phone currently connected to the MBUX multimedia system.
- Display contacts and call list and call a contact
- Use voice functions
- Suggest contacts
The contacts are suggested for the mobile phone connected to the MBUX multimedia system. No contacts are suggested for a mobile phone that is linked to another user profile.
- Write messages to contacts (suggestion)
- Connect a device via the device manager (suggestion)

Information about active applications

The following functions are available:

- Operating the massage programme
- Operating an ENERGIZING COMFORT programme

- Raising or lowering the vehicle level

Suggestions for comfort and vehicle functions as well as navigation

Requirement: the [Comfort](#), [Vehicle](#) and [Navigation](#) options are activated in the suggestions.

- Operating the massage programme
For example, the multimedia system suggests a programme at a certain time.
- Operating an ENERGIZING COMFORT programme
- Opening the tailgate
Requirement: the vehicle is equipped with boot lid convenience closing.
- Opening and closing the convenience doors
Requirement: the vehicle is equipped with comfort doors.
- Setting the vehicle level
- Making heating settings
- Activating/deactivating Parking Assist PARKTRONIC
- Selecting previous destinations and destinations from favourites

Suggestions for online voice applications

Requirement: the **Online voice services** option is activated in the suggestions.

The suggested voice applications are made available online and are based on your previous voice inputs.

Examples:

- What will the weather be like tomorrow?
- Play the messages.
- Start geoquiz.
- Open the garage door.

Calling up and operating the zero layer

Calling up the zero layer



When the vehicle has been switched on, the zero layer is displayed with the digital map. Navigation is active.

▶ **From another application:** press the  button on the right side of the steering wheel.

or

▶ Tap on .

Operating applications in the reduced view (examples)

▶ **Media:** to play the previous or next track, tap  or .

▶ **To answer a call or call a missed call:** tap on the contact.
After the connection has been established, the call functions are available.

▶ **To end a call:** tap on the contact again.

▶ **To reply to message:** tap on a message and dictate the message via the MBUX Voice Assistant.

▶ **To start a relaxation programme:** tap on the application and start the relaxation programme.

▶ **To select a previous destination:** tap on the application and select one of the previous destinations.

▶ **To select a destination from the favourites:** tap on the application and select the destination.

Hiding and showing the display area with applications

▶ **To hide:** pull the applications down.

▶ **To show:** pull the bar above  upwards.
or

▶ Select .

or

▶ Press the  button on the steering wheel on the right.

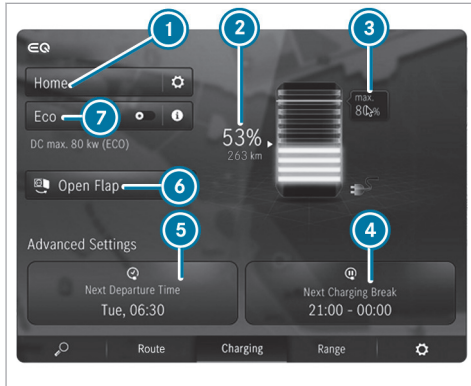

EQ module (expanded view)



- 1 Setting the charging program (→ page 296)
- 2 Current state of charge of the high-voltage battery
- 3 Maximum state of charge (depending on the setting)
- 4 Sets the next charging break (to use a less expensive tariff)

- 5 Sets the departure time
- 6 Opens the socket flap
- 7 Activates or deactivates ECO charging

▶ Tap on the EQ module (→ page 432). The charging settings are displayed. Additional EQ and navigation functions are available in the lower menu bar:

- Symbol  Enters a destination (→ page 30)
- **Route**
The route shows charging stops and the destination.
- **Range**
Switches range maximisation on or off (→ page 264).
- **Consumption**
The current and average fuel consumption will be displayed.
- Symbol  Makes settings for **View**, **Messages & tones** and **Route**.

▶ To close the menu: select .

Navigation module (expanded view)

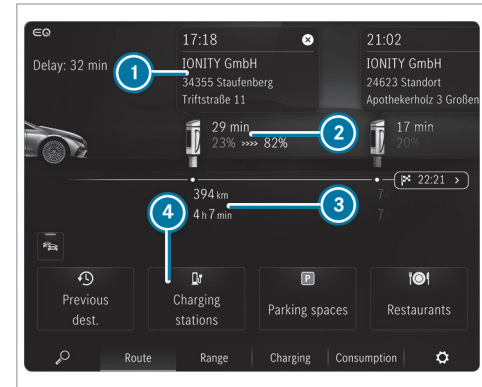



Example: navigation module with active route guidance

- 1 Arrival time at charging stop, type of charging station

- ② Charging stop shows the charging time recommended by the Navigation with Electric Intelligence as well as states of charge on arrival and onward journey for an optimal travel time
 - ③ Distance from current vehicle position and remaining driving time
 - ④ Searches for an additional charging station
- ▶ Tap on the EQ module (→ page 432).
 - ▶ Select **Route** in the lower menu bar.

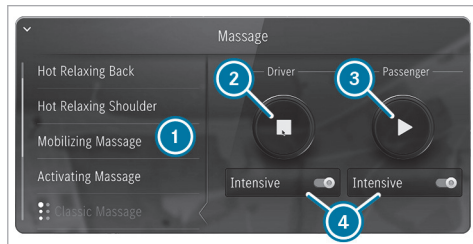
Operating a menu in the lower display area (example: active massage programme)



- ① Selecting a massage programme
 - ② Starts/stops a massage programme for the driver
 - ③ Starts/stops a massage programme for the front passenger
 - ④ Sets the massage programme intensity for the driver's or front passenger seat
- ▶ Tap on the application. The expanded view of the application is displayed.
 - ▶ **To close the menu:** select .



Opening and closing the context menu for a suggestion

- ▶ Press and hold on a suggestion. The context menu opens and shows the **Do not suggest** option, for example.
- ▶ **To close:** swipe downwards.



Removing a suggestion from the display area

- ▶ Swipe the suggestion upwards.

Showing all applications

- ▶ Press  briefly. Available applications are displayed. The global search is available.
- ▶ **To hide applications:** briefly press  again.



Switching between zero layer and home screen with classic menu

- ▶ Long press on . The home screen with classic menu is shown.
- ▶ **To return to the zero layer:** press and hold on .

Home screen overview



- ① Displays in the status line
 - ② Calls up user profile settings and switches user
 - ③ Calls up the Control Centre: pull the bar down
 - ④ Calls up favourites
 - ⑤ Displays in the status line
 - ⑥ Displays further applications
 - ⑦ Calls up an application
 - ⑧ Quick-access to application
 - ⑨ Global menu
-  Calls up previous menu

-  Press and hold: switches between home screen and zero layer
-  Previous track or previous radio station
-  Next track or next radio station

i During a telephone call, the call duration is displayed in global menu ⑨.

Alternatively, to switch between the home screen and the zero layer, press and hold the  button on the steering wheel on the right.

The following functions are called up in the Control Centre:

- Notifications Centre
- Content sharing menu
- Favourites
- Vehicle quick-access

Touch Control

Operating Touch Control (MBUX multimedia system)

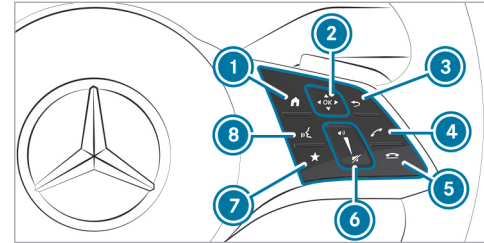

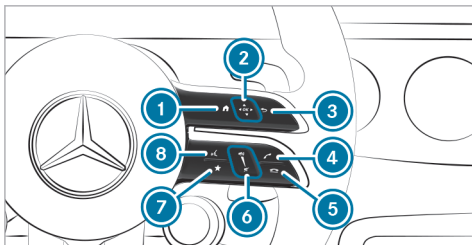

Mercedes-AMG vehicles

- ① Shows zero layer/home screen
- ② Touch Control
 - Swipe in the direction of the arrow (navigate)
 - Press (confirm)
- ③ Returns to the previous display
- ④ Makes or accepts a call
- ⑤ Rejects or ends a call
- ⑥ To increase volume: swipe upwards
To reduce volume: swipe down
 - To switch off the sound: press

- ⑦ Calls up favourites
- ⑧ Starts the MBUX voice assistant

① To operate Touch Control ② in the most effective way, use the tip of your thumb if possible.

You can navigate through menus and lists via the touch-sensitive surface of Touch Control ② using a **single-finger swipe**, for example:

- ▶ **To enter a character:** select a character using the keyboard and press on Touch Control ②.
- ▶ **To select a menu option:** scroll in a list and press Touch Control ②.
- ▶ **To move the digital map:** swipe in any direction.

Setting the sensitivity for Touch Control

Multimedia system:

- ▶ Settings System
- ▶ Control elements
- ▶ Touch Control sensitivity
- ▶ Select **Fast**, **Medium** or **Slow**.

Setting acoustic operational feedback for all control elements

Multimedia system:

- ▶ Settings System
- ▶ Control elements Acoustic feedback

The function is supported by the selection in a list.

- ▶ Set **Off**, **Unleaded** or **Loud**.
If the function is activated you will hear a clicking sound when selecting control elements or when scrolling in a list. When the beginning or end of the list is reached you will hear another clicking sound.

Touchscreen

Operating the touchscreen

Tapping

- ▶ **To select a menu item or entry:** tap on a symbol or an entry.
- ▶ **To increase the map scale:** tap twice quickly with one finger.
- ▶ **To reduce the map scale:** tap with two fingers.

- ▶ **To enter characters with the keypad:** tap on a button.

Single-finger swipe

- ▶ **To navigate in menus:** swipe up, down, left or right.
- ▶ **To move the digital map:** swipe in any direction.
- ▶ **To use handwriting to enter characters:** write the character with one finger on the touchscreen.

Two-finger swipe

- ▶ **To zoom in and out of the map:** move two fingers together or apart.
- ▶ **To enlarge or reduce the size of a section of a website:** move two fingers together or apart.
- ▶ **To turn the map:** turn anti-clockwise or clockwise using two fingers.

Three-finger swipe

- ▶ **To call up the home screen:** swipe up with three fingers in an application.

Touching, holding and moving

- ▶ **To move the map:** touch the touchscreen and move your finger in any direction.
- ▶ **To set the volume on a scale:** touch the touchscreen and move the finger to the left or right.

Touching and holding

- ▶ **To save the destination in the map:** touch the touchscreen and hold until a message is shown.
- ▶ **To call up a global menu in the applications:** touch the touchscreen and hold until the **Options** menu appears.

Setting haptic operation for the touchscreen

Multimedia system:

- ➔  ➔ **Settings** ➔ **System**
- ➔ **Control elements** ➔ **Touch & feel disp.**

- ▶ Set **Off**, **Unleaded** or **High**.
If the function is switched off, all you need to do is tap the display to make an entry.
If the function is switched on, the entry is made by pressing the display. The system sup-

ports you with discreet tactile aids and pressure resistances.

- ⓘ You can operate the function on the MBUX Hyperscreen for the central and front passenger display.

Overview of the fingerprint sensor

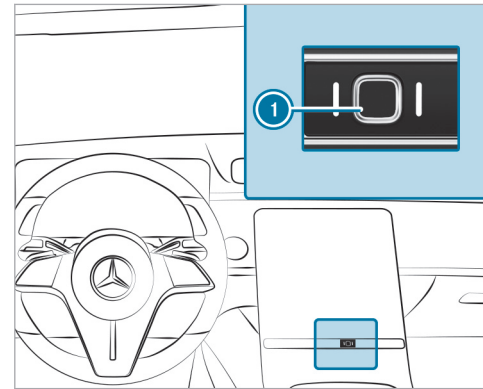

Equipment with central display

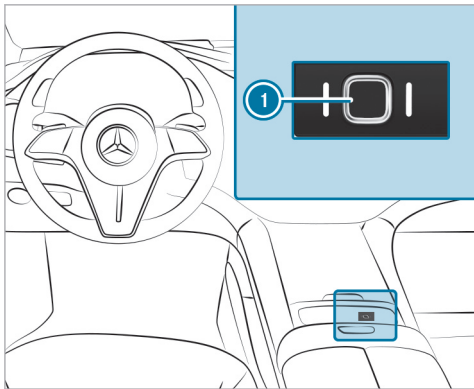

Equipment with MBUX Hyperscreen

Fingerprint sensor ① allows you to conveniently access protected MBUX multimedia system functions and services. Compared to protection provided by the Mercedes me PIN, the entry of a four-digit number is not required to activate services and functions with personal content.

The fingerprint sensor must be set up before use (→ page 442).

If equipped with a front passenger display, one fingerprint can be scanned in for the driver's seat and one for the front passenger seat. These fingerprints are then assigned to the respective seat. They can be used for authentication or to activate your own user profile on the assigned display.

- ① The fingerprint sensor stores only a data model and no image of the fingerprint. The data model is only processed in the vehicle and is not transmitted from the vehicle.

User

Notes on user profiles

⚠ WARNING Risk of becoming trapped during adjustment of the driver's seat after calling up a driver profile

Selecting a user profile may trigger an adjustment of the driver's seat to the position saved under the user profile. You or other vehicle occupants could be injured in the process.

- ▶ Make sure that when the position of driver's seat is being adjusted using the mul-

timedia system, no people or body parts are in the seat's range of movement.

If there is a risk of someone becoming trapped, immediately stop the adjustment process by:

- ▶ a) Pressing the warning message on the central display.

or

- ▶ b) Pressing a position button of the memory function or a seat adjustment switch in the driver's door.

The adjustment process is stopped.

The driver's seat is equipped with an anti-entrapment feature.

If the driver's door is open, the driver's seat will **not** be set after calling up the driver's profile.

Overview of user profiles

Requirements for use

- You have a Mercedes me user account.
- You have a Mercedes me PIN.
- You have agreed to the terms of use.

- The vehicle is linked to a Mercedes me user account.
- i** If one of the pre-requisites listed is missing or if no user profile has been selected, the data described in the following section will be saved in the vehicle as the standard setting. Standard settings can be changed by all vehicle users.

User profiles save personal settings. If the vehicle is used by several people, a person can change their profile settings without changing the settings of other users.

You can individualise a user profile in the vehicle using the set-up assistant or using the settings in your user profile. Some settings, e.g. the Mercedes me PIN and a profile photo are made in the Mercedes me App or in the Mercedes me Portal.

- i** If the user profile is downloaded while travelling, user profiles are not set up using the set-up assistant.

User-specific content and applications with personal data are protected by different levels of security (→ page 442).

To access protected content, the Mercedes me PIN and, depending on the vehicle equipment, biometric sensors are used.

- i** The security level is set by the multimedia system and calculated from the combination of all sensor inputs. Some security levels cannot be turned off.
- i** When a user profile is activated, the following personalised comfort systems, for example, can be adjusted or their settings loaded:
- Seat
 - Ambient light
 - Outside mirrors
 - Roller blinds
 - Climate control settings

If the user profile is activated when driving, the driver's seat position will not be adjusted.

User-specific content

Depending on the vehicle equipment you can, as a user, save the following settings, for example:

- Driver's seat, steering wheel and mirror settings

- Climate control
- Ambient light
- Radio (including station list)
- Suggestions and favourites

You can watch an animation on this topic via the following link:

Adding a user

Requirements

- The vehicle is stationary.

Multimedia system:



- ▶ Select **+** Add user.
A QR code is loaded.
- ▶ Scan the displayed QR code with the Mercedes me App or any QR code scanner on a mobile device. If the Mercedes me App is not yet installed on your mobile device, you will be directed to the store of your mobile device.

▶ Follow the steps in the Mercedes me App. The vehicle is connected with your Mercedes me user account. This automatically creates your user profile in the vehicle.

You will be informed when your user profile is available.

When the vehicle is stationary, the set-up assistant starts automatically after user selection.

ⓘ When the user has been added, they can be selected (→ page 444).

■ Selecting user options

Multimedia system:

▶  ▶  ▶ Settings

■ Protecting user-specific content and applications

If you add a new user, access protection is already activated for the user profile. The Mercedes me PIN and, depending on the vehicle equipment, biometric sensors are available for access. Biometric sensors in the vehicle must be taught in. The authentication process then takes all taught-in and available sensors into account.

The following user-specific content and applications are protected, for example:

- User selection and user profile settings
- Biometric sensors

The teaching-in of biometric sensors

For teaching in and editing biometric recognition see the following section.

- Suggestions

The data and determination of the most probable navigation destinations, media sources, radio stations, contacts and messages.

- ENERGIZING COACH

The recorded health data and its evaluation.

- In-Car Office

The calendar, the tasks and the e-mails.

- Parking service

The payment transactions.

- Mercedes me Store

The purchase of services.

- System activations of paid vehicle functions

In the following cases you will be prompted for authentication or re-authentication using a sensor or the Mercedes me PIN:

- When selecting a protected user profile
- When calling a function requiring special protection
- If biometric sensors provide insufficient or contradictory information
- If the multimedia system no longer trusts a sensor
- If the seat belt buckle and the door are opened at the same seat and a function requiring special protection is called up
- When the vehicle is locked from outside

ⓘ Facial recognition for re-authentication in the driver's seat is only possible once the door has been closed or the seat belt buckle has been fastened.

▶ Select **Protect content**.

▶ Switch **Access protection** on or off.

- ❗ When access protection is switched off, your user profile can be viewed from any seat and changes can be made.
- ❗ Access protection is switched on or off on a vehicle-specific basis.
- ❗ Please note that authentication is necessary for several functions such as In-Car Office and cannot therefore be completely switched off.

Setting up and editing biometric recognition

The biometric data models are saved in the sensors in the vehicle. If recognition has been set up, this sensor serves as a contributory factor for authentication on the multimedia system.

- ▶ Select **Protect content**.
- ▶ Select **Facial recognition**, **Fingerprint recognition** or **Voice recognition**.
- ❗ If necessary, authenticate yourself on the multimedia system.

Setting up facial recognition

- ▶ Follow the system's instructions. Your face is scanned. A message in the driver's display or central display shows whether facial recognition was successful or not. You

can unlock your user profile and protected applications with the facial scan.

Setting up fingerprint recognition

- ▶ Place and lift your finger several times on the fingerprint sensor under the touchscreen (→ page 439). The finger is scanned. If the scanning procedure is successful, a message appears on the central display. You can unlock your user profile and protected applications with your fingerprint.

Setting up voice recognition

- ▶ Speak the sentence shown on the central display and follow the voice assistant's instructions. If the voice recognition was successful, a message appears on the central display. You can unlock your user profile.
- ❗ Avoid background or disturbing noises during voice recognition.

Deleting biometric data

- ▶ Tap on , for example, behind **Fingerprint recognition**.
- ▶ Select **Yes**.

Calling up the set-up assistant

- ▶ Select **Profile**.
- ▶ Select **Set-up assistant**.
- ▶ Follow the directions from the set-up assistant.

Changing user name or profile photo

- ▶ Select **Profile**.
- ▶ Select **Change user name**.
- or
- ▶ Select **Profile picture**.
- ▶ Enter the user name or select a user image.
- ▶ Select **Finished**.
- ❗ You can store your photo in the Mercedes me user account using the app or in the portal. The photo will then be shown in the vehicle. In the vehicle itself, you can select other sample images instead of the photo.

Deleting a user profile

- ▶ Select **Profile**.
- ▶ Select **Remove**.
- ▶ Select **Remove user profile**.

i Your Mercedes me user account and your personal data will remain within the Mercedes me ecosystem.

Resetting the user profile to factory settings

- ▶ Select **Profile**.
- ▶ Select **Reset**.
- ▶ Select **Yes**.

i This resets the contents of the user profile to factory settings, but not the vehicle.

You can watch an animation on this topic via the following link:

Selecting a user

Multimedia system:



i When you call up your driver profile, the driver's seat and the steering wheel can be set.

You can cancel the setting process with the following actions:

- Press **Tap here to cancel**. message on the central display.
- Press one of the seat operating buttons in the driver's door.

- ▶ Select **Select user**.
- ▶ Select a user.
- ▶ When requested to do so, authenticate with the Mercedes me PIN or a taught-in biometric characteristic.
The user profile is loaded and activated.

i If you select **Continue without selecting user**, no specific settings for the user profile are loaded.

Synchronising user profiles

Requirements

- You have a Mercedes me user account.
- The vehicle is connected with your Mercedes me user account.

Multimedia system:



Synchronisation

▶ **Synchronise automatically** .
When the vehicle is switched on or off, the data stored in the vehicle is automatically synchronised with the Mercedes me user accounts. This synchronization is done for all user profiles and is not profile-specific.

or

▶ Select **Synchronise now**.
After selecting this option, the data stored in the vehicle is synchronised with the Mercedes me user accounts.

i Not all user profile functions are available during synchronization.

i If the personalisation service in the vehicle is deactivated, only the following user profile master data is synchronised:

- Profile name
- Profile image
- Mercedes me PIN

Favourites

Overview of favourites



Favourites offer you quick access to frequently used applications. 100 favourites are available in total.

You can select favourites from categories or you add favourites directly from an application.

Calling up favourites

Multimedia system:



- ▶ Alternatively, in the home screen pull down bar  in the centre of the status line (→ page 437).
- ▶ Select  in the Control Center.

Adding favourites

Multimedia system:



Selecting favourites from categories

- ▶ Select .
- ▶ Select  **Create new favourite** .

- ▶ Select the category.
- ▶ Select a favourite.
The favourite is stored at the next available position.
- ▶ **All positions in the favourites are taken:** confirm the message shown.
A list shows all the favourites.
- ▶ Select a favourite to be overwritten.

Adding a favourite from an application

You can, for example, save a contact (example), or add an ENERGIZING COMFORT programme.

- ▶ **To save a contact as a global favourite:** select a contact (→ page 532).
- ▶ Press on a telephone number until a menu is shown.
- ▶ Select **Save as favourite**.
- ▶ The contact is added as a favourite.

Renaming favourites

Multimedia system:



- ▶ Press on a favourite until a menu is shown.

- ▶ Select **Rename**.
- ▶ Enter the name.
- ▶ Save the names.

Moving favourites

Multimedia system:



- ▶ Press on a favourite until a menu is shown.
- ▶ Select **Move**.
- ▶ Move the favourite to the new position.
- ▶ Tap on .

Deleting favourites

Multimedia system:



- ▶ Press on a favourite until a menu is shown.
- ▶ Select **Delete**.
- ▶ Select **Yes**.

Resetting favourites

- ▶ In the menu, select **Reset all favourites** .
- ▶ Select **Yes**.

Notifications Centre

Overview of the Notifications Centre

The following communications are collected in the Notifications Centre:

- Communications which are generated by the vehicle or from the multimedia system.
- Communications which are received through the use of services.

The following notification types are available for you:

- Navigable destinations and routes
- Messages (text messages)
- Calendar entries and reminders, e.g. from In-Car Office

This function is not available in all countries.
- System information, e.g. **Important software update available. Confirm to start the update.**
- Other notifications, e.g. from additional online services that can be subscribed to or emergency reports (e.g. tornado)

The Notifications Centre is in the Control Center. Depending on the style set, newly received notifications are shown using a coloured dot.

Notifications are normally briefly shown as they are received. If you take no action, these are stored for future access in the Notifications Centre.

The notifications are sorted chronologically. The most recent notifications are at the top.



Example of a message

- ① Calls up the Notifications Centre
- ② Symbol for a pinned notification
- ③ Time message received
- ④ Calls up the settings
- ⑤ Deletes notifications
- ⑥ Display for available actions

- ⑦ Description of the notification and the issuing service
- ⑧ Symbol for notifications
- ⑨ Date of the received notifications

Depending on the type of notification, up to four different actions are available.

Examples of actions include:

- Reading aloud
- Placing a call
- Replying
- Calling up a web page
- Navigation

Some notifications, e.g. a navigation destination, are stored longer. Therefore, it is not necessary to carry out available actions directly upon receipt of the notifications. A route guidance can be started at a later time.

You can pin a notification so that this is not deleted automatically after a certain time. The notification is then denoted by symbol ②.

Calling up notifications

Opening the Notifications Centre

▶ In the zero layer pull down bar ④ in the centre of the status line (→ page 432).

or

- ▶ In the home screen pull down bar ③ in the centre of the status line (→ page 437). The Control Centre opens.
- ▶ Select  in the Control Center.

Selecting a notification

- ▶ If several messages are available swipe up or down.
- ▶ Select an action.

Closing the Notifications Centre



▶ Select .

Selecting actions for a notification

The following options are available:

- Select the action directly after a notification is received and shown.

- Select the action later after calling up in the Notifications Centre.

- ▶ Up to two actions available: select the action.
- ▶ More than two actions available: select .
- ▶ Select the action. The notification is still available.
- ▶ Close the actions with .

Editing notifications

- ▶ Call up the Notifications Centre (→ page 447).

Configuring settings

- ▶ Select  **Settings**.
- ▶ Select the service.
- ▶ Switch the options on or off.

The following options are available depending on the service:

- [Allow notifications](#)
- [Display in notification centre](#)
- [Show notifications](#)
- Switching [Acoustic signals](#) on or off

- **External access**

The option allows an external service access to specific data, e.g. the current vehicle position. The detailed, approved information is shown with .

If **Allow notifications** is switched off, the options cannot be selected with the exception of **External access**.

Pinning a notification

- ▶ Drag a notification to the right on the touchscreen.
A pin appears.
- ▶ Tap on the pin.
The notification is marked with a pin.

Deleting notifications

- ▶ Drag a notification to the left on the touchscreen.

or

- ▶ Select .
- ▶ Select **Yes**.
All messages are deleted.

Global search

Global search overview

You can call up the global search on the home screen. You can input characters using the keyboard or the handwriting recognition. Alternatively, the MBUX voice assistant allows voice input.

The global search provides search results for the following categories:

- Navigation
- Entertainment
- Phone, In-Car Office
In-Car Office is not available in all countries.
- Digital Owner's Manual
- Internet

The global search enables you to search for towns, roads and tourist attractions in the navigation category, for example.

The global search makes it possible to enter a three-word address (→ page 482).

If the search field is empty, you will first see smart suggestions in the **Suggestions** category.

The prerequisite for this is that the smart suggestions are activated in the user options (→ page 442).

As soon as a letter is entered, you will be shown the best hits in the **All** category. You will find further search results in the individual categories. Next to the category is the number of results.

After selecting a category you can select the search results within the category. When you select a search result, a detailed view is opened depending on the category.

Using the global search

Multimedia system:



In the **Suggestions** category up to six smart suggestions are displayed, even if no search entry has been entered yet.

- ▶ Enter the search term into the search field.
As soon as a character is entered the **All** category is marked. Up to ten search results per category are displayed there.

In the other categories suitable search results for the entered search item are displayed.

Alternatively, the MBUX Voice Assistant allows voice input using  or you switch to the handwriting recognition  (→ page 454).

▶ **To end the search:** select .

▶ **To show search results for a category:** select a category.

▶ **To accept the search result:** select the search result.
An action starts, e.g. a radio station is set or a detailed view is displayed, e.g. for a contact.

Content sharing menu

Overview of the Content sharing menu

You can find the **Share content** menu in the Control Center. It shows the available displays in the vehicle and their playback status. Content currently on a display can be shared with other displays; playback of an entertainment source, for example. Status symbols on the displays inform you about the current settings, for example "Headphones connected".

Content is shared in the menu itself or directly from an application.

Active content is shared on a display and played back on the receiving display.

Inactive content can be searched for in an application and then shared from there.

The following display content can be shared, for example:

- Radio stations
- Media
- Browser
- ENERGIZING COMFORT programme

Opening the content sharing menu in the Control Center

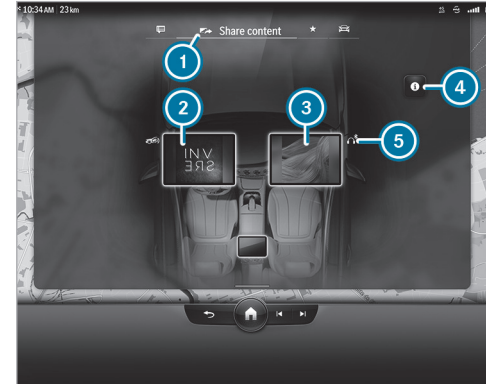

Example: content sharing menu

- 1 Calls up a menu
- 2 Central display with active content (cover display)
- 3 Front passenger display

- ④ Displays animation for content sharing
- ⑤ Status information, e.g.  Bluetooth® headphones connected to the front passenger display on the right



▶ In the zero layer pull down bar ④ in the centre of the status line (→ page 432).

or

▶ In the home screen pull down bar ③ in the centre of the status line (→ page 437). The Control Centre opens.

▶ Select ①.

⑤ shows the following status information:

- Audio playback, e.g. via Bluetooth® headphones  or vehicle loudspeakers 
- Playback status, for example pause or mute function active

Depending on the status of the display, the following information is shown on ② and ③:

- The cover
- The active privacy mode 
- **Display off**

- **System off**

■ Sharing MBUX display content

In the **Share content** menu, you can share content currently being played back on one display with other displays.

You can also share content from an application in the vehicle, e.g. in a menu or in a search.

▶ In the menu drag and drop a display to another display. The content of one display is placed on another display or retrieved from another display.

or

▶ Select **Share with everyone**. The content of one display is shared with all displays in the vehicle.

or

▶ Share content directly from an application using **Share**; share a radio station in the vehicle, for example.

Controlling entertainment sources with MBUX voice assistant

- ▶ Activate the voice assistant with "Hey Mercedes".
- ▶ Say a voice command, for example "Play Rihanna on front passenger seat".

■ Controlling media playback in the Control Centre



Example: control menu

- ① Cover (if available)
- ② Track and other information
- ③ Controls playback of the entertainment source

Previous track/scene, play/pause or sound on/off, next track/scene

- ④ On the central display: switches the MBUX multimedia system or the display off

On the front passenger display: switches the display off

- ⑤ Switches the  privacy mode on or off at the seat
- ⑥ Selects the current audio source at the seat for playback on the vehicle speakers

The available options are seat-specific. On the front passenger display the sound for the connected headphones can also be switched on or off and the volume can be set.

- ⓘ The options in ③ are available depending on the application.
- ⓘ In the active  privacy mode, the display content being played back is hidden from the other seats. The display content can be shared but not retrieved.



- ▶ Call up the Control Center on the home screen (→ page 437). The Control Centre opens.

- ▶ Briefly press on a display. The control menu for media playback is called up.
- ▶ Change the settings.

Setting the volume for headphones

- ▶ Select .
- ▶ Slide the volume button up or down.

Switching the sound for the headphones on and off

- ▶ **To switch off:** press and hold . The current audio source is muted.
- ▶ **To switch on:** press and hold  once again.

Switching the sound for the MBUX multimedia system on or off

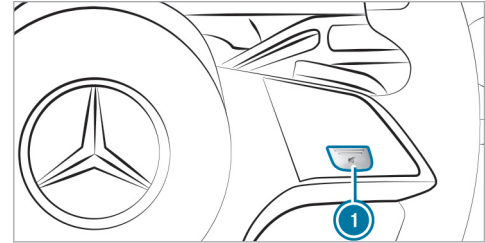

On the steering wheel

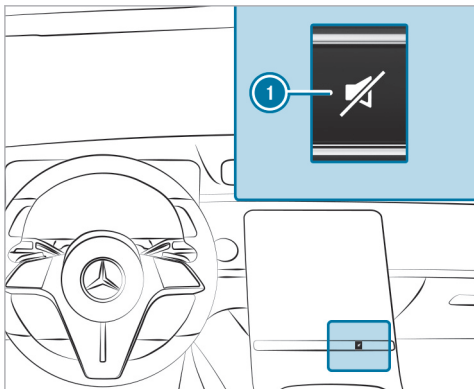

On the central display control panel

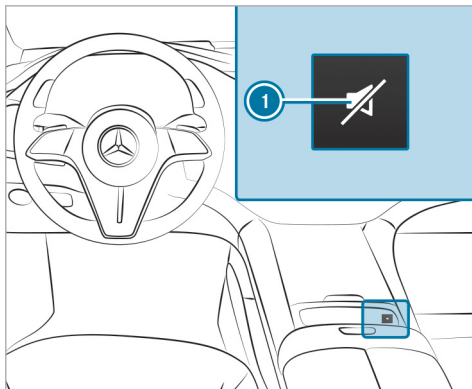

On the control panel when equipped with MBUX Hyperscreen

- ▶ **To switch off:** press button ①.
The current audio source is muted.
The  symbol appears in the status line of the central display.

If you are listening to a radio station, for example, and switch off the sound then all media sources will be muted.

Traffic and navigation announcements can still be heard in this case. The MBUX voice assistant and telephony are also not affected.

Switching on

- ▶ Press button ① again.
- or
- ▶ Set the volume.
- or
- ▶ The media source changes.

Setting the volume of the MBUX multimedia system

Setting with the button

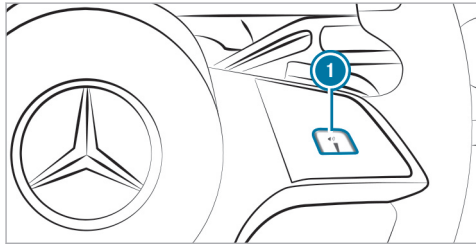

On the steering wheel

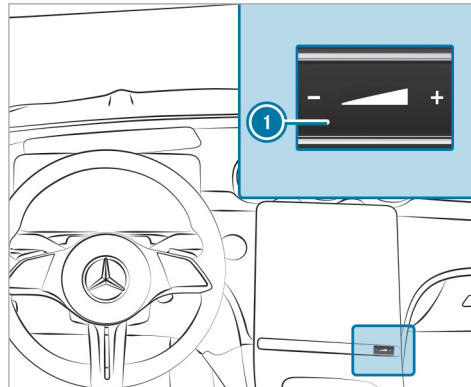

On the central display control panel

▶ Press **-** or **+** **1**.

or

▶ Swipe across button **1**.
The volume of the current audio source in the foreground is set.

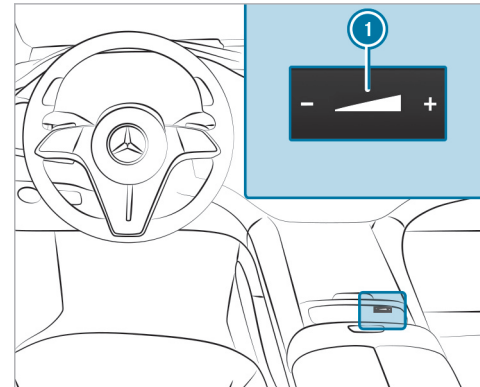

On the control panel when equipped with MBUX Hyperscreen

▶ Press **-** or **+** **1**.

The volume of the current audio source in the foreground is set.

The volume is adjusted for the following groups:

- Entertainment
- Ringtone

- Calls, for example phone calls
 - Voice output, for example MBUX voice assistant
 - Navigation announcements
- i** If you set the volume of the voice output to "0", for example, a minimum volume is automatically set when the MBUX voice assistant is next called up. The entertainment volume is automatically adjusted after the multimedia system is restarted.

Setting in the menu

▶ Press and hold the  button on the right of the steering wheel.

or

- ▶ Press and hold  on the touchscreen. The home screen appears.
- ▶ Select **Settings**.
- ▶ Select **System**.
- ▶ Select **Audio**.
- ▶ Select a volume setting.

i The volume can be set for all groups except the entertainment volume.

▶ Set the volume.

The following settings are also available in the Assistance menu:

- Switching the navigation announcements on or off during a phone call.
- Reducing the entertainment volume while a navigation announcement is being issued.

Entering characters

Using the character input function

Requirements:

- **For the handwriting recognition read-aloud function:** the MBUX multimedia system is equipped with the MBUX voice assistant.
- The read-aloud function is available for the selected system language.
- The handwriting recognition read-aloud function is activated.

Enter the characters on the Touch Control or on the touchscreen. Character input can be started with a control element and resumed with another.

▶ When the keypad is shown, enter the characters by swiping and pressing on the Touch Control or by tapping on the touchscreen.

or

▶ If handwriting recognition has been selected, write the characters on the touchscreen. Examples for character input include the global search, entering a navigation destination or the renaming of a favourite, for example.

The touchscreen supports character input with the following functions:

- Handwriting recognition offers character suggestions.
- If the read aloud function is activated for handwriting recognition then the entered characters are read aloud.

Entering characters on the touchscreen

Requirements:

- If you wish to have the character input read aloud: the read aloud function of the handwriting recognition is switched on (→ page 456).
- An online connection is required for some functions.

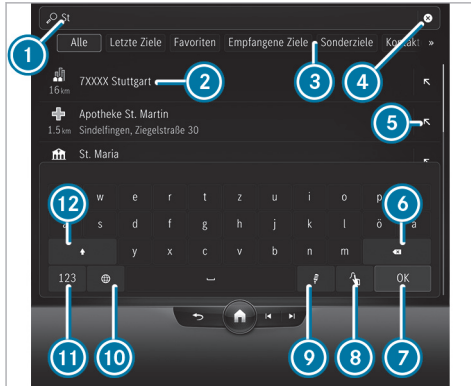

Example: character input with the keypad

- ① Input line with current entry
- ② Search result
- ③ Selects destination input, displays further destination inputs with double arrow
- ④ Deletes an entry
- ⑤ Adopts the search result in the input line and continues the search

- ⑥ Deletes the last character entered
- ⑦ Hides the keypad
- ⑧ Switches to handwriting recognition
- ⑨ Starts the MBUX voice assistant (→ page 419)
- ⑩ Sets the written language
- ⑪ Switches to digits and special characters
- ⑫ Switches to upper-case or lower-case letters

▶ Example: call up the navigation and enter a destination address (→ page 30).

▶ Briefly press on a character. The character is entered in input line ①.

▶ Resume character input.

① The available editing functions depend on the editing task, the language set and the character level.

Entering alternative characters

- ▶ Press and hold on a character.
- ▶ Select the character.

Ending character input

- ▶ Hide keypad ⑦.

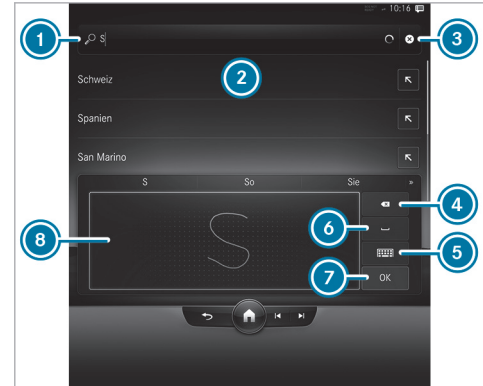





Example: entering characters with handwriting recognition

- ① Input line
- ② Shows suggestions during input
- ③ Deletes an entry
- ④ Last character entered
- Pressing and holding deletes the entry
- ⑤ Switches to input using the keyboard

- 6 Enters a space
- 7 Accepts an entry
- 8 Writing area

If available, the  symbol allows you to change to voice input.

- ▶ When the keyboard is displayed, select .
- ▶ Write the character with one finger on the touchscreen. The letters can be written next to each other or above each other. The character is entered in input line 1. Suggestions are shown in 2.
- ▶ Select one of the suggestions.
- ▶ If available, display additional suggestions with  or .
- ▶ **To end character entry:** press briefly on .

Setting the keyboard and handwriting recognition for character entry

Requirements:

- The read-aloud function is available for the selected system language.

Multimedia system:

- ▶  ▶ Settings ▶ System
- ▶ ▶ Keyboards and handwriting

Setting the keyboard language

- ▶ Select **Keyboard languages**.
- ▶ Select one or more keyboard languages.

Setting the writing speed

- ▶ Select **Handwriting recognition**.
- ▶ Select an option, e.g. **Medium**.

Activating the read-aloud function

- ▶ Select **Handwriting recognition**.
- ▶ Activate  **Read out**.
The letter that you write on the touchscreen is read aloud.

Activating handwriting recognition on the keyboard

- ▶ Select **Handwriting recognition**.
- ▶ Activate  **Handwriting recognition**.
You can write characters directly on the keyboard.

Deleting the user dictionary

The user dictionary learns from your inputs and offers suggestions during character input. You can reset the user dictionary.

- ▶ Select **Reset my dictionary**.
- ▶ Select **Yes**.

Driver camera

Overview of the driver camera

⚠ WARNING Risk of injury from infrared radiation from the camera

This product uses an infrared lighting system of risk group 0 (RG0). If the housing is opened or damaged, infrared radiation may damage your retina.



- ▶ Do not open the housing.
- ▶ Always have maintenance work and repairs carried out by a qualified specialist workshop.

This device is a product of risk group 0 (RG0) according to IEC 62471: 2006 (First Edition) & DIN EN 62471: 2008.

The driver camera is located in the driver's display.

The driver camera detects the following characteristics:

- Head position
- Viewing direction
- Eyelid closure characteristics
- Driver's face

 The driver camera is automatically activated each time the vehicle is opened with the key. The current status of the  driver camera is shown in the status line of the central display.

 The driver camera records image data for applications such as ATTENTION ASSIST and facial recognition, for example. The driver camera converts the image data directly into meta data. No image data is saved in the process. The data is only pro-

cessed in the vehicle and is not transmitted from the vehicle.

The driver camera must be set up for facial recognition before use (→ page 442).

System limits

The system may be impaired or may not function in the following situations:

- The driver camera is covered or dirty, misted up or scratched.
- The driver's face and/or eyes are covered.
- The driver is wearing glasses that block infrared.

Display messages

In the following situations display messages may be shown:

- If the driver camera is not functioning. The driver camera is malfunctioning.

The **Driver camera inoperative** See Owner's Manual message appears.

- If the driver camera cannot capture the position of your head due to the position of the steering wheel or seat.

The **Change steering wheel/ seat position until 6 dots are visible on the upper edge of the screen** message appears.

- If the view of the driver camera is reduced or restricted.

The **The camera's view of the driver is currently impeded** Affected functions: see Owner's Manual message appears.

The message can appear, for example, in the following cases:

- The camera's view is obstructed, e.g. due to a scarf or hat being worn.
- The driver is wearing glasses that block infrared.
- If hair partially obstructs the eyes, e.g. as with a long fringe.
- In the event of strong direct sunlight. The driver camera cannot detect the driver's eyes if the light-dark contrast is too strong.

- When one or both hands are on top of the steering wheel (twelve o'clock position).

Notes on care

Please comply with the notes on caring for the interior relevant to the display (→ page 605).

Switching the driver camera on or off

Multimedia system:

→  » Settings » System
» Intelligent assistants

The driver camera is automatically activated each time the vehicle is switched on.

- ▶ Select **On** or **Off**.

When the driver camera is switched off or the **The camera's view of the driver is currently impeded** Affected functions: see **Owner's Manual** message appears, the following functions are not available or limited:

- The microsleap and distraction detection function of ATTENTION ASSIST (→ page 315)
- The facial recognition

This function serves as sensor input for authentication and unlocking of the user profile and protected applications (→ page 442).

System settings

Display

■ Configuring display settings

Multimedia system:

→  » Settings » System » Display

Adjusting the brightness

- ▶ Select **Display brightness**.
- ▶ Vehicles with a driver's display and central display: Adjust the display brightness of the driver's display or central display.
- ▶ Vehicles with the MBUX Hyperscreen: Adjust the display brightness of the driver's display, central display or the front passenger display.

Setting the decorative image for the front passenger display (vehicles with MBUX Hyperscreen)

- ⓘ The function is country-dependent.

- ▶ Select **Screensaver, passenger display**.
A selection of decorative images is displayed.
- ▶ Select the desired decorative image.
- ⓘ The number of available decorative images is variable.
- ⓘ Using the Mercedes me App you can select a personal image for the front passenger display.
- ⓘ If no user is logged in on the front passenger display and the front passenger display is switched on, the decorative image or the personal image is visible.

Time and date

■ Setting the time zone

Multimedia system:

→  » Settings » System
» Time and date

- ▶ Select **Time zone**.
The list of countries is displayed.

- ⓘ If there are several time zones available in a country, these will be shown after the country is selected.

▶ Select a country and, if required, a time zone. The time zone set is displayed after **Time zone**.

or

▶ Select the **Automatic time zone** entry from the country list. The time zone will be set automatically according to the vehicle location.

- ⓘ The **Automatic time zone** option is available for vehicles with satellite reception.

■ Setting the time and date format

Multimedia system:

➔  ➔ **Settings** ➔ **System**
➔ **Time and date** ➔ **Set format**

▶ Select a time and date format.

■ Setting the time and date manually

Requirements:

- The vehicle does not have satellite reception.

Multimedia system:

➔  ➔ **Settings** ➔ **System**
➔ **Time and date**

Setting the time

- ▶ Select **Set time**.
- ▶ Set a time.
- ▶ Press **OK** to confirm.

Setting the date

- ▶ Select **Set date**.
- ▶ Select a date.
- ▶ Press **OK** to confirm.

- ⓘ On vehicles with satellite reception, the time and date settings are determined automatically based on the vehicle location and cannot be set manually.

Adjusting the time

- ▶ Select **Adjust time**.
- ▶ Set a value.
- ▶ Press **OK** to confirm.

- ⓘ The function is only available in vehicles with satellite reception.

Vehicle position

■ Switching transmission of the vehicle position on or off

Requirements:

- A Mercedes me user account is available.
- At least one service is activated in the Mercedes me user account which has access to the transmitted position data.
- ⓘ The function is country-dependent. For more information, consult a Mercedes-Benz service centre.

Multimedia system:

➔  ➔ **Settings** ➔ **System**
➔ **Data protection**

▶ Activate or deactivate the **Transmit veh. position** function.



- ⓘ Alternatively, you can also switch the function on or off in the status line via .

Setting permissions

Multimedia system:

 **Settings** **System**
Data protection **Permissions**

In the **Permissions** menu, you can set access authorisations for various data points (such as microphone, camera) used in an application. You can change permissions that have already been granted here. You can set permissions either for individual data points or for certain applications or websites.

-  Select **Requests** or **Apps/websites**.
-  Make the required settings for the permissions.

Bluetooth®

Information about Bluetooth®

Bluetooth® technology is a standard for short-range wireless data transfer up to approximately 10 m.

You can use Bluetooth® to connect your mobile phone to the multimedia system and use the following functions, for example:

- Hands-free system with access to the following options:
 - Contacts (→ page 531)
 - Call lists (→ page 533)
 - Text messages (→ page 534)
- Internet connection (→ page 561)

Bluetooth® is a registered trademark of Bluetooth Special Interest Group (SIG) Inc.

 Internet connection via Bluetooth® is not available in all countries.

Activating/deactivating Bluetooth®

Multimedia system:

 **Settings** **System**
Internet and Bluetooth

-  Activate or deactivate **Bluetooth**.

Near Field Communication (NFC)

Information on Near Field Communication (NFC)



NFC enables short-range wireless data transfer or connection of a mobile phone with the multimedia system.

Further information can be found at: <https://www.mercedes-benz-mobile.com/>

Switching near-field communication on or off

Multimedia system:

 **Settings** **System**
Internet and Bluetooth

-  Activate or deactivate **NFC**.
-  Further information on connecting a mobile phone via the NFC interface (→ page 527).

Wi-Fi

Wi-Fi connection overview

You can use Wi-Fi to set up a connection to the Internet or to external network devices.

-  The availability of the function is dependent on the country.

Generally, two types of Wi-Fi connection are available:

- **Using the multimedia system as a Wi-Fi hotspot** (→ page 461)

The vehicle's multimedia system serves as a Wi-Fi hotspot for mobile communication devices, such as smartphones or tablet PCs, for example.

- **Using a mobile communication device as a Wi-Fi hotspot (tethering)** (→ page 563)

An external Wi-Fi hotspot is accessed for the Internet connection of the vehicle's multimedia system.

■ Switching Wi-Fi on or off

Multimedia system:

→  ► Settings ► System
► Internet and Bluetooth

▶ Select **Wi-Fi**.

The controller is to the right: Wi-Fi is switched on.

When Wi-Fi is switched on, you can connect the multimedia system with external hotspots or make it available as a hotspot for external devices.

When Wi-Fi is switched off, it is not possible to establish a hotspot connection.

 The availability of the function is dependent on the country.

■ Using the multimedia system as a Wi-Fi hotspot



Requirements

- The device to be connected supports at least one of the types of connection described.

The connection types shown depend on the device to be connected. The function must be supported by the multimedia system and by the device to be connected. The type of connection must be selected on the multimedia system and on the device to be connected.

-  The data volume of the vehicle or an already connected tethering device is used for the data connection.
Vehicle data volumes: depending on the vehicle equipment, you can purchase a data package directly from a mobile phone network pro-

vider via the Mercedes me Store. To be able to use the data package, you conclude a separate contract with a mobile phone network provider via the Mercedes me Store, which can be terminated at any time and for which there are no costs. This contract is a prerequisite for using the services from the previously purchased package. The availability of this option is dependent on the country. If the data package option is not available or can be upgraded, you can purchase data volume directly from the mobile phone network provider for a fee.

-  Some functions may first need to be activated on the device being connected. More detailed information can be found in the manufacturer's operating instructions.
-  The use of the vehicle data tariff by external devices is not available in all countries.

Multimedia system:

→  ► Settings ► System
► Internet and Bluetooth

▶ Select **MBUX hotspot**.

- ▶ Select one of the following connection options.

Connecting using a QR code

Requirement: an app for scanning the QR code is installed on the device being connected.

Alternatively: the device being connected has an integrated QR code scanner (see manufacturer's operating instructions).

- ▶ Scan the QR code shown.
- ▶ The Wi-Fi connection is established.

Connecting using NFC

- ▶ Activate NFC on the device to be connected.
- ▶ When the NFC symbol is displayed in the **MBUX hotspot** menu, hold the device to be connected to the NFC interface.
- ▶ Follow the instructions on the device.
- ▶ The Wi-Fi connection is established.

Connecting using a security key

- ▶ Select the vehicle from the device to be connected. The vehicle is displayed with the **MBUX XXXXX** network name.

- ▶ Enter the security key which is shown in the central display on the device to be connected.
- ▶ Confirm the entry.

Generating a new security key

- ▶ Select the **Generate new security key** option in the **MBUX hotspot** menu.
- ▶ Confirm the prompt with **Yes**.
- ▶ A new security key is generated.

A connection will be established with the newly created security key.

- ⓘ When a new security key is generated, all existing Wi-Fi connections are then disconnected. If the Wi-Fi connections are re-established, the new security key must be entered.

System language

Notes on the system language

This function allows you to determine the language for the menu displays and the navigation announcements. The selected language affects the characters available for entry. The navigation announcements are not available in all languages.

If a language is not available, the navigation announcements will be in English.

Setting the language

Multimedia system:

- ▶  ▶ **Settings** ▶ **System** ▶ **Language**

Setting the system language

A list of the available system languages is shown.

- ▶ Select a language.
- ▶ The system language is switched to the selected language.

Setting the distance unit

Multimedia system:

- ▶  ▶ **Settings** ▶ **System** ▶ **Display**

- ⓘ This function is not available in all countries.
- ▶ Select a unit for the distance.
- ▶ Activate **Additional speedometer** for an additional display in the driver's display.

Activating/deactivating system PIN protection

Multimedia system:

-  ➤ Settings ➤ System
- Data protection ➤ PIN protection

Setting the system PIN

- ▶ Select **Set PIN**.
- ▶ Enter a four-digit system PIN.
- ▶ Enter the four-digit system PIN again.
If both system PINs match, then the system PIN protection is active.

Changing the system PIN

- ▶ Select **Change settings**.
- ▶ Enter the current system PIN.
- ▶ Select **Change PIN**.
- ▶ Set a new system PIN.

Activating system PIN protection for software updates

- ▶ Select **Protect software updates**.
- ▶ Activate or deactivate the function.

Configuring suggestions

Multimedia system:

-  ➤ Settings ➤ System
- Suggestions

- ▶ Select .
- ▶ Switch the options on or off individually.
If an option is switched on and sufficient data has been gathered, personalised suggestions based on your user behaviour will be offered to you. These are, for example, navigation destinations visited, phone numbers dialled as well as suggestions based on your music preferences.

Navigation

When **Allow destination suggestions** is switched on, the vehicle makes suggestions based on your visited navigation destinations.

If **Activate commuter route** is switched on, the navigation automatically detects that the vehicle is on a commuter route.

Calls & messages

Suggestions are offered for numbers dialled and messages sent.

Comfort

The vehicle makes suggestions based on the use of your comfort functions, e.g. which massage programme should be started at what time.

Entertainment

Suggestions are offered for the currently played media source. Suggestions are also made for online digital services, e.g. Spotify, TuneIn Radio and streaming services, and for categories, e.g. genre, artist and mood.

Vehicle

The suggestions for vehicle functions such as Parking Assist PARKTRONIC and the vehicle level settings are displayed on the zero layer.

Online voice services

The suggestions are made available online based on your voice input and are offered on the zero layer.

- ⓘ The suggestions offered depend on the equipment.

Deleting collected suggestions

Multimedia system:

 Settings >> System

>> Suggestions

Select .

Select **Yes**.

The suggestions are reset.

Software update

Information on software updates

Software updates keep your vehicle and the related systems up-to-date and prevent security flaws.

Software updates are available online for vehicle components such as control units, convenience systems, locking and safety systems, driver assistance systems, suspension and drive systems as well as for the MBUX multimedia system. Software updates are available via the communication module or a Wi-Fi connection to an external hotspot.

The navigation maps are also updated via updates from external storage media (e.g. USB flash drive).

Install available software updates regularly. Otherwise the security of your MBUX multimedia system and individual vehicle components cannot be ensured.

 Software updates can be protected with a system PIN. Further information about the system PIN (→ page 463).

Further information about software updates can be found at <https://me.secure.mercedes-benz.com>.







Carrying out software updates

Requirements

For software updates via the communication module and Wi-Fi:

- Your vehicle is linked to a Mercedes me user account (→ page 551).
- Software updates without Mercedes me user account: The **Allow software updates** option is activated in the **Software update** menu.
- For software updates via the communication module: an Internet connection exists via the communication module (→ page 562).

- For software updates via Wi-Fi: a connection to an external Wi-Fi hotspot exists (→ page 563).

-  Depending on the software update, this is started via the  communication module,  Wi-Fi or  external storage medium.
-  Online software updates cannot be performed via external Wi-Fi hotspots that are encrypted via TKIP.
-  If the Wi-Fi hotspot requires logging in via the browser, once the connection is successfully established the browser will open in order to start the update. To start the download follow the instructions in the browser.

Multimedia system:

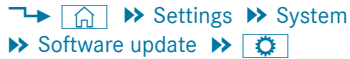

Starting a map update from an external storage medium

- ▶ Connect the storage medium with the vehicle via a media interface.
A message about an available map update appears on the central display.
- ▶ Select the message.
- ▶ Select **Start**.
The map update is started.

Starting the software update via the communication module

If the **Automatic online update** option is active, available software updates are downloaded and installed automatically. Activate the option in order to always keep your vehicle up-to-date and avoid security flaws.

- ▶ Select **Automatic online update**.
The software update is downloaded and installed automatically.

If the option is deactivated, you will be informed of new software updates once. The updates are available for downloading for a limited period of time.

- ▶ Select an update from the list of available updates.
- ▶ Start the update.
The software update is downloaded and installed automatically.

Starting a software update via Wi-Fi

Some software updates require an additional connection to a Wi-Fi hotspot. The connection to an external hotspot can be established when the software update is started.

- ▶ Select an update from the list of available updates.
- ▶ Start the update.
- ▶ Establish the connection to a Wi-Fi hotspot.
The update is downloaded and installed automatically.

For software updates requiring a safe vehicle status: when the last installation step is reached, a message appears on the central display after the

vehicle is switched off. Follow the step-by-step instructions on the central display to complete the installation.

There are software updates that can only be installed when the vehicle is safely parked, there are no more people in the vehicle and the vehicle is locked.

Installing software updates

Software updates are installed automatically after they are downloaded. As soon as the software update has been completed, a message appears in the central display. It may be necessary to restart the MBUX multimedia system.

Software updates are installed automatically after they are downloaded. As soon as the software update has been completed, a message appears in the central display. It may be necessary to restart the MBUX multimedia system.

Some software updates require a safe vehicle status for the installation to be completed. They can only be carried out in a safely parked vehicle with the vehicle switched off. If this is necessary, a message appears on the central display after the vehicle is switched off.

▶ Follow the instructions on the central display.

For some software updates, you can set a time for installation. The installation is carried out automatically at the scheduled time. You do not need to be in the vehicle during installation. Note that the planned installation is cancelled as soon as the vehicle door is opened.

If an installation is available where you can set the time, a message appears on the central display after the vehicle is switched off.

▶ Follow the instructions on the central display.

The vehicle cannot be used while these software updates are being installed. Make sure that no persons or animals are in the path of your vehicle. Events stored in the vehicle's control units can be overwritten.

■ Availability of the driver's and central display

During the installation of software updates, it is not possible to use the vehicle, driver's display and central display. You may receive the following display messages when an installation is running:

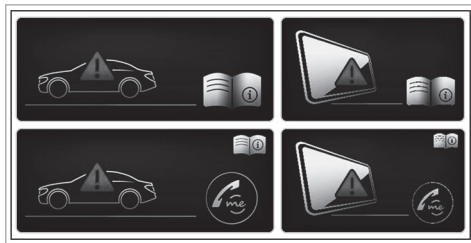

❗ The display message does not appear every time a software update is installed.

In rare cases, an error can occur during the installation. The multimedia system automatically attempts to restore the previous version.

If it is not possible to restore the previous version, the display message shown above appears every time the vehicle is started.

■ Failure of the driver's display:

If the driver's display fails or there is a malfunction, you may not recognise limitations in the functions of systems relevant to safety or the speed display, for example. The operating safety of the vehicle may be impaired. Drive on carefully

and have the vehicle checked at a qualified specialist workshop immediately .

Further information about software updates can be found at <https://me.secure.mercedes-benz.com>

■ Failure of the central display:

If the central display fails or the display message shown above is shown continuously, several systems such as the reversing camera, Parking Assist PARKTRONIC or climate control are no longer available. Drive on carefully and consult a specialist workshop as soon as possible.

■ Front passenger display failure (only vehicles with MBUX Hyperscreen):

If the front passenger display has failed or a display message appears permanently, functions and systems are no longer available via the front passenger display. Visit a qualified specialist workshop.

Resetting the multimedia system (reset function)

⚠ WARNING Risk of accident due to failure of central display functions

While the multimedia system is reset, its functions, such as the reversing camera, are not available.

▶ Only reset the multimedia system when the vehicle is stationary.

Requirements:

- The vehicle is switched on.
- The vehicle is stationary.

Multimedia system:

➔  ➔ Settings ➔ System ➔ Reset

When resetting the system, personal data and settings are deleted, for example:

- Connected devices
- Individual user profiles
- Biometric data
- Vehicles with rear telephony: handset connection

- ① The data used and saved in the multimedia system by the driver assistance systems is deleted.
- ① Vehicles with rear telephony: The handset must be in the mobile phone cradle while the system is reset.
 - ▶ Select **Reset**.
A query appears asking if the system should really be reset.
 - ▶ Select **Yes**.
The multimedia system is reset to the factory settings. The multimedia system is restarted after the system reset.
- ① Due to data protection, as well as the function of individual driving systems and driving safety systems, it is a requirement to carry out a complete system reset before selling the vehicle or transferring it to a third party, or after use as a hire car.

AMG TRACK PACE

Function of AMG TRACK PACE

- ① This function is an on-demand feature (→ page 75).

With AMG TRACK PACE, the driving characteristics on race tracks can be analysed and optimised. You can drive previously saved race tracks (e.g. Hockenheimring), or record and save new tracks. The driven lap times are stored for every track. These can be analysed and compared to other lap times to achieve the best possible race results. Additionally, acceleration and braking procedures can be measured and stored.



Note: Use AMG TRACK PACE only on closed-off routes outside the public traffic area. Adapt your driving style to your personal performance and environmental conditions. As the driver, you are solely responsible for driving your vehicle. Park your vehicle safely before operating the application.

Setting Track Race





Multimedia system:

 TRACK PACE  Track Race

Recording a new track

- ▶ Select  **New track** .
- ▶ Select  **Start Record**. at the desired starting point.
The track recording starts at this point.



During track recording, sectors can be set to divide up the track.

- ▶  Select **Set Sector**.
 - ▶ Select  **Stop Recording** to end track recording or cross the starting line again.
 - ▶ Confirm the prompt with **Yes**.
 - ▶ Select the weather.
-  The temperature is determined automatically.
- ▶ Enter a name.
 - ▶ Press  to confirm.
The track is saved under the name entered.

Searching by track name





- ▶ Select  **Search** .
- ▶ Enter the desired track name.
Tracks with the searched name are displayed.

Measuring time on a saved track

- ▶  Select **All tracks**.
- ▶ Select the desired track.
- ▶ Select  .
- ▶ Select **Start timing** if you are already at the starting line.

or



- ▶ Select **Navigate to** for navigation to the starting line.
Timing begins automatically when the starting line has been crossed.

-  When  is selected, the track display can be switched to AR. In addition, it is possible to switch to the telemetry display by selecting  .
- ▶ Select  **Stop timekeeping** to end timekeeping.

- ▶ Confirm the prompt with **OK**.
- ▶ Select the weather.
- ▶ Select **Yes** to save the times driven for this track.



Showing readings during Track Race

The following readings can be shown:

- Tyre temperature
 - Miniature map
 - Sector overview
 - G-force display
 - Lap overview
- ▶ Select  **Start timing** .
 - ▶ Select  .
 - ▶ Drag the desired display from the grid on the left or right edge of the central display.
The readings are shown during the Track Race.

By selecting  on the active display, you can deactivate this.

Displaying the analysis

- ▶  Select **All tracks**.
An overview of all the driven tracks appears.
- ▶ Select a track.
- ▶ Select a session.
The following data are displayed:
 - Lap and sector times
 - Average and top speed
 - Driver
 - Vehicle
 - Date
 - Weather
- ▶ Select **Add recording** to use a different session as a reference value.
- ▶ Select  to return to the overview.
- ▶ Select **Diagram**.
- ▶ Set the desired parameters.
The analysis is displayed.

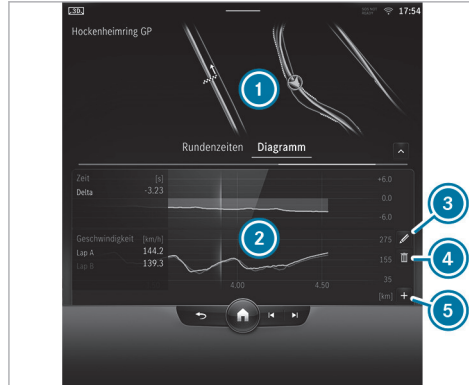



- ① Lap overview
- ② Parameter overview
- ③ Editing parameters
- ④ Deleting parameters
- ⑤ Adding new parameters
- ⓘ The following values can be set for the parameters, for example:
 - speed



- Longitudinal/lateral acceleration
- Steering angle
- Engine speed
- Engine oil/tyre temperature

Based on the analysis, you can check and optimise the driving behaviour for any position on the track.

Exporting tracks (USB)

- ▶ Select  **Tracks** .
An overview of all stored tracks appears.
- ▶ Select the desired track.
- ▶ Select options  for the desired track.
- ▶ Select **Export track to...**
The selected track can be exported to a USB storage device connected to the vehicle.

Editing tracks and recordings

- ▶ Select  **Tracks** .
- ▶ Select the desired track.
- ▶ Select options  for the desired track.
- ▶ Select **Rename** or **Delete**.

or

- ▶ Select a track.
- ▶ Highlight the desired recording.
- ▶ Select  options.
- ▶ Select [Exporting to...](#) or [Delete](#).

Setting Drag Race

Multimedia system:

↳ [TRACK PAGE](#) ▶▶ [Drag Race](#)

Measuring acceleration

- ▶ Select  [Drag race options](#).
- ▶ Select [Acceleration](#).
- ▶ Set a starting speed or select [Automatic](#).
Measurement begins as soon as the specified starting speed has been reached.
- ▶ Set a target speed.
Measurement stops as soon as the specified target speed has been reached.
- ▶ Start off and begin the measurement.
Measurement begins when the vehicle accelerates.

Measurement can be stopped early by interrupting the acceleration procedure.

Quarter mile race

- ▶ Select  [Drag race options](#).
- ▶ Select [Quarter-mile](#).
- ▶ Set a target distance.
Measurement stops as soon as the specified target distance has been reached.
- ▶ Start off and begin the measurement.
Measurement begins when the vehicle accelerates. Timing runs until the target distance or a maximum of one mile has been travelled.

Measurement can be stopped early by interrupting the acceleration procedure.

Measuring braking

- ▶ Select  [Drag race options](#).
- ▶ Select [Braking](#).
- ▶ Set a starting speed or select [Automatic](#).
- ▶ Start off and begin the measurement.

- ▶ Brake to a stop.
Measurement is incremental, in steps of 10 km/h to a stop. If the braking procedure is started e.g. at a speed of 157 km/h, measurement starts as soon as 150 km/h has been reached

Storing and calling up measured values

If measurement is completed or cancelled, a prompt appears asking whether the measurement should be saved.

- ▶ Confirm the prompt with [OK](#) to save.

Calling up saved measurements

- ▶  Select [History](#).
 - ▶ Select [Acceleration](#), [Quarter-mile](#) or [Braking](#).
 - ▶ Select a measurement.
The desired measurement is displayed in detail.
- or
- ▶ Delete a measurement.

Calling up the telemetry display

Multimedia system:

↳ TRACK PACE ▶ Telemetry

The telemetry display shows current vehicle data as a digital value and as a diagram. Up to four parameters can be selected to be shown on the display.

For example:

- Engine speed
- Wheel angle
- speed
- Steering angle

▶ Set the desired parameters.

▶ Set the time.

The set parameters are evaluated in the diagram for the selected time.

Configuring AMG TRACK PACE

Requirements

To connect a mobile device to the TRACK PACE app:

- The TRACK PACE app is installed on the mobile end device.
- The mobile end device is connected to the multimedia system via Wi-Fi (→ page 461).

Multimedia system:

↳ TRACK PACE ▶ 

Connect mobile device via the TRACK PACE app

The TRACK PACE app makes it possible to record videos and to synchronise them with stored tracks.

▶ Select **TRACK PACE App**.

▶ Select **Authorise new device**.

▶ Start the TRACK PACE app on the device to be connected.

▶ Select **Continue** and confirm the authorisation prompt.
A four-digit code is shown on the central display.

▶ Enter the code on the smartphone.
The device is authorised.

De-authorising the mobile device

▶ Select **TRACK PACE App**.

▶ Select a device.

▶ Confirm the message prompt with Yes.
The device is de-authorised.

Setting the TRACK PACE display on the head-up display and driver's display

▶ Select **IC and HUD contents**.

▶ Activate or deactivate the desired contents.
The contents on the head-up display and the driver's display are adapted.

ⓘ For further information on the Head-up Display (→ page 414).

ⓘ Further information about the driver's display (→ page 402).

Setting acoustic feedback

▶ Select **Acoustic feedback**.

A scale with values from 0 to 10 is shown.

▶ Select a setting.

Displaying statistics

- ▶ Select **TRACK PACE statistics**. Statistics on the current user profile are displayed.

The following data are displayed:

- Driving time
- Track driven
- Recorded tracks
- Recorded Track Races
- Laps recorded
- Recorded Drag Races
- Maximum design speed

Activating the ambient light

If this function is active, the vehicle interior is lit in red or green depending on delta time.

- ▶ Select **Ambient light**.
- ▶ Activate or deactivate the function.

Adjusting the dashcam

If the vehicle is equipped with a dashcam, it can be used in AMG TRACK PACE.

- ▶ Select **Dashcam**.
- ▶ Select **Track Race** or **Drag Race** and activate **Activate recording**.
- ▶ You can set which overlay is to be used in the recorded video under **Video overlay contents**.

Drive system settings

Overview of the energy flow display in the multimedia system

The active components of the drive system are highlighted on the energy flow display. The energy flow between the individual components is shown in colour.

The components displayed are:

- State of charge of the high-voltage battery
- Electric motors (drive system)
- Energy flow
- High-voltage battery

The energy flow is shown in different colours depending on the operating status:

- **White:** strong acceleration (boost effect)

- **Copper:** driving at constant speed or with moderate acceleration
- **Blue:** recuperation (charging the high-voltage battery) or overrun mode

Calling up the energy flow display

Multimedia system:



- ▶ Select **Energy flow**. The energy flow in the vehicle will be displayed.

Fit & Healthy

Setting ENERGIZING seat kinetics

Requirements

- ⓘ These functions are available only for fully electric seats with a memory function.

Multimedia system:



- ▶ Select **Seat kinetics**.

ENERGIZING seat kinetics can support back health by changing the seat position during a journey. This involves repeatedly stressing and relieving the muscles and joints by means of minor movements of the cushion and backrest.

Starting seat kinetics

- ▶ Select  for the desired seat.
The programme will run for the set duration.

Configuring seat kinetics

- ▶ Select  for the desired seat.
- ▶ Select **Backrest**, **Backrest & seat surface** or **Seat surface**.
- ▶ Select the desired duration for the selected seat.

Vehicles with a multicontour seat:

In addition to the seat backrest and seat cushion, the lumbar region can be activated for the function.

- ▶ Activate or deactivate **Including lumbar**.

ENERGIZING COMFORT

Overview of ENERGIZING COMFORT programs

- ⓘ Note that the available programs and the associated functions depend on your vehicle equipment. Depending on your equipment, fewer functions may be available.

Program overview

- **Refresh:** Can have a refreshing effect with short, cool puffs of air. The seat is ventilated, the vehicle interior is illuminated with cool colours and the program is completed with appropriate sound. In addition, the vibration massage in the cushions can loosen the muscles.
- **Warmth:** Can increase the comfort level for the vehicle occupants. Seat and steering wheel heater provide soothing warmth. The program is completed with unobtrusive sound and warm colours.
- **Vitality:** Can counteract diminishing attentiveness in monotonous driving situations. The activating stimulation of the vehicle occupants is carried out with invigorating sound, activating light and a vitalising massage.

- **Joy:** Can promote a positive mood in the vehicle occupants as well as mental regeneration. This results from the activation of a massage program, friendly sound and illumination with suitable colours.
- **Well-being:** Can help relax the vehicle occupants. This is achieved through relaxing massage, friendly light and calming sound.
- **Forest Glade:** Can have a calming and soothing effect on the vehicle occupants thanks to the acoustics of the forest. The ambience is supported by a suitable animation, colours and sound.
- **Sounds of the Sea:** Can contribute to calming the vehicle occupants. The acoustics of the sound of waves and seagulls in combination with other vehicle functions create a relaxing seashore atmosphere.
- **Summer Rain:** Can help relax the vehicle occupants. The relaxing effect of a rain shower can be experienced via acoustics and other vehicle functions inside the vehicle.
- **Power Nap:** The program consists of three phases.

- Falling asleep phase: here relaxing music is played and the air is cleaned by ionisation.
- Sleep phase: the active functions are deactivated or restricted as much as possible.
- Waking phase: slightly stimulating music is played, and the air is purified with ionisation. Additionally, functions such as seat ventilation and massage are activated.
- **Training:** Can counteract the onset of muscle tension, limbs falling asleep or stress with targeted relaxation or stimulation exercises. The exercises are demonstrated in short videos. The training consists of audio content and a brief animation. The audio content is conceived so that it can also be played back when you are driving. Animations are only shown when the vehicle is stationary. Always observe the traffic conditions if you are training when driving.
- **Tips:** The system gives auditory tips for possible exercises or measures for improving the comfort level of the vehicle occupants. By

selecting the desired area of the body you can receive targeted tips for the comfort level of this area.

Most programs that have been started for one seat can also be transferred simultaneously to another seat.

Starting the ENERGIZING COMFORT programme

⚠ WARNING Increased risk of accidents when using the ENERGIZING COMFORT programmes [Tips](#) and [Training](#)

The [Tips](#) and [Training](#) ENERGIZING COMFORT programmes can distract you when driving.

- ▶ Only carry out exercises if the traffic situation permits.
- ▶ When listening to the tips, make sure you are aware of the traffic around you at all times.

⚠ WARNING Risk of entrapment when using the ENERGIZING COMFORT programme [Power Nap](#)

With the [Power Nap](#) ENERGIZING COMFORT programme the following systems are moved automatically if required:

- Seats
- Side windows
- Sliding sunroof
- Roller sunblinds

This can cause you or another vehicle occupant to be trapped.

- ▶ Make sure that there is sufficient space behind the front seats.
- ▶ Make sure that no body parts are in the areas of movement.

Requirements:

- The vehicle is switched on.

For the start of [Power Nap](#):



- Only the power supply is on.

- The doors are closed.
- The vehicle is secured against rolling away.
- The state of charge of the high-voltage battery is sufficient for the use of the auxiliary climate control.

Multimedia system:



Starting and stopping a programme

- ▶ Select a programme.
- ▶ Select  for the desired seat.
- ▶ Select  to stop the program.

i If, during an active programme, a function requirement is no longer met, a corresponding message appears. The active programme is cancelled.

Configuring the programme

- ▶ Select a programme.
- ▶ Select **Settings**.
- ▶ Switch the functions included in the programme on or off.

Setting the duration

- ▶ Select a programme.
- ▶ Select **Settings**.
- ▶ Select the desired duration.

Starting a Power Nap



- ▶ Select **Power Nap**.
- ▶ Select  for the desired seat.

When the vehicle is stationary, the following actions are carried out when Power Nap is started:

- The roller sunblinds are extended.
 - The doors are locked.
 - The windows and sliding sunroof are closed.
 - The seats are moved into the fully reclined position.
 - The parking brake is applied.
- ▶ Select  to stop the program.
- i** The programme is available for the rear seats while the vehicle is in motion. The above-men-



tioned functions may only have limited availability.

Starting the training programme

- ▶ Select **Training**.
- ▶ Select a programme .
- ▶ Select  to stop the training programme.

i The animations demonstrating the exercises are faded out when the vehicle is in motion and you only hear the instructions.

Starting tips

- ▶ Select **Tips**.
- ▶ Select  a region of the body.
- ▶ Select  to stop playback of the tip.

ENERGIZING COACH

Function of the ENERGIZING COACH

Requirements:

- The **ENERGIZING COACH** service is activated in the Mercedes me portal or the Mercedes me App.

- The Mercedes me ENERGIZING App is installed on the mobile phone to use the service.

With ENERGIZING COACH you can evaluate the driving and driver situation. Depending on the situation, it offers recommendations for the start of an appropriate ENERGIZING COMFORT programme.

The following programmes could be suggested:

- **Vitality**
As an activating programme in monotonous driving situations or for long journey times, for example
Information on the vitality programme see (→ page 473).
- **Joy**
As a balancing programme in demanding driving situations
Information on the Joy programme see (→ page 473).
- **Refresh**
As a refreshing programme when temperatures rise

Information on the Refresh programme; see (→ page 473).

- **Warmth**
As a warming programme when temperatures drop
Information on the Warmth programme; see (→ page 473).

By connecting a Garmin fitness tracker, for example the Garmin vivoactive® 3, additional information can be entered into the evaluation for the recommendation of an ENERGIZING COMFORT programme. The additional information includes the stress level, that is calculated by the fitness tracker. The stress level is based primarily on the pulse rate.

Requirements for the integration of additional information via a Garmin fitness tracker:

- Your fitness tracker is connected with your Garmin account.
- Your Garmin account is connected with your Mercedes me user account.

If you wear your Garmin fitness tracker at night also, the sleep data is included in the evaluation of the ENERGIZING COACH.

Requirement for the integration of the sleep data:

- The Garmin fitness tracker is synchronised with the Garmin account before the beginning of the journey.
- ❗ If ATTENTION ASSIST determines an excessive lack of attention, ENERGIZING COACH makes no further suggestions. Further information about ATTENTION ASSIST (→ page 317).

■ Calling up the ENERGIZING COACH display

Requirements:

- The fitness tracker is connected with your Garmin account.
- Your Garmin account is connected with your Mercedes me user account in the Mercedes me ENERGIZING App.
- The mobile phone is connected to the multimedia system (→ page 525).

- You are logged in with your Mercedes me profile both in the vehicle and in the Mercedes me ENERGIZING App.

Multimedia system:

→  ► Apps ► ENERGIZING COACH

- Your current pulse as well as an evaluation of your pulse for the last 30 minutes driving time are shown. A corresponding fault message is shown if there is no mobile phone connected or no pulse can be sent to the system for an extended period.
-  Only pulse values in the range of 30 - 140 (possibly 150) bpm are shown on the central display. The pulse values have no medical validity but are only informative in nature and are therefore also not required to be accurate.

Navigation and traffic

Switching navigation on

Multimedia system:



→ 

- Alternatively, press the  button on the steering wheel on the right (→ page 437). The Zero Layer with the digital map is displayed.



Navigation overview

Digital map and user-specific applications





-  Navigation module (reduced view) or EQ module (reduced view)
Route guidance active:
Reduced view of the navigation module shows information relevant to the route, e.g. the next charging stop, the destination and a delay
 Ends the current route guidance
Tapping opens the navigation module in the expanded view with the **Route** (→ page 495)
Route guidance not active:
EQ module is shown in the reduced view

Tapping opens the EQ module in the expanded view with the charging functions (→ page 434)

- ② Destination entry
- ③ Calls up the Control Centre in the status line
- ④ Current vehicle position (vehicle symbol or arrow)
- ⑤ Display area with entertainment sources, phone, active applications and suggestions
- ⑥ Searches for POIs, e.g. charging stations  and parking facilities , as well as setting map orientation  and map type
- ⑦ Navigation window shows the next driving manoeuvre (zoomed out view) or the route monitor (zoomed in view)

Route guidance active: route monitor shows, e.g. route sections, upcoming driving manoeuvres with lane recommendations, charging stops, destination, traffic delays, 3D images at motorway exits, online content

-  Switches off navigation announcements
-  Switches on navigation announcements

The following map orientations ⑥ are available:

- 2D and to the north
 - 2D and direction of travel
 - 3D and direction of travel
 - Map with complete route
- ① If the map is moved, the map switches between 3D direction of travel and 2D north orientation.

The following map types ⑥ are available:

- Daytime display
 - Night-time display
 - Satellite map
- ① If you notice a problem with the digital map you can report this under <https://mapfeedback.here.com/#/report>.

Destination entry

Notes on destination entry

⚠ WARNING Risk of distraction from operating integrated communication equipment while the vehicle is in motion

If you operate communication equipment integrated in the vehicle when driving, you could be distracted from the traffic situation. This could also cause you to lose control of the vehicle.

- ▶ Only operate this equipment when the traffic situation permits.
- ▶ If you cannot be sure of this, stop the vehicle whilst paying attention to road and traffic conditions and operate the equipment with the vehicle stationary.

You must observe the legal requirements for the country in which you are currently driving when operating the multimedia system.

Entering a POI or address

Requirements:

Observe the notes on destination entry (→ page 478).

For the online search:

- There is an Internet connection.
- Mercedes me connect is available.
- The vehicle is connected with the user account and you have accepted the Mercedes me connect terms of use.
- Further information can be found at: <https://www.mercedes.me>
- The service is available and has been activated.

i If Online Search is not available, the search is performed using the data of the digital map.

Multimedia system:



Example: entering a POI or address

- 1 Input line with current entry
- 2 Search result
- 3 Selects destination search, displays further destination searches with double arrow
- 4 Deletes an entry

- 5 Adopts the search result in the input line and continues the search
- 6 Deletes the last character entered
- 7 Hides the keypad
- 8 Switches to handwriting recognition (→ page 454)
- 9 Starts the MBUX voice assistant (→ page 419)
- 10 Sets the written language
- 11 Switches to digits and special characters
- 12 Switches to upper-case or lower-case letters

▶ Enter a destination. The entries can be made in any order.
The search results are displayed in a list.

i Online search results for POIs may contain additional information, for example opening times and ratings. The information is provided by an online map service.
This online function is not available in all countries.

The following entries can be made, for example in **1**:

- Town, street, house number or street, town
- Postcode
- POI name or POI category, e.g. **Restaurants**
- Town, POI name
- Contact name
- Geo-coordinates (→ page 482)
- Three-word addresses from what3words (→ page 482)

Entering three-word addresses is possible in the online search .

- ▶ Hide the keyboard with **OK**.
- ▶ Select the destination in the list.
The following menu shows the selected destination with the address information and a corresponding map section.
The menu enables the route to be calculated.

Selecting a destination suggestion

Requirements

- The **Allow destination suggestions** option is switched on (→ page 463).
- The multimedia system has gathered sufficient data in order to show destination suggestions.

Multimedia system:



- ▶ Select **Suggestions**.

or

- ▶ Select a destination suggestion directly on the Zero Layer (→ page 431).
The route is calculated in the following menu.
- i** If **Suggestions** has been selected, a menu is available via **...**. The menu offers settings for the suggestions and memory functions.
- i** Managing destination suggestions (→ page 506).

Selecting previous destinations

Multimedia system:



- ▶ Select **Previous destinations**.

- ▶ Select the destination.

The following menu enables the route to be calculated.

- i** You can save a destination as a favourite (→ page 506).

Selecting a POI

Requirements

- **For the use of personal POIs:**
 - A USB device is connected with the multimedia system .
 - Personal POIs with the GPS Exchange format (.gpx) have been saved in the PersonalPOI folder on the USB device.

Multimedia system:



- ▶ Select **POIs**.

- ▶ Select one of the displayed quick-access categories, e.g. .
- ▶ Select the POI.
The following menu enables the route to be calculated.

or

- ▶ Select **All categories** or **Personal POIs** (see requirements).
- ▶ Select the category.
- ▶ Select the POI.
The following menu enables the route to be calculated.

Setting a search filter after selecting a POI category

The preset search position depends on the status of the route guidance:

- If route guidance is not active, **In the vicinity** is searched.
 - If route guidance is active, **Along the route** is searched.
- ▶ When the search results are displayed, select **Filter**.







- ▶ Select the search position, e.g. **In the vicinity**.
- ▶ If a route with intermediate destinations already exists and **Near destination** has been selected in the search filters, the destination is selected for the search.

or

- ▶ Select the desired travelling time to the point of interest.
- ▶ Select **Search results**.

Configuring categories for quick access

The categories are displayed:



- As symbols after calling up the destination entry via 
 - As a list after calling up **All categories**
- ▶ In the POI menu, select **All categories**.
 - ▶ Select  or  for a category.
Tapping on  adds the category.
Tapping on  removes the category.
 - ▶ Use  to change back.
The new categories are shown after the destination entry is called up the next time.

- ⓘ If all available quick-access positions are full, select the category to be replaced.

Changing the order of quick-access categories

- ▶ In the POI menu, press and hold a category for quick access.
- ▶ Tap on the arrows next to the selected category.
The arrows for the other categories are greyed out.
- ▶ Drag the category up or down.
- ▶ Select .

Deleting quick-access categories

- ▶ In the POI menu, press and hold a category for quick access.
- ▶ Select  for the chosen category.
- ▶ Select **Delete**.
- ▶ Select .

Changing categories for personal POIs

- ▶ Select **Personal POIs**.

- ▶ Press on a category as long as is necessary until a menu appears.
- ▶ Select **Change name** and enter a name.
- ▶ Select **Change icon** and select a symbol.
- ▶ Select **Delete** and confirm the prompt with **Yes**.

Selecting a contact for destination entry

Requirements

- A mobile phone is connected to the multimedia system (→ page 525).
- The contacts from the mobile phone have been downloaded .
- The contact has a navigable address.
- The address data can be located on the digital map.

Multimedia system:



- ▶ Enter a contact in the entry line.

- ▶ Select the address.
Alternatively, after calling up the destination entry, you can enter the name of a contact in the search field.

Entering geo-coordinates

Multimedia system:



- ▶ Enter the geo-coordinates as latitude and longitude.

Examples of input formats:

- 47°58'11"N 7°57'25"E (degrees, minutes and seconds)
 - 47.969722 7.956944 (decimal degrees)
- ▶ Confirm the entry.
The following menu enables the route to be calculated.

Entering the destination as a three-word address

Requirements

- An active Internet connection is indicated in the status line on the central display with the  symbol.
- The online search is active.

Multimedia system:



- ▶ Enter the destination as a three-word address from what3words. The entry can be made with spaces between the words instead of dots. The search results are displayed.
- ▶ Select the destination in the list.
The following menu enables the route to be calculated.

The Brandenburg Gate has this language dependent three-word address:

- German: tapfer.gebäude.verliehen
- English: that.lands.winning
- French: postaux.bobineur.ombrant

- ❗ Searching for a destination using three-word addresses is not possible in all countries and in all languages.

Alternatively, use the following entry options:

- Entry in the global search (→ page 448)
- Voice navigation (→ page 419)

Example: during a telephone call you are given a 3-word address. After activating the MBUX voice assistant, say one of the following two voice commands:

- Navigate to tapfer gebäude verliehen
- Navigate to tapfer Punkt gebäude Punkt verliehen



Three-word addresses from what3words are an alternative addressing system for multilingual georeferencing of global locations with a resolution of three metres. Using this grid, locations on the Earth's surface are included which do not have a building address such as a street and house number, for example.

- ❗ Three-word addresses are unique, easy to remember and suffice for most routine applications.

You can convert addresses to three-word addresses and back again:

- At the website <https://what3words.com>
- In the what3words apps

■ Selecting a destination on the map

Multimedia system:



- ▶ If necessary, move the map (→ page 512).
- ▶ Press and hold on the map. Available destinations are displayed.

or

- ▶ Briefly press on a POI symbol. The POI is selected. If there are several POIs at this map position, a list appears.
- ▶ Select the destination in the **Selected objects** list. The following menu enables the route to be calculated.

■ Selecting a destination from favourites

Requirements

- Destinations are saved as favourites. Save a previous destination or a destination suggestion as a favourite (→ page 506).

Multimedia system:



- ▶ Select **Favourites**.
- ▶ Select a favourite. The following menu enables the route to be calculated.

Addresses for home and work are already set

- ▶ Select **Home** or **Work**. The route is calculated in the following menu.

Addresses for home and work are not yet set

- ▶ Select **Home** or **Work**.
The prompt **No "Home" address available. Set address now?** appears, for example.
- ▶ Select **Yes**.
- ▶ Search for or select the address.
- ▶ Select **Save**.

Deleting favourites

- ▶ Select for a favourite.
- ▶ Select **Delete**.

or

- ▶ Select **Delete all**.
- ▶ Confirm the prompt.
When all the favourites have been deleted, **Add favourite** is available, for example.

■ Selecting received destinations

Requirements

- There is an Internet connection for receiving external destinations.
- A destination has been sent to the vehicle.

- Destinations have been shared from another seat in the vehicle.

Multimedia system:



The vehicle can receive destinations from services or apps. You will be informed when a destination is received.

- ▶ Select **Received destinations**.
- ▶ Select a destination.
The route is calculated in the following menu.
- ⓘ You can save a received destination in the favourites (→ page 506).

Deleting received addresses

- ▶ Delete a destination with .

or

- ▶ Select **Delete all**.

Route

■ Calculating a route with Electric Intelligence

Requirements:

- The destination has been entered.
 - The destination address is shown.
 - **For navigation with Electric Intelligence:**
 - Mercedes me connect is available.
 - You have a Mercedes me connect user account and the vehicle is connected with the account.
 - The "Navigation with Electric Intelligence" service is available and activated in the Mercedes me Portal.
- The services "Navigation with Electric Intelligence", "Display of charging stations" and "Mercedes me Charge" are required for optimal function.
- The **Schedule charging stops** route option is switched on (→ page 487).



Example: detailed display

- ① Saves destination as a favourite (**Schedule charging stops** is switched on)
Calls up alternative routes (**Schedule charging stops** is switched off)
- ② Calculates the route and starts route guidance

- ③ Selects a point of interest in the vicinity of the destination
- ④ Destination information, online content (e.g. pictures, opening hours), three-word address from what3words

The route with Electric Intelligence is automatically and intelligently calculated to the destination. This is updated during route guidance. The route with Electric Intelligence contains the required charging stops as intermediate destinations. The charging stations are determined taking account of the driving distance and the estimated charging times.

- ▶ Select one of the options.
- ① When the **Schedule charging stops** route option is switched off, a route without charging stations is calculated.
- ① If the destination is located in a multi-storey car park, for example, and corresponding data is available, the parking levels are displayed.

Saving a destination as a favourite

- ▶ Select **Favourite**.
- ▶ Select an option.

Calling up the route overview

- ① When **Schedule charging stops** is switched off, this option is available instead of the favourites function.

- ▶ Select **Routes**.
- ▶ Select an alternative route.

Starting route guidance

- ▶ Select **Let's go!**

Calling up the detailed display with destination address

- ▶ Pull the bar above the **Let's go!** symbol upwards.
Depending on the destination selection and availability, online content, for example ratings, prices and weather information, is shown.

If the destination is in a different time zone, a message is displayed.

- ▶ **To share a destination:** select **Share**.
This option allows you to scan the displayed QR code.

- ▶ **To call up an Internet address:** if a web address is available, select **Browser**.
- ▶ **To call the destination:** if a telephone number is available, select **Call**.

Searching for POIs in the vicinity of the destination shown

- ▶ Select **In the vicinity**.
- ▶ Search using categories, enter a search entry or search for a personal POI (→ page 480).

Adding an intermediate destination to the existing route or starting a new route guidance

- ▶ Select  **Add**.
The selected destination address is set as the next intermediate destination. Route guidance begins.
- ▶ **There are already four intermediate destinations:** confirm the prompt with **Yes** and select an intermediate destinations in the route overview (→ page 495), that should be overwritten with the new intermediate destination.

or

- ▶ Select  **Replace**.
The selected destination address is set as a new destination. Route guidance begins.

- ① If you call up the menu during route guidance, more options are available:
 - To change the order of destinations, select **Move** (→ page 497).
 - To delete the destination, select **Delete** (→ page 497).
 - To end route guidance, select **Cancel route guidance**.

Overview: Navigation with Electric Intelligence

If the **Schedule charging stops** route option is enabled, the optimal route based on time is calculated with the required charging stops. The charging stops are determined taking into account the route and charging times and are set as intermediate destinations for route guidance.

Navigation with Electric Intelligence constantly checks a large number of influencing variables, e.g. specifications for the climate control in the vehicle interior or changes in the weather. For each section of the route, the current energy

requirement is calculated from the high-voltage battery. The multimedia system determines the ideal charging stations along the route based on availability and charging power.

For each charging stop, the required amount of energy and the expected charging time is calculated and displayed. If the driver wishes, they will be informed by a notification on their mobile phone when the required state of charge is reached. The high-voltage battery continues to charge until the process is interrupted by the driver.

- ① Observe the notes on charging the high-voltage battery (→ page 276).

You can influence the route calculated by the navigation with Electric Intelligence.

The options "Ignore charging station" and "Add charging station" are available for this purpose (→ page 495).

- ① Navigation with Electric Intelligence attempts to shorten the total travel time, if necessary, by using the following charging strategies:
 - Charge twice briefly with high charging power instead of charging once for a long time with low charging power

- Charge once briefly with low charging power to reach a charging station with higher charging power

Navigation with Electric Intelligence uses the following data:

- Online Route
Route calculation establishes an Online Route. The Online Route is continuously updated during the journey, e.g. if traffic information is available.
- Specific vehicle information
The current state of charge of the high-voltage battery and electrical consumption are taken into account, for example.
- Charging stations
These are made available as intermediate destinations in the Online Route.

 This function is not available in all countries. You can watch an animation on this topic via the following link:

Switching on the Electric Intelligence route option

Multimedia system:



- ▶ Switch on the [Schedule charging stops](#) route option.
If the route has been calculated and the state of charge of the high-voltage battery is not sufficient to reach the destination, charging stations are set automatically as intermediate destinations.

 This function is not available in all countries.

Selecting settings for charging stations on the route

Requirements

- The "Navigation with Electric Intelligence" service is available and activated in the Mercedes me Portal.

The services "Navigation with Electric Intelligence", "Display of charging stations" and "Mercedes me Charge" are required for optimal function.

Multimedia system:



Setting the state of charge of the high-voltage battery when the charging station and destination are reached

- ▶ Select [Charge level at destination](#) or [Charge level at charging stations](#).
- ▶ Move the control knob to the left or right and set the preferred state of charge in percent (%).

To reach a charging station, the system uses the battery capacity, e.g. up to 10 % residual energy content (state of charge) or even less. The **Min.** message appears on the central display. You can increase this state of charge for the arrival at the charging station and destination, e.g. to 25 % at the charging station and 50 % at the destination.

-  In the event of increased energy consumption while driving, e.g. with headwind, the following options are available from the system:
 - The charging station is safely reached even at states of charge of less than 10 %.

- Navigation with Electric Intelligence selects a closer charging station for the route.
- i** If a charging facility is available at the destination, the state of charge can be lowered below 10 %. The **Min.** message appears on the central display. Make sure that the range monitor is switched on.
- i** When planning a route, you can enter another destination or the return journey. The navigation with Electric Intelligence then takes into account the required state of charge at the destination. This ensures that an optimal charging station or the new destination is reached safely on the onward journey.

Selecting a provider for charging stations

- ▶ Activate or deactivate **Mercedes me Charge**. If the option is activated, only charging stations payable with Mercedes me Charge are taken into account when selecting the charging station.

or

- ▶ Activate **All**. All charging stations known to the navigation system are taken into account when calculating routes with Electric Intelligence, regardless of the type of payment. It may be necessary to register with the provider.
- i** If route guidance is active, the high-voltage battery is tempered before a charging stop depending on the state of charge and the battery temperature.

Switching the range monitor on or off

Multimedia system:



The activated range monitoring assists with messages on the driver and central display to ensure safe arrival at the destination.

- ▶ Activate or deactivate **Range monitoring**. To reach the destination with the state of charge set by the driver, the range is permanently monitored when the option is switched on.

- i** If necessary, the range monitor in the speedometer shows a recommended maximum speed and informs you in the driver display, e.g. with the message **Avoid additional charging stop: drive less than 100 km/h**. Tips for saving energy are then also shown on the central display while driving.
- i** The recommended maximum speed is accounted for by the following driving systems:
- Active Distance Assist DISTRONIC (→ page 324)
 - Cruise control (→ page 319)
- i** This function is not available in all countries.

Showing charging stations on the map

Requirements:

- **For the display of online charging stations:**
 - Mercedes me connect is available.
 - You have a Mercedes me connect user account and the vehicle is connected with the account.

- The "Display of charging stations" service is available and activated in the Mercedes me Portal.



Multimedia system:



- ▶ Select **Schedule charging stops**.

Displaying on-board charging stations

On-board charging stations are included in the map data of the MBUX multimedia system navigation. The data on these charging stations is not updated regularly. In contrast, online charging stations are transmitted to the vehicle via an Internet connection and displayed on the map.

- ▶ Select **POI symbols** .
- ▶ Select **All categories** .
- ▶ Switch on the **Charging stations** category.

You can recognise charging stations in the vicinity of the current vehicle position on the map by the following symbols:

- Online charging stations

The charging power and availability are shown in the symbol for the charging station using arrows and a status indicator.

- On-board charging stations

The charging stations are shown on the map with white symbols without detailed information.

-  The display of the online charging stations is not available in all countries.

■ Paying for charging on a route with Mercedes me Charge

Requirements

- The Mercedes me Charge service is available and subscribed to in the Mercedes me Portal.
- The "Display of charging stations" and "Mercedes me Charge" services are activated.
- **To select the charging station using Navigation with Electric Intelligence:** the "Navigation with Electric Intelligence" service is activated and the **Schedule charging stops** option is switched on in the multimedia system.

- **For authentication at the charging station:** after activation in the Mercedes me Portal, you have concluded a charging contract with your payment details with the respective contractual partners.
- **For authentication using the app:** the Mercedes me App is installed on the external device, e.g. tablet or smartphone.
- For charging stations without the ability to be unlocked using the app, you have purchased an RFID card for the contractual partner.

-  This function is not available in all countries.

Multimedia system:



-  Observe the following information:
 - Read the notes on charging the high-voltage battery (→ page 276).
 - Read the notes on charging the high-voltage battery at the charging station (→ page 281) and (→ page 282).
 - **Before selection of a charging station:** the data for the charging stations is based on

the online content available from the respective third-party provider.

- Observe the local information and conditions.

i With the Plug & Charge charging function of Mercedes me Charge, you can charge the vehicle at public Plug & Charge-enabled charging stations. The charging process starts immediately when the charging cable is plugged into the charging station. No further authentication is required. Communication between the vehicle and the charging station takes place directly via the charging cable. This charging function is not available in all countries.

▶ **To select a charging station:** tap on a symbol on the map for a charging station or on a group of symbols for several charging stations.

or

▶ Select a charging station as a POI and accept it in the list (→ page 480).

or

▶ When route guidance is active with Navigation with Electric Intelligence, select a charging stop **1** in the route overview (→ page 495).

▶ Select **Details**.

When arriving at a charging station, the corresponding screen is automatically displayed if necessary.

The following information is displayed on the charging station (if available):

- Name of the charging station operator
- Address of the charging station
- Plug with availability and information about charging power
- Opening times
- Name of the charging station
- Travel time and distance of the charging station from the vehicle
- Authentication method
- Contact information of the charging station operator
- General costs and charging costs

- Estimated charging costs and your available energy volumes, if available
- Display of available reviews and the ability to review with up to five stars
- Availability prognosis
- Information on green charging

Mercedes-Benz provides high-quality certificates of origin to ensure that an equivalent amount of electricity from renewable sources is fed into the grid for charging processes carried out via Mercedes me Charge.

▶ Calculate the route (→ page 484).

i If the function is available, the start/stop of the charging process can be selected.

Authentication at the charging station (start/stop)

i During authentication, the contract data is checked at the charging station. If the check is successful, the charging process is authorised. Payment is made automatically via the payment method specified in the contract.

Depending on the charging station operator, authentication is first carried out at the charging station. The charging cable of the charging station is then unlocked. Alternatively, first plug the charging cable connector into the vehicle socket and then carry out authentication at the charging station.

i For some charging stations, unlocking the charging station via the app is not available. In this case use your RFID card to activate the charging process (if available).

▶ In the app or on the MBUX multimedia system, select a charging station in the map menu.

▶ Display the details using the widget (programme symbol).

▶ Select **Start charging process**.

The charging process starts. In addition, the payment agreement saved with the third-party provider is authorised.

▶ If required, enter the PIN for personalisation.

▶ Confirm the action.

▶ If required, select the connector ID from the list shown.

The selected charge port is unlocked.

▶ Start the charging process.

The start of the charging process is shown.

▶ Select the **Stop charging process** display button in the app.

The charging process is ended.

Payment is processed automatically.

If data for third-party providers is available, you will receive this information:

- Overview of the charging process
- Estimated cost

i There may be differences between the costs listed and the costs billed.

You can watch an animation on this topic via the following link:

■ Overview of the Range on Map service

If there are only a few fast-charging stations or charging stations available within the vehicle's electric range, the service warns you with a notification. The notification recommends charging sta-

tions made available to the service by charging station providers/operators.

The function is available under the following conditions:

- The "Range on Map" service, which is subject to a charge, is available and activated in the Mercedes me Portal.
- The route type **Online routes** is switched off (→ page 492).

There are three notification types:

- Comfort warning
There are no longer enough fast charging stations nearby.
- Warning when electric range falls below 50 km
As soon as the vehicle falls below the electric range of 50 km, the next charging stations in the vicinity are suggested.
- Critical warning
There are less than five charging stations including fast charging stations nearby.

 If you do not want to receive notifications, deactivate the option **Allow notifications** (→ page 447) for the "Range on Map" service.

In addition, the electric range can be displayed on the map (→ page 517).

 If the electric range of the vehicle is less than 6 km, there is no display on the map. If there are not enough charging stations available within this range, you will receive a notification.

 If the route type **Online routes** is switched on, you will not receive any notifications.

Overview of charging near destination

The function is available under the following conditions:

- The destination has been entered.
- The destination address is shown.
- **For navigation with Electric Intelligence:**
 - Mercedes me connect is available.

- You have a Mercedes me connect user account and the vehicle is connected with the account.
- The "Navigation with Electric Intelligence" service is available and activated in the Mercedes me Portal.

The services "Navigation with Electric Intelligence", "Display of charging stations" and "Mercedes me Charge" are required for optimal function.

The function suggests the best possible charging stop near the destination from which you can reach the destination on foot.

The digital map shows the following information, for example:

- The route to the destination
- The route to the charging stop
- The pedestrian route from the charging stop to the destination and the walking time in minutes

The following functions can be used, for example:

- Select the charging station as the destination and calculate the route.
- Move the map and reset the map to the current vehicle position.
- Change the map scale.
- Select additional map symbols, e.g. for displaying traffic information or hazard warnings from Car-2-X.

Selecting a route type

Multimedia system:



Using online routes

The route is calculated as a fast route with a short journey time.

If available, you can select online routes.

 Online routes are not available in all countries and for all vehicles.

 **To use online routes:** switch on the option.

Taking traffic information for the route into account

- ▶ Select **Dynamic route guidance** .
- ▶ Select one of the options.

Explanation of the options:

- **Automatic**

Traffic reports via Live Traffic Information are taken into account (→ page 506).

Live Traffic Information and FM home screen are not available in all countries.

- **After asking**

A prompt appears when a new route is detected with a shorter journey time based on traffic reports. You can continue to use the current route or use the dynamic route instead (→ page 493).

- **Off**

No traffic reports are taken into account for the route.

Calculating alternative routes

Requirements

- The **Schedule charging stops** option is switched off (→ page 487).

Multimedia system:

  **EQ**  **View**

- ▶ Activate **Overview of route after start**. Alternative routes are calculated for every route.

 When **Schedule charging stops** is switched on, the route is calculated with Electric Intelligence.

Accepting a detour recommendation after a prompt

Requirements:

- **After asking** is switched on (→ page 492) in the **Dynamic route guidance** menu.
- Route guidance is active.
- There are traffic reports for the current route.

If a new route with a shorter driving time is determined, the current and new routes will be shown.

If another application is active, a notification is hidden.

- ▶ Confirm the notification.
- ▶ **To accept the new route:** select **Accept**.
- ▶ **To maintain the current route:** select **Keep to current route**.

Selecting route options

Multimedia system:

  **EQ**  **Route**

▶ **Avoid options**

Avoiding or using route sections, e.g. motorways or ferries

- ▶ Activate or deactivate the avoid option.
 - Avoid:** the option is activated. The route avoids motorways, for example.
 - Use:** the option is deactivated. The route takes motorways into consideration, for example.

- i** The selected route options cannot always be taken into account. Therefore, a route may include a ferry, for instance, even though the **Avoid ferries** avoid option is enabled. A message then appears and you will hear a corresponding message.

Avoiding or using toll roads

The use of toll roads requires a usage fee (toll).

- ▶ Select **Toll roads** .

- ▶ Activate or deactivate **Avoid all**.

If the option is activated, the route avoids toll roads.

If the option is deactivated, the route takes toll roads into account.

or

- ▶ Select an option for **Payment by cash or card** or **Electronic billing**.

Avoid: the route avoids toll roads with the selected method of payment.

Use: the route takes into account roads that require a toll corresponding with the payment type selected.

Avoiding or using roads requiring a special toll sticker

A vignette allows for the use of a route network for a limited time period.

- ▶ Select **Avoid vignette roads** .

- ▶ Activate or deactivate **Avoid all**.

or

- ▶ Switch individual countries on or off in the list.
Avoid: the option is activated. The route avoids roads requiring a special toll sticker in the selected countries.

Use: the option is deactivated. The route takes into account roads in the selected country which require you to pay a time-based fee (vignette).

- i** These route options are not available in every country.

Avoiding areas

- ▶ Select **Avoid areas**  (→ page 514).

Selecting notifications for the route

Requirements

- **For an audible indication when approaching a personal POI:** the USB device contains personal POIs.
- The USB device is connected with the multimedia system.
- The category in which the personal POI belongs is activated.

Multimedia system:



- ▶ **Messages & tones**

Switching navigation announcements on or off

- ▶ Activate **Reduced messages**.
If a driving instruction is available for a simple change in direction, you hear a brief announcement, e.g. "turn right in 200 m". The number of driving instructions along the route is minimised.
- ▶ Activate **Detailed messages**.
If a driving instruction is available and there is a complex driving situation, you hear supple-

mentary information, e.g. "In 200 m turn right and continue to follow the major road". Additional driving instructions are issued for the route, for example on turning major roads.

- ▶ Activate **Announce street names**.

The name of the street into which the vehicle should turn is announced.

- ⓘ This option is not available in all countries and languages.

Switching traffic announcements on or off

- ▶ Activate or deactivate **Announce traffic warnings**.

If available, traffic warnings are announced, e.g. before the end of traffic jams that pose a risk.

Audible indication when approaching a personal POI

- ▶ Select **Personal POIs**.
- ▶ Activate a category.
When approaching a personal POI in the selected category an audible indication will be issued.

■ Displaying a route overview with charging station

Requirements:

- A destination is entered.

Multimedia system:



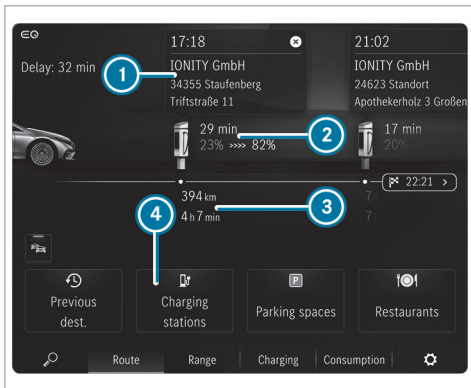

- ➊ Arrival time at charging stop, type of charging station
- ➋ Charging stop shows the charging time recommended by the navigation with Electric Intelligence as well as states of charge on arrival and onward journey for an optimal travel time

- ➌ Distance from current vehicle position and remaining driving time
- ➍ Searches for an additional charging station

When route guidance is active, the charging stops, entered intermediate destinations the destination are shown.

Depending on the route, traffic situation and available data, further information is displayed:

- Name, destination address
- Symbols for intermediate destination and destination
- Phone number (if available)
- Web address (if available)
- Traffic information

You can influence the route calculated by the navigation with Electric Intelligence using options ➊ and ➍.

- ▶ Select one of the options.

Ignoring a charging station

If you do not want to drive to the selected charging station, it can be removed for the current



route guidance. The navigation with Electric Intelligence tries to plan the best possible alternative charging station for the route.

- ▶ Select ➊.
The expected charging output, the dynamic charge level display as well as the current state of charge and the predicted charging target are displayed, for example.
- ▶ Select **Ignore**.
- ▶ Select **Ignore during this journey**.
The charging station is removed from the route.
- ➊ After selecting **Details**, the detailed information about the charging station is displayed.

Adding a charging station

If you want to drive to a charging station on the route earlier than planned, for example, you can search for an additional charging station. If the charging station is suitable for the route, it will be accepted by the navigation with Electric Intelligence.

- ▶ Select ➍.

- ▶ If necessary, filter the display of the charging stations according to the charging power.
 - ▶ Select a charging station.
- ① You can also search for a charging station using the  symbol on the digital map or next to  **Where to?**(→ page 477).

■ Planning routes

Requirements:

- A destination is entered.

Multimedia system:



- ▶ Enter the intermediate destination (→ page 30).
After entering the destination and new calculation of the route, the route overview is shown again. The route contains a new intermediate destination.
- ① If there are already four intermediate destinations, delete an intermediate destination (→ page 497).

■ Editing a route with intermediate destinations



Requirements:

- The destination and at least one intermediate destination have been entered.

Multimedia system:



Changing the order of the destinations

- ▶ In the route overview, press and hold on a destination.
 - ▶ Move the destination with  or .
 - ▶ Tap on .
- The editing mode is ended.

Deleting a destination

- ▶ In the route overview, press and hold on a destination.
 - ▶ Tap on .
- The editing mode is ended.

■ Displaying the route list

Multimedia system:



- ▶ Tap on the navigation window  (→ page 477).



Example: route list

- ① Route sections with turning arrow, distance to change of direction, road number, road name
Current driving manoeuvre at the top of the list
Destination at the end of the list
- ② Current vehicle position

The route sections are displayed in the navigation window. The route list is updated during the journey.

i Motorway information shows the available service facilities. After selecting symbols, e.g. for car parks, service areas or motorway exits, the POI is adopted as an intermediate destination or destination.

- ▶ Press the arrow at the bottom of the navigation window briefly.
- ▶ Swipe up or down.
- ▶ Select a route section.
The map section is displayed.
- ▶ **To return to vehicle position:** select **Current position**.

■ Selecting an alternative route

Requirements

- A route has already been created.
- The **Overview of route after start** option is switched on (→ page 493).
- The **Schedule charging stops** option is switched off (→ page 487).

i When **Schedule charging stops** is switched on, the route is calculated with Electric Intelligence. Alternative routes are then not available.

Multimedia system:

 EQ ▶▶ **Route** ▶▶ **Other routes**

The original route and alternative routes with indication of the travel time difference are displayed on the map. An alternative route can also be a faster route, but one that is significantly longer.

The following route information is displayed:

- Driving time
- Time of arrival
- Distance to the destination
- Avoid options based on the set route options
- Driving time saved or lost compared with the original route

▶ When the alternative routes have been calculated, display the route in the navigation window by swiping to the right or left.

Changing route type

- ▶ Select **Filter**.
- ▶ Switching the route type on or off.

Avoiding or using route options

- ▶ Select **Filter**.
- ▶ Switch the route options on or off (→ page 493).
- ▶ Confirm the settings with **Finished**.
- ▶ **To start route guidance to the alternative route:** select **Start**.
- ▶ **To select an alternative route on the map:** touch any point on the alternative route. The alternative route is highlighted.

■ Activating a commuter route



Requirements:

- You have created a profile (→ page 441).
- The **Allow destination suggestions** option is switched on (→ page 463).
- The **Activate commuter route** option is switched on.

- The multimedia system has gathered sufficient data in order to show destination suggestions.
 - Routes have been learned for these destination suggestions.
 - Route guidance is active.
-  This commuter route is not available in all countries.

Multimedia system:



- ▶ Activate **Activate commuter route**.
The navigation system automatically detects that the vehicle is on a commuter route.
For the daily commuter route, traffic events on the route are also reported when driving without active route guidance.
 - ▶ **To select commuter route:** select **Start**.
Route guidance begins without spoken driving instructions.
-  A commuter route is suggested even with delays on the route.
- ▶ **To delete a commuter route:** select .

Adjusting the route on the map

Requirements:

- A route has already been created.

You can change the course of the original route on the map. A new intermediate destination is set in the process.

-  If the maximum number of intermediate destinations is reached, the function is not supported. Press the **OK** button to confirm the message.
- ▶ Press and hold lightly on the route.
A symbol appears. The route can be changed.
 - ▶ Drag and hold the route with your finger to a desired map position.
The new route is displayed. The route is recalculated.
When the route is calculated, the journey time and distance are compared with the original route.
When the finger is pulled away from the display, the intermediate destination is shown on the map.

- ▶ Accept the route with **Confirm** or reject it with **Cancel** and return to the original route.



Starting the automatic service station search

Requirements

- ATTENTION ASSIST is activated (→ page 317).
- You are driving on a motorway.
- There are service stations along the route section ahead.

Driving situation

The following notification is shown on the central display **ATTENTION ASSIST Tap here to search for rest areas..**

- ▶ Confirm the notification.
The service station search starts. The available service stations along the route or in the vicinity of the vehicle's current position are displayed.
- ▶ Select a service station.
- ▶ Calculate the route with the service station as an  intermediate destination or as a  destination (→ page 484).

- ▶ **If there are already four intermediate destinations:** select **Yes** in the prompt. The selected service station is entered in the route overview at position 1. Intermediate destination 4 is deleted. Route guidance begins.

Starting and editing a stored route

Requirements:

- A USB device with stored routes is connected with the multimedia system (→ page 572).
- The route is stored in the "Routes" folder with the GPS Exchange format (.gpx).

Multimedia system:



- ▶ Press the double arrow in the destination input line until **Stored routes** is displayed.
- ▶ Select **Stored routes**.

Starting a saved route

- ▶ Select a route.
- ▶ Select **Start: route guidance at start** or **Start: current location**. Route guidance begins.

Renaming a route

- ▶ Press on a route until a menu is shown.
- ▶ Select **Rename**.
- ▶ Enter the name.
- ▶ Select **OK**.

Recording and storing a route

Requirements:

- A USB device is connected with the multimedia system (→ page 572).

Multimedia system:



- ▶ Press the double arrow in the destination input line until **Stored routes** is displayed.
- ▶ Select **Stored routes**.

Starting recording

- ▶ Select **Start recording**. A white rectangle is displayed. The route is stored on the USB device.

Stopping recording

- ▶ Press the white rectangle.
- ▶ Select **End recording**.

Route guidance

Notes on route guidance

⚠ WARNING Risk of distraction from operating integrated communication equipment while the vehicle is in motion

If you operate communication equipment integrated in the vehicle when driving, you could be distracted from the traffic situation. This could also cause you to lose control of the vehicle.

- ▶ Only operate this equipment when the traffic situation permits.
- ▶ If you cannot be sure of this, stop the vehicle whilst paying attention to road and traffic conditions and operate the equipment with the vehicle stationary.

You must observe the legal requirements for the country in which you are currently driving when operating the multimedia system.

Route guidance begins once a route has been calculated. The road and traffic rules and regulations always have priority over multimedia system driving instructions. Driving instructions are, for example navigation announcements, changes in direction and lane recommendations.

Changes in direction and lane recommendations are shown in the navigation window.

The following displays and functions are also available in the navigation window, for example:

- Route list
- Destination information
- Traffic information, e.g. length of traffic jam, delay
- Motorway facilities
- Car park search
- Emergency corridors

If you do not follow the driving instructions or if you leave the calculated route, a new route is calculated automatically.

If, for example, the route is diverted or the direction of a one-way road has been reversed, driving instructions may deviate from the actual traffic situation.

Alternatives may be offered during route guidance, e.g. before passing a motorway exit road. The additional driving time for the journey along the motorway exit is shown.

For this reason, you must always observe road and traffic rules and regulations during your journey as well as the prevailing traffic conditions.

The route can differ from the ideal route, for example in the event of roadworks or incomplete digital map data.

Notes on satellite reception

The correct function of the navigation system depends amongst other things on reception of the satellite system used. In certain situations satellite reception can be impaired, malfunction or even not be possible, e.g. in tunnels or in multi-storey car parks.

Changing direction overview

Changes of direction are shown in the following displays:

- Detailed image of the junction
The display appears when you drive into a junction.
- 3D image
The display appears when driving on junction-free, multi-lane roads, for example at motorway exits and motorway interchanges.



Example: detailed image of the crossing with upcoming changes of direction

- ① Name of the street to turn into
- ② Change of direction arrow (also on the map)
- ③ Current distance to the change of direction



Example: 3D image of the upcoming change of direction

- ① Manoeuvre point
- ② Change of direction arrow (also on the map)
- Larger map scales show change of direction points instead of change of direction arrows.
- ③ Current distance to the change of direction
- ④ Current vehicle position

There are three phases when changing direction:

- Preparation phase

If there is enough time between the changes of direction, the multimedia system prepares you for the upcoming change of direction. A navigation announcement is issued, e.g. "Prepare to turn right".

The navigation window shows: the direction information or the name of the road which is to be turned into as well as the distance to the change of direction.

- Announcement phase

The multimedia system announces the upcoming change of direction, e.g. by announcing "Turn right in 300 m".

When the **Auto zoom** map orientation is switched off (→ page 516), a detailed representation of the junction or a 3D image of the upcoming change in direction appears in the navigation window.

- Change-of-direction phase

The multimedia system announces the imminent change of direction, e.g. by announcing "Now turn right".

Example of 3D image: when the distance to manoeuvre point ❶ is shown with 0 m and the symbol for current vehicle position ❷ has reached manoeuvre point ❶ the change in direction is carried out.

- ❶ Changes in direction are also displayed on the driver's display and head-up display.

Lane recommendations overview



- Example: lane recommendations
- ❶ Lane not recommended (grey arrow)
 - ❷ Possible lane (white arrow)
 - ❸ Recommended lane (white arrow, blue background)

This display appears for multi-lane roads.

If the digital map contains the relevant data, lane recommendations are displayed in the navigation window.

Explanation of the displayed lanes:

- Recommended lane
In this lane, you will be able to complete both the next change of direction and the one after that.
- Possible lane
In this lane, you will only be able to complete the next change of direction.
- Non-recommended lane
In this lane, you will not be able to complete the next change of direction without changing lane.

During the change of direction, new lanes may be added. Bus lanes are also shown.

- ❶ Lane recommendations are also displayed on the driver's display and head-up display.

Using motorway information

When driving on the motorway, upcoming motorway facilities and available service facilities are

shown in the route list. These include car parks, service stations or motorway exits with service POIs, for example.

The entries are sorted according to increasing distance from the current vehicle position.

- ▶ Select an entry.
- ▶ If several service facilities are available, select a service facility from the list. The destination address and the map position are shown.
- ▶ Calculate the route (→ page 484).

or

- ▶ Search for a POI in the vicinity.

or

- ▶ Use other functions, e.g. store the destination address of the service facility.

Destination reached

Once the destination is reached, you will see the  chequered flag. Route guidance will now be complete. The navigation menu is shown.

When an intermediate destination has been reached, you will see the intermediate destination



flag with the number of your  intermediate destination. Route guidance is continued.

Switching navigation announcements on or off

Switching off

- ▶ Press the  button on the right of the steering wheel or on the MBUX multimedia system during a navigation announcement (→ page 451). The **Spoken driving recommendations have been deactivated.** message appears.

or

- ▶ In the navigation window, select  for an upcoming driving manoeuvre. The symbol changes to .

Switching on

- ▶ Press the  button again on the right of the steering wheel or on the MBUX multimedia system.

or



- ▶ In the navigation window, select  for an upcoming driving manoeuvre. The current navigation announcement is played.

The symbol changes to .

Switching navigation announcements on or off during a phone call

- ▶ When the zero layer is shown, press the  button on the right side on the steering wheel (→ page 437).

or

- ▶ Select  on the zero layer. The applications are displayed.
- ▶ Select **Settings**.
- ▶ Select **System**.
- ▶ Select **Audio**.
- ▶ Select **Navigation & traffic announcements**.
- ▶ Activate or deactivate **Driving recommendations during call**.
- ▶ **To leave the menu:** select .

Adjusting the volume of navigation announcements

Multimedia system:

→  ► Settings ► System ► Audio
► Navigation & traffic announcements

- ▶ Select **Driving recommendation vol..**
- ▶ Set the volume.
- ▶ **To leave the menu:** select .

Route guidance is active

- ▶ Set the volume during a navigation announcement on the steering wheel or under the touchscreen (→ page 453).

Switching audio fadeout on or off during navigation announcements

- ▶ Press the  button on the steering wheel on the right.

or

- ▶ Press  in the central display.
- ▶ Select **Settings**.
- ▶ Select **System**.
- ▶ Select **Audio**.

- ▶ Select **Navigation & traffic announcements**.
- ▶ Activate or deactivate **Audio fadeout during navigation announcements**.
- ▶ **To leave the menu:** select .



Repeating navigation announcements

Requirements

- A route has already been created.
- Route guidance is active.

Multimedia system:

→ 

- ▶ In the navigation window, select  for an upcoming driving manoeuvre.
- ▶ Select .
The current navigation announcement is repeated.

Cancelling route guidance

Requirements

- A route has already been created.
- Route guidance is active.

- ▶ Select  in the navigation module (→ page 477).

Overview of off-road status during route guidance

Due to roadworks, for example, there may be differences between the data on the digital map and the actual course of the road. In such cases, the multimedia system will temporarily be unable to locate the vehicle's current position on the digital map. The vehicle is off-road. **Road not mapped** will be shown. Route guidance may be restricted.

When the vehicle is back on a road known to the multimedia system, route guidance continues as normal.

Destination

Saving the current vehicle position

Multimedia system:

→ 

- ▶ When the map is shown, tap on the  current vehicle position.
- ▶ Select **Store position**.

- ▶ To save as a favourite: select **Save as favourite**.
- ▶ To save as "Home" address: select **Home**.
- ▶ To save as "Work" address: select **Work**.

Managing previous destinations

Multimedia system:



- ▶ Select **Previous destinations**.

Saving the last destination as a favourite

- ▶ For a last destination, select . A menu appears.
- ▶ To save as a favourite: select **Save as favourite**.
- ▶ To save as "Home" address: select **Home**.
- ▶ To save as "Work" address: select **Work**.

Deleting a previous destination

- ▶ For a last destination, select .
 - ▶ Select **Delete**.
- or
- ▶ Select **Delete all**.

- ▶ Confirm the prompt. When all the favourites have been deleted, **Add favourite** is available, for example.

Editing destination suggestions

Requirements:

- The **Allow destination suggestions** option is switched on (→ page 463).
- For the display of destination suggestions: the multimedia system has gathered sufficient data.

Multimedia system:



- ▶ Press and hold on a destination suggestion. A menu appears.
 - ▶ To cancel a destination suggestion: select **Do not suggest now** or **Do not suggest**.
 - ▶ To save a destination suggestion: select **Save as favourite**, **Home** or **Work**.
-  Delete a destination suggestion from the favourites (→ page 483).

Route guidance with current traffic reports

Traffic information overview

Current traffic reports are received with the Live Traffic Information subscription service.

If the subscription has expired, then FM RDS-TMC is available in selected countries.

-  Live Traffic Information is not available in all countries.

The service must be registered in the Mercedes me user account (→ page 507). This secures the free-of-charge period of three years.

The service updates the traffic situation via the Internet connection at short, regular intervals.

Information on the vehicle's position is regularly sent to Mercedes-Benz AG. The data is immediately rendered anonymous by Mercedes-Benz AG and forwarded to the traffic data provider. Using this data, traffic reports relevant to the vehicle's position are sent to the vehicle. The vehicle acts as a sensor for the flow of traffic and helps to improve the quality of the traffic reports.

- ⓘ There may be differences between the traffic reports received and the actual road and traffic conditions.

If you do not want to transmit the vehicle position, you have the following options:

- You deactivate the service in the Mercedes me user account.
 - You have the service deactivated at a Mercedes-Benz service centre.
- ⓘ Further hazard warnings are received using the Car-to-X service (→ page 509).

■ Showing information from the service provider for Live Traffic Information

Requirements:

- The vehicle is equipped with Live Traffic Information.

Multimedia system:

- ▶  ▶ Apps ▶ Mercedes me
- ▶ My services
- ▶ Select Live Traffic.

When the subscription for Live Traffic Information has expired then in selected countries FM RDS-TMC is available.

■ Registering Live Traffic Information

Requirements:

- The vehicle is equipped with Live Traffic Information.
 - You have a Mercedes me user account.
- ▶ Create a Mercedes me user account at: <https://www.mercedes.me>. A valid email address is required for this.
 - ▶ Register the vehicle using the vehicle identification number (VIN).
 - ▶ Connect the vehicle with your Mercedes me user account. A code is sent to the multimedia system.
 - ▶ Enter the code into the multimedia system.
 - ▶ Accept the general and specific terms of use.
- ⓘ Alternatively, you can have the connection completed at a Mercedes-Benz service centre.

■ Extending a Live Traffic Information subscription

Requirements:

- The vehicle is equipped with Live Traffic Information.
 - You have a Mercedes me user account.
- ▶ Call up the Mercedes me website.
 - ▶ Call up the Mercedes me user account.
 - ▶ Switch to the Mercedes me Store via the linked vehicle.
 - ▶ Select Live Traffic Information.
 - ▶ Select the renewal period.
 - ▶ Add the product to the shopping basket.
 - ▶ Accept the general and specific terms of use. Live Traffic Information remains activated for the selected extension period. Activation begins on the date of extension.

■ Displaying traffic information on the map

Requirements

- **Traffic incidents** and **Free-flowing traffic** are switched on (→ page 509).

Multimedia system:



▶ If necessary, move the map (→ page 512).

The map shows the following traffic information depending on the activated settings:

- Traffic incidents

These are roadworks, road blocks and warning messages, for example.

When route guidance is active, the symbols for traffic incidents will be shown in colour on the route. Off the route they are grey.

- Warning messages

Warning messages are shown as the  symbol.

Traffic safety information can be shown, e.g. if there are people on the carriageway.

If the vehicle approaches a danger area, for example the end of a traffic jam in a dangerous position, the  symbol is shown on the map. If **Announce traffic warnings** is switched on and a message has been issued, an additional announcement is made.

- Traffic flow information:

- Traffic jam (red line)
- Slow-moving traffic (orange line)
- Heavy traffic (yellow line)
- Free-flowing traffic (green line)

- Display for traffic delays on the current route
The smallest value for the display for traffic delays is a minute.

Showing traffic incidents on the route

Requirements

- The **Traffic incidents** display is switched on (→ page 509).

Multimedia system:



If there are traffic incidents on the route, these are shown on the map and in the route overview.

- ① With the MBUX Voice Assistant you can inform yourself about traffic incidents on your route. Ask, for example **How is the traffic on my route?** or **How is the traffic at home?.** A voice output is given.



Example: traffic incidents on the route

- ① Delay
- ② Colour display of traffic flow information, delay and length, road name or road number
- ③ Switches traffic information display on or off

- ① During active route guidance, the total delay on the route is displayed:
 - in the navigation system in the navigation window
 - in other applications in the status line at the top

A traffic incident symbol is, for example  for roadworks.

In the map several traffic incidents may be shown on top of each other. The traffic incident symbol shows a plus sign.

If available, the street number can be replaced by a street name or both the name and number.

- ① If a message about forming an emergency corridor has been issued, **Emergency corridor** is shown in the navigation window.

- ▶ To see all of the traffic incidents on the route, swipe to the right or left. The route section is highlighted on the map.

- ▶ **To show detailed information in the route overview:** tap on a display in the route overview. The detailed information is shown, for example the road section and the direction.

Calling up detailed information on the map

- ▶ Tap on traffic flow information on the map, e.g. a red line for a traffic jam section. The detail information is displayed.
- ▶ If several lines are shown on top of the other, then select an item of traffic flow information from the list.

Showing traffic incidents on the map

- ▶ Tap on a traffic incident symbol. The detail information is displayed.
- ▶ **Several traffic incidents are in the immediate vicinity:** tap on the top traffic incident symbol and select from the list of traffic incidents.

Switching the traffic information display on Multimedia system:



- ▶ Select **View**.

- ▶ **Traffic .**
- ▶ Activate **Traffic incidents** and **Free-flowing traffic**. Traffic incidents, for example roadworks, local area reports (e.g. fog) and warning messages, are shown on the route.
- ▶ **To switch traffic information in the quick-access on or off:** tap on  in the route overview (→ page 495). The indicator lamp lights up or is off.

Car-to-X-Communication

Car-to-X-Communication overview

The following requirements apply for the Car-to-X-Communication service:

- The vehicle is equipped with an MBUX multimedia system with navigation function.
- There is a subscription for the Live Traffic Information service.
- The Car-to-X-Communication service is activated in your Mercedes me user account.

- ❶ Car-to-X-Communication is available in selected countries.

The communication module automatically establishes an Internet connection once the vehicle is switched on. If there are any hazard warnings, they will be provided shortly thereafter. Depending on the mobile phone connection, provision takes place from within a second up to about a minute.

Benefits of Car-to-X-Communication:

- Dangers are automatically detected by the vehicle or can be reported by the driver. These are then sent to vehicles with Car-to-X-Communication in the immediate vicinity.
- If available, current details relating to hazard spots near the vehicle's current position are received.

This gives you sufficient time to adapt your driving style to the traffic conditions.

The use of Car-to-X-Communication requires the regular transmission of vehicle data to Mercedes-Benz AG. The data is then immediately pseudonymised by Mercedes-Benz AG. The vehicle data is deleted after an appropriate amount of time has

elapsed (several weeks) and is not stored permanently.

- ❶ Data which serves as identification is replaced during the pseudonymisation process. In this way, your identity is protected against access by unauthorised third parties.

■ Displaying hazard warnings

Multimedia system:



If hazard warnings are available these can be shown as symbols on the map. The display depends on the settings for the **Traffic incidents** option.

- ▶ Select **EQ**.
- ▶ Select .
- ▶ Activate or deactivate **Traffic incidents**.
If the option is activated, all of the symbols are shown.
If the option is deactivated, the symbols are only shown when there is a hazard warning.

The following hazards may be shown on the map:

- Accidents and breakdowns

- Slippery roads, fog, crosswinds and heavy rain
- Hazards reported manually
- Vehicle with active hazard warning light
- Roadworks
- Additional hazards (if available)

- ❶ If **Announce traffic warnings** is switched off (→ page 494), voice output can indicate a danger area.

■ Sending hazard warnings

Reporting hazards manually

- ❶ Automatically detected hazard warnings are sent by the vehicle.
- ▶ When the map is shown, tap on the  current vehicle position.
The **Position** menu is shown.
- ▶ Select **Report traffic incident**.
The **Thank you for supporting accident prevention!** message appears.

Route guidance with augmented reality

Overview of route guidance with augmented reality

⚠ WARNING Risk of accident and injury as a result of distraction, incorrect depiction or wrong interpretation of the display

The camera image of the augmented reality display is not suitable as a guide for driving.

- ▶ Always keep an eye on the actual traffic situation.
- ▶ Avoid extended observation of the camera image.

During route guidance with augmented reality a camera image with the real traffic scene is shown on the central display before a turning manoeuvre. The camera image includes additional information, for example arrows indicating a change of direction.

If the options are switched on and this additional information is available, road names and house numbers are displayed (→ page 512).



- ① House number
- ② Street name
- ③ Change of direction arrow

Route guidance with augmented reality will not be available in some situations, e.g. in the event of poor satellite reception or roads that have not been digitised.

Route guidance with augmented reality is not available in all countries.

You can watch an animation on this topic via the following link:

Activating route guidance with augmented reality

⚠ WARNING Risk of accident and injury due to imprecise positioning of additional information

The additional information from the augmented reality display may be inaccurate and is not a substitute for observing and assessing the actual driving situation.

- ▶ Always keep an eye on the actual traffic situation when carrying out all driving manoeuvres.

Multimedia system:



- ▶ Select **View**.
- ▶ Select **Augmented reality video**.
- ▶ Activate or deactivate **Augmented reality video**.
The camera's video image is shown on the central display before a turning manoeuvre. The video image includes additional information.

Showing property information for route guidance with augmented reality

Requirements:

- Augmented reality is activated (→ page 511).

Multimedia system:



- Select **View**.
- Select **Augmented reality video**.
- Activate **Street names** and **House numbers**. During route guidance, the activated options are shown as additional information in the camera image.

Map and compass

Setting the map scale

Multimedia system:



Zooming in

- When the map is shown, tap twice quickly with one finger on the central display.

or

- Move two fingers apart on the central display.

Zooming out

- Tap with two fingers on the central display.

or

- Move two fingers together on the central display.

- i** You can set the unit of measurement of the map scale (→ page 462).

Moving the map

Multimedia system:



- When the map is displayed, swipe in any direction with one finger on the central display.

The following functions are available:

- Select a destination on the map (→ page 483).
- Select a POI (→ page 480).
- Show traffic incidents on the map (→ page 508).

- To reset the map to the current vehicle position:** select  **Centre**.

Switching the route overview after start on or off

Multimedia system:



- Select **View**.
- Activate or deactivate **Overview of route after start**. If the option is enabled, the map shows the full route after route guidance is started and, if available, all alternative routes.

Selecting POI symbols for the map display

Multimedia system:



POIs include restaurants and hotels, for example. These are displayed as symbols on the map. Not all POIs are available in all countries. Personal POIs are destinations which you have saved on a USB device, for example.

- i** The display of POI symbols on the map can be activated or deactivated as a favourite.

- Select **View**.
- Select **POI symbols on map** .

▶ Activate **Hide all points of interest**.

When the option is switched on, the POI symbols for all categories are shown on the map according to the settings in the POI categories.

- ❗ If the conditions are fulfilled, the POI symbols are shown with current online information (→ page 517).

Switching display of categories for quick-access on or off

- ▶ Switch a category on or off in the menu.

Selecting categories

- ▶ In the menu, select **Other categories** .

- ▶ Activate or deactivate **Show all**.

When the option is switched on, the POI symbols for all categories are shown on the map.

or

- ▶ Select  the categories.

- ▶ Activate or deactivate the categories.

The POI symbols for the selected categories are shown on the map.

Selecting personal POI categories

- ▶ In the menu, select **Personal POIs** .

- ▶ Select  a category.

- ▶ Activate or deactivate **Display on the map**.

- ▶ **To issue a signal when approaching:** activate **Visual warning** and **Acoustic notification**.

Resetting the POI symbol display

- ▶ In the menu, select **Reset POIs**.
The settings are reset to the standard settings.

Selecting the display of additional information on the map

Multimedia system:



- ▶ Select **View**.

- ▶ Select **Show additional information**.

- ▶ Switch the options on or off.

The following options are available:

- **Current street**

If the option is enabled, it will be displayed in the navigation window.

- **Scale**

If the option is switched off, the map scale is only displayed on the map when zooming.

If the option is enabled, the map scale is permanently displayed on the map.

The option also influences the display on the driver's display.

- **Altitude**

- **Next junction**

If the option is switched on and the journey continues without route guidance, the name of the next intersecting street will be displayed in the navigation window.

Displaying the map version

Multimedia system:



- ▶ Select **View**.

- ▶ Select **Map data version**.

The detail information is displayed.

- ❗ The online map update service from Mercedes me connect can be used to update the map data (→ page 29).

A message is shown on the central display when a new map version is available.

- Information about new versions of the digital map can be obtained from a Mercedes-Benz service centre.

Overview of area avoidance on the route

You can define areas along a route that you would like to avoid.

Motorways or multi-lane expressways that pass through an area to be avoided may be included in the route despite being blocked.

Avoiding a new area for the route

Multimedia system:

 **Route**
 >> **Avoid areas**

- Select **Avoid new area**.

Starting using the map

- Select **Using map**.
A red rectangle appears. This designates the area that should be avoided.
- Move the map (→ page 512).

- Set the map scale (→ page 512).
- Select **OK**.
The area is entered into the list.

Starting using destination search

- Select **Via address entry**.
- Enter the address (→ page 30).
- Select the destination in the list.
The map appears. The area is saved.

Changing an area to be avoided

Multimedia system:

 **Route**
 >> **Avoid areas**

- Select an area in the list.
- Select **Edit**.
- To move an area on the map:** swipe in any direction on the central display.

Changing the size of the area

- Move two fingers apart or together on the central display.

- Select **OK**.
The area is entered into the list.

Taking the area for the route into account

- Select the area in the list.
- Activate **Avoid area**.
If route guidance is active, a new route is calculated.

If there is no route yet, the setting is carried over to the next route guidance.

The route can include an area that is to be avoided in the following cases:

- The destination is located in an area that is to be avoided.
- The route includes motorways or multi-lane expressways which pass through an area to be avoided.
- There is no practical alternative route.

■ Deleting an area to be avoided

Multimedia system:



Deleting an area to be avoided

- ▶ Select an area in the list.
- ▶ Select **Delete**.
- ▶ Confirm the prompt with **Yes**.

Deleting all areas to be avoided

- ▶ If at least two areas to be avoided are set, select **Delete all**.
- ▶ Confirm the prompt with **Yes**.

■ Map data update overview

As the content of a digital road map has a short life, outdated data may have a negative effect on all navigation functions. For the best MBUX navigation experience, you should install all of the map updates offered by Mercedes-Benz.

The following options are available for the update of map data:

- Online map update

- Updates from the Mercedes me Portal
 - Update at a Mercedes-Benz service centre
- Additional costs can be incurred in this process.

Online map update

Requirements:

- Mercedes me connect is available.
 - You have a Mercedes me user account.
 - The Online Map Update service is available for your region.
 - The service has been activated.
- i** The Online Map Update service is only available in certain countries.

Installation takes place in the background as an automatic map update.

The MBUX multimedia system installs all of the available map updates for the European regions in which the vehicle is located or is moved.

The online map update is activated at the latest after the next time the vehicle is switched on.

Updates from the Mercedes me Portal

The map data for several regions can also be updated manually. Log in with your Mercedes me user account at: <https://www.mercedes-benz.de/>

Follow the menu path **My Mercedes Me account** > **My vehicles** > **Selection of car** > **Online Map Update**. Select the regions to be downloaded to a storage medium.

After the map data has been copied, connect the storage medium with your vehicle. Select the notification with information about a new version of the map data and start the installation. After the MBUX multimedia system has been restarted, the updated map data is used.

■ Overview of map data

If map data is reinstalled in a vehicle, no activation code needs to be entered.

For map data purchased as data media, the enclosed activation code must be entered after starting the installation.

Activation codes are only ever valid for one vehicle.

In the event of the following problems, please contact a Mercedes-Benz service centre:

- The multimedia system does not accept the activation code.
- You have lost the activation code.

■ Displaying the compass

Multimedia system:



▶ When the map is shown, tap on the  current vehicle position until the **Position** menu is shown.

▶ Select **Compass**.

The compass display shows the following information:

- The current direction of travel with bearing (360° format) and compass direction
- Longitude and latitude coordinates in degrees, minutes and seconds
- Number of satellites from which a signal can be received

The information is not available in every country.

■ Displaying Qibla

Multimedia system:



▶ When the map is shown, tap on the  current vehicle position until the **Position** menu is shown.

▶ Select **Alerts**.

The arrow on the compass shows the direction to Mecca in relation to the current direction of travel.

The number of satellites received is shown.

 This function is not available in all countries.

■ Sharing the vehicle position with a contact

Requirements:

- A mobile phone is connected to the MBUX multimedia system.
- The connected mobile phone supports sending text messages from the vehicle (→ page 534).

Multimedia system:



The current vehicle position can be shared with a contact.

- ▶ In the Route menu, select **Share journey**.
The display changes to **Stop sharing journey**.
- ▶ Select the contact (→ page 532).
The text message is sent. The display changes back to the digital map. A symbol is displayed in the status line. When the message has been sent, a notification is displayed.

■ Setting the map scale automatically

Multimedia system:



▶ Select **View**.

▶ Activate  **Auto zoom**.
When the option is switched on, the map scale is set automatically depending on your driving speed and the type of road.

 The automatically selected map scale can be changed manually. After a few seconds, this is automatically reset.

When the option is activated, no detailed display of the junction or a 3D image is shown in the navigation window during an upcoming driving manoeuvre.

■ Displaying the satellite map

Multimedia system:



▶ Select **View**.

▶ Activate or deactivate **Satellite map**.

When **Satellite map** is selected, they are displayed at the following map scales:

- On-board maps

The satellite maps are displayed in map scales from 2 km.

- Online maps

The satellite maps are displayed in high-resolution map scales from 10 m.

When **Satellite map** is not selected, no satellite maps are displayed.

- ❗ The satellite maps for these map scales are not available in all countries.

■ Showing electric range on the map

Requirements:

- There is an Internet connection.
 - Mercedes me connect is available.
 - You have a Mercedes me user account.
 - The vehicle is connected with the user account and you have accepted the Mercedes me connect terms of use.
- Further information can be found at: <https://www.mercedes.me>
- The service is available and has been activated.

Multimedia system:



▶ Select **View**.

▶ **Range**.

The electric range is shown on the map with a white line around the current vehicle position.

- ❗ The electric range display on the map is not available in all countries.

■ Displaying online map contents

Requirements

- There is an Internet connection.
 - Mercedes me connect is available.
 - You have a Mercedes me user account.
 - The vehicle is connected with the user account and you have accepted the Mercedes me connect terms of use.
- Further information can be found at: <https://www.mercedes.me>
- The service is available and has been activated.

Multimedia system:



▶ Select **View**.

▶ Switch on an online service, e.g. **Weather**. Current weather information is displayed on the navigation map, e.g. temperature or cloud cover.

The service information is not shown in all map scales, e.g. weather symbols.



-  The display of online map content is not available in all countries.

Parking service

Notes on the parking service

 **NOTE** Damage to the vehicle due to not observing the maximum permitted headroom clearance

If the vehicle height is greater than the maximum permitted headroom clearance, the roof and other parts of the vehicle may be damaged.

-  Observe the signposted headroom clearance.
-  If the vehicle height is greater than the permitted headroom clearance, do not enter.
-  Observe the changed vehicle height with add-on roof equipment.

-  This service is not available in all countries.

Selecting parking options

 **NOTE** Vehicle damage due to failure to observe local information and parking conditions

The data is based on the information provided by the respective service providers.

Mercedes-Benz does not guarantee the accuracy of the information provided in relation to the car park or parking area.

-  Always observe the local information and conditions.

Requirements:



- Navigation Services is activated in your Mercedes me user account.
- The parking service is part of the scope of the Navigation Services.
- **Parking** is activated (→ page 519).

Multimedia system:



-  Tap on **P** the map.

or

-  In the route overview, select **P** **Parking spaces** (→ page 495).
-  Select the search position and search filter, e.g. **Near destination** and **Multi-storey car parks**.
The map shows car parks suited to the selected settings.
-  Select a parking option.
The map shows the parking options in the vicinity.
The following information is displayed (if available):
 - Destination address, distance from current vehicle position and arrival time
 - Information on the car park, e.g.
 - Opening times
 - Parking charges
 - Current occupancy
 - Maximum parking time
 - **Maximum access height**

The maximum access height shown by the parking service does not replace the need for observation of the actual circumstances.

- Available payment options (Mercedes pay, coins, bank notes, cards)
- Details on parking tariffs
- Number of available parking spaces
- Payment method (e.g. at parking meters)
- Services/facilities at the parking option
- Telephone number

▶ Calculate the route (→ page 484).

The following functions can also be selected (if available):

- Searching for POIs in the vicinity.
- Saving the destination.
- Placing a call at the destination.
- Sharing the destination via QR code.
- Calling up the web address.
- Showing the destination on the map.

■ Displaying parking options on the map

Requirements

- Navigation Services is activated in your Mercedes me user account.
- The parking service is part of the scope of the Navigation Services.

Multimedia system:



- ▶ Activate **Parking**.
The parking options within the vicinity of the current vehicle position are shown.

■ Prior booking of a parking space

Requirements:

- Navigation Services is activated in your Mercedes me user account.
- The parking service is part of the scope of the Navigation Services.
- You have registered with your payment details for the payment of parking in the Mercedes me Portal with Mercedes pay and the respective contract partner.

- **Parking** is activated (→ page 519).

ⓘ This option is not available in all countries.

Multimedia system:



- ▶ Select a parking option on the map.
- ▶ If a parking space available to book has been selected, select **Book parking space**.
- ▶ Select the desired booking period. Take note of the cancellation conditions.
If the parking space is available for the selected period, the price will be shown.
- ▶ Press **OK** to confirm.
- ▶ In the booking overview, confirm with **Book**.
- ▶ If required, enter the Mercedes me PIN.
The parking space will be booked in the background.
A booking confirmation including a car park ticket will be sent to your registered e-mail address.

Making use of or cancelling the booking

- ▶ Start the Mercedes me app on your smartphone.
- ▶ Open **Menu**.
- ▶ Select **My transactions**.
- ▶ Select **Parking transactions**.
- ▶ Select the desired booking.
- ▶ **To make use of the booking:** select **Show car park ticket**.

or

- ▶ **To cancel the booking:** select **Cancel booking**.

i If possible, a parking space booking can be cancelled up to the stated time. If a booking cannot be cancelled, this will already be shown to you during the booking procedure.

Paying parking charges

Requirements:

- Navigation Services is activated in your Mercedes me user account.
- The parking service is part of the scope of the Navigation Services.

- You have registered with your payment details for the payment of parking in the Mercedes me Portal with Mercedes pay and the respective contract partner.
- **Parking** is activated (→ page 519).

i This option is not available in all countries.

Multimedia system:



- ▶ Select a parking option on the map.
- ▶ If a car park that can be paid for has been selected, scroll down in the parking details.
- ▶ Select **Payment**.
Once the vehicle has reached a parking position with payment function and the vehicle is switched off, a message appears. Using this message you can pay from the vehicle and start the payment process.

Starting a payment procedure

- ▶ Acknowledge the message.
- ▶ Please note the maximum parking period displayed and any existing additional limitations. If required, a message will inform you about

the necessity of displaying information confirming the online payment for the parking space.

- ▶ Select **Start the payment process**.
- ▶ If required, enter the Mercedes me PIN.
- ▶ Press **OK** to confirm.
The successful start of your parking transaction is shown.
- ▶ Complete the booking with **OK**.
- ▶ **To cancel a parking transaction:** after receiving the confirmation request, select **Cancel**. Minimum charges may be incurred.

Ending a parking transaction

- ▶ Stop the active transaction using the Mercedes me app.
You receive a summary of the procedure and the costs.

If an uncompleted parking transaction is detected for your vehicle as you continue your journey, a message will appear asking whether you would like to end it.

- ▶ Acknowledge the message.
When the parking transaction is stopped successfully, another message appears with the details about your completed parking.

Dashcam

Notes on the dashcam

! **NOTE** Risk of legal consequences due to violation of legal regulations and data protection provisions

You are legally responsible for operation and use of the dashcam functions.

The legal requirements relating to operation and use of the dashcam can vary depending on the country in which the dashcam is operated.

This function is not permitted in all countries.

- ▶ Before using the dashcam, read up on the content of the legal regulations, in particular the data protection requirements in the respective country of use.

- ▶ Observe the legal regulations, in particular the data protection requirements.

- ① Observe the following instructions for safe operation:
 - Only use FAT32 or exFAT formatted USB storage devices.
 - Use USB-IF certified USB storage devices.
USB-IF is a non-profit corporation and stands for USB Implementers Forum. Based on the USB specification, USB-IF certifies, for example, USB versions, corresponding cables and plugs as well as energy supply processes via the USB interface.
 - USB storage devices may be damaged if often or permanently overwritten at high speed. Mercedes-Benz recommends a high-quality external SSD drive.
The abbreviation SSD stands for Solid State Drive.
- ① The file size and therefore the duration of single recording is limited by the limitations of the USB flash drive format. So FAT32 format-

ted USB flash drives do not allow files larger than 4 GB, for example.
When the file size is reached, the recording stops and you receive a notification.

- ① The following functions are available in the Gallery app:
 - Switching write protection on or off
 - Deleting video files

Additional information about the Gallery app (→ page 552).

Selecting a USB device for a video recording with the dashcam

Requirements:

- At least one USB device is connected with the multimedia system (→ page 572).

Multimedia system:

→  ▶▶ Apps ▶▶ Dashcam

- ▶ Select the USB symbol.
- ▶ Select the USB device.

- ❗ When USB devices contain multiple partitions, recorded video files are not always displayed in the recording list.
Mercedes-Benz recommends that you use USB devices with one partition.

Starting or stopping video recording with the dashcam

Requirements

- For recording and saving a video file: a USB device is connected with the multimedia system (→ page 572).
- The vehicle is switched on.

Multimedia system:

➔  ➔ Apps ➔ Dashcam

- ▶ If several USB devices are connected with the multimedia system, select a USB device (→ page 521).
If no USB device is selected, a selection is made automatically when recording starts.

- ▶ **To select a recording mode:** select **Loop recording** or **Individual recording**.
Loop recording records several short video files. When the memory is full, recording is continued automatically. In doing so, other files will be overwritten starting with the oldest file.

Individual recording stops recording when the memory limit is reached. An individual recording is automatically protected against being overwritten.

- ▶ **To start:** select **Start recording**.
The length of the recording is shown. The **Do not remove the storage medium during recording. Before removing the storage medium, eject it first.** message appears. The video file is stored on the USB device.

- ▶ **To end:** select **End recording**.

- ❗ In some countries, geo-coordinates (longitude and latitude) are shown in the video image. For technical reasons, the geo-coordinates may show greater inaccuracies.

A report may appear in the following cases:

- **Individual recording:** the memory is full or there are only a few minutes recording time available. The video recording stops or will be stopped imminently.
Change the USB device or delete a video file.
- The camera is not functional, the **Camera unavailable** message appears.
Have the camera checked in a Mercedes-Benz service centre.
- If the country border indication has been switched on (→ page 522).
- If an outdoor recording is started with the camera app during a dashcam recording, the dashcam recording pauses and resumes automatically after the camera recording is finished. A notification to this effect is displayed.

Configuring dashcam settings

Requirements:

- A USB device is connected with the multimedia system (→ page 572).

Multimedia system:

- 
 Apps >> Dashcam
 Select .

Receiving notifications after passing a border crossing

- ▶ Switch on **National border alert** .
A message is shown if video is being recorded and the vehicle passes a border.
- ⓘ This function is not available in all countries.

Starting automatic video recording

- ▶ Select **Automatic loop recording**.
- ▶ Switch on **Automatic loop recording**.
When the vehicle is started, video recording starts automatically.
- ⓘ This function is not available in all countries.

Telephone

Telephony

Notes on telephony

- ⚠ **WARNING** Risk of distraction from operating integrated communication equipment while the vehicle is in motion

If you operate communication equipment integrated in the vehicle when driving, you could be distracted from the traffic situation. This could also cause you to lose control of the vehicle.

- ▶ Only operate this equipment when the traffic situation permits.
- ▶ If you cannot be sure of this, stop the vehicle whilst paying attention to road and traffic conditions and operate the equipment with the vehicle stationary.

- ⚠ **WARNING** Risk of accident from operating mobile communication equipment while the vehicle is in motion

Mobile communication devices distract the driver from the traffic situation. This can also cause the driver to lose control of the vehicle.

- ▶ As a driver, only operate mobile communication devices when the vehicle is stationary.
- ▶ As a vehicle occupant, use mobile communication devices only in the designated area, e.g. in the rear passenger compartment.

You must observe the legal requirements for the country in which you are currently driving when operating the multimedia system and mobile communication equipment in the vehicle.

- ⚠ **WARNING** Risk of injury due to objects being stowed incorrectly

If objects in the vehicle interior are stowed incorrectly, they can slide or be thrown around

and hit vehicle occupants. In addition, cup holders, open stowage spaces and mobile phone receptacles cannot always retain all objects within.

There is a risk of injury, particularly in the event of sudden braking or a sudden change in direction.

- ▶ Always stow objects so that they cannot be thrown around in such situations.
- ▶ Always make sure that objects do not protrude from stowage spaces, luggage nets or stowage nets.
- ▶ Close the lockable stowage spaces before starting a journey.
- ▶ Always stow and secure heavy, hard, pointed, sharp-edged, fragile or bulky objects in the boot/load compartment.

Observe the additional information on stowing mobile communications devices correctly:

- Loading the vehicle (→ page 190)

Further information can be obtained from a Mercedes-Benz service centre or at: <https://www.mercedes-benz-mobile.com/>

Telephone menu overview



- ① Bluetooth® device name of the currently connected mobile phone/of the mobile phone
- ② Bluetooth® device name of the currently connected mobile phone/of the mobile phone (two phone mode)
- ③ Signal strength of the mobile phone network
- ④ Battery status of the connected mobile phone

- ⑤ Options
- ⑥ Messages
- ⑦ Calls up devices
- ⑧ Numerical pad
- ⑨ Starts contact search

Bluetooth® profile overview

Bluetooth® profile of the mobile phone	Function
PBAP (Phone Book Access Profile)	Contacts are automatically displayed in the multimedia system
MAP (Message Access Profile)	Message functions can be used

Bluetooth® profile of the mobile phone	Function
HFP (Hands Free Profile)	Wireless telephony is available
SAP (SIM Access Profile)	The car telephone has access to the SIM card data and dials into the mobile phone network via the exterior aerial

■ Telephony operating modes overview

Depending on your equipment, the following telephony operating modes are available:

- A mobile phone is connected to the multimedia system via Bluetooth® (→ page 525).
- Two mobile phones are connected with the multimedia system via Bluetooth® (two phone mode) (→ page 526).
 - You can use all the functions of the multimedia system with both mobile phones.

i Irrespective of this, Bluetooth® audio functionality can be used with any mobile phone (→ page 573).

■ Information on telephony

The following situations can lead to the call being disconnected while the vehicle is in motion:

- There is insufficient network coverage in the area
- You move from one transmission/reception station to another and no communication channels are free
- The SIM card used is not compatible with the network available
- A mobile phone with "Twincard" is logged into the network with the second SIM card at the same time

The multimedia system supports calls in HD Voice® for improved speech quality. A requirement for this is that the mobile phone and the mobile phone network provider of the person you are calling support HD Voice®.

Depending on the quality of the connection, the voice quality may fluctuate.

■ Connecting a mobile phone

Requirements

- Bluetooth® is activated on the mobile phone (see the manufacturer's operating instructions).
- Bluetooth® is activated on the multimedia system (→ page 460).

Multimedia system:



Searching for a mobile phone

▶ Select **Connect new device**.

Authorising a mobile phone

▶ Select a mobile phone.
A code is displayed in the multimedia system and on the mobile phone.

▶ **If the codes match:** confirm the code on the mobile phone.

- ❗ For older mobile phone models, enter a one to sixteen-digit number code on the mobile phone and on the multimedia system for authorisation.
- ❗ Up to 15 mobile phones can be authorised on the multimedia system. Authorised mobile phones are reconnected automatically.
- ❗ The connected mobile phone can also be used as Bluetooth® audio equipment (→ page 573).

You can watch an animation on this topic via the following link:

■ Connecting a second mobile phone (two phone mode)

Requirements

- At least one mobile phone is already connected to the multimedia system via Bluetooth®.

Multimedia system:

→  ► Phone ►  ► Devices
► Devices

- Select **Connect new device**.

- Select the mobile phone.
- In some cases, if the query appears, confirm the selection of the mobile phone pair with the **Device name 1 + Device name 2** option. The selected mobile phone is connected to the multimedia system.

■ Interchanging mobile phones (two phone mode)

Multimedia system:

→  ► Phone

Both mobile phones are shown individually in separate tabs.

- Select the tab with the desired mobile phone. Selecting the tab of a specific mobile phone displays the associated telephone contents. Selecting the other tab switches the view to the other telephone. The submenus in the telephone menu (e.g. contacts, call lists, messages) relate to the currently selected mobile phone with the exception of the telephone settings. In the telephone settings, settings can be made for both mobile phones.

■ Changing the function of a mobile phone

Multimedia system:

→  ► Phone ►  ► Devices
► Devices

Activating a function

- Select a grey symbol in the line of a mobile phone. The corresponding function is activated.

Deactivating a function

- **One function is active:** select the coloured symbol in the line of a mobile phone. The mobile phone is disconnected from the multimedia system.
- **Several functions are active:** de-select an active function in the line of one of the mobile phones. The corresponding function is deactivated.

Replacing mobile phones

Multimedia system:



No authorised mobile phone available:

- ▶ Select **Connect new device**.
- ▶ Select a mobile phone.
- ▶ **Newly authorised mobile phone:** confirm the numerical code on the mobile phone.

Using in single telephone mode

- ▶ Select **Device name**.
A newly authorised mobile phone is connected in single telephone mode.
If the mobile phone has already been authorised and connected in single telephone mode, it is connected again in single telephone mode.
If a mobile phone is already authorised and has been connected in two phone mode with another mobile phone, a query may come, whether the mobile phone should in future be operated in single telephone mode or connec-

ted with another mobile phone in two phone mode.

- ▶ If required, confirm the query about operating mode (single telephone or two phone mode) by confirming the **Device name** option.

Using in two phone mode

- ▶ Select **Device name 1 + Device name 2**.
A newly authorised mobile phone is connected with the selected mobile phone in two phone mode.
If the mobile phone has already been authorised and connected in single telephone mode, it will be connected in future with the selected mobile phone in two phone mode.
If the mobile phone was previously connected with another mobile phone, this connection is cancelled.

Disconnecting or deleting a mobile phone

Multimedia system:



Disconnecting a mobile phone

- ▶ Select **Disconnect**.
If applicable, the mobile phone will be automatically reconnected when the vehicle is next started.

Deleting a mobile phone

- ▶ Select **Devices**.
- ▶ Select **...** in the line of the mobile phone.
- ▶ Select **Delete device**.
The mobile phone is deleted from the system.

Using a mobile phone with near-field communication (NFC)

Requirements

- NFC is activated on the mobile phone (see the manufacturer's operating instructions)
- The mobile phone's screen is switched on and unlocked (see the manufacturer's operating instructions)

Connecting a mobile phone

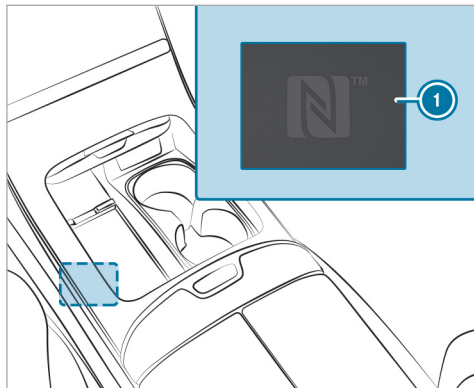

- ▶ Hold the NFC interface of the mobile phone (see the manufacturer's operating instructions) against NFC interface ① in the front stowage compartment.
- ▶ Follow the additional prompts on the central display to connect the mobile phone. Connect the mobile phone in single telephone mode

(→ page 525). Connect the mobile phone in two phone mode (→ page 526).

Replacing a mobile phone

- ▶ Hold the NFC interface of the mobile phone (see the manufacturer's operating instructions) against NFC interface ① in the front stowage compartment.
 - ▶ Follow the additional prompts on the central display to replace the mobile phone in single or two phone mode (→ page 526).
 - ▶ If required, confirm the prompts on your mobile phone (see the manufacturer's operating instructions).
- ① If your mobile phone supports wireless charging, it can be charged on the mat (→ page 208).
- ① If the mobile phone is not charging, switch off NFC on the mobile phone (see the manufacturer's operating instructions).

Further information can be found at: <https://www.mercedes-benz-mobile.com/>

Setting the reception and transmission volume

Requirements:

- A mobile phone is connected (→ page 525).

Multimedia system:

- ▶ ▶ Phone ▶ ▶ Devices
- ▶ Devices

This function ensures optimal language quality.

- ① Please note that the respective mobile phone must be selected for adjustment of the reception and transmission volume.
- ▶ Select in the line of the mobile phone.
 - ▶ Select **Volume**.
 - ▶ Set the reception and transmission volume using **Reception volume** and **Transmission volume**.

Further information on the recommended reception and transmission volume: <https://www.mercedes-benz-mobile.com/>

Setting the ringtone

Multimedia system:

Home ►► Phone ►► Settings ►► Ringtones

▶ Set the ringtone.

- ⓘ If the mobile phone supports the transfer of the ringtone, you will hear the ringtone of the mobile phone instead of that of the vehicle audio system.

Starting or stopping mobile phone voice recognition

Requirements

- At least one mobile phone is connected to the multimedia system (→ page 525).
- The tab with the mobile phone for which voice recognition should be started is selected (→ page 526).

Starting mobile phone voice recognition

- ▶ Press and hold the button on the multi-function steering wheel for more than one second.
Voice recognition is started for the currently selected mobile phone.

Stopping mobile phone voice recognition

- ▶ Press the or button on the multi-function steering wheel.

- ⓘ If a mobile phone is connected via Smartphone Integration, the voice recognition of this mobile phone is always started or stopped.

Note about contact suggestions

The multimedia system can show contact suggestions based on frequently used contacts, outgoing calls and text messages. For this, the **Allow contact suggestions** option must be switched on (→ page 463).

When you open the call list or the message menu, contacts which you can call or write to will be suggested to you. Suggestions will be shown in the **Suggestionstab**.

- ⓘ The multimedia system does not use the content of messages for suggestions.

Selecting options for contact suggestions

Requirements

- The **Allow contact suggestions** option is switched on (→ page 463).
- The multimedia system has gathered sufficient data in order to show contact suggestions.

Multimedia system:

Home ►► Phone

▶ Select **Call list** or **Contacts**.

▶ Select **Suggestions**.

▶ Select in the line of the suggested contact.

The following option is available for selection:

- **Do not suggest now**



Calls

Telephone operation

Multimedia system:

  Phone

Making a call by entering the numbers

- ▶ Select .
- ▶ Enter a number.
- ▶ Select .
- The call is made.

Accepting a call

- ▶ Select  **Accept** .

Rejecting a call

- ▶ Select  **Reject** .

Answering a call with a message

- ▶ Select  **Reply**.

Ending a call





- ▶ Select .

Putting a call on In-Car Office's to-do list

- ▶ Select  **Put call on In-Car Office's to-do list**.

Activating functions during a call

The following functions are available during a call:

-  **End call**
-  **Micro. off**
-  **Keypad** (show to send DTMF tones)
-  **Add call**

Hands-free

Transfer the call, e.g. to **Front**, **Rear** or **All seats**.

- **Private mode**

Transfer the call to the telephone or head-phones, for example.

- ▶ Select a function.

 Observe that the functions and symbols can vary depending on the vehicle equipment.

Conducting calls with several participants

Requirements

- There is an active call (→ page 530).
- Another call is being made.

Switching between calls

- ▶ Select the contact.
The selected call is active. The other call is on hold.



Activating a call on hold

- ▶ Select the contact of the call on hold.

Conducting a conference call

- ▶ Select  **Conference**.
The new participant is included in the conference call.

Ending an active call

- ▶ Select  **End call**.
-  On some mobile phones, the call on hold is activated as soon as the active call is ended.

Accepting or rejecting a waiting call

Requirements:

- There is an active call (→ page 530).

If you receive a call while already in a call, a message is displayed.

Depending on the mobile phone and mobile phone network provider you will hear a call waiting signal.

Alternatively, in two phone mode you will hear an acoustic signal when the call goes through to the other (not yet active) mobile phone.

- ▶ Select  **Accept**.
The incoming call is active.

If only one mobile phone is connected with the multimedia system, the previous call will be put on hold.

If during a call you accept a call with the other mobile phone when in two phone mode then the existing call is ended.

or

- ▶ Select **Reply**.
The incoming call is not accepted.

 You answer with a message.

or

- ▶ Select  **Reject**.

 This function and behaviour depends on your mobile phone network provider and the mobile phone (see the manufacturer's operating instructions).

Using the international dialling code

Multimedia system:



- ▶ Press and "0" until a "+" appears in the selection field.
- ▶ Enter the numbers of the country code, regional code and the telephone number.
- ▶ Select .
The call is made.

Contacts

Information about the contacts menu

The contacts menu contains all contacts from existing data sources, e.g. mobile phone or data storage medium.

Depending on the data source, it is possible to save/load the following number of contacts:

- Permanently saved contacts: 3,000 entries
- Contacts loaded from the mobile phone: 5,000 entries per mobile phone

From the contacts menu, you can perform the following actions:

- Make a call, for example call a contact (→ page 532)
- Navigation (→ page 482)
- Compose messages (→ page 534)
- Additional options (→ page 533)

Mobile phone contacts are automatically displayed when a mobile phone is connected to the multimedia system (→ page 525).

Downloading mobile phone favourite contacts

If the mobile phone supports the function, the favourites of the mobile phone are automatically loaded and appear in the overview of the phone menu.

Calling up contacts

Multimedia system:

Phone >> Contacts

The following options can be used to search for contacts:

- Searching by initials
- Searching by name
- Searching by phone number

▶ Enter characters into the search field.

▶ Select the contact.

A contact can contain the following details:

- Phone numbers
- Navigation addresses
- Internet address
- Email addresses
- Relationship (if set)

Managing the format of a contact's name

Multimedia system:

Phone >>

▶ Select **Name format**.

▶ Select an option.

Overview of importing contacts

Importing contacts into the contacts menu

Source	Requirements
USB device	The USB device is connected with the USB port.
Mobile phone	A mobile phone is connected to the multimedia system via Bluetooth®. Contacts are available.

Note that the imported contacts remain in the vehicle and can be accessed at any time regardless of the connected mobile phones.

Importing contacts into the contacts menu

Multimedia system:

Phone >> >> Contacts

>> **Import contacts**

▶ Select a mobile phone **<device name>**, from which the contacts should be imported.

▶ Select an option.

Saving a mobile phone contact

Multimedia system:

Phone >> Contacts

▶ Select in the line of the mobile phone contact.

▶ Select .

▶ Select **Save**.

▶ Select **Yes**.

The contact saved in the multimedia system is identified by the MBUX symbol.

Calling a contact

Multimedia system:

Phone >> Contacts



▶ Select **Search contacts**.

- ▶ Enter characters into the search field.
- ▶ Select the contact.
- ▶ Select the telephone number.
The number is dialled.

Selecting further options in the contacts menu

Multimedia system:

→  ▶▶ Phone ▶▶ Contacts

- ▶ Select  in the line of the contact.
- ▶ Select .
- ▶ Select an option.

Deleting contacts

Requirements

- The contacts are saved in the vehicle.
- To delete an individual contact, this has been imported manually into the vehicle.

Multimedia system:



→  ▶▶ Phone

Deleting all contacts

- ▶ Select .

- ▶ Select **Contacts**.
- ▶ Select **Delete all MBUX contacts**.
- ▶ Select an option.

Deleting a contact

- ▶ Select **Contacts**.
- ▶ Select  in the line of the contact.
- ▶ Select .
- ▶ Select **Delete contact**.
- ▶ Select **Yes**.

Call list

Overview of the call list

Depending on whether your mobile phone supports the PBAP Bluetooth® profile or not, this can have different effects on the presentation and functions of the call list.

If the PBAP Bluetooth® profile is supported, the effects are as follows:

- The call lists from the mobile phone are displayed in the multimedia system.

- When connecting the mobile phone, you may have to confirm the connection for the PBAP Bluetooth® profile.

If the PBAP Bluetooth® profile is not supported, the effects are as follows:

- The multimedia system generates a call list independently as soon as calls are made in the vehicle.
- The call list is not synchronised with the call lists in the mobile phone.

Making a call from the call list

Multimedia system:

→  ▶▶ Phone

- ▶ Select  **Call list**.
- ▶ Select an entry.
The call is made.

Selecting additional options in the call list

Multimedia system:

→  ▶▶ Phone

- ▶ Select  **Call list**.

- ▶ For contacts that are in the address book: select options.
The contact details are called up.
- ▶ For contacts where only one number is shown (not in the address book): select .

Deleting the call list

Multimedia system:

- ▶  ▶ Phone ▶ <Device name>
- ▶  ▶ Devices

- ▶ Select **Delete call list**.
- ▶ Select **Yes**.

 This function is only available if your mobile does not support the PBAP Bluetooth® profile.

Text messages

Overview of message functions

In the message menu you can receive text messages and create and send them with the help of the MBUX voice assistant.

If the connected mobile phone supports the Bluetooth® MAP profile, the message functions can be used on the multimedia system.

You can obtain further information about settings and supported functions of Bluetooth®-capable mobile phones at a Mercedes-Benz service centre or at: <https://www.mercedes-benz-mobile.com/>
Some mobile phones require further settings after being connected to the multimedia system to activate the messaging functionality (see manufacturer's operating instructions).

Setting message displays



Multimedia system:

- ▶  ▶ Phone ▶ <Device name>
- ▶  ▶ Devices

- ▶ Select **Message display**.
- ▶ Select **On** or **Off**.

Reading messages

Multimedia system:

- ▶  ▶ Phone ▶ <Device name>
- ▶ 

Using the read-aloud function

A message list is shown.

- ▶ To read aloud, select the  symbol at a conversation.
The message is read aloud.

Creating and sending a new message

Requirements

- There is an Internet connection.
- At least one mobile phone with reception is connected.
- If applicable, the message function must be activated on the mobile phone.

Multimedia system:

- ▶  ▶ Phone ▶ <Device name>
- ▶ 

- ▶ Using the MBUX voice assistant, speak the voice command **Send a message to**, and name the desired contact (→ page 419).

Dictating text

- ▶ Say the message.
You are guided by the voice dialogue.

Replying to a message in the messaging history

Multimedia system:

  >> Phone >> <Device name>
>> 

A message list is shown.

- ▶ Select  next to a contact. The messaging history with this contact is shown. You will be guided through the steps with the help of a voice dialogue.
- ▶ Say the message.

Forwarding messages

Multimedia system:

  >> Phone >> <Device name>
>> 

A message list is shown.



- ▶ Speak the voice command **Forward message**. You are guided by the voice dialogue.

Calling a message sender

Multimedia system:

  >> Phone >> <Device name>
>> 

A message list is shown.

- ▶ Select  next to a contact. The messaging history with this contact is shown.
- ▶ Select .
- ▶ Select **Call**.

Using telephone numbers, URLs or email addresses from a text message

Requirements

- An Internet connection is available to call up a URL.

Multimedia system:

  >> Phone >> <Device name>
>> 

A message list is shown.

- ▶ Select  next to a contact. The messaging history with this contact is shown.
- ▶ Select a telephone number or a URL in the message. If a URL is selected the web browser opens. If a telephone number is selected the following options are available:
 - **Call**
 - **New message**

or

- ▶ **If In-Car Office and the email function are available:** select an email address. In-Car Office opens.
 - ⓘ The availability of In-Car Office is country-dependent.
- ▶ Select an option.

Deleting a message

Multimedia system:

  >> Phone >> <Device name>
>> 

A message list is shown.

- ▶ Select a contact.
- ▶ Press and hold on a message.
- ▶ **To delete the message:** select **Delete**.

In-Car Office

In-Car Office functions

Using In-Car Office, you can connect your online services to the multimedia system.

The following functions are available:

- Calendar
Showing appointments and triggering actions, e.g. reading aloud, placing a call, navigating
- E-mail
Reading, reading aloud, creating, answering and forwarding e-mails
- Tasks and calls
Managing tasks and pre-booked calls
- Voice input
Creating appointments/reminders and tasks

- ① Alternatively, you can record text contents via the MBUX voice assistant or via the dictation function.
Further information on the MBUX voice assistant (→ page 420).
- ① The zero layer displays notifications or reminders from In-Car Office, such as birthdays or calls due (→ page 431).
- ① Please note that certain functions are only available when the vehicle is stationary.

Calling up In-Car Office

Requirements:

- You have a Mercedes me user account.
- The In-Car Office service is activated in your Mercedes me user account.
- You have a user account with an online service, for example Office 365 or Gmail.
In this way, appointments, e-mails and tasks can be synchronised and facilitated.

Multimedia system:



- ▶ Select **In-Car Office**.
Individual functions from In-Car Office can be called up.

Linking a user account

- ▶ Select the desired online service.
- ▶ Scan the QR code.
- ▶ Follow the instructions on the device.

Selecting calendar functions in In-Car Office

Multimedia system:



- ▶ Select an appointment.

The following functions are available:

- **Read aloud**
- **Call**
- **Navigate**
- **Delete**
- ▶ Select a function.

- ❗ Functions are available if corresponding appointment information is saved.

Examples of this are:

- If a telephone number has been saved for the appointment, **Call** is available.
- If a navigable address has been saved in the Online Account for the appointment, **Navigate** is available.

■ Selecting functions of Tasks & Calls in "In-Car Office"

Multimedia system:

→ ▶ Apps ▶ In-Car Office
▶ Tasks & calls

- ▶ Select a function for an entry.

The following functions are available:

- Reading aloud
 - Placing a call
- This task function requires a telephone number.
- Marking as completed

In the current edit, an entry that has been marked as completed can be marked as open again by removing the tick.

- Deleting
- Displaying details

■ Marking an entry as completed in Tasks & Calls

Multimedia system:

→ ▶ Apps ▶ In-Car Office
▶ Tasks & calls

- ▶ Select **Tasks & calls**.
An overview appears.
- ▶ Select .

■ Reading and managing e-mails

Multimedia system:

→ ▶ Apps ▶ In-Car Office ▶ E-mail

- ▶ Select an e-mail.
The e-mail is opened.

Additional functions are available:

- Reading e-mails
- Answering e-mails (→ page 538)
- Forwarding e-mails (→ page 538)

- Deleting e-mails

■ Creating new e-mails

Multimedia system:

→ ▶ Apps ▶ In-Car Office ▶ E-mail

- ▶ Select **Create e-mail**.

- ▶ Select .

- ▶ Enter an e-mail address directly via the keyboard.

or

- ▶ Select an e-mail address from the contacts.

- ❗ Contacts can be used from the contacts menu or from linked online services such as Office 365 or Gmail. Further information about the contacts menu (→ page 531).

- ❗ Please note that e-mails can only be written when the vehicle is stationary.

- ▶ Enter the subject and text of the e-mail in the corresponding fields with the keypad.

- ▶ Select **Send**.

■ Answering e-mails

Multimedia system:

→  >> Apps >> In-Car Office >> E-mail

- ▶ Select an e-mail.
- ▶ Select **Reply**.
- ▶ Enter the e-mail text in the corresponding field using the keypad.
- ▶ Select **Send**.

ⓘ Please note that e-mails can only be written when the vehicle is stationary.

■ Forwarding e-mails

Multimedia system:

→  >> Apps >> In-Car Office >> E-mail

- ▶ Select an e-mail.
- ▶ Select **Forward**.
- ▶ **To forward with attachment:** select **Forward with attachment**.

ⓘ Contacts can be used from the contacts menu or from linked online services such as Office 365 or Gmail. Further information about the contacts menu (→ page 531).

ⓘ Forwarding with an attachment is only possible if an attachment is available.

- ▶ **To forward without attachment:** select **Forward without attachment**.
- ▶ Enter the e-mail text in the corresponding field using the keypad.
- ▶ Select **Send**.

■ Operating In-Car Office using the MBUX Voice Assistant and dictation function

Multimedia system:



→  >> Apps >> In-Car Office >> E-mail

Operating In-Car Office using the dictation function

The dictation function allows you to dictate text content, such as the subject or text of an e-mail, instead of typing the content using the keyboard.

ⓘ The dictation function is not available everywhere with the full range of functions. For the first-time activation of the function it may be necessary to accept the Mercedes me connect terms of use in your Mercedes me user account.

The following is an example of how you can dictate the subject and text of an e-mail.

- ▶ Select  **Create e-mail**.
- ▶ Add recipients using .
- ▶ Select .
The dictation function is started.
- ▶ Dictate the subject and text of the e-mail. After the voice input has been processed, it is shown as text.
- ▶ Select **Send**.

Operating In-Car Office using the MBUX Voice Assistant

With the voice control of the MBUX Voice Assistant you can operate various functions of In-Car Office and speak in text contents.

ⓘ Further information on operating the MBUX Voice Assistant (→ page 419).

The following are examples of some voice commands that you can use to operate In-Car Office.

- ▶ **To write new e-mail:** say the voice command **I want to send an e-mail to John Doe**. You are guided by the dialogue.

- ▶ **To reply to an e-mail:** say the voice command Reply to e-mail.
You are guided by the dialogue.
- ▶ **To forward an e-mail:** say the voice command Forward e-mail.
Dictate the text of the e-mail.
- ▶ **To show tasks:** say the voice command Show my tasks.
The tasks are shown.
- ▶ **To create a calendar entry:** say the voice command Create a calendar entry tomorrow at 9 a.m..
You are guided by the dialogue.

Apple CarPlay®

Overview of Apple CarPlay®

⚠ WARNING Risk of distraction from information systems and communications equipment

If you operate information systems and communication devices integrated in the vehicle

when driving, you could be distracted from the traffic situation. This could also cause you to lose control of the vehicle.

- ▶ Only operate this equipment when the traffic situation permits.
- ▶ If you cannot be sure of this, stop the vehicle whilst paying attention to road and traffic conditions and operate the equipment with the vehicle stationary.

You must observe the legal requirements for the country in which you are currently driving when operating the multimedia system. iPhone® functions can be used via the multimedia system using Apple CarPlay®. They are operated using the touchscreen, Touch Control or the Siri® voice control system. You can activate the voice control system by pressing and holding the  button on the multifunction steering wheel.

i By briefly pressing the  button on the multifunction steering wheel you can continue to operate the multimedia system using the MBUX voice assistant (→ page 419).

Only one iPhone® at a time can be connected via Apple CarPlay® with the multimedia system.

Also for use of Apple CarPlay® with two phone mode, only one additional mobile phone can be connected using Bluetooth® with the multimedia system.

As access to the iPhone® is restricted by MBUX when an Apple CarPlay® session is active, not all MBUX functions (e.g. dialling from the address book) can be fully provided for the connected device. In this case use Apple CarPlay®.

The full range of functions for Apple CarPlay® is only available with an Internet connection.

The availability of Apple CarPlay® may vary according to the country.

The service provider is responsible for this application and the services and content connected to it.

Apple CarPlay® is a registered trademark of Apple Inc.

You can watch an animation on this topic via the following link:

Information on Apple CarPlay®

The Apple CarPlay® symbol in the status line switches within Apple CarPlay® to the last active display.

If route guidance is active on the multimedia system, it is closed when route guidance is started on the mobile phone.

Connecting an iPhone® via Apple CarPlay® (wired)

Requirements:

- The current version of your device's operating system is being used (see the manufacturer's operating instructions).
- i** For safety reasons, the first activation of Apple CarPlay® on the multimedia system must be carried out when the vehicle is stationary and the parking brake applied.

- ▶ Connect the iPhone® to a USB port on the multimedia system using a suitable cable (→ page 572).
When the application is connected for the first time, a message about data protection regulations appears.
- ▶ Select **Accept & start** if the application should be started.

or

- ▶ Open the device manager (→ page 526).
 - ▶ Start Apple CarPlay® using the relevant symbol next to the device name.
- i** If applicable, a message about data protection regulations appears.
- ▶ If required confirm the use of Apple CarPlay® on your iPhone®.

Exiting Apple CarPlay®

- ▶ Select .

or

- ▶ Press the  button on the multifunction steering wheel (MBUX multimedia system).

- i** If Apple CarPlay® was not displayed in the foreground before disconnecting, the application starts in the background when reconnected. You can call up Apple CarPlay® using the Apple CarPlay® symbol in the status line.

Connecting an iPhone® via Apple CarPlay® (wireless)

Requirements

- The current version of your device's operating system is being used (see the manufacturer's operating instructions).
 - Bluetooth® is activated on the device (see the manufacturer's operating instructions).
 - The device is "visible" for other devices.
- i** For safety reasons, the first activation of Apple CarPlay® on the multimedia system must be carried out when the vehicle is stationary and the parking brake applied.

Multimedia system:

→  » Phone »  » Devices

- ▶ Connect the mobile phone using Bluetooth® (→ page 525).
When the application is connected for the first time, a message about data protection regulations appears.
- ▶ Select **OK, start Apple CarPlay** if the application should be started.
- ▶ If required confirm the use of Apple CarPlay® on your iPhone®.
- ❶ It is possible at any time to switch between connection via Bluetooth® or Apple CarPlay® (wireless) in the device list.
- ❶ If you have already connected a mobile phone via Bluetooth®, you can connect another iPhone® via Bluetooth® to use Apple CarPlay® via the device manager.

Exiting Apple CarPlay®

- ▶ Select .

or

- ▶ Press the  button on the Touch Control (MBUX multimedia system).

- ❶ If Apple CarPlay® was not displayed in the foreground before disconnecting, the application starts in the background when reconnected. You can call up Apple CarPlay® using the Apple CarPlay® symbol in the status line.

Calling up Apple CarPlay® sound settings

Multimedia system:

→  » Settings » System » Audio

- ▶ Select the sound settings.

Ending Apple CarPlay®

- ▶ Select the Apple CarPlay® symbol in the device manager (telephone, media) that is next to the device name of the iPhone®.
- ❶ Select the Apple CarPlay® symbol in the device manager in the telephone or media applications if Apple CarPlay® should be restarted.
- ❶ If Apple CarPlay® was not displayed in the foreground before disconnecting, the application starts in the background the next time it

is started automatically. You can call up Apple CarPlay® using the relevant symbol in the status line.

Android Auto

Android Auto overview



⚠ WARNING Risk of distraction from information systems and communications equipment

If you operate information systems and communication devices integrated in the vehicle when driving, you could be distracted from the traffic situation. This could also cause you to lose control of the vehicle.

- ▶ Only operate this equipment when the traffic situation permits.
- ▶ If you cannot be sure of this, stop the vehicle whilst paying attention to road and traffic conditions and operate the equipment with the vehicle stationary.

You must observe the legal requirements for the country in which you are currently driving when operating the multimedia system.

Mobile phone functions can be used with Android Auto using the Android operating system on the multimedia system. It is operated using the touchscreen, Touch Control or voice control. You can activate the voice control system by pressing and holding the  button on the multifunction steering wheel.

 By briefly pressing the  button on the multifunction steering wheel you can continue to operate the multimedia system using the MBUX voice assistant (→ page 419).

Only one mobile phone at a time can be connected via Android Auto with the multimedia system.

Also for use of Android Auto with two phone mode, only one additional mobile phone can be connected using Bluetooth® with the multimedia system.

The full range of functions for Android Auto is only possible with an Internet connection.

The availability of Android Auto and Android Auto apps may vary according to the country.

The service provider is responsible for this application and the services and content connected to it.

You can watch an animation on this topic via the following link:

Information on Android Auto

The Android Auto symbol in the status line switches within Android Auto to the last active display.

If route guidance is active on the multimedia system, it is closed when route guidance is started on the mobile phone.

Connecting a mobile phone via Android Auto (wired)

Requirements:

- The mobile phone supports Android Auto from Android 5.0.
- The current version of the Android Auto app is installed on the mobile phone.
- In order to use the telephone functions, the mobile phone must be connected to the multimedia system via Bluetooth® (→ page 525).



If there was no prior Internet connection, this is established with the use of the mobile phone with Android Auto.

 For safety reasons, the first activation of Android Auto on the multimedia system must be carried out when the vehicle is stationary with the parking brake.

 Connect the mobile phone to a USB port on the multimedia system using a suitable cable (→ page 572).
When the application is connected for the first time, a message about data protection regulations appears.

 Select **Accept & start** if the application should be started.

or

 Open the device manager (→ page 526).
 Start Android Auto using the relevant symbol next to the device name.

Exiting Android Auto

 Select .

or

▶ Press the  button on the Touch Control (MBUX multimedia system).

- ⓘ If Android Auto was not displayed in the foreground before disconnecting, the application starts in the background when reconnected. You can call up Android Auto using the Android Auto symbol in the status line.

■ Connecting a mobile phone via Android Auto (wireless)

Requirements

- The current version of your device's operating system is being used (see the manufacturer's operating instructions).
 - The device supports the Android Auto function (wireless).
 - Bluetooth® is activated on the device (see the manufacturer's operating instructions).
 - The device is "visible" for other devices.
 - Bluetooth® is activated on the multimedia system (→ page 460)
- ⓘ For safety reasons, the first activation of Android Auto on the multimedia system must

be carried out when the vehicle is stationary with the parking brake.

- ⓘ The Android Auto function (wireless) is not available in all countries.

Multimedia system:

  ▶▶ Phone ▶▶  ▶▶ Devices

▶ Connect the mobile phone using Bluetooth® (→ page 525).

- ⓘ Depending on the device configuration, the query whether Android Auto should be started may appear after connecting the mobile phone via Bluetooth®. In this case, the query must be answered with **Yes**.

▶ Select **Start Android Auto**.

When the application is connected for the first time, a message about data protection regulations appears.

▶ Select **Accept & start**.

- ⓘ It is possible at any time to switch between connection via Bluetooth® or Android Auto (wireless) in the device list.

- ⓘ If you have already connected a mobile phone via Bluetooth®, you can connect another mobile phone via Bluetooth® to use Android Auto via the device manager.

Exiting Android Auto

▶ Select .

or

▶ Press the  button on the Touch Control (MBUX multimedia system).

- ⓘ If Android Auto was not displayed in the foreground before disconnecting, the application starts in the background when reconnected. You can call up Android Auto using the Android Auto symbol in the status line.

■ Calling up the Android Auto sound settings

Multimedia system:

  ▶▶ Settings ▶▶ System ▶▶ Audio

▶ Select the sound settings.

■ Ending Android Auto

▶ Select the Android Auto symbol in the device manager (telephone, media) that is next to the device name of the mobile phone.

- ❗ Select the Android Auto symbol in the device manager if Android Auto should be restarted.
- ❗ If Android Auto was not displayed in the foreground before disconnecting, the application starts in the background the next time it is started automatically. You can call up Android Auto using the Android Auto symbol in the status line.

Transferred vehicle data with Android Auto and Apple CarPlay®

■ Overview of transferred vehicle data

When using Smartphone Integration, certain vehicle data is transferred to the mobile phone. This enables you to get the best out of selected mobile phone services. Vehicle data is not directly accessible.

The following system information is transmitted:

- Software release of the multimedia system
- System ID (anonymised)

The transfer of this data is used to optimise communication between the vehicle and the mobile phone.

To do this, and to assign several vehicles to the mobile phone, a vehicle identifier is randomly generated.

This has no connection to the vehicle identification number (VIN) and is deleted when the multimedia system is reset (→ page 467).

The following driving status data is transmitted:

- Transmission position engaged
- Distinction between parked, standstill, rolling and driving
- Day/night mode of the driver's display
- Drive type

The transfer of this data is used to alter how content is displayed to correspond to the driving situation.

The following position data is transmitted:

- Coordinates
- Speed
- Compass direction
- Acceleration direction

This data is used by the mobile phone to improve the accuracy of the navigation (e.g. for continuation in a tunnel).

Mercedes me calls

■ Making a call via the overhead control panel

- ❗ Mercedes me calls are not possible in every country. Find out at a Mercedes-Benz service centre if these functions are available in your country.

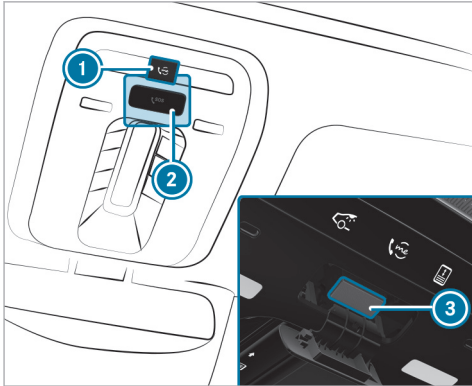

- ① me button for service or information calls
- ② SOS button cover
- ③ SOS button (emergency call system)

Making a Mercedes me call

- ▶ Press me button ①.

Making an emergency call

- ▶ To open the cover of SOS button ②, press it briefly.
- ▶ Press and hold SOS button ③ for at least one second.

If a Mercedes me call is active, an emergency call can still be triggered. This has priority over all other active calls.

Information about the Mercedes me call using the me button

A call to the Mercedes-Benz Customer Centre has been initiated via the me button in the overhead control panel or the multimedia system (→ page 544).

Using the voice dialogue system you access the desired service:

- Accident and Breakdown Management
- Mercedes-Benz Customer Centre for general information about the vehicle

You can find information on the following topics:

- Activation of Mercedes me connect
- Operating the vehicle

- Nearest Mercedes-Benz service centre
- Other products and services from Mercedes-Benz

Data is transferred during the connection to the Mercedes-Benz Customer Centre (→ page 547).

Calling the Mercedes-Benz Customer Centre using the multimedia system

Requirements

- Access to a GSM network is available.
- The contract partner's GSM network coverage is available in the respective region.
- The vehicle must be switched on so that vehicle data can be transferred automatically.

Multimedia system:



- ▶ Call **Mercedes me connect**. After confirmation, the multimedia system sends the required vehicle data. The data transfer is shown in the display.

Then you can select a service and be connected to a specialist at the Mercedes-Benz Customer Centre.

■ Calling the Mercedes-Benz Customer Centre after automatic accident or breakdown detection

Requirements:

- The vehicle has detected an accident or breakdown situation (→ page 302).
- The vehicle is stationary.
- The hazard warning lights are switched on.

 This function is not available in all countries.

The vehicle can detect accident or breakdown situations under certain circumstances.

Requirements for collision detection in the context of accident recovery:

- The vehicle is equipped with an anti-theft alarm system (ATA) (code 551).
- The vehicle is equipped with the interior protection (code 882).
- The vehicle is equipped with the Anti-Theft Protection Package (code P54).

- The collision detection service with theft notification has been activated on Mercedes me connect.

If a collision is detected when the tow-away protection is primed on a locked vehicle, you will receive a notification in the multimedia system when you switch the vehicle on.

The message informs you about the potentially affected area of the vehicle and the strength of the collision.

In the event an accident or breakdown is detected, the emergency guide shows safety notes in the multimedia system display. This may take a few seconds.

 The availability of collision detection depends on the vehicle.

After quitting the emergency guide display on the multimedia system, a prompt appears asking whether you would like to get support from the Mercedes-Benz Customer Centre.

 Select **Call**.

- After your agreement, or if the Mercedes me connect service "Accident and Break-

down Management" is active, the vehicle data is transferred automatically (→ page 550).

- The Mercedes-Benz Customer Centre takes your call and organises the breakdown and accident assistance.

You may be charged for these services.

 Depending on the severity of the accident, an automatic emergency call can be initiated. This has priority over all other active calls (→ page 556).

 In addition, if the Mercedes me connect service "Telediagnosics" is active, a similar prompt can appear after a delay in the event of a breakdown. If you are already in contact with the Mercedes-Benz Customer Centre or have already received support, this prompt can be ignored or declined.

 If you answer the prompt for support from the Mercedes-Benz Customer Centre with **Call later**, the message will be hidden and appear again later.

The prompt triggered by the Mercedes me connect service "Telediagnosics", can either be confirmed or declined. After being declined, this will not be shown again.

■ Arranging a service appointment via a Mercedes me call

If you have activated the maintenance management service, relevant vehicle data is transferred automatically to the Mercedes-Benz Customer Centre. You will then receive individual recommendations regarding the maintenance of your vehicle.

Regardless of whether you have consented to the maintenance management service, the multimedia system reminds you after a certain amount of time that a service is due. A prompt appears asking if you would like to make an appointment.

▶ **To arrange a service appointment:** select **Call**. After your consent, the vehicle data is transferred and the Mercedes-Benz customer centre takes your preferred appointment date. The information is then sent to your desired service outlet.

This will contact you to confirm the appointment and if necessary consult about the details.

❗ If you select **Call later** after the service message appears, the message is hidden and reappears at a later time.

■ Giving consent to data transfer during a Mercedes me call

Requirements

- There is an active Mercedes me call via the multimedia system or the me button in the overhead control panel (→ page 544).

❗ The prompt to confirm data transfer does not appear in all countries.

If the Accident and Breakdown Management services are not activated on Mercedes me, the **Do you want to transfer your vehicle data and the vehicle's position to the Mercedes-Benz Customer Centre to improve the processing of your request?** message is shown.

❗ The exact phrase may differ depending on the multimedia system installed.

▶ Select **Yes**.

- The relevant vehicle data is sent automatically (→ page 547).

or

▶ Select **No** and confirm.

- Only call control data is transmitted (→ page 547).

More information on Mercedes me: <https://www.mercedes.me>

■ Data transferred during a Mercedes me call

If you initiate a service call using Mercedes me, data is transferred to enable targeted advice and an efficient service.

The following requirements must be fulfilled for the transfer of the data:

- The vehicle is switched on.
- The required data transfer technology is supported by the mobile phone network provider.
- The quality of the mobile connection is sufficient.

Multi-stage transfer depends on the following factors:

- Reason for the initiation of the call
- The available mobile phone transmission technology
- The activated Mercedes me connect services
- The service selected in the voice control system

i A prompt for consent to the data transfer only occurs if the corresponding Mercedes me connect service is not activated.

i The scope of the data transmitted depends on the vehicle model and vehicle equipment. For technical reasons, not all data is available at all times.

Data transfer if Mercedes me connect services are not activated

If no Mercedes me connect services are activated and the data protection prompt has been confirmed the following data is transmitted:

- Vehicle identification number
- Time of the call

- Reason for the initiation of the call
- Confirmation of the data protection prompt
- Country indicator of the vehicle
- Set language for the multimedia system
- Telephone number of the communication platform installed in the vehicle

If a call is made for a service appointment via the service reminder, the following data is also transmitted:

- Current mileage and maintenance data

If a call is made after automatic accident or breakdown detection using the multimedia system, the following data is also transmitted:

- Current mileage and maintenance data
- Current vehicle location

If Accident and Breakdown Management is called via the voice control system and no service has been activated, but the data protection query has been confirmed, the following data can also be called up from the vehicle by the Mercedes-Benz Customer Centre:

- Current vehicle location

If the data protection prompt has been rejected, the following data is transmitted to enable targeted advice and an efficient service:

- Vehicle identification number
- Time of the call
- Reason for the initiation of the call
- Rejection of the data protection prompt
- Country indicator of the vehicle
- Set language for the multimedia system
- Telephone number of the communication platform installed in the vehicle

Data transfer if Mercedes me connect services are activated

Only if the respective service is activated will additional incident-specific data be transmitted in the second stage to enable an optimal service.

An overview of the data transferred is contained in the data protection information for the Mercedes me connect services. You can find these in your Mercedes me user account.

Data processing

The data transmitted within the scope of the call is deleted from the processing system after the call is finished, in so far as this data is not being used for other activated Mercedes me connect services.

The incident-specific data is processed and stored in the Mercedes-Benz Customer Centre and, if required to process the incident, forwarded to the service partner authorised by the Mercedes-Benz Customer Centre. Take note of the data protection information on the Mercedes me Internet page <https://www.mercedes.me> or in the recorded message immediately after calling the Mercedes-Benz Customer Centre.

- ❗ The recorded message is not available in every country.

Mercedes me connect

Information on Mercedes me connect

- ❗ Mercedes me connect or individual Mercedes me connect services are not available in every country. Find out at a Mercedes-Benz service centre if these functions are available in your country.

Mercedes me connect consists of multiple services.

You can use the following services via the multimedia system and the overhead control panel, for example:

- Accident and Breakdown Management (me button or situation-dependent display in the multimedia system)
- Mercedes-Benz Emergency Call System (automatic emergency call and SOS button)

The Mercedes me connect Accident and Breakdown Management and the Mercedes-Benz emer-

gency call centre are available to you around the clock.

The me button and the SOS button can be found on the vehicle's overhead control panel (→ page 544).

You can also call the Mercedes-Benz Customer Centre using the multimedia system (→ page 545).

Please note that Mercedes me connect is a Mercedes-Benz service. In emergencies, first call the national emergency services using the standard national emergency service telephone numbers. In emergencies, you can also use the Mercedes-Benz emergency call system (→ page 55).

Please note the Mercedes me connect terms of use and the data protection information for Mercedes me connect. You can find these in your Mercedes me user account.

Information on Mercedes me connect Accident and Breakdown Management

i Accident and Breakdown Management is not available in every country. Contact a Mercedes-Benz service centre to find out whether this function is available in your country.

The Accident and Breakdown Management can include the following functions:

- Supplement to the Mercedes-Benz emergency call system (→ page 55)

If necessary, the contact person at the Mercedes-Benz emergency call centre forwards the call to Mercedes me connect Accident and Breakdown Management. Forwarding the call is however not possible in all countries.

- Breakdown assistance by a technician on location and/or the towing away of the vehicle to the nearest Mercedes-Benz service centre
You may be charged for these services.

- Addition to the emergency guide after automatic accident or breakdown detection (→ page 546)

In the event of a breakdown or accident, further vehicle data is sent which enables optimal support by the Mercedes-Benz Customer Centre and the authorised service partner or breakdown assistance.

- Addition to the Mercedes me connect service Telediagnosics

With the Telediagnosics function, specific wear and failure reports are recorded by the service provider, in so far as these can be clearly interpreted and are available through the monitoring of components that are subject to diagnostics.

If your vehicle detects a breakdown or threat of a breakdown, you may be prompted via the multimedia system to contact the Mercedes-Benz Customer Centre for further help. This prompt in the multimedia system only appears when the vehicle is stationary.

- i** These services are subject to technical restrictions such as the mobile phone cover-

age, mobile network quality and the ability of the processing systems to interpret the transferred data. In some circumstances, this can result in delays or the failure of the information to appear in the multimedia system.

Please note that the service and breakdown call is a Mercedes-Benz service. In emergencies, be sure to contact the usual national emergency number first or use the Mercedes-Benz emergency call system (→ page 553).

More information about Mercedes me connect services can be obtained in the Mercedes me Portal: <https://me.secure.mercedes-benz.com>

Data transferred during Mercedes me connect call services

The data transferred during a Mercedes me connect call depends on:

- The reason for initiation of the call
- The service that is selected in the voice control system
- The activated Mercedes me connect services

You can find out which data is transferred when using the services in the currently valid Mercedes

me connect terms of use and the data protection information for Mercedes me connect. You can find these in your Mercedes me user account.

Mercedes me Apps

Information about Mercedes me

With a Mercedes me user account you have access to Mercedes-Benz services and offers.

Availability is dependent both on the country and equipment.

You can obtain further information at a Mercedes-Benz service centre or in the Mercedes me Portal: <https://me.secure.mercedes-benz.com>

Further information about on-demand features via Mercedes me can be found in the "General notes" section (→ page 75).

- ❗ Make sure you always keep the Mercedes me Apps updated.

Calling up the Mercedes me user account

Multimedia system:

→  ▶ Apps ▶ Mercedes me

Vehicle is linked to user account and Mercedes me is available

- ▶ Select **Mercedes me ID**.
Information about the linked user account appears.

Your vehicle is not linked to the user account

- ❗ If you do not yet have a Mercedes me user account, you can create one at: <https://www.mercedes.me> or in the Mercedes me App. A valid email address or phone number is required for this.
- ▶ Select .
- ▶ Select **Apps**.
- ▶ Select **Mercedes me**.
- ▶ Follow the instructions on the display to link the user account with the vehicle.
- ❗ If the Mercedes me App is available on a mobile phone, the vehicle connection can be accomplished using the QR code shown.

Calling up the Mercedes me services

Requirements:

- The vehicle is connected with the user account.

Multimedia system:

→  ▶ Apps ▶ Mercedes me

- ▶ Select **My services**.
The Mercedes me connect services for which you have a valid licence are displayed in alphabetical order.

Ordering or extending Mercedes me connect services

To order or renew Mercedes me connect services, use the Store.

- ▶ Select .
- ▶ Select **Store**.

Deleting a connection between a user account and the vehicle

Requirements

- The user profile of the user account that was first linked to the vehicle is selected.

- The user profile is synchronised (→ page 444).
- A Mercedes me PIN has been set.

Multimedia system:

  **Apps** **Mercedes me**

▶ Select **Mercedes me ID**.

▶ Select **Delete vehicle connection**.

- i** Only the user, whose user account was first connected with the vehicle can delete the connection between all user accounts and the vehicle.

Selecting apps

Requirements:

- Depending on the app, the general terms and conditions are confirmed.

Multimedia system:

  **Apps**

▶ Select an app.

The following apps are available, for example:

- **Weather**

- **Browser**
- Additional apps, which are purchased or installed subsequently

i You can also access both of the first two apps via the quick access at **Apps**.

i The available features are country-dependent. Licence fees may be applicable.

The following functions are available for apps, for example:

- Search function
- Filter function, for displaying search results at the current vehicle position or at the destination
- Display of detailed information
- Read-aloud function
- Setting functions

Using the Gallery app

Multimedia system:

  **Apps**

▶ Select **Gallery**.

Images and video recordings are displayed from the following sources, for example:

- Dashcam video recordings
- Collision detection images
- Video recordings and images from other available sources
- Favourites

▶ Select a tab.

i The Gallery app is also available on the front passenger display.



Filtering displays

▶ Select .

▶ Select an option.

All files, all images or all video recordings are displayed.

Playing back a video recording

- ▶ Select . Playback starts.
- ▶ **To continue playback in full screen mode:** tap on the display.
- ▶ **To pause playback:** select .
- ▶ **To continue playback from the desired position:** move the position  on the timeline by sliding it.
- ▶ **To select the previous or next video recording:** swipe to the right or left.

Scrolling and zooming images



- ▶ **To scroll:** swipe on the image in one direction.
- ▶ **To zoom:** tap twice in quick succession on an image.
- ▶ **To select the previous or next image:** swipe to the right or left.

Adding or removing a file from the favourites





- ▶ Press and hold on a file.

- ▶ Select **Add to favourites/Remove from favourites**.
A corresponding message appears.

Switching write protection on or off

- ① Active write protection is not supported by every app.
- ▶ Press and hold on a file.
- ▶ Activate  or deactivate  **Write protection**.

Deleting files

- ▶ Select .
- ▶ **To delete a single file:** tap on a file.  will appear.
- ▶ **To delete all files:** tap on .
- ▶ **To delete:** select . A prompt appears.
- ▶ Select **Yes**.
- ① A single file can be deleted even after a long press on the file.

Mercedes-Benz emergency call system

■ Information on available emergency call systems

Two types of emergency call system are available to you in the vehicle:

- Mercedes-Benz emergency call system
- 112 emergency call system (EU eCall)

The Mercedes-Benz Emergency Call System is not available in all countries. You can find more information on the regional availability of the Mercedes-Benz emergency call system at: <https://www.mercedes-benz-mobile.com/extra/ecall/>

The following applies for both emergency call systems:

- The transfer of specific data is required for the intended function of both emergency call systems. This will be explained in the "Data transfer" section (→ page 557).
- Both emergency call systems are included as standard equipment in your vehicle and are activated at the factory.

- The use of both emergency call systems is exempt from charges.
- Both emergency call systems only function in areas in which the mobile phone network providers offer mobile phone coverage.

For both systems, insufficient network coverage from the mobile phone network providers can result in an emergency call not being transmitted.

Differences between the Mercedes-Benz emergency call system and the 112 emergency call system (EU eCall)

Mercedes-Benz emergency call system	112 emergency call system (EU eCall)
<ul style="list-style-type: none"> • The Mercedes-Benz emergency call system is permanently logged in to the mobile phone network. • Automatic and manual Mercedes-Benz emergency calls are transmitted to a Mercedes-Benz emergency call centre. <p>In the event that the emergency call centre of the Mercedes-Benz emergency call system cannot be reached (e.g. due to a lack of network coverage), the 112 emergency call is carried out automatically.</p>	<ul style="list-style-type: none"> • If you decide on the 112 emergency call system (EU eCall) only, then the system only logs in to the mobile phone network after the triggering of a manual or automatic emergency call. • The 112 emergency call system (EU eCall) transmits automatic and manual emergency calls directly to public coordination centres.

i The 112 emergency call system (EU eCall) in your vehicle meets the delegated regulation EU 2017/79. Proper and full functionality of the 112 emergency call system (EU eCall) depends on circumstances beyond the influence of Mercedes-Benz AG. This includes mobile network coverage and the technical

infrastructure of the public reception centres in the respective countries.

i Please observe that in the event of a repair genuine Mercedes-Benz batteries must be used which have been certified pursuant to the delegated regulation EU 2017/79 (Appen-

dix I). Other manufacturers are also permitted provided their batteries are certified according to the delegated regulation EU 2017/79.

There is the option of deactivating the Mercedes-Benz emergency call system and using only the 112 emergency call system (EU eCall). Contact

address for carrying out deactivation of the Mercedes-Benz emergency call system are the local dealers.

Mercedes-Benz recommends the activation of the Mercedes-Benz emergency call system for the following reasons:

- In emergency situations when abroad, you can also get support in a language you speak.
- Several transmission technologies are used to accelerate the transfer of the accident data and improve reliability of the transmission.
- The Mercedes-Benz emergency call system is permanently logged in to the mobile phone network, which ensures faster placement of the emergency call and faster transfer of the accident data.

Measures for rescue, recovery or towing away can then be initiated quickly.

- With a Mercedes-Benz emergency call, the accident data is only transferred to the public coordination centre with the approval of the customer.

In the event of an automatically triggered emergency call in which there is no voice con-

tact, the accident data is transmitted immediately to the public emergency call centre.

- If the Mercedes-Benz emergency call centre is not available, the 112 emergency call is carried out automatically.

■ Overview of emergency call systems

Both the Mercedes-Benz emergency call system as well as the 112 emergency call system (EU eCall) can help to reduce the time between an accident and the arrival of emergency services at the site of the accident. They help locate an accident site in places that are difficult to access.

Both emergency call systems can initiate an emergency call automatically (→ page 556) or manually (→ page 556).

Only make emergency calls if you or others are in need of rescue. Do not make an emergency call in the event of a breakdown or a similar situation.



Indicators in the displays

The following messages appear on the central display or the media display of both emergency call systems:

- **SOS NOT READY:** the vehicle is not switched on or the emergency call system is malfunctioning. This does not necessarily indicate complete failure of the emergency call system. Emergency calls can still be transmitted.

The display only refers to the vehicle and does not take account of the availability of mobile phone networks and the Mercedes-Benz emergency call centre.

The functional readiness of the emergency call system on the vehicle can be seen when the **SOS NOT READY** display disappears once the vehicle is switched on.

- : the icon appears in the display during an active emergency call.
-  If there is a malfunction of the emergency call system, the loudspeakers, microphone, airbag or the SOS button, for example, are faulty.

You can recognise a fault in the emergency call system by the following displays:

- A corresponding message will also appear in the driver's display.
- The SOS button lights up red continuously.

■ Triggering an automatic emergency call

Requirements

- The vehicle is switched on.
- The starter battery is sufficiently charged.

Both the Mercedes-Benz emergency call system as well as the 112 emergency call system (EU eCall) automatically initiate an emergency call:

- After activation of the restraint systems such as airbags or seat belt tensioners after an accident
- After an automatically initiated emergency stop by Active Emergency Stop Assist

The emergency call has been made:

- A voice connection is established with the emergency call centre.

- A message with accident data is transmitted to the emergency call centre.

The SOS button in the overhead control panel flashes until the emergency call is finished.

If no connection can be made to the public emergency services, a corresponding message appears in the display.

- ▶ Dial the emergency number 112 or the appropriate local emergency call number on your mobile phone.

If an emergency call has been initiated:

- Remain in the vehicle if the road and traffic conditions permit you to do so until a voice connection is established with the emergency call centre.
- On the basis of the call, the emergency call centre decides whether it is necessary to call rescue teams and/or the police to the accident site.
- If no vehicle occupant answers, an ambulance is sent to the vehicle immediately.

■ Triggering a manual emergency call

- ▶ **To use the SOS button in the overhead control panel:** press the SOS button at least one second long (→ page 544).

or

- ▶ **To use voice control:** use the voice commands of the MBUX voice assistant (→ page 423).

The emergency call has been made:

- A voice connection is established with an emergency call centre.
- Remain in the vehicle if the road and traffic conditions permit you to do so until a voice connection is established with the emergency call centre.
- On the basis of the call, the emergency call centre decides whether it is necessary to call rescue teams and the police to the accident site.
- A message with accident data is transmitted to the emergency call centre.

If no connection can be made to the public emergency services, a corresponding message appears in the display.

- ▶ Dial the emergency number 112 or the appropriate local emergency call number on your mobile phone.

■ Emergency call system data transfer

For both the Mercedes-Benz emergency call system as well as the 112 emergency call system (EU

eCall) data is transferred to the Mercedes-Benz emergency call centre or the public emergency services call centre.

Depending on the emergency call system (→ page 553) activated different data is transmitted to the appropriate emergency call centre.

Transmitted data according to activated emergency call system:

Mercedes-Benz emergency call	112 emergency call
<ul style="list-style-type: none"> • Position data of the vehicle • Position data on the route (a few 100 m before the incident) • Direction of travel • Vehicle identification number • Drive type of the vehicle (e.g. petrol, diesel, CNG, LPG, electric or hydrogen) • Number of people detected in the vehicle • Whether the emergency call was initiated manually or automatically • Time of the accident • Language setting on the multimedia system • Whether Mercedes me connect is available or not <p>This is a requirement for the option of forwarding the call to the Mercedes-Benz Customer Centre if necessary.</p>	<ul style="list-style-type: none"> • Position data of the vehicle • Position data on the route (a few 100 m before the incident) • Direction of travel • Vehicle identification number • Drive type of the vehicle (e.g. petrol, diesel, CNG, LPG, electric or hydrogen) • Number of people detected in the vehicle • Whether the emergency call was initiated manually or automatically • Time of the accident

i If only the 112 emergency call system (EU eCall) is activated in the vehicle, the accident data is transmitted directly to the public emergency call centre.

For accident clarification purposes, the following measures can be taken up to an hour after the emergency call has been initiated:

- The current vehicle position can be determined.
 - A voice connection to the vehicle occupants can be established.
 - Emergency call data can be called up.
- i** For Russia: various functions, e.g. receiving traffic information, cannot be performed for up to two hours after sending an emergency call.

■ Self-diagnosis function of the emergency call system

Your vehicle checks the functionality of the emergency call system every time the vehicle is switched on. During this time, the SOS button lights up red continuously for five seconds. In the event of a system failure, you will be informed via a text message on the driver's display and the red **SOS NOT READY** indicator on the central display or media display.

Please, make sure, that during 30 seconds after switching vehicle ON the red indicator SOS NOT READY in the upper right corner of display is switched OFF, this means the emergency call system passed diagnostics successfully.

■ Starting/ending ERA-GLONASS test mode

Requirements

- The starter battery is sufficiently charged.
- The vehicle is switched on.
- The vehicle has been stationary for at least one minute.

i The test mode is currently available in the following countries, for example:

- Russia
- Belarus
- Kazakhstan
- Armenia
- Kyrgyzstan

▶ **To start the test mode:** press and hold the  button on the multifunction steering wheel for at least five seconds.

The test mode is started and automatically ends after the language test has been performed.

▶ **To stop manual test mode:** switch off the vehicle.

The test mode is ended.

■ Information on data processing

Processing of personal data via the Mercedes-Benz emergency call system

All processing of personal data via the Mercedes-Benz emergency call system corresponds with the specifications in the EU Regulation 2016/679 "on the protection of natural entities with regard to the processing of personal data (GDPR)".

The data is solely used by the Mercedes-Benz emergency call system for rescue and recovery in the event of an accident.

The owner of a vehicle, that is equipped with a Mercedes-Benz emergency call system in addition to the 112 emergency call system (EU eCall), has

the right to use the 112 emergency call system instead of the Mercedes-Benz emergency call system.

Contact address for carrying out deactivation of the Mercedes-Benz emergency call system are the local dealers.

Processing of personal data via the 112 emergency call system (EU eCall)

All processing of personal data via the 112 emergency call system (EU eCall) corresponds with the specifications in the EU Regulation 2016/679 "on the protection of natural entities with regard to the processing of personal data (GDPR)" and is based particularly on the necessity of upholding the vital interests of the affected person in accordance with Article 6, Clause 1, Letter d of the GDPR.

The processing of this type of data is strictly limited to the purpose of operating the emergency calls to the standard European emergency call number 112.

Data recipient

The recipients of data that is processed by the 112 emergency call system (EU eCall) are the rel-

evant emergency call inquiry terminals. These are configured by the appropriate authorities of the respective country in which they are located to first accept and subsequently process emergency calls to the standard European emergency call number 112.

Arrangements for data processing

Both emergency call systems are designed so that the following requirements are fulfilled:

- The data contained in the system memory is not accessible outside the system prior to the initiation of an emergency call.
- Both emergency call systems cannot be traced and there is no continuous tracking in normal operation.
- The data in the system's internal memory is automatically and continuously deleted.
- The location data of the vehicle is continuously overwritten in the system's internal memory, so that no more than the last three current locations required for the normal function of the system are available.

- The record of the activity data of both emergency call systems is only kept for as long as is required to fulfil the purpose of handling the emergency call, and under no circumstances for more than 13 hours after the time that an emergency call is initiated.

Rights of persons affected by the data processing

The person affected by the data processing (the vehicle owner) has the right to access the data and if applicable can demand the correction, deletion or barring of data that affects him or her and that the processing of which does not correspond with the GDPR regulations. Each correction, deletion or barring carried out according to this regulation must be shared with the third party to which the data has been transmitted, provided this does not prove to be infeasible and does not incur disproportionate expenditure.

The person affected by the data processing has the right to complain to the appropriate data protection authority should they be of the opinion that their rights have been infringed by the processing of their personal data.

Responsible contact point for the processing of access rights: Konzernbeauftragter für den Datenschutz, Mercedes-Benz Group AG, HPC E600, D-70546 Stuttgart, Germany

Online and Internet functions

Internet connection

Information on connecting to the Internet

⚠ WARNING Risk of distraction from information systems and communications equipment

If you operate information systems and communication devices integrated in the vehicle when driving, you could be distracted from the traffic situation. This could also cause you to lose control of the vehicle.

- ▶ Only operate this equipment when the traffic situation permits.
- ▶ If you cannot be sure of this, stop the vehicle whilst paying attention to road

and traffic conditions and operate the equipment with the vehicle stationary.

You must observe the legal requirements for the country in which you are currently driving when operating the multimedia system.

⚠ WARNING Risk of accident from operating mobile communication equipment while the vehicle is in motion

Mobile communication devices distract the driver from the traffic situation. This can also cause the driver to lose control of the vehicle.

- ▶ As a driver, only operate mobile communication devices when the vehicle is stationary.
- ▶ As a vehicle occupant, use mobile communication devices only in the designated area, e.g. in the rear passenger compartment.

You must observe the legal requirements for the country in which you are currently driving when

operating mobile communication equipment in the vehicle.

Depending on the vehicle's equipment and availability in the country, you can establish an Internet connection in the following ways:

- **Vehicles with a communication module:**
 - Using the communication module including data roaming (→ page 562)
 - Using Bluetooth® or Wi-Fi with a data-enabled mobile phone
- **Vehicles without a communication module:**
 - Using Bluetooth® with a data-enabled mobile phone
 - Using Wi-Fi with a data-enabled mobile phone

The Internet functions can only be used to a limited degree whilst driving.

Setting up an Internet connection using the communication module

Requirements

- The vehicle is equipped with a permanently installed communication module.
- A Mercedes me user account is available.
- The vehicle is linked to a Mercedes me user account.
- The Entertainment Package is active.
- The Comfort Data Volume service is active.

Multimedia system:

- ➔  ➔ Settings ➔ System
- ➔ Internet and Bluetooth
- ➔ Manage Internet access
- ▶ Select **Acquired data package**.

For most Mercedes me connect services, data volume is available when purchasing the services.

Additional data volume is required to use some functions, e.g. web browser or Wi-Fi hotspot.

If the data volume limit is reached, the availability of Mercedes me connect services is limited.

Depending on the vehicle equipment, you can purchase a data package directly from a mobile phone network provider via the Mercedes me Store. To be able to use the data package, you conclude a separate contract with a mobile phone network provider via the Mercedes me Store, which can be terminated at any time and for which there are no costs. This contract is a prerequisite for using the services from the previously purchased package. The availability of this option is dependent on the country.

If the data package option is not available or can be upgraded, you can purchase data volume directly from the mobile phone network provider for a fee.

- ① Visit a Mercedes-Benz service centre to find out whether it is possible to purchase data volume in your country **directly from a mobile phone network provider**.
- ① Alternatively, and if available, you can utilise the tethering function of a mobile phone via Wi-Fi or Bluetooth® to use the web browser or Wi-Fi hotspot.



- ① With external Wi-Fi hotspots, which are encrypted via TKIP, online software updates cannot be carried out via the external Wi-Fi hotspot.

Disconnecting the automatic Internet connection via communication module

Requirements:

- Wi-Fi or Bluetooth® tethering are available in the vehicle.

Multimedia system:

- ➔  ➔ Settings ➔ System
- ➔ Internet and Bluetooth
- ➔ Manage Internet access
- ▶ Select the  settings in the line of **Acquired data package**.
- ▶ **To disconnect the automatic connection:** select the **Delete entry** option.
- ① The communication module is removed from the list of known hotspots, but can be reconnected manually at any time (→ page 562).

The **Delete entry** option permits the use of purchased data volume to be limited. The system is

prevented from automatically establishing a connection to the communication module after this option has been activated.

■ Setting up an Internet connection via Wi-Fi

Requirements:

- The Wi-Fi function is activated on the multimedia system (→ page 461).
- The Wi-Fi hotspot function is activated on the mobile phone (see the manufacturer's operating instructions).
- Internet access via Wi-Fi is activated (see the manufacturer's operating instructions).

Multimedia system:

➔  ➔ **Settings** ➔ **System**
 ➔ **Internet and Bluetooth**
 ➔ **Manage Internet access**

 This function is country-dependent.

The mobile phone is listed in the Internet device manager

- ▶ Select the mobile phone with the  Wi-Fi symbol.

The mobile phone is not listed in the Internet device manager

- ▶ Select **Search for access**.
- ▶ Select the mobile phone with the  Wi-Fi symbol. It may take a few seconds until the device is found by the Wi-Fi search.
- ▶ Log in to the Wi-Fi network (→ page 461).

The Internet connection via Wi-Fi is restricted or does not function in the following cases:

- The mobile phone is switched off
- Mobile data use is deactivated on the mobile phone
- The Wi-Fi function is deactivated on the multimedia system
- The Wi-Fi function is deactivated on the mobile phone
- Internet access via Wi-Fi is deactivated on the mobile phone

■ Setting up an internet connection via Bluetooth®

Requirements:

- The mobile phone supports the Bluetooth® profile PAN (Personal Area Network).
- The mobile phone is connected to the multimedia system via Bluetooth® (→ page 525).
- Internet access via Bluetooth® is activated (see the manufacturer's operating instructions).

Multimedia system:

➔  ➔ **Settings** ➔ **System**
 ➔ **Internet and Bluetooth**
 ➔ **Manage Internet access**

 This function is country-dependent.

The mobile phone is listed in the Internet device manager

- ▶ Select the mobile phone with the  Bluetooth® symbol.

The mobile phone is not listed in the Internet device manager

▶ Select **Search for access**.

In the list displayed, all mobile phones already known to the multimedia system are shown. New devices can be set up using the phone application.

▶ Connect the mobile phone using Bluetooth® (→ page 525).

- ❗ If a new mobile phone is connected using Bluetooth®, this is also used for the telephone application.

The Internet connection via Bluetooth® is restricted or does not function in the following cases:

- The mobile phone is switched off
- The mobile phone network coverage is insufficient
- Mobile data use is deactivated on the mobile phone
- The Bluetooth® function on the multimedia system is switched off and the mobile phone is to be connected via Bluetooth®
- The Bluetooth® function is switched off on the mobile phone and the mobile phone is to be connected via Bluetooth®

- Neither the mobile phone network nor the mobile phone allow simultaneous use of a telephone and an Internet connection
- The mobile phone has not been enabled for Internet access via Bluetooth®

■ Cancelling Internet access permission for a mobile phone

Multimedia system:

- ↳  ▶▶ **Settings** ▶▶ **System**
 ▶▶ **Internet and Bluetooth**
 ▶▶ **Manage Internet access**

- ▶ Select options  next to the name of the mobile phone.
- ▶ Select **Delete configuration**.
- ▶ Select **Yes**.

■ Establishing an Internet connection

Multimedia system:

- ↳  ▶▶ **Apps**

- ▶ For example, select  **Browser**.

If you select a function that requires an Internet connection and the system is currently offline, a

menu opens with a selection of possible Internet accesses as well as all tethering devices that are within range.

- ▶ Select an Internet access from the list.
 The Internet connection is established.

- ❗ The list of possible Internet connections can also be displayed using the extended status line.
- ❗ Depending on the vehicle equipment and country availability, you can establish an Internet connection via the communication module or connected mobile phones.
- ❗ The availability of the web browser depends on the country.

Connection status

■ Connection status overview

Depending on the connection status, the following symbols can appear on the central display in the status line:

- : a Wi-Fi device is selected as Internet access.

- : a Bluetooth® device is selected as Internet access.
- Mobile communications standard (e.g. 4G + double arrow symbol): the communication module is selected as the hotspot.

■ Displaying the connection status

Multimedia system:



- ▶ Briefly press the status line.
The extended status line is displayed.
- ▶ Briefly press the Internet symbol in the symbol overview.
The current connection status is displayed.

Notes on displaying the connection status

- When connecting via Wi-Fi, the connection status and device name are displayed.
- When connecting via a Bluetooth® device, the connection status, device name, and network type are displayed.
- In the case of a connection via the communication module the following status information can be shown:

- Type of network
- Status (online, offline, data volumes available or used, limited service)
- For vehicles with a communication module, the connection data of non-user paid services can be displayed via [Mercedes me connect](#).

Web browsers

■ Calling up a web page

⚠ WARNING Risk of distraction from information systems and communications equipment

If you operate information systems and communication devices integrated in the vehicle when driving, you could be distracted from the traffic situation. This could also cause you to lose control of the vehicle.

- ▶ Only operate this equipment when the traffic situation permits.
- ▶ If you cannot be sure of this, stop the vehicle whilst paying attention to road

and traffic conditions and operate the equipment with the vehicle stationary.

You must observe the legal requirements for the country in which you are currently driving when operating the multimedia system.

Multimedia system:



Calling up a new web page

- ▶ Select **Search**.
- ▶ Entering a web address.
- ▶ Select **OK**.
- ⓘ The function is country-dependent.
- ⓘ No web pages can be displayed on the multimedia system while driving.

Calling up a website from the browser history

- ▶ To call up the previous page from the history: select .

Web browser overview



- 1 Previous website
- 2 Next website
- 3 Update
- 4 URL
- 5 Adds/removes bookmarks
- 6 Options
- 7 Settings

i Under **[...]** you have the following options:

- Tabs
- Bookmarks & history
- Reading mode
- Share link
- Share content
- Request mobile website

Calling up web browser options

Multimedia system:

→ **[Home]** → Apps → **[Globe]** Browser
 → **[...]** → Bookmarks & history

The following functions are available:

- Bookmarks
 - Browsing history
 - Entered URLs
- ▶ Select an option.
- ▶ Change the settings.

Calling up the web browser settings

Multimedia system:

→ **[Home]** → Apps → **[Globe]** Browser
 → **[Gear]** → Settings

The following functions are available:

- Block popups
 - Enable cookies
 - Enable Javascript
- ▶ Switch a function on **[Toggle On]** or off **[Toggle Off]**.

Deleting browser data

Multimedia system:

→ **[Home]** → Apps → **[Globe]** Browser
 → **[Gear]** → Browser data

The following specific browser data can be deleted:

- Cache
 - Cookies
 - Form data
- ▶ Select one of the options shown.

Managing bookmarks

Multimedia system:



- ▶ Select **Bookmarks & history**.
- ▶ Select  after the bookmark.
A menu with options opens.

The following options are available:

- [Delete entry](#)
- [Delete all](#)
- [Edit](#)
- [Share](#)

- ▶ Select one of the options shown.

Managing tabs

Multimedia system:



Opening a new tab

- ▶ Select [New tab](#).



Changing tab

- ▶ Select the icon for the desired tab.

Closing a tab

- ▶ Press and hold the icon of the tab to be closed until a menu appears.
- ▶ Select [Close](#).
The tab is closed.

Private mode

- ▶ Switch private mode on  or off .
If the private mode is switched on, an icon appears in the input line of the web browser.
- ⓘ In private mode, neither the history nor cookies are saved.
Bookmarks can also be created in private mode.

Sharing URLs from the web browser

Requirements:

- To share via QR code: an app for scanning the QR code is installed on the mobile device.

Multimedia system:



Sharing URLs via QR code

- ▶ Select [Share link](#).
A QR code appears.
- ▶ Scan the displayed QR code with a mobile device.

Sharing URLs with another display

- ▶ Select [Share content](#).
- ▶ In the menu drag and drop a display to another display.
The displayed web page opens on the other display.
- ⓘ More information on sharing display content: (→ page 450)

Setting the web browser in the background

Multimedia system:



- ▶ Press .
Audio playback continues.

Tuneln Radio

Calling up Tuneln Radio

Requirements:

- There is a user account at <https://www.mercedes.me>.
- The vehicle is linked to the Mercedes me user account.
- The Tuneln radio service is activated.
- The data volume is available.

Depending on the country, data volume may need to be purchased.

- A fast Internet connection for data transmission free of interference.

- ① The functions and services are country-dependent. For more information, consult a Mercedes-Benz service centre.

Multimedia system:



- ▶ Select **Tuneln Radio**.

The Tuneln Radio menu appears. The last station set starts playing.

- ① The connection quality depends on the local mobile phone reception.

Overview of Tuneln Radio

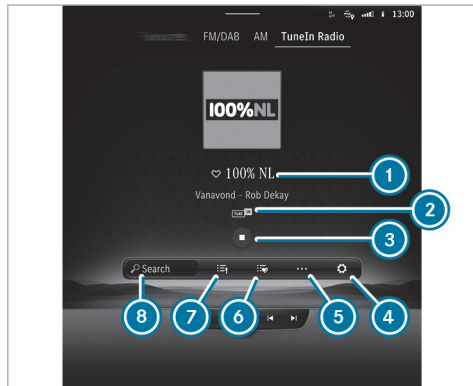

- ① Internet Radio provider
- ② Additional information on the current station
- ③ Controls playback
- ④ Settings
- ⑤ Additional options

- ⑥ Favourites
- ⑦ Station list
- ⑧ Search

Selecting and connecting to Tuneln radio stations

Multimedia system:



- ▶ Select [Search icon].

- ▶ Select a category.

- ▶ Select a station.

The connection is established automatically.

or

- ▶ Select the search field.

- ▶ Enter a station name.

- ① A relatively large volume of data can be transmitted when using Internet Radio.

Saving/deleting a TuneIn radio station as a favourite

Multimedia system:



Saving favourites

- ▶ Select a station.
- ▶ Press the symbol next to the station name.

Deleting favourites

- ▶ Select a station.
- ▶ Press the symbol next to the station name.

Setting Internet Radio options

Multimedia system:



The following options are available:

- **Select Stream:** select the stream quality
- **Login to TuneIn Account:** log in to your TuneIn user account
- **Log Out of Account:** log out of your TuneIn user account

- ▶ Select an option.

Media

Information about media mode

Information about supported formats and data storage media

⚠ WARNING Risk of distraction when handling data storage media

If you handle a data storage medium while driving, your attention is diverted from the traffic conditions. This could also cause you to lose control of the vehicle.

- ▶ Only handle a data storage medium when the vehicle is stationary.

- ⓘ The driver may be distracted from the traffic situation by the sounds of media playback. Use headphones for media playback to avoid distracting the driver.

Supported formats and data storage media:

Permissible file systems	FAT32, exFAT, NTFS
Permissible data storage media	USB devices, iPod®/iPhone®, MTP devices, Bluetooth® audio equipment
Supported audio formats	MP3, WMA, AAC, WAV, FLAC, ALAC
Supported video formats	MPEG, AVI, MKV, MP4, M4V, WMV

- ⓘ Observe the following notes:
 - The multimedia system supports a total of up to 50,000 files.
 - Data storage media up to 2 TB are supported (32-bit address space).
 - Due to the large variety of available music and video files regarding encoders, sampling frequency and data transfer rates, playback cannot be guaranteed.

- Due to the wide range of USB devices available on the market, playback cannot be guaranteed for all USB devices.
- Videos up to FullHD (1920x1080) are supported.
- Copy-protected music and video files or DRM (Digital Rights Management) encrypted files cannot be played back.
- MP3 players must support Media Transfer Protocol (MTP).

■ Information on copyright protection and trademarks

Audio files which you create yourself (e.g. copies of data storage media you make yourself) are generally subject to copyright protection. In many countries, reproductions are not permitted without the prior consent of the copyright holder, even for private use. Make sure that you know about the applicable copyright regulations and that you comply with these.



Manufactured under licence from Dolby Laboratories. Dolby, Dolby Audio and the double-D symbol are trademarks of Dolby Laboratories.



For DTS Patents, see <https://patents.dts.com>. Manufactured under licence from DTS Licensing Limited. DTS, the Symbol, & DTS and the Symbol together are registered trademarks, and DTS TrueVolume is a trademark of DTS, Inc.®. DTS, Inc. All Rights Reserved.



DTS® Connected Radio™

For DTS Patents, see <http://patents.dts.com>. Manufactured under licence from DTS Licensing Limited. DTS, DTS Connected Radio, and the DTS logo are registered trademarks or trademarks of DTS, Inc. in the United States and other countries. © 2020 DTS, Inc. ALL RIGHTS RESERVED. Lyrics licensed and provided by Lyric Find™. Content licensed and sourced from Radioplayer™.



Gracenote, the Gracenote logo and logotype, "Powered by Gracenote", MusicID and Playlist Plus are either registered trademarks or trademarks of Gracenote, Inc. in the United States and/or other countries.

This product incorporates Spotify software which is subject to 3rd party licences found here: <https://www.spotify.com/connect/third-party-licenses>



TIDAL and TIDAL logo are registered trademark of Aspiro AB in the European Union and other countries.

Overview of the media menu

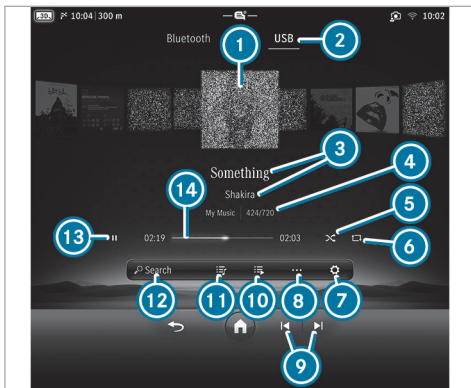

- ① Album cover
- ② Active media source
- ③ Track and artist
- ④ Active data storage medium and current track number/track in playback list
- ⑤ Random playback
- ⑥ Repeat

- ⑦ Settings
- ⑧ Additional options
- ⑨ Previous or next track and fast rewind or fast forward
- ⑩ Additional categories
- ⑪ Playlists and categories
- ⑫ Media search
- ⑬ Controls playback
- ⑭ Timeline

When the control menu is called up on the zero layer, the following functions are available:

- Controlling media playback
 - Selecting tracks from the current playlist
 - Selecting a playback list
 - Media search
 - Selecting a media source
 - Creating favourites
 - Configuring settings
- ① Further information on:
- Overview of the zero layer (→ page 432).
 - Operating the zero layer (→ page 434).

Connecting the data storage medium to the multimedia system

Connecting USB devices

! **NOTE** Damage caused by high temperatures

High temperatures can damage USB devices.

▶ Remove the USB device after use and take it out of the vehicle.

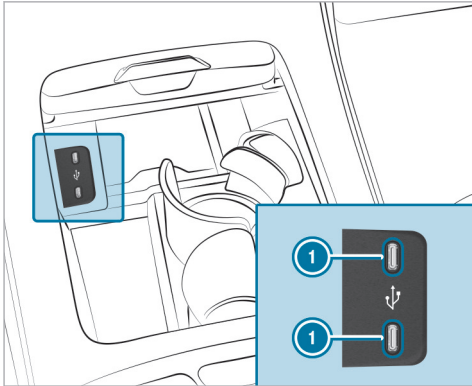

Vehicles with cup holders (example)

The multimedia connection unit is found in the centre console stowage compartment and has two type C USB ports ❶. Depending on the vehicle equipment, there are two more USB ports in the stowage compartment under the armrest. The charging power of the USB ports is at least 5 V (3 A) and, depending on the vehicle equipment, a maximum of 20 V (5 A).

- ▶ Connect the USB device to the USB port.

■ Searching for and authorising a Bluetooth® audio device

Requirements:

- Bluetooth® is activated on the multimedia system and audio equipment.
- The audio equipment supports the Bluetooth® audio profiles A2DP and AVRCP.
- The audio equipment is "visible" for other devices.

Multimedia system:



Authorising a new Bluetooth® audio device

- ▶ Select **Connect device**.
Detected equipment is displayed in the device list.
- ▶ Select an audio device.
Authorisation starts. A code is displayed on the multimedia system and on the mobile phone.

- ▶ If the codes are identical, confirm on the audio equipment.
- ▶ Select **No, only music**.
The Bluetooth® audio equipment is connected with the multimedia system.

Connecting previously authorised Bluetooth® audio equipment

- ▶ Select a Bluetooth® audio device from the list.
The connection is being established.

Starting media playback

Requirements:

- A data storage medium is connected to the multimedia system.

Multimedia system:



- ▶ Select a media source.

Controlling media playback

Multimedia system:

Media

▶ **To pause playback:** select .

▶ **To continue playback:** select .

▶ **To repeat a track:** select .

For the repeat function there are the following settings:

- **Select once:** the active playlist is repeated.
- **Select twice:** the current track is repeated.
- **Select three times:** the repeat function is deactivated.

▶ **To play back tracks in random order:** select .

▶ **To rewind or fast-forward a track:** tap on the desired point on the timeline.

▶ **To select the next track:** select .

▶ **To select the previous track:** select .

▶ **To scroll through tracks quickly:** press and hold or .

▶ **To show the current track list:** select .

i You can also control media playback on the zero layer using the control menu displayed (→ page 432).

Additional options for setting media playback

Multimedia system:

Media

Calling up additional options

- ▶ Select . The additional options are shown.
- ▶ Select an option.

Media search

Notes about the search function in categories

Under you can search through all available media files. There are several categories available for selection. The categories shown depend on the connected device and data format.

i The categories are available as soon as the entire media content has been read in and analysed.

Availability of the media search with Android devices may be limited.

Starting a search in categories

Multimedia system:

Media

▶ Select a category.

Using the keyword search

Multimedia system:

Media

You can look for content using the keyword search with free text input.

- ▶ Select . A keyboard for character entry appears.
- ▶ Enter the term searched for.

i The search begins with the first character entered. The more characters entered the more concrete the search results become.

▶ Select the desired entry from the result list. If a list with several tracks is selected, then this is opened in the search.

To playback all of the tracks in the list, select  and then **Play now**.

Media mode on the front passenger display (only vehicles with MBUX Hyperscreen)

Information about media mode

You can also use functions of the MBUX multimedia system on the front passenger display.

You can find more information on the following topics:

- Information about supported formats and data storage media (→ page 569)
- Information on copyright protection and trademarks (→ page 570)
- Overview of the media menu (→ page 572)

Bluetooth® headphones can be connected to the MBUX multimedia system on the front passenger display.

⚠ WARNING Risk of injury from unsecured items in the vehicle

If objects such as headphones/headsets or external audio/video sources are not secured in the vehicle interior, they can be flung around and hit vehicle occupants.

- ▶ Always stow these items or similar objects carefully so that they cannot be flung around, for example in a lockable vehicle stowage compartment.

Observe the notes on loading the vehicle.

⚠ WARNING Health hazard due to excessive volume on headphones

Excessive volume can damage your hearing.

- ▶ Avoid wearing headphones for long periods of time and at too high a volume (85 decibels).
- ▶ Ensure that the volume is set to a comfortable level.

i The headphones are special equipment for the MBUX multimedia system.

You can also obtain the headphones from Mercedes-Benz Customer Solutions or in a specialist shop (see the manufacturer's operating instructions).

i The function of wireless headphones can be impaired by other radio-based electronic devices, such as mobile phones, for example.





Starting and operating media playback

Requirements:

- A data storage medium is connected to the multimedia system.

Multimedia system:

 **Media**

- ▶ Select a media source.
- ▶ **To adjust the volume:** select  in the menu line and press  or .
- ▶ **To set playback via vehicle loudspeakers:** press  in the menu line.
- ▶ **To connect Bluetooth® headphones to the front passenger display:** press  in the menu line and select the desired headphones.

The following functions are available:

- Controlling media playback (→ page 574)
- Options for setting media playback (→ page 574)
- Starting a search in categories (→ page 574)
- Using the keyword search (→ page 574)

Music online

■ Requirements

- There is an account for the music streaming service.
 - A subscription for the music streaming service has been obtained.
 - The data volume is available.
Depending on the country, data volume may need to be purchased.
 - A fast Internet connection for data transmission free of interference.
-  The functions and services are country-dependent. For more information, consult a Mercedes-Benz service centre.

Multimedia system:



Media

Adding a streaming provider the first time you start the application



- ▶ Select **Online music**.
The overview of all supported streaming providers appears.
- ▶ Select a streaming provider.
A QR code is shown on the display.
- ▶ Scan the QR code with the mobile phone.
- ▶ Confirm the connection request on the mobile phone.

Adding more streaming providers

- ▶ Select **Online music**.
The last active streaming provider is active.
- ▶ Select .
- ▶ Select **Music services**.
The overview of all supported streaming providers appears.
- ▶ Select a streaming provider.
A QR code is shown on the display.

- ▶ Scan the QR code with the mobile phone.
- ▶ Confirm the connection request on the mobile phone.

Logging out from a streaming provider

- ▶ Select **Online music**.
The last active streaming provider is active.
- ▶ Select .
- ▶ Select **Music services**.
The overview of all supported streaming providers appears.
- ▶  next to the streaming provider.
- ▶ Tap on **Log out**.

■ Calling up music online

Multimedia system:



Media

- ▶ Select **Online music**.

Music playback can be controlled with the Touch Control or by using the media application.

Searching for music in online music

Multimedia system:

 **Media** **Online music**

Searching for categories in online music

The media content of the streaming provider can be scanned through in the category search. The available categories and the symbol for the category search depend on the streaming provider.

- ▶ Start the category search.
The list of available categories appears.
- ▶ Select a category.

Keyword search in online music

You can look for content using the keyword search with free text input.

- ▶ Select .
- A keyboard for character entry appears.
- ▶ Enter the term searched for.



- ⓘ The more characters entered when using the keyword search, the more concrete the search results are.

- ▶ Select the desired entry from the result list. Depending on the selected hit, playback is started or a lower level in the search is opened.

Calling up online music settings

Multimedia system:

 **Media** **Online music**

- ▶ Select .
- ▶ Select **Music services**.
- ▶ Select  next to a streaming provider.
- ▶ Select a setting.
- ⓘ Information about the linked accounts can be displayed using the  gear icon next to the configured streaming provider. The available information depends on what is offered by the provider of the streaming service.

Radio

Switching on the radio

Multimedia system:

 **Radio**

- ▶ Start the application on the multimedia system home screen.
The radio menu appears. You will hear the last station played on the last frequency band selected.

Radio overview

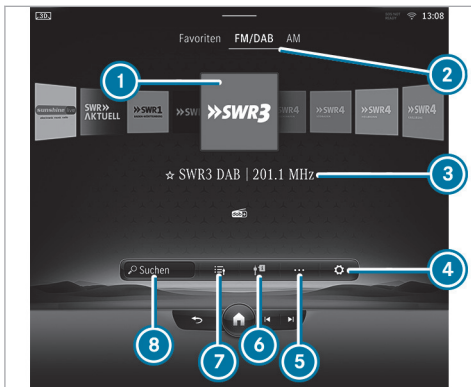

- ① Preview image
- ② Active frequency band
- ③ Station name or set frequency
- ④ Settings
- ⑤ Additional options
- ⑥ Switches on traffic reports

With DAB equipment: switches on radio announcements

- ⑦ Station list
- ⑧ Search

ⓘ The availability of the frequency bands is dependent on the equipment.

When the control menu is called up on the zero layer, the following functions are available:

- Selecting a radio station
 - Setting radio stations from the station list
 - Storing radio stations
 - Frequency band
 - Search function
 - Creating favourites
 - Configuring settings
- ⓘ Further information on:
- Overview of the zero layer (→ page 432).
 - Operating the zero layer (→ page 434).

You can watch an animation on this topic via the following link:

Setting the frequency band

Multimedia system:



- ▶ Select a frequency band or a favourite.

Selecting a radio station

Multimedia system:



- ▶ Swipe to the left or right on the control element or select a radio station.

ⓘ You can also set the previous/next radio station on the zero layer using the control menu displayed (→ page 432).

Calling up the radio station list

Multimedia system:



- ▶ Select .
- ▶ The station list appears.
- ▶ Swipe the station list up or down.

- ▶ Select a station.

Searching for radio stations using station names or frequency entry

Multimedia system:



- ▶ Select .
- ▶ Enter a station name or frequency.
- ▶ Select a station.

Selecting a recommended radio station

Requirements:

- The [Allow music suggestions](#) option is switched on (→ page 442).
- The multimedia system has gathered sufficient data in order to show station suggestions.

Multimedia system:



- ▶ Select .
- The recommended stations are shown.

- ▶ Select a suggested station.
The selected station is played.

Storing radio stations

Multimedia system:





- ▶ Select a radio station.
- ▶ Select .

Managing favourites

Multimedia system:



Moving stations

- ▶ Press .
- ▶ The list of favourites appears.
- ▶ Press  to the far right of the station name.
- ▶ Select [Move](#).
- ▶ Move the station to the new position.

Setting station tracking via Internet radio

Requirements

- A fast Internet connection for data transmission free of interference.

Multimedia system:



- ▶ Select .
- ▶ Select [Internet radio](#).
- ▶ Activate or deactivate the [Service Following](#) function.
When the function is on, the station is searched for via Internet Radio.
If you are driving out of the station's coverage area and the station is available via Internet radio, the [Poor reception. Tap here to switch to Internet radio](#) message appears on the central display.

Calling up a slide show (FM/DAB radio mode)

Multimedia system:



The slide show displays additional information provided by the station as an image. This can include logos, album covers, music tracks, programmes, news or service information, for example.



i The slide show is available for DAB+ channels that broadcast additional information.

- ▶ Press the station picture on the central display.
The image is enlarged.

Switching a slideshow on or off (FM/DAB radio mode)

Multimedia system:



- ▶ Switch **DAB Slideshow** or **Expanded Radio Slideshow** on  or off .
- When both slideshows are switched on, the contents of both slideshows alternate.

Activating/deactivating the frequency fix function

Multimedia system:



▶▶ **Active frequency band**

- ▶ Activate or deactivate **Frequency fix**.
If the function is activated, the set frequency is kept even if the reception is poor.

Activating/deactivating traffic announcements

Multimedia system:



- ▶ Select **TA**.
The traffic information is switched on or off.

Activating/deactivating radio announcements

Multimedia system:



- ▶ Switch on **Radio announcements**.
The selected radio announcements are played.

When **Radio announcements** are first switched on, **Traffic information service (TA)**, **Travel and Warning** are preset.

or

- ▶ Switch off **Radio announcements**.
No radio announcements are played.

Selecting radio announcements

Multimedia system:



▶▶ **Radio announcements**

- ▶ Switch an announcement on or off.
For example, **Traffic information service (TA)**, **Travel** or **Warning** can be selected.

i The radio announcements are not station-dependent.

Setting the traffic information service volume increase

Multimedia system:

     System  Audio

- ▶ Select **Navigation & traffic announcements**.
- ▶ Set a value for **Traffic announc. vol. increase**.

Displaying radio text

Multimedia system:

    Radio  

- ▶▶ **Active frequency band**
- ▶ Activate or deactivate **Radio text information**.

Showing or hiding lyrics

-  The function is equipment-dependent.

Multimedia system:

    Radio  

Showing lyrics

- ▶ Select **Show lyrics**.
The lyrics, album cover, title and artist of the song currently playing on the radio are displayed.
Swipe up or down to go to the bottom or top section of the lyrics.
If no lyrics are available for the song currently playing on the radio, **Show lyrics** is greyed out.

Hiding lyrics

- ▶ Select the cross at the top of the lyrics display.
- or
- ▶ Select .
The radio menu appears.

TV

Information on TV mode

Information on copyright protection and trademarks

Copyright® 2015 Ubiquitous Corp.

DVB and DVB logos are trademarks of the DVB Project.

The TV tuner can receive programmes in Dolby Digital Plus.



Manufactured under licence from Dolby Laboratories. Dolby, Dolby Audio and the double-D symbol are trademarks of Dolby Laboratories.

The TV tuner automatically sets the TV standard.

TV reception is dependent on the following factors:

- Speed
- Characteristics of the selected TV channel

TV reception may be influenced by the following factors:

- Electronic devices which are taken into the vehicle may impair TV reception.
- The conditions for reception may change whilst the vehicle is in motion.

Poor reception conditions can have the following effect:

- The TV tuner switches to an alternative digital channel with better reception with the same programme content.
- The TV tuner mutes the sound, freezes the screen or hides it. The  symbol appears in the display.

Switching to TV mode

Multimedia system:



- ▶ Select **TV**.
The TV picture appears. If available, the channel and programme information is displayed.

If the vehicle is travelling faster than 5 km/h the television picture is hidden from the driver. If available, the channel and programme information is continuously displayed.

- ▶ **To show a TV programme on a full screen:** tap on the preview picture.

TV mode overview

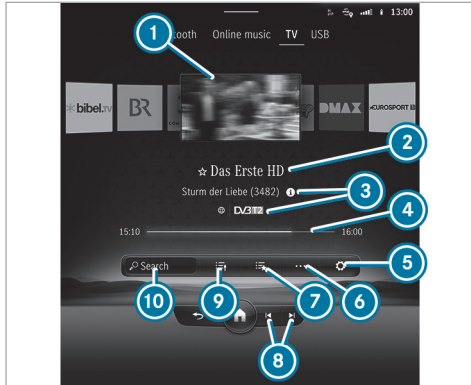

- 1 Preview image
- 2 Station name
- 3 Features of the TV channel and the current programme
- 4 Start and finish times of the current programme, graphic showing the remaining broadcast time

- 5 Settings
- 6 Additional options
- 7 Favourites
- 8 Selects the previous or next TV channel from the channel list
- 9 Station list
- 10 Searches for a TV channel

Overview of symbols



- 1 TV standard
- 2 Channel fix active
- 3 Audio languages available
- 4 Subtitles available

- 5 TV channel is encrypted
Open lock: TV channel can be decrypted with the currently connected CI+ module

Showing or hiding full screen

Multimedia system:

→ [Home] → Media → TV

- ▶ **To show full screen:** press the preview picture.
- ▶ **To hide full screen:** press [Back] on the central display.
The TV menu appears.

Selecting TV channels

Selecting TV channels from the menu

Multimedia system:

→ [Home] → Media → TV

- ▶ Press [Left] or [Right] on the central display.
The TV tuner sets the previous/next channel from the channel list.

Selecting TV channels from the channel list

Multimedia system:

→ » **Media** » **TV**

- ▶ Select in the menu.
- ▶ Select a TV channel.
The TV tuner selects the channel from the channel list.
- ▶ Press the preview picture.

Searching for a TV channel

- ▶ Select the search bar next to (→ page 583).
 - ▶ Enter the first characters.
 - ▶ Select the TV channel from the channel list.
- Further information on the search bar (→ page 585).

Selecting a TV channel from the favourites

Requirements:

- The TV channel is stored.

Multimedia system:

→ » **Media** » **TV**

Selecting from favourites

- ▶ Select in the menu (→ page 583).
- ▶ Select the TV channel.

Selecting TV channels in the background

Requirements:

- Another application is active, e.g. the navigation, in the foreground.
 - TV mode is switched on in the background and the sound from the selected TV channel can be heard
- ▶ Press or on the central display.
The TV tuner sets the previous/next channel from the channel list.

Displaying current programme information for the selected channel (EPG)

Multimedia system:

→ » **Media** » **TV** »

EPG displays the following information (if available):

- Broadcast times
- Names of the current and upcoming programmes

- ▶ Select a programme name with .
The programme information is displayed.
- ▶ **To scroll:** swipe up or down.
- ▶ **To leave the programme information display:** select .

Function of the channel fix setting

Channel fix is switched on

The channel is not changed. This is useful if, for example, you drive the vehicle through reception regions that overlap. It prevents frequent switching back and forth between the channels.

The **FIX** indicator is displayed after the name of the TV channel.

Channel fix is switched off

Depending on reception quality, the TV tuner automatically switches to an alternative channel with the same programme content but better reception. Using this function, the best possible television picture can be found, regardless of the reception quality.

Activating/deactivating channel fix

Multimedia system:

Media **TV** **TV**

- ▶ Activate or deactivate **Station fix**.
When the option is switched on, the display button is activated.

Switching the country-specific character set for the TV channel on/off

Multimedia system:

Media **TV** **TV**

- ▶ Activate or deactivate **Country-specific character set**.

When the option is switched on, a country-specific character set is used for the display.

When the option is switched off, the character set transmitted by the currently set TV channel is used for the display.

The respective TV channel is responsible for the transmission of the channel-dependent character set.

Channel list overview

The TV tuner shows the current programme on the digital TV channels or radio stations with adequate reception in its own channel list.

The order of the channel lists is alphabetical or country-specific.

The TV tuner requires a short amount of time to update the information.

The channel lists show the following information:

- receivable channel names
- programme title

The information is shown under the following conditions:

- it is broadcast by the digital channel
- the reception conditions are adequate

Favourites

Overview of TV programmes (favourites)

You can save up to 100 digital TV channels in favourites.

For quick-access you can save TV channels as favourites.

Storing TV channels



Multimedia system:

Media **TV**

Adding a TV channel to favourites

- ▶ Select a TV channel.
- ▶ Select .

Moving a TV channel within favourites

- ▶ Press . The list of favourites appears.
- ▶ Press  next to the channel name.
- ▶ Select **Move**.
- ▶ Move the channel to the new position.

Removing a TV channel from favourites

- ▶ Select a TV channel.
- ▶ Select .

TV programme

Setting the TV audio language

Multimedia system:



- ▶ Select one of the available audio languages  under the **Audio language** category.
- ▶ Select one of the available options for the selected audio language. The selected audio language, e.g. French, will be kept until the multimedia system is switched off.

When you switch on the multimedia system again, the system language is loaded as the audio language. If this is not available, the audio language that appears at the beginning of the list is loaded.

Setting the TV subtitles

Multimedia system:



- ▶ Select the available languages  under the **Subtitles** category.
- ▶ Select one of the available options for the selected language. The selected language, e.g. French, will be kept until the multimedia system is switched off. When you switch on the multimedia system again, the system language is loaded as the language. If this is not available, the language that appears at the beginning of the list is loaded.
- ▶ **To show no subtitles:** switch **Activate** off.

Hiding encrypted TV channels

Multimedia system:



- ▶ Select **Hide encrypted channels**. When you start the application for the first time or after the system is reset, all TV channels are displayed. If **Hide encrypted channels** is active, all free-to-air TV channels and TV channels decoded by the CI+ module, for example, are displayed.

Teletext

Teletext overview

Teletext pages are located between page 100 and page 899.

A dynamic teletext page consists of several sub-pages.

Information on MHEG-5 digital teletext:

- Digital teletext is only available in some countries, e.g. the UK and New Zealand

- Interactive multimedia applications such as weather forecasts, news reports and sport results are available
- It may take some time before all the pages load

Showing teletext

Multimedia system:



- ▶ **To switch to page selection:** switch between number entry and selection using the arrow button with and 123.
- ▶ **To call up a side:** enter the numbers in quick succession.

or

- ▶ Select the arrow buttons.
- ▶ **To return to the TV programme:** select TV.

MHEG-5 digital teletext

Apart from the functions described above, additional options can be used.

- ▶ **To call up data content using colours:** select a colour.

- ▶ **To move back a level:** select a list symbol.

Picture settings

Selecting picture settings for the TV

Multimedia system:



- ▶ **To set the picture format:** activate one of the Automatic, 4:3, 8:3, 16:9, 21:9 or Zoom display buttons.

The brightness is automatically set.

HD programmes

Receiving encrypted HD programmes

! **NOTE** Damage to the CI+ capable CA module (Conditional Access module) and the Smart Card due to sustained high heat

The CI+ capable CA module is designed for home use. The CI+ capable CA module can

overheat and be damaged at continuously high outside temperatures.

- ▶ Make sure that the CI+ enabled CA module is not exposed to prolonged high temperatures. If the CI+ capable CA module is damaged, no encrypted channels can be received.

A CI+-capable CA module (Common Interface Plus capable CA module), which is not included in the scope of delivery, is used to decrypt HD programmes according to the CI+ standard.

In some countries, an additional smart card is required, which is inserted into the CI+-capable CA module (see the manufacturer's operating instructions).

The CI+-capable CA module is connected in the CI+ box in the glove compartment.

- ▶ **To insert or remove the CI+-capable CA module in the CI+ box:** to insert or remove the CI+-capable CA module in the CI+ box, press the catch downwards.

Make sure that the catch does not exert any lateral pressure on the CI+-capable CA module when inserting or removing it.

▶ **To insert the smart card in the CI+-capable CA module:** if required (country-dependent), insert the smart card into the CI+-capable CA module slot.

Encrypted HD programmes can be received according to the CI+ standard.

- ❶ The CI+ box is not available in all countries.
- ❷ The CI+ box is designed for operating temperatures between 0 °C and 65 °C. At operating temperatures that are too high or too low a message appears in the multimedia system and the CI+-capable CA module is switched off automatically. If the CI+-capable CA module is switched off, no encrypted channels can be received.
- ❸ If a CI+-capable CA module is connected, **Card status reminder** is switched on (→ page 588) and the vehicle is switched off, the **CI+ card is still in the vehicle.** message appears on the central display.

■ Calling up the menu for the CI+-capable CA module

Multimedia system:

→  ▶ Media ▶ TV

Switching the reminder of a connected CI+-capable CA module on or off

- ❶ The CI+-capable CA module is not available in all countries.
- ▶ Select .
- ▶ Select **General settings**.
- ▶ Switch the **Card status reminder** option on or off.

Calling up the menu for the CI+-capable CA module

- ▶ Select **CI+ module**.
- ▶ Select **Open menu**.
The subscription number can be shown in the menu, for example. The content of the menu depends on the manufacturer of the CI+-capable CA module.

- ❶ You need the subscription number to extend the subscription, for example. Further information can be found in the manufacturer's operating instructions.

▶ **To reset the TV tuner:** select **Reset TV tuner**.

If the playback is malfunctioning, you can try to solve the problem by restarting.

▶ **To restart CI+-capable CA module:** select **Restart CI+ module**.

Sound

Sound settings

■ Information about the sound system

The sound system has a total output of 125 W and is equipped with seven speakers. It is available for all functions in the radio and media modes.

- ❶ The call can also be made from other audio sources. Replace Media with, for example, Radio in the menu path.

■ Calling up the sound menu

Multimedia system:



- ▶ Select one of the functions shown to make settings.

■ Adjusting treble, mid-range and bass settings

Multimedia system:



- ▶ Set **Treble**, **Mid** or **Bass**.

■ Switching loudness normalisation on or off

Multimedia system:



- ▶▶ **Loudness normalisation**

The function compensates for differing loudness when changing between audio sources and within an audio source. Several levels are available for this purpose. The currently set level is displayed.

The loudness normalisation can also be switched off.

- ▶ Switch on one level.

or

- ▶ Switch off the loudness normalisation.

■ Setting the balance and fader

Multimedia system:



- ▶▶ **Balance and Fader**

Adjusting the balance

- ▶ In the grid shown, move the volume distribution between the right and left speakers in the vehicle.
The volume is distributed between the right and left-hand speakers.

Adjusting the fader

- ▶ In the grid shown, move the volume distribution between the front and rear speakers in the vehicle.
The volume is distributed between the front and rear speakers.

Burmester® 3D-surround sound system

■ Information about the Burmester® 3D-surround sound system

The Burmester® 3D-surround sound system has a total output of 710 W and is equipped with 15 speakers. It is available for all functions in the radio and media modes.

- ⓘ The call can also be made from other audio sources. Replace Media with, for example, Radio in the menu path.

■ Calling up the sound menu in the Burmester® 3D-surround sound system

Multimedia system:



- ▶ Select one of the functions shown to make settings.

■ Adjusting the treble, mid and bass settings on the Burmester® 3D-surround sound system

Multimedia system:



- ▶ Set **Treble**, **Mid** or **Bass**.

Switching loudness normalisation in the Burmester® 3D-surround sound system on or off

Multimedia system:

 Media >> Equaliser
 >> Loudness normalisation

The function compensates for differing loudness when changing between audio sources and within an audio source. Several levels are available for this purpose. The currently set level is displayed.

Switch off loudness normalisation as follows:

- ▶ Switch on one level.

or

- ▶ Switch off the loudness normalisation.

Adjusting the balance and fader in the Burmester® 3D-surround sound system

Multimedia system:

 Media >> Balance and Fader

Adjusting the balance

- ▶ Move the volume distribution between the right and left sides of the vehicle in the grid shown.
The volume is distributed between the speakers on the left and right sides in the vehicle.

Adjusting the fader

- ▶ Move the volume distribution between the front and rear of the vehicle in the grid shown.
The volume is distributed between the speakers in the front and rear of the vehicle.
- ⓘ Setting 0 is recommended for high quality music and voice reproduction.

Selecting a sound profile in the Burmester® 3D-surround sound system

Multimedia system:

 Media >> Settings

Setting an existing sound profile

- ▶ Select a sound profile.

Setting up a personal sound profile

- ▶ Select **Personal sound profile** and .
- ▶ Select **Reconfigure**.
- ▶ Restart the set-up assistant.

Setting up a personal sound profile for the first time:

- ▶ Select **Personal sound profile**.
- ▶ Open the set-up assistant with **Start**.
- ▶ Observe the messages on the display and select the preferred settings.
The personal sound profile is created with the selected settings and can be selected in the **Sound profiles** menu.

Changing individual settings of the personal sound profile at a later date:

- ▶ Select **Personal sound profile** and .
- ▶ Make the required adjustments.
- ⓘ The availability of a **Personal sound profile** is dependent on the equipment.
The set-up assistant is available when the vehicle is stationary.

Adjusting the sound focus in the Burmester® 3D-surround sound system

Multimedia system:

  ▶▶ **Media** ▶▶  ▶▶ **Sound focus**

- ▶ Select a seat or row of seats for the sound focus.
The sound focus is activated.
- or
- ▶ Select the seat or row of seats again.
The sound focus is deactivated.

Advanced sound system

Information about the Advanced sound system

The Advanced sound system has a total output of 225 W and is equipped with eleven speakers. It is available for all functions in the radio and media modes.

- ⓘ The call can also be made from other audio sources. Replace Media with, for example, Radio in the menu path.

Calling up the sound menu in the Advanced sound system

Multimedia system:

  ▶▶ **Media** ▶▶ 

Adjusting sound settings

- ▶ Select one of the functions shown.

Adjusting treble, mid-range and bass settings in the Advanced sound system

Multimedia system:

  ▶▶ **Media** ▶▶ 

- ▶ Set **Treble**, **Mid** or **Bass**.

Switching loudness normalisation in the Advanced sound system on or off

Multimedia system:

  ▶▶ **Media** ▶▶  ▶▶ **Equaliser**
▶▶ **Loudness normalisation**

Switching off loudness normalisation

- ▶ Switch on one level.
- or
- ▶ Switch off loudness normalisation.

Setting the balance/fader in the Advanced sound system

Multimedia system:

  ▶▶ **Media** ▶▶ 
▶▶ **Balance and Fader**

Adjusting the balance

- ▶ Move the volume distribution between the right and left sides of the vehicle in the grid shown.
The volume is distributed between the speakers on the left and right sides in the vehicle.

Adjusting the fader

- ▶ Move the volume distribution between the front and rear of the vehicle in the grid shown. The volume is distributed between the speakers in the front and rear of the vehicle.

Sound Experience

Information about Sound Experience

Your journey will be an acoustic experience. For this purpose, the active Sound Experience accompanies certain situations in the vehicle with selected sounds.

In the vehicle interior, for example, the following situations are accompanied by selected sounds:

- Arrival in the vehicle
- Starting the drive system
- Vehicle acceleration
- Recovery of energy from the braking procedure
- Exiting the vehicle

In the exterior area, for example, the following situations are accompanied by selected sounds:

- Locking and unlocking your vehicle
- Plugging in and unplugging the vehicle plug
The sound when disconnecting the vehicle plug varies with the state of charge of your vehicle.
- Unlocking the vehicle plug
- Successful initiation of the charging process
- Malfunction when charging

In addition, your vehicle welcomes you with an ambient sound outside when the vehicle is stationary and unlocked.

- ⓘ The availability of the exterior area sounds is dependent on the country.

Calling up Sound Experience

Multimedia system:

- ▶  ▶ Settings ▶ Vehicle ▶ Driving ▶ Sound Experience

Switching Sound Experience on or off

- ▶ Switch **Sound Experience inside** or **Sound Experience outside** on or off.

- ⓘ The availability of the Sound Experience outside is country-dependent.

Selecting Sound Experience style

- ▶ Select a style.

Styles are already available, for example **Vivid Flux**.

You can purchase additional styles through the Mercedes me Portal.

- ⓘ The availability of styles that can be purchased is country-dependent.

AMG Sound Experience

Information about AMG Sound Experience

Your journey will be an acoustic experience. For this purpose, the active Sound Experience accompanies certain situations in the vehicle with selected sounds.

In the vehicle interior, for example, the following situations are accompanied by selected sounds:

- Arrival in the vehicle
- Starting the drive system
- Vehicle acceleration
- **RACE START**

In the exterior area, for example, the following situations are accompanied by selected sounds:

- Locking and unlocking your vehicle
- Plugging in and unplugging the vehicle plug
- Locking and unlocking the vehicle plug
- Successful start of the charging process

i The intensity and dynamics of the sounds vary with the set drive programme.



i You can choose between a comfortable (Balanced), a sporty (Sport) or a very sporty (Powerful) supporting characteristic of the driving sounds inside the vehicle. Use the steering wheel buttons (→ page 266) or the multimedia system (→ page 271) to set the supporting sound characteristics.

Calling up AMG Sound Experience

Multimedia system:

 →  » Settings » Vehicle » Driving » Sound experience

Switching Sound Experience Events inside or outside on or off

 Switch **Sound Experience Events inside** or **Sound Experience Events outside** on  or off .

Selecting Sound Experience style

 Select a style, e.g. **Authentic**.

i The availability of the style is dependent on the equipment.

ASSYST PLUS service interval display

Function of the ASSYST PLUS service interval display

The ASSYST PLUS service interval display on the driver's display informs you of the next regular service due date.

Depending on the operating conditions of the vehicle, the remaining time or distance until the next service due date will be displayed.

You can hide this service display using the back button  on the steering wheel.

You can obtain information concerning the servicing of your vehicle from a qualified specialist workshop, e.g. a Mercedes-Benz Service Centre (→ page 85).

Displaying the service due date

Driver's display:



The next service due date is displayed.

To exit the display: press the back button  on the steering wheel.

Information on regular maintenance work

! **NOTE** Premature wear through failure to observe service due dates

Maintenance work which is not carried out at the right time or incompletely can lead to increased wear and damage to the vehicle.

- ▶ Adhere to the prescribed service intervals.
- ▶ Always have the prescribed maintenance work carried out at a qualified specialist workshop.

! **NOTE** Irreparable damage to the high-voltage battery due to maintenance work not being carried out

The high-voltage battery is subject to wear. Maintenance work which is not carried out in time can lead to irreparable damage to the high-voltage battery.

- ▶ Always observe the warning messages about the high-voltage battery and

immediately consult a qualified specialist workshop.

- ▶ Have the necessary maintenance work on the high-voltage battery carried out at a qualified specialist workshop.

Notes on special service requirements

The prescribed service interval is based on normal operation of the vehicle. Have the maintenance work carried out more often than prescribed if operating conditions are difficult or the vehicle is subject to increased stress. This is the case for frequent operation in mountainous terrain or on poor road surfaces, for example.

In these or similar operating conditions, have the interior air filter changed more frequently. Check the tyres more frequently if the vehicle is operated under increased stress. Further information can be obtained at a qualified specialist workshop.

The ASSYST PLUS service interval display is only an aid. It is the responsibility of the driver of the vehicle to have maintenance work carried out

more often than prescribed due to actual operating conditions and/or stresses.

Battery disconnection periods

The ASSYST PLUS service interval display can calculate the service due date only when the battery is connected.

- ▶ Display and note down the service due date on the driver display before disconnecting the battery (→ page 594).

Maintenance Management

Notes about Maintenance Management

If the Maintenance Management service is activated, relevant data is automatically transferred to the Mercedes-Benz customer centre.

The customer centre transmits the data to the service partner that you have entered on the Mercedes me website at: <http://www.mercedes.me>. You will then receive individual recommendations regarding the maintenance of your vehicle.

- ❗ The calculation of the optimal transmission time of the maintenance request to the service partner is subject to technical limitations that may cause the maintenance recommendation to be perceived as too early or too late or not to be made at all. In this case, you can conveniently arrange a maintenance appointment with the customer centre via the maintenance reminder in the multimedia system.
- ❗ Maintenance Management and the maintenance reminder in the multimedia system are not available in every country. Contact a Mercedes-Benz service centre to find out whether this function is available in your country.

Data transferred when using Maintenance Management

When the service is activated, relevant data is automatically transferred to determine the required scope of maintenance as well as fault detection and fault rectification.

Details on data transfer can be found in the data protection information for the Mercedes me connect services. These can be found at: <https://www.mercedes.me> under "My Mercedes me account", "Terms of use".

- ❗ Maintenance Management and the maintenance reminder in the multimedia system are not available in every country.

Telediagnosics

Notes about Telediagnosics

- ❗ This service is not available in all countries. The vehicle can detect if certain wear parts need to be replaced or if malfunctions have occurred in vehicle systems. If the Telediagnosics service is activated, relevant data is automatically transmitted to the manufacturer. If fault conditions are detected by the vehicle system self-diagnosis, the system transmits recommendations for action to the Mercedes-Benz customer centre depending on the fault detected. The customer centre transmits the data to the service partner that you have

entered on the Mercedes me website at: <http://www.mercedes.me>.

For selected faults, the notification that a malfunction has been detected may appear in the multimedia system with a request to contact the Mercedes-Benz Customer Centre. From this message, a call can be made directly to the customer centre for assistance.

- i The transmission of a notification to the multimedia system depends on the country, vehicle model and equipment and requires a fast data connection, over which the service provider has no influence.
- i Reliable fault detection is subject to technical limitations. Therefore, only a limited selection of faults can be detected and recommendations for action transmitted to the customer centre and the service partners. Mercedes-Benz AG is continuously working on the expansion of this service. The fault detection depends on the country, vehicle model and equipment.

Data transferred when using Telediagnosics

When the service is activated, relevant data is automatically transferred to determine the required scope of maintenance as well as fault detection and fault rectification.

Details on data transfer can be found in the data protection information for the Mercedes me connect services. These can be found at: <https://www.mercedes.me> under "My Mercedes me account", "Terms of use".

- i The scope of the data transmitted depends on the vehicle model and equipment. For technical reasons, not all data is available at all times.

Engine compartment

Active bonnet (pedestrian protection)

Operation of the active bonnet (pedestrian protection)

In certain accident situations, the actuation of the active bonnet reduces the risk of injury to pedestrians. The rear area of the bonnet is raised by approximately 80 mm.

After being triggered, the active bonnet remains in the raised position. Limited visibility due to the raised bonnet cannot be ruled out.

After the active bonnet has been actuated, pedestrian protection may be limited.

Have the full functionality of the active bonnet restored immediately in a qualified specialist workshop.

If necessary, adjust your seat position and drive carefully to a qualified specialist workshop. If a safe continued journey is not possible, contact a qualified specialist workshop.

Notes on the bonnet

Only the specialist personnel of a qualified specialist workshop should open the bonnet. Access by the customer is not permitted.

To open the bonnet, consult a qualified specialist workshop.

⚠ DANGER Risk of fatal injuries when carrying out maintenance work during the charging process

During the charging process, the high-voltage on-board electrical system is under high voltage.

- ▶ Do not perform any maintenance work during the charging process.

⚠ WARNING Risk of accident due to driving with the bonnet unlocked

The bonnet may open and block your view.

- ▶ Never release the bonnet when driving.
- ▶ Before every trip, ensure that the engine bonnet is locked.

⚠ WARNING Risk of accident and injury when opening and closing the bonnet

The bonnet may suddenly drop into the end position.

There is a risk of injury for anyone in the engine bonnet's range of movement.

- ▶ Do not open or close the bonnet if there is a person in the bonnet's range of movement.

⚠ WARNING Risk of injury due to overheated vehicle

If you open the bonnet in the event of an overheated vehicle or fire in the engine compartment, the following situations may occur:

- You may come into contact with hot gases.
- You may come into contact with other escaping hot operating fluids.
- ▶ In the event of overheating or fire in the engine compartment, keep the bonnet closed and call the fire service.
- ▶ Allow the overheated vehicle to cool down first if you need to open the bonnet.

⚠ WARNING Risk of injury due to moving parts

Components in the engine compartment may continue to run or start unexpectedly even when the drive system is switched off.

Observe the following if you must open the bonnet:

- ▶ Switch off the vehicle.
- ▶ Never touch the danger zones surrounding moving components, e.g. the rotation area of the fan.
- ▶ Remove jewellery and watches.
- ▶ Keep items of clothing and hair away from moving parts.

⚠ WARNING Risk of injury from using the windscreen wipers when the bonnet is open

If the windscreen wipers start moving when the bonnet is open, you could be trapped by the wiper linkage.

- ▶ Always switch off the windscreen wipers and the vehicle first if you need to open the bonnet.

Notes on the coolant level

Checking or topping up coolant should be carried out only by the trained personnel of a qualified specialist workshop. Access by the customer is not permitted.

To check or top up coolant, use a qualified specialist workshop.

- ⚠ DANGER** Risk of fatal injuries when carrying out maintenance work during the charging process

During the charging process, the high-voltage on-board electrical system is under high voltage.

- ▶ Do not perform any maintenance work during the charging process.

- ⚠ WARNING** Risk of injury due to overheated vehicle

If you open the bonnet in the event of an overheated vehicle or fire in the engine compartment, the following situations may occur:

- You may come into contact with hot gases.
- You may come into contact with other escaping hot operating fluids.
- ▶ In the event of overheating or fire in the engine compartment, keep the bonnet closed and call the fire service.
- ▶ Allow the overheated vehicle to cool down first if you need to open the bonnet.

- ⚠ WARNING** Risk of injury due to moving parts

Components in the engine compartment may continue to run or start unexpectedly even when the drive system is switched off.

Observe the following if you must open the bonnet:

- ▶ Switch off the vehicle.
- ▶ Never touch the danger zones surrounding moving components, e.g. the rotation area of the fan.
- ▶ Remove jewellery and watches.
- ▶ Keep items of clothing and hair away from moving parts.

- ⚠ WARNING** Risk of scalding from hot coolant

You may scald yourself if you open the cap when the drive system is at normal operating temperature.

- ▶ Allow the engine to cool down before opening the cap.
- ▶ When opening the cap, wear protective gloves and safety glasses.
- ▶ Open the cap slowly to release pressure.

Keeping the air/water duct free

- ▶ Keep the area between the bonnet and the windscreen free of deposits, e.g. ice, snow or leaves.

Topping up the windscreen washer system

- ⚠ WARNING** Risk of fire and injury from windscreen washer concentrate

Windscreen washer concentrate is highly flammable.

- ▶ Avoid fire, naked flames, smoking and the creation of sparks when using windscreen washer concentrate.

Requirements

- The vehicle is unlocked.

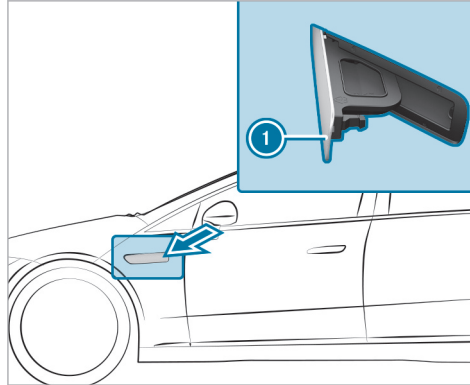

- ▶ Press on the rear area of washer fluid filler flap ①. Washer fluid filler flap ① will open.
- ▶ Top up the washer fluid.
- ▶ Close washer fluid filler flap ①.

You can watch an animation on this topic via the following link:

Cleaning and care

Information on washing the vehicle in a car wash

- ⚠ WARNING** Risk of an accident due to reduced braking power after washing the vehicle

Braking efficiency is reduced after washing the vehicle.

- ▶ After the vehicle has been washed, brake carefully while paying attention to the traffic conditions until braking power has been fully restored.

- ! NOTE** Damage from automatic braking

If one of the following functions is activated, the vehicle will brake automatically in certain situations:

- Active Brake Assist
- Active Distance Assist DISTRONIC
- HOLD function
- Active Parking Assist

To avoid damaging the vehicle, deactivate these systems e.g. during towing or in the car wash.

! **NOTE** Damage due to unsuitable car wash

- ▶ Before driving into a car wash make sure that the car wash is suitable for the vehicle dimensions.
- ▶ Ensure there is sufficient ground clearance between the underbody and the guide rails of the car wash.
- ▶ Ensure that the clearance width of the car wash, in particular the width of the guide rails, is sufficient.

To avoid damage to your vehicle when using a car wash, ensure the following beforehand:

- Active Distance Assist DISTRONIC is deactivated.
- The HOLD function is switched off.
- The 360° camera or the reversing camera is switched off.

- The vehicle is locked and the door handles are retracted.
- The side windows and sliding sunroof are completely closed.
- The outside mirrors are folded in.
- The blower for the ventilation and heating is switched off.
- The windscreen wiper switch is in position **0**.
- The key is at a minimum distance of 6 m away from the vehicle. Otherwise, the boot lid or a door could open unintentionally.

This also applies to the Digital Vehicle Key.

- For car washes with a conveyor system:
 - Neutral **N** is engaged.
 - The vehicle is locked from the inside.
- i** If, after the car wash, you remove the wax from the windscreen and wiper rubbers, this will prevent smearing and reduce wiper noise.

Automatic car wash mode

In car wash mode, the vehicle is prepared for driving into an automatic car wash. Car wash mode

can be activated at a speed of up to 20 km/h (→ page 601).

When car wash mode is activated, the **Car wash mode active** message will appear on the driver's display. The following adjustments will be made:

- The outside mirrors will be folded in.
- To prevent the windscreen washer system from starting up automatically, the rain sensor will be deactivated.
- The windows and the sliding sunroof will be closed, if necessary.
- The comfort doors will be deactivated.
- Parking Assist PARKTRONIC will be deactivated.
- **Vehicles with 360° camera:** The front image will be activated after approximately eight seconds.
- **Vehicles with HANDS-FREE ACCESS:** kick detection will be deactivated.

If one of the settings cannot be selected, this will be shown by the **X** symbol next to the respective setting.

Pressing **Switch off** will cancel car wash mode. Above a speed of 20 km/h, car wash mode will be deactivated automatically.

You can also switch off car wash mode via the MBUX multimedia system (→ page 601).

The following settings will be reset when car wash mode is deactivated:

- The outside mirrors will be folded out.
- The rain sensor will be activated.
- The comfort doors will be activated.
- Parking Assist PARKTRONIC will be reset to the previously selected setting.
- The windows and the sliding sunroof will remain closed.
- **Vehicles with 360° camera:** The front image will be deactivated at speeds above 18 km/h.
- **Vehicles with HANDS-FREE ACCESS:** kick detection will be activated.

Activating/deactivating car wash mode

Requirements

- The vehicle is stationary.

- The vehicle is switched on.

Multimedia system:

→  ► Settings ► Vehicle ► Driving

Activating car wash mode

- ▶ Select **Car wash mode**.
- ▶ Select **Activate**.

If one of the settings cannot be selected, this is shown by an  next to the respective setting.

- ⓘ For an overview of the settings made when you activate car wash mode (→ page 25).

Deactivating car wash mode

- ▶ Select **Switch off**.
The settings for car wash mode will be reset.
- ⓘ Car wash mode is automatically deactivated as soon as a speed of 20 km/h is exceeded.

Information on using a high-pressure cleaner

 **WARNING** Risk of an accident when using high-pressure cleaners with round-spray nozzles

The water jet can cause externally invisible damage.

Components damaged in this way may unexpectedly fail.

- ▶ Do not use a high-pressure cleaner with round-spray nozzles.
- ▶ Have damaged tyres or chassis parts replaced immediately.

To avoid damage to your vehicle, observe the following when using a high-pressure cleaner:

- The key is at a minimum distance of 3 m away from the vehicle. Otherwise, the boot lid or a door could open unintentionally.
This also applies to the Digital Vehicle Key.
- Maintain a distance of at least 30 cm to the vehicle.

- **Vehicles with decorative film:** Parts of your vehicle are covered with a decorative film. Maintain a distance of at least 70 cm between the film-covered parts of the vehicle and the nozzle of the high-pressure cleaner. Move the nozzle of the high-pressure cleaner around while cleaning. The water temperature of the high-pressure cleaner must not exceed 60°C.
- Observe the information on the correct distance in the equipment manufacturer's operating instructions.
- Do not direct the nozzle of the high-pressure cleaner directly at sensitive parts, e.g. tyres, gaps, electrical components, batteries, illuminants or louvres.

Washing the vehicle by hand

Observe the relevant legal requirements (e.g. in some countries, washing by hand is permitted only in specially designated wash bays).

- ▶ Use a mild cleaning agent (e.g. car shampoo).

- ▶ Wash the vehicle with lukewarm water using a soft car sponge. When doing so, do not expose the vehicle to direct sunlight.
- ▶ Carefully hose the vehicle off with water and dry using a chamois.
- ⓘ Observe the notes on the care of car parts (→ page 604).

Notes on paintwork/matt finish paintwork care

To avoid damaging the paintwork and interfering with the driving assistance systems, please observe the following notes:

Paint

- Insect remains: soak with insect remover and rinse off the treated areas afterwards.
- Bird droppings: soak with water and rinse off afterwards.
- Tree resin, oils, fuels and greases: remove by rubbing gently with a cloth soaked in petroleum ether or lighter fluid.
- Coolant and brake fluid: remove with a damp cloth and clean water.

- Tar stains: use tar remover.
- Wax: use silicone remover.
- Do not attach stickers, films or similar materials. Only have film attached to the bumper at a qualified specialist workshop.
- Remove dirt immediately, where possible. Do not use acid solutions.

Matt finish

- Only use care products approved for Mercedes-Benz.
- Do not attach stickers, films or similar materials. Only have film attached to the bumper at a qualified specialist workshop.
- Do not polish the vehicle and light-alloy wheels.
- Only use car washes that correspond to the latest engineering standards.
- Do not use car wash programmes with a final hot wax treatment.
- Do not use paint cleaners, buffing or polishing products, gloss preservers, e.g. wax.

In the event of paintwork damage:

- Always have paintwork repairs carried out at a qualified specialist workshop.
- Make sure the radar sensors function (→ page 304).

Notes on cleaning decorative films

Observe the "Notes on paintwork/matt finish paintwork care" (→ page 602). They also apply to matt decorative films.

Observe the notes on cleaning decorative films to avoid damage.

Cleaning

- For cleaning, use plenty of water and a mild cleaning agent without additives or abrasive substances (e.g. a car shampoo approved for Mercedes-Benz).
- Remove dirt as soon as possible. Avoid rubbing too hard in order not to damage the decorative film irreparably.

- If there is dirt on the finish or if the decorative film is dull: use the paint cleaner recommended and approved for Mercedes-Benz.
- Insect remains: soak with insect remover and rinse off the treated areas afterwards.
- Bird droppings: soak with water and rinse off afterwards.
- To prevent water stains, dry a film-wrapped vehicle with a soft, absorbent cloth after every car wash.

Avoiding damage to the decorative film

- The service life and colouring of decorative films are impaired by:
 - Sunlight
 - Temperature (e.g. hot air blower)
 - Weather conditions
 - Stone chippings and dirt
 - Chemical cleaning agents
 - Oily products
- Do not use polish on matt decorative film. Polishing will have the effect of shining the film-wrapped surface.

- Do not treat matt or structured decorative films with wax. Permanent stains may occur.

Scratches, corrosive deposits, areas affected by corrosion and damage caused by incorrect care cannot always be completely repaired. In this case, contact a qualified specialist workshop.

You can obtain more information on care and cleaning agents from the manufacturer.

In the case of film-wrapped surfaces, visual differences may occur between the surfaces that were not protected by a decorative film after a decorative film has been removed.

- ① Have work or repairs to decorative films carried out at a qualified specialist workshop (e.g. at a Mercedes-Benz Service Centre).

Information on cleaning and care of car parts

⚠ WARNING Risk of entrapment if the windscreen wipers are switched on while the windscreen is being cleaned

If the windscreen wipers are set in motion while you are cleaning the windscreen or wiper blades, you can be trapped by the wiper arm.

▶ Always switch off the windscreen wipers and the drive system before cleaning the windscreen or wiper blades.

To avoid damage to the vehicle, observe the notes on cleaning and care of the following car parts:

Wheels and rims

- Use water and acid-free alloy wheel cleaners.
- Do not use acidic alloy wheel cleaners to remove brake dust. This could damage wheel bolts and brake components.
- To avoid corrosion of the brake discs and pads, drive the vehicle for a few minutes after cleaning before parking it. The brake discs and pads will warm up and dry out.

Windows

! NOTE Damage to electronic components due to excess fluids

When cleaning the windows from the inside, fluids such as cleaning agents or water may run down and get behind trim parts of the vehicle interior and cause damage to electronic components.

▶ Use cleaning agents as sparingly as possible.
▶ Immediately absorb any excess fluids.

- Clean the windows inside and outside with a damp cloth and with a cleaning agent recommended for Mercedes-Benz.
- Do not use dry cloths or abrasive or solvent-based cleaning agents to clean the insides of windows.
- ⓘ After changing the wiper blades or treating the vehicle with wax, clean the windscreen thoroughly with cleaning agents recommended for Mercedes-Benz. Failure to observe the

application instructions may result in damage, smear marks or dazzling spots.

- ⓘ Remove external fogging or dirt on the windscreen in front of the multifunction camera. Otherwise, driving systems and driving safety systems may be impaired or not available (→ page 304).

Wiper blades

- The wiper arms will move into the replacement position (→ page 23).
- With the wiper arms folded out, clean the wiper blades with a damp cloth.
- ⓘ Make sure that the wiper blades are coated. The coating may leave residue on a cloth. Do not rub the wiper blades excessively or clean them too often.

Exterior lighting

- Clean the lenses with a wet sponge and mild cleaning agent, such as car shampoo.
- Use only cleaning agents or cleaning cloths that are suitable for plastic lenses.

Vehicle socket (high-voltage battery)

- Use clean water and a soft cloth to clean the vehicle socket.
- Do not use high-pressure cleaners or cleaning agents, such as soap.

Sensors

- Clean the sensors in the front and rear part of the vehicles with car shampoo, plenty of water and a soft cloth (→ page 304).
- When using a high-pressure cleaner, maintain a minimum distance of 30 cm.

Cameras

- Open the camera cover with the multimedia system (→ page 371).
 - Use clean water and a soft cloth to clean the camera lenses.
 - Do not use a high-pressure cleaner.
- i** Remove external fogging or dirt on the windscreen in front of the multifunction camera. Otherwise, driving systems and driving safety systems may be impaired or not available (→ page 304).

Trailer hitch

- Observe the notes on care in the trailer hitch manufacturer's owner's manual.
 - Do not clean the ball neck with a high-pressure cleaner or solvent.
 - Remove traces of rust on the ball, e.g. with a wire brush.
 - Remove dirt with a lint-free cloth.
 - After cleaning, lightly oil or grease the ball head.
- i** Before using trailers with anti-swerve coupling, note the manufacturer's Owner's Manual.

Notes on care of the interior

- !** **WARNING** Risk of injury from plastic parts breaking off after the use of solvent-based care products

Care and cleaning products containing solvents can cause surfaces in the cockpit to become porous. When the airbags are deployed, plastic parts may break away.

- ▶** Do not use any care or cleaning products containing solvents to clean the cockpit.

- !** **WARNING** Risk of injury or fatal injuries from bleached seat belts

Bleaching or dyeing seat belts can severely weaken them.

This can, for example, cause seat belts to tear or fail in an accident.

- ▶** Never bleach or dye seat belts.

- !** **NOTE** Property damage due to disinfectants

The interior includes a number of sensitive surfaces such as displays, plastics and leather.

Disinfectants can contain alcohol and other substances that penetrate and damage surfaces. Technology behind buttons and displays can also be damaged.

- ▶** Do not use disinfectant on interior surfaces.

To avoid damage to the vehicle, observe the following notes on cleaning and care:

Seat belts

- Clean with lukewarm soapy water.
- Do not use chemical cleaning agents.
- Do not dry by heating them to over 80°C or exposing them to direct sunlight.

Display

- Switch off the display and let it cool down.
- Clean the surface carefully with a microfibre cloth and a suitable display care product (TFT-LCD).
- Do not use any other agents.

Head-up display

- Clean with a soft, non-static, lint-free cloth.
- Do not use cleaning agents.

Plastic trim

- Clean with a damp microfibre cloth.
- For heavy soiling: use a cleaning agent recommended for Mercedes-Benz.

- Do not attach stickers, films or similar materials.
- Do not allow cosmetics, insect repellent or sun cream to come into contact with the plastic trim.

Real wood and trim elements

- Clean with a microfibre cloth.
- Black piano-lacquer look: clean with a damp cloth and soapy water.
- For heavy soiling: use a cleaning agent recommended for Mercedes-Benz.
- Do not use solvent-based cleaning agents, polishes or waxes.

Roof lining

- Clean with a brush or dry shampoo.

Carpet

- Use a carpet and textile cleaning agent recommended for Mercedes-Benz.

Imitation leather steering wheel

- Clean the entire steering wheel with a damp cotton cloth and a 1% soapy water solution. Do not spot clean.

- Use cleaning and care products recommended for Mercedes-Benz.
- Do not use a microfibre cloth.
- Do not use oil-based cleaning and care products.

Steering wheel made of genuine leather or DINAMICA

! NOTE Damage caused by wrong cleaners

▶ Do not use solvent-based cleaning agents such as tar remover or wheel cleaner; neither should you use polishes or waxes. Otherwise you may damage the finish.

- Clean with a damp cloth and a 1% soap solution and then wipe with a dry cloth.
- For heavy soiling: use a cleaning agent recommended for Mercedes-Benz.
- Leather care: use a leather care agent that has been recommended for Mercedes-Benz.
- Do not allow the leather to become too damp.
- Do not use a microfibre cloth.

- i** Leather is a natural product. It exhibits natural surface properties such as differences in structure, marks caused by growth and injury or subtle colour differences. These surface properties are characteristics of leather and not material faults. Leather is also subject to a natural ageing process during which the surface properties change.

Genuine leather seat covers

- Vacuum up dirt such as crumbs or dust and then clean the seat covers with a damp cotton cloth and wipe down with a dry cloth. Regularly clean the seat covers.
- For heavy soiling: use a leather care agent recommended for Mercedes-Benz aftercare.
- Leather care: use a leather care agent that has been recommended for Mercedes-Benz.
- Do not use a microfibre cloth.
- Do not allow the leather to become too damp.
- Do not use oil-based cleaning and care products.

- i** Leather is a natural product. It exhibits natural surface properties such as differences in

structure, marks caused by growth and injury or subtle colour differences. These surface properties are characteristics of leather and not material faults. Leather is also subject to a natural ageing process during which the surface properties change.

Waves or wrinkling in the seat cover may occur due to the stress on the seat; this is caused by the natural leather material.

Regular cleaning and care of the leather reduces soiling, wear marks and ageing damage and thus significantly extends its life span. Clothing that can leave stains (e.g. jeans) may discolour the leather.

DINAMICA seat covers

- Vacuum up dirt such as crumbs or dust and then use a damp cloth to clean.
- Do not use a microfibre cloth.

Imitation leather seat covers

- Vacuum up dirt such as crumbs or dust and then use a damp cotton cloth and a 1% soap solution to clean the entire seat cover. Do not spot clean.

- Use cleaning and care products recommended for Mercedes-Benz.
- Do not use a microfibre cloth.
- Do not use oil-based cleaning and care products.

Fabric seat covers

- Vacuum up dirt such as crumbs or dust and then use a damp microfibre cloth and a 1% soap solution to clean the entire seat cover. Do not spot clean.
- Use cleaning and care products recommended for Mercedes-Benz.
- Do not use oil-based cleaning and care products.

Emergency

Removing the safety vest

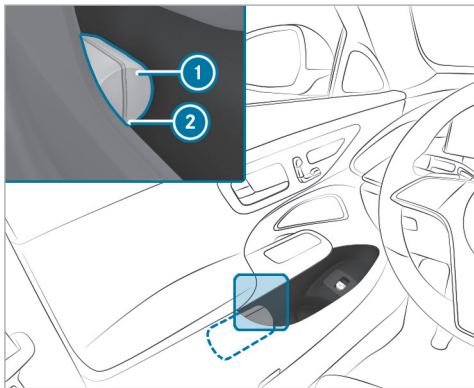

There is a high-visibility waistcoat compartment on the door shelves of all doors for storing a high-visibility waistcoat.

- ▶ To remove: pull out safety vest bag ① by loop ②.

- ▶ Open the safety vest bag ① and pull out the safety vest.
- ▶ Replace: Fold up the safety vest, roll it up and place it in the safety vest ①.
- ▶ Slide the safety vest bag ① along the lower edge of the armrest into the safety vest compartment. Ensure that the loop ② hangs out so that it is easy to reach.

- ⓘ Remove the packaging film before sliding it into the safety vest compartment for a new safety vest. Otherwise, it may cause unintentional slipping or make removing difficult. Observe the legal requirements in the individual countries.

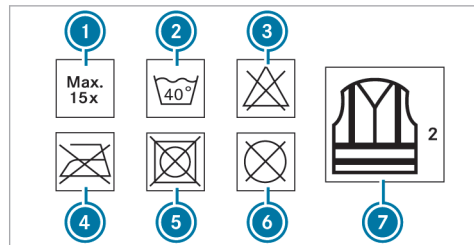

- ① Maximum number of washes
- ② Maximum wash temperature
- ③ Do not bleach
- ④ Do not iron
- ⑤ Do not tumble dry
- ⑥ Do not dry clean
- ⑦ Class 2 safety vest

The requirements defined by the legal standard are only fulfilled if the safety vest is the correct size and is fully closed.

Replace the safety vest in the following cases:

- The reflective strips are damaged or dirty

- The maximum permissible number of washes is exceeded
- The fluorescence property decreases, e.g. due to permanent exposure to sunlight.

Dispose of the safety vest in an environmentally friendly way:

- Please contact your local waste disposal company.

Warning triangle

Removing the warning triangle

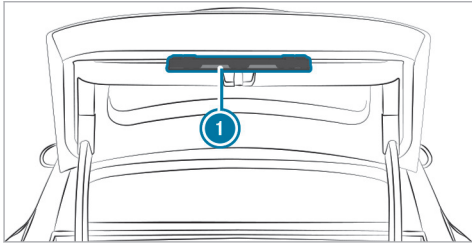

- ▶ Remove the warning triangle ①.

Setting up the warning triangle

- ▶ Fold the side reflectors upwards to form a triangle and attach at the top using the upper press-stud.
- ▶ Fold the legs down and out to the side.

First-aid bag

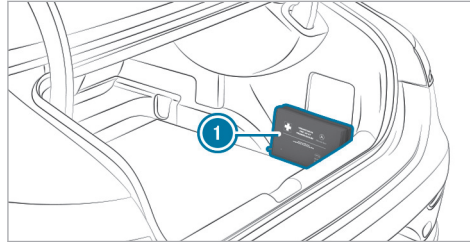

The first-aid bag ① is located on the right-hand side of the boot in the as-delivered condition.

Removing the fire extinguisher

⚠ WARNING Risk of accident due to an incorrectly secured fire extinguisher in the driver's footwell

A fire extinguisher may impede pedal travel or block a depressed pedal.

This jeopardises the operating and road safety of the vehicle.

The fire extinguisher can be flung around and injure the driver or other vehicle occupants.

- ▶ Always store and secure the fire extinguisher in the bracket.
- ▶ Do not remove the fire extinguisher while driving.

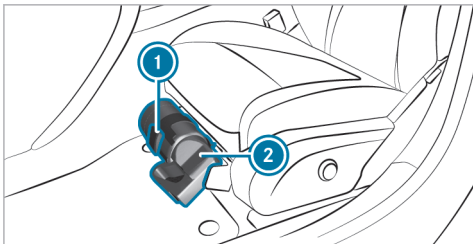

- ▶ **Left-hand drive vehicle:** pull tab ① upwards.
- ▶ **Right-hand drive vehicle:** pull tab ① downwards.
- ▶ Remove fire extinguisher ②.

Flat tyre

Notes on flat tyres

⚠ WARNING Risk of accident due to a flat tyre

A flat tyre severely affects the driving characteristics as well as the steering and braking of the vehicle.

Tyres without run-flat characteristics:

- ▶ Do not drive with a flat tyre.
- ▶ Change the flat tyre immediately with an emergency spare wheel or spare wheel. Alternatively, consult a qualified specialist workshop.

Tyres with run-flat characteristics:

- ▶ Observe the information and warning notes on MOExtended tyres (run-flat tyres).

In the event of a flat tyre, the following options are available depending on your vehicle's equipment:

- **Vehicles with MOExtended tyres:** it is possible to continue the journey for a short period of time. Make sure you observe the notes on MOExtended tyres (run-flat tyres) (→ page 610).
- **Vehicles with a TIREFIT kit:** you can seal the tyre so that it is possible to continue the journey for a short period of time. To do this, use the TIREFIT kit (→ page 612).

- **Vehicles with Mercedes me connect:** you can make a call for breakdown assistance via the overhead control panel in the case of a breakdown (→ page 544).
 - **All vehicles:** change the wheel (→ page 636).
- ⓘ (→ page 642) The emergency spare wheel is only available in certain countries.

Notes on MOExtended tyres (run-flat tyres)

⚠ WARNING Risk of accident when driving in limp-home mode

Driving in emergency mode impairs the handling characteristics of the vehicle.

- ▶ Do not exceed the permissible maximum speed of the MOExtended tyres.
- ▶ Avoid any abrupt steering and driving manoeuvres as well as driving over obstacles (kerbs, pot holes, off-road). This applies, in particular, to a loaded vehicle.

- ▶ Stop driving in the emergency mode if you notice:
 - banging noise
 - vehicle vibration
 - smoke which smells like rubber
 - continuous ESP® intervention
 - cracks in the tyre sidewalls
- ▶ After driving in emergency mode, have the rims checked by a qualified specialist workshop with regard to their further use.
- ▶ The defective tyre must be replaced in every case.

With MOExtended tyres (run-flat tyres), you can continue to drive your vehicle even if there is a total loss of pressure in one or more tyres. However, the tyre affected must not show any clearly visible damage.

You can recognise MOExtended tyres by the MOExtended marking which appears on the side wall of the tyre.

Vehicles with tyre pressure monitoring system:
MOExtended tyres may only be used in conjunction with an activated tyre pressure monitoring system.

If a pressure loss warning message appears in the driver's display, proceed as follows:

- Check the tyre for damage.
- If driving on, observe the following notes.

Driving distance possible in emergency mode after the pressure loss warning:

Load condition	Driving distance possible in emergency mode
Partially laden	80 km
Fully laden	30 km

The driving distance possible in emergency mode may vary depending on the driving style. Observe the maximum permissible speed of 80 km/h.

If a tyre has gone flat and cannot be replaced with an MOExtended tyre, you can use a standard tyre as a temporary measure.

TIREFIT kit storage location

The TIREFIT kit is located under the boot floor.

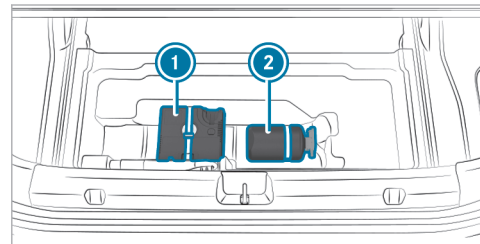

- ① Tyre inflation compressor
- ② Tyre sealant bottle

Depending on the model, the TIREFIT kit may also be located in other places under the boot floor.

- ⓘ You can find information on the power category (LK) and/or electrical data on the back of the tyre inflation compressor:
 - LK3 – 12 V/20 A, 240 W, 1 kg

At a distance of approximately 1 m to the tyre inflation compressor and approximately 1.6 m above the ground, the following sound pressure levels apply:

- Emission sound pressure level L_{PA} 84 dB(A)
- Sound power level L_{WA} 92 dB(A)

The tyre inflation compressor is maintenance-free. If there is a malfunction, please contact a qualified specialist workshop.

Using the TIREFIT kit

Requirements:

- Tyre sealant bottle and tyre inflator compressor are ready for use (→ page 50).
- TIREFIT sticker is present.
- Gloves are present.

You can use TIREFIT tyre sealant to seal perforation damage of up to 4 mm, particularly those in the tyre contact surface. You can use TIREFIT in outside temperatures down to -20 °C.

⚠ WARNING Risk of accident when using tyre sealant

The tyre sealant may be unable to seal the tyre properly, especially in the following cases:

- there are large cuts or punctures in the tyre (larger than damage previously mentioned)
 - the wheel rims have been damaged
 - after journeys with very low tyre pressure or with flat tyres
- ▶ Do not continue driving.
 - ▶ Consult a qualified specialist workshop.

⚠ WARNING Risk of injury and poisoning from tyre sealant

Tyre sealant is hazardous to health and causes irritation. Do not allow it to come into contact with your skin, eyes or clothing, and do not swallow it. Do not inhale any vapours. Keep the tyre sealant away from children.

Observe the following if you come into contact with the tyre sealant:

- ▶ Rinse off the tyre sealant from your skin using water immediately.
- ▶ If tyre sealant gets into your eyes, thoroughly rinse them using clean water immediately.
- ▶ If tyre sealant has been swallowed, thoroughly rinse out your mouth immediately and drink plenty of water. Do not induce vomiting and seek medical attention immediately.
- ▶ Change out of clothing which has come into contact with tyre sealant immediately.
- ▶ If an allergic reaction occurs, seek medical attention immediately.

! **NOTE** Overheating due to the tyre inflation compressor running too long

- ▶ Do not run the tyre inflation compressor for longer than ten minutes without interruption.

Comply with the manufacturer's safety notes on the sticker on the tyre inflation compressor.

Have the tyre sealant bottle replaced in a qualified specialist workshop every five years.

- ▶ Do not remove any foreign objects which have entered the tyre.

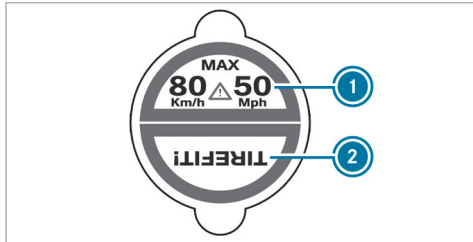

- ▶ Affix part ① of the TIREFIT sticker to the instrument cluster within the driver's field of vision.
- ▶ Affix part ② of the TIREFIT sticker near the valve on the wheel with the defective tyre.

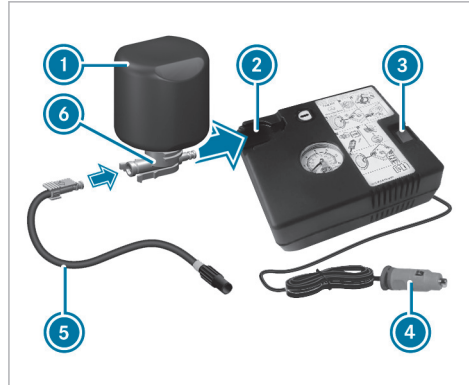

- ▶ Pull plug ④ with the cable and hose ⑤ out of the tyre inflation compressor housing.
- ▶ Push the plug of hose ⑤ into flange ⑥ of tyre sealant bottle ① until the plug engages.
- ▶ Place tyre sealant bottle ① head downwards into recess ② of the tyre inflation compressor.



- ▶ Remove the valve cap from valve ⑦ on the faulty tyre.
- ▶ Screw filling hose ⑧ onto valve ⑦.

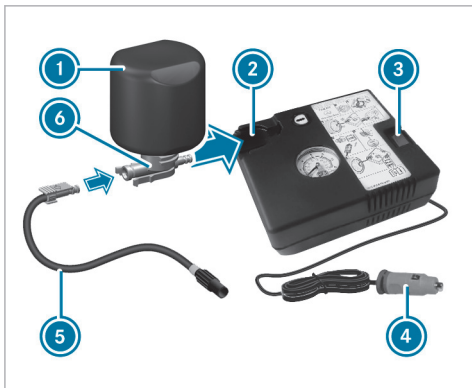

- ▶ Insert plug ④ into a 12-V-socket in your vehicle.
- ▶ Switch on the vehicle.
- ▶ Switch on the tyre inflation compressor using On/Off switch ③. The tyre is inflated. First, tyre sealant is pumped into the tyre. The pressure may briefly rise to approximately 500 kPa (5.0 bar/73 psi).

Do not switch off the tyre inflation compressor during this phase!

- ▶ Let the tyre inflation compressor run for a maximum of ten minutes. The tyre should then have attained a tyre pressure of at least 200 kPa (2.0 bar/29 psi).

If tyre sealant leaks out, make sure you clean the affected area as quickly as possible. It is preferable to use clean water.

If you get tyre sealant on your clothing, have it cleaned as soon as possible with perchloroethylene.

If, after ten minutes, a tyre pressure of 200 kPa (2.0 bar/29 psi) has not been attained:

- ▶ Switch off the tyre inflation compressor.
- ▶ Unscrew the filling hose from the valve of the defective tyre.

Please note that tyre sealant may leak out when unscrewing the filling hose.

- ▶ Drive forwards or in reverse very slowly for approximately 10 m.

- ▶ Pump up the tyre again. After a maximum of ten minutes the tyre pressure must be at least 200 kPa (2.0 bar/29 psi).

⚠ WARNING Risk of accident due to the specified tyre pressure not being attained

If the specified tyre pressure is not attained after the specified time, the tyre is too badly damaged. The tyre sealant cannot repair the tyre in this instance.

The braking and driving characteristics may be greatly impaired.

- ▶ Do not continue driving.
- ▶ Consult a qualified specialist workshop.

If, after ten minutes, a tyre pressure of 200 kPa (2.0 bar/29 psi) has been attained:

- ▶ Switch off the tyre inflation compressor.
- ▶ Unscrew the filling hose from the valve of the defective tyre.

⚠ WARNING Risk of accident from driving with sealed tyres

A tyre temporarily sealed with tyre sealant impairs the handling characteristics and is not suitable for higher speeds.

- ▶ Adapt your driving style accordingly and drive carefully.
- ▶ Do not exceed the maximum speed limit with a tyre that has been repaired using tyre sealant.

- ▶ Observe the maximum permissible speed of 80 km/h for a tyre sealed with tyre sealant.

! NOTE Staining from leaking tyre sealant

After use, excess tyre sealant may leak out from the filling hose.

- ▶ Therefore, place the filling hose in the plastic bag that contained the TIREFIT kit.

🌿 ENVIRONMENTAL NOTE Environmental pollution caused by environmentally irresponsible disposal

Tyre sealant contains pollutants.

- ▶ Have the tyre sealant bottle disposed of professionally, e.g. at a Mercedes-Benz Service Centre.
- ▶ Stow the tyre sealant bottle and the tyre inflation compressor.
- ▶ Pull away immediately.
- ▶ Stop driving after approximately ten minutes and check the tyre pressure using the tyre inflation compressor. The tyre pressure must now be at least 130 kPa (1.3 bar/19 psi).

⚠ WARNING Risk of accident due to the specified tyre pressure not being attained

If the specified tyre pressure is not reached, the tyre is too badly damaged. The tyre sealant cannot repair the tyre in this instance.

The braking and driving characteristics may be greatly impaired.

- ▶ Do not continue driving.
- ▶ Consult a qualified specialist workshop.

Countries that have Mercedes-Benz Service24h:

you will find a sticker with the telephone number, e.g. on the B-pillar on the driver's side.

- ▶ Correct the tyre pressure if it is still at least 130 kPa (1.3 bar/19 psi). For values, see the tyre pressure table on the driver's side B-pillar.
- ▶ **To increase the tyre pressure:** switch on the tyre inflation compressor.

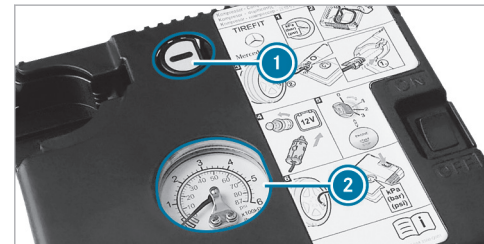

- ▶ **To reduce the tyre pressure:** press pressure release button ① next to manometer ②.
- ▶ When the tyre pressure is correct, unscrew the filling hose from the valve of the sealed tyre.
- ▶ Screw the valve cap onto the valve of the sealed tyre.
- ▶ Pull the tyre sealant bottle out of the tyre inflation compressor.
The filling hose stays on the tyre sealant bottle.
- ▶ Drive to the nearest qualified specialist workshop and have the tyre, tyre sealant bottle and filling hose replaced there.

Battery (vehicle)

Notes on the 12 V battery

⚠ WARNING Risk of explosion due to electrostatic charge

Electrostatic charge can ignite the highly explosive gas mixture in the battery.

- ▶ To discharge any electrostatic charge that may have built up, touch the metal vehicle body before handling the battery.

The highly flammable gas mixture is created while the battery is charging and during starting assistance.

For safety reasons, Mercedes-Benz recommends that you only use batteries which have been tested and approved for your vehicle by Mercedes-Benz.

⚠ WARNING Danger of chemical burns from the battery acid

Battery acid is caustic.

- ▶ Avoid contact with the skin, eyes or clothing.
- ▶ Do not lean over the battery.
- ▶ Do not inhale battery gases.
- ▶ Keep children away from the battery.
- ▶ Immediately rinse battery acid off thoroughly with plenty of clean water and seek medical attention immediately.

🌿 ENVIRONMENTAL NOTE Environmental damage due to improper disposal of batteries



Batteries contain pollutants. It is illegal to dispose of them with the household rubbish.



Dispose of batteries in an environmentally responsible manner. Take discharged batteries to a qualified specialist workshop or to a collection point for used batteries.

If you have to disconnect the 12 V battery, contact a qualified specialist workshop.

Comply with safety notes and take protective measures when handling batteries.



Risk of explosion.



Fire, naked flames and smoking are prohibited when handling the battery. Avoid creating sparks.



Electrolyte or battery acid is corrosive. Avoid contact with the skin, eyes or clothing. Wear suitable protective clothing, in particular gloves, an apron and a face mask. Immediately rinse electrolyte or acid splashes off with clean water. Consult a doctor immediately.



Wear safety glasses.



Keep children away.



Observe this Owner's Manual.

If you do not want to use the vehicle for a long period of time, consult a qualified specialist workshop.

Notes on the high-voltage battery

⚠ DANGER Risk of fire and explosion from excessive internal pressure of the high-voltage battery

In the event of a vehicle fire, flammable gas can escape and ignite.

- ▶ Stop the charging process immediately in case of unusual odours, smoke or burn marks.
- ▶ Leave the danger zone immediately. Secure the danger zone at a sufficient distance.
- ▶ Call the fire service.

Observe the notes on charging the high-voltage battery (→ page 276).



Risk of explosion.



Fire, naked flames and smoking are prohibited when handling the battery. Avoid creating sparks.



Electrolyte or battery acid is corrosive. Avoid contact with the skin, eyes or clothing. Wear suitable protective clothing, in particular gloves, an apron and a face mask. Immediately rinse electrolyte or acid splashes off with clean water. Consult a doctor immediately.



Wear safety glasses.



Keep children away.



Observe this Owner's Manual.

Starting assistance and charging the 12 V battery

- ▶ Only have starting assistance provided by a qualified specialist workshop, e.g. a Mercedes-Benz Service Centre.
- ▶ Only have the battery charged at a qualified specialist workshop, e.g. a Mercedes-Benz Service Centre.

Replacing the 12 V battery

- ▶ Only have the battery replaced at a qualified specialist workshop, e.g. at a Mercedes-Benz Service Centre.

Tow-starting or towing away

Overview of the permitted towing methods

! NOTE Damage from automatic braking

If one of the following functions is activated, the vehicle will brake automatically in certain situations:

- Active Brake Assist
- Active Distance Assist DISTRONIC
- HOLD function
- Active Parking Assist

To avoid damaging the vehicle, deactivate these systems e.g. during towing or in the car wash.

Mercedes-Benz recommends transporting your vehicle in the case of a breakdown, rather than towing it away.

For towing with both axles on the ground, use a tow rope or tow rod. Do not use tow bar systems.

If you notice that the vehicle has lost coolant, do not have it towed away. Have the vehicle transported instead.

! NOTE Damage to the vehicle due to towing away incorrectly

- ▶ Observe the instructions and notes on towing away.

Vehicles with rear wheel drive

Permitted towing methods

Both axles on the ground	Yes, for a maximum of 50 km at 50 km/h, only forwards with the driver in the cockpit
Front axle raised	No
Rear axle raised	Yes, for a maximum of 50 km at 50 km/h

4MATIC vehicles

Permitted towing methods

Both axles on the ground	Yes, for a maximum of 50 km at 50 km/h, only forwards with the driver in the cockpit
Front axle raised	No
Rear axle raised	No

Towing the vehicle with both axles on the ground



- ▶ Observe the notes on the permitted towing methods (→ page 618).
- ▶ Make sure that the 12V battery is connected and charged

Observe the following points when the 12V battery is disconnected or discharged

- the drive system cannot be started
- the electric parking brake cannot be released or applied
- The selector lever cannot be put into position **N** or **P**.

Only one transport is permitted when at least one of the following conditions occur:

- If the selector lever cannot be put into position **N**.
- if the 12V battery is disconnected or discharged.
- if the display in the instrument cluster is not working

- if the  **Towing not permitted See Owner's Manual** message is displayed
- if the  **Top up coolant See Owner's Manual** message is displayed
- if the  **Stop Switch off the vehicle** message is displayed

- ▶ In such cases, transport the vehicle (→ page 621).

! **NOTE** Damage due to towing away at excessively high speeds or over long distances

The drivetrain could be damaged when towing at excessively high speeds or over long distances.

- ▶ A towing speed of 50 km/h must not be exceeded.
- ▶ A towing distance of 50 km must not be exceeded.

! **WARNING** Risk of accident when towing a vehicle which is too heavy

If the vehicle to be tow-started or towed away is heavier than the permissible gross mass of your vehicle, the following situations can occur:

- the towing eye may become detached.
- the vehicle/trailer combination may swerve or overturn.

- ▶ Before tow-starting or towing away, check if the vehicle to be tow-started or towed away exceeds the permissible gross mass.

If a vehicle has to be tow-started or towed away, its permissible gross mass must not exceed the permissible gross mass of the towing vehicle.

- ▶ Information on the permissible gross mass of the vehicle can be found on the vehicle identification plate (→ page 757).

Towing away the vehicle

- ▶ Fit the towing eye (→ page 623).

- ▶ Fasten the towing device.

! **NOTE** Damage due to incorrect connection of the tow bar

- ▶ Only connect the tow rope or tow bar to the towing eyes.

- ▶ Deactivate the automatic locking mechanism (→ page 147).
- ▶ Do not activate the HOLD function.
- ▶ Deactivate tow-away protection (→ page 169).
- ▶ Deactivate Active Brake Assist (→ page 341).
- ▶ Put the selector lever into position **N**.
- ▶ Release the electric parking brake.
- ▶ Remain in the cockpit during towing and observe the display messages.
- ▶ Do not switch off the vehicle while it is being towed. Do not operate the start/stop key after moving the shift lever to position **N**.
- ▶ Do not open the driver's door or front passenger door, because otherwise the selec-

tor lever automatically switches to position **P**.

! **WARNING** Risk of accident due to restricted safety-relevant functions during towing

Safety-relevant functions are restricted or no longer available in the following situations:

- The vehicle is switched off.
- The start-stop button was pressed after the selector lever was moved to the **N** position.
- The brake system or the power steering is faulty.
- The power supply or the on-board electrical system is faulty.

- ▶ Do not tow the vehicle in these situations.

- ▶ Transport the vehicle (→ page 621).

! **NOTE** Damage to the drive system due to incorrect towing

The vehicle must not be towed in the following situations:

- The vehicle is switched off.
- The start-stop button was pressed after the selector lever was moved to the **N** position.
- The brake system or the power steering is faulty.
- The power supply or the on-board electrical system is faulty.

- ▶ Do not tow the vehicle in these situations.

! **NOTE** Damage due to excessive tractive power

If you pull away sharply, the tractive power may be too high and the vehicles could be damaged.

- ▶ Pull away slowly and smoothly.

Loading the vehicle for transport

Requirements

- The vehicle is stationary.
 - The vehicle is switched off.
 - The driver's display is in the initial state with no menus open (→ page 403). Transport is also possible with a warning message visible.
 - The 12 V battery is charged.
- ▶ If necessary, set the system language (→ page 462).
 - ▶ Observe the notes on towing away (→ page 50).
 - ▶ Connect the towing device to the towing eye in order to load the vehicle.
- ❗ **Vehicles with a trailer hitch:** you can also attach the tow bar to the trailer hitch.
 - ▶ Switch on the power supply (→ page 252).
 - ▶ Shift the transmission to position **N**.
 - ❗ The transmission may be locked in position **P** in the event of damage to the electrics. To

shift to **N**, provide the on-board electrical system with power (→ page 48).

Vehicles with AIRMATIC

❗ **NOTE** Possible damage to the vehicle when loading or unloading

When loading or unloading, the vehicle must be raised to transport level.

If the transport settings are not shown or the **Vehicle not ready for loading** message is displayed, the vehicle may not be loaded or unloaded.

- ▶ If required, raise the vehicle to transport level again.
- ▶ A vehicle that cannot be raised to transport level may not be loaded or unloaded using a ramp. Consult a qualified specialist workshop.



⚠ **WARNING** Risk of accident due to activated transport level





If the vehicle is raised to transport level, driving and driving safety systems have only limited availability and the view from the vehicle is restricted.

Driving safety is severely restricted and there is a risk of an accident!

- ▶ Do not use transport level in normal road operation.
- ▶ Only activate and use transport level to load the vehicle and when not on public roads.

- ▶ Ensure that no persons or obstacles are located in the area surrounding the vehicle.

Raising the vehicle to transport level Vehicles with AIRMATIC

- ▶ Press the  button for at least five seconds.
 - ▶ Immediately press and hold the  button for at least one second. The **For transport level, switch vehicle on** message is displayed.
 - ▶ Select **Vehicle transport**.
-  The noise certification mode is intended exclusively for the technical test organisation. It restricts the drive power of the vehicle and must not be used in customer operation.
- ▶ Switch on the vehicle (→ page 253). The transport settings are displayed.
 - ▶ Swipe downward to select **Transport level** and press . The vehicle is raised and the **Vehicle rising... Do not drive on ramp** message is displayed

for 5 seconds. The raising process can take up to 60 seconds and can be cancelled with the  button.

- ▶ When raising, do not switch off the vehicle.

While the vehicle is being raised, you can manoeuvre at a maximum speed of 40 km/h.



- ▶ Before loading the vehicle, wait until the transport level has been reached and the **Transport level** status is shown.
-  If the vehicle is raised to transport level, the transport settings will continue to be shown even after a restart. Operation of the driver's display is restricted.

When the vehicle is at transport level, it is lowered again in the following situations:

- When driving faster than 40 km/h.
- The 12 V battery is discharged.

The vehicle is adjusted to the height of the last active level.

Transporting the vehicle

- ▶ Load the vehicle onto the transporter.
- ▶ Shift the transmission to position .
- ▶ Use the electric parking brake to secure the vehicle against rolling away.
- ▶ Switch off the vehicle and the power supply.
- ▶ Only secure the vehicle by the wheels.

4MATIC vehicles

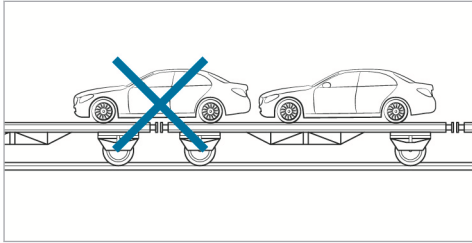

- ▶ Make sure that the front and rear axles come to rest on the same transportation vehicle.

! **NOTE** Damage to the drive train due to incorrect positioning of the vehicle

- ▶ Do not position the vehicle above the connection point of the transport vehicle.

Unloading the vehicle Vehicles with AIRMATIC

- ▶ Make sure that the vehicle is raised to transport level before unloading (→ page 358).

Lowering the vehicle after unloading

- ▶ Switch on the power supply.
- ▶ Switch on the vehicle.
- ▶ In Transport Settings, swipe up to select the **Standard level** and press **OK**.
The vehicle is adjusted to the height of the last active level and the **Lowering vehicle** message is displayed.
- ▶ After the vehicle has been lowered, press the **↶** button for at least two seconds. Transport Settings closes.

Towing eye storage location

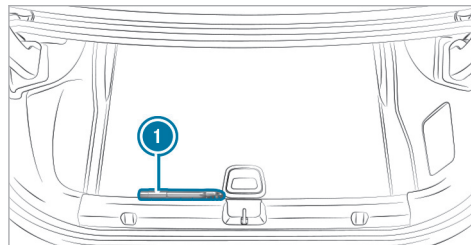

Towing eye **1** is located under the boot floor.

Fitting and removing the towing eye

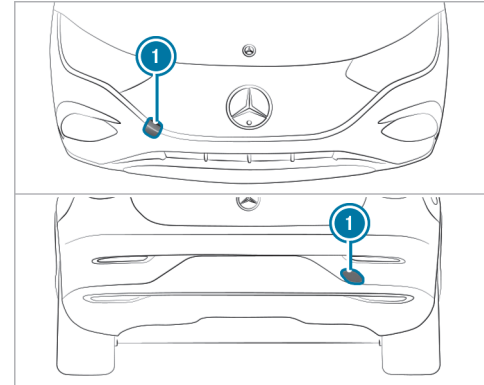

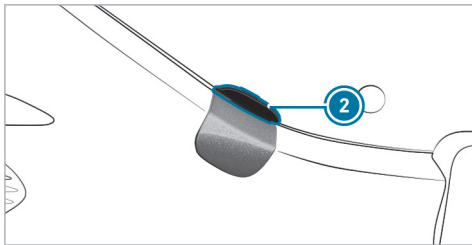

- ▶ Press cover ① at the top ② inwards and remove.
- ▶ Screw in the towing eye clockwise as far as it will go and tighten.

Vehicles with a trailer hitch: vehicles with a trailer hitch do not have a rear bracket for the towing eye. Fasten the tow bar to the trailer hitch.

- ▶ After removing the towing eye, engage the cover ① in the bumper.

! **NOTE** Damage to the vehicle due to incorrect use of the towing eye or trailer hitch

When a towing eye or trailer hitch is used to recover a vehicle, the vehicle may be damaged in the process.

- ▶ Only use the towing eye or trailer hitch to tow away or tow start the vehicle.
- ▶ Do not use the towing eye or trailer hitch to tow the vehicle during recovery.

Tow-starting the vehicle

- ▶ If the drive system does not start, have the vehicle transported to a qualified specialist workshop, e.g. a Mercedes-Benz Service Centre.
- ▶ The drive system cannot be started by tow-starting the vehicle. Do not make any attempts to tow-start the vehicle.

Electrical fuses

Notes on electrical fuses

! **WARNING** Risk of accident and injury due to overloaded lines

If you manipulate or bridge a faulty fuse or if you replace it with a fuse with a higher amperage, the electric line could be overloaded.

This could result in a fire.

- ▶ Always replace faulty fuses with specified new fuses containing the correct amperage.

! **NOTE** Damage due to incorrect fuses

Using incorrect fuses can result in damage to electrical components or systems or their functions being considerably restricted.

- ▶ Use only fuses approved for Mercedes-Benz with the respective specified fuse rating.

Blown fuses must be replaced with fuses of the same rating, which you can recognise by the col-

our and the label. The fuse ratings and further information to be observed can be found in the fuse assignment diagram.

Fuse assignment diagram: on the fuse box in the rear passenger compartment (→ page 626).

! **NOTE** Damage or malfunctions caused by moisture

Moisture may cause damage to the electrical system or cause it to malfunction.

- ▶ When the fuse box is open, make sure that no moisture can enter the fuse box.
- ▶ When closing the fuse box, make sure that the seal of the lid is positioned correctly on the fuse box.

If the newly inserted fuse also blows, have the cause traced and rectified at a qualified specialist workshop.

Ensure the following before replacing a fuse:

- The vehicle is secured against rolling away.
- All electrical consumers are switched off.
- The vehicle is switched off.

The electrical fuses are located in various fuse boxes:

- Fuse box on the driver's side of the cockpit (→ page 625)
- Fuse box in the front passenger footwell (→ page 625)
- Fuse box in the rear passenger compartment (→ page 626)

Opening and closing the fuse box in the cockpit

- Observe the notes on electrical fuses (→ page 48).

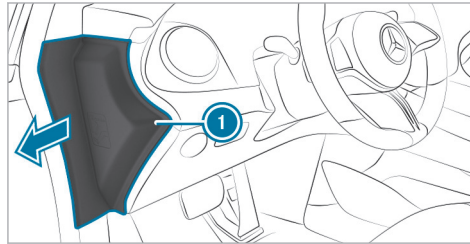

The fuse box is on the driver's side on the side of the cockpit under a cover.

- ▶ Open cover ① in the direction of the arrow and remove it.

Mercedes-Benz recommends you have the fuse box opened at a Mercedes-Benz Service Centre.

Opening and closing the fuse box in the front passenger footwell

Requirements

- Observe the notes on electrical fuses (→ page 48).

Right-hand drive vehicles: the fuse box is on the left side.

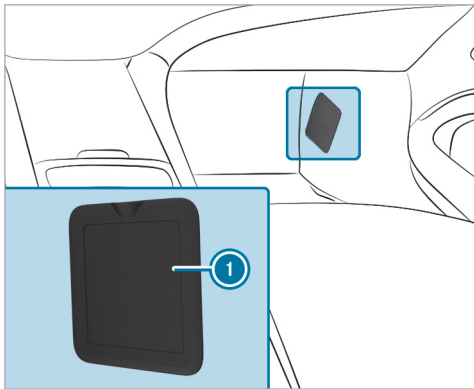

The fuse box is located in the centre of the vehicle under the seat.

- ▶ To open and close it, consult a Mercedes-Benz Service Centre.

▶ To open the fuse box: remove cover ①.

▶ To close the fuse box: reinsert cover ①.

Opening and closing the fuse box in the rear

Requirements:

- Observe the notes on electrical fuses (→ page 48).

Notes on noise or unusual handling characteristics

Make sure there are no vibrations, noises or unusual handling characteristics when the vehicle is in motion. This may indicate that the wheels or tyres are damaged. Hidden tyre damage could also be causing the unusual handling characteristics.

If you suspect that a tyre is defective, reduce your speed immediately and have the tyres and wheels checked at a qualified specialist workshop.

Notes on regularly inspecting wheels and tyres

⚠ WARNING Risk of injury due to damaged tyres

Damaged tyres can cause tyre pressure loss.

- ▶ Check the tyres regularly for signs of damage and replace any damaged tyres immediately.

⚠ WARNING Risk of aquaplaning due to insufficient tyre tread

Insufficient tyre tread will result in reduced tyre grip.

The risk of aquaplaning is increased on wet roads, especially when the speed of the vehicle is not adapted to suit the conditions.

- ▶ Thus, you should regularly check the tread depth and the condition of the tread across the entire width of all tyres.

Minimum tread depth for:

- Summer tyres: 3 mm
- M+S tyres: 4 mm

- ▶ For safety reasons, replace the tyres before the legally-prescribed limit for the minimum tread depth is reached.

Carry out the following checks on all wheels regularly, at least once a month or as required, for example, prior to a long journey or driving off-road:

- Check the tyre pressure (→ page 628).

- Visually inspect wheels and tyres for damage.
- Check the valve caps.
- Visual check of the tyre tread depth and the tyre contact surface across the entire width.
The minimum tread depth for summer tyres is 3 mm and for winter tyres 4 mm.

Notes on snow chains

⚠ WARNING Risk of accident due to incorrectly fitted snow chains

If you have fitted snow chains to the front wheels, they may drag against the vehicle body or chassis components.

- ▶ Never fit snow chains to the front wheels.
- ▶ Only fit snow chains on the rear wheels in pairs.

! **NOTE** Damage to components of the vehicle body or chassis due to fitted snow chains

If you fit snow chains to the front wheels of 4MATIC vehicles, you may damage components of the vehicle body or chassis.

▶ Only fit snow chains to the rear wheels of 4MATIC vehicles.

! **NOTE** Damage to wheel trims through fitted snow chains

If you fit snow chains on aluminium wheels you could damage the wheel trims.

▶ Remove the wheel trims from the aluminium wheels before fitting snow chains.

Observe the following notes when using snow chains:

- Snow chains are only permissible for certain wheel/tyre combinations. You can obtain information about this from a Mercedes-Benz Service Centre.

- For safety reasons, only use snow chains that have been specifically approved for your vehicle by Mercedes-Benz, or snow chains with the same quality standard.
 - Comply with the installation instructions of the snow chain manufacturer.
 - If snow chains are fitted, the maximum permissible speed is 50 km/h.
 - **Vehicles with Active Parking Assist:** do not use Active Parking Assist when snow chains are fitted.
 - **Vehicles with AIRMATIC:** if snow chains are fitted, only drive at raised vehicle level (→ page 358).
 - **Vehicles with rear axle steering:** if snow chains are fitted, only drive with snow chain mode active (→ page 628).
- i** You can permanently limit the maximum speed for driving with winter tyres (→ page 321).
- i** You can deactivate ESP® to pull away (→ page 310). This allows the wheels to spin, achieving an increased driving force.

Activating or deactivating snow chain mode

Multimedia system:



▶ Activate or deactivate **Snow chain mode**.

When the function is active, the vehicle behaves as if snow chains were installed. For example, the maximum steering movement of the rear wheels is limited and the turning circle is thus increased.

Additionally, parts of the driving and driving safety systems are not available when snow chain mode is active.

Tyre pressure

Notes on tyre pressure

! **WARNING** Risk of accident due to insufficient or excessive tyre pressure

Underinflated or overinflated tyres pose in particular the following risks:

- The tyres can burst.

- The tyres can wear excessively and/or unevenly.
 - The driving characteristics as well as the steering and braking characteristics may be greatly impaired.
- ▶ Comply with the recommended tyre pressure and check the tyre pressure of all tyres, including the spare wheel, regularly:
- monthly
 - when the load changes
 - before embarking on a longer journey
 - if operating conditions change, e.g. off-road driving
- ▶ Adjust the tyre pressure, if necessary.

Tyre pressure which is too high or too low can:

- Shorten the service life of the tyres.
- Cause increased tyre damage.
- Adversely affect driving characteristics and thus driving safety, e.g. due to aquaplaning.

⚠ WARNING Risk of accident due to repeated pressure drop in the tyres

The wheels, valves or tyres could be damaged. Too low a tyre pressure can lead to the tyres bursting.

- ▶ Examine the tyres for foreign objects.
- ▶ Check whether the tyre has a puncture or the valve has a leak.
- ▶ If you are unable to rectify the damage, contact a qualified specialist workshop.

Information on the recommended tyre pressure for the vehicle's factory-fitted tyres can be found on the tyre pressure table on the B-pillar on the driver's side (→ page 629).

Use a suitable pressure gauge to check the tyre pressure. The outer appearance of a tyre does not permit any reliable conclusion about the tyre pressure.

Only correct tyre pressures when the tyres are cold. Conditions for cold tyres:

- The vehicle has been parked with the tyres out of direct sunlight for at least three hours.

- The vehicle has travelled less than 1.6 km.

The vehicle's tyres heat up when driving. As the temperature of the tyres increases, so too does the tyre pressure.

Vehicles with a tyre pressure monitoring system: you can also see the tyre pressure in the driver's display (→ page 631).

Notes on trailer operation

Always inflate the rear axle tyres to the recommended tyre pressures on the tyre pressure table for increased load.

Tyre pressure table

The tyre pressure table is on the B-pillar on the driver's side.

The image shows a digital display for a tyre pressure monitoring system. At the top left is an information icon (i) and the text "100 kPa = 1 bar". At the top right is a car silhouette with two tyre pressure sensor icons. Below this is a table with columns for "kPa" and "psi" for two different tyre positions. The table rows represent different load conditions: "partially laden" and "fully laden", each with sub-rows for different passenger and luggage configurations. The bottom of the display shows the vehicle identification number "A 213 584 37 03" and the code "1234567".

	Load Condition	Left Tyre		Right Tyre	
		kPa	psi	kPa	psi
partially laden	2 passengers + luggage				
	3 passengers + luggage				
fully laden	4 passengers + luggage				
	5 passengers + luggage				

The tyre pressure table shows the recommended tyre pressure for all tyres approved for this vehicle. The recommended tyre pressures apply for cold tyres under various operating conditions, i.e. loading and/or speed of the vehicle.

If one or more tyre sizes precede a tyre pressure, the tyre pressure information following is only valid for those tyre sizes.

If the preceding tyre sizes are complemented by the symbol, the tyre pressure information following shows alternative tyre pressures. These tyre pressures may improve your vehicle's ride comfort. Energy consumption may then increase slightly.

The load conditions "partially laden" and "fully laden" are defined in the table for different numbers of passengers and amounts of luggage. The actual number of seats may differ from this.

Be sure to also observe the following further related subjects:

- Notes on tyre pressure (→ page 628)

Tyre pressure monitoring system

Function of the tyre pressure monitoring system

The system checks the tyre pressure and the tyre temperature of the tyres fitted to the vehicle by means of a tyre pressure sensor.

The tyre pressure and the tyre temperature appear in the driver's display.

If there is a substantial pressure loss or if the tyre temperature is excessive, you will be warned with display messages (→ page 854) or the warning lamp in the driver's display (→ page 874).

The tyre pressure monitoring system is only an aid. It is the driver's responsibility to set the tyre pressure to the recommended cold tyre pressure suitable for the operating situation.

In most cases, the tyre pressure monitoring system will automatically update the new reference values after you have changed the tyre pressure. You can, however, also update the reference values by restarting the tyre pressure monitoring system manually (→ page 631).

System limits

The system may be impaired or may not function particularly in the following situations:

- incorrect reference values were taught in
- sudden pressure loss caused by a foreign object penetrating the tyre, for example
- there is a malfunction caused by another radio signal source

Checking the tyre pressure with the tyre pressure monitoring system

Requirements

- The vehicle is switched on.

Driver's display:

→  **Service**

▶ Press **OK** to confirm.

One of the following displays appears:

- Current tyre pressure of each wheel:

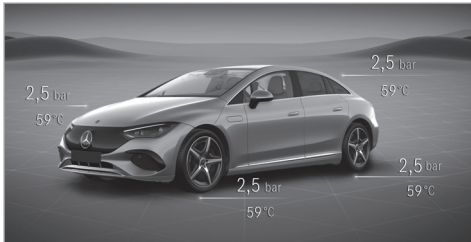

- Tyre pressures will be displayed after a few minutes of driving:** current values are not yet known to the system. The pressure/tempera-

ture values of each tyre are displayed as soon as they are known to the system.

- Tyre pressure monitor active:** the teach-in process of the system is not yet complete. The tyre pressures are already being monitored.

▶ Compare the current tyre pressure with the recommended tyre pressure for the current operating condition (→ page 629). Additionally, observe the notes on cold tyres (→ page 628).

ⓘ The values displayed in the driver's display may deviate from those of the tyre pressure gauge as they refer to sea level. At high elevations, the tyre pressure values indicated by a tyre pressure gauge are higher than those shown in the driver's display.

Restarting the tyre pressure monitoring system

Requirements

- The recommended tyre pressure is correctly set for the respective operating status on each of the four wheels (→ page 628).

Restart the tyre pressure monitoring system in the following situations:

- The tyre pressure has changed.
- The wheels or tyres have been changed or newly fitted.

Driver's display:

→  **Service**

- ▶ Select **Tyre pressure** and confirm with **OK**.
- ▶ Swipe downwards on Touch Control on the steering wheel. The **Use current tyre pressures as new reference values?** message is shown in the driver's display.
- ▶ Select **Yes** and confirm the restart with **OK**. The **Tyre pressure monitor restarted** message is shown in the driver's display.

Current warning messages are deleted and the yellow  warning lamp goes out.

After you have been driving for a few minutes, the system checks whether the current tyre pressures are within the specified range. The current tyre pressures are then accepted as reference values and monitored.

If the tyre pressure levels are not within the specified range, the **Please correct tyre pressure** message appears.

Wheel change

Notes on selecting, fitting and replacing tyres

⚠ WARNING Risk of accident due to incorrect wheel and tyre dimensions

If wheels and tyres of the wrong size are fitted, the service brakes or components in the brake system and in the wheel suspension may be damaged.

▶ Always replace wheels and tyres with those that fulfil the specifications of the original part.

For wheels, pay attention to the following:

- Designation
- Type

For tyres, pay attention to the following:

- Designation

- Manufacturer
- Type

⚠ WARNING Risk of injury through exceeding the specified tyre load-bearing capacity or the permissible speed rating

Exceeding the load-bearing capacity of the tyres can lead to tyre damage and could cause the tyres to explode.

- ▶ Therefore, only use tyre types and sizes approved for your vehicle model.
- ▶ Observe the tyre load-bearing capacity rating and speed rating required for your vehicle.

! NOTE Vehicle and tyre damage caused by non-approved tyre types and sizes

For safety reasons, only use tyres, wheels and accessories which have been specially approved by Mercedes-Benz for your vehicle.

These tyres are specially adapted to the active safety systems, such as ABS, ESP® and 4MATIC, and marked as follows:

- MO = Mercedes-Benz Original
- MOE = Mercedes-Benz Original Extended (run-flat tyres only for certain wheels)
- MO1 = Mercedes-Benz Original (only certain AMG tyres)

Otherwise, certain properties, such as driving characteristics, vehicle noise emissions, consumption, etc. could be adversely affected. Furthermore, other tyre sizes could result in the tyres rubbing against the body and axle components when loaded. This could result in damage to the tyre or the vehicle.

Only use tyres, wheels and accessories that have been checked and recommended by Mercedes-Benz.

! **NOTE** Risk to driving safety from retreaded tyres

Retreaded tyres are neither tested nor recommended by Mercedes-Benz, since previous damage cannot always be detected on retreaded tyres.

For this reason driving safety cannot be guaranteed.

- ▶ Do not use used tyres if you have no information about their previous usage.

! **NOTE** Possible wheel and tyre damage when driving over obstacles

Large wheels have a smaller section width. As the section width decreases, the risk of wheels and tyres being damaged when driving over obstacles increases.

- ▶ Avoid obstacles or drive especially carefully.
- ▶ Reduce your speed when driving over kerbs, speed bumps, manhole covers and potholes.

- ▶ Avoid particularly high kerbs.

! **NOTE** Possible wheel and tyre damage when parking on kerbs or in potholes

Parking on kerbs or in potholes can damage the wheels and tyres.

- ▶ Only park on level surfaces if possible.
- ▶ Avoid kerbs and potholes when parking.

! **NOTE** Damage to electronic component parts due to the use of tyre-fitting tools

Vehicles with tyre pressure monitoring system: there are electronic component parts in the wheel.

If tyre-fitting tools are positioned in the area of the valve, the electronic components could be damaged.

- ▶ Tyre-fitting tools should not be applied in the area of the valve.
- ▶ Always have tyres changed at a qualified specialist workshop.

! **NOTE** Damage to summer tyres at low ambient temperatures

At low ambient temperatures, tears could form when driving with summer tyres, causing permanent damage to the tyre.

- ▶ At temperatures below 7 °C use  M+S tyres.

Accessory parts which are not approved for your vehicle by Mercedes-Benz, or which are not used correctly, can impair the operating safety.

Before purchasing and using non-approved accessories, visit a qualified specialist workshop and enquire about:

- Suitability
- Legal stipulations
- Factory recommendations

! **WARNING** Risk of accident with sport tyres

The special tyre tread in combination with the optimised tyre compound means that the risk

of skidding or aquaplaning on wet roads is increased.

In addition, the tyre grip is greatly reduced at a low outside temperature and tyre running temperature.

- ▶ Switch on the ESP[®] and adapt your driving style accordingly.
- ▶ Use  M+S tyres at outside temperatures of less than 7 °C.
- ▶ Only use tyres suitable for the intended use.

Observe the following when selecting, fitting and replacing tyres:

- Country-specific requirements for tyre approval that define a specific tyre type for your vehicle.
- Furthermore, the use of certain tyre types in certain regions and areas of operation can be highly beneficial.
- Only use tyres and wheels of the same type (summer tyres, winter tyres, MOExtended tyres) and the same make.

- Only fit wheels of the same size on one axle (left and right).

It is only permissible to fit a different wheel size in the event of a flat tyre in order to drive to the specialist workshop.

- Do not make any modifications to the brake system, the wheels or the tyres.

The use of shims or brake dust shields is not permitted and may invalidate the vehicle's general operating permit.

- **Vehicles with a tyre pressure monitoring system:** all fitted wheels must be equipped with functioning sensors for the tyre pressure monitoring system.
- At temperatures below 7 °C use winter tyres or all-season tyres marked  M+S for all wheels.
Winter tyres provide the best possible grip in wintry road conditions.
- For M+S tyres, only use tyres with the same tread.
- Observe the maximum permissible speed for the M+S tyres fitted.

If the tyre's maximum speed is below that of the vehicle, this must be indicated by an appropriate label in the driver's field of vision.

- Run in new tyres at moderate speeds for the first 100 km.
- Replace the tyres after six years at the latest, regardless of wear.
- **When replacing with tyres that do not feature run-flat characteristics:** vehicles with MOExtended tyres are not equipped with a TIREFIT kit at the factory. Equip the vehicle with a TIREFIT kit after replacing with tyres that do not feature run-flat characteristics, e.g. winter tyres.

 You can permanently limit the maximum speed for driving with winter tyres (→ page 321).

For more information on wheels and tyres, contact a qualified specialist workshop.

Vehicles with the AMG DYNAMIC PLUS package

⚠ WARNING Risk of accident caused by non-approved tyre types

If you use tyre types that have not been adapted to changes made to the factory speed limit, this can have the following consequences:

- The tyres are not suitable for high speeds and the corresponding driving dynamics.
- The tyres wear unevenly and affect the roadworthiness of the vehicle.
- ABS, ESP® and cruise control operation are restricted.

This can jeopardise road safety.

- ▶ Only use tyre types that have been approved for the maximum permissible speed set and the vehicle.

Notes on interchanging wheels

⚠ WARNING Risk of injury through different wheel sizes

Interchanging the front and rear wheels can severely impair the driving characteristics.

The disk brakes or wheel suspension components may also be damaged.

- ▶ Only interchange the front and rear wheels if the wheels and tyres have the same dimensions.

Interchanging the front and rear wheels if the wheels or tyres have different dimensions can render the general operating permit invalid. Observe the instructions and safety notes on "Changing a wheel" (→ page 632)

The wear patterns on the front and rear wheels differ:

- front wheels wear more on the tyre shoulder
- rear wheels wear more in the centre of the tyre

Do not drive with tyres that have too little tread depth. This significantly reduces traction on wet roads (aquaplaning).

On vehicles with the same front and rear wheel size, you can interchange the wheels every 5,000 to 10,000 km, depending on the wear. Ensure the direction of rotation is maintained for the wheels.

Notes on storing wheels

When storing wheels, observe the following notes:

- After removing wheels, store them in a cool, dry and preferably dark place.
- Protect the tyres from contact with oil, grease or fuel.

Overview of the tyre-change tool kit

Apart from some country-specific variants, vehicles are not equipped with a tyre-change tool kit. Consult a qualified specialist workshop to find out which wheel change tool is necessary and approved for a wheel change on your vehicle.

You require the following tools, foreexample, to change a wheel:

- Jack
- Chock
- Wheel wrench
- Centring pin

i The jack weighs approximately 3.4 kg. The maximum load capacity of the jack can be found on the sticker affixed to the jack. The jack is maintenance-free. If there is a malfunction, please contact a qualified specialist workshop.

The tyre-change tool kit is located in tool bag **1** in the boot.

i When stowing the tool bag, make sure that it is adequately secured.

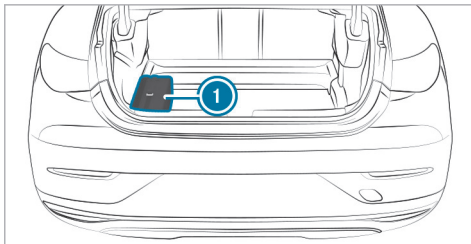

The tool bag contains:

- Jack
- Gloves
- Wheel wrench
- Centring pin
- Folding chock
- Ratchet for jack

Preparing the vehicle for a wheel change

Requirements

- The vehicle is not on a slope.

- The vehicle is on solid, non-slippery and level ground.
- The required tyre-change tool kit is available.

i If your vehicle is not equipped with the tyre-change tool kit, consult a qualified specialist workshop to find out about suitable tools.

- ▶ Apply the electric parking brake manually.
- ▶ Move the front wheels to the straight-ahead position.
- ▶ Shift the transmission to position **P**.
- ▶ **Vehicles with AIRMATIC:** set the raised vehicle level for greater ground clearance (→ page 358).
- ▶ Switch off the vehicle.
- ▶ Make sure that the vehicle cannot be started.
- ▶ Place chocks or other suitable items under the front and rear of the wheel that is diagonally opposite the wheel you wish to change.
- ▶ Unload the vehicle.

Fitting/removing the hub cap

Requirements

- The vehicle is prepared for a wheel change .

Removing

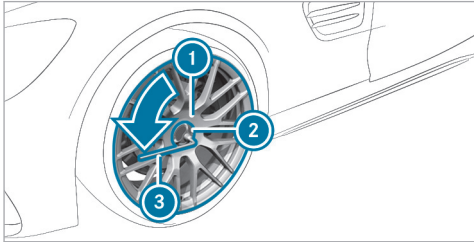

- Remove socket ② and wheel wrench ③ from the vehicle tool kit.
- Position socket ② on hub cap ①.
- Position wheel spanner ③ on socket ②.
- Using wheel spanner ③, turn hub cap ① anti-clockwise and remove it.

Fitting

- Before fitting, check hub cap ① and the wheel area for dirt, and clean if necessary.
- Position hub cap ① and turn until it is in the right position.
- Position socket ② on hub cap ①.
- Position wheel wrench ③ on socket ② and tighten hub cap ①.

i Specified tightening torque: 25 Nm

Removing and fitting the wheel trim/hub caps

Requirements

- The vehicle is prepared for a wheel change (→ page 636).

Wheel trim

The wheel trim covers the wheel bolts on vehicles with aluminium wheels. Before unscrewing the wheel bolts, remove the wheel trim.

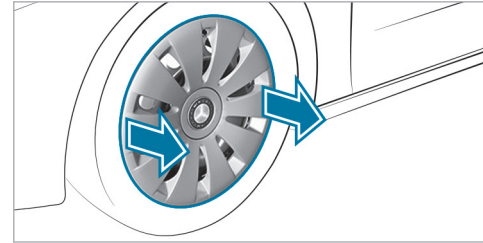

- To remove:** using both hands, carefully reach into two wheel trim openings and remove the wheel trim.
- To fit:** place the wheel trim in position and press firmly until it engages.

Raising the vehicle when changing a wheel

Requirements

- There are no persons in the vehicle.
- The vehicle has been prepared for a wheel change (→ page 636).

Important notes on using the jack:

- Use only a vehicle-specific jack that has been approved by Mercedes-Benz to raise the vehicle.
- The jack is only designed for raising and holding the vehicle for a short time while a wheel is being changed and not for maintenance work under the vehicle.
- The jack must be placed on a firm, flat and non-slip surface. If necessary, use a large, flat, load-bearing, non-slip underlay.
- The foot of the jack must be positioned vertically under the jack support point.

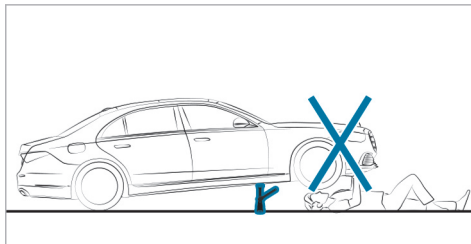
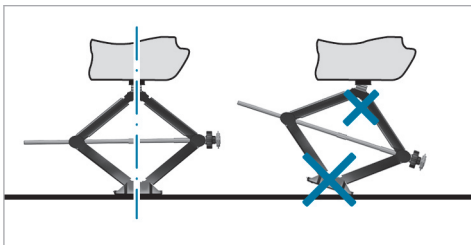

Rules of conduct when the vehicle is raised:

- Never place your hands or feet under the vehicle.
- Never lie under the vehicle.
- Do not start the vehicle and do not release the electric parking brake.
- Do not open or close any doors or the boot lid.

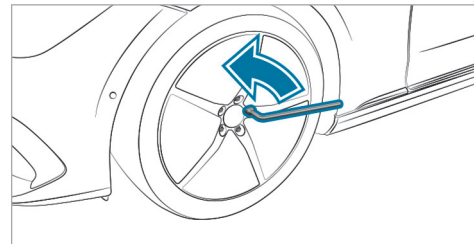

- ▶ Using the wheel wrench, loosen the wheel bolts on the wheel you wish to change by about one full turn. Do not unscrew the screws completely.

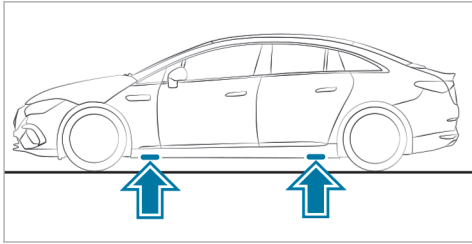

Position of the jack support points

⚠ WARNING Risk of injury from incorrect positioning of the jack

If you do not position the jack correctly at the appropriate jacking point of the vehicle, the jack could tip with the vehicle raised.

- ▶ Only position the jack at the appropriate jacking point of the vehicle. The base of the jack must be positioned vertically under the jacking point of the vehicle.

! NOTE Damage to the vehicle due to using an unsuitable jack

You can damage the vehicle and, in particular, the high-voltage battery if you use a jack that is not specifically designed for the jack support points of the vehicle.

- ▶ Only use jacks that are specifically designed for the jack support points, or use an appropriate adapter.

! NOTE Risk of damage to the vehicle due to incorrect positioning of the jack

If you do not position the jack at the designated jack support points, you could damage your vehicle and, in particular, the high-voltage battery.

- ▶ Only position the jack at the designated jack support points.
- ▶ Take the ratchet out of the tyre-change tool kit and place it on the hexagon nut of the jack so that the letters "AUF" are visible.

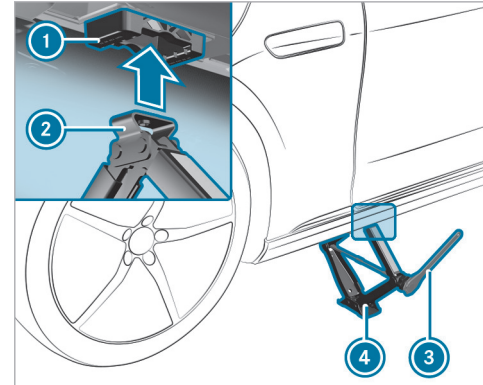

- ▶ Position support ② of jack ④ on jack support point ①.
- ▶ Turn ratchet ③ clockwise until support ② sits completely on jack support point ① and the base of the jack lies evenly on the ground.
- ▶ Turn ratchet ③ until the tyre is raised a maximum of 3 cm from the ground.
- ▶ Loosen and remove the wheel (→ page 640).

Removing a wheel

Requirements

- The vehicle is raised (→ page 637).

When changing a wheel, avoid applying any force to the brake discs, as this could impair the level of comfort when braking.

! **NOTE** Damage to the wheels' plastic elements when changing a wheel

Plastic elements on wheels may be damaged when removing and repositioning the wheel.

- ▶ Do not raise the wheels by the plastic elements when removing and repositioning.

! **NOTE** Damage to threading from dirt on wheel bolts

- ▶ Do not place wheel bolts in sand or on a dirty surface.

- ▶ Unscrew the uppermost wheel bolt completely.

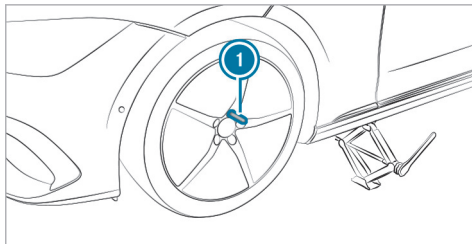

- ▶ Screw centring pin ① into the thread instead of the wheel bolt.
- ▶ Unscrew the remaining wheel bolts completely.
- ▶ Remove the wheel.

Fitting a new wheel

Requirements

- The wheel to be changed is removed and the centring pin is screwed in (→ page 640).

! **WARNING** Risk of accident from losing a wheel

Oiled or greased wheel bolts can cause the wheel bolts to come loose, as too can damaged wheel bolts or wheel hub threads.

- ▶ Never oil or grease the threads.
- ▶ In the event of damage to the threads, contact a qualified specialist workshop immediately.
- ▶ Have the damaged wheel bolts or damaged hub threads replaced.
- ▶ Do not continue driving.

- ▶ Observe the information on the choice of tyres (→ page 632).

For tyres with a specified direction of rotation, an arrow on the side wall of the tyre indicates the correct direction of rotation. Observe the direction of rotation when fitting.

! **NOTE** Damage to the wheels' plastic elements when changing a wheel

Plastic elements on wheels may be damaged when removing and repositioning the wheel.

▶ Do not raise the wheels by the plastic elements when removing and repositioning.

▶ Slide the wheel to be mounted onto the centring pin and push it on.

! **WARNING** Risk of injury from tightening wheel bolts and nuts

If you tighten the wheel bolts or wheel nuts when the vehicle is raised, the jack could tip.

▶ Only tighten wheel bolts or wheel nuts when the vehicle is on the ground.

- ▶ Be sure to observe the instructions and safety notes on "Changing a wheel" (→ page 632).
- ▶ For safety reasons, only use wheel bolts which have been approved by Mercedes-Benz and for the wheel in question.

▶ Tighten the wheel bolts evenly in a diagonal pattern in the order indicated until they are finger-tight.

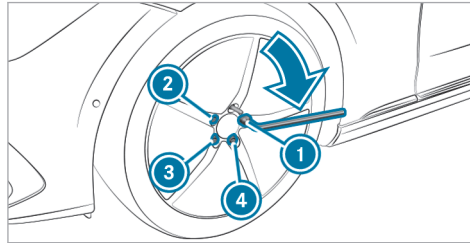

▶ Unscrew and remove the centring pin.

▶ Tighten the last wheel bolt until it is finger-tight.

▶ Lower the vehicle (→ page 641).

Lowering the vehicle after a wheel change

Requirements

- The new wheel has been fitted (→ page 640).

! **NOTE** Risk of vehicle jack becoming trapped by the AIRMATIC system

If the AIRMATIC system has released air when raising the vehicle, the jack can become trapped when the vehicle is lowered.

▶ Start the drive system. This adapts the vehicle level.

▶ Remove the jack from under the vehicle.

▶ **To lower the vehicle:** place the ratchet onto the hexagon nut of the jack so that the letters "AB" are visible and turn anti-clockwise.

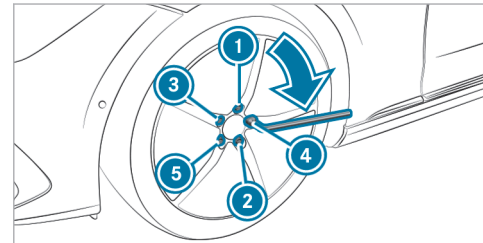

- ▶ Tighten the wheel bolts evenly in a diagonal pattern in the order indicated ① to ⑤ with an initial maximum force of 80 Nm.
- ▶ Tighten the wheel bolts evenly in a diagonal pattern in the order indicated ① to ⑤ with the specified tightening torque of 150 Nm.

⚠ WARNING Risk of accident due to incorrect tightening torque

The wheels could come loose if the wheel bolts or wheel nuts are not tightened to the prescribed torque.

- ▶ Ensure that the wheel bolts or wheel nuts are tightened to the prescribed tightening torque.
- ▶ If you are not sure, do not move the vehicle. Contact a qualified specialist workshop and have the tightening torque checked immediately.

- ▶ Check the tyre pressure of the newly fitted wheel and adjust it if necessary.

i The following does not apply if the new wheel is an emergency spare wheel.

- ▶ **Vehicles with a tyre pressure monitoring system:** restart the tyre pressure monitoring system (→ page 631).

Emergency spare wheel

Notes on the emergency spare wheel

⚠ WARNING Risk of accident caused by incorrect wheel and tyre dimensions

The wheel or tyre size and the tyre type of the emergency spare wheel or spare wheel and the wheel to be replaced may differ. The emergency spare wheel or spare wheel can significantly impair driving characteristics of the vehicle.

To prevent hazardous situations:

- ▶ Drive carefully.
- ▶ Never fit more than one emergency spare wheel or spare wheel that differs in size.

- ▶ Only use an emergency spare wheel or spare wheel briefly.
- ▶ Do not deactivate ESP®.
- ▶ Have the emergency spare wheel or spare wheel of a different size replaced at the nearest qualified specialist workshop. The new wheel must have the correct dimensions.

i The emergency spare wheel is secured in the emergency spare wheel bag in the boot.

Observe the following notes on fitting an emergency spare wheel:

- The maximum permissible speed with an emergency spare wheel fitted is 80 km/h.
- Do not fit the emergency spare wheel with snow chains.
- Replace the emergency spare wheel after six years at the latest, regardless of wear.
- Use the wheel bolts that are included with the emergency spare wheel.

- Check the tyre pressure of the emergency spare wheel fitted. Correct the pressure as necessary.
- ❗ The specified tyre pressure is stated on the label of the emergency spare wheel.
- ❗ **Vehicles with a tyre pressure monitoring system:** if an emergency spare wheel is fitted, the tyre pressure monitoring system cannot function reliably. For a few minutes after an emergency spare wheel is fitted, the system may still display the tyre pressure of the removed wheel. Only restart the system again when the emergency spare wheel has been replaced with a new wheel.

Be sure to also observe the following further related subjects:

- Notes on tyre pressure (→ page 628)
- Tyre pressure table (→ page 629)
- Notes on fitting tyres (→ page 632)
- Fitting an emergency spare wheel (→ page 636)

Notes on technical data

The technical data was determined in accordance with EU Directives. The data stated only applies to vehicles with standard equipment. You can obtain further information from a Mercedes-Benz Service Centre.

Only for certain countries: you can find vehicle-specific vehicle data in the COC documents (CERTIFICATE OF CONFORMITY). These documents are supplied when the vehicle is delivered.

On-board electronics

Notes on tampering with the drive system

! **NOTE** Premature wear through improper maintenance

Improper maintenance may cause vehicle components to wear more quickly and the vehicle's operating permit may be invalidated.

- ▶ Always have work on the drive system and related components carried out at a qualified specialist workshop.

Two-way radios

Notes on fitting two-way radios

! **WARNING** Risk of accident due to improper work on two-way radios

If two-way radios are manipulated or retrofitted incorrectly, the electromagnetic radiation from the two-way radios can interfere with the vehicle electronics and jeopardise the operating safety of the vehicle.

- ▶ You should have all work on electrical and electronic components carried out at a qualified specialist workshop.

! **WARNING** Risk of accident due to improper operation of two-way radios

If you use two-way radios in the vehicle improperly, their electromagnetic radiation can disrupt the vehicle's electronics. This is the case in the following situations, in particular:

- The two-way radio is not connected to an exterior aerial.
- The exterior aerial is fitted incorrectly or is not a low-reflection aerial.

This could jeopardise the operating safety of the vehicle.

- ▶ Have the low-reflection exterior aerial fitted at a qualified specialist workshop.
- ▶ When operating two-way radios in the vehicle, always connect them to the low-reflection exterior aerial.

! **NOTE** Invalidation of the operating permit due to failure to comply with the instructions for installation and use

The operating permit may be invalidated if the instructions for installation and use of two-way radios are not observed.

- ▶ Only use approved frequency bands.
- ▶ Observe the maximum permissible output power in these frequency bands.
- ▶ Only use approved aerial positions.

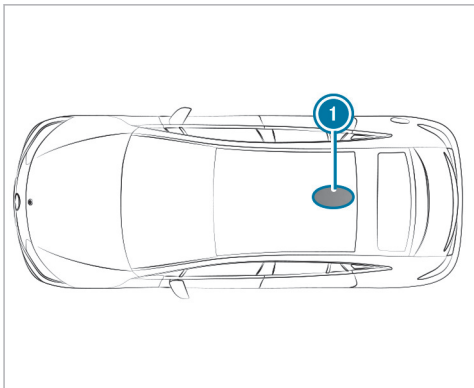

① Rear roof area

On vehicles with a panoramic sliding sunroof, fitting an aerial is not permitted.

Use Technical Specification ISO/TS 21609 (Road Vehicles – "EMC guidelines for installation of aftermarket radio frequency transmitting equipment") when retrofitting two-way radios. Comply with the legal requirements for detachable parts.

If your vehicle has fittings for two-way radio equipment, use the power supply and aerial connectors provided in the pre-installation. Observe the manufacturer's supplements when fitting.

■ Two-way radio transmission output

The maximum transmission output (PEAK) at the base of the aerial must not exceed the values in the following table.

Frequency band and maximum transmission output

Frequency band	Maximum transmission output
2-m- frequency band 144 - 174 MHz	50 W
Terrestrial Trunked Radio (TETRA) 380 - 460 MHz	10 W

Frequency band	Maximum transmission output
Two-way radio 2G	2 W
Two-way radio 3G/4G/5G	0.5 W

The following can be used in the vehicle without restrictions:

- two-way radios with a maximum transmission output of up to 100 mW
- two-way radios with transmitter frequencies in the 380 - 410 MHz frequency band and a maximum transmission output of up to 2 W (TETRA)
- mobile phones (2G/3G/4G/5G)

There are no restrictions when positioning the aerial on the outside of the vehicle for the following frequency bands:

- Terrestrial Trunked Radio (TETRA)
- 2G/3G/4G/5G

Regulatory radio information

Specific information on wireless applications in accordance with 2014/53/EU

Besides the typical frequencies for mobile communication cars by Mercedes-Benz make use of the following automotive radio applications.

Type of wireless applications and specifications in accordance with 2014/53/EU

Technology	Frequency range	Transmission output/magnetic field strength
Remote Keyless Entry	20 kHz (9–90 kHz)	≤ 72 dB μ A/m at 10m
Wireless Power Transmission	105 kHz (90–119 kHz)	≤ 42 dB μ A/m at 10m
Remote Keyless Entry	120 kHz (119–135 kHz)	≤ 42 dB μ A/m at 10m
Wireless Power Transmission	127 kHz (119–135 kHz)	≤ 66 dB μ A/m at 10m with the magnetic field strength level decreasing 3dB/octave above 119 kHz
Near-field communication	13.553–13.567 MHz	≤ 42 dB μ A/m at 10m
Remote Keyless Entry, Garage Door Opener, Tire Pressure Monitoring	433 MHz (433.05–434.79 MHz)	≤ 10 mW ERP

Technology	Frequency range	Transmission output/magnetic field strength
Block Heater Remote Control, Garage Door Opener	868 MHz (868.0–868.6 MHz)	≤ 25 mW ERP
Block Heater Remote Control, Garage Door Opener	869 MHz (868.7–869.2 MHz)	≤ 25 mW ERP
Bluetooth, Klear, RLAN, wireless Headphones	2.4 GHz ISM band (2400–2483.5 MHz)	≤ 100 mW EIRP
RLAN	5.1 GHz UNII-1 (5150–5250 MHz)	≤ 25 mW EIRP
Interior Monitoring Radar, RLAN	5.8 GHz UNII-3 (5725–5875 MHz)	≤ 25 mW EIRP
Remote Keyless Entry	7.25 GHz UWB (6.0–8.5 GHz)	≤ -41.3 dBm/MHz EIRP mean ≤ 0 dBm/MHz EIRP peak
76 GHz radar	76–77 GHz	≤ 55 dBm peak EIRP
Compensator ECE DE003 and ECE DE004	GSM (E-GSM 900)	< +33 dBm
	GSM (E-GSM 1800)	< +30 dBm
	UMTS (I, III, VIII)	< +23 dBm
	LTE (B1, B3, B7, B8, B20)	< +23 dBm
HERMES (Hardware for Enhanced Remote, Mobility & Emergency Services)	WLAN (2400–2483.5 MHz)	< 20 dBm
	WLAN (5736–5833 MHz)	< 14 dBm

Technology	Frequency range	Transmission output/magnetic field strength
	GSM (E-GSM 900, Class 4)	< +33 dBm (± 2 dB)
	GSM (E-GSM 1800, Class 1)	< +30 dBm (± 2 dB)
	GSM (E-GSM 900 8-PSK, Class E2)	< +27 dBm (± 3 dB)
	GSM (E-GSM 1800 8-PSK, Class E2)	< +26 dBm (± 3 dB/-4 dB)
	UMTS (2100 WCDMA FDD B1, Class 3)	< +24 dBm (± 1 dB/-3 dB)
	LTE (FDD B I, B III, B38, B39, B40, B41, Class 3)	< +23 dBm (± 2 dB)
	GPS (1575,42 MHz +/- 2 MHz)	Receiving only
RAMSES (Router And Mobile ServiceS)	GSM (E-GSM 850 / E-GSM 900, Class 4)	< +32.5 dBm (± 1 dB)
	GSM (E-GSM 1800 / E-GSM 1900, Class 4)	< +29.5 dBm (± 1 dB)
	UMTS (WCDMA FDD I, II, III, IV, V, VIII, XIX, Class 3)	< +23.5 dBm (± 1 dB)
	LTE (FDD B1, B2, B3, B4, B5, B7, B8, B9, B18, B19, B21, B28, Class 3)	< +23 dBm (± 1 dB)
	LTE (TDD B38, B40, B41, Class 3)	< +23 dBm (± 1 dB)
	GNSS (1559-1610 MHz)	Receiving only

Further information and updates are available at the following web address:

<https://regulatoryradioinformation.corpinter.net/en>



Regulatory radio identifiers and specific notes

The tables and sections contain the following regulatory radio information:

- Manufacturer information
- Required regulatory radio identifiers, listed by country/region:
 - Manufacturer's specifications
 - Model designations
 - Radio equipment approval numbers
- Specific information on wireless vehicle components

Overview of manufacturers

Manufacturer	Manufacturer information
ADC	ADC Automotive Distance Control Systems GmbH, Peter-Dornier-Straße 10, 88131 Lindau, Germany
Bosch	Robert Bosch GmbH, Daimlerstraße 6, 71229 Leonberg, Germany
Continental Antenna	Continental Advanced Antenna GmbH, Römerring 1, 31137 Hildesheim, Germany
Continental Automotive	Continental Automotive GmbH, Siemensstraße 12, 93055 Regensburg, Germany

Manufacturer	Manufacturer information
Gentex	Gentex Corporation, 600 North Centennial Street, Zeeland MI 49464, USA
Harman Becker	Harman Becker Automotive Systems GmbH, Becker-Goehring-Strasse 18, 76307 Karlsbad, Germany
HELLA	HELLA KGaA Hueck & Co., Rixbecker Straße 75, 59552 Lippstadt, Germany
Hirschmann	Hirschmann Car Communication GmbH, Stuttgarter Straße 45-51, 72654 Neckartenzlingen, Germany

Manufacturer	Manufacturer information
Huf Baolong	Huf Baolong Electronics Bretten GmbH, Gewerbestraße 40, 75015 Bretten, Germany
HUF	HUF Hülsbeck & Fürst GmbH & Co. KG, Steeger Straße 17, 42551 Velbert, Germany
KATHREIN	KATHREIN Automotive GmbH & Co. KG, Römerring 1, 31137 Hildesheim, Germany
LEOPOLD KOSTAL	LEOPOLD KOSTAL GmbH & Co. KG, Hauert 11, 44227 Dortmund, Germany

Manufacturer	Manufacturer information
MARQUARDT	MARQUARDT GmbH, Schloßstraße 16, 78604 Rietheim-Weilheim, Germany
Meta System	Meta System S.P.A., Via T. Galimberti 5, 42124 Reggio Emilia, Italy
Molex	Molex CVS Dabendorf GmbH, Märkische Straße 72, 15806 Zossen, Germany
Panasonic	Panasonic Automotive Systems Europe GmbH, Robert-Bosch-Straße 27, 63225 Langen, Germany

Manufacturer	Manufacturer information
Schrader	Schrader Electronics Ltd., 11 Technology Park, Belfast Road, Antrim BT41 1QS, Northern Ireland, United Kingdom
Sennheiser	Sennheiser electronic GmbH & Co. KG, Am Labor 1, 30900 Wedemark, Germany
Veoneer	Veoneer Sweden AB, Wallentinsvägen 22, 44737 Vårgårda, Sweden
WITTE-Velbert	WITTE-Velbert GmbH & Co. KG, Hoefestr. 3-15, 42551 Velbert, Germany

The tables and sections contain the following regulatory radio information:

- Manufacturer information
- Required regulatory radio identifiers, listed by country/region:
 - Manufacturer's specifications
 - Model designations
 - Radio equipment approval numbers
- Specific information on wireless vehicle components

Further information and updates are available at the following web address:

<https://regulatoryradioinformation.corpinter.net/en>



Overview of manufacturers

Manufacturer	Manufacturer information
ADC	ADC Automotive Distance Control Systems GmbH, Peter-Dornier-Straße 10, 88131 Lindau, Germany
Bosch	Robert Bosch GmbH, Daimlerstraße 6, 71229 Leonberg, Germany
Continental Antenna	Continental Advanced Antenna GmbH, Römerring 1, 31137 Hildesheim, Germany
Continental Automotive	Continental Automotive GmbH, Siemensstraße 12, 93055 Regensburg, Germany

Manufacturer	Manufacturer information
Gentex	Gentex Corporation, 600 North Centennial Street, Zeeland MI 49464, USA
Harman Becker	Harman Becker Automotive Systems GmbH, Becker-Goehring-Strasse 18, 76307 Karlsbad, Germany
HELLA	HELLA KGaA Hueck & Co., Rixbecker Straße 75, 59552 Lippstadt, Germany
Hirschmann	Hirschmann Car Communication GmbH, Stuttgarter Straße 45-51, 72654 Neckartenzlingen, Germany

Manufacturer	Manufacturer information
Huf Baolong	Huf Baolong Electronics Bretten GmbH, Gewerbestraße 40, 75015 Bretten, Germany
HUF	HUF Hülsbeck & Fürst GmbH & Co. KG, Steeger Straße 17, 42551 Velbert, Germany
KATHREIN	KATHREIN Automotive GmbH & Co. KG, Römerring 1, 31137 Hildesheim, Germany
LEOPOLD KOSTAL	LEOPOLD KOSTAL GmbH & Co. KG, Hauert 11, 44227 Dortmund, Germany

Manufacturer	Manufacturer information
MARQUARDT	MARQUARDT GmbH, Schloßstraße 16, 78604 Rietheim-Weilheim, Germany
Meta System	Meta System S.P.A., Via T. Galimberti 5, 42124 Reggio Emilia, Italy
Molex	Molex CVS Dabendorf GmbH, Märkische Straße 72, 15806 Zossen, Germany
Panasonic	Panasonic Automotive Systems Europe GmbH, Robert-Bosch-Straße 27, 63225 Langen, Germany

Manufacturer	Manufacturer information
Schrader	Schrader Electronics Ltd., 11 Technology Park, Belfast Road, Antrim BT41 1QS, Northern Ireland, United Kingdom
Sennheiser	Sennheiser electronic GmbH & Co. KG, Am Labor 1, 30900 Wedemark, Germany
Veoneer	Veoneer Sweden AB, Wallentinsvägen 22, 44737 Vårgårda, Sweden
WITTE-Velbert	WITTE-Velbert GmbH & Co. KG, Hoefenstr. 3-15, 42551 Velbert, Germany

Algeria

Agréé par l'ANF
Référence du Certificat de conformité

Homologué par l'ARPC
Référence du Certificat de conformité

Regulatory radio identification

Manufacturer	Model designation	Radio equipment approval number
Continental Antenna	RKE223GNS (locking system)	71/H/ANF/2021
Continental Automotive	CMKG1 (locking system)	122/H/ANF/2021
Continental Automotive	MARS Keyless (locking system)	122/H/ANF/2021
HELLA	DM4 (locking system)	123/H/ANF/2021
Hirschmann	920287A (locking system)	106/H/ANF/2020
Hirschmann	920287B (locking system)	107/H/ANF/2020

Manufacturer	Model designation	Radio equipment approval number
Hirschmann	920702A (locking system)	133/H/ANF/2022
LEOPOLD KOSTAL	KK1 (locking system)	172/H/ANF/2021
MARQUARDT	DC12A (locking system)	188/H/ANF/2021
MARQUARDT	DC12B (locking system)	189/H/ANF/2021
MARQUARDT	DC12K (locking system)	190/H/ANF/2021
MARQUARDT	MS5 (locking system)	195/H/ANF/2021
MARQUARDT	MK1 (locking system)	193/H/ANF/2021

Manufacturer	Model designation	Radio equipment approval number
MARQUARDT	MK2 (locking system)	194/H/ANF/2021
MARQUARDT	3350.38 (locking system)	186/H/ANF/2021
Schrader	AG5SP4 (tyre pressure sensor)	3681/1-73.0 A 1639/DT/DG/ARPT/15
Schrader	AG3PF4 (tyre pressure sensor)	652/1/DT/DG/ARPCE/2020
Schrader	BG3FP4 (tyre pressure sensor)	56/H/ANF/2021

Manufacturer	Model designation	Radio equipment approval number
Schrader	GG4T (tyre pressure sensor)	3994/1.69-DA/ 2098/DT/DG/ARPT/17
Schrader	DG6W2D4 (tyre pressure sensor)	2695/1-NO.431396/ DT/DG/ARPT/17
Huf Baolong	TSSRE4A (tyre pressure sensor)	2695/1-NO.431396/ DT/DG/ARPT/17
WITTE-Velbert	SDHTAG3NFC (locking system)	32/H/ANF/2021

Argentina

Regulatory radio identification



Manufacturer	Model designation	Radio equipment approval number
Continental Antenna	RKE213E1 (aerial amplifier)	H-26206
Continental Antenna	RKE223E1 (aerial amplifier)	H-24637
Continental Automotive	CMKG1 (locking system)	H-24376
Continental Automotive	MARS Keyless (locking system)	H-17929



Manufacturer	Model designation	Radio equipment approval number
Continental Automotive	D-WMI2020A (control unit)	H-23974
HELLA	DM4 (locking system)	H-17845
Hirschmann	920287A (locking system)	H-15694
Hirschmann	920287B (locking system)	H-15695
Hirschmann	920702A (locking system)	H-28310



Manufacturer	Model designation	Radio equipment approval number
Huf Baolong	TSSRE4A (tyre pressure sensor)	H-20027
HUF	HUF14632 (locking system)	H-15541
HUF	HUF4761 (locking system)	H-11545
LEOPOLD KOSTAL	KK1 (locking system)	H-16874
MARQUARDT	DC12A (locking system)	H-17689
MARQUARDT	DC12B (locking system)	H-21034



Manufacturer	Model designation	Radio equipment approval number
MARQUARDT	DC12K (locking system)	H-21035
MARQUARDT	MS2 (locking system)	H-17598
MARQUARDT	MS4 (locking system)	H-23101
MARQUARDT	MS5 (locking system)	H-24933
MARQUARDT	MK1 (locking system)	H-17213
MARQUARDT	MK2 (locking system)	H-17212



Manufacturer	Model designation	Radio equipment approval number
MARQUARDT	3350.38 (locking system)	H-23166
Schrader	AG5SP4 (tyre pressure sensor)	H-4788
Schrader	AG3PF4 (tyre pressure sensor)	H-23292
Schrader	BG3FP4 (tyre pressure sensor)	H-25586
Schrader	GG4T (tyre pressure sensor)	H-20495



Manufacturer	Model designation	Radio equipment approval number
Schrader	DG6W2D4 (tyre pressure sensor)	H-20959
WITTE-Velbert	SDHTAG3NFC (locking system)	H-24664

Australia

Regulatory radio identification



Manufacturer	Model designation
ADC	ARS4-A (radar sensor)
ADC	ARS4-C (radar sensor)
Bosch	MRR1Rear (radar sensor)
Bosch	MRRre14FCR (radar sensor)
Bosch	FR5CPCCF (radar sensor)
Continental Antenna	RKE213E1 (aerial amplifier)
Continental Antenna	RKE223E1 (aerial amplifier)



Manufacturer	Model designation
Continental Automotive	CMKG1 (locking system)
Continental Automotive	MARS Keyless (locking system)
Hirschmann	920287A (locking system)
Hirschmann	920287B (locking system)
Hirschmann	920702A (locking system)
Huf Baolong	TSSRE4A (tyre pressure sensor)
LEOPOLD KOSTAL	KK1 (locking system)
MARQUARDT	MK1 (locking system)



Manufacturer	Model designation
MARQUARDT	MK2 (locking system)
MARQUARDT	3350.38 (locking system)
Schrader	AG5SP4 (tyre pressure sensor)
Schrader	AG3PF4 (tyre pressure sensor)
Schrader	BG3FP4 (tyre pressure sensor)
Schrader	GG4T (tyre pressure sensor)
Schrader	DG6W2D4 (tyre pressure sensor)



Manufacturer	Model designation
Veoneer	77V12BSM (radar sensor)
Veoneer	77V12CRN (radar sensor)
Veoneer	77V125CRN (radar sensor)
Veoneer	MMRV1 (radar sensor)

Bahamas

Regulatory radio identification

Manufacturer	Model designation	Radio equipment approval number
ADC	ARS4-A (radar sensor)	URCA_TA_2014_082
ADC	ARS4-C (radar sensor)	URCA_TA_2019_167
Bosch	MRR1Rear (radar sensor)	URCA_TA/2017_184
Bosch	MRRe14FCR (radar sensor)	URCA_TA/2017_157
Bosch	FR5CPCCF (radar sensor)	URCA_TA_2019_195
Continental Automotive	CMKG1 (locking system)	URCA_TA/2020_068

Manufacturer	Model designation	Radio equipment approval number
Continental Automotive	MARS Keyless (locking system)	URCA_TA/2017_119
Continental Antenna	RKE213E1 (aerial amplifier)	UCRA_TA/2016_009
Continental Antenna	RKE223E1GN S (aerial amplifier)	UCRA_TA/2020_032
HELLA	DM4 (locking system)	URCA_TA/2017_078
Hirschmann	920287A (locking system)	URCA_TA/2019_053
Hirschmann	920287B (locking system)	URCA_TA/2019_052

Manufacturer	Model designation	Radio equipment approval number
Hirschmann	920702A (locking system)	URCA_TA/2022_043
HUF	HUF4761 (locking system)	URCA_TA/2015_087
Huf Baolong	TSSRE4A (tyre pressure sensor)	URCA_TA/2017_094
LEOPOLD KOSTAL	KK1 (locking system)	URCA_TA/2015_081
MARQUARDT	DC12A (locking system)	URCA_TA_2017_042
MARQUARDT	DC12B (locking system)	URCA_TA_2019_128
MARQUARDT	DC12K (locking system)	URCA_TA_2019_129

Manufacturer	Model designation	Radio equipment approval number
MARQUARDT	MS2 (locking system)	URCA_TA/2017_021
MARQUARDT	MS4 (locking system)	URCA_TA_2019_141
MARQUARDT	MS5 (locking system)	URCA_TA_2020_141
MARQUARDT	MK1 (locking system)	URCA_TA/2015_031
MARQUARDT	MK2 (locking system)	URCA_TA/2015_033
MARQUARDT	3350.38 (locking system)	URCA_TA/2019_250
Schrader	AG5SP4 (tyre pressure sensor)	URCA_TA_TA/2015_009

Manufacturer	Model designation	Radio equipment approval number
Schrader	AG3PF4 (tyre pressure sensor)	URCA_TA_2019_101
Schrader	BG3FP4 (tyre pressure sensor)	URCA_TA_2021_001
Schrader	GG4T (tyre pressure sensor)	URCA_TA_2020_046
Schrader	DG6W2D4 (tyre pressure sensor)	URCA_TA_2019_247
Veoneer	77V12BSM (radar sensor)	URCA_TA_2019_169
Veoneer	77V12CRN (radar sensor)	URCA_TA_2019_168

Manufacturer	Model designation	Radio equipment approval number
Veoneer	77V125CRN (radar sensor)	URCA_TA_2021_027
Veoneer	MMRV1 (radar sensor)	URCA_TA/2015_063
WITTE-Velbert	SDHTAG3NFC (locking system)	URCA_TA_2020_056

Belarus

Regulatory radio identification



Manufacturer	Model designation
ADC	ARS4-A (radar sensor)
ADC	ARS4-C (radar sensor)



Manufacturer	Model designation
Bosch	MRR1Rear (radar sensor)
Bosch	MRRre14FCR (radar sensor)
Bosch	FR5CPCCF (radar sensor)
Continental Antenna	RKE213E1 (aerial amplifier)
Continental Antenna	RKE223E1GNS (aerial amplifier)
Continental Automotive	CMKG1 (locking system)
Continental Automotive	MARS Keyless (locking system)



Manufacturer	Model designation
Harman Becker	HERMES 3.0 (communication module)
HELLA	DM4 (locking system)
LEOPOLD KOSTAL	KK1 (locking system)
MARQUARDT	DC12A (locking system)
MARQUARDT	DC12B (locking system)
MARQUARDT	DC12K (locking system)
MARQUARDT	MS2 (locking system)
MARQUARDT	MS4 (locking system)
MARQUARDT	MS5 (locking system)



Manufacturer	Model designation
MARQUARDT	MK1 (locking system)
MARQUARDT	MK2 (locking system)
MARQUARDT	3350.38 (locking system)
Veoneer	77V12BSM (radar sensor)
Veoneer	77V12CRN (radar sensor)
Veoneer	77V125CRN (radar sensor)
Veoneer	MMRV1 (radar sensor)
WITTE-Velbert	SDHTAG3NFC (locking system)

Botswana
Regulatory radio identification

Manufacturer	Model designation	Radio equipment approval number
ADC	ARS4-A (radar sensor)	BOCRA/TA/2018/2026
ADC	ARS4-C (radar sensor)	BOCRA/TA/2020/5186
Bosch	MRRre14FCR (radar sensor)	BOCRA/TA/2019/4674
Bosch	FR5CPCCF (radar sensor)	BOCRA/TA/2019/4975
Bosch	MRR1Rear (radar sensor)	BOCRA/TA/2017/3788
Continental Antenna	RKE213E1 (aerial amplifier)	BOCRA/TA/2019/4387

Manufacturer	Model designation	Radio equipment approval number
Continental Antenna	RKE223E1GN S (aerial amplifier)	BOCRA/TA/2019/5050
Continental Automotive	CMKG1 (locking system)	BOCRA/TA/2019/5075
Continental Automotive	MARS Keyless (locking system)	BOCRA/TA/2019/4661
HELLA	DM4 (locking system)	BOCRA/TA/2019/4662
Hirschmann	920287A (locking system)	BOCRA/TA/2019/4724
Hirschmann	920287B (locking system)	BOCRA/TA/2019/4723

Manufacturer	Model designation	Radio equipment approval number
Hirschmann	920702A (locking system)	BOCRA/TA/2022/7099
HUF	HUF4761 (locking system)	BOCRA/TA/2019/4664
LEOPOLD KOSTAL	KK1 (locking system)	BOCRA/TA/2019/4593
MARQUARDT	DC12A (locking system)	BOCRA/TA/2019/4389
MARQUARDT	DC12B (locking system)	BOCRA/TA/2019/4388
MARQUARDT	DC12K (locking system)	BOCRA/TA/2019/4390
MARQUARDT	MS2 (locking system)	BOCRA/TA/2019/5135

Manufacturer	Model designation	Radio equipment approval number
MARQUARDT	MS4 (locking system)	BOCRA/TA/2019/4758
MARQUARDT	MS5 (locking system)	BOCRA/TA/2020/5473
MARQUARDT	MK1 (locking system)	BOCRA/TA/2019/4359
MARQUARDT	MK2 (locking system)	BOCRA/TA/2019/4360
MARQUARDT	3350.38 (locking system)	BOCRA/TA/2019/4687
Veoneer	77V12BSM (radar sensor)	BOCRA/TA/2019/4975
Veoneer	77V12CRN (radar sensor)	BOCRA/TA/2019/4980

Manufacturer	Model designation	Radio equipment approval number
Veoneer	77V125CRN (radar sensor)	BOCRA/TA/2021/6191
WITTE-Velbert	SDHTAG3NFC (locking system)	BOCRA/TA/2020/5342

Brazil

Note on two-way radio systems in the vehicle:

These systems are not protected against harmful interference and must not cause interference in properly approved systems.

Regulatory radio identification

		
Manufacturer	Model designation	Radio equipment approval number
Continental Antenna	RKE223E1 (aerial amplifier)	03691-15-05298
Continental Antenna	RKE213E1 (aerial amplifier)	07359-21-12817
Continental Antenna	RKE213E1 (aerial amplifier)	3691-15-5298
Continental Automotive	CMKG1 (locking system)	00325-20-02149

		
Manufacturer	Model designation	Radio equipment approval number
Continental Automotive	MARS Keyless (locking system)	03189-17-02856
HELLA	DM4 (locking system)	04689-17-05364
Hirschmann	920287A (locking system)	1855-12-5762
Hirschmann	920287B (locking system)	1787-12-8058
HUF	HUF14632 (locking system)	03627-15-06643

		
Manufacturer	Model designation	Radio equipment approval number
HUF	HUF4761 (locking system)	00053-13-06643
LEOPOLD KOSTAL	KK1 (locking system)	02712-15-03366
MARQUARDT	DC12A (locking system)	01333-17-02930
MARQUARDT	DC12B (locking system)	01395-11-02930
MARQUARDT	DC12K (locking system)	01392-11-02930
MARQUARDT	MS2 (locking system)	00616-17-02930

		
Manufacturer	Model designation	Radio equipment approval number
MARQUARDT	MS4 (locking system)	06218-19-02930
MARQUARDT	MS5 (locking system)	11149-20-02930
MARQUARDT	3350.38 (locking system)	03149-19-02930
MARQUARDT	MK1 (locking system)	03756-15-02930



Manufacturer	Model designation	Radio equipment approval number
MARQUARDT	MK2 (locking system)	03757-15-02 930
WITTE-Velbert	SDHTAG3NFC (locking system)	03034-20-07 018

Further specific information

Rear Seat Entertainment System:

This system is not protected against harmful interference and must not cause interference in properly approved systems.

This product is approved by ANATEL in accordance with the procedures set out in Resolution 242/2000 and complies with the relevant technical requirements. Further information can be found on the <https://www.anatel.gov.br>

Brunei Darussalam

Regulatory radio identification





Manufacturer	Model designation	Radio equipment approval number
ADC	ARS4-C (radar sensor)	DTA-004005
Bosch	FR5CPCCF (radar sensor)	DTA-004222
Bosch	LRR3 (radar sensor)	DTA-011039
Bosch	MRR1Rear (radar sensor)	DTA-006601
Bosch	MRRre14FCR (radar sensor)	DTA-006678



Manufacturer	Model designation	Radio equipment approval number
Continental Antenna	RKE213E1 (aerial amplifier)	DTA-006665
Continental Antenna	RKE223E1GN S (aerial amplifier)	DTA-004998
Continental Automotive	CMKG1 (locking system)	DTA-005043
Continental Automotive	MARS Keyless (locking system)	DTA-017264
HELLA	DM4 (locking system)	DTA-000351

		
Manufacturer	Model designation	Radio equipment approval number
Hirschmann	920287A (locking system)	DTA-001661
Hirschmann	920287B (locking system)	DTA-000794
Hirschmann	920702A (locking system)	DTA-018051
Huf Baolong	TSSRE4A (tyre pressure sensor)	DTA-000310

		
Manufacturer	Model designation	Radio equipment approval number
Huf Baolong	TSSSG4G6b (tyre pressure monitoring system control unit)	DTA-003757
HUF	HUF14632 (locking system)	DTA-006138
HUF	HUF4761 (locking system)	DTA-000615
LEOPOLD KOSTAL	KK1 (locking system)	DTA-007245

		
Manufacturer	Model designation	Radio equipment approval number
MARQUARDT	DC12A (locking system)	LPD-38937
MARQUARDT	DC12B (locking system)	DTA-000068
MARQUARDT	DC12K (locking system)	DTA-000066
MARQUARDT	MS2 (locking system)	LPD-38890
MARQUARDT	MS4 (locking system)	DTA-003525
MARQUARDT	MS5 (locking system)	DTA-005850



Manufacturer	Model designation	Radio equipment approval number
MARQUARDT	MK1 (locking system)	DTA-011312
MARQUARDT	MK2 (locking system)	DTA-011313
MARQUARDT	3350.38 (locking system)	DTA-003662
Schrader	AG5SP4 (tyre pressure sensor)	LPD-29665
Schrader	AG3PF4 (tyre pressure sensor)	LPD-29665



Manufacturer	Model designation	Radio equipment approval number
Schrader	BG3FP4 (tyre pressure sensor)	DRQ-D-JATI-07-2000-109000
Schrader	DG6W2D4 (tyre pressure sensor)	DTA-001514
Schrader	MFR (tyre pressure monitoring system control unit)	DTA No. 003893



Manufacturer	Model designation	Radio equipment approval number
Schrader	MFR3 (tyre pressure monitoring system control unit)	DRQ-D-MAJU-02-2011-111083
Veoneer	77V12BSM (radar sensor)	DTA-004000
Veoneer	77V12CRN (radar sensor)	DTA-003999
Veoneer	77V125CRN (radar sensor)	DTA-010423



Manufacturer	Model designation	Radio equipment approval number
Veoneer	77GHz MMRV1 (radar sensor)	DTA-006216
WITTE-Velbert	SDHTAG3NFC (locking system)	DTA-005628

Eurasian Economic Union

Regulatory radio identification



Manufacturer

ADC

ADC

Bosch

Bosch

Bosch

Bosch

Continental Antenna



Model designation

ARS4-A (radar sensor)

ARS4-C (radar sensor)

FR5CPCCF (radar sensor)

LRR3 (radar sensor)

MRR1Rear (radar sensor)

MRRe14FCR (radar sensor)

RKE213E1 (aerial amplifier)



Manufacturer

Continental Antenna

Continental Automotive

Continental Automotive

HELLA

Hirschmann

Hirschmann

Hirschmann



Model designation

RKE223E1GNS (aerial amplifier)

MARS Keyless (locking system)

CMKG1 (locking system)

DM4 (locking system)

920287A (locking system)

920287B (locking system)

920702A (locking system)



Manufacturer	Model designation
Huf Baolong	TSSRE4A (tyre pressure sensor)
HUF	HUF4761 (locking system)
HUF	HUF14632 (locking system)
LEOPOLD KOSTAL	KK1 (locking system)
MARQUARDT	DC12A (locking system)
MARQUARDT	DC12B (locking system)
MARQUARDT	DC12K (locking system)
MARQUARDT	MS2 (locking system)



Manufacturer	Model designation
MARQUARDT	MS4 (locking system)
MARQUARDT	MS5 (locking system)
MARQUARDT	MK1 (locking system)
MARQUARDT	MK2 (locking system)
MARQUARDT	3350.38 (locking system)
Schrader	AG5SP4 (tyre pressure sensor)
Schrader	AG3PF4 (tyre pressure sensor)
Schrader	BG3FP4 (tyre pressure sensor)



Manufacturer	Model designation
Schrader	GG4T (tyre pressure sensor)
Schrader	DG6W2D4 (tyre pressure sensor)
Veoneer	77GHz MMRV1 (radar sensor)
Veoneer	77V12BSM (radar sensor)
Veoneer	77V12CRN (radar sensor)
Veoneer	77V125CRN (radar sensor)
WITTE-Velbert	SDHTAG3NFC (locking system)

Ghana

Regulatory radio identification

Manufacturer	Model designation	Radio equipment approval number
		NCA APPROVED
ADC	ARS4-C (radar sensor)	ZRO-1H-7E3-152
Bosch	FR5CPCCF (radar sensor)	ZRO-M8-7E3-230
Continental Antenna	RKE213E1 (aerial amplifier)	ZRO-M8-7E3-X53
Continental Antenna	RKE223E1GN S (aerial amplifier)	ZRO-M8-7E3-225
Continental Automotive	CMKG1 (locking system)	ZRO-M8-7E3-277



Manufacturer	Model designation	Radio equipment approval number
Continental Automotive	MARS Keyless (locking system)	BR3-1M-GE2-16A
HELLA	DM4 (locking system)	BR3-1M-GE2-157
Hirschmann	920287A (locking system)	ZRO-M8-7E3-X45
Hirschmann	920287B (locking system)	ZRO-M8-7E3-X47
Hirschmann	920702A (locking system)	7E6-M1-XA4-SRD
HUF	HUF4761 (locking system)	EX6-6M-GE2-16C



Manufacturer	Model designation	Radio equipment approval number
LEOPOLD KOSTAL	KK1 (locking system)	ZRO-M8-7E3-X49
MARQUARDT	DC12A (locking system)	ZRO-M8-7E3-X50
MARQUARDT	DC12B (locking system)	ZRO-M8-7E3-X51
MARQUARDT	DC12K (locking system)	ZRO-M8-7E3-X52
MARQUARDT	MS2 (locking system)	BR3-1M-GE-129
MARQUARDT	MS4 (locking system)	ZRO-1H-7E3-26E
MARQUARDT	MS5 (locking system)	SRO-1M-7E4-11B
MARQUARDT	MK1 (locking system)	ZRO-M8-7E3-X4A



Manufacturer	Model designation	Radio equipment approval number
MARQUARDT	MK2 (locking system)	ZRO-M8-7E3-X4C
MARQUARDT	3350.38 (locking system)	ZRO-M8-7E3-X3C
Veoneer	77V12BSM (radar sensor)	ZRO-1H-7E3-142
Veoneer	77V12CRN (radar sensor)	ZRO-M8-7E3-230
Veoneer	77V125CRN (radar sensor)	7E5-7M-X72-RDR
WITTE-Velbert	SDHTAG3NFC (locking system)	SRO-1M-7E4-X59

Indonesia

Regulatory radio identification



Manufacturer	Model designation	Radio equipment approval number
ADC	ARS4-C (radar sensor)	68676/SDPPI/20207163 
ADC	ARS4-A (radar sensor)	70266/SDPPI/20207163 

Manufacturer	Model designation	Radio equipment approval number
Bosch	LRR3 (radar sensor)	74264/SDPPI/20217163 
Bosch	MRR1Rear (radar sensor)	74267/SDPPI/20217163 

Manufacturer	Model designation	Radio equipment approval number
Bosch	MRRevo14F (radar sensor)	74265/ SDPPI/2021 7163 
Bosch	MRRe14FCR (radar sensor)	74266/ SDPPI/2021 7163 

Manufacturer	Model designation	Radio equipment approval number
Bosch	FR5CPCCF (radar sensor)	67882/ SDPPI/2020 7163  Dilarang melakukan perubahan spesifikasi yang dapat menimbulkan gangguan fisik dan/atau elektromagnetik terhadap lingkungan sekitarnya



Manufacturer	Model designation	Radio equipment approval number
		

Manufacturer	Model designation	Radio equipment approval number	Manufacturer	Model designation	Radio equipment approval number	Manufacturer	Model designation	Radio equipment approval number
Continental Antenna	RKE213E1 (aerial amplifier)	76621 / SDPPI/2021 7163  Dilarang melakukan perubahan spesifikasi yang dapat menimbulkan gangguan fisik dan/atau elektromagnetik terhadap lingkungan sekitarnya				Continental Antenna	RKE223E1GN S (aerial amplifier)	66185 / SDPPI/2020 10325  Dilarang melakukan perubahan spesifikasi yang dapat menimbulkan gangguan fisik dan/atau elektromagnetik terhadap lingkungan sekitarnya

Manufacturer	Model designation	Radio equipment approval number
		

Manufacturer	Model designation	Radio equipment approval number
Continental Automotive	CMKG1 (locking system)	66911 / SDPPI/2020 7163  Dilarang melakukan perubahan spesifikasi yang dapat menimbulkan gangguan fisik dan/atau elektromagnetik terhadap lingkungan sekitarnya



Manufacturer	Model designation	Radio equipment approval number
		

Manufacturer	Model designation	Radio equipment approval number	Manufacturer	Model designation	Radio equipment approval number	Manufacturer	Model designation	Radio equipment approval number
Continental Automotive	MARS Keyless (locking system)	69379 / SDPPI/2020 7163 				Continental Automotive	D-WMI2020A (control unit)	66678 / SDPPI/2020 7163 
		Dilarang melakukan perubahan spesifikasi yang dapat menimbulkan gangguan fisik dan/atau elektromagnetik terhadap lingkungan sekitarnya						Dilarang melakukan perubahan spesifikasi yang dapat menimbulkan gangguan fisik dan/atau elektromagnetik terhadap lingkungan sekitarnya

Manufacturer	Model designation	Radio equipment approval number
		

Manufacturer	Model designation	Radio equipment approval number
Continental Automotive	NTG7 MID (Headunit)	70732/ SDPPI/2020 7163  Dilarang melakukan perubahan spesifikasi yang dapat menimbulkan gangguan fisik dan/atau elektromagnetik terhadap lingkungan sekitarnya



Manufacturer	Model designation	Radio equipment approval number
		

Manufacturer	Model designation	Radio equipment approval number	Manufacturer	Model designation	Radio equipment approval number	Manufacturer	Model designation	Radio equipment approval number
Continental Automotive	NTG7 HIGH (Headunit)	70733 / SDPPI/2020 7163  Dilarang melakukan perubahan spesifikasi yang dapat menimbulkan gangguan fisik dan/atau elektromagnetik terhadap lingkungan sekitarnya				Continental Automotive	NTG7 PREMIUM (Headunit)	70731 / SDPPI/2020 7163  Dilarang melakukan perubahan spesifikasi yang dapat menimbulkan gangguan fisik dan/atau elektromagnetik terhadap lingkungan sekitarnya

Manufacturer	Model designation	Radio equipment approval number
		

Manufacturer	Model designation	Radio equipment approval number
Continental Automotive	NTG7 PREMIUM PLUS (Headunit)	70734/SDPPI/2020 7163  Dilarang melakukan perubahan spesifikasi yang dapat menimbulkan gangguan fisik dan/atau elektromagnetik terhadap lingkungan sekitarnya

Manufacturer	Model designation	Radio equipment approval number
		

Manufacturer	Model designation	Radio equipment approval number	Manufacturer	Model designation	Radio equipment approval number	Manufacturer	Model designation	Radio equipment approval number
Harman Becker	NTG6N ENTRY/MID (Headunit) Production: Germany	64019/ SDPPI/2019 7163  Dilarang melakukan perubahan spesifikasi yang dapat menimbulkan gangguan fisik dan/atau elektromagnetik terhadap lingkungan sekitarnya				Harman Becker	NTG6N HIGH (Headunit) Production: Germany	64018/ SDPPI/2019 7163  Dilarang melakukan perubahan spesifikasi yang dapat menimbulkan gangguan fisik dan/atau elektromagnetik terhadap lingkungan sekitarnya

Manufacturer	Model designation	Radio equipment approval number
		

Manufacturer	Model designation	Radio equipment approval number
Harman Becker	NTG6N ENTRY/MID (Headunit) Production: Hungary	63775/ SDPPI/2019 7163  Dilarang melakukan perubahan spesifikasi yang dapat menimbulkan gangguan fisik dan/atau elektromagnetik terhadap lingkungan sekitarnya

Manufacturer	Model designation	Radio equipment approval number
		

Manufacturer	Model designation	Radio equipment approval number
Harman Becker	NTG6N HIGH (Headunit) Production: Hungary	63774/ SDPPI/2019 7163  Dilarang melakukan perubahan spesifikasi yang dapat menimbulkan gangguan fisik dan/atau elektromagnetik terhadap lingkungan sekitarnya



Manufacturer	Model designation	Radio equipment approval number
		

Manufacturer	Model designation	Radio equipment approval number
Harman Becker	NTG7 MID (Headunit)	65544/ SDPPI/2020 7163  Dilarang melakukan perubahan spesifikasi yang dapat menimbulkan gangguan fisik dan/atau elektromagnetik terhadap lingkungan sekitarnya

Manufacturer	Model designation	Radio equipment approval number
		

Manufacturer	Model designation	Radio equipment approval number
Harman Becker	NTG7 HIGH (Headunit)	70513/ SDPPI/2020 7163  Dilarang melakukan perubahan spesifikasi yang dapat menimbulkan gangguan fisik dan/atau elektromagnetik terhadap lingkungan sekitarnya





Manufacturer	Model designation	Radio equipment approval number
		

Manufacturer	Model designation	Radio equipment approval number	Manufacturer	Model designation	Radio equipment approval number	Manufacturer	Model designation	Radio equipment approval number
Harman Becker	NTG7 PRE- MIUM (Headunit)	65543/ SDPPI/2020 7163  Dilarang melakukan perubahan spesifikasi yang dapat menimbulkan gangguan fisik dan/atau elektromagnetik terhadap lingkungan sekitarnya				Harman Becker	NTG7 PRE- MIUM PLUS (Headunit)	70512/ SDPPI/2020 7163  Dilarang melakukan perubahan spesifikasi yang dapat menimbulkan gangguan fisik dan/atau elektromagnetik terhadap lingkungan sekitarnya

Manufacturer	Model designation	Radio equipment approval number
		

Manufacturer	Model designation	Radio equipment approval number
Harman Becker	NTG7 RSU (control unit)	66387/ SDPPI/2020 7163  Dilarang melakukan perubahan spesifikasi yang dapat menimbulkan gangguan fisik dan/atau elektromagnetik terhadap lingkungan sekitarnya



Manufacturer	Model designation	Radio equipment approval number
		

Manufacturer	Model designation	Radio equipment approval number	Manufacturer	Model designation	Radio equipment approval number	Manufacturer	Model designation	Radio equipment approval number
HELLA	DM4 (locking system)	69378 / SDPPI/2020 7163  Dilarang melakukan perubahan spesifikasi yang dapat menimbulkan gangguan fisik dan/atau elektromagnetik terhadap lingkungan sekitarnya				Hirschmann	920287A (locking system)	71369 / SDPPI/2020 7163  Dilarang melakukan perubahan spesifikasi yang dapat menimbulkan gangguan fisik dan/atau elektromagnetik terhadap lingkungan sekitarnya
			Huf Baolong	TSSRE4A (tyre pressure sensor)	72438 / SDPPI/2021 7163 			

Manufacturer	Model designation	Radio equipment approval number
		

Manufacturer	Model designation	Radio equipment approval number
Hirschmann	920287B (locking system)	72974 / SDPPI/2021 7163  Dilarang melakukan perubahan spesifikasi yang dapat menimbulkan gangguan fisik dan/atau elektromagnetik terhadap lingkungan sekitarnya



Manufacturer	Model designation	Radio equipment approval number
		

Manufacturer	Model designation	Radio equipment approval number	Manufacturer	Model designation	Radio equipment approval number	Manufacturer	Model designation	Radio equipment approval number
Hirschmann	920702A (locking system)	82675/ SDPPI/2022 7163  Dilarang melakukan perubahan spesifikasi yang dapat menimbulkan gangguan fisik dan/atau elektromagnetik terhadap lingkungan sekitarnya				HUF	HUF14632 (locking system)	78368/ SDPPI/2021 7163  Dilarang melakukan perubahan spesifikasi yang dapat menimbulkan gangguan fisik dan/atau elektromagnetik terhadap lingkungan sekitarnya

Manufacturer	Model designation	Radio equipment approval number
		

Manufacturer	Model designation	Radio equipment approval number
HUF	HUF4761 (locking system)	26742/ SDPPI/2015 3533  Dilarang melakukan perubahan spesifikasi yang dapat menimbulkan gangguan fisik dan/atau elektromagnetik terhadap lingkungan sekitarnya



Manufacturer	Model designation	Radio equipment approval number
		

Manufacturer	Model designation	Radio equipment approval number	Manufacturer	Model designation	Radio equipment approval number	Manufacturer	Model designation	Radio equipment approval number
HUF	HUF13145 (NFC reader)	83988/ SDPPI/2022  Dilarang melakukan perubahan spesifikasi yang dapat menimbulkan gangguan fisik dan/atau elektromagnetik terhadap lingkungan sekitarnya	LEOPOLD KOSTAL	KK1 (locking system)	41121/ SDPPI/2018 5125	MARQUARDT	DC12A (locking system)	67373/ SDPPI/2020 7163  Dilarang melakukan perubahan spesifikasi yang dapat menimbulkan gangguan fisik dan/atau elektromagnetik terhadap lingkungan sekitarnya

Manufacturer	Model designation	Radio equipment approval number
		

Manufacturer	Model designation	Radio equipment approval number
MARQUARDT	DC12B (locking system)	80676/ SDPPI/2022 7163  Dilarang melakukan perubahan spesifikasi yang dapat menimbulkan gangguan fisik dan/atau elektromagnetik terhadap lingkungan sekitarnya



Manufacturer	Model designation	Radio equipment approval number
		

Manufacturer	Model designation	Radio equipment approval number	Manufacturer	Model designation	Radio equipment approval number	Manufacturer	Model designation	Radio equipment approval number
MARQUARDT	DC12K (locking system)	80621 / SDPPI/2022 7163  Dilarang melakukan perubahan spesifikasi yang dapat menimbulkan gangguan fisik dan/atau elektromagnetik terhadap lingkungan sekitarnya				MARQUARDT	MS2 (locking system)	67372 / SDPPI/2020 7163  Dilarang melakukan perubahan spesifikasi yang dapat menimbulkan gangguan fisik dan/atau elektromagnetik terhadap lingkungan sekitarnya

Manufacturer	Model designation	Radio equipment approval number
		

Manufacturer	Model designation	Radio equipment approval number
MARQUARDT	MS4 (locking system)	64126/ SDPPI/2019 7163  Dilarang melakukan perubahan spesifikasi yang dapat menimbulkan gangguan fisik dan/atau elektromagnetik terhadap lingkungan sekitarnya



Manufacturer	Model designation	Radio equipment approval number
		

Manufacturer	Model designation	Radio equipment approval number	Manufacturer	Model designation	Radio equipment approval number	Manufacturer	Model designation	Radio equipment approval number
MARQUARDT	MS5 (locking system)	69077/ SDPPI/2020 7163 7163  Dilarang melakukan perubahan spesifikasi yang dapat menimbulkan gangguan fisik dan/atau elektromagnetik terhadap lingkungan sekitarnya				MARQUARDT	MK1 (locking system)	75282/ SDPPI/ 2021 7163  Dilarang melakukan perubahan spesifikasi yang dapat menimbulkan gangguan fisik dan/atau elektromagnetik terhadap lingkungan sekitarnya

Manufacturer	Model designation	Radio equipment approval number
		

Manufacturer	Model designation	Radio equipment approval number
MARQUARDT	MK2 (locking system)	75285/ SDPPI/ 2021 7163  Dilarang melakukan perubahan spesifikasi yang dapat menimbulkan gangguan fisik dan/atau elektromagnetik terhadap lingkungan sekitarnya



Manufacturer	Model designation	Radio equipment approval number
		



Manufacturer	Model designation	Radio equipment approval number	Manufacturer	Model designation	Radio equipment approval number	Manufacturer	Model designation	Radio equipment approval number
MARQUARDT	3350.38 (locking system)	82980/ SDPPI/2022 7163  Dilarang melakukan perubahan spesifikasi yang dapat menimbulkan gangguan fisik dan/atau elektromagnetik terhadap lingkungan sekitarnya				Molex	WCH-302b (control unit)	71668/ SDPPI/2020 7163  Dilarang melakukan perubahan spesifikasi yang dapat menimbulkan gangguan fisik dan/atau elektromagnetik terhadap lingkungan sekitarnya

Manufacturer	Model designation	Radio equipment approval number
		



Manufacturer	Model designation	Radio equipment approval number
Molex	WCH-302d (control unit)	71220/ SDPPI/2020 7163  Dilarang melakukan perubahan spesifikasi yang dapat menimbulkan gangguan fisik dan/atau elektromagnetik terhadap lingkungan sekitarnya

Manufacturer	Model designation	Radio equipment approval number
		

Manufacturer	Model designation	Radio equipment approval number	Manufacturer	Model designation	Radio equipment approval number	Manufacturer	Model designation	Radio equipment approval number
Molex	WCH-302e (control unit)	71669/ SDPPI/2020 7163  Dilarang melakukan perubahan spesifikasi yang dapat menimbulkan gangguan fisik dan/atau elektromagnetik terhadap lingkungan sekitarnya				Panasonic	DAIRSE (control unit)	63550/ SDPPI/2019  Dilarang melakukan perubahan spesifikasi yang dapat menimbulkan gangguan fisik dan/atau elektromagnetik terhadap lingkungan sekitarnya

Manufacturer	Model designation	Radio equipment approval number
		
Schrader	GG4T (tyre pressure sensor)	72023/ SDPPI/2020 9338
Schrader	AG5SP4 (tyre pressure sensor)	75465/ SDPPI/2021 7163 

Manufacturer	Model designation	Radio equipment approval number
Schrader	BG3FP4 (tyre pressure sensor)	72765/ SDPP/2021 7163 
Schrader	DG6W2D4 (tyre pressure sensor)	57058/ SDPPI/2018 3612
Schrader	MC34MA4 (tyre pressure monitoring system control unit)	25626/ SDPPI/2015 3612

Manufacturer	Model designation	Radio equipment approval number
Schrader	AG3PF4 (tyre pressure sensor)	62396/ SDPPI/2020 7163 
Schrader	GG4T (tyre pressure sensor)	72023/ SDPPI/2020 7163 

Manufacturer	Model designation	Radio equipment approval number
Veoneer	77GHz MMRV1 (radar sensor)	74749/ SDPPI/2021 7163
Veoneer	77V12CRN (radar sensor)	66830/ SDPPI/2020 7163 

Manufacturer	Model designation	Radio equipment approval number
Veoneer	77V125CRN (radar sensor)	78366/ SDPPI/2021 7163 

Manufacturer	Model designation	Radio equipment approval number
Veoneer	77V12BSM (radar sensor)	66792/ SDPPI/2020 7163 

Manufacturer	Model designation	Radio equipment approval number
WITTE-Velbert	SDHTAG3NFC (locking system)	67233/ SDPPI/2020 10325  Dilarang melakukan perubahan spesifikasi yang dapat menimbulkan gangguan fisik dan/atau elektromagnetik terhadap lingkungan sekitarnya

Manufacturer	Model designation	Radio equipment approval number
		

Israel

Regulatory radio identification

Manufacturer	Model designation	Radio equipment approval number
		Approval number of the Ministry of Communications:
ADC	ARS4-A (radar sensor)	55-09697

Manufacturer	Model designation	Radio equipment approval number
ADC	ARS4-C (radar sensor)	55-07525
Bosch	FR5CPCCF (radar sensor)	55-08783
Bosch	LRR3 (radar sensor)	55-08334
Bosch	MRR1Rear (radar sensor)	55-08333
Bosch	MRRre14FCR (radar sensor)	55-08395
Continental Antenna	RKE213E1 (aerial amplifier)	55-08395
Continental Automotive	D-WMI2017B (control unit)	51-75654

Manufacturer	Model designation	Radio equipment approval number
Continental Automotive	D-WMI2017A (control unit)	51-75367
Continental Automotive	D-WMI2016A (control unit)	55-08177
Continental Automotive	D-WMI2020A (control unit)	55-08179
Continental Automotive	RKE213E1 (Antennenverstärker)	55-13929
Continental Automotive	RKE223E1GNS (Antennenverstärker)	51-70799
Continental Automotive	CMKG1 (Schließsystem)	51-75924

Manufacturer	Model designation	Radio equipment approval number
Continental Automotive	MARS Keyless (Schließsystem)	55-13749
Hirschmann	920287A (Schließsystem)	51-62759
Hirschmann	920287B (Schließsystem)	51-49357
Hirschmann	920702A (Schließsystem)	55-12320
Huf Baolong	TSSRE4A (tyre pressure sensor)	63-63571

Manufacturer	Model designation	Radio equipment approval number
Huf Baolong	TSSSG4G6b (tyre pressure monitoring system control unit)	63-66757
LEOPOLD KOSTAL	KK1 (locking system)	51-75788
MARQUARDT	MK1 (locking system)	55-09027
MARQUARDT	MK2 (locking system)	55-09028
MARQUARDT	3350.38 (locking system)	55-14331
Schrader	AG3PF4 (tyre pressure sensor)	51-78338

Manufacturer	Model designation	Radio equipment approval number
Schrader	AG5SP4 (tyre pressure sensor)	51-73152
Schrader	BG3FP4 (tyre pressure sensor)	51-77898
Schrader	DG6W2D4 (tyre pressure sensor)	51-64111
Schrader	GG4T (tyre pressure sensor)	55-09441
Schrader	MC34MA4 (tyre pressure monitoring system control unit)	51-29611

Manufacturer	Model designation	Radio equipment approval number
Schrader	MFR (tyre pressure monitoring system control unit)	55-06040
Schrader	MFR3 (tyre pressure monitoring system control unit)	51-79817
Veoneer	77V12BSM (radar sensor)	55-08176
Veoneer	77V12CRN (radar sensor)	55-08301

Jamaica

Regulatory radio identification

Manufacturer	Model designation
Continental Automotive	CMKG1 (locking system)
Continental Automotive	RKE213E1 (aerial amplifier)
Continental Automotive	RKE223E1GNS (aerial amplifier)
Continental Automotive	MARS Keyless (locking system)
Hirschmann	920287A (locking system)
Hirschmann	920287B (locking system)
Hirschmann	920702A (locking system)
HELLA	DM4 (locking system)

Manufacturer	Model designation
LEOPOLD KOSTAL	KK1 (locking system)
MARQUARDT	DC12A (locking system)
MARQUARDT	DC12B (locking system)
MARQUARDT	DC12K (locking system)
MARQUARDT	MS2 (locking system)
MARQUARDT	MS4 (locking system)
MARQUARDT	MS5 (locking system)
MARQUARDT	MK1 (locking system)
MARQUARDT	MK2 (locking system)
MARQUARDT	3350.38 (locking system)
WITTE-Velbert	SDHTAG3NFC (locking system)

Japan

Regulatory radio identification



Manufacturer	Model designation	Radio equipment approval number
Sennheiser	M3IETW2R (Earbud)	201-190814 (R)
Sennheiser	M3IETW2L (Earbud)	201-190815 (L)
Sennheiser	BTT100 (Bluetooth Audio Transmitter)	020-180077

Canada

Regulatory radio identification

Manufacturer	Model designation	Radio equipment approval number
Sennheiser	M3IETW2R (Earbud)	IC:2099A-M3IETW2R
Sennheiser	M3IETW2L (Earbud)	IC:2099A-M3IETW2L
Sennheiser	BTT100 (Bluetooth Audio Transmitter)	IC:2099A-BTT100
Sennheiser	M3IETW2 C (Charging Case)	CAN ICS-3(B)/NMB-3(B)

Kuwait

Regulatory radio identification

Manufacturer	Model designation	Radio equipment approval number
Sennheiser	M3IETW2 (Momentum True Wireless 2)	Ref. 4870
Sennheiser	BTT100 (Bluetooth Audio Transmitter)	Ref. 4871

Malaysia

Regulatory radio identification

		
Manufacturer	Model designation	Radio equipment approval number
ADC	ARS4-C (radar sensor)	HIDF15000153
Bosch	FR5CPCCF (radar sensor)	CIDF15000490
Bosch	LRR3 (radar sensor)	CIDF15000490
Bosch	MRR1Rear (radar sensor)	CIDF15000490
Bosch	MRR14FCR (radar sensor)	CIDF15000490

		
Manufacturer	Model designation	Radio equipment approval number
Bosch	MRRevo14F (radar sensor)	CIDF15000490
Continental Antenna	RKE213E1 (aerial amplifier)	HIDF15000153
Continental Antenna	RKE223E1GN S (aerial amplifier)	HIDF16000136
Continental Automotive	CMKG1 (locking system)	HIDF15000153
Continental Automotive	MARS Keyless (locking system)	CIDF15000578



Manufacturer	Model designation	Radio equipment approval number
Continental Automotive	UWBTRX1 (locking system)	HIDF15000153
Continental Automotive	D-WMI2020A (control unit)	RGEZ/12A/1019/S(19-4128)
HELLA	DM4 (locking system)	CIDF15000578
Hirschmann	920287A (locking system)	RAUU/63A/0311/S(11-0432)
Hirschmann	920287B (locking system)	RAUU/22C/0615/S(15-1864)



Manufacturer	Model designation	Radio equipment approval number
Huf Baolong	TSSRE4A (tyre pressure sensor)	CIDF17000184
HUF	HUF14632 (locking system)	RAYN/25A/0715/S(15-2385)
HUF	HUF4761 (locking system)	RAAU/16B/1112/S(12-2053)
LEOPOLD KOSTAL	KK1 (locking system)	HIDF15000153
MARQUARDT	DC12A (locking system)	RDDK/33A/0317/S(17-0669)



Manufacturer	Model designation	Radio equipment approval number
MARQUARDT	DC12B (locking system)	RAUU/62A/0311/S(11-0263)
MARQUARDT	DC12K (locking system)	RAUU/62A/0311/S(11-0264)
MARQUARDT	MS2 (locking system)	RDDK/31A/0217/S(17-0405)
MARQUARDT	MS4 (locking system)	RDDK/25B/1019/S(19-0943)



Manufacturer	Model designation	Radio equipment approval number
MARQUARDT	MS5 (locking system)	RGLO/02A/0720/S(20-2580)
MARQUARDT	MK1 (locking system)	CIDF19000029
MARQUARDT	MK2 (locking system)	CIDF19000029
MARQUARDT	3350.38 (locking system)	CIDF19000029
Meta System	ITS/TPS (interior protection)	RAVG/18Q/0212/S(11-2068)



Manufacturer	Model designation	Radio equipment approval number
Meta System	MUW II (interior protection)	RAVG/17Q/0212/S(11-2067)
Schrader	AG5SP4 (tyre pressure sensor)	RCDD/03A/0615/S(19-2094)
Schrader	AG3PF4 (tyre pressure sensor)	RBEF/28A/0419/S/(19-1542)
Schrader	BG3FP4 (tyre pressure sensor)	RBEF/51A/0121/S/(20-5642)



Manufacturer	Model designation	Radio equipment approval number
Schrader	MFR (tyre pressure monitoring system control unit)	RAQP/62A/0419/S(19-1694)
Schrader	MFR3 (tyre pressure monitoring system control unit)	RAQP/62A/0419/S(19-1694)
Veoneer	77GHz MMRV1 (radar sensor)	HIDF15000153
Veoneer	77V12BSM (radar sensor)	HIDF15000153



Manufacturer	Model designation	Radio equipment approval number
Veoneer	77V12CRN (radar sensor)	HIDF1500015 3
Veoneer	77V125CRN (radar sensor)	HIDF1500015 3
WITTE-Velbert	SDHTAG3NFC (locking system)	RDDK/43B/ 0420/ S(20-1749)

Morocco

Regulatory radio identification

Manufacturer	Model designation	Radio equipment approval number
		AGREE PAR L'ANRT MAROC
ADC	ARS4-A (radar sensor)	MR 9490 ANTR 2014-07-23
ADC	ARS4-C (radar sensor)	MR 20231 ANRT 2019-06-27
Bosch	FR5CPCCF (radar sensor)	MR 20575 ANRT 2019-07-29
Bosch	LRR3 (radar sensor)	MR 5371 ANRT 2010 2019-12-05

Manufacturer	Model designation	Radio equipment approval number
Bosch	MRR1Rear (radar sensor)	MR 9186 ANTR 2014-04-22
Bosch	MRRre14FCR (radar sensor)	MR 13900 ANTR 2017-05-04
Continental Antenna	RKE213E1 (aerial amplifier)	MR 10631 ANTR 2015-07-16
Continental Antenna	RKE223E1GN S (aerial amplifier)	MR 21174 ANTR 2019-10-14
Continental Automotive	CMKG1 (locking system)	MR 21701 ANTR 2019-12-05
Continental Automotive	MARS Keyless (locking system)	MR 13681 ANTR 2017-04-04

Manufacturer	Model designation	Radio equipment approval number
HELLA	DM4 (locking system)	MR 14426 ANTR 2017-07-28
Hirschmann	920287A (locking system)	MR 6700 ANTR 2011-11-16
Hirschmann	920287B (locking system)	MR 7260 ANTR 2012-06-13
Hirschmann	920702A (locking system)	MR 32214 ANTR 2022-03-08
Huf Baolong	TSSRE4A (tyre pressure monitoring system control unit)	MR 14320 ANTR 2017-07-07

Manufacturer	Model designation	Radio equipment approval number
Huf Baolong	TSSSG4G6b (tyre pressure monitoring system control unit)	MR 19561 ANTR 2019-04-26
HUF	HUF14632 (locking system)	MR 10506 ANTR 2015-06-22
HUF	HUF4761 (locking system)	MR 7829 ANTR 2013-02-14
LEOPOLD KOSTAL	KK1 (locking system)	MR 10697 ANTR 2015-08-05
MARQUARDT	DC12A (locking system)	MR 13429 ANTR 2017-03-03

Manufacturer	Model designation	Radio equipment approval number
MARQUARDT	DC12B (locking system)	MR 6698 ANTR 2021-11-04
MARQUARDT	DC12K (locking system)	MR 6699 ANTR 2021-11-04
MARQUARDT	MS2 (locking system)	MR 13300 ANTR 2017-02-15
MARQUARDT	MS4 (locking system)	MR 19199 ANTR 2019-03-25
MARQUARDT	MS5 (locking system)	MR 23805 ANTR 2020-04-22
MARQUARDT	MK1 (locking system)	MR 10645 ANTR 2015-07-21

Manufacturer	Model designation	Radio equipment approval number
MARQUARDT	MK2 (locking system)	MR 10987 ANTR 2015-10-22
MARQUARDT	3350.38 (locking system)	MR 18817 ANTR 2019-02-12
Schrader	AG5SP4 (tyre pressure monitoring system control unit)	MR 10216 ANRT 2015
Schrader	AG3PF4 (tyre pressure sensor)	MR 19241 ANRT 2019
Schrader	BG3FP4 (tyre pressure sensor)	MR00026829 ANRT2020



Manufacturer	Model designation	Radio equipment approval number
Schrader	MFR (tyre pressure monitoring system control unit)	MR 19527 ANRT 2019-04-30
Schrader	MFR3 (tyre pressure monitoring system control unit)	MR 19527 ANRT 2019
Schrader	GG4T (tyre pressure sensor)	MR 14777 ANRT 2017-09-20
Schrader	DG6W2D4 (tyre pressure sensor)	MR 16355 ANRT 2018-04-19



Manufacturer	Model designation	Radio equipment approval number
Schrader	MC34MA4 (tyre pressure monitoring system control unit)	MR 6706 ANRT 2011-11-17
Veoneer	77GHz MMRV1 (radar sensor)	MR 10436 ANRT 2015-05-25
Veoneer	77V12BSM (radar sensor)	MR 20097 ANRT 2019-06-14
Veoneer	77V12CRN (radar sensor)	MR 20149 ANRT 2019-06-19



Manufacturer	Model designation	Radio equipment approval number
Veoneer	77V125CRN (radar sensor)	MR 27966 ANRT 2021-03-29
WITTE-Velbert	SDHTAG3NFC (locking system)	MR 23310 ANRT 2020-03-10



Mexico



Regulatory radio identification



  		
Manufacturer	Model designation	Radio equipment approval number
ADC	ARS4-A (radar sensor)	IFETEL: RCPCOAR14-1191
ADC	ARS4-C (radar sensor)	IFETEL: RLVCOR19-1062
Bosch	LRR3 (radar sensor)	IFETEL: RCPBOLR09-0828
Bosch	MRR1Rear (radar sensor)	IFETEL: RCPBOMR14-0922



  		
Manufacturer	Model designation	Radio equipment approval number
Bosch	MRRr14FCR (radar sensor)	IFETEL: RCPBOMR17-0598
Continental Antenna	RKE213E1 (aerial amplifier)	IFETEL: RLVKARK15-1741
Continental Antenna	RKE223E1 (aerial amplifier)	IFETEL: RLVCORK19-2174
Continental Automotive	CMKG1 (locking system)	IFETEL: RCPCOM19-2315



		
Manufacturer	Model designation	Radio equipment approval number
Continental Automotive	MARS Keyless (locking system)	IFETEL: RLVDAMA18-1827
Gentex	MUAHL 5 (convenience system)	IFETEL: RCPGEMU15-0448
HELLA	DM4 (locking system)	IFETEL: RLVHEDM17-10
Hirschmann	920287A (locking system)	IFETEL: RLVHI9211-0472



		
Manufacturer	Model designation	Radio equipment approval number
Hirschmann	920287B (locking system)	IFETEL: RLVHI9212-0608
Hirschmann	920702A (locking system)	IFETEL: RLVHI9222-2674
Huf Baolong	TSSRE4A (tyre pressure sensor)	IFETEL: RLVHUTS17-0806
HUF	HUF14632 (locking system)	IFETEL: RLVHUUHU15-1204



		
Manufacturer	Model designation	Radio equipment approval number
HUF	HUF4761 (locking system)	IFETEL: RLVHUUHU12-1587
LEOPOLD KOSTAL	KK1 (locking system)	IFETEL: RLVKOKK15-0891
MARQUARDT	DC12A (locking system)	IFETEL: RLVMEDC17-0348
MARQUARDT	DC12B (locking system)	IFETEL: RLVMA DC11-0446

		
Manufacturer	Model designation	Radio equipment approval number
MARQUARDT	DC12K (interior protection)	IFETEL: RLVADC11-0446
MARQUARDT	MS2 (locking system)	IFETEL: RLVAMS17-0222
MARQUARDT	MS4 (locking system)	IFETEL: RLVAMS19-0449
MARQUARDT	MS5 (locking system)	IFETEL: RLVMEMS20-0957

		
Manufacturer	Model designation	Radio equipment approval number
MARQUARDT	MK1 (locking system)	IFETEL: RLVAMK15-1042
MARQUARDT	MK2 (locking system)	IFETEL: RLVAMK15-1043
MARQUARDT	3350.38 (locking system)	IFETEL: RCPMA3319-0530
Schrader	AG5SP4 (tyre pressure sensor)	IFETEL: RCPSCAG15-0627

		
Manufacturer	Model designation	Radio equipment approval number
Schrader	AG3PF4 (tyre pressure sensor)	IFETEL: RLVSCAG19-0705
Schrader	BG3FP4 (tyre pressure sensor)	IFETEL: RLVSCBG21-0750
Schrader	MFR (tyre pressure sensor)	IFETEL: RLVSCMF15-0959
Schrader	MFR3 (tyre pressure sensor)	IFETEL: RLVSCMF19-0777

		
Manufacturer	Model designation	Radio equipment approval number
Schrader	GG4T (tyre pressure sensor)	IFETEL: RLVSCGG17-1665
Schrader	DG6W2D4 (tyre pressure sensor)	IFETEL: RLVSCDG18-04
Schrader	MC34MA4 (tyre pressure monitoring system control unit)	IFETEL: RCPSCMR14-062
Sennheiser	M3IETW2R (Earbud)	IFETEL: RCPSEM320-0435-A1

		
Manufacturer	Model designation	Radio equipment approval number
Sennheiser	M3IETW2L (Earbud)	IFETEL: RCPSEM320-0435
Sennheiser	BTT100 (Bluetooth Audio Transmitter)	IFETEL: RCPSEBT18-1407
WITTE-Velbert	SDHTAG3NFC (locking system)	IFETEL: RCPWISD20-0943

Mongolia

Regulatory radio identification

		
Manufacturer	Model designation	Radio equipment approval number
Continental Automotive	CMKG1 (locking system)	A19000633
Continental Automotive	MARS Keyless (locking system)	A18000328
HELLA	DM4 (locking system)	A18000329
Hirschmann	920702A (locking system)	A22000649

		
Manufacturer	Model designation	Radio equipment approval number
MARQUARDT	DC12A (locking system)	A19000400
MARQUARDT	DC12B (locking system)	A19000371
MARQUARDT	DC12K (locking system)	A19000372
MARQUARDT	MS2 (locking system)	A18000289
MARQUARDT	MS4 (locking system)	A19000516
MARQUARDT	MS5 (locking system)	A20000085

		
Manufacturer	Model designation	Radio equipment approval number
MARQUARDT	MK1 (locking system)	A19000374
MARQUARDT	MK2 (locking system)	A19000374
MARQUARDT	3350.38 (locking system)	A19000401
WITTE-Velbert	SDHTAG3NFC (locking system)	A20000067

Niger

Regulatory radio identification

Manufacturer	Model designation	Radio equipment approval number
Continental Antenna	RKE213E1 (aerial amplifier)	029 / ARCEP/DG/19
Continental Automotive	MARS Keyless (locking system)	083 / ARCEP/DG/19
HELLA	DM4 (locking system)	082 / ARCEP/DG/19
Hirschmann	920287A (locking system)	097 / ARCEP/DG/19
Hirschmann	920287B (locking system)	098 / ARCEP/DG/19

Manufacturer	Model designation	Radio equipment approval number
HUF	HUF4761 (locking system)	053/ARCEP/DG/19
LEOPOLD KOSTAL	KK1 (locking system)	037/ARCEP/DG/19
MARQUARDT	DC12A (locking system)	010/ARCEP/DG/19
MARQUARDT	DC12B (locking system)	008/ARCEP/DG/19
MARQUARDT	DC12K (locking system)	009/ARCEP/DG/19
MARQUARDT	MS2 (locking system)	014/ARCEP/DG/19

Manufacturer	Model designation	Radio equipment approval number
MARQUARDT	MS4 (locking system)	HOMO-0096/ARCEP/DG/2019
MARQUARDT	MK1 (locking system)	034/ARCEP/DG/19
MARQUARDT	MK2 (locking system)	035/ARCEP/DG/19
MARQUARDT	3350.38 (locking system)	015/ARCEP/DG/19
MARQUARDT	MU1 (locking system)	HOMO-0095/ARCEP/DG/2019

Nigeria

Regulatory radio identification

Manufacturer	Model designation
ADC	ARS4-A (radar sensor)
ADC	ARS4-C (radar sensor)
Bosch	FR5CPCCF (radar sensor)
Bosch	MRR1Rear (radar sensor)
Bosch	MRRre14FCR (radar sensor)
Continental Antenna	RKE213E1 (aerial amplifier)
Continental Antenna	RKE223E1GNS (aerial amplifier)
Continental Automotive	CMKG1 (locking system)

Manufacturer	Model designation
Continental Automotive	MARS Keyless (locking system)
HELLA	DM4 (locking system)
Hirschmann	920287A (locking system)
Hirschmann	920287B (locking system)
Hirschmann	920702A (locking system)
HUF	HUF14632 (locking system)
HUF	HUF4761 (locking system)
LEOPOLD KOSTAL	KK1 (locking system)
MARQUARDT	DC12A (locking system)

Manufacturer	Model designation
MARQUARDT	DC12B (locking system)
MARQUARDT	DC12K (locking system)
MARQUARDT	MS2 (locking system)
MARQUARDT	MS4 (locking system)
MARQUARDT	MS5 (locking system)
MARQUARDT	MK1 (locking system)
MARQUARDT	MK2 (locking system)
MARQUARDT	3350.38 (locking system)
Schrader	AG3PF4 (tyre pressure sensor)
Schrader	BG3FP4 (tyre pressure sensor)
Schrader	MFR3 (control unit)

Manufacturer	Model designation
Veoneer	77V12BSM (radar sensor)
Veoneer	77V12CRN (radar sensor)
Veoneer	77V125CRN (radar sensor)
WITTE-Velbert	SDHTAG3NFC (locking system)

Oman

Regulatory radio identification

Manufacturer	Model designation	Radio equipment approval number
ADC	ARS4-A (radar sensor)	TRA/TA-R/ 2016/14 D080134
ADC	ARS4-C (radar sensor)	TRA/TA-R/ 7769/19 D172338
Bosch	FR5CPCCF (radar sensor)	TRA/TA-R/ 7983/19 D172338
Bosch	LRR3 (radar sensor)	TRA/TA-R/ 1049/09
Bosch	MRR1Rear (radar sensor)	TRA/TA-R/ 1849/14

Manufacturer	Model designation	Radio equipment approval number
Bosch	MRRe14FCR (radar sensor)	TRA/TA-R/ 4353/17
Continental Antenna	RKE213E1 (aerial amplifier)	TRA/TA-R/ 2715/15 D090258
Continental Antenna	RKE223E1GN S (aerial amplifier)	TRA/TA-R/ 8337/19
Continental Automotive	CMKG1 (locking system)	TRA/TA-R/ 8642/19 D172338
Continental Automotive	MARS Keyless (locking system)	TRA/TA-R/ 4158/17 D080134
HELLA	DM4 (locking system)	TRA/TA-R/ 4548/17 D080134

Manufacturer	Model designation	Radio equipment approval number
Hirschmann	920287A (locking system)	TRA/TA-R/ 0210/11 D080353
Hirschmann	920287B (locking system)	TRA/TA-R/ 0655/12 D080353
Hirschmann	920702A (locking system)	TRA/TA-R/ 13300/22 D172338
Huf Baolong	TSSRE4A (tyre pressure sensor)	TRA/TA-R/ 4516/17 D100428
Huf Baolong	TSSSG4G6b (tyre pressure sensor)	TTRA/TA-R/ 7506/19

Manufacturer	Model designation	Radio equipment approval number
HUF	HUF14632 (locking system)	TRA/TA-R/2665/15
HUF	HUF4761 (locking system)	TRA/TA-R/0920/12
LEOPOLD KOSTAL	KK1 (locking system)	TRA/TA-R/3129/16
MARQUARDT	DC12A (locking system)	TRA/TA-RD/4056/17 D100428
MARQUARDT	DC12B (locking system)	TRA/TA-R/0227/11 D080353
MARQUARDT	DC12K (locking system)	TRA/TA-R/0228/11 D080353

Manufacturer	Model designation	Radio equipment approval number
MARQUARDT	MS2 (locking system)	TRA/TA-R/4136/17 D080134
MARQUARDT	MS4 (locking system)	TRA/TA-R/7316/19 D172249
MARQUARDT	MS5 (locking system)	TRA/TA-R/9324/20 D100428
MARQUARDT	MK1 (locking system)	TRA/TA-R/2848/15 D080353
MARQUARDT	MK2 (locking system)	TRA/TA-R/2900/15 D080353

Manufacturer	Model designation	Radio equipment approval number
MARQUARDT	3350.38 (locking system)	TRA/TA-R/7051/19 D172249
Schrader	AG5SP4 (tyre pressure sensor)	TTRA R/2380/15 D080134
Schrader	AG3PF4 (tyre pressure sensor)	TRA R/7287/19 D172338
Schrader	BG3FP4 (tyre pressure sensor)	TRA/TA-R/10694/20 D172338
Schrader	MFR (tyre pressure monitoring system control unit)	TRA/TA-R/7464/19 D090258

Manufacturer	Model designation	Radio equipment approval number
Schrader	MFR3 (tyre pressure monitoring system control unit)	TRA/TA-R/ 7467/19 D090258
Schrader	GG4T (tyre pressure sensor)	TRA/TA-R/ 4686/17 D080134
Schrader	DG6W2D4 (tyre pressure sensor)	TRA/TA-R/ 5511/18 D172249
Sennheiser	M3IETW2R (Earbud)	TRA/TA-R/ 10988/21
Sennheiser	BTT100 (Bluetooth Audio Transmitter)	TRA/TA-R/ 10976/21

Manufacturer	Model designation	Radio equipment approval number
Veoneer	77GHz MMRV1 (radar sensor)	TRA/TA-R/ 2706/15
Veoneer	77V12BSM (radar sensor)	TRA/TA-R/ 7706/19 D172338
Veoneer	77V12CRN (radar sensor)	TRA/TA-R/ 7707/19 D172338
Veoneer	77V125CRN (radar sensor)	TRA/TA-R/ 11335/21 D172338
WITTE-Velbert	SDHTAG3NFC (locking system)	TRA/TA-R/ 9150/20

Pakistan

Regulatory radio identification



Manufacturer	Model designation	Radio equipment approval number
ADC	ARS4-A (radar sensor)	TAC NO: 9.9014/2019
ADC	ARS4-C (radar sensor)	TAC NO: 9.9389/2019
Bosch	FR5CPCCF (radar sensor)	TAC NO: 9.198/2020
Continental Antenna	RKE213E1 (aerial amplifier)	TAC NO: 9.142/2016



Manufacturer	Model designation	Radio equipment approval number
Continental Antenna	RKE223E1GN S (aerial amplifier)	TAC NO: 9.100169/2019
Continental Automotive	CMKG1 (locking system)	TAC NO: 9.100175/2019
Continental Automotive	MARS Keyless (locking system)	TAC NO: 9.213/2017
Continental Automotive	D-WMI2020A (control unit)	TAC NO: 9.9836/2019
HELLA	DM4 (locking system)	TAC NO: 9.409/2017



Manufacturer	Model designation	Radio equipment approval number
Hirschmann	920287A (locking system)	TAC NO: 9.845/2013
Hirschmann	920287B (locking system)	TAC NO: 9.846/2013
Hirschmann	920702A (locking system)	TAC NO: 9.412/2022
HUF Baolong	TSSRE4A (tyre pressure sensor)	TAC NO: 9.620/2017



Manufacturer	Model designation	Radio equipment approval number
HUF	HUF14632 (locking system)	TAC NO: 9.598/2015
HUF	HUF4761 (locking system)	TAC NO: 9.790/2013
LEOPOLD KOSTAL	KK1 (locking system)	TAC NO: 9.118/2016
MARQUARDT	DC12A (locking system)	TAC NO: 9.131/2017
MARQUARDT	DC12B (locking system)	TAC NO: 9.829/2013



Manufacturer	Model designation	Radio equipment approval number
MARQUARDT	DC12K (locking system)	TAC NO: 9.830/2013
MARQUARDT	MS2 (locking system)	TAC NO: 9.133/2017
MARQUARDT	MS4 (locking system)	TAC NO: 9.100171/2019
MARQUARDT	MS5 (locking system)	TAC.NO: 9.774/2020
MARQUARDT	MK1 (locking system)	TAC NO: 9.486/2015
MARQUARDT	MK2 (locking system)	TAC NO: 9.497/2015



Manufacturer	Model designation	Radio equipment approval number
Schrader	AG3PF4 (tyre pressure sensor)	TAC NO:9.039/2016
Schrader	AG5SP4 (tyre pressure sensor)	TAC NO:9.9167/2019
Schrader	BG3FP4 (tyre pressure sensor)	TAC NO:9.68/2021
Schrader	GG4T (tyre pressure sensor)	TAC NO:9.538/2017



Manufacturer	Model designation	Radio equipment approval number
Schrader	DG6W2D4 (tyre pressure sensor)	TAC NO: 9.789/2018
Veoneer	77GHz MMRV1 (radar sensor)	TAC NO: 9.9284/2019
Veoneer	77V12BSM (radar sensor)	TAC NO: 9.9391/2019
Veoneer	77V12CRN (radar sensor)	TAC NO: 9.9391/2019



Manufacturer	Model designation	Radio equipment approval number
Veoneer	77V125CRN (radar sensor)	TAC NO: 9.477/2021
WITTE-Velbert	SDHTAG3NFC (locking system)	TAC NO: 9.527/2020

Paraguay

Regulatory radio identification



Manufacturer	Model designation	Radio equipment approval number
ADC	ARS4-A (radar sensor)	2019-05-I-0271
ADC	ARS4-C (radar sensor)	2019-11-I-0602
Bosch	FR5CPCCF (radar sensor)	2019-09-I-0508
Bosch	MRRre14FCR (radar sensor)	2017-06-I-0000162
Bosch	MRR1Rear (radar sensor)	2019-05-I-000236



Manufacturer	Model designation	Radio equipment approval number
Continental Antenna	RKE213E1 (aerial amplifier)	2021-02-I-00101 y 2016-02-I-0000038
Continental Antenna	RKE223E1GN S (aerial amplifier)	2019-12-I-0656
Continental Automotive	CMKG1 (locking system)	2020-02-I-0110
Continental Automotive	MARS Keyless (locking system)	2017-05-I-0000136
HELLA	DM4 (locking system)	2017-08-I_0000261



Manufacturer	Model designation	Radio equipment approval number
Hirschmann	920287A (locking system)	2016-5-I-000134 y 2011-06-I-0059
Hirschmann	920287B (locking system)	2017-04-I-0000119 y 2012-05-I-0096
Hirschmann	920702A (locking system)	2022-03-I-0149
Huf Baolong	TSSRE4A (tyre pressure sensor)	2017-09-I-0000328



Manufacturer	Model designation	Radio equipment approval number
HUF	HUF14632 (locking system)	2020-06-I-0284 y 2015-08-I-0000226
HUF	HUF4761 (locking system)	2017-12-I-0000409 y 2012-10-I-0178
LEOPOLD KOSTAL	KK1 (locking system)	2015-06-I-0000181
MARQUARDT	DC12A (locking system)	2020-12-I-0898 y 2015-06-I-0000181



Manufacturer	Model designation	Radio equipment approval number
MARQUARDT	DC12B (locking system)	2021-05-I-0304; 2016-5-I-000144 y 2011-06-I-0067
MARQUARDT	DC12K (locking system)	2021-05-I-0305; 2016-5-I-000143 y 2011-06-I-0068
MARQUARDT	MS2 (locking system)	2017-04-I-0000101



Manufacturer	Model designation	Radio equipment approval number
MARQUARDT	MS4 (locking system)	2019-10-I-0581
MARQUARDT	MS5 (locking system)	2020-08-I-0604
MARQUARDT	MK1 (locking system)	2020-07-I-0390 y 2015-07-I-0000200
MARQUARDT	MK2 (locking system)	2020-07-I-0391 y 2015-07-I-0000201



Manufacturer	Model designation	Radio equipment approval number
MARQUARDT	3350.38 (locking system)	2019-04-I-000216
Schrader	AG5SP4 (tyre pressure sensor)	2015-04-I-0000150
Schrader	AG3PF4 (tyre pressure sensor)	2019-05-1-000261
Schrader	BG3FP4 (tyre pressure sensor)	2021-02-I-0063



Manufacturer	Model designation	Radio equipment approval number
Schrader	GG4T (tyre pressure sensor)	2020-02-1-0044
Schrader	DG6W2D4 (tyre pressure sensor)	2019-11-1-0632
Veoneer	77GHz MMRV1 (radar sensor)	2020-07-I-0510
Veoneer	77V12BSM (radar sensor)	2019-07-I-0399
Veoneer	77V12CRN (radar sensor)	2019-07-I-0398



Manufacturer	Model designation	Radio equipment approval number
Veoneer	77V125CRN (radar sensor)	2021-04-I-0188
WITTE-Velbert	SDHTAG3NFC (locking system)	2020-06-I-0326

Further specific information

Charging unit for the wireless charging of mobile devices (WMI):

D-WMI2020A:

This vehicle has the following radio frequency component approved by CONATEL - Paraguay: Wireless interface for mobile devices, Continental brand, model D-WMI2020A manufactured by Continental Automotive GmbH.

Radio equipment approval number: 2019-11-I-0600

Rear Seat Entertainment System:

DAIRSE:

Importer: Condor S.A.C.I Casa Central, J.B. Gorostiaga 315 y Guaraníes, Asunción, Paraguay, (595 21) 569 7000, sac@condor.com.py

Philippines

Regulatory radio identification



Manufacturer	Model designation	Radio equipment approval number
ADC	ARS4-A (radar sensor)	ESD-1409466 C
ADC	ARS4-C (radar sensor)	ESD-1920226 C



Manufacturer	Model designation	Radio equipment approval number
Bosch	FR5CPCCF (radar sensor)	ESD-1920531 C
Bosch	MRR1Rear (radar sensor)	ESD-1408917 C
Bosch	MRRre14FCR (radar sensor)	ESD-1716172 C
Continental Antenna	RKE213E1 (aerial amplifier)	ESD-1511856 C
Continental Antenna	RKE223E1GN S (aerial amplifier)	ESD-1921015 C



Manufacturer	Model designation	Radio equipment approval number
Continental Automotive	CMKG1 (locking system)	ESD-2021556 C
Continental Automotive	MARS Keyless (locking system)	ESD-1714865 C
HELLA	DM4 (locking system)	ESD-1715539 C
Hirschmann	920287A (locking system)	ESD-1105246 C
Hirschmann	920287B (locking system)	ESD-1206044 C



Manufacturer	Model designation	Radio equipment approval number
Hirschmann	920702A (locking system)	ESD-RCE-2229632
Huf Baolong	TSSRE4A (tyre pressure sensor)	ESD-1715393 C
HUF	HUF14632 (locking system)	ESD-1511236 C
HUF	HUF4761 (locking system)	ESD-1206521 C
LEOPOLD KOSTAL	KK1 (locking system)	ESD-1510698 C



Manufacturer	Model designation	Radio equipment approval number
MARQUARDT	DC12A (locking system)	ESD-1714489 C
MARQUARDT	DC12B (locking system)	ESD-1105216 C
MARQUARDT	DC12K (locking system)	ESD-1105215 C
MARQUARDT	MS2 (locking system)	ESD-1715652 C
MARQUARDT	MS4 (locking system)	ESD-1919133 C
MARQUARDT	MS5 (locking system)	ESD-2022426 C



Manufacturer	Model designation	Radio equipment approval number
MARQUARDT	MK1 (locking system)	ESD-1510644 C
MARQUARDT	MK2 (locking system)	ESD-1510645 C
MARQUARDT	3350.38 (locking system)	ESD-1919198 C
Schrader	AG5SP4 (tyre pressure sensor)	ESD-1715393 C
Schrader	AG3PF4 (tyre pressure sensor)	ESD-1919585 C



Manufacturer	Model designation	Radio equipment approval number
Schrader	BG3FP4 (tyre pressure sensor)	ESD-RCE-2124846
Schrader	GG4T (tyre pressure sensor)	ESD-1715977 C
Schrader	DG6W2D4 (tyre pressure sensor)	ESD-1817081 C





Manufacturer	Model designation	Radio equipment approval number
Veoneer	77GHz MMRV1 (radar sensor)	ESD-1510921 C
WITTE-Velbert	SDHTAG3NFC (locking system)	ESD-2022599 C

Zambia

Regulatory radio identification

		
Manufacturer	Model designation	Radio equipment approval number
Continental Antenna	RKE223E1 (aerial amplifier)	ZMB/ ZICTA/TA/ 2019/3/11
Continental Automotive	MARS Keyless (locking system)	ZMB/ ZICTA/TA/ 2019/3/3
HELLA	DM4 (locking system)	ZMB/ ZICTA/TA/ 2019/3/4
Hirschmann	920287A (locking system)	ZMB/ ZICTA/TA/ 2019/7/12

		
Manufacturer	Model designation	Radio equipment approval number
Hirschmann	920287B (locking system)	ZMB/ ZICTA/TA/ 2019/7/11
HUF	HUF4761 (locking system)	ZMB/ ZICTA/TA/ 2018/12/18
LEOPOLD KOSTAL	KK1 (locking system)	ZMB/ ZICTA/TA/ 2019/3/48
MARQUARDT	DC12A (locking system)	ZMB/ ZICTA/TA/ 2019/5/16

		
Manufacturer	Model designation	Radio equipment approval number
MARQUARDT	DC12B (locking system)	ZMB/ ZICTA/TA/ 2019/5/17
MARQUARDT	DC12K (locking system)	ZMB/ ZICTA/TA/ 2019/5/18
MARQUARDT	MS2 (locking system)	ZMB/ ZICTA/TA/ 2018/9/30
MARQUARDT	MS4 (locking system)	ZMB/ ZICTA/TA/ 2019/7/123



Manufacturer	Model designation	Radio equipment approval number
MARQUARDT	MK1 (locking system)	ZMB/ ZICTA/TA/ 2019/3/20
MARQUARDT	MK2 (locking system)	ZMB/ ZICTA/TA/ 2019/3/21
MARQUARDT	3350.38 (locking system)	ZMB/ ZICTA/TA/ 2019/3/6
MARQUARDT	MU1 (locking system)	ZMB/ ZICTA/TA/ 2019/7/124

Serbia

Regulatory radio identification



Manufacturer	Model designation	Radio equipment approval number
ADC	ARS4-A (radar sensor)	I011 20
ADC	ARS4-C (radar sensor)	I011 19
Bosch	FR5CPCCF (radar sensor)	I011 19
Bosch	LRR3 (radar sensor)	I011 19
Bosch	MRR1Rear (radar sensor)	I011 17



Manufacturer	Model designation	Radio equipment approval number
Bosch	MRRe14FCR (radar sensor)	I005 17
Continental Antenna	RKE213E1 (aerial amplifier)	I005 21
Continental Antenna	RKE223E1GN S (aerial amplifier)	I005 19
Continental Automotive	CMKG1 (locking system)	I005 20
Continental Automotive	MARS Keyless (locking system)	I005 20



Manufacturer	Model designation	Radio equipment approval number
HELLA	DM4 (locking system)	I005 20
Hirschmann	920287A (locking system)	I005 18
Hirschmann	920287B (locking system)	I005 18
Hirschmann	920702A (locking system)	I005 22
Huf Baolong	TSSRE4A (tyre pressure sensor)	I005 20



Manufacturer	Model designation	Radio equipment approval number
HUF	HUF14632 (locking system)	I005 21
HUF	HUF4761 (locking system)	I005 21
LEOPOLD KOSTAL	KK1 (locking system)	I005 18
MARQUARDT	DC12A (locking system)	I005 20
MARQUARDT	DC12B (locking system)	I005 20



Manufacturer	Model designation	Radio equipment approval number
MARQUARDT	DC12K (locking system)	I005 20
MARQUARDT	MS2 (locking system)	I011 17
MARQUARDT	MS4 (locking system)	I005 19
MARQUARDT	MS5 (locking system)	I005 20
MARQUARDT	MK1 (locking system)	I005 21
MARQUARDT	MK2 (locking system)	I005 21



Manufacturer	Model designation	Radio equipment approval number
MARQUARDT	3350.38 (locking system)	I005 22
Meta System	MUW II (interior protection)	I011 19
Schrader	AG5SP4 (tyre pressure sensor)	I005 15
Schrader	AG3PF4 (tyre pressure sensor)	I005 15



Manufacturer	Model designation	Radio equipment approval number
Schrader	BG3FP4 (tyre pressure sensor)	I005 20
Schrader	GG4T (tyre pressure sensor)	I005 17
Schrader	DG6W2D4 (tyre pressure sensor)	I005 18
Schrader	MC34MA4 (tyre pressure monitoring system control unit)	I011 11



Manufacturer	Model designation	Radio equipment approval number
Veoneer	77GHz MMRV1 (radar sensor)	I011 18
Veoneer	77V12BSM (radar sensor)	I011 19
Veoneer	77V12CRN (radar sensor)	I011 19
Veoneer	77V125CRN (radar sensor)	I038 21
WITTE-Velbert	SDHTAG3NFC (locking system)	I005 20

Singapore

Regulatory radio identification

Manufacturer	Model designation	Radio equipment approval number
		Complies with IMDA Standards
ADC	ARS4-A (radar sensor)	DA103365
ADC	ARS4-C (radar sensor)	DA103365
Bosch	FR5CPCCF (radar sensor)	DA103365
Bosch	LRR3 (radar sensor)	DA103365
Bosch	MRR1Rear (radar sensor)	DA103365

Manufacturer	Model designation	Radio equipment approval number
Bosch	MRRe14FCR (radar sensor)	DA103365
Continental Antenna	RKE213E1 (aerial amplifier)	DA105282
Continental Antenna	RKE223E1GN S (aerial amplifier)	DA107248
Continental Automotive	CMKG1 (locking system)	DA103365
Continental Automotive	MARS Keyless (locking system)	DA105282
Continental Automotive	UWBTRX1 (locking system)	DB107091

Manufacturer	Model designation	Radio equipment approval number
Continental Automotive	D-WMI2020A (control unit)	DA103365
Harman Becker	HERMES 3.0 (communication module)	DB107091
HELLA	DM4 (locking system)	DA103365
Hirschmann	920287A (locking system)	DA103365
Hirschmann	920287B (locking system)	DA103365
Hirschmann	920702A (locking system)	DA105282

Manufacturer	Model designation	Radio equipment approval number
HUF Baolong	TSSRE4A (tyre pressure sensor)	DA30668
HUF Baolong	TSSSG4G6b (tyre pressure sensor)	DA28467
HUF	HUF14632 (locking system)	DA105282
HUF	HUF4761 (locking system)	DA103365
LEOPOLD KOSTAL	KK1 (locking system)	DA103365
MARQUARDT	DC12A (locking system)	DA103787

Manufacturer	Model designation	Radio equipment approval number
MARQUARDT	DC12B (locking system)	DA103365
MARQUARDT	DC12K (locking system)	DA103365
MARQUARDT	MS2 (locking system)	DA103787
MARQUARDT	MS4 (locking system)	DA103787
MARQUARDT	MS5 (locking system)	DB107091
MARQUARDT	MK1 (locking system)	DA103365
MARQUARDT	MK2 (locking system)	DA103365

Manufacturer	Model designation	Radio equipment approval number
MARQUARDT	3350.38 (locking system)	DA103787
Meta System	ITS/TPS (interior protection)	DA103365
Meta System	MUW II (interior protection)	DA103365
Schrader	AG5SP4 (tyre pressure sensor)	DA103787
Schrader	AG3PF4 (tyre pressure sensor)	DA107968
Schrader	BG3FP4 (tyre pressure sensor)	DA103365

Manufacturer	Model designation	Radio equipment approval number
Schrader	GG4T (tyre pressure sensor)	DA105282
Schrader	DG6W2D4 (tyre pressure sensor)	DA105282
Veoneer	77GHz MMRV1 (radar sensor)	DA103365
Veoneer	77V12BSM (radar sensor)	DA103365
Veoneer	77V12CRN (radar sensor)	DA103365

Manufacturer	Model designation	Radio equipment approval number
Veoneer	77V125CRN (radar sensor)	DA103365
WITTE-Velbert	SDHTAG3NFC (locking system)	DA107248

South Africa

Regulatory radio identification

		
Manufacturer	Model designation	Radio equipment approval number
ADC	ARS4-A (radar sensor)	TA-2014/1637
ADC	ARS4-C (radar sensor)	TA-2019/1595
Bosch	FR5CPCCF (radar sensor)	TA-2019/1200
Bosch	MRR1Rear (radar sensor)	TA-2014/212
Bosch	MRRre14FCR (radar sensor)	TA-2017/2013



Manufacturer	Model designation	Radio equipment approval number
Bosch	LRR3 (radar sensor)	TA-2009/464
Continental Antenna	RKE213E1 (aerial amplifier)	TA-2015/1438
Continental Antenna	RKE223E1 (aerial amplifier)	TA-2020/043
Continental Automotive	CMKG1 (locking system)	TA-2019/5405
Continental Automotive	MARS Keyless (locking system)	TA-2016/3500



Manufacturer	Model designation	Radio equipment approval number
Continental Automotive	UWBTRX1 (locking system)	TA-2021/3460
Gentex	MUAHL 5 (convenience system)	TA-2015/1386
HELLA	DM4 (locking system)	TA-2017/2518
Hirschmann	920287A (locking system)	TA-2011/374
Hirschmann	920287B (locking system)	TA-2013/1262



Manufacturer	Model designation	Radio equipment approval number
Hirschmann	920702A (locking system)	TA-2022/0162
Huf Baolong	TSSRE4A (tyre pressure sensor)	TA-2017/1393
Huf Baolong	TSSSG4G6b (tyre pressure sensor)	TA-2019/1440
HUF	HUF14632 (locking system)	TA-2015/1077



Manufacturer	Model designation	Radio equipment approval number
HUF	HUF4761 (locking system)	TA-2012/1543
LEOPOLD KOSTAL	KK1 (locking system)	TA-2015/595
Meta System	ITS Master (interior protection)	TA-2011/1636
Meta System	ITS Sensor (interior protection)	TA-2011/1227
Meta System	MUW II (interior protection)	TA-2019/261



Manufacturer	Model designation	Radio equipment approval number
MARQUARDT	DC12A (locking system)	TA-2017/312
MARQUARDT	DC12B (locking system)	TA-2011/370
MARQUARDT	DC12K (locking system)	TA-2012/1542
MARQUARDT	MS2 (locking system)	TA-2016/3314
MARQUARDT	MS4 (locking system)	TA-2019/843
MARQUARDT	MS5 (locking system)	TA-2020/5765



Manufacturer	Model designation	Radio equipment approval number
MARQUARDT	MK1 (locking system)	TA-2015/179
MARQUARDT	MK2 (locking system)	TA-2015/180
MARQUARDT	3350.38 (locking system)	TA-2018/3985
Schrader	AG5SP4 (tyre pressure sensor)	TA-2015/072
Schrader	AG3PF4 (tyre pressure sensor)	TA-2019-133



Manufacturer	Model designation	Radio equipment approval number
Schrader	BG3FP4 (tyre pressure sensor)	TA-2020/773
Schrader	MFR (control unit)	TA-2019/273
Schrader	MFR3 (control unit)	TA-2019-273
Schrader	GG4T (tyre pressure sensor)	TA-2017/3884
Schrader	DG6W2D4 (tyre pressure sensor)	TA-2017/2933



Manufacturer	Model designation	Radio equipment approval number
Schrader	MC34MA4 (tyre pressure monitoring system control unit)	TA-2011/1370
Veoneer	77GHz MMRV1 (radar sensor)	TA-2015/2087
Veoneer	77V12BSM (radar sensor)	TA-2019/1380
Veoneer	77V12CRN (radar sensor)	TA-2019/1382





Manufacturer	Model designation	Radio equipment approval number
Veoneer	77V125CRN (radar sensor)	TA-2021/0150
WITTE-Velbert	SDHTAG3NFC (locking system)	TA-2020/055

South Korea

Regulatory radio identification

		
Manufacturer	Model designation	Radio equipment approval number
Continental Antenna	RKE223E1 (aerial amplifier)	R-C-Ca3-RKE223E1
Huf Baolong	TSSRE4A (tyre pressure sensor)	
HUF	HUF14632 (locking system)	MSIP-CRM-HHF-HUF-14632
Schrader	MFR (control unit)	MSIP-REM-SRD-MFR

		
Manufacturer	Model designation	Radio equipment approval number
Schrader	MFR3 (control unit)	KCC R-R-SRD-MFR3A
Schrader	MC34MA4 (tyre pressure monitoring system control unit)	KCC-REM-SRD-MRXMC34MA4
Schrader	AG5SP4 (tyre pressure sensor)	MSIP-CRM-SRD-AG5SP4
Schrader	AG3PF4 (tyre pressure sensor)	R-C-SRD-AG3PF4

		
Manufacturer	Model designation	Radio equipment approval number
Schrader	BG3FP4 (tyre pressure sensor)	R-C-SRD-BG3FP4
Schrader	GG4T (tyre pressure sensor)	MSIP-CRM-SRD-GG4T
Schrader	DG6W2D4 (tyre pressure sensor)	R-CRM-SRD-DG6W2D4

Togo

Regulatory radio identification

Manufacturer	Model designation	Radio equipment approval number
Continental Antenna	RKE223E1 (aerial amplifier)	No. 024/19
Continental Automotive	MARS Keyless (locking system)	No. 040/19
HELLA	DM4 (locking system)	No. 039/19
Hirschmann	920287A (locking system)	No. 089/19
Hirschmann	920287B (locking system)	No. 088/19

Manufacturer	Model designation	Radio equipment approval number
HUF	HUF4761 (locking system)	No. 041/19
LEOPOLD KOSTAL	KK1 (locking system)	No. 060/19
MARQUARDT	DC12A (locking system)	No. 055/19
MARQUARDT	DC12B (locking system)	No. 057/19
MARQUARDT	DC12K (locking system)	No. 056/19
MARQUARDT	MS2 (locking system)	No. 008/19
MARQUARDT	MS4 (locking system)	No. 101/19

Manufacturer	Model designation	Radio equipment approval number
MARQUARDT	MK1 (locking system)	No. 021/19
MARQUARDT	MK2 (locking system)	No. 022/19
MARQUARDT	3350.38 (locking system)	No. 016/20

Ukraine

Regulatory radio identification



Manufacturer	Model designation	Radio equipment approval number
Continental Antenna	RKE213E1 (aerial amplifier)	UKR.355-123 /19
Continental Antenna	RKE223E1GN S (aerial amplifier)	UA.R.TR.052.682-19
Continental Automotive	CMKG1 (locking system)	UA1.001.021 175-20-TE
Continental Automotive	MARS Keyless (locking system)	RTS.UKR.355-34/18



Manufacturer	Model designation	Radio equipment approval number
HELLA	DM4 (locking system)	UA.TR.109
Hirschmann	920287A (locking system)	UKR.355-7/20
Hirschmann	920287B (locking system)	UKR.355-8/20
Huf Baolong	TSSRE4A (tyre pressure sensor)	UA 1.001.01856 8-19-TE



Manufacturer	Model designation	Radio equipment approval number
Huf Baolong	TSSSG4G6b (tyre pressure monitoring system control unit)	UA 1.001.01928 9-19-TE
HUF	HUF14632 (locking system)	UKR.355-113 /19
HUF	HUF4761 (locking system)	UA1.001.018 653-19-TE
LEOPOLD KOSTAL	KK1 (locking system)	10094.00668 2-19



Manufacturer	Model designation	Radio equipment approval number
MARQUARDT	DC12A (locking system)	UA.R.TR.052.307-19
MARQUARDT	DC12B (locking system)	UA.R.TR.052.308-19
MARQUARDT	DC12K (locking system)	UA.R.TR.052.309-19
MARQUARDT	MS2 (locking system)	UA1.001.019.129-19-TE
MARQUARDT	MS4 (locking system)	UA.R.TR.052.528-19
MARQUARDT	MS5 (locking system)	632.16-CET



Manufacturer	Model designation	Radio equipment approval number
MARQUARDT	MK1 (locking system)	UA1.001.019.233-19-TE
MARQUARDT	MK2 (locking system)	UA1.001.019.234-19-TE
MARQUARDT	3350.38 (locking system)	UA1.001.018.888-19-TE
Schrader	AG5SP4 (tyre pressure sensor)	UA.TR. 032
Schrader	AG3PF4 (tyre pressure sensor)	UA-TR-001



Manufacturer	Model designation	Radio equipment approval number
Schrader	BG3FP4 (tyre pressure sensor)	UA-TR-109
Schrader	GG4T (tyre pressure sensor)	UA.TR. 028
Schrader	DG6W2D4 (tyre pressure sensor)	UA.TR. 028
WITTE-Velbert	SDHTAG3NFC (locking system)	UA.R.TR.052.120-20

Uzbekistan

Regulatory radio identification



Manufacturer	Model designation
Continental Automotive	RKE213E1 (aerial amplifier)
Continental Automotive	RKE223E1GNS (aerial amplifier)
Continental Automotive	CMKG1 (locking system)
Continental Automotive	MARS Keyless (locking system)
HELLA	DM4 (locking system)
Hirschmann	920287A (locking system)



Manufacturer	Model designation
Hirschmann	920287B (locking system)
Hirschmann	920702A (locking system)
LEOPOLD KOSTAL	KK1 (locking system)
MARQUARDT	DC12A (locking system)
MARQUARDT	DC12B (locking system)
MARQUARDT	DC12K (locking system)
MARQUARDT	MS2 (locking system)
MARQUARDT	MS4 (locking system)



Manufacturer	Model designation
MARQUARDT	MS5 (locking system)
MARQUARDT	MK1 (locking system)
MARQUARDT	MK2 (locking system)
MARQUARDT	3350.38 (locking system)
WITTE-Velbert	SDHTAG3NFC (locking system)

United Arab Emirates

Regulatory radio identification



Manufacturer	Model designation	Radio equipment approval number
ADC	ARS4-A (radar sensor)	TA RTTE: 58296/17, DA40068/15 



Manufacturer	Model designation	Radio equipment approval number
ADC	ARS4-C (radar sensor)	TA RTTE: 77062/19, DA40068/15 



Manufacturer	Model designation	Radio equipment approval number
Bosch	FR5CPCCF (radar sensor)	TA RTTE: 74533/19, DA36758/14 
Continental Antenna	RKE213E1 (aerial amplifier)	TRA ER64693/18, DA65993/17
Continental Antenna	RKE223E1GN S (aerial amplifier)	TRA E76442/19, DA65993/17



Manufacturer	Model designation	Radio equipment approval number
Continental Automotive	CMKG1 (locking system)	TRA ER77964/20, DA0018994/09
Continental Automotive	MARS Keyless (locking system)	TRA ER56005/17, DA44932/15
Continental Automotive	UWBTRX1 (locking system)	TRA ER11321/22, DA36975/14
Gentex	MUAHL 5 (convenience system)	TRA ER41849/15, DA35176/14



Manufacturer	Model designation	Radio equipment approval number
Haram Becker	HERMES 3.0 (communication module)	TRA ER03601/21, DA0028019/10
HELLA	DM4 (locking system)	TRA ER56616/17, DA44932/15
Hirschmann	920287A (locking system)	TRA ER52213/17, DA35219/14
Hirschmann	920287B (locking system)	TRA ER42011/15, DA35219/14



Manufacturer	Model designation	Radio equipment approval number
Hirschmann	920702A (locking system)	TRA ER10723/22, DA35219/14
Huf Baolong	TSSRE4A (tyre pressure sensor)	TRA ER57806/17, DA36976/14
Huf Baolong	TSSSG4G6b (tyre pressure monitoring system control unit)	TRA ER7307/19, DA0086237/12
HUF	HUF14632 (locking system)	TRA ER63716/18, DA36976/14



Manufacturer	Model designation	Radio equipment approval number
HUF	HUF4761 (locking system)	TRA ER55496/17, DA36976/14
HUF	HUF13145 (locking system)	TRA ER08607/22 DA36976/14 
LEOPOLD KOSTAL	KK1 (locking system)	TRA ER62622/18, DA0105247/13



Manufacturer	Model designation	Radio equipment approval number
MARQUARDT	DC12A (locking system)	TRA ER53465/17, DA0018994/09
MARQUARDT	DC12B (locking system)	TRA ER0067828/11, DA0018994/09
MARQUARDT	DC12K (locking system)	TRA ER0067829/11, DA0018994/09



Manufacturer	Model designation	Radio equipment approval number
MARQUARDT	MS2 (locking system)	TRA ER52668/17, DA0018994/09
MARQUARDT	MS4 (locking system)	TRA ER71616/19, DA0018994/09
MARQUARDT	MS5 (locking system)	TRA ER80720/20, DA0018994/09



Manufacturer	Model designation	Radio equipment approval number
MARQUARDT	MK1 (locking system)	TRA ER64145/18, DA0018994/09
MARQUARDT	MK2 (locking system)	TRA ER64146/18, DA0018994/09
MARQUARDT	3350.38 (locking system)	TRA ER69280/19, 0018994/09
Schrader	AG5SP4 (tyre pressure sensor)	TRA ER37156/15, DA0047074/10



Manufacturer	Model designation	Radio equipment approval number
Schrader	AG3PF4 (tyre pressure sensor)	TRA ER70533/19, DA0047074/10
Schrader	BG3FP4 (tyre pressure sensor)	TRA ER96175/21, DA0047074/10
Schrader	GG4T (tyre pressure sensor)	TRA ER57985/17, DA0047074/10



Manufacturer	Model designation	Radio equipment approval number
Schrader	DG6W2D4 (tyre pressure sensor)	TRA ER960528/18, DA0047074/10
Schrader	MC34MA4 (tyre pressure monitoring system control unit)	TRA ER37066/15, DA0047074/10
Sennheiser	M3IETW2L (Earbud)	ER78231/20
Sennheiser	BTT100 (Bluetooth Audio Transmitter)	ER64728/18



Manufacturer **Model designation** **Radio equipment approval number**

Veoneer 77GHz MMRV1 (radar sensor) TA RTTE: ER96352/21; 0020858/10



Manufacturer **Model designation** **Radio equipment approval number**

Veoneer 77V12BSM (radar sensor) TA RTTE: ER72324/19; 0020858/10



Manufacturer **Model designation** **Radio equipment approval number**

Veoneer 77V12CRN (radar sensor) TA RTTE: ER72323/19; 0020858/10





Manufacturer	Model designation	Radio equipment approval number
Veoneer	77V125CRN (radar sensor)	TA RTTE: ER95775/21; 0020858/10 
WITTE-Velbert	SDHTAG3NFC (locking system)	TRA ER79695/20, DA0018994/09

United Kingdom

Regulatory radio identification



Manufacturer	Model designation
Continental Antenna	RKE213E1 (aerial amplifier)
Continental Antenna	RKE223E1GNS (aerial amplifier)
Continental Automotive	CMKG1 (locking system)
Continental Automotive	MARS Keyless (locking system)
Continental Automotive	UWBTRX1 (locking system)



Manufacturer	Model designation
HUF	HUF13145 (locking system)
Huf Baolong	TSSRE4A (tyre pressure sensor)
HELLA	DM4 (locking system)
Hirschmann	920287A (locking system)
Hirschmann	920287B (locking system)
Hirschmann	920702A (locking system)
LEOPOLD KOSTAL	KK1 (locking system)



Manufacturer	Model designation
MARQUARDT	DC12B (locking system)
MARQUARDT	DC12K (locking system)
MARQUARDT	MK1 (locking system)
MARQUARDT	MK2 (locking system)
MARQUARDT	MS2 (locking system)
MARQUARDT	MS2 (locking system)
MARQUARDT	MS4 (locking system)
MARQUARDT	3350.38 (locking system)



Manufacturer	Model designation
Schrader	AG5SP4 (tyre pressure sensor)
Schrader	AG3PF4 (tyre pressure sensor)
Schrader	BG3FP4 (tyre pressure sensor)
Schrader	GG4T (tyre pressure sensor)
Schrader	DG6W2D4 (tyre pressure sensor)
WITTE-Velbert	SDHTAG3NFC (locking system)

Further specific information

Charging unit for the wireless charging of mobile devices (WMI):

D-WMI2016A, D-WMI2017A, D-WMI2017B:

Restrictions or Requirements in the UK: A separation distance of at least 10 cm between all persons and the device must be provided at all times. The Device must not be co-located or operating in conjunction with any other antenna or transmitter.

D-WMI2020A:

Restrictions or Requirements in the UK: A separation distance of at least 0 cm between all persons and the device must be provided at all times. The Device must not be co-located or operating in conjunction with any other antenna or transmitter.

United States

Regulatory radio identification

Manufacturer	Model designation	Radio equipment approval number
Sennheiser	M3IETW2R (Earbud)	FCC ID: DMOM3IETW 2R
Sennheiser	M3IETW2L (Earbud)	FCC ID: DMOM3IETW 2L
Sennheiser	BTT100 (Bluetooth Audio Transmitter)	FCC ID: DMOBTT100

Information on installation clearances

Charging unit for the wireless charging of mobile devices (WMI):

The charging unit for wireless charging of mobile devices (WMI) complies with FCC and IC radiation exposure limits set forth for an uncontrolled envi-

ronment. This equipment should be installed and operated with a minimum distance of 0 cm (in contact) between the source of radiation and your body. This transmitter must not be placed in the same location as or used at the same time as another transmitter or antenna.

Rear Seat Entertainment System:

USA: "This device complies with part 15 of the FCC Rules and Industry Canada licence-exempt RSS standard(s). Operation is subject to the following two conditions: (1) This device must not cause any harmful interference, and (2) this device must accept any interference received, including interference that may cause undesired operation.

Changes or modifications not expressly approved by the party responsible for compliance could void the user's authority to operate the equipment.

This device must be installed and used at a distance of at least 6 cm from the body."

Canada: "This device complies with ISED Canada licence-exempt RSS standard(s). Operation is subject to the following two conditions: (1) This

device must not cause interference, and (2) this device must accept any interference received, including interference that may cause undesired operation of the device.

This equipment complies with ISED radiation exposure limits established for an uncontrolled environment. This equipment must be installed and operated with a minimum distance of 5 cm between the radiation source and your body."

Radar sensors:

ARS4-C (ADC), ARS4-B (ADC), ARS4-A (ADC), FR5CPCCF (Bosch), MRR1REAR (Bosch), MRREVO14F (Bosch), LRR3 (Bosch), 77V12BSM (Veoneer), 77V12CRN (Veoneer), MMRV1 (Veoneer)

For the USA only: Information on exposure to high-frequency radiation:

This equipment complies with FCC radiation exposure limits established for an uncontrolled environment. This equipment must be installed and operated with a minimum distance of 20 cm between the radiation source and your body.

This transmitter must not be placed in the same location as or used at the same time as another antenna or transmitter.

For Canada only: This equipment should be installed and operated with a minimum distance of 20 cm between the radiation source and your body.

BT Audio Transmitter (BTT100):

This equipment complies with FCC and IC radiation exposure limits established for an uncontrolled environment. This equipment should be installed and operated with a minimum distance of 9 cm between the radiation source and your body.

This transmitter must not be placed in the same location as or used at the same time as another antenna or transmitter.

Vietnam

Regulatory radio identification



Manufacturer	Model designation	Radio equipment approval number
ADC	ARS4-A (radar sensor)	Mercedes-Benz Vietnam Company Limited
ADC	ARS4-C (radar sensor)	Mercedes-Benz Vietnam Company Limited
Bosch	FR5CPCCF (radar sensor)	Mercedes-Benz Vietnam Company Limited



Manufacturer	Model designation	Radio equipment approval number
Bosch	MRR1Rear (radar sensor)	Mercedes-Benz Vietnam Company Limited
Bosch	MRRre14FCR (radar sensor)	Mercedes-Benz Vietnam Company Limited
Continental Antenna	RKE213E1 (aerial amplifier)	Suntech Vietnam Technology Company Limited C027415111 8AF04A2



Manufacturer	Model designation	Radio equipment approval number
Continental Antenna	RKE223E1GN S (aerial amplifier)	Suntech Vietnam Technology Company Limited B152201112 1AF04A3
Continental Automotive	CMKG1 (locking system)	Suntech Vietnam Technology Company Limited C000107012 0AF04A2



Manufacturer	Model designation	Radio equipment approval number
Continental Automotive	MARS Keyless (locking system)	Mercedes-Benz Vietnam Company Limited B074824041 9AF04A2
HELLA	DM4 (locking system)	Mercedes-Benz Vietnam Company Limited C020403032 1AF04A3



Manufacturer	Model designation	Radio equipment approval number
Hirschmann	920702A (locking system)	Mercedes-Benz Vietnam Company Limited B042407042 2AF04A3
Huf Baolong	TSSRE4A (tyre pressure sensor)	C011220071 7AF04A2
LEOPOLD KOSTAL	KK1 (locking system)	Mercedes-Benz Vietnam Company Limited C031314042 1AF0403



Manufacturer	Model designation	Radio equipment approval number
MARQUARDT	DC12A (locking system)	Suntech Vietnam Technology Company Limited C020803032 1AF04A3
MARQUARDT	DC12B (locking system)	Suntech Vietnam Technology Company Limited C007621012 1AF04A3



Manufacturer	Model designation	Radio equipment approval number
MARQUARDT	DC12K (locking system)	Suntech Vietnam Technology Company Limited C007721012 1AF04A3
MARQUARDT	MS2 (locking system)	Suntech Vietnam Technology Company Limited C007521012 1AF04A3



Manufacturer	Model designation	Radio equipment approval number
MARQUARDT	MS4 (locking system)	Suntech Vietnam Technology Company Limited C091311082 1AF04A3
MARQUARDT	MS5 (locking system)	Suntech Vietnam Technology Company Limited C014114052 0AF04A2



Manufacturer	Model designation	Radio equipment approval number
MARQUARDT	MK1 (locking system)	Suntech Vietnam Technology Company Limited C004915012 1AF04A3
MARQUARDT	MK2 (locking system)	Suntech Vietnam Technology Company Limited C005015012 1AF04A3



Manufacturer	Model designation	Radio equipment approval number
MARQUARDT	3350.38 (locking system)	Suntech Vietnam Technology Company Limited C013103022 1AF04A3
Schrader	AG5SP4 (tyre pressure sensor)	Suntech Vietnam Technology Company Limited C000205011 9AF042A



Manufacturer	Model designation	Radio equipment approval number
Schrader	AG3PF4 (tyre pressure sensor)	Suntech Vietnam Technology Company Limited C012022051 9AF04A2
Schrader	GG4T (tyre pressure sensor)	Suntech Vietnam Technology Company Limited C017019101 7AF04A2



Manufacturer	Model designation	Radio equipment approval number
Schrader	DG6W2D4 (tyre pressure sensor)	Suntech Vietnam Technology Company Limited C007807051 8AF04A2
Veoneer	77GHz MMRV1 (radar sensor)	Mercedes-Benz Vietnam Company Limited
Veoneer	77V12BSM (radar sensor)	Mercedes-Benz Vietnam Company Limited



Manufacturer	Model designation	Radio equipment approval number
Veoneer	77V12CRN (radar sensor)	Mercedes-Benz Vietnam Company Limited
Veoneer	77V125CRN (radar sensor)	Mercedes-Benz Vietnam Company Limited
WITTE-Velbert	SDHTAG3NFC (locking system)	Mercedes-Benz Vietnam Company Limited A084713082 0AF04A3

Information on the specific absorption rate (SAR)

Information about the specific absorption rate

The values have been determined and tested in accordance with the Décret n° 2019-1186 guideline regarding the indication of the specific absorption rate (SAR) of wireless vehicle components.

Further information and updates are available at the following web address:

<https://regulatoryradioinformation.corpinter.net/en>



Information about the specific absorption rate

Vehicle components	SAR value in W/kg	Applicable limit value
Compensator ECE DE003 & ECE DE004	< 0.2 W/kg	2 W/kg
DAI RSE	1.8 W/kg	2 W/kg
D-WMI2020A	0.018 W/kg	4 W/kg
HERMES communication module	< 0.4 W/kg	2 W/kg
RAMSES communication module	0.036 W/kg	2 W/kg
NRCS2P	0.003 W/kg	2 W/kg
NTG6	0.199 W/kg	4 W/kg
NTG7	0.08 W/kg	2 W/kg
NTG7RSU	0.07 W/kg	2 W/kg
SM-T230NZ tablet PC	0.7 W/kg	4 W/kg
Radio data transmission telephone system	0.24 W/kg	2 W/kg

Importer information for regulatory radio components

For Moldova only: Importer

S.C. GRAND PREMIUM S.R.L. Moldova
mun. Chisinau, str. Hîncesti sos., 2/2

For Turkey only: Importer

Mercedes Benz Otomotiv Ticaret ve Hizmetler
A.Ş. Genel Merkez
Akçaburgaz Mah. Süleyman Şah Cad. No: 6/1
34522 Esenyurt/İstanbul

For Ukraine only: Importer

PJSC "AUTOCAPITAL"
Velyka Vasytkivska str. 15/2
01004 Kyiv
Ukraine

For the United Kingdom only: Importer

Mercedes-Benz Cars UK Limited
Delaware Drive, Tongwell
Milton Keynes, MK15 8BA
England

Importer of Mercedes-Benz vans

Mercedes-Benz Vans UK Limited
Delaware Drive, Tongwell
Milton Keynes, MK15 8BA

Importer of Mercedes-Benz spare parts

Mercedes-Benz Parts Logistics
Delaware Drive, Tongwell
Milton Keynes, MK15 8BA
England

Further information and updates are available at
the following web address:

[https://
regulatoryradioinformation.corpinter.net/en](https://regulatoryradioinformation.corpinter.net/en)



Vehicle identification plate, VIN and engine number overview

Vehicle identification plate

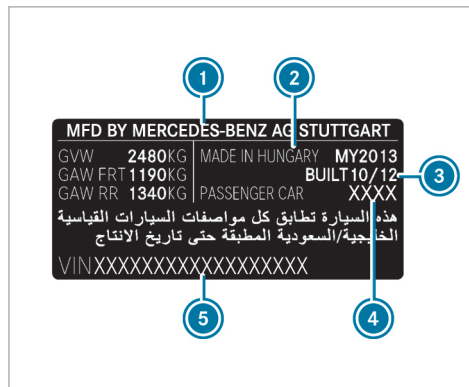
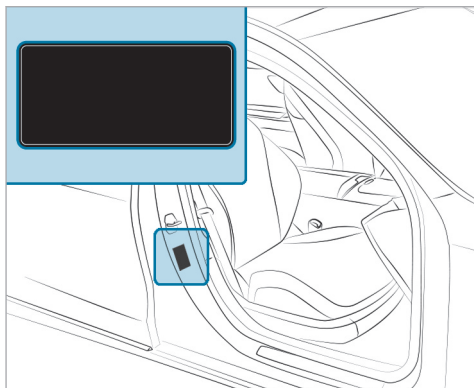

Vehicle identification plate (example: Kuwait)

- ① Vehicle manufacturer
- ② Place of manufacture
- ③ Manufacturing date
- ④ Vehicle model
- ⑤ VIN

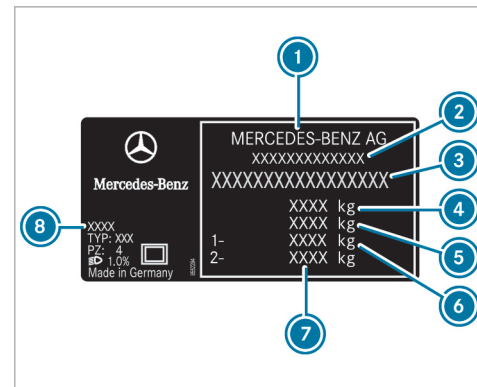

Vehicle identification plate (example: all other countries)

- ① Vehicle manufacturer
- ② EU general operating permit number (only for certain countries)
- ③ VIN (vehicle identification number)
- ④ Maximum permissible gross vehicle weight (kg)

- ⑤ Maximum permissible gross weight of vehicle combination (kg) (only for specific countries)
- ⑥ Maximum permissible front axle load (kg)
- ⑦ Maximum permissible rear axle load (kg)
- ⑧ Paint code
- ① The data shown in the illustration is example data.

VIN below the front right-hand seat

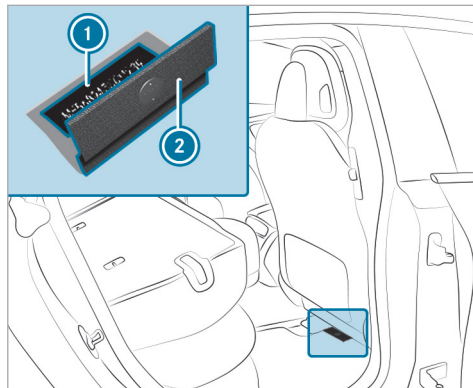

- ① Imprinted VIN (vehicle identification number)
- ② Floor covering

VIN at the lower edge of the windscreen

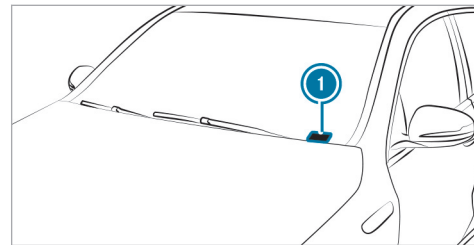

- ① VIN (vehicle identification number) as label

The VIN as a label at the lower edge of the windscreen is only available in some countries.

Engine number

Further information on motor numbers can be obtained at a qualified specialist workshop.

Operating fluids

Notes on operating fluids

⚠ WARNING Risk of injury due to harmful operating fluids

Operating fluids can be toxic.

- ▶ When using, storing and disposing of operating fluids, observe the imprints on the respective original containers.
- ▶ Always keep operating fluids in the sealed original container.
- ▶ Always keep children away from operating fluids.

🌿 ENVIRONMENTAL NOTE Pollution of the environment due to irresponsible disposal of operating fluids

Incorrect disposal of operating fluids can cause considerable damage to the environment.

- ▶ Dispose of operating fluids in an environmentally responsible manner.

Operating fluids include the following:

- lubricants
- Coolant
- Brake fluid
- windscreen washer fluid
- climate control system refrigerant

Only use products approved by Mercedes-Benz. Damage caused by the use of products that have not been approved is not covered by the Mercedes-Benz warranty or goodwill gestures.

You can identify operating fluids approved by Mercedes-Benz by the following inscriptions on the container:

- MB-Freigabe (e.g. MB-Freigabe 229.51)
- MB-Approval (e.g. MB-Approval 229.51)

Further information on approved operating fluids is available at the following locations:

- in the Mercedes-Benz Specifications for Operating Fluids by entering the designation
 - At <https://operatingfluids.mercedes-benz.com>

- At a qualified specialist workshop

Notes on brake fluid

Observe the notes on operating fluids (→ page 759).

⚠ WARNING Risk of an accident due to vapour pockets forming in the brake system

The brake fluid constantly absorbs moisture from the air. This lowers the boiling point of the brake fluid. If the boiling point is too low, vapour pockets may form in the brake system when the brakes are applied hard.

This impairs the braking effect.

- ▶ Have the brake fluid renewed at the specified intervals.

Have the brake fluid regularly replaced at a qualified specialist workshop. Only use a brake fluid approved by Mercedes-Benz according to MB-Freigabe or MB-Approval 331.0.

Coolant

Notes on coolant

Observe the notes on operating fluids (→ page 759).

⚠ WARNING Risk of fire- and injury from antifreeze

If antifreeze comes into contact with hot component parts in the engine compartment, it may ignite.

- ▶ Allow the drive system to cool down before you top up the antifreeze.
- ▶ Make sure that no antifreeze spills out next to the filler opening.
- ▶ Thoroughly clean the antifreeze from component parts before starting the vehicle.

! NOTE Damage caused by incorrect coolant

- ▶ Only use coolant that has been premixed with the required antifreeze protection.

Information on coolant is available at the following locations:

- In the Mercedes-Benz Specification for Operating Fluids 320.1
 - At <https://operatingfluids.mercedes-benz.com>
- At a qualified specialist workshop

! NOTE Overheating at high outside temperatures

If an inappropriate coolant is used, the cooling system is not sufficiently protected against overheating and corrosion at high outside temperatures.

- ▶ Only use coolant approved for Mercedes-Benz.
- ▶ Observe the instructions in the Mercedes-Benz Specifications for Operating Fluids 320.1.

Have the coolant regularly replaced at a qualified specialist workshop.

Proportion of antifreeze concentrate in the cooling system:

- A minimum of 50% (antifreeze protection down to about -37°C)
- A maximum of 55% (antifreeze protection down to -45°C)

Notes on windscreen washer fluid

Observe the notes on operating fluids (→ page 759).

⚠ WARNING Risk of fire and injury from windscreen washer concentrate

Windscreen washer concentrate is highly flammable. If it comes into contact with hot components, it may ignite.

- ▶ Make sure that windscreen washer concentrate is not spilled near to the filler opening.

! **NOTE** Damage to the exterior lighting due to unsuitable windscreen washer fluid

Unsuitable windscreen washer fluids may damage the plastic surface of the exterior lighting.

▶ Only use windscreen washer fluids which are also suitable for use on plastic surfaces, e.g. MB SummerFit or MB WinterFit.

! **NOTE** Blocked spray nozzles caused by mixing windscreen washer fluids

▶ Do not mix MB SummerFit and MB WinterFit with other windscreen washer fluids.

Do not use distilled or de-ionised water. Otherwise, the fill level sensor may be triggered erroneously.

Recommended windscreen washer fluid:

- above freezing point: e.g. MB SummerFit
- below freezing point: e.g. MB WinterFit

For the correct mixing ratio, refer to the information on the antifreeze container.

Mix washer fluid with windscreen washer fluid all year round.

Windscreen washer system

Washer fluid reservoir capacity

Model	Filling volume
All models	Maximum 3.7 l

Vehicle data

Vehicle dimensions

The heights specified may vary as a result of the following factors:

- Tyres
- Load
- Condition of the suspension
- Optional equipment

Missing values were not available at the time of going to press.

Vehicle dimensions (EQE 350)

All models	
Vehicle length	
Vehicle width including exterior mirrors	
Vehicle width excluding exterior mirrors	
Wheelbase	

Vehicle dimensions (all other models)

All models	
Vehicle length	4946 mm
Vehicle width including exterior mirrors	2103 mm
Vehicle width excluding exterior mirrors	1961 mm
Wheelbase	3120 mm

Vehicle height

Model	Vehicle height
EQE 350	
EQE 350 4MATIC EQE 500 4MATIC	1512 mm
All other models	1510 mm

Vehicle dimensions (Mercedes-AMG vehicles)

The heights specified may vary as a result of the following factors:

- Tyres
- Load
- Condition of the suspension
- Optional equipment

Vehicle dimensions

All models	
Vehicle length	4964 mm
Vehicle width including exterior mirrors	2103 mm
Vehicle width excluding exterior mirrors	1906 mm
Vehicle height	1492 mm
Wheelbase	3120 mm

Weights and loads

Please observe the following notes for the specified vehicle data:

- Items of optional equipment increase the unladen weight and reduce the payload.
- Vehicle-specific weight information can be found on the vehicle identification plate (→ page 757).

Also observe the notes on loading the vehicle (→ page 190).

Maximum design speeds

The maximum design speed can differ from the stated figures in practice. It depends on the operating conditions, the optional equipment and the size of the tyres.

Not for Mercedes-AMG vehicles:

Missing values were not available at the time of going to press.

Maximum design speed

Model	
All models	

Maximum design speeds

! **NOTE** Tyres for vehicles with AMG DYNAMIC PLUS Package

The specified top speed for vehicles with **AMG DYNAMIC PLUS Package** is only designed for a specific type of tyres.

- ▶ Only drive the specified maximum speed with summer tyres.
- ▶ Please also observe the notes on the approved tyre types. You could otherwise fail to recognise dangers.

Vehicles with AMG DYNAMIC PLUS Package:

Please see the notice in the section "Tyres and Wheels" in addition (→ page 632).

The maximum design speed can differ from the stated figures in practice. It depends on the operating conditions, the optional equipment and the size of the tyres..

Mercedes-AMG vehicles:

Maximum design speed

Model	
Mercedes-AMG EQE 43 4MATIC	210 km/h
Mercedes-AMG EQE 53 4MATIC+	220 km/h
Only with AMG DYNAMIC PLUS Package: Mercedes-AMG EQE 53 4MATIC+	240 km/h

High-voltage battery

Notes on the power supply for vehicles with high-voltage battery

In accordance with European standard EN 17186:2019, vehicle identifiers are located on the vehicle in the following places:

- On the inside of the socket flap
- On the charging cable connector

In addition, charging stations in European countries are equipped with energy supply identifiers. You can recharge your vehicle at charging stations where the charging station identifier corresponds to the vehicle identifier.

For further information on charging the high-voltage battery, refer to the "Charging the high-voltage battery" section (→ page 276).

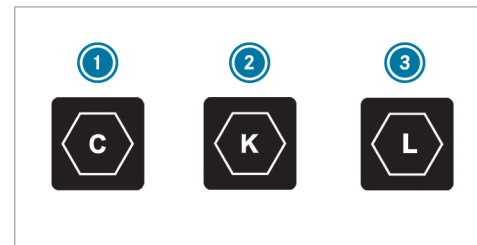

- ① Supply type: AC
Standard: EN 62196-2
Design: type 2
Plug type: charging cable socket and vehicle plug
Voltage range: 480 V RMS

- ② Supply type: DC
Standard: EN 62196-3
Design: FF
Plug type: charging cable socket and vehicle plug
Voltage range: 50 V to 500 V
- ③ Supply type: DC
Standard: EN 62196-3
Design: FF
Plug type: charging cable socket and vehicle plug
Voltage range: 200 V to 920 V

Missing values were not available at the time of going to press.

Energy content and charging times (EQE 300)

EQE 300	
Type	Lithium-ion
Usable energy content	89.9 kWh

EQE 300

Charging time – mode 3 with 7.7 kW charging capacity	approx. 11 h 30 min
Charging time – mode 3 with 11 kW charging capacity	approx. 8 h
Charging time – mode 4 with 170 kW charging capacity	approx. 30 min

Energy content and charging times (EQE 350)

EQE 350	
Type	Lithium-ion
Usable energy content	

EQE 350

Charging time – mode 3 The charging capacity was not yet available at the time of going to press.	
Charging time – mode 4 The charging capacity was not yet available at the time of going to press.	

Energy content and charging times (EQE 350+)

EQE 350+	
Type	Lithium-ion
Usable energy content	90.56 kWh

EQE 350+	
Charging time – mode 3 with 7.7 kW charging capacity	approx. 11 h 45 min
Charging time – mode 3 with 11 kW charging capacity	approx. 8 h 15 min
Charging time – mode 4 with 170 kW charging capacity	approx. 32 min

Energy content and charging times (EQE 350 4MATIC)

EQE 350 4MATIC	
Type	Lithium-ion
Usable energy content	90.56 kWh

EQE 350 4MATIC	
Charging time – mode 3 with 7.7 kW charging capacity	approx. 11 h 30 min
Charging time – mode 3 with 11 kW charging capacity	approx. 8 h only for certain countries: approx. 8 h 15 min
Charging time – mode 4 with 170 kW charging capacity	approx. 32 min

Energy content and charging times (EQE 500 4MATIC)

EQE 500 4MATIC	
Type	Lithium-ion
Usable energy content	90.56 kWh

EQE 500 4MATIC	
Charging time – mode 3 with 11 kW charging capacity	approx. 8 h only for certain countries: approx. 8 h 15 min
Charging time – mode 4 with 170 kW charging capacity	approx. 32 min

Energy content and charging times (Mercedes-AMG EQE 43 4MATIC)

Mercedes-AMG EQE 43 4MATIC	
Type	Lithium-ion
Usable energy content	90.56 kWh only for certain countries: 90.6 kWh

Mercedes-AMG EQE 43 4MATIC	
Charging time – mode 3 with 11 kW charging capacity	approx. 8 h 15 min
Charging time – mode 4 with 170 kW charging capacity	approx. 32 min

Energy content and charging times (Mercedes-AMG EQE 53 4MATIC+)

Mercedes-AMG EQE 53 4MATIC+	
Type	Lithium-ion
Usable energy content	96.12 kWh only for certain countries: 90.5 kWh

Mercedes-AMG EQE 53 4MATIC+	
Charging time – mode 3 with 11 kW charging capacity	approx. 8 h
Charging time – mode 4 with 170 kW charging capacity	approx. 30 min

–Mode 2 and mode 3 charging times apply to AC charging from 10 % to 100 % of the usable energy content.

Charging time –mode 4 applies to DC charging from 10 % to 80 % of the usable energy content.

The time taken to charge the battery depends on the state of charge of the battery, the ambient temperature and the charging capacity. The charging capacity, in turn, depends on the supply voltage, the current intensity and the type of power supply.

The nominal voltage range for your vehicle can be found on the information label in the socket cover (→ page 276).

Trailer hitch

General notes on the trailer hitch

Modifications to the cooling system may be necessary, depending on the vehicle model. The retrofitting of a trailer hitch is only permissible if a trailer load is specified in the vehicle documents.

Further information can be obtained at a qualified specialist workshop.

Mounting dimensions of the trailer hitch

The overhang dimension and fastening points are valid for a trailer hitch installed at the factory.

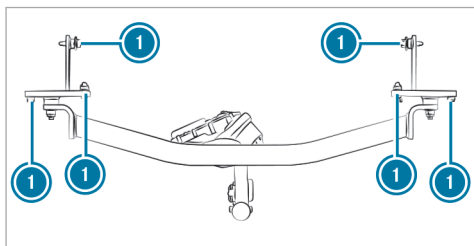
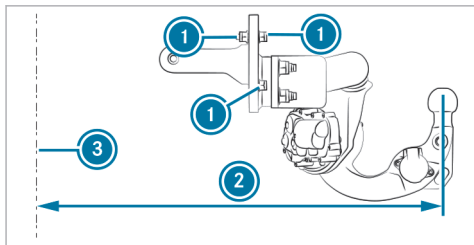

- ① Fastening points
- ② Overhang dimension
- ③ Rear axle centre line

Missing values were not available at the time of going to press.

Overhang dimension length

Model	② Overhang dimension
EQE 350	
All other models	1033 mm

Towing capacity

- ① The drawbar load is not included in the towing capacity.

Missing values were not yet available at the time of going to press.

Towing capacity, braked (at a minimum start-off gradeability of 12 %)

Model	Towing capacity, braked
EQE 350	
All other models	750 kg

Towing capacity, unbraked

Model	Towing capacity, unbraked
EQE 350	
All other models	750 kg

Trailer load (Mercedes-AMG vehicles)

- ① The tongue weight is not included in the towing capacity.
The values for the **trailer load, braked** apply with a minimum start-off gradeability of 12 %.

Towing capacity, braked

Model	Towing capacity, braked
All models	750 kg

Towing capacity, unbraked

Model	Towing capacity, unbraked
All models	750 kg

Maximum trailer drawbar noseweight -and load capacity

! **NOTE** Damage caused by the trailer coming loose

If the tongue weight used is too low, the trailer may come loose.

▶ The tongue weight must not be below 50 kg.

▶ Use a tongue weight that is as close as possible to the maximum permissible tongue weight.

! **NOTE** Damage caused by the bicycle rack coming loose

When using a bicycle rack, both the maximal tongue weight and the maximal load capacity should be observed.

▶ Do not exceed the permissible load capacity.

Observe the additional notes on the maximum load capacity (→ page 399).

Missing values were not available at the time of going to press.

Trailer drawbar load

Model	Maximum drawbar load
EQE 350	
All other models	75 kg

Load capacity

All models	Maximum load capacity
When attaching the bicycle rack to the ball head	75 kg
When attaching the bicycle carrier to the ball head and additionally to the guide pins	100 kg

Maximum tongue-weight and load capacity (Mercedes-AMG vehicles)

! **NOTE** Damage caused by the trailer coming loose

If the tongue weight used is too low, the trailer may come loose.

▶ The tongue weight must not be below 50 kg.

- ▶ Use a tongue weight that is as close as possible to the maximum permissible tongue weight.

! **NOTE** Damage caused by the bicycle rack coming loose

When using a bicycle rack, both the maximal tongue weight and the maximal load capacity should be observed.

- ▶ Do not exceed the permissible load capacity.

Tongue weight

Model	Maximum tongue weight
All models	75 kg

Observe the additional notes on load capacity in the vehicle Owner's Manual.

Load capacity

	Maximum load
When attaching the bicycle rack to the ball head	75 kg
When attaching the bicycle carrier to the ball head and additionally to the guide pins	100 kg

Permissible rear axle load (trailer operation)

Missing values were not available at the time of going to press.

Axle load when towing trailer

Model	Axle load
EQE 350	
All other models	1 700 kg

Permissible axle load, rear axle (Mercedes-AMG vehicles)

Axle load when towing trailer

Model	Axle load
All models	1 770 kg

Display messages

Introduction



Information about display messages



Display messages appear on the driver's display.

Display messages with graphical symbols are simplified in the Owner's Manual and may differ from the symbols on the driver's display. The driver's display shows high-priority display messages in red. Certain display messages are accompanied by a warning tone.

Please act in accordance with the display messages and follow the additional notes in the Owner's Manual.

For some display messages, symbols will also be shown:

-  Further information
-  Hide display message

With the left-hand Touch Control, you can select the respective symbol by swiping to the left or right. Pressing  displays further information on the central display. Press the  symbol to hide the display message.

Display messages to be acknowledged can be hidden by pressing the back button  or with the left-hand Touch Control. The display messages will then be stored in the message memory.

Rectify the cause of a display message as quickly as possible.

High-priority display messages cannot be hidden. The driver's display will show these display messages continuously until the cause of the display message has been rectified.



Calling up saved display messages

Driver's display:



 Service





The **Message memory: XX**message appears on the driver's display.



 Scroll through the display messages by swiping upwards or downwards on the left-hand Touch Control.





 **To exit the display:** press the  back button.



Occupant safety

Display messages	Possible causes/consequences and ► Solutions
 <p data-bbox="118 350 445 412">Restraint system malfunction Consult workshop</p>	<p data-bbox="527 236 1185 267">* The restraint system is malfunctioning (→ page 94).</p> <div data-bbox="553 288 1984 584" style="border: 1px solid gray; padding: 10px;"> <p data-bbox="568 301 1430 332">⚠ DANGER Risk of fatal injuries due to restraint system malfunctions</p> <p data-bbox="574 350 1929 415">Components in the restraint system may be activated unintentionally or not deploy as planned in an accident. In the event of an accident, the high-voltage on-board electrical system may not be deactivated as intended.</p> <p data-bbox="574 425 1902 487">You may suffer an electric shock if you touch the damaged components of the high-voltage on-board electrical system.</p> <ul data-bbox="574 498 1766 570" style="list-style-type: none"> <li data-bbox="574 498 1766 529">► Have the restraint system checked and repaired immediately at a qualified specialist workshop. <li data-bbox="574 539 1255 570">► After an accident, switch off the vehicle immediately. </div> <p data-bbox="553 609 1022 640">Recognition of a restraint system fault:</p> <ul data-bbox="560 650 1719 726" style="list-style-type: none"> <li data-bbox="560 650 1678 681">• the  restraint system warning lamp does not light up when the vehicle is switched on <li data-bbox="560 692 1719 723">• the  restraint system warning lamp lights up continuously or repeatedly during a journey <p data-bbox="553 746 1226 778">► Consult a qualified specialist workshop immediately.</p>

Display messages	Possible causes/consequences and ► Solutions
 <p data-bbox="53 298 392 360">Front left malfunction Consult workshop</p>	<p data-bbox="466 184 1120 215">* The restraint system is malfunctioning (→ page 94).</p> <div data-bbox="492 236 1923 534" style="border: 1px solid gray; padding: 5px;"> <p data-bbox="502 246 1371 277">⚠ DANGER Risk of fatal injuries due to restraint system malfunctions</p> <p data-bbox="506 298 1866 360">Components in the restraint system may be activated unintentionally or not deploy as planned in an accident. In the event of an accident, the high-voltage on-board electrical system may not be deactivated as intended.</p> <p data-bbox="506 370 1845 433">You may suffer an electric shock if you touch the damaged components of the high-voltage on-board electrical system.</p> <ul data-bbox="506 448 1702 521" style="list-style-type: none"> <li data-bbox="506 448 1702 479">► Have the restraint system checked and repaired immediately at a qualified specialist workshop. <li data-bbox="506 490 1191 521">► After an accident, switch off the vehicle immediately. </div> <p data-bbox="486 557 956 588">Recognition of a restraint system fault:</p> <ul data-bbox="496 598 1661 676" style="list-style-type: none"> <li data-bbox="496 598 1620 629">• the  restraint system warning lamp does not light up when the vehicle is switched on <li data-bbox="496 640 1661 676">• the  restraint system warning lamp lights up continuously or repeatedly during a journey <p data-bbox="486 697 1160 728">► Consult a qualified specialist workshop immediately.</p>
 <p data-bbox="53 865 343 927">Front right malfunction Consult workshop</p>	<p data-bbox="466 751 1120 782">* The restraint system is malfunctioning (→ page 94).</p> <div data-bbox="492 802 1923 935" style="border: 1px solid gray; padding: 5px;"> <p data-bbox="502 813 1371 844">⚠ DANGER Risk of fatal injuries due to restraint system malfunctions</p> <p data-bbox="506 865 1866 927">Components in the restraint system may be activated unintentionally or not deploy as planned in an accident. In the event of an accident, the high-voltage on-board electrical system may not be deactivated as intended.</p> </div>

Display messages	Possible causes/consequences and ► Solutions
	<p>You may suffer an electric shock if you touch the damaged components of the high-voltage on-board electrical system.</p> <ul style="list-style-type: none"> ► Have the restraint system checked and repaired immediately at a qualified specialist workshop. ► After an accident, switch off the vehicle immediately. <p>Recognition of a restraint system fault:</p> <ul style="list-style-type: none"> • the  restraint system warning lamp does not light up when the vehicle is switched on • the  restraint system warning lamp lights up continuously or repeatedly during a journey <p>► Consult a qualified specialist workshop immediately.</p>
 <p>Second row of seats, left Malfunction Consult workshop</p>	<p>* The restraint system is malfunctioning (→ page 94).</p> <p>⚠ DANGER Risk of fatal injuries due to restraint system malfunctions</p> <p>Components in the restraint system may be activated unintentionally or not deploy as planned in an accident. In the event of an accident, the high-voltage on-board electrical system may not be deactivated as intended.</p> <p>You may suffer an electric shock if you touch the damaged components of the high-voltage on-board electrical system.</p> <ul style="list-style-type: none"> ► Have the restraint system checked and repaired immediately at a qualified specialist workshop. ► After an accident, switch off the vehicle immediately.

Display messages	Possible causes/consequences and ► Solutions
	<p>Recognition of a restraint system fault:</p> <ul style="list-style-type: none"> • the  restraint system warning lamp does not light up when the vehicle is switched on • the  restraint system warning lamp lights up continuously or repeatedly during a journey <p>► Consult a qualified specialist workshop immediately.</p>
 <p>Second row of seats, right Malfunction Consult work- shop</p>	<p>* The restraint system is malfunctioning (→ page 94).</p> <div data-bbox="492 425 1923 477" style="background-color: #e0e0e0; padding: 5px;"> <p>⚠ DANGER Risk of fatal injuries due to restraint system malfunctions</p> </div> <p>Components in the restraint system may be activated unintentionally or not deploy as planned in an accident. In the event of an accident, the high-voltage on-board electrical system may not be deactivated as intended. You may suffer an electric shock if you touch the damaged components of the high-voltage on-board electrical system.</p> <ul style="list-style-type: none"> ► Have the restraint system checked and repaired immediately at a qualified specialist workshop. ► After an accident, switch off the vehicle immediately. <p>Recognition of a restraint system fault:</p> <ul style="list-style-type: none"> • the  restraint system warning lamp does not light up when the vehicle is switched on • the  restraint system warning lamp lights up continuously or repeatedly during a journey <p>► Consult a qualified specialist workshop immediately.</p>



Display messages	Possible causes/consequences and ► Solutions
 <p data-bbox="118 301 455 363">Left window airbag malfunction Consult workshop</p>	<p data-bbox="527 184 1185 215">* The restraint system is malfunctioning (→ page 94).</p> <div data-bbox="553 236 1984 384" style="border: 1px solid gray; padding: 5px;"> <p data-bbox="564 249 1559 280">⚠ WARNING Risk of injury or fatal injury due to a malfunction in the windowbag</p> <p data-bbox="574 298 1888 329">The windowbag might be triggered unintentionally or might not be triggered at all in the event of an accident.</p> <p data-bbox="574 342 1708 373">► Have the windowbag checked and repaired immediately at a qualified specialist workshop.</p> </div> <p data-bbox="547 405 1228 436">► Consult a qualified specialist workshop immediately.</p>
 <p data-bbox="118 576 455 638">Right window airbag malfunction Consult workshop</p>	<p data-bbox="527 458 1185 490">* The restraint system is malfunctioning (→ page 94).</p> <div data-bbox="553 510 1984 658" style="border: 1px solid gray; padding: 5px;"> <p data-bbox="564 524 1559 555">⚠ WARNING Risk of injury or fatal injury due to a malfunction in the windowbag</p> <p data-bbox="574 572 1888 603">The windowbag might be triggered unintentionally or might not be triggered at all in the event of an accident.</p> <p data-bbox="574 617 1708 648">► Have the windowbag checked and repaired immediately at a qualified specialist workshop.</p> </div> <p data-bbox="547 679 1228 710">► Consult a qualified specialist workshop immediately.</p>
<p data-bbox="118 731 455 793">Front passenger airbag disabled See Owner's Manual</p>	<p data-bbox="527 733 1984 795">* The front passenger airbag has been disabled even though an adult or a person of adult build is on the front passenger seat. If additional forces are applied to the seat, the weight the system detects may be too low.</p> <div data-bbox="553 816 1984 939" style="border: 1px solid gray; padding: 5px;"> <p data-bbox="564 829 1698 860">⚠ WARNING - Risk of injury or even fatal injury when the front passenger airbag is disabled</p> <p data-bbox="574 878 1949 940">If the front passenger airbag is disabled, It will not be deployed in the event of an accident and cannot perform its intended protective function.</p> </div>

Display messages	Possible causes/consequences and ► Solutions
	<p>A person in the front passenger seat could then, for example, come into contact with the vehicle interior, especially if the person is sitting too close to the dashboard.</p> <p>► Be aware of the status of the front passenger airbag both before and during the journey.</p> <p>► Stop the vehicle immediately in accordance with the traffic conditions.</p> <p>► Make sure that no objects are trapped under the front passenger seat.</p> <p>► Check the status of automatic front passenger airbag shutoff (→ page 96).</p> <p>► If necessary, consult a qualified specialist workshop immediately.</p>
<p>Front passenger airbag enabled See Owner's Manual</p>	<p>* The front passenger airbag will be enabled while the vehicle is in motion in the following situations:</p> <ul style="list-style-type: none"> • even when a child, a small adult or an object weighing less than the system weight threshold is located on the front passenger seat • even when the front passenger seat is not occupied <p>The system may detect objects or forces that are adding to the weight applied to the seat.</p> <p>⚠ WARNING Risk of injury or death when using a child restraint system while the front passenger airbag is enabled</p> <p>If you secure a child in a child restraint system on the front passenger seat and the front passenger airbag is enabled, the front passenger airbag can deploy in the event of an accident.</p> <p>The child could be struck by the airbag.</p>



Display messages	Possible causes/consequences and ► Solutions
	<ul style="list-style-type: none"> <li data-bbox="553 192 1999 225">► Ensure, both before and during the journey, that the status of the front passenger airbag is correct. NEVER use a rearward facing child restraint on a seat protected by an ACTIVE AIRBAG in front of it, DEATH or SERIOUS INJURY to the CHILD can occur. <li data-bbox="553 344 1999 378">► Stop the vehicle immediately in accordance with the traffic conditions. <li data-bbox="553 389 1999 422">► Make sure that no objects are trapped under the front passenger seat. <li data-bbox="553 434 1999 467">► Check the status of automatic front passenger airbag shutoff (→ page 96). <li data-bbox="553 478 1999 511">► If necessary, consult a qualified specialist workshop immediately.



Key



Display messages	Possible causes/consequences and ► Solutions
 <p data-bbox="118 795 271 826">Replace key</p>	<ul style="list-style-type: none"> <li data-bbox="519 681 1999 714">* Have the key replaced. <li data-bbox="553 726 1999 759">► Consult a qualified specialist workshop.

Display messages	Possible causes/consequences and ► Solutions
 <p data-bbox="53 298 322 329">Change key batteries</p>	<ul style="list-style-type: none"> <li data-bbox="457 184 850 215">* The key battery is discharged. <li data-bbox="486 225 960 256">► Replace the battery (→ page 136).
 <p data-bbox="53 474 404 547">Key not detected (white display message)</p>	<ul style="list-style-type: none"> <li data-bbox="457 360 874 391">* The key is currently undetected. <li data-bbox="486 401 1079 433">► Change the location of the key in the vehicle. <li data-bbox="486 443 813 474">► Try to start the vehicle. <li data-bbox="486 484 1594 515">► If the key is still not detected, place it in the slot for starting with the key (→ page 256). <li data-bbox="486 526 739 557">► Start the vehicle.
 <p data-bbox="53 694 380 766">Key not detected (red display message)</p>	<ul style="list-style-type: none"> <li data-bbox="457 580 1553 611">* The key can no longer be detected during a journey and may no longer be in the vehicle. <p data-bbox="486 621 1291 652">If the key is no longer in the vehicle and you switch off the vehicle:</p> <ul style="list-style-type: none"> <li data-bbox="494 663 960 694">• You can no longer start the vehicle. <li data-bbox="494 704 981 735">• You cannot centrally lock the vehicle. <ul style="list-style-type: none"> <li data-bbox="486 756 968 787">► Ensure that the key is in the vehicle. <p data-bbox="486 818 1095 849">If the key is in the vehicle and is still not detected:</p> <ul style="list-style-type: none"> <li data-bbox="486 859 1385 890">► Stop the vehicle immediately in accordance with the traffic conditions. <li data-bbox="486 901 1438 932">► Place the key in the slot for starting the engine with the key (→ page 256).





Display messages	Possible causes/consequences and ► Solutions
	<p>The key battery is weak or discharged.</p> <ul style="list-style-type: none"> ► Check the battery using the indicator lamp (→ page 134). ► Replace the key battery, if necessary (→ page 136).
 <p>Key being taught in Please wait</p>	<ul style="list-style-type: none"> * The vehicle is processing in order to teach in the new key. <ul style="list-style-type: none"> ► Wait until processing is complete.
<p>Place the key in the marked space See Owner's Manual</p>	<ul style="list-style-type: none"> * Key detection is malfunctioning. <ul style="list-style-type: none"> ► Change the location of the key in the vehicle. ► Place the key in the slot for starting the engine with the key (→ page 256).
<p>Searching for key in stowage tray or Digital Vehicle Key in inductive charging bracket... See Owner's Manual</p>	<ul style="list-style-type: none"> * The key has not been detected. <ul style="list-style-type: none"> ► Place the key in the stowage compartment (→ page 256). <p>If the key is still not detected:</p> <ul style="list-style-type: none"> ► Consult a qualified specialist workshop. * The Digital Vehicle Key has not been detected. <ul style="list-style-type: none"> ► Place the Digital Vehicle Key in the stowage space (→ page 255).

Display messages	Possible causes/consequences and ► Solutions
 <p data-bbox="57 391 269 422">Key not detected</p>	<p data-bbox="486 184 1030 215">If the Digital Vehicle Key is still not detected:</p> <ul style="list-style-type: none"> <li data-bbox="486 225 1009 256">► Consult a qualified specialist workshop. <p data-bbox="466 277 1185 308">* The key or the Digital Vehicle Key is currently undetected.</p> <ul style="list-style-type: none"> <li data-bbox="486 319 1385 350">► Change the location of the key or the Digital Vehicle Key in the vehicle. <li data-bbox="486 360 813 391">► Try to start the vehicle. <li data-bbox="486 401 1598 433">► If the key is still not detected, place the key in the stowage compartment (→ page 256). <li data-bbox="486 443 1872 474">► If the Digital Vehicle Key is still not detected, place the Digital Vehicle Key in the stowage space (→ page 255). <li data-bbox="486 484 739 515">► Start the vehicle.
 <p data-bbox="57 660 404 754">Key not detected Place Digital Vehicle Key in inductive charging bracket</p>	<p data-bbox="466 547 1819 578">* The key or the Digital Vehicle Key are no longer detected during a journey and may no longer be in the vehicle.</p> <p data-bbox="486 588 1598 619">If the key or the Digital Vehicle Key is no longer in the vehicle and you switch off the vehicle:</p> <ul style="list-style-type: none"> <li data-bbox="494 629 960 660">• You can no longer start the vehicle. <li data-bbox="494 671 985 702">• You cannot centrally lock the vehicle. <ul style="list-style-type: none"> <li data-bbox="486 723 1279 754">► Ensure that the key or the Digital Vehicle Key is in the vehicle. <p data-bbox="486 785 1402 816">If the key or the Digital Vehicle Key is in the vehicle and is still not detected:</p> <ul style="list-style-type: none"> <li data-bbox="486 826 1385 857">► Stop the vehicle immediately in accordance with the traffic conditions. <li data-bbox="486 868 1238 899">► Place the key in the stowage compartment (→ page 256). <li data-bbox="486 909 1328 940">► Place the Digital Vehicle Key in the stowage space (→ page 255).

Display messages	Possible causes/consequences and ► Solutions
	<p>The key battery is weak or discharged.</p> <ul style="list-style-type: none"> ► Check the battery using the indicator lamp (→ page 134). ► Replace the key battery, if necessary (→ page 136). <p>The charge status of the rechargeable battery of the end device with the Digital Vehicle Key is too low.</p> <ul style="list-style-type: none"> ► Immediately charge the rechargeable battery of the Digital Vehicle Key end device. <p>Otherwise, it may not be possible to restart the vehicle after it has been switched off. If the key or the Digital Vehicle Key is still not detected:</p> <ul style="list-style-type: none"> ► Consult a qualified specialist workshop.
 <p>Replace key See Owner's Manual</p>	<ul style="list-style-type: none"> * If the Digital Vehicle Key is not renewed, the vehicle cannot be unlocked/locked or started. ► The system automatically renews the Digital Vehicle Key. When the renewal is complete, the message disappears and the Digital Vehicle Key is available again.
 <p>Do not forget key</p>	<ul style="list-style-type: none"> * A warning tone will also sound. This message reminds you to take your key with you when you leave the vehicle. This also applies to the Digital Vehicle Key.





Display messages	Possible causes/consequences and ► Solutions
 <p data-bbox="53 298 386 360">Digital Vehicle Key Charge device</p>	<ul style="list-style-type: none">* The charge status of the rechargeable battery of the end device with the Digital Vehicle Key is too low.<ul style="list-style-type: none">► Immediately charge the rechargeable battery of the Digital Vehicle Key end device.
 <p data-bbox="53 510 386 572">Key being taught in Please wait</p>	<ul style="list-style-type: none">* The vehicle is processing in order to teach in the new Digital Vehicle Key.<ul style="list-style-type: none">► Wait until processing is complete.
 <p data-bbox="53 720 386 782">Key does not belong to vehicle</p>	<ul style="list-style-type: none">* The vehicle cannot be unlocked/locked or started.<ul style="list-style-type: none">► Use the Digital Vehicle Key belonging to the vehicle.





Lights





Display messages	Possible causes/consequences and ► Solutions
 <p data-bbox="118 350 433 410">Malfunction See Owner's Manual</p>	<ul style="list-style-type: none"> <li data-bbox="519 236 1013 265">* The exterior lighting is malfunctioning. <ul style="list-style-type: none"> <li data-bbox="549 277 1075 306">► Consult a qualified specialist workshop. <li data-bbox="519 319 1177 348">* Vehicles with a trailer hitch: a fuse may have blown. <ul style="list-style-type: none"> <li data-bbox="549 360 1293 389">► Stop the vehicle in accordance with the traffic conditions. <li data-bbox="549 401 1336 430">► Check the fuses and replace them if necessary (→ page 48).
 <p data-bbox="118 572 416 632">Automatic driving lights inoperative</p>	<ul style="list-style-type: none"> <li data-bbox="519 458 1293 487">* The light sensor for automatic driving lights is malfunctioning. <ul style="list-style-type: none"> <li data-bbox="549 500 1075 529">► Consult a qualified specialist workshop.
 <p data-bbox="118 783 386 812">Switch on headlamps</p>	<ul style="list-style-type: none"> <li data-bbox="519 669 1099 698">* You are driving without low-beam headlamps. <ul style="list-style-type: none"> <li data-bbox="549 710 1208 739">► Turn the light switch to the  or AUTO position.





Display messages	Possible causes/consequences and ► Solutions
 <p data-bbox="57 298 261 329">Switch off lights</p>	<ul style="list-style-type: none"> <li data-bbox="461 184 1238 215">* You are leaving the vehicle and the lights are still switched on. <ul style="list-style-type: none"> <li data-bbox="486 225 1038 256">► Turn the light switch to the AUTO position.
<p data-bbox="57 360 372 420">DIGITAL LIGHT Functions limited</p>	<ul style="list-style-type: none"> <li data-bbox="461 360 1892 433">* The DIGITAL LIGHT system is malfunctioning. The lighting system will continue to work even without the functions of the DIGITAL LIGHT system. <ul style="list-style-type: none"> <li data-bbox="486 438 1013 469">► Consult a qualified specialist workshop.
<p data-bbox="57 484 359 544">Check low beam setting (left/right-side traffic)</p>	<ul style="list-style-type: none"> <li data-bbox="461 484 1054 515">* The type of traffic has been selected manually. <ul style="list-style-type: none"> <li data-bbox="486 526 1373 557">► Check the setting and change it manually if necessary (→ page 223).
<p data-bbox="57 578 363 679">Low beam setting (left/right-side traffic) Manual adjustment only</p>	<ul style="list-style-type: none"> <li data-bbox="461 578 1537 609">* The automatic headlamp conversion for left-hand/right-hand traffic has malfunctioned. <ul style="list-style-type: none"> <li data-bbox="486 619 1177 650">► Change the headlamps over manually (→ page 223).
<p data-bbox="57 702 384 803">Adaptive Highbeam Assist currently unavailable See Owner's Manual</p>	<ul style="list-style-type: none"> <li data-bbox="461 702 1128 785">* Adaptive Highbeam Assist is temporarily unavailable. The system limits have been reached (→ page 220). Once the cause of the problem is no longer present, the system will be available again. The Adaptive Highbeam Assist available again display message will appear. <ul style="list-style-type: none"> <li data-bbox="486 868 637 899">► Drive on <li data-bbox="486 909 1537 940">► Operate the high beam manually until Adaptive High Beam Assist is available again.





Display messages	Possible causes/consequences and ► Solutions
<p>Adaptive Highbeam Assist inoperative</p>	<p>* Adaptive Highbeam Assist is malfunctioning.</p> <ul style="list-style-type: none"> ► Drive on or ► Stop the vehicle in accordance with the traffic conditions and restart the vehicle. ► If the display message does not disappear: consult a qualified specialist workshop. ► Until then, operate the high beam manually.
<p>Adaptive Highbeam Assist Plus currently unavailable See Owner's Manual</p>	<p>* Adaptive Highbeam Assist Plus is temporarily unavailable. The system limits have been reached (→ page 222). Once the cause of the problem is no longer present, the system will be available again. The Adaptive Highbeam Assist Plus available again display message will appear.</p> <ul style="list-style-type: none"> ► Drive on ► Operate the high beam manually until Adaptive High Beam Assist Plus is available again.
<p>Adaptive Highbeam Assist Plus inoperative</p>	<p>* Adaptive Highbeam Assist Plus is malfunctioning.</p> <ul style="list-style-type: none"> ► Drive on or ► Stop the vehicle in accordance with the traffic conditions and restart the vehicle. ► If the display message does not disappear: consult a qualified specialist workshop. ► Until then, operate the high beam manually.





Display messages	Possible causes/consequences and ► Solutions
Hazard warning lamp system Malfunction	<ul style="list-style-type: none"> * The hazard warning lamp switch is malfunctioning. <ul style="list-style-type: none"> ► Consult a qualified specialist workshop.
 Front left parking lights	<ul style="list-style-type: none"> * The front left parking light is malfunctioning. <ul style="list-style-type: none"> ► Consult a qualified specialist workshop.
 Front right parking lights	<ul style="list-style-type: none"> * The front right parking light is malfunctioning. <ul style="list-style-type: none"> ► Consult a qualified specialist workshop.
 Left low beam	<ul style="list-style-type: none"> * The left low beam is malfunctioning. <ul style="list-style-type: none"> ► Consult a qualified specialist workshop.
 Right low beam	<ul style="list-style-type: none"> * The right low beam is malfunctioning. <ul style="list-style-type: none"> ► Consult a qualified specialist workshop.





Display messages	Possible causes/consequences and ► Solutions
 <p data-bbox="118 301 314 329">Left main beam</p>	<ul style="list-style-type: none"> <li data-bbox="519 184 1075 256">* The left high beam is malfunctioning. ► Consult a qualified specialist workshop.
 <p data-bbox="118 477 329 505">Right main beam</p>	<ul style="list-style-type: none"> <li data-bbox="519 363 1075 436">* The right high beam is malfunctioning. ► Consult a qualified specialist workshop.
 <p data-bbox="118 653 451 681">Left daytime running lights</p>	<ul style="list-style-type: none"> <li data-bbox="519 539 1156 612">* The left daytime running lights are malfunctioning. ► Consult a qualified specialist workshop.
 <p data-bbox="118 829 466 857">Right daytime running lights</p>	<ul style="list-style-type: none"> <li data-bbox="519 715 1242 788">* The right-hand daytime running lights are malfunctioning. ► Consult a qualified specialist workshop.

Display messages	Possible causes/consequences and ► Solutions
 Left cornering light	<ul style="list-style-type: none">* The left cornering light is malfunctioning.<ul style="list-style-type: none">► Consult a qualified specialist workshop.
 Right cornering light	<ul style="list-style-type: none">* The right cornering light is malfunctioning.<ul style="list-style-type: none">► Consult a qualified specialist workshop.
 Front left turn signal	<ul style="list-style-type: none">* The front left turn signal lamp is malfunctioning.<ul style="list-style-type: none">► Consult a qualified specialist workshop.
 Rear left turn signal	<ul style="list-style-type: none">* The rear left turn signal lamp is malfunctioning.<ul style="list-style-type: none">► Consult a qualified specialist workshop.

Display messages	Possible causes/consequences and ► Solutions
 <p data-bbox="118 298 390 329">Front right turn signal</p>	<ul style="list-style-type: none"> <li data-bbox="519 184 1146 215">* The front right turn signal lamp is malfunctioning. <li data-bbox="549 225 1075 256">► Consult a qualified specialist workshop.
 <p data-bbox="118 474 380 505">Rear right turn signal</p>	<ul style="list-style-type: none"> <li data-bbox="519 360 1136 391">* The rear right turn signal lamp is malfunctioning. <li data-bbox="549 401 1075 433">► Consult a qualified specialist workshop.
 <p data-bbox="118 650 390 681">Left mirror turn signal</p>	<ul style="list-style-type: none"> <li data-bbox="519 536 1228 567">* The turn signal lamp on the left mirror is malfunctioning. <li data-bbox="549 578 1075 609">► Consult a qualified specialist workshop.
 <p data-bbox="118 826 406 857">Right mirror turn signal</p>	<ul style="list-style-type: none"> <li data-bbox="519 712 1248 743">* The turn signal lamp on the right mirror is malfunctioning. <li data-bbox="549 754 1075 785">► Consult a qualified specialist workshop.



Display messages	Possible causes/consequences and ► Solutions
 Left brake lamp	<ul style="list-style-type: none">* The left brake light is malfunctioning.<ul style="list-style-type: none">► Consult a qualified specialist workshop.
 Right brake lamp	<ul style="list-style-type: none">* The right brake light is malfunctioning.<ul style="list-style-type: none">► Consult a qualified specialist workshop.
 Third brake lamp	<ul style="list-style-type: none">* The third brake light is malfunctioning.<ul style="list-style-type: none">► Consult a qualified specialist workshop.
 Left tail light	<ul style="list-style-type: none">* The left tail light is malfunctioning.<ul style="list-style-type: none">► Consult a qualified specialist workshop.



Display messages	Possible causes/consequences and ► Solutions
 <p data-bbox="118 298 294 329">Right tail light</p>	<ul style="list-style-type: none"> <li data-bbox="519 184 1075 256">* The right tail light is malfunctioning. ► Consult a qualified specialist workshop.
 <p data-bbox="118 478 294 509">Reversing light</p>	<ul style="list-style-type: none"> <li data-bbox="519 364 1075 437">* The reversing light is malfunctioning. ► Consult a qualified specialist workshop.
 <p data-bbox="118 654 294 685">Rear fog light</p>	<ul style="list-style-type: none"> <li data-bbox="519 540 1075 613">* The rear fog light is malfunctioning. ► Consult a qualified specialist workshop.
 <p data-bbox="118 830 355 861">Number plate lamp</p>	<ul style="list-style-type: none"> <li data-bbox="519 716 1075 789">* The number plate lamp is malfunctioning. ► Consult a qualified specialist workshop.

Display messages	Possible causes/consequences and ► Solutions
 <p data-bbox="53 298 322 329">Trailer left turn signal</p>	<ul style="list-style-type: none"><li data-bbox="455 184 1160 215">* The left turn signal lamp on the trailer is malfunctioning.<li data-bbox="486 225 1011 256">► Consult a qualified specialist workshop.
 <p data-bbox="53 474 339 505">Trailer right turn signal</p>	<ul style="list-style-type: none"><li data-bbox="455 360 1181 391">* The right turn signal lamp on the trailer is malfunctioning.<li data-bbox="486 401 1011 433">► Consult a qualified specialist workshop.
 <p data-bbox="53 650 282 681">Trailer brake lamp</p>	<ul style="list-style-type: none"><li data-bbox="455 536 1052 567">* The brake light on the trailer is malfunctioning.<li data-bbox="486 578 1011 609">► Consult a qualified specialist workshop.
 <p data-bbox="53 826 245 857">Trailer tail light</p>	<ul style="list-style-type: none"><li data-bbox="455 712 991 743">* A tail light on the trailer is malfunctioning.<li data-bbox="486 754 1011 785">► Consult a qualified specialist workshop.



Display messages	Possible causes/consequences and ► Solutions
<p>Inoperative indicator lamp in driver display. Consult workshop</p>	<ul style="list-style-type: none"> * An indicator lamp on the driver's display is defective. <ul style="list-style-type: none"> ► Consult a qualified specialist workshop.



Climate control

Display messages	Possible causes/consequences and ► Solutions
 <p>Currently unavailable High-voltage battery charging incomplete.</p>	<ul style="list-style-type: none"> * The high-voltage battery is charging. Pre-entry climate control cannot be switched on. <ul style="list-style-type: none"> ► Wait until the charging process has achieved a minimum state of charge.
 <p>Currently unavailable Charge high-voltage battery</p>	<ul style="list-style-type: none"> * The charge of the high-voltage battery is too low. Pre-entry climate control cannot be switched on. <ul style="list-style-type: none"> ► Charge the high-voltage battery (→ page 276).

Display messages	Possible causes/consequences and ► Solutions
 <p data-bbox="53 298 369 394">Pre-entry climate control via key available again after starting vehicle</p>	<ul style="list-style-type: none"><li data-bbox="466 184 1827 213">* You have attempted to switch on pre-entry climate control more than three times with the vehicle switched off.<ul style="list-style-type: none"><li data-bbox="486 225 1085 291">► Start the vehicle for ten seconds. Pre-entry climate control is operational again.
 <p data-bbox="53 543 384 671">Pre-entry climate control via key currently unavailable. High-voltage battery low</p>	<ul style="list-style-type: none"><li data-bbox="466 429 1678 458">* The charge of the high-voltage battery is too low. Pre-entry climate control cannot be switched on.<ul style="list-style-type: none"><li data-bbox="486 471 1790 536">► Charge the high-voltage battery (→ page 276). When the high-voltage battery is sufficiently charged, pre-entry climate control will be operational again.



Drive system

Display messages	Possible causes/consequences and ► Solutions
 <p data-bbox="118 350 441 410">Towing not permitted See Owner's Manual</p>	<ul style="list-style-type: none"> * The drive system is malfunctioning. <ul style="list-style-type: none"> ► Have the vehicle transported only using a transporter or trailer (→ page 618).
 <p data-bbox="118 559 441 619">Acoustic presence indicator inoperative</p>	<ul style="list-style-type: none"> * The sound generator (acoustic vehicle warning system) is malfunctioning. No vehicle noises are being produced. The vehicle may not be heard by other road users. <ul style="list-style-type: none"> ► Drive with particular care. ► Consult a qualified specialist workshop.
<p data-bbox="118 650 441 778">To switch off the vehicle, press the Start/Stop button for at least 3 seconds or 3 times</p>	<ul style="list-style-type: none"> * You have pressed the start/stop button while the vehicle is in motion. <ul style="list-style-type: none"> ► To switch off the drive system while the vehicle is in motion (→ page 253).
<p data-bbox="118 811 441 871">Cannot start vehicle See Owner's Manual</p>	<ul style="list-style-type: none"> * It is not possible to start the vehicle. A malfunction has occurred in the drive system. <ul style="list-style-type: none"> ► Switch the vehicle off and lock it.



Display messages	Possible causes/consequences and ► Solutions
	<ul style="list-style-type: none"> ► After waiting for a short time, unlock the vehicle and start it again. ► If the display message appears again and the vehicle does not start, consult a qualified specialist workshop.
 <p data-bbox="53 391 369 453">Top up coolant See Owner's Manual</p>	<p data-bbox="466 277 823 303">* The coolant level is too low.</p> <div data-bbox="492 329 1923 436" style="border: 1px solid black; padding: 5px;"> <p data-bbox="502 339 1304 370">! NOTE Damage to the drive system due to insufficient coolant</p> <ul style="list-style-type: none"> ► Avoid long journeys with insufficient coolant. </div> <ul style="list-style-type: none"> ► Have the cooling system of the drive system checked at a qualified specialist workshop.
 <p data-bbox="53 623 353 685">Coolant Stop Switch off the vehicle</p>	<p data-bbox="466 509 762 535">* The coolant is too hot.</p> <ul style="list-style-type: none"> ► Stop the vehicle immediately in accordance with the traffic conditions and switch off the drive system. <div data-bbox="492 613 1923 961" style="border: 1px solid black; padding: 5px;"> <p data-bbox="502 623 1171 654">▲ WARNING Risk of injury due to overheated vehicle</p> <p data-bbox="502 675 1896 737">If you open the bonnet in the event of an overheated vehicle or fire in the engine compartment, the following situations may occur:</p> <ul style="list-style-type: none"> • You may come into contact with hot gases. • You may come into contact with other escaping hot operating fluids. <ul style="list-style-type: none"> ► In the event of overheating or fire in the engine compartment, keep the bonnet closed and call the fire service. ► Allow the overheated vehicle to cool down first if you need to open the bonnet. </div>



Display messages	Possible causes/consequences and ► Solutions
	<ul style="list-style-type: none"> ► Wait until the drive system has cooled down. ► Make sure that the air supply to the vehicle radiator is not obstructed. ► Avoiding high loads on the drive system, drive to the nearest qualified specialist workshop.
	<ul style="list-style-type: none"> * The cooling system has detected a component fault. ► Avoiding high loads on the drive system, drive to the nearest qualified specialist workshop.
<p>Socket flap blocked Please open manually</p>	<ul style="list-style-type: none"> * The socket flap is not opening automatically. An obstruction may be hindering the opening process. ► Make sure that no objects are in the opening area. ► Open the socket flap again.
<p>Please close socket flap manually. Anti-entrapment active</p>	<ul style="list-style-type: none"> * The socket flap is not closing automatically. An obstruction may be hindering the closing process. ► Make sure that no objects are in the closing area. ► Close the socket flap again.
<p>Please close socket flap manually. Automatic function inoperative</p>	<ul style="list-style-type: none"> * The socket flap is not closing automatically. The motor of the socket flap may be defective. ► Close the socket flap manually. ► Consult a qualified specialist workshop.

Display messages	Possible causes/consequences and ► Solutions
 <p>Charger cable connected</p>	<ul style="list-style-type: none"> * You cannot pull away while the charging cable is connected. <ul style="list-style-type: none"> ► Disconnect the charging cable from the vehicle.
<p>Not possible to unlock charging cable See Owner's Manual</p>	<ul style="list-style-type: none"> * The charging cable connector cannot be removed from the charging station's socket. <ul style="list-style-type: none"> ► Press the EMERGENCY OFF switch on the charging station. <p>If the charging cable connector cannot be removed after that:</p> <ul style="list-style-type: none"> ► Request service personnel from the operator of the charging station via the emergency call button or the emergency numbers attached to the charging station.
<p>Vehicle not currently being charged Charging station fault</p>	<ul style="list-style-type: none"> * A malfunction has occurred in the charging station or the RFID card is not recognised. <ul style="list-style-type: none"> ► Start the charging process at a different charging station. or ► Have the RFID card checked to ensure it is functioning.
<p>Charging fault Please change charging method See Owner's Manual</p>	<ul style="list-style-type: none"> * A temporary malfunction has occurred in the charging station. <ul style="list-style-type: none"> ► Wait until the malfunction has passed. or ► Start the charging process at a different charging station.





Display messages	Possible causes/consequences and ► Solutions
<p>AC charging inoperative Consult workshop</p>	<ul style="list-style-type: none"> * The charging process cannot be started due to a malfunction. <ul style="list-style-type: none"> ► Consult a qualified specialist workshop.
<p>DC charging inoperative Consult workshop</p>	<ul style="list-style-type: none"> * The charging process cannot be started due to a malfunction. <ul style="list-style-type: none"> ► Consult a qualified specialist workshop.
<p>Reduced drive system performance See Owner's Manual</p>	<ul style="list-style-type: none"> * The drive system is outside the normal operating temperature range, e.g. due to extremely low or high outside temperatures. Drive system power output is reduced. The yellow  reduced-power warning lamp is on. Once the operating temperature of the drive system returns to normal (e.g. after a short trip), the full output will be available again. The display message and the yellow  reduced-power warning lamp will go out. <ul style="list-style-type: none"> ► Drive on carefully. * The high-voltage battery is not charged sufficiently. Drive system power output is reduced. The yellow  reduced-power warning lamp is on. <ul style="list-style-type: none"> ► Drive on carefully. ► Charge the high-voltage battery immediately. * If the drive system power output is still reduced, there is a fault in the drive system. <ul style="list-style-type: none"> ► Drive on carefully. ► Consult a qualified specialist workshop.

Display messages	Possible causes/consequences and ► Solutions
<p>Please charge the high-voltage battery. Otherwise the vehicle may not start</p>	<ul style="list-style-type: none"> * Due to a possible drop in temperature of the high-voltage battery, the starting ability or the range may drop significantly until the vehicle is restarted. <ul style="list-style-type: none"> ► Charge the high-voltage battery (→ page 276).
<p>Please wait in READY status Warming battery See Owner's Manual</p>	<ul style="list-style-type: none"> * Operational readiness is established READY and the transmission position P is engaged. The high-voltage battery is warmed up to the operating temperature. This process can take a few minutes and may be prolonged if defrosting of the windscreen MAX is activated. The heating process ends when transmission position D is engaged. However, when you are driving, the output will be significantly limited until the high-voltage battery has reached its operating temperature.
<p>Preparing drive system...</p>	<ul style="list-style-type: none"> * The insulation of the drive system is being tested. This process can last for up to ten seconds.
<div data-bbox="63 578 261 681" data-label="Image"> </div> <p>Battery capacity too low Stop Charge immediately</p>	<ul style="list-style-type: none"> * The charge level of the high-voltage battery is so low that it is no longer possible to drive the vehicle. The drive system can no longer be restarted. When the drive system is restarted, the message Battery capacity too low Stop Charge immediately will appear again. <ul style="list-style-type: none"> ► Stop the vehicle immediately in accordance with the traffic conditions. ► Charge the high-voltage battery (→ page 276).

Display messages	Possible causes/consequences and ► Solutions
 <p data-bbox="118 301 455 394">Battery overheated Stop, everybody out! Outdoors if possible</p>	<ul style="list-style-type: none"> <li data-bbox="527 184 1310 215">* The high-voltage battery has overheated. There is a risk of fire. <ul style="list-style-type: none"> <li data-bbox="553 228 1447 260">► Stop the vehicle immediately in accordance with the traffic conditions. <li data-bbox="553 270 1663 301">► If possible, stop the vehicle in the open air and ensure that all vehicle occupants get out. <li data-bbox="553 319 1923 353">◉ Supporting vehicle functions may activate automatically, e.g. air-recirculation mode as part of climate control. <li data-bbox="553 363 887 394">► Do not continue driving. <li data-bbox="553 405 1555 436">► If smoke is present, leave the danger zone and call the fire service immediately. <li data-bbox="553 446 1590 477">► Consult a qualified specialist workshop even if there are no external signs of a fire.
 <p data-bbox="118 620 267 651">Malfunction</p>	<ul style="list-style-type: none"> <li data-bbox="527 503 1357 534">* The drive system is malfunctioning. A warning tone will also sound. <ul style="list-style-type: none"> <li data-bbox="553 544 1075 576">► Consult a qualified specialist workshop.
 <p data-bbox="118 796 457 827">Malfunction Visit workshop</p>	<ul style="list-style-type: none"> <li data-bbox="527 679 977 710">* The drive system is malfunctioning. <ul style="list-style-type: none"> <li data-bbox="553 721 1075 752">► Consult a qualified specialist workshop.

Display messages	Possible causes/consequences and ► Solutions
 <p data-bbox="53 298 400 391">Have high-voltage system checked See Owner's Manual</p>	<ul style="list-style-type: none"> * A function restriction has occurred in the drive system. <ul style="list-style-type: none"> ► Consult a qualified specialist workshop.
<p data-bbox="53 422 384 488">Consult workshop without starting the vehicle again</p>	<ul style="list-style-type: none"> * It is not possible to restart the drive system due to a malfunction. <ul style="list-style-type: none"> ► Do not switch off the drive system; drive on to the nearest qualified specialist workshop.
 <p data-bbox="53 637 384 696">Output and range reduced See Owner's Manual</p>	<ul style="list-style-type: none"> * A malfunction has occurred in the high-voltage battery. Output and range will be severely restricted. <ul style="list-style-type: none"> ► Switch the vehicle off and lock it. ► After waiting for a short time, unlock the vehicle and start it again. <p data-bbox="486 709 944 740">If the display message appears again:</p> <ul style="list-style-type: none"> ► Drive on carefully. ► Fully charge the high-voltage battery (→ page 276). <p data-bbox="486 854 1488 885">If the output and range are still reduced, there is a malfunction in the drive system.</p> <ul style="list-style-type: none"> ► Drive on carefully. ► Consult a qualified specialist workshop.

Display messages	Possible causes/consequences and ► Solutions
<p>Cannot start vehicle See Owner's Manual</p>	<p>* It is not possible to start the vehicle. A malfunction has occurred in the drive system.</p> <ul style="list-style-type: none"> ► Switch the vehicle off and lock it. ► After waiting for a short time, unlock the vehicle and start it again. ► If the display message appears again and the vehicle does not start, consult a qualified specialist workshop.
<p>Drive malfunction Achievable speed limited Stop soon</p>	<p>* The drive system is malfunctioning. The maximum vehicle speed is restricted. The drive system will shut off within a few kilometres.</p> <ul style="list-style-type: none"> ► Stop the vehicle immediately in accordance with the traffic conditions and switch off the drive system. Do not continue driving. ► Do not tow the vehicle; stop towing if necessary. ► Consult a qualified specialist workshop.
<p>Drive malfunction Achievable speed severely limited See Owner's Manual</p>	<p>* The drive system is malfunctioning. The maximum vehicle speed is restricted.</p> <ul style="list-style-type: none"> ► Consult a qualified specialist workshop.

Display messages	Possible causes/consequences and ► Solutions
 <p data-bbox="53 298 390 363">Reserve level Charge high-voltage battery</p>	<ul style="list-style-type: none">* The charge level of the high-voltage battery has dropped into the reserve range.<ul style="list-style-type: none">► Charge the high-voltage battery (→ page 276).
 <p data-bbox="53 510 206 534">Malfunction</p>	<ul style="list-style-type: none">* The drive system is malfunctioning. The output of your vehicle is restricted.<ul style="list-style-type: none">► Consult a qualified specialist workshop.
 <p data-bbox="53 686 390 710">Stop Switch off the vehicle</p>	<ul style="list-style-type: none">* The drive system is malfunctioning.<ul style="list-style-type: none">► Stop the vehicle immediately in accordance with the traffic conditions and switch off the drive system. Do not continue driving.► Do not tow the vehicle; stop towing if necessary.► Consult a qualified specialist workshop.
 <p data-bbox="53 899 390 923">Malfunction Visit workshop</p>	<ul style="list-style-type: none">* The drive system is malfunctioning.<ul style="list-style-type: none">► Consult a qualified specialist workshop.

Display messages	Possible causes/consequences and ► Solutions
 <p data-bbox="118 301 451 360">Performance severely limited</p>	<p data-bbox="527 184 1218 215">* A malfunction has occurred in the high-voltage battery. Output and range will be severely restricted.</p> <ul style="list-style-type: none"> <li data-bbox="553 270 997 301">► Switch the vehicle off and lock it. <li data-bbox="553 314 1396 346">► After waiting for a short time, unlock the vehicle and start it again. <p data-bbox="553 377 1003 408">If the display message appears again:</p> <ul style="list-style-type: none"> <li data-bbox="553 421 813 452">► Drive on carefully. <li data-bbox="553 466 1224 497">► Fully charge the high-voltage battery (→ page 276). <p data-bbox="553 527 1551 558">If the output and range are still reduced, there is a malfunction in the drive system.</p> <ul style="list-style-type: none"> <li data-bbox="553 571 813 602">► Drive on carefully. <li data-bbox="553 616 1073 647">► Consult a qualified specialist workshop.
<p data-bbox="118 660 437 826">High-voltage battery malfunction. No start in approx. XXX km Consult workshop (yellow display message)</p>	<p data-bbox="527 660 1218 692">* A malfunction has occurred in the high-voltage battery. It will no longer be possible to start the electric drive system after the distance displayed has been covered.</p> <ul style="list-style-type: none"> <li data-bbox="553 746 1954 778">► Have the necessary maintenance work on the high-voltage battery carried out at a qualified specialist workshop.

Display messages	Possible causes/consequences and ► Solutions
<p>High-voltage battery malfunction. No start in approx. XXX km Consult workshop (red display message)</p>	<p>* A malfunction has occurred in the high-voltage battery. It will no longer be possible to start the electric drive system after the distance displayed has been covered.</p> <p>► Have the necessary maintenance work on the high-voltage battery carried out immediately at a qualified specialist workshop.</p>
<p>High-voltage battery malfunction. Consult workshop without starting the vehicle again</p>	<p>* A malfunction has occurred in the high-voltage battery. It will no longer be possible to restart the drive system once it has been switched off.</p> <p>► Do not switch off the drive system; drive on to the nearest qualified specialist workshop.</p>

Vehicle

Display messages	Possible causes/consequences and ► Solutions
	<p>* The driver's display is inoperative due to a failed software update. The display message will be shown every time the engine is started.</p> <p>⚠ WARNING Risk of accident due to failure of the driver display</p> <p>In the event that the driver display fails or malfunctions, you will not recognise function restrictions affecting systems relevant to safety. This may impair operating safety.</p> <p>► Park the vehicle safely as soon as possible and notify a qualified specialist workshop.</p>

Display messages	Possible causes/consequences and ► Solutions
	<p>If the driver's display fails, you may not recognise function restrictions affecting systems relevant to safety or the speed display, for example. The operating safety of the vehicle may be impaired (→ page 466).</p> <ul style="list-style-type: none"> ► Have the vehicle checked by a qualified specialist workshop immediately.
<p>Vehicle is ready to drive Shutdown occurs when locked or automatically in a few minutes</p>	<ul style="list-style-type: none"> * You are leaving the vehicle in a ready-to-drive state. <ul style="list-style-type: none"> ► Get out of the vehicle, secure it against rolling away and take the key with you. ► If you do not leave the vehicle, switch off the electrical consumers, e.g. the seat heating. Otherwise, the 12 V battery may discharge and starting the engine may be possible only with the help of a second battery (jump start).
 <p>Trailer coupling Check lock (white display message)</p>	<ul style="list-style-type: none"> * The trailer hitch is not operational during a journey with a trailer. <div style="background-color: #cccccc; padding: 5px; margin: 5px 0;"> <p>▲ WARNING Risk of an accident if the ball neck is not locked</p> </div> <p>The trailer may become detached.</p> <ul style="list-style-type: none"> ► Stop the vehicle immediately in accordance with the traffic conditions. Do not continue driving. ► Uncouple the trailer and secure it against rolling away. ► Initiate a new swivelling procedure and do not re-couple the trailer until the display message disappears. ► Stop immediately in accordance with the traffic conditions and switch off the vehicle. ► Uncouple the trailer and secure it against rolling away. ► Initiate a new swivel movement (→ page 36). ► When the display message disappears, couple up the trailer and drive on.

Display messages	Possible causes/consequences and ► Solutions
	<p>If the display message does not disappear, the trailer hitch is malfunctioning and the ball neck is not locked.</p> <ul style="list-style-type: none">► Do not couple up the trailer. Drive on without the trailer. Note the reduced ground clearance due to the unlocked ball neck.► Consult a qualified specialist workshop. <p>* When the vehicle is stationary with a coupled trailer, the trailer hitch is not operational.</p> <ul style="list-style-type: none">► Uncouple the coupled trailer and secure it against rolling away.► If the ball neck has been folded in: unlock the ball neck (→ page 36).► Swivel the ball neck into the end position manually and let it engage.► If the ball neck has been folded out: unlock the ball neck (→ page 36).► Swivel the ball neck beneath the bumper manually and let it engage. <p>If the display message does not disappear, the trailer hitch is malfunctioning and the ball neck is not locked.</p> <ul style="list-style-type: none">► Do not couple up the trailer. Drive on without the trailer. Note the reduced ground clearance due to the unlocked ball neck.► Consult a qualified specialist workshop.

Display messages



Trailer coupling Check
lock (red display message)

Possible causes/consequences and ► Solutions

- * The trailer hitch is not operational during a journey with a trailer.

⚠ WARNING Risk of an accident if the ball neck is not locked

The trailer may become detached.

- Stop the vehicle immediately in accordance with the traffic conditions. Do not continue driving.
- Uncouple the trailer and secure it against rolling away.
- Initiate a new swivelling procedure and do not re-couple the trailer until the display message disappears.

- Stop immediately in accordance with the traffic conditions and switch off the vehicle.
- Uncouple the trailer and secure it against rolling away.
- Initiate a new swivel movement (→ page 36).
- When the display message disappears, couple up the trailer and drive on.



If the display message does not disappear, the trailer hitch is malfunctioning and the ball neck is not locked.



- Do not couple up the trailer. Drive on without the trailer. Note the reduced ground clearance due to the unlocked ball neck.
- Consult a qualified specialist workshop.



- * When the vehicle is stationary with a coupled trailer, the trailer hitch is not operational.



- Uncouple the coupled trailer and secure it against rolling away.
- **If the ball neck has been folded in:** unlock the ball neck (→ page 36).



Display messages	Possible causes/consequences and ► Solutions
	<ul style="list-style-type: none"> ► Swivel the ball neck into the end position manually and let it engage. ► If the ball neck has been folded out: unlock the ball neck (→ page 36). ► Swivel the ball neck beneath the bumper manually and let it engage. <p>If the display message does not disappear, the trailer hitch is malfunctioning and the ball neck is not locked.</p> <ul style="list-style-type: none"> ► Do not couple up the trailer. Drive on without the trailer. Note the reduced ground clearance due to the unlocked ball neck. ► Consult a qualified specialist workshop.
Head-up display currently unavailable See Owner's Manual	<p>* The head-up display is temporarily unavailable. Possible causes:</p> <ul style="list-style-type: none"> • malfunctions in the power supply • signal interference <ul style="list-style-type: none"> ► Stop in accordance with the traffic conditions and switch the vehicle off and on again. ► If the display message still appears, consult a qualified specialist workshop.
Head-up display inoperative	<p>* The head-up display has an internal error.</p> <ul style="list-style-type: none"> ► Consult a qualified specialist workshop.
Head-up display Brightness currently reduced See Owner's Manual	<p>* The brightness of the head-up display is reduced. Possible causes:</p> <ul style="list-style-type: none"> • Dirt on the windscreen in the camera's field of vision • Faulty exterior brightness signals



Display messages	Possible causes/consequences and ► Solutions
	<ul style="list-style-type: none"> ► Switch on the windscreen wipers. ► Clean the windscreen if necessary. ► Switch the vehicle off and switch it back on ► If the display message still appears, consult a qualified specialist workshop.
 <p>Steering malfunction Drive carefully Visit workshop</p>	<p>* A power steering malfunction has occurred. Steering characteristics may be impaired as a result.</p> <ul style="list-style-type: none"> ► Drive on carefully. ► Consult a qualified specialist workshop.
 <p>Steering malfunction Increased physical effort See Owner's Manual</p>	<p>* The power steering assistance is malfunctioning.</p> <div style="background-color: #f0f0f0; padding: 5px; border: 1px solid #ccc;"> <p>⚠ WARNING Risk of an accident due to altered steering characteristics</p> <p>If the power assistance of the steering fails partially or completely, you will need to use more force to steer.</p> <ul style="list-style-type: none"> ► If safe steering is possible, drive on carefully. ► Visit or consult a qualified specialist workshop immediately. </div> <ul style="list-style-type: none"> ► If safe steering is possible, drive on carefully. ► Visit or consult a qualified specialist workshop immediately.

Display messages	Possible causes/consequences and ► Solutions
 <p data-bbox="53 298 384 391">Steering malfunction Stop immediately See Owner's Manual</p>	<p data-bbox="466 184 1389 213">* The steering is malfunctioning. Steering capability is significantly impaired.</p> <div data-bbox="492 236 1923 456" style="border: 1px solid gray; padding: 5px;"> <p data-bbox="502 246 1279 275">⚠ WARNING Risk of accident if steering capability is impaired</p> <p data-bbox="513 298 1600 327">If the steering does not function as intended, the vehicle's operating safety is jeopardised.</p> <ul style="list-style-type: none"> <li data-bbox="513 339 1851 399">► Pull over and stop the vehicle safely as soon as possible, paying attention to road and traffic conditions. Do not continue driving under any circumstances. <li data-bbox="513 415 1034 444">► Consult a qualified specialist workshop. </div> <ul style="list-style-type: none"> <li data-bbox="486 480 1682 509">► Stop the vehicle immediately in accordance with the traffic conditions. Do not continue driving. <li data-bbox="486 525 1009 554">► Consult a qualified specialist workshop.
 <p data-bbox="53 692 339 752">Rear axle steering currently malfunctioning</p>	<p data-bbox="466 578 1533 607">* The rear-axle steering is temporarily unavailable. The turning circle may become wider.</p> <ul style="list-style-type: none"> <li data-bbox="486 622 1510 651">► Stop the vehicle in accordance with the traffic conditions and restart the vehicle. <p data-bbox="486 681 1005 710">If the display message does not disappear:</p> <ul style="list-style-type: none"> <li data-bbox="486 726 752 755">► Drive on carefully. <li data-bbox="486 770 1009 799">► Consult a qualified specialist workshop.

Display messages	Possible causes/consequences and ► Solutions
 <p data-bbox="118 298 461 363">Rear axle steering Malfunction Visit workshop</p>	<ul style="list-style-type: none"> <li data-bbox="527 184 1412 301">* The rear axle steering is malfunctioning. The rear axle has no steering capability. The steering wheel may be at an angle when you drive in a straight line. <li data-bbox="553 311 1085 342">► Adapt your speed and drive on carefully. <li data-bbox="553 353 1228 384">► Consult a qualified specialist workshop immediately.
 <p data-bbox="118 523 461 588">Rear axle steering Malfunction Stop immediately</p>	<ul style="list-style-type: none"> <li data-bbox="527 409 1958 598">* The rear axle steering is malfunctioning. The rear axle has no steering capability. The steering wheel may be tilted considerably when you drive in a straight line. Depending on the steering wheel's tilted position, the steering wheel will also vibrate and a continuous warning tone will sound. <div data-bbox="553 619 1984 671" style="background-color: #e0e0e0; padding: 5px;"> <p data-bbox="568 632 1344 664">⚠ WARNING Risk of accident if steering capability is impaired</p> </div> <div data-bbox="553 681 1984 840" style="border: 1px solid #ccc; padding: 5px;"> <p data-bbox="574 684 1663 715">If the steering does not function as intended, the vehicle's operating safety is jeopardised.</p> <ul style="list-style-type: none"> <li data-bbox="574 726 1913 788">► Pull over and stop the vehicle safely as soon as possible, paying attention to road and traffic conditions. Do not continue driving under any circumstances. <li data-bbox="574 798 1095 829">► Consult a qualified specialist workshop. </div> <ul style="list-style-type: none"> <li data-bbox="553 866 1745 897">► Stop the vehicle immediately in accordance with the traffic conditions. Do not continue driving. <li data-bbox="553 907 1275 938">► When stopping, bear the enlarged vehicle width in mind.

Display messages	Possible causes/consequences and ► Solutions
	<ul style="list-style-type: none"> ► Consult a qualified specialist workshop.
Snow chain mode Maximum speed exceeded	<ul style="list-style-type: none"> * The maximum permissible speed for snow chain mode has been exceeded. ► Drive more slowly.
Active bonnet malfunction See Owner's Manual	<ul style="list-style-type: none"> * The active bonnet (pedestrian protection) is malfunctioning or inoperative after having already been triggered. ► Consult a qualified specialist workshop.
Ambient light warning support inoperative	<ul style="list-style-type: none"> * The ambient lighting may not provide full visual warning support. ► Lock the vehicle and unlock it again after a few minutes. ► If the display message appears regularly, contact a qualified specialist workshop.
	<ul style="list-style-type: none"> * At least one door is open. ► Close all doors.
	<ul style="list-style-type: none"> * The bonnet is open. <div style="background-color: #f0f0f0; padding: 5px; margin-top: 10px;"> <p>▲ WARNING Risk of accident due to driving with the bonnet unlocked</p> <p>The bonnet may open and block your view.</p> <ul style="list-style-type: none"> ► Never release the bonnet when driving. ► Before every trip, ensure that the engine bonnet is locked. </div>

Display messages	Possible causes/consequences and ► Solutions
	<ul style="list-style-type: none"> ► Stop the vehicle immediately in accordance with the traffic conditions. ► Do not continue driving. ► Consult a qualified specialist workshop.
	<ul style="list-style-type: none"> * The boot lid is open. ► Close the boot lid.
 <p data-bbox="118 567 453 629">Rear left seat backrest not locked</p>	<ul style="list-style-type: none"> * The seat backrest of the corresponding seat is not engaged. ► Fold the seat backrest back until it engages.
 <p data-bbox="118 778 421 840">Rear right seat backrest not locked</p>	<ul style="list-style-type: none"> * The seat backrest of the corresponding seat is not engaged. ► Fold the seat backrest back until it engages.

Display messages	Possible causes/consequences and ► Solutions
 <p data-bbox="53 298 298 329">Top up washer fluid</p>	<ul style="list-style-type: none"> * The washer fluid level in the washer fluid reservoir has dropped below the minimum. <ul style="list-style-type: none"> ► Top up the washer fluid (→ page 23).
 <p data-bbox="53 477 333 508">Washer fluid flap open</p>	<ul style="list-style-type: none"> * The washer fluid filler flap is open. <ul style="list-style-type: none"> ► Close washer fluid filler flap (→ page 23).
<p data-bbox="53 536 282 567">Wiper Malfunction</p>	<ul style="list-style-type: none"> * The windscreen wiper is malfunctioning. <ul style="list-style-type: none"> ► Restart the vehicle. <p data-bbox="486 643 921 674">If the display message still appears:</p> <ul style="list-style-type: none"> ► Consult a qualified specialist workshop.

Transmission

Display messages	Possible causes/consequences and ► Solutions
<p data-bbox="53 891 390 954">Only select P when vehicle is stationary</p>	<ul style="list-style-type: none"> * It is possible to select the park position P only if the vehicle is stationary. <ul style="list-style-type: none"> ► Depress the brake pedal to stop.



Display messages	Possible causes/consequences and ► Solutions
Apply brake to deselect P position	<ul style="list-style-type: none"> ► Shift the transmission to park position P when the vehicle is stationary. <p>* You have attempted to shift the transmission out of park position P and into another transmission position.</p> <ul style="list-style-type: none"> ► Depress the brake pedal. ► Select transmission position D, R or neutral N.
Apply brake and start vehicle to shift out of P or N	<p>* You have attempted to shift the transmission out of park position P or neutral N and into another transmission position.</p> <ul style="list-style-type: none"> ► Depress the brake pedal. ► Start the vehicle. ► Change the transmission position.
Apply brake to engage D or R	<p>* You have attempted to select transmission position D or R.</p> <ul style="list-style-type: none"> ► Depress the brake pedal. ► Select transmission position D or R.
Apply brake to engage R	<p>* You have attempted to select transmission position R.</p> <ul style="list-style-type: none"> ► Depress the brake pedal. ► Select transmission position R.
Apply parking brake to park Visit workshop	<p>* A malfunction has occurred in the emergency power supply to park position P.</p> <ul style="list-style-type: none"> ► Consult a qualified specialist workshop.





Display messages	Possible causes/consequences and ► Solutions
	<ul style="list-style-type: none"> ► Until then, always select park position P manually before you switch off the vehicle. ► Before leaving the vehicle, apply the electric parking brake.
Risk of vehicle rolling away Driver's door open Transmission not in P	<p>* The driver's door is not fully closed and transmission position D, R or neutral N is selected. The vehicle may roll away.</p> <ul style="list-style-type: none"> ► Select park position P when switching off the vehicle.
Risk of vehicle rolling away Apply parking brake to park	<p>* The transmission is malfunctioning. Park position P cannot be selected.</p> <ul style="list-style-type: none"> ► Park the vehicle safely. ► Use the electric parking brake to secure the vehicle against rolling away. ► On gradients, turn the front wheels so that the vehicle will roll towards the kerb if it starts moving.
Risk of vehicle rolling away N activated manually No automatic switch to P	<p>* While the vehicle was at a standstill or driving at very low speed, neutral N was engaged with the drive system or the vehicle switched on.</p> <div style="border: 1px solid black; padding: 5px; margin-top: 10px;"> <p>! NOTE Damage to the vehicle due to rolling away</p> <p>When the vehicle is switched off or the driver's door is opened, automatic engagement of park position P is deactivated. The vehicle may roll away.</p> <ul style="list-style-type: none"> ► Be ready to brake. ► Do not leave the vehicle unattended. </div>



Display messages	Possible causes/consequences and ► Solutions
	<ul style="list-style-type: none"> ► Depress the brake pedal until the vehicle comes to a standstill. ► Engage park position P when the vehicle is stationary with the brake pedal depressed. ► To continue driving with the brake pedal depressed, select transmission position D or R.
<p>N automatically activated Please engage transmission position again</p>	<ul style="list-style-type: none"> * Neutral N was automatically engaged when the vehicle was rolling or being driven. ⓘ When you open the driver's door in neutral N, park position P will be engaged automatically. ► Engage park position P when the vehicle is stationary with the brake pedal depressed. ► To continue driving with the brake pedal depressed, select transmission position D or R.
<p>N is selected Please select desired transmission position</p>	<ul style="list-style-type: none"> * The accelerator pedal was depressed while the vehicle was rolling or moving in neutral N. ► To accelerate the vehicle, select transmission position D or R.
<p>Reversing not poss. Consult workshop</p>	<ul style="list-style-type: none"> * The transmission is malfunctioning. It is not possible to select transmission position R. ► Consult a qualified specialist workshop.
<p>Transmission Malfunction Stop</p>	<ul style="list-style-type: none"> * The transmission is malfunctioning. The transmission shifts to neutral N automatically. ► Stop the vehicle immediately in accordance with the traffic conditions. ► Depress the brake pedal. ► Engage park position P. ► Consult a qualified specialist workshop.





Display messages	Possible causes/consequences and ► Solutions
Consult workshop without changing the transmission position	<ul style="list-style-type: none"> * The transmission is malfunctioning. It is no longer possible to change the transmission position. <ul style="list-style-type: none"> ► If transmission position D is selected, consult a qualified specialist workshop and do not change the transmission position. ► For all other transmission positions, park the vehicle safely. ► Consult a qualified specialist workshop.
Auxiliary battery malfunction (white display message)	<ul style="list-style-type: none"> * There is a malfunction in the auxiliary battery. <ul style="list-style-type: none"> ► Consult a qualified specialist workshop. ► Until then, always select park position P manually before you switch off the vehicle. ► Before leaving the vehicle, apply the electric parking brake.



Brakes

Display messages	Possible causes/consequences and ► Solutions
 <p>Parking brake See Owner's Manual</p>	<ul style="list-style-type: none"> * The yellow  indicator lamp is lit. The electric parking brake is malfunctioning. <p>To apply:</p> <ul style="list-style-type: none"> ► Switch the vehicle off and switch it back on ► Apply the electric parking brake manually (→ page 300). <p>If it is not possible to apply the electric parking brake:</p>

Display messages	Possible causes/consequences and ► Solutions
	<ul style="list-style-type: none"> ► Consult a qualified specialist workshop. ► Where necessary, also secure the parked vehicle against rolling away. <p>* The yellow  indicator lamp and the red  indicator lamp are lit. The electric parking brake is malfunctioning.</p> <p>To release:</p> <ul style="list-style-type: none"> ► Switch the vehicle off and switch it back on ► Release the electric parking brake manually (→ page 300). <p>or</p> <ul style="list-style-type: none"> ► Release the electric parking brake automatically (→ page 300). <p>If it is still not possible to release the electric parking brake:</p> <ul style="list-style-type: none"> ► Do not continue driving. Consult a qualified specialist workshop. <p>* The yellow  indicator lamp is lit and the red  indicator lamp is flashing. The electric parking brake is malfunctioning.</p> <p>The electric parking brake could not be applied or released.</p> <ul style="list-style-type: none"> ► Switch the vehicle off and switch it back on <p>To apply:</p> <ul style="list-style-type: none"> ► Release and then apply the electric parking brake manually (→ page 300). <p>To release:</p> <ul style="list-style-type: none"> ► Apply and then release the electric parking brake manually.

Display messages	Possible causes/consequences and ► Solutions
	<p>If it is not possible to apply the electric parking brake or the red  indicator lamp continues to flash:</p> <ul style="list-style-type: none">► Do not continue driving. Consult a qualified specialist workshop.► Where necessary, also secure the parked vehicle against rolling away. <p>* The yellow  indicator lamp is lit and the red  indicator lamp flashes for approximately ten seconds after the electric parking brake has been applied or released. It then remains lit or goes out. The electric parking brake is malfunctioning.</p> <p>If the state of charge is too low:</p> <ul style="list-style-type: none">► Charge the 12 V battery. <p>To apply:</p> <ul style="list-style-type: none">► Apply the electric parking brake manually. <p>If it is not possible to apply the electric parking brake:</p> <ul style="list-style-type: none">► Consult a qualified specialist workshop.► Where necessary, also secure the parked vehicle against rolling away. <p>To release:</p> <ul style="list-style-type: none">► If the conditions for automatic release are fulfilled and the electric parking brake is not released automatically, release the electric parking brake manually (→ page 300). <p>If it is still not possible to release the electric parking brake:</p>



Display messages	Possible causes/consequences and ► Solutions
 <p data-bbox="118 350 396 379">Release parking brake</p>	<p data-bbox="553 184 1371 213">► Do not continue driving. Consult a qualified specialist workshop.</p> <p data-bbox="527 236 1030 265">* The red  indicator lamp is flashing.</p> <p data-bbox="553 280 1252 309">The electric parking brake is applied while you are driving:</p> <ul data-bbox="564 324 1794 394" style="list-style-type: none"> <li data-bbox="564 324 1794 353">• A condition for automatic release of the electric parking brake has not been fulfilled (→ page 300). <li data-bbox="564 365 1643 394">• You are performing emergency braking using the electric parking brake (→ page 302). <p data-bbox="553 419 1473 448">► Check the conditions for automatic release of the electric parking brake.</p> <p data-bbox="553 461 1130 490">► Release the electric parking brake manually.</p>
 <p data-bbox="118 629 425 685">Parking brake Switch on vehicle to release</p>	<p data-bbox="527 515 962 544">* The red  indicator lamp is lit.</p> <p data-bbox="553 557 1596 586">You have attempted to release the electric parking brake with the vehicle switched off.</p> <p data-bbox="553 600 864 629">► Switch on the vehicle.</p>
 <p data-bbox="118 837 355 866">Brake immediately</p>	<p data-bbox="527 723 1371 752">* A malfunction has occurred while the HOLD function was activated.</p> <p data-bbox="553 764 1069 793">A horn may also sound at regular intervals.</p> <p data-bbox="553 806 993 835">You cannot start the vehicle system.</p> <p data-bbox="553 849 1575 913">► Immediately depress the brake pedal firmly until the display message disappears. You cannot start the vehicle system again.</p>

Display messages	Possible causes/consequences and ► Solutions
 <p data-bbox="57 298 369 360">Malfunction See Owner's Manual</p>	<p data-bbox="466 184 1044 256">* The brake force boosting function is impaired. The hill start assist may be impaired.</p> <div data-bbox="492 277 1923 467" style="border: 1px solid gray; padding: 5px;"> <p data-bbox="506 288 1351 322">▲ WARNING Risk of an accident due to a brake system malfunction</p> <p data-bbox="513 339 1463 370">If the brake system is malfunctioning, braking characteristics may be impaired.</p> <ul style="list-style-type: none"> <li data-bbox="513 381 772 412">► Drive on carefully. <li data-bbox="513 422 1508 453">► Have the brake system checked immediately at a qualified specialist workshop. </div> <ul style="list-style-type: none"> <li data-bbox="486 487 1622 519">► Adjust your speed and drive on carefully, leaving a suitable distance to the vehicle in front. <li data-bbox="486 529 1009 560">► Consult a qualified specialist workshop.
 <p data-bbox="57 702 363 733">Malfunction Stop vehicle</p>	<p data-bbox="466 588 1631 619">* The brake force boosting function is impaired and the braking characteristics may be affected.</p> <div data-bbox="492 640 1923 857" style="border: 1px solid gray; padding: 5px;"> <p data-bbox="506 650 1508 684">▲ WARNING Risk of accident and injury if brake force boosting is malfunctioning</p> <p data-bbox="513 702 1872 764">If brake force boosting is malfunctioning, increased brake pedal force may be necessary for braking. The braking characteristics may be impaired. The braking distance can increase in emergency braking situations.</p> <ul style="list-style-type: none"> <li data-bbox="513 774 1283 806">► Stop in a safe location immediately. Do not continue driving! <li data-bbox="513 816 1034 847">► Consult a qualified specialist workshop. </div> <ul style="list-style-type: none"> <li data-bbox="486 881 1684 912">► Stop the vehicle immediately in accordance with the traffic conditions. Do not continue driving. <li data-bbox="486 923 1009 954">► Consult a qualified specialist workshop.



Display messages	Possible causes/consequences and ► Solutions
 <p data-bbox="118 298 404 327">Check brake fluid level</p>	<p data-bbox="527 184 1250 213">* There is insufficient brake fluid in the brake fluid reservoir.</p> <div data-bbox="553 236 1984 467" style="border: 1px solid gray; padding: 5px;"> <p data-bbox="568 246 1316 275">▲ WARNING Risk of an accident due to low brake fluid level</p> <p data-bbox="574 298 1780 327">If the brake fluid level is too low, the braking effect and the braking characteristics may be impaired.</p> <ul style="list-style-type: none"> <li data-bbox="574 339 1929 368">▶ Stop the vehicle as soon as possible, paying attention to road and traffic conditions. Do not continue driving. <li data-bbox="574 381 1095 410">▶ Consult a qualified specialist workshop. <li data-bbox="574 422 972 451">▶ Do not top up the brake fluid. </div> <ul style="list-style-type: none"> <li data-bbox="553 490 1745 519">▶ Stop the vehicle immediately in accordance with the traffic conditions. Do not continue driving. <li data-bbox="553 531 952 560">▶ Do not top up the brake fluid. <li data-bbox="553 572 1075 601">▶ Consult a qualified specialist workshop.
<p data-bbox="118 627 400 687">Check brake pads See Owner's Manual</p>	<p data-bbox="519 627 1079 656">* The brakepads have reached the wear limit.</p> <ul style="list-style-type: none"> <li data-bbox="553 669 1075 698">▶ Consult a qualified specialist workshop.

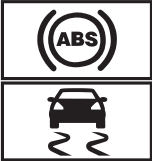

Driving and driving safety systems

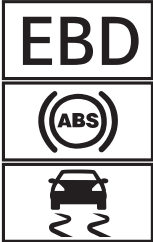

Display messages	Possible causes/consequences and ► Solutions
 <p data-bbox="53 456 384 553">currently unavailable See Owner's Manual (ABS and ESP®)</p>	<p data-bbox="466 236 1913 353">* ABS and ESP® are temporarily unavailable. Other driving systems and driving safety systems (e.g. BAS) may also be temporarily unavailable. The brake system will continue to operate normally. Braking distance may increase in an emergency braking situation.</p> <div data-bbox="492 373 1913 425" style="background-color: #e0e0e0; padding: 5px;"> <p data-bbox="502 387 1324 418">▲ WARNING Risk of skidding if ABS and ESP® are malfunctioning</p> </div> <p data-bbox="508 441 1862 544">The wheels may lock during braking and ESP® does not perform any vehicle stabilisation. The steerability and braking characteristics are heavily impaired and the braking distance may increase. In addition, other driving safety systems are switched off.</p> <ul data-bbox="508 560 1841 664" style="list-style-type: none"> ▶ Drive carefully on a suitable stretch of road, making slight steering movements at a speed above 30 km/h. ▶ If the display message does not disappear, consult a qualified specialist workshop immediately. Drive carefully. <p data-bbox="486 700 1862 770"> ▶ Drive carefully on a suitable stretch of road, making slight steering movements at a speed above 30 km/h. ▶ If the display message does not disappear, consult a qualified specialist workshop immediately. Drive carefully. </p>

Display messages	Possible causes/consequences and ► Solutions
 <p data-bbox="118 407 425 471">inoperative See Owner's Manual (ABS and ESP®)</p>	<p data-bbox="527 187 1978 303">* ABS and ESP® are malfunctioning. Other driving systems and driving safety systems (e.g. BAS) may also be malfunctioning. The brake system will continue to operate normally. Braking distance may increase in an emergency braking situation.</p> <div data-bbox="553 322 1984 378" style="background-color: #e0e0e0; padding: 5px;"> <p data-bbox="568 337 1385 370">▲ WARNING Risk of skidding if ABS and ESP® are malfunctioning</p> </div> <p data-bbox="574 391 1923 495">The wheels may block during braking and ESP® does not perform any vehicle stabilization. The steerability and braking characteristics are heavily impaired and the braking distance may increase. In addition, other driving safety systems are switched off.</p> <ul data-bbox="574 510 1539 588" style="list-style-type: none"> <li data-bbox="574 510 833 541">► Drive on carefully. <li data-bbox="574 552 1539 588">► Have ABS and ESP® checked immediately at a qualified specialist workshop. <p data-bbox="553 622 1228 695"> ► Drive on carefully. ► Consult a qualified specialist workshop immediately. </p>
 <p data-bbox="118 831 435 896">currently unavailable See Owner's Manual (ESP®)</p>	<p data-bbox="527 717 1616 790">* ESP® is temporarily unavailable. Other driving systems and driving safety systems (e.g. BAS) may also be malfunctioning.</p> <div data-bbox="553 809 1984 865" style="background-color: #e0e0e0; padding: 5px;"> <p data-bbox="568 824 1259 857">▲ WARNING Risk of skidding if ESP is malfunctioning®</p> </div> <p data-bbox="574 878 1954 940">If ESP® is malfunctioning, ESP® cannot carry out vehicle stabilisation. In addition, other driving safety systems are switched off.</p>

Display messages	Possible causes/consequences and ► Solutions
	<ul style="list-style-type: none"> ► Drive carefully on a suitable stretch of road, making slight steering movements at a speed above 30 km/h. ► If the display message does not disappear, consult a qualified specialist workshop immediately. Drive carefully. <ul style="list-style-type: none"> ► Drive carefully on a suitable stretch of road, making slight steering movements at a speed above 30 km/h. ► If the display message does not disappear, consult a qualified specialist workshop immediately. Drive carefully.
 <p data-bbox="51 543 363 609">inoperative See Owner's Manual (ESP®)</p>	<p data-bbox="466 429 1911 549">* ESP® is malfunctioning. Other driving systems and driving safety systems (e.g. BAS) may also be malfunctioning. The brake system will continue to operate normally. Braking distance may increase in an emergency braking situation.</p> <div style="background-color: #e0e0e0; padding: 5px; margin-bottom: 10px;"> <p data-bbox="500 574 1195 616">▲ WARNING Risk of skidding if ESP® is malfunctioning</p> </div> <p data-bbox="506 631 1890 694">If ESP® is malfunctioning, ESP® cannot carry out vehicle stabilisation. In addition, other driving safety systems are switched off.</p> <ul style="list-style-type: none"> ► Drive on carefully. ► Have ESP® checked at a qualified specialist workshop. <ul style="list-style-type: none"> ► Drive on carefully. ► Consult a qualified specialist workshop immediately.

Display messages	Possible causes/consequences and ► Solutions
 <p data-bbox="118 511 425 612">inoperative See Owner's Manual (EBD, ABS and ESP®)</p>	<p data-bbox="527 184 1616 262">* EBD, ABS and ESP® are malfunctioning. Other driving systems and driving safety systems (e.g. BAS) may also be malfunctioning.</p> <div data-bbox="553 280 1984 552" style="border: 1px solid gray; padding: 5px;"> <p data-bbox="564 294 1453 329">▲ WARNING Risk of skidding if EBD, ABS and ESP® are malfunctioning</p> <p data-bbox="574 350 1667 381">The wheels may block during braking and ESP® does not perform any vehicle stabilization.</p> <p data-bbox="574 394 1923 453">The steerability and braking characteristics are heavily impaired and the braking distance may increase. In addition, other driving safety systems are switched off.</p> <ul style="list-style-type: none"> <li data-bbox="574 467 833 498">▶ Drive on carefully. <li data-bbox="574 511 1569 542">▶ Have the brake system checked immediately at a qualified specialist workshop. </div> <ul style="list-style-type: none"> <li data-bbox="553 573 813 605">▶ Drive on carefully. <li data-bbox="553 618 1228 649">▶ Consult a qualified specialist workshop immediately.
 <p data-bbox="118 785 159 816">Off</p>	<p data-bbox="527 671 1851 702">* The HOLD function is deactivated because the vehicle is slipping or a condition for activation is not fulfilled.</p> <ul style="list-style-type: none"> <li data-bbox="553 715 1896 746">▶ Reactivate the HOLD function later or check the activation conditions for the HOLD function (→ page 312).
<p data-bbox="118 845 445 907">Restricted mode activated Output reduced</p>	<ul style="list-style-type: none"> <li data-bbox="527 845 1528 876">* Valet Service Mode is activated. Vehicle acceleration is restricted (→ page 314). <li data-bbox="527 889 1555 921">* Beginner Driver Mode is activated. Vehicle acceleration is restricted (→ page 314).



Display messages	Possible causes/consequences and ► Solutions
 <p data-bbox="53 298 396 360">ATTENTION ASSIST: Take a break!</p>	<ul style="list-style-type: none"> <li data-bbox="461 182 1741 246">* ATTENTION ASSIST has detected fatigue or an increasing lack of concentration on the part of the driver (→ page 315). <li data-bbox="486 256 850 290">► If necessary, take a break.
 <p data-bbox="53 510 396 572">ATTENTION ASSIST Microsleep Take a break!</p>	<ul style="list-style-type: none"> <li data-bbox="461 394 1373 427">* ATTENTION ASSIST has detected indicators of microsleep (→ page 315). <li data-bbox="486 438 862 471">A warning tone will also sound. <li data-bbox="486 481 846 514">► Take a break immediately. <li data-bbox="486 525 1414 558">► Press the left-hand Touch Control and acknowledge the display message.
<p data-bbox="53 603 396 699">ATTENTION ASSIST Remain alert! (white display message)</p>	<ul style="list-style-type: none"> <li data-bbox="461 603 1815 637">* ATTENTION ASSIST has detected that the driver is looking away from the situation on the road (→ page 315). <li data-bbox="486 647 862 680">A warning tone will also sound. <li data-bbox="486 691 833 724">► Focus on the road again.
<p data-bbox="53 741 396 837">ATTENTION ASSIST Remain alert! (yellow display message)</p>	<ul style="list-style-type: none"> <li data-bbox="461 741 1917 806">* ATTENTION ASSIST has detected that the driver is not paying attention to the traffic situation after a warning has been issued (→ page 315). <li data-bbox="486 816 1005 849">A continuous warning tone will also sound. <li data-bbox="486 859 1169 893">► Immediately return your focus to the traffic situation. <li data-bbox="486 903 1414 936">► Press the left-hand Touch Control and acknowledge the display message.





Display messages	Possible causes/consequences and ► Solutions
 <p>--- km/h</p>	<ul style="list-style-type: none"> * Cruise control cannot be activated as not all activation conditions are fulfilled. <ul style="list-style-type: none"> ► Observe the activation conditions for cruise control (→ page 319).
<p>Cruise control inoperative</p>	<ul style="list-style-type: none"> * Cruise control is malfunctioning. <ul style="list-style-type: none"> ► Consult a qualified specialist workshop.
<p>Cruise control and Limiter inoperative</p>	<ul style="list-style-type: none"> * Cruise control and the limiter are malfunctioning. <ul style="list-style-type: none"> ► Consult a qualified specialist workshop.
<p>Cruise control off</p>	<ul style="list-style-type: none"> * Cruise control has been deactivated. If there is an additional warning tone, cruise control has been deactivated automatically (→ page 317).
 <p>--- km/h</p>	<ul style="list-style-type: none"> * The limiter can temporarily not be engaged. Once the cause of the problem is no longer present, the system will be available again.
 <p>passive</p>	<ul style="list-style-type: none"> * If you depress the accelerator pedal beyond the point of resistance (kickdown), the limiter will be switched to passive mode (→ page 318).

Display messages	Possible causes/consequences and ► Solutions
Limiter inoperative	<ul style="list-style-type: none"> * The limiter is malfunctioning. <ul style="list-style-type: none"> ► Consult a qualified specialist workshop.
Speed Limit Assist currently unavailable See Owner's Manual	<ul style="list-style-type: none"> * Speed Limit Assist is temporarily unavailable. <ul style="list-style-type: none"> ► Drive on Once the cause of the problem is no longer present, the system will be available again.
Speed Limit Assist inoperative	<ul style="list-style-type: none"> * Speed Limit Assist is malfunctioning. <ul style="list-style-type: none"> ► Drive on or ► Stop the vehicle in accordance with the traffic conditions and restart the vehicle. ► If the display message does not disappear: consult a qualified specialist workshop.
Speed limit (winter tyres) XXX km/h	<ul style="list-style-type: none"> * You have reached the maximum permissible stored speed for winter tyres. It is not possible to exceed this speed.
<div style="border: 2px solid black; padding: 5px; display: inline-block; margin-bottom: 5px;">120km/h!</div> <p>Maximum speed exceeded</p>	<ul style="list-style-type: none"> * You have exceeded the maximum permissible speed (for certain countries only). <ul style="list-style-type: none"> ► Drive more slowly.

Display messages	Possible causes/consequences and ► Solutions
<p>Traffic Sign Assist currently unavailable See Owner's Manual</p>	<ul style="list-style-type: none"> * Traffic Sign Assist is temporarily unavailable. Once the cause of the problem is no longer present, the system will be available again. <ul style="list-style-type: none"> ► Continue driving in compliance with the traffic regulations.
<p>Traffic Sign Assist inoperative</p>	<ul style="list-style-type: none"> * Traffic Sign Assist is malfunctioning. <ul style="list-style-type: none"> ► Continue driving in compliance with the traffic regulations. or ► Stop the vehicle in accordance with the traffic conditions and restart the vehicle. ► If the display message does not disappear: consult a qualified specialist workshop.
<div data-bbox="130 532 324 636" style="border: 1px solid black; padding: 5px; text-align: center;">  </div> <p>Fault Drive at max. 80 km/h</p>	<ul style="list-style-type: none"> * AIRMATIC is functioning only to a limited extent. The vehicle's handling characteristics may be affected. <div data-bbox="553 584 1984 764" style="border: 1px solid gray; padding: 10px; margin-top: 10px;"> <p>! NOTE The tyres on the front axle or the fenders could be damaged by large steering movements</p> <ul style="list-style-type: none"> ► Avoid large steering movements while driving and listen for scraping sounds. ► If you hear scraping sounds, pull over and stop the vehicle in accordance with the traffic conditions, and set a higher vehicle level if possible. </div> <ul style="list-style-type: none"> ► Drive in a manner appropriate for the current level, but do not exceed 80 km/h. ► Consult a qualified specialist workshop.

Display messages	Possible causes/consequences and ► Solutions
 <p data-bbox="53 298 331 364">Fault Drive at max. 80 km/h</p>	<ul style="list-style-type: none"> * AMG RIDE CONTROL + is malfunctioning. The vehicle's handling characteristics may be affected. <ul style="list-style-type: none"> ► No faster than 80 km/h. ► Consult a qualified specialist workshop.
<p data-bbox="53 391 404 453">AMG Ride Control Function limited See Owner's Manual</p>	<ul style="list-style-type: none"> * At least one of the main functions of AMG RIDE CONTROL + is malfunctioning. The system is outside the operating temperature range or the on-board electrical system voltage is too low. Once the cause of the problem is no longer present, the system will be available again. <div data-bbox="492 529 1923 754" style="border: 1px solid gray; padding: 5px; margin: 10px 0;"> <p data-bbox="506 542 1864 609">! NOTE The vehicle's suspension and damping behaviour is restricted. The vehicle body may tilt heavily to the side during cornering.</p> <ul style="list-style-type: none"> ► Drive on carefully. ► Reduce speed considerably before taking a bend. ► Avoid sudden steering movements. </div> <ul style="list-style-type: none"> ► Drive on carefully. ► Reduce speed considerably before taking a bend. ► Avoid sudden steering movements.



Display messages	Possible causes/consequences and ► Solutions
 <p data-bbox="118 301 451 327">STOP Vehicle level too low</p>	<p data-bbox="527 184 1279 215">* You have pulled away despite the vehicle level being too low.</p> <ul style="list-style-type: none"> <li data-bbox="553 228 1293 291">► Stop the vehicle in accordance with the traffic conditions. The vehicle will be raised to the selected vehicle level. <li data-bbox="553 304 1344 335">► Wait until the display message disappears before pulling away. <p data-bbox="553 366 1804 397">If the display message does not disappear and a warning tone also sounds, AIRMATIC is malfunctioning:</p> <ul style="list-style-type: none"> <li data-bbox="553 411 1569 442">► No faster than 80 km/h and consult a qualified specialist workshop immediately. <div data-bbox="553 470 1984 650" style="border: 1px solid black; padding: 5px;"> <p data-bbox="568 483 1784 514">! NOTE The tyres on the front axle or the fenders could be damaged by large steering movements</p> <ul style="list-style-type: none"> <li data-bbox="574 535 1539 566">► Avoid large steering movements while driving and listen for scraping sounds. <li data-bbox="574 577 1943 639">► If you hear scraping sounds, pull over and stop the vehicle in accordance with the traffic conditions, and set a higher vehicle level if possible. </div> <ul style="list-style-type: none"> <li data-bbox="553 674 1279 736">► Set a higher vehicle level (→ page 361, 358). Depending on the malfunction, the vehicle will be raised.
 <p data-bbox="118 877 233 903">Lowering</p>	<p data-bbox="527 760 1181 791">* The vehicle level will lower for the following reasons:</p> <ul style="list-style-type: none"> <li data-bbox="560 804 1126 836">• You have selected a different drive program. <li data-bbox="560 846 1017 877">• You have exceeded the speed limit. <li data-bbox="560 887 1299 918">• You have changed the vehicle level by pressing the button.

Display messages	Possible causes/consequences and ► Solutions
 <p>Rising</p>	<ul style="list-style-type: none"> • Operation with a trailer or bicycle rack: if an electrical connection has been correctly made, you have exceeded the speed limit. <p>* Your vehicle is adjusting to the level you have selected.</p>
 <p>Max. speed 20km/h</p>	<p>* AIRMATIC is functioning only to a limited extent. The current level is too high. The vehicle's handling characteristics may be affected.</p> <ul style="list-style-type: none"> ► No faster than 20 km/h. ► Consult a qualified specialist workshop.
 <p>Compressor is cooling</p>	<p>* Due to frequent level changes within a short space of time, the compressor first needs to cool down in order to set the selected vehicle level. When the compressor has cooled down, the vehicle will continue rising to the selected vehicle level.</p> <ul style="list-style-type: none"> ► Drive on in a manner appropriate for the current level. Make sure that there is sufficient ground clearance.
 <p>Reduce speed</p>	<p>* You are driving too fast for the selected vehicle level.</p> <ul style="list-style-type: none"> ► Drive more slowly and then select the desired vehicle level again. <p>You are driving too quickly with a trailer or the trailer hitch socket is being used, e.g. for a rear bicycle rack.</p> <ul style="list-style-type: none"> ► Read the notes on trailer operation.

Display messages	Possible causes/consequences and ► Solutions
 <p data-bbox="118 298 437 329">Vehicle rising Please wait</p>	<ul style="list-style-type: none"> * The vehicle level is too low. The vehicle will be raised to the selected vehicle level. <ul style="list-style-type: none"> ► Wait until the display message disappears before pulling away.
<p data-bbox="118 357 437 419">RACE START not possible See Owner's Manual</p>	<ul style="list-style-type: none"> * Possible causes: <ul style="list-style-type: none"> • The activation conditions have not been fulfilled (→ page 362).
<p data-bbox="118 450 404 481">RACE START cancelled</p>	<ul style="list-style-type: none"> * Possible causes: <ul style="list-style-type: none"> • you released the accelerator pedal during RACE START. • you depressed the brake pedal during RACE START. ► You can try RACE START again at the next start.



Driver assistance systems

Display messages	Possible causes/consequences and ► Solutions
 <p data-bbox="118 912 241 943">--- km/h</p>	<ul style="list-style-type: none"> * Active Distance Assist DISTRONIC cannot be activated as not all activation conditions are fulfilled. <ul style="list-style-type: none"> ► Comply with the activation conditions of Active Distance Assist DISTRONIC (→ page 324).

Display messages	Possible causes/consequences and ► Solutions
 <p>suspended</p>	<ul style="list-style-type: none"> * If you depress the accelerator pedal beyond the setting of Active Distance Assist DISTRONIC, the system will switch to passive mode (→ page 321).
 <p>Off</p>	<ul style="list-style-type: none"> * Active Distance Assist DISTRONIC was deactivated. If a warning tone also sounds, Active Distance Assist DISTRONIC has deactivated automatically (→ page 324).
<p>Active Distance Assist currently unavailable See Owner's Manual</p>	<ul style="list-style-type: none"> * Active Distance Assist DISTRONIC is temporarily unavailable. The ambient conditions are outside the system limits (→ page 321). As soon as the ambient conditions are within the system limits, the system will become available again. <ul style="list-style-type: none"> ► Drive on carefully. or ► If the display message does not disappear, stop the vehicle in accordance with the traffic conditions and restart the vehicle.
<p>Active Distance Assist inoperative</p>	<ul style="list-style-type: none"> * Active Distance Assist DISTRONIC is malfunctioning. Other driving systems and driving safety systems may also be malfunctioning. <ul style="list-style-type: none"> ► Drive on carefully.

Display messages	Possible causes/consequences and ► Solutions
	<p>or</p> <ul style="list-style-type: none"> ► Stop the vehicle in accordance with the traffic conditions and restart the vehicle. ► If the display message does not disappear: consult a qualified specialist workshop.
Active Distance Assist available again	<p>* Active Distance Assist DISTRONIC is operational again.</p> <ul style="list-style-type: none"> ► Switch on Active Distance Assist DISTRONIC (→ page 324).
Active Brake Assist Functions currently limited See Owner's Manual	<p>* For vehicles with the Driving Assistance Package, the following functions may be temporarily unavailable or only partially available:</p> <ul style="list-style-type: none"> • Active Brake Assist with cross-traffic function • Evasive Steering Assist • PRE-SAFE® PLUS <p>Vehicles with Blind Spot Assist: PRE-SAFE® PLUS is temporarily unavailable. The ambient conditions are outside the system limits (→ page 336).</p> <p>Vehicles without the Driving Assistance Package: Active Brake Assist is temporarily unavailable.</p> <ul style="list-style-type: none"> ► Drive on carefully. As soon as the ambient conditions are within the system limits, the system will become available again. <p>or</p> <ul style="list-style-type: none"> ► If the display message does not disappear, stop the vehicle in accordance with the traffic conditions and restart the vehicle.

Display messages	Possible causes/consequences and ► Solutions
<p>Active Brake Assist Functions limited See Owner's Manual</p>	<p>* For vehicles with the Driving Assistance Package, the following functions may be temporarily unavailable or only partially available:</p> <ul style="list-style-type: none"> • Active Brake Assist with cross-traffic function • Evasive Steering Assist • PRE-SAFE® PLUS <p>Vehicles without the Driving Assistance Package: Active Brake Assist is temporarily unavailable or only partially available.</p> <p>► Drive on carefully.</p> <p>or</p> <p>► Stop the vehicle in accordance with the traffic conditions and restart the vehicle.</p> <p>► If the display message does not disappear: consult a qualified specialist workshop.</p>
<p>Active Steering Assist currently unavailable See Owner's Manual</p>	<p>* Active Steering Assist is temporarily unavailable.</p> <p>The ambient conditions are outside the system limits (→ page 330).</p> <p>As soon as the ambient conditions are within the system limits, the system will become available again.</p> <p>► Drive on</p> <p>► Check the tyre pressure if necessary.</p>
<p>Active Steering Assist inoperative</p>	<p>* Active Steering Assist is malfunctioning. Active Distance Assist DISTRONIC remains available.</p> <p>► Drive on</p>

Display messages	Possible causes/consequences and ► Solutions
	<p>or</p> <ul style="list-style-type: none"> ► Stop the vehicle in accordance with the traffic conditions and restart the vehicle. ► If the display message does not disappear: consult a qualified specialist workshop.
	<ul style="list-style-type: none"> * Active Steering Assist has reached the system limits (→ page 330). You have not steered independently for a considerable period of time. <ul style="list-style-type: none"> ► Take over the steering and drive on in accordance with the traffic conditions.
<p>Active Steering Assist currently unavailable due to multiple emergency stops</p>	<ul style="list-style-type: none"> * Active Steering Assist is temporarily unavailable due to multiple emergency stops. <ul style="list-style-type: none"> ► Take over the steering and stop in accordance with the traffic conditions. ► Switch the vehicle off and switch it back on Active Steering Assist is available once more.
 <p>Beginning emergency stop</p>	<ul style="list-style-type: none"> * Your hands are not on the steering wheel. Active Steering Assist will initiate an emergency stop (→ page 330). <ul style="list-style-type: none"> ► Put your hands on the steering wheel. <p>Information on cancelling an emergency stop (→ page 332).</p>
<p>Active Emergency Stop Assist currently unavailable See Owner's Manual</p>	<ul style="list-style-type: none"> * Active Emergency Stop Assist is temporarily unavailable. The ambient conditions are outside the system limits (→ page 332). As soon as the ambient conditions are within the system limits, the system will become available again. <ul style="list-style-type: none"> ► Drive on

Display messages	Possible causes/consequences and ► Solutions
	<p>or</p> <ul style="list-style-type: none"> ► If the display message does not disappear, stop the vehicle in accordance with the traffic conditions and restart the vehicle. <p>* Vehicles without the Driving Assistance Package: Active Emergency Stop Assist is temporarily unavailable due to multiple emergency stops.</p> <ul style="list-style-type: none"> ► Take over the steering and stop in accordance with the traffic conditions. ► Switch the vehicle off and switch it back on <p>Active Emergency Stop Assist is available once more.</p>
<p>Active Emergency Stop Assist inoperative</p>	<p>* Active Emergency Stop Assist is malfunctioning.</p> <ul style="list-style-type: none"> ► Drive on <p>or</p> <ul style="list-style-type: none"> ► Stop the vehicle in accordance with the traffic conditions and restart the vehicle. ► If the display message does not disappear: consult a qualified specialist workshop.
<p>Active Lane Change Assist currently unavailable See Owner's Manual</p>	<p>* Active Lane Change Assist is temporarily unavailable.</p> <p>The ambient conditions are outside the system limits (→ page 334).</p> <p>As soon as the ambient conditions are within the system limits, the system will become available again.</p> <ul style="list-style-type: none"> ► Drive on <p>or</p>



Display messages	Possible causes/consequences and ► Solutions
	<ul style="list-style-type: none"> ► If the display message does not disappear, stop the vehicle in accordance with the traffic conditions and restart the vehicle.
Active Lane Change Assist inoperative	<ul style="list-style-type: none"> * Active Lane Change Assist is malfunctioning. <ul style="list-style-type: none"> ► Drive on or ► Stop the vehicle in accordance with the traffic conditions and restart the vehicle. ► If the display message does not disappear: consult a qualified specialist workshop.
Active Stop-and-Go Assist currently unavailable see Owner's Manual	<ul style="list-style-type: none"> * Active Stop-and-Go Assist is temporarily unavailable. Active Distance Assist DISTRONIC and Active Steering Assist are still available. The ambient conditions are outside the system limits (→ page 321). As soon as the ambient conditions are within the system limits, the system will become available again. <ul style="list-style-type: none"> ► Drive on
Active Stop-and-Go Assist inoperative See Owner's Manual	<ul style="list-style-type: none"> * Active Stop-and-Go Assist is malfunctioning. Active Stop-and-Go Assist has been deactivated. Active Distance Assist DISTRONIC and Active Steering Assist are still available. <ul style="list-style-type: none"> ► Drive on or ► Stop the vehicle in accordance with the traffic conditions and restart the vehicle. ► If the display message does not disappear: consult a qualified specialist workshop.

Display messages	Possible causes/consequences and ► Solutions
Blind Spot Assist currently unavailable See Owner's Manual	<p>* Blind Spot Assist is temporarily unavailable. The system limits have been reached (→ page 350). Once the cause of the problem is no longer present, the system will be available again.</p> <p>► Drive on or ► If the display message does not disappear, stop the vehicle in accordance with the traffic conditions and restart the vehicle.</p>
Blind Spot Assist inoperative	<p>* Blind Spot Assist or the exit warning is malfunctioning.</p> <p>► Drive on or ► Stop the vehicle in accordance with the traffic conditions and restart the vehicle. ► If the display message does not disappear: consult a qualified specialist workshop.</p>
Blind Spot Assist unavailable when towing a trailer See Owner's Manual	<p>* When you establish the electrical connection to the trailer, Blind Spot Assist will be unavailable.</p> <p>► Press the left-hand Touch Control and acknowledge the display message.</p>
Active Blind Spot Assist currently unavailable See Owner's Manual	<p>* Active Blind Spot Assist is temporarily unavailable. The system limits have been reached (→ page 350). Once the cause of the problem is no longer present, the system will be available again.</p>

Display messages	Possible causes/consequences and ► Solutions
	<ul style="list-style-type: none"> ► Drive on or ► If the display message does not disappear, stop the vehicle in accordance with the traffic conditions and restart the vehicle.
Active Blind Spot Assist inoperative	<ul style="list-style-type: none"> * Active Blind Spot Assist or the exit warning is malfunctioning. ► Drive on or ► Stop the vehicle in accordance with the traffic conditions and restart the vehicle. ► If the display message does not disappear: consult a qualified specialist workshop.
Active Blind Spot Assist unavailable when towing a trailer See Owner's Manual	<ul style="list-style-type: none"> * When you establish the electrical connection to the trailer, Active Blind Spot Assist will be unavailable. ► Press the left-hand Touch Control and acknowledge the display message.
Active Lane Keeping Assist currently unavailable See Owner's Manual	<ul style="list-style-type: none"> * Active Lane Keeping Assist is temporarily unavailable. The ambient conditions are outside the system limits (→ page 354). As soon as the ambient conditions are within the system limits, the system will become available again. ► Drive on
Active Lane Keeping Assist inoperative	<ul style="list-style-type: none"> * Active Lane Keeping Assist is malfunctioning. ► Drive on

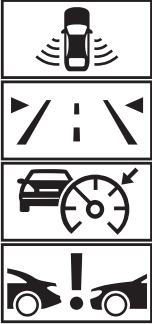
Display messages	Possible causes/consequences and ► Solutions
	<p>or</p> <ul style="list-style-type: none"> ► Stop the vehicle in accordance with the traffic conditions and restart the vehicle. ► If the display message does not disappear: consult a qualified specialist workshop.
<p>Active Lane Keeping Assist functions restricted See Owner's Manual</p>	<p>* Active Lane Keeping Assist is available but restricted.</p> <ul style="list-style-type: none"> ► Drive on <p>or</p> <ul style="list-style-type: none"> ► Stop the vehicle in accordance with the traffic conditions and restart the vehicle. ► If the display message does not disappear: consult a qualified specialist workshop.
 <p>Beginning emergency stop</p>	<p>* Your hands are not on the steering wheel. The Active Lane Keeping Assist will initiate an emergency stop (→ page 354).</p> <ul style="list-style-type: none"> ► Put your hands on the steering wheel. <p>Information on cancelling an emergency stop (→ page 332).</p>

Display messages	Possible causes/consequences and ► Solutions
 <p data-bbox="118 619 410 679">temporarily unavailable Sensors dirty</p>	<p data-bbox="527 184 1631 213">* Front and corner radar sensors (hereafter "sensors") are malfunctioning. Possible causes:</p> <ul data-bbox="560 228 1365 342" style="list-style-type: none"> <li data-bbox="560 228 850 257">• The sensors are dirty <li data-bbox="560 270 825 299">• Heavy rain or snow <li data-bbox="560 311 1365 342">• Extended country driving without other traffic, e.g. in the desert <p data-bbox="549 366 1984 428">Driving systems and driving safety systems may be malfunctioning or temporarily unavailable. The brake system, steering and drive system will continue to function normally.</p> <p data-bbox="549 441 813 470">► Drive on carefully.</p> <p data-bbox="549 503 1980 565">Once the causes of the problem are no longer present, the driving systems and driving safety systems will be available again and the corresponding symbols will be switched off.</p> <p data-bbox="549 578 1066 607">If the display message does not disappear:</p> <ul data-bbox="549 622 1293 736" style="list-style-type: none"> <li data-bbox="549 622 1293 651">► Stop the vehicle in accordance with the traffic conditions. <li data-bbox="549 664 1273 693">► Clean all sensor covers from the outside (→ page 304). <li data-bbox="549 705 829 734">► Restart the vehicle.

Display messages	Possible causes/consequences and ► Solutions
 <p data-bbox="51 828 347 890">Camera view restricted See Owner's Manual</p>	<p data-bbox="459 181 1308 212">* The view of the multifunction camera is restricted. Possible causes:</p> <ul data-bbox="490 222 1900 378" style="list-style-type: none"> <li data-bbox="490 222 1400 253">• Dirt on the windscreen in the field of vision of the multifunction camera <li data-bbox="490 264 817 295">• Heavy rain, snow or fog <li data-bbox="490 305 1900 378">• Mist on the inside of the windscreen: in certain weather conditions, mist can form on the inside or outside of the windscreen during cold times of year in particular. <p data-bbox="490 393 1911 461">  This mist on the windscreen will be removed automatically within a short time with the aid of a heater. The restriction is temporary. </p> <p data-bbox="480 471 1921 533">Driving systems and driving safety systems may be malfunctioning or temporarily unavailable. The brake system, steering and drive system will continue to function normally.</p> <ul data-bbox="480 543 1257 668" style="list-style-type: none"> <li data-bbox="480 543 756 574">► Drive on carefully. <li data-bbox="480 585 1257 616">► To remove mist from the outside, wipe once (→ page 226). <li data-bbox="480 626 1257 668">► To remove mist from the inside, press  (→ page 240). <p data-bbox="480 694 1921 761">Once the causes of the problem are no longer present, the driving systems and driving safety systems will be available again and the corresponding symbols will be switched off.</p> <p data-bbox="480 771 1645 802">If the display message does not disappear even after a longer driving time of about 15 minutes:</p> <ul data-bbox="480 813 1645 932" style="list-style-type: none"> <li data-bbox="480 813 1236 844">► Stop the vehicle in accordance with the traffic conditions. <li data-bbox="480 854 1645 885">► Clean the windscreen, especially in the position of the multifunction camera (→ page 304). <li data-bbox="480 896 766 927">► Restart the vehicle.

Display messages	Possible causes/consequences and ► Solutions
 <p data-bbox="118 511 416 573">Restricted during trailer operation</p>	<p data-bbox="527 184 1739 215">* When the trailer socket is occupied, some driving systems will be available only to a limited extent.</p> <ul style="list-style-type: none"> <li data-bbox="549 225 1494 256">► Drive carefully if you are towing a trailer or have the bicycle rack mounted.
<p data-bbox="118 605 455 729">The camera's view of the driver is currently impeded Affected functions: see Owner's Manual</p>	<p data-bbox="527 605 1259 636">* The view of the driver camera is reduced. Possible causes:</p> <ul style="list-style-type: none"> <li data-bbox="560 646 1469 677">• Objects or stickers are projecting into the driver camera's field of vision. <li data-bbox="560 687 911 718">• The driver camera is dirty. <ul style="list-style-type: none"> <li data-bbox="549 739 1130 770">► Keep the driver camera's field of vision free. <li data-bbox="549 781 1978 850">► Clean the driver camera if necessary. Please comply with the notes on caring for the interior relating to the display (→ page 605).

Display messages	Possible causes/consequences and ► Solutions
<p>Change steering wheel/ seat position until 6 dots are visible on the upper edge of the screen</p>	<ul style="list-style-type: none"> * The driver camera cannot capture your line of sight. <ul style="list-style-type: none"> ► Change the steering wheel and seat position until six dots are visible on the top edge of the screen. The display message will appear again if the driver camera is again unable to detect your line of sight after 30 minutes. The display message will no longer appear if you confirm the display message and the driver camera cannot detect your line of sight during the entire journey.
<p>Driver camera inoperative See Owner's Manual</p>	<ul style="list-style-type: none"> * The driver camera is malfunctioning. <ul style="list-style-type: none"> ► Consult a qualified specialist workshop.
<p>PRE-SAFE inoperative See Owner's Manual</p>	<ul style="list-style-type: none"> * The PRE-SAFE® functions are malfunctioning. <ul style="list-style-type: none"> ► Consult a qualified specialist workshop.
<p>PRE-SAFE impulse side inoperative See Owner's Manual</p>	<ul style="list-style-type: none"> * The PRE-SAFE® Impulse Side system is malfunctioning or inoperative after having already been triggered. <ul style="list-style-type: none"> ► Consult a qualified specialist workshop.
<p>PRE-SAFE PLUS inoperative See Owner's Manual</p>	<ul style="list-style-type: none"> * The PRE-SAFE® system is malfunctioning. <ul style="list-style-type: none"> ► Drive on or ► Stop the vehicle in accordance with the traffic conditions and restart the vehicle. ► If the display message does not disappear: consult a qualified specialist workshop.

Parking assistance systems

Display messages	Possible causes/consequences and ► Solutions
<p>PARKTRONIC inoperative See Owner's Manual</p>	<ul style="list-style-type: none"> * Parking Assist PARKTRONIC is malfunctioning. Once the cause of the problem is no longer present, the system will be available again. <ul style="list-style-type: none"> ► Continue driving while paying attention to the vehicle's surroundings. or ► Stop the vehicle in accordance with the traffic conditions and restart the vehicle. ► If the display message still appears, consult a qualified specialist workshop.
<p>PARKTRONIC and manoeuvring assistant unavailable at rear when towing a trailer</p>	<ul style="list-style-type: none"> * If transport equipment, e.g. a trailer or bicycle rack, is attached to the trailer hitch and the electrical connection is correctly established, Parking Assist PARKTRONIC is not available at the rear when reversing. The rear manoeuvring assistant is also unavailable in this situation. <ul style="list-style-type: none"> ► Press the left-hand Touch Control and acknowledge the display message.
<p>Active Parking Assist and PARKTRONIC inoperative See Owner's Manual</p>	<ul style="list-style-type: none"> * Active Parking Assist and Parking Assist PARKTRONIC are malfunctioning. Once the cause of the problem is no longer present, the system will be available again. <ul style="list-style-type: none"> ► Continue driving while paying attention to the vehicle's surroundings. or ► Stop the vehicle in accordance with the traffic conditions and restart the vehicle. ► If the display message still appears, consult a qualified specialist workshop.

Display messages	Possible causes/consequences and ► Solutions
<p>Limited availability of Active Parking Assist manoeuvring assistant See Owner's Manual</p>	<ul style="list-style-type: none"> * Active Parking Assist's manoeuvring assistant is temporarily unavailable or only partially available. <ul style="list-style-type: none"> ► Clean all sensors of the parking and camera system (→ page 604). ► If the display message still appears, consult a qualified specialist workshop.

Mercedes-Benz emergency call system

Display messages	Possible causes/consequences and ► Solutions
<div data-bbox="63 500 261 606" data-label="Image"> </div> <p>Inoperative</p>	<ul style="list-style-type: none"> * The Mercedes-Benz emergency call system is malfunctioning. The Mercedes me connect system is also malfunctioning. <ul style="list-style-type: none"> ► Consult a qualified specialist workshop.

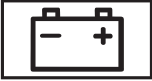

Battery

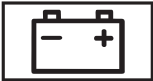

Display messages	Possible causes/consequences and ► Solutions
 <p data-bbox="118 350 421 412">12 V on-board electrical system Visit workshop</p>	<ul style="list-style-type: none"> * The 12 V on-board electrical system is malfunctioning. <ul style="list-style-type: none"> ► Consult a qualified specialist workshop immediately.
 <p data-bbox="118 562 441 624">Stop vehicle See Owner's Manual</p>	<ul style="list-style-type: none"> * The 12 V battery is no longer being charged and the state of charge is too low. <div data-bbox="553 495 1984 643" style="border: 1px solid gray; padding: 5px; margin: 5px 0;"> <p data-bbox="568 510 1418 541">! NOTE Possible damage to the drive system if you continue driving</p> <ul style="list-style-type: none"> ► Do not continue driving. ► Consult a qualified specialist workshop. </div> <ul style="list-style-type: none"> ► Stop the vehicle immediately in accordance with the traffic conditions. Do not continue driving. ► Switch off the vehicle. ► Consult a qualified specialist workshop.

Display messages	Possible causes/consequences and ► Solutions
 <p data-bbox="53 298 388 360">Start the vehicle to charge the 12 V battery</p>	<ul style="list-style-type: none"> <li data-bbox="461 184 1344 211">* The vehicle is off and the state of charge of the 12 V battery is too low. <ul style="list-style-type: none"> <li data-bbox="486 225 1181 252">► Switch off electrical consumers that are not required. <li data-bbox="486 259 797 285">► Drive for 30–60 mins. <li data-bbox="486 304 515 331">or <li data-bbox="486 343 1201 370">► Charge the vehicle at a charging station (→ page 276).
 <p data-bbox="53 512 388 606">Stop vehicle Leave vehicle on to charge the 12 V battery</p>	<ul style="list-style-type: none"> <li data-bbox="461 398 1087 425">* The state of charge of the 12 V battery is too low. <ul style="list-style-type: none"> <li data-bbox="486 440 1680 467">► Stop the vehicle immediately in accordance with the traffic conditions. Do not continue driving. <li data-bbox="486 481 842 508">► Leave the vehicle running <li data-bbox="486 523 1058 550">► If the display message disappears: drive on. <li data-bbox="486 564 1528 591">► If the display message does not disappear: consult a qualified specialist workshop.

Tyre pressure monitor

Display messages	Possible causes/consequences and ► Solutions
<p data-bbox="53 795 355 857">Tyre press. monitor currently unavailable</p>	<ul style="list-style-type: none"> <li data-bbox="461 795 1872 857">* There is interference from a powerful radio signal source As a result, no signals from the tyre pressure sensors are being received. The tyre pressure monitoring system is temporarily unavailable. The tyre pressure monitoring system will restart automatically as soon as the cause has been rectified. <ul style="list-style-type: none"> <li data-bbox="486 913 637 940">► Drive on

Display messages	Possible causes/consequences and ► Solutions
<p>Tyre press. monitor inoperative</p>	<ul style="list-style-type: none"> * The tyre pressure monitoring system is malfunctioning. <div style="border: 1px solid black; padding: 5px; margin: 5px 0;"> <p>⚠ WARNING There is a risk of an accident if the tyre pressure monitoring system is malfunctioning</p> <p>The tyre pressure monitoring system cannot issue a warning if there is pressure loss in one or more of the tyres. Tyres with insufficient tyre pressure may impair the driving characteristics as well as steering and braking.</p> <p>► Have the tyre pressure monitoring system checked at a qualified specialist workshop.</p> </div> <ul style="list-style-type: none"> ► Consult a qualified specialist workshop.
<p>Tyre pressure monitor inoperative No tyre pressure sensors</p>	<ul style="list-style-type: none"> * The wheels fitted do not have suitable tyre pressure sensors. The tyre pressure monitoring system is deactivated. <ul style="list-style-type: none"> ► Fit wheels with suitable tyre pressure sensors.
<div style="text-align: center;">  </div> <p>Wheel sensor(s) missing</p>	<ul style="list-style-type: none"> * There is no signal from the tyre pressure sensor in at least one wheel. No pressure value is displayed for the affected tyre. <ul style="list-style-type: none"> ► Have the faulty tyre pressure sensor replaced at a qualified specialist workshop.
<div style="text-align: center;">  </div> <p>Check tyre(s)</p>	<ul style="list-style-type: none"> * The tyre pressure in one or more tyres has dropped significantly. The wheel position is displayed. A warning tone will also sound.

Display messages	Possible causes/consequences and ► Solutions
	<p>▲ WARNING Risk of an accident due to insufficient tyre pressure</p> <ul style="list-style-type: none"> • The tyres can burst. • The tyres can wear excessively and/or unevenly. • The driving characteristics as well as the steering and braking may be greatly impaired. <p>You could then lose control of the vehicle.</p> <ul style="list-style-type: none"> ► Observe the recommended tyre pressures. ► Adjust the tyre pressure if necessary. <p>► Stop the vehicle in accordance with the traffic conditions.</p> <p>► Check the tyre pressure (→ page 628) and the tyres.</p>
 <p>Rectify tyre pressure</p>	<p>* The tyre pressure is too low in at least one of the tyres, or the difference in tyre pressure between the individual wheels is too great.</p> <ul style="list-style-type: none"> ► Check the tyre pressure and add air, if necessary. ► When the tyre pressure is correct, restart the tyre pressure monitor (→ page 631).
 <p>Warning tyre malfunction</p>	<p>* The pressure in one or more tyres has dropped suddenly. The wheel position is displayed.</p>

Display messages	Possible causes/consequences and ► Solutions
	<p>▲ WARNING Risk of an accident from driving with a flat tyre</p> <ul style="list-style-type: none"> • The tyres can overheat and be damaged. • The driving characteristics as well as the steering and braking characteristics may be greatly impaired. <p>You could then lose control of the vehicle.</p> <ul style="list-style-type: none"> ► Do not drive with a flat tyre. ► Do not exceed the maximum permissible driving distance in emergency mode and the maximum permissible speed with a flat MOExtended tyre. ► Observe the notes on flat tyres. <p>Notes on flat tyres (→ page 49).</p> <ul style="list-style-type: none"> ► Stop the vehicle in accordance with the traffic conditions. ► Check the tyres.
 <p>Tyre(s) overheated</p>	<p>* At least one tyre is overheating. The affected tyres are displayed in red. At temperatures close to the limit value, the tyres are displayed in yellow.</p> <p>▲ WARNING Risk of an accident from driving with overheated tyres</p> <p>Overheated tyres can burst.</p> <ul style="list-style-type: none"> ► Reduce speed so that the tyres cool down.

Display messages	Possible causes/consequences and ► Solutions
 <p data-bbox="53 347 233 378">Reduce speed</p>	<ul style="list-style-type: none"> <li data-bbox="486 181 1109 212">► Reduce your speed so that the tyres cool down. <p data-bbox="466 233 1886 295">* At least one tyre is overheating. The affected tyres are displayed in red. At temperatures close to the limit value, the tyres are displayed in yellow.</p> <div style="background-color: #f0f0f0; padding: 5px; border: 1px solid #ccc;"> <p data-bbox="500 326 1344 362">▲ WARNING Risk of an accident from driving with overheated tyres</p> <p data-bbox="506 378 848 409">Overheated tyres can burst.</p> <ul style="list-style-type: none"> <li data-bbox="506 419 1073 450">► Reduce speed so that the tyres cool down. </div> <ul style="list-style-type: none"> <li data-bbox="486 481 1109 512">► Reduce your speed so that the tyres cool down.

Warning and indicator lamps

Overview of indicator and warning lamps

Some systems will perform a self-test when the vehicle is switched on. Some indicator and warning lamps may briefly light up or flash. This behaviour is non-critical. These indicator and warning lamps indicate a malfunction only if they light up or flash after the vehicle has been started or during a journey.

Driver's display

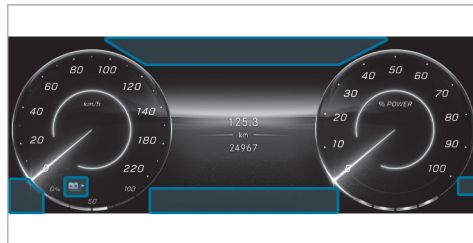

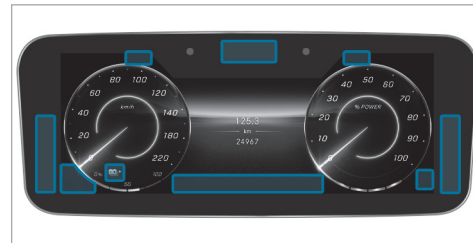

Driver's display with driver camera





Indicator and warning lamps





Occupant safety

-  Restraint system (→ page 860)
-  Seat belt (→ page 860)



Drive system

-  Reduced power (→ page 861)
-  System error (→ page 861)
-  Electrical fault (→ page 861)

Vehicle















-  Trailer hitch (→ page 862)
-  Power steering (yellow) (→ page 862)
-  Power steering (red) (→ page 862)
-  Rear axle steering (yellow) (→ page 862)
-  Rear axle steering (red) (→ page 862)

Brakes

-  Electric parking brake (yellow) (→ page 865)
-  Electric parking brake (red) (→ page 865)
-  Brakes (yellow) (→ page 865)

 Brakes (red) (→ page 865)

Driving and driving safety systems

-  ABS (→ page 867)
-  ESP® (→ page 867)
-  ESP® OFF (→ page 867)
-  ESP® OFF (→ page 867)
-  ESP® SPORT (→ page 867)
-  ATTENTION ASSIST (→ page 867)
-  Traffic Sign Assist (→ page 867)
-  Speed Limit Assist (→ page 867)
-  Distance warning (→ page 867)
-  Active Brake Assist (→ page 867)
-  Active Brake Assist (→ page 867)
-  Active Brake Assist (→ page 867)
-  AIRMATIC (→ page 867)
-  AMG RIDE CONTROL + (→ page 867)





Mercedes-Benz emergency call system

-  Mercedes-Benz emergency call system (→ page 874)



Tyre pressure monitoring system

-  Tyre pressure monitoring system (→ page 874)



Exterior lighting

-  Side lights (→ page 212)
-  Low beam (→ page 212)
-  High beam (→ page 214)
-  Turn signal lights (→ page 214)
-  Rear fog light (→ page 212)

Symbols on the central display



-  Drive Away Assist (→ page 386)
-  Rear cross traffic warning (→ page 387)
-  Manoeuvring brake function (→ page 388)

Occupant safety

Warning/indicator lamp	Possible causes/consequences and ► Solutions
 <p data-bbox="53 350 363 412">Restraint system warning lamp</p>	<p data-bbox="451 234 1269 296">* The restraint system red warning lamp is lit while the vehicle is on. The restraint system is malfunctioning (→ page 94).</p> <div data-bbox="472 319 1923 619" style="border: 1px solid gray; padding: 10px;"> <p data-bbox="482 329 1351 363">⚠ DANGER Risk of fatal injuries due to restraint system malfunctions</p> <p data-bbox="488 379 1892 441">Components in the restraint system may be activated unintentionally or not deploy as planned in an accident. In the event of an accident, the high-voltage on-board electrical system may not be deactivated as intended.</p> <p data-bbox="488 456 1878 513">You may suffer an electric shock if you touch the damaged components of the high-voltage on-board electrical system.</p> <ul style="list-style-type: none"> <li data-bbox="488 529 1684 563">► Have the restraint system checked and repaired immediately at a qualified specialist workshop. <li data-bbox="488 573 1173 608">► After an accident, switch off the vehicle immediately. </div> <ul style="list-style-type: none"> <li data-bbox="466 638 731 672">► Drive on carefully. <li data-bbox="466 682 1024 716">► Note the messages on the driver's display. <li data-bbox="466 727 1142 761">► Consult a qualified specialist workshop immediately.
 <p data-bbox="53 896 335 958">Seat belt warning lamp flashes</p>	<p data-bbox="451 780 1565 842">* The red seat belt warning lamp flashes and an intermittent warning tone sounds. The driver or front passenger has not fastened their seat belt while the vehicle is in motion.</p> <ul style="list-style-type: none"> <li data-bbox="466 852 938 886">► Fasten your seat belt (→ page 94). <p data-bbox="466 886 1030 921">There are objects on the front passenger seat.</p> <ul style="list-style-type: none"> <li data-bbox="466 931 1128 965">► Remove the objects from the front passenger seat.

Warning/indicator lamp	Possible causes/consequences and ► Solutions
 <p data-bbox="118 298 398 363">Seat belt warning lamp lights up</p>	<p data-bbox="513 184 1371 213">* The red seat belt warning lamp lights up once the vehicle has started.</p> <p data-bbox="529 225 1167 254">In addition, an intermittent warning tone may sound.</p> <p data-bbox="529 260 1692 289">The red seat belt warning lamp reminds the driver and front passenger to fasten their seat belts.</p> <p data-bbox="529 301 1003 330">► Fasten your seat belt (→ page 94).</p> <p data-bbox="529 356 1755 385">If you have placed objects on the front passenger seat, the red seat belt warning lamp may remain lit.</p>



Drive system

Warning/indicator lamp	Possible causes/consequences and ► Solutions
 <p data-bbox="118 676 410 741">Reduced-power warning lamp</p>	<p data-bbox="513 562 1091 627">* The yellow reduced-power warning lamp is on. Drive system power output is reduced.</p> <p data-bbox="529 640 1085 669">► Note the messages on the driver's display.</p>
 <p data-bbox="118 878 445 907">System error warning lamp</p>	<p data-bbox="513 764 1743 819">* The red system error warning lamp is lit while the vehicle is in a state of operational readiness READY.</p> <p data-bbox="529 798 1044 827">There is a malfunction in the drive system.</p> <p data-bbox="529 840 1085 869">► Note the messages on the driver's display.</p>

Warning/indicator lamp	Possible causes/consequences and ► Solutions
 <p data-bbox="51 295 398 326">Electrical fault warning lamp</p>	<p data-bbox="439 181 981 243">* The red electrical fault warning lamp is lit. There is a fault with the electrics.</p> <ul style="list-style-type: none"> <li data-bbox="459 253 1022 284">► Note the messages on the driver's display.



Vehicle

Warning/indicator lamp	Possible causes/consequences and ► Solutions
 <p data-bbox="51 616 367 647">Trailer hitch warning lamp</p>	<p data-bbox="439 502 940 564">* The red trailer hitch warning lamp is lit. The trailer hitch is not operational.</p> <div data-bbox="470 590 1911 637" style="background-color: #f0f0f0; padding: 5px;"> <p data-bbox="480 600 1257 631">⚠ WARNING Risk of an accident if the ball neck is not locked</p> </div> <div data-bbox="470 642 1911 823" style="border: 1px solid #ccc; padding: 5px;"> <p data-bbox="480 647 909 678">The trailer may become detached.</p> <ul style="list-style-type: none"> <li data-bbox="480 688 1686 720">► Stop the vehicle immediately in accordance with the traffic conditions. Do not continue driving. <li data-bbox="480 730 1195 761">► Uncouple the trailer and secure it against rolling away. <li data-bbox="480 771 1788 802">► Initiate a new swivelling procedure and do not re-couple the trailer until the display message disappears. </div> <ul style="list-style-type: none"> <li data-bbox="459 839 1022 870">► Note the messages on the driver's display.

Warning/indicator lamp	Possible causes/consequences and ► Solutions
 <p data-bbox="118 298 404 363">Power steering warning lamp (yellow)</p>	<p data-bbox="513 184 1412 246">* The yellow power steering warning lamp is lit while the vehicle is running. The power assistance or the steering itself is malfunctioning.</p> <p data-bbox="529 260 1085 288">► Note the messages on the driver's display.</p>
 <p data-bbox="118 498 404 563">Power steering warning lamp (red)</p>	<p data-bbox="513 384 1377 446">* The red power steering warning lamp is lit while the vehicle is running. The power assistance or the steering itself is malfunctioning.</p> <div data-bbox="533 467 1984 689" style="border: 1px solid black; padding: 10px;"> <p data-bbox="547 480 1320 508">▲ WARNING Risk of accident if steering capability is impaired</p> <p data-bbox="553 529 1641 557">If the steering does not function as intended, the vehicle's operating safety is jeopardised.</p> <ul style="list-style-type: none"> <li data-bbox="553 570 1937 632">► Pull over and stop the vehicle safely as soon as possible, paying attention to road and traffic conditions. Do not continue driving under any circumstances. <li data-bbox="553 646 1075 674">► Consult a qualified specialist workshop. </div> <p data-bbox="529 712 1085 740">► Note the messages on the driver's display.</p>
 <p data-bbox="118 881 441 946">Rear axle steering warning lamp (yellow)</p>	<p data-bbox="513 767 1443 829">* The yellow rear axle steering warning lamp is lit while the vehicle is running. The rear axle steering is malfunctioning.</p> <p data-bbox="529 843 1085 871">► Note the messages on the driver's display.</p>

Warning/indicator lamp	Possible causes/consequences and ► Solutions
 <p data-bbox="53 298 378 363">Rear axle steering warning lamp (red)</p>	<p data-bbox="451 184 1344 246">* The red rear axle steering warning lamp is lit while the vehicle is running. The rear axle steering is malfunctioning.</p> <div data-bbox="472 270 1917 490"><p data-bbox="482 280 1257 311">▲ WARNING Risk of accident if steering capability is impaired</p><p data-bbox="492 329 1575 360">If the steering does not function as intended, the vehicle's operating safety is jeopardised.</p><ul data-bbox="492 370 1876 479" style="list-style-type: none"><li data-bbox="492 370 1876 438">► Pull over and stop the vehicle safely as soon as possible, paying attention to road and traffic conditions. Do not continue driving under any circumstances.<li data-bbox="492 448 1011 479">► Consult a qualified specialist workshop.</div> <p data-bbox="466 515 1024 547">► Note the messages on the driver's display.</p>

Brakes



Warning/indicator lamp	Possible causes/consequences and ► Solutions
 <p>Electric parking brake indicator lamp (red)</p>  <p>Electric parking brake indicator lamp (yellow)</p>	<p>* The red electric parking brake indicator lamp flashes or is lit. The yellow electric parking brake indicator lamp is also lit in the event of a malfunction.</p> <p>► Note the messages on the driver's display.</p>
 <p>Brakes warning lamp (yellow)</p>	<p>* The yellow brake warning lamp is lit while the vehicle is running.</p> <div style="background-color: #f0f0f0; padding: 5px; border: 1px solid #ccc;"> <p>⚠ WARNING Risk of an accident due to a brake system malfunction</p> <p>If the brake system is malfunctioning, braking characteristics may be impaired.</p> <p>► Drive on carefully.</p> <p>► Have the brake system checked immediately at a qualified specialist workshop.</p> </div> <p>The Hill Start Assist may be malfunctioning.</p> <p>► Adjust your speed and drive on carefully, leaving a suitable distance to the vehicle in front.</p>



Warning/indicator lamp	Possible causes/consequences and ► Solutions
 <p data-bbox="57 391 372 422">Brakes warning lamp (red)</p>	<ul style="list-style-type: none"> <li data-bbox="466 184 1218 215">► If the driver's display shows a display message, observe it. <li data-bbox="466 225 989 256">► Consult a qualified specialist workshop. <p data-bbox="449 277 1218 308">* The red brakes warning lamp is lit while the vehicle is running.</p> <p data-bbox="466 319 670 350">Possible causes:</p> <ul style="list-style-type: none"> <li data-bbox="478 360 1618 391">• The brake force boosting is malfunctioning and the braking characteristics may be affected. <li data-bbox="478 401 1214 433">• There is insufficient brake fluid in the brake fluid reservoir. <ul style="list-style-type: none"> <li data-bbox="466 453 1026 484">► Note the messages on the driver's display. <div data-bbox="474 509 1923 560" style="background-color: #e0e0e0; padding: 5px;"> <p data-bbox="478 520 1488 551">▲ WARNING Risk of accident and injury if brake force boosting is malfunctioning</p> </div> <p data-bbox="486 571 1851 634">If brake force boosting is malfunctioning, increased brake pedal force may be necessary for braking. The braking characteristics may be impaired. The braking distance can increase in emergency braking situations.</p> <ul style="list-style-type: none"> <li data-bbox="486 644 1263 675">► Stop in a safe location immediately. Do not continue driving! <li data-bbox="486 685 1013 716">► Consult a qualified specialist workshop. <div data-bbox="474 754 1923 804" style="background-color: #e0e0e0; padding: 5px;"> <p data-bbox="478 764 1234 795">▲ WARNING Risk of an accident due to low brake fluid level</p> </div> <p data-bbox="486 816 1700 847">If the brake fluid level is too low, the braking effect and the braking characteristics may be impaired.</p> <ul style="list-style-type: none"> <li data-bbox="486 857 1847 888">► Stop the vehicle as soon as possible, paying attention to road and traffic conditions. Do not continue driving. <li data-bbox="486 899 1013 930">► Consult a qualified specialist workshop.



Warning/indicator lamp	Possible causes/consequences and ► Solutions
	<ul style="list-style-type: none"> ► Do not top up the brake fluid.



Driving and driving safety systems





Warning/indicator lamp	Possible causes/consequences and ► Solutions
 <p data-bbox="118 529 339 560">ABS warning lamp</p>	<p data-bbox="513 415 1283 477">* The yellow ABS warning lamp is lit while the vehicle is running. ABS is malfunctioning.</p> <p data-bbox="513 487 1255 519">If an additional warning tone sounds, EBD is malfunctioning.</p> <p data-bbox="513 529 1467 560">Other driving systems and driving safety systems may also be malfunctioning.</p> <ul style="list-style-type: none"> <li data-bbox="513 570 1085 601">► Note the messages on the driver's display. <div data-bbox="533 632 1984 684" style="background-color: #e0e0e0; padding: 5px;"> <p data-bbox="543 648 1432 679">⚠ WARNING There is a risk of skidding if EBD or ABS is malfunctioning</p> </div> <p data-bbox="543 695 993 726">The wheels may lock during braking.</p> <p data-bbox="543 736 1949 798">The steerability and braking characteristics are heavily impaired and the braking distance may increase. In addition, other driving safety systems are switched off.</p> <ul style="list-style-type: none"> <li data-bbox="543 809 813 840">► Drive on carefully. <li data-bbox="543 850 1549 881">► Have the brake system checked immediately at a qualified specialist workshop. <ul style="list-style-type: none"> <li data-bbox="513 923 793 954">► Drive on carefully.



Warning/indicator lamp	Possible causes/consequences and ► Solutions
 <p data-bbox="53 350 384 381">ESP® warning lamp flashes</p>	<ul style="list-style-type: none"> <li data-bbox="466 184 991 215">► Consult a qualified specialist workshop. <p data-bbox="449 236 1297 303">* The yellow ESP® warning lamp flashes while the vehicle is in motion. One or more wheels have reached their grip limit (→ page 307).</p> <ul style="list-style-type: none"> <li data-bbox="466 313 1287 344">► Adapt your driving style to suit the road and weather conditions.
 <p data-bbox="53 521 404 552">ESP® warning lamp lights up</p>	<p data-bbox="449 407 1236 474">* The yellow ESP® warning lamp is lit while the vehicle is running. ESP® is malfunctioning.</p> <p data-bbox="466 484 1533 515">Other driving systems and driving safety systems (e.g. BAS) may also be malfunctioning.</p> <ul style="list-style-type: none"> <li data-bbox="466 526 1022 557">► Note the messages on the driver's display. <div data-bbox="470 588 1921 821" style="border: 1px solid gray; padding: 5px;"> <p data-bbox="480 603 1175 635">⚠ WARNING Risk of skidding if ESP® is malfunctioning</p> <p data-bbox="486 655 1870 717">If ESP® is malfunctioning, ESP® cannot carry out vehicle stabilisation. In addition, other driving safety systems are switched off.</p> <ul style="list-style-type: none"> <li data-bbox="486 733 746 764">► Drive on carefully. <li data-bbox="486 774 1195 806">► Have ESP® checked at a qualified specialist workshop. </div> <ul style="list-style-type: none"> <li data-bbox="466 842 725 873">► Drive on carefully. <li data-bbox="466 883 1144 914">► Consult a qualified specialist workshop immediately.

Warning/indicator lamp	Possible causes/consequences and ► Solutions
 <p data-bbox="118 303 410 334">ESP® OFF warning lamp</p>	<p data-bbox="513 187 1357 249">* The yellow ESP® OFF warning lamp is lit while the vehicle is running. ESP® is deactivated.</p> <p data-bbox="529 265 1422 296">Other driving systems and driving safety systems may also be inoperative.</p> <div data-bbox="533 319 1984 370" style="background-color: #f0f0f0; padding: 5px;"> <p data-bbox="547 329 1365 365">▲ WARNING Risk of skidding when driving with ESP® deactivated</p> </div> <p data-bbox="549 384 1821 415">ESP® does not act to stabilise the vehicle. The availability of further driving safety systems is also limited.</p> <ul style="list-style-type: none"> <li data-bbox="549 427 813 458">▶ Drive on carefully. <li data-bbox="549 471 1295 502">▶ Deactivate ESP® only for as long as the situation requires. <p data-bbox="549 536 1187 567">If ESP® cannot be activated, ESP® is malfunctioning.</p> <ul style="list-style-type: none"> <li data-bbox="549 580 1408 611">▶ Have ESP® checked immediately at a qualified specialist workshop. <p data-bbox="529 650 1250 681">► Observe the notes on deactivating ESP® (→ page 307).</p>
	<p data-bbox="513 705 1389 767">* The yellow ESP® OFF warning lamps are lit while the vehicle is running. ESP® is deactivated.</p> <p data-bbox="529 783 1422 814">Other driving systems and driving safety systems may also be inoperative.</p> <div data-bbox="533 837 1984 888" style="background-color: #f0f0f0; padding: 5px;"> <p data-bbox="547 847 1365 883">▲ WARNING Risk of skidding when driving with ESP® deactivated</p> </div> <p data-bbox="549 902 1821 933">ESP® does not act to stabilise the vehicle. The availability of further driving safety systems is also limited.</p>

Warning/indicator lamp	Possible causes/consequences and ► Solutions
	<ul style="list-style-type: none"> ► Drive on carefully. ► Deactivate ESP® only for as long as the situation requires. <p>If ESP® cannot be activated, ESP® is malfunctioning.</p> <ul style="list-style-type: none"> ► Have ESP® checked immediately at a qualified specialist workshop. <p>► Observe the notes on deactivating ESP® (→ page 308).</p>
 <p>The icon shows a car with a wavy line underneath it, indicating a loss of control or skidding. Below the car is the word "OFF". The entire icon is enclosed in a rectangular border. Below the border, the text "ESP SPORT" is written in a bold, sans-serif font.</p>	<p>* ESP® SPORT is activated while the vehicle is running. When ESP® SPORT is activated, ESP® will stabilise the vehicle only to a limited extent.</p> <p>▲ WARNING Risk of skidding if ESP® SPORT is used incorrectly</p> <p>When you activate ESP® SPORT, there is an increased risk of skidding and having an accident.</p> <ul style="list-style-type: none"> ► Activate ESP® SPORT only in the circumstances described below. <p>► Observe the notes on activating ESP® SPORT(→ page 308).</p>
 <p>The icon shows a coffee cup with a wavy line above it, representing a drowsiness or attention warning. Below the cup is the word "OFF". The entire icon is enclosed in a rectangular border. Below the border, the text "ATTENTION ASSIST warning lamp" is written in a bold, sans-serif font.</p>	<p>* The ATTENTION ASSIST warning lamp is lit. ATTENTION ASSIST is malfunctioning.</p> <ul style="list-style-type: none"> ► Consult a qualified specialist workshop.

Warning/indicator lamp	Possible causes/consequences and ► Solutions
 <p data-bbox="118 298 441 364">Traffic Sign Assist warning lamp</p>	<p data-bbox="506 184 1034 250">* The Traffic Sign Assist warning lamp is lit. Traffic Sign Assist is malfunctioning.</p> <p data-bbox="527 261 1087 292">► Note the messages on the driver's display.</p>
 <p data-bbox="118 500 441 566">Speed Limit Assist warning lamp</p>	<p data-bbox="506 386 1044 452">* The Speed Limit Assist warning lamp is lit. Speed Limit Assist is malfunctioning.</p> <p data-bbox="527 463 1087 494">► Note the messages on the driver's display.</p>
 <p data-bbox="118 699 441 765">Warning lamp for distance warning</p>	<p data-bbox="506 585 1381 651">* The red distance warning lamp lights up while the vehicle is in motion. The distance to the vehicle in front is too small for the speed selected.</p> <p data-bbox="527 662 1631 693">If there is an additional warning tone, you are approaching an obstacle at too high a speed.</p> <p data-bbox="527 703 993 734">► Be prepared to brake immediately.</p> <p data-bbox="527 744 846 775">► Increase the distance.</p> <p data-bbox="527 796 1095 827">Function of Active Brake Assist (→ page 336).</p>

Warning/indicator lamp	Possible causes/consequences and ► Solutions
 <p data-bbox="53 301 390 363">Active Brake Assist warning lamp</p>	<ul style="list-style-type: none"> <li data-bbox="445 184 1719 249">* The Active Brake Assist warning lamp is on. Due to dirty sensors or a malfunction, the system is not available or the range of functions is restricted. <li data-bbox="466 260 1024 291">► Note the messages on the driver's display.
 <p data-bbox="53 503 390 565">Active Brake Assist warning lamp</p>	<ul style="list-style-type: none"> <li data-bbox="445 386 1739 493">* The Active Brake Assist warning lamp is on. The system is switched off or the range of functions has been automatically restricted. This may be the case if the driver is not wearing a seat belt or another driving system has been activated. <li data-bbox="466 503 1197 534">► Observe the notes on Active Brake Assist (→ page 336).
 <p data-bbox="53 705 390 767">Active Brake Assist warning lamp</p>	<ul style="list-style-type: none"> <li data-bbox="445 588 1637 695">* The Active Brake Assist warning lamp is on. After you drive off, the system's range of functions will be restricted due to the teach-in process. Depending on the ambient conditions, the teach-in process may take a few minutes. <li data-bbox="466 705 1197 736">► Observe the notes on Active Brake Assist (→ page 336).
 <p data-bbox="53 907 390 969">Suspension warning lamp (yellow)</p>	<ul style="list-style-type: none"> <li data-bbox="445 790 1024 855">* The yellow AIRMATIC warning lamp is lit. A fault has occurred in AIRMATIC. <li data-bbox="466 866 1024 897">► Note the messages on the driver's display.

Warning/indicator lamp	Possible causes/consequences and ► Solutions
 <p data-bbox="118 298 431 363">Suspension warning lamp (red)</p>	<p data-bbox="506 184 987 246">* The red AIRMATIC warning lamp is lit. A fault has occurred in AIRMATIC.</p> <div data-bbox="533 270 1984 373" style="border: 1px solid gray; padding: 5px;"> <p data-bbox="547 280 1494 311">! NOTE The vehicle's driving characteristics will have changed significantly.</p> <p data-bbox="547 329 1075 360">► Consult a qualified specialist workshop.</p> </div> <p data-bbox="527 394 1089 425">► Note the messages on the driver's display.</p> <p data-bbox="527 439 1054 470">► Consult a qualified specialist workshop.</p>
 <p data-bbox="118 609 431 671">Suspension warning lamp (yellow)</p>	<p data-bbox="506 495 1181 557">* The yellow AMG RIDE CONTROL + warning lamp is lit. There is a fault in the AMG RIDE CONTROL +.</p> <p data-bbox="527 567 1089 598">► Note the messages on the driver's display.</p>

Mercedes-Benz emergency call system

Warning/indicator lamp	Possible causes/consequences and ► Solutions
 <p>Mercedes-Benz emergency call system warning lamp</p>	<p>*The Mercedes-Benz emergency call system is malfunctioning. The Mercedes me connect system is also malfunctioning.</p> <ul style="list-style-type: none"> ► Consult a qualified specialist workshop.

Tyre pressure monitor

Warning/indicator lamp	Possible causes/consequences and ► Solutions
 <p>Tyre pressure monitoring system warning lamp flashes</p>	<p>*The yellow tyre pressure monitor warning lamp (pressure loss/malfunction) flashes for approximately one minute and then remains lit. The tyre pressure monitoring system is malfunctioning.</p> <div style="border: 1px solid gray; padding: 5px; margin: 5px 0;"> <p>▲ WARNING There is a risk of an accident if the tyre pressure monitoring system is malfunctioning</p> <p>The tyre pressure monitoring system cannot issue a warning if there is pressure loss in one or more of the tyres. Tyres with insufficient tyre pressure may impair the driving characteristics as well as steering and braking.</p> <ul style="list-style-type: none"> ► Have the tyre pressure monitoring system checked at a qualified specialist workshop. </div> <ul style="list-style-type: none"> ► Consult a qualified specialist workshop.

Warning/indicator lamp	Possible causes/consequences and ► Solutions
 <p data-bbox="118 301 451 394">Tyre pressure monitoring system warning lamp lights up</p>	<p data-bbox="513 184 1692 249">* The yellow tyre pressure monitoring system warning lamp (pressure loss/malfunction) is lit. The tyre pressure monitoring system has detected tyre pressure loss in at least one of the tyres.</p> <div data-bbox="533 270 1984 596"><p data-bbox="547 280 1361 311">▲ WARNING Risk of an accident due to insufficient tyre pressure</p><ul data-bbox="564 329 1647 446" style="list-style-type: none">• The tyres can burst.• The tyres can wear excessively and/or unevenly.• The driving characteristics as well as the steering and braking may be greatly impaired.<p data-bbox="553 467 1060 498">You could then lose control of the vehicle.</p><ul data-bbox="553 513 1116 586" style="list-style-type: none">▶ Observe the recommended tyre pressures.▶ Adjust the tyre pressure if necessary.</div> <ul data-bbox="533 617 1275 689" style="list-style-type: none">▶ Stop the vehicle in accordance with the traffic conditions.▶ Check the tyre pressure and the tyres.

- 1, 2, 3 ...
- 4MATIC**..... 275
- A**
- A/C function**
 Activating/deactivating (operating unit)..... 237
 Switching on/off (MBUX)..... 238
- ABS**..... 306
- Accelerator pedal**..... 264
- Access data**
 Setting (Bluetooth®)..... 563
- Accident**
 ERA-GLONASS test mode..... 559
- Accident prevention**..... 386
- Accident, emergency call**..... 55, 555
- Acoustic presence indicator**..... 250
- Acoustic vehicle alerting system**..... 250
- Activating/deactivating the acoustic lock-
 ing verification signal**..... 135
- Active Blind Spot Assist**
 Activating/deactivating..... 354
- Brake application..... 353
 Exit warning..... 350
 Function..... 350
 Trailer operation..... 353
- Active bonnet**..... 596
- Active Brake Assist**
 Function..... 336
 Setting..... 341
- Active Distance Assist DISTRONIC**
 Activate/deactivate variable limiter..... 324
 Activating/deactivating..... 324
 Active Emergency Stop Assist..... 332
 Active Lane Change Assist..... 334
 Active Speed Limit Assist..... 327
 Calling up a speed..... 324
 Function..... 321
 Increases/decreases the speed..... 324
 Route-based speed adaptation..... 328
 Storing a speed..... 324
- Active Emergency Stop Assist**..... 332
- Active headlamps**..... 216
- Active Lane Change Assist**
 Activating/deactivating..... 336
 Function..... 334
- Active Lane Keeping Assist**
 Activating/deactivating..... 357
 Function..... 354
 Setting the sensitivity..... 357
 Trailer operation..... 354
- Active light function**..... 216
- Active Parking Assist**
 Automatic braking function..... 381
 Cross traffic warning..... 387
 Drive Away Assist..... 386
 Exiting a parking space..... 379
 Function..... 375
 Manoeuvring brake function..... 388
 Memory Parking Assist..... 389
 Parking..... 377
 Pausing..... 381
 Remote Parking Assist..... 382
- Active Service System PLUS**..... 594
- Active Speed Limit Assist**..... 327
- Active Steering Assist**
 Activating/deactivating..... 332
 Active Emergency Stop Assist..... 332
 Active Lane Change Assist..... 334
 Function..... 330

- Active Stop-and-Go Assist**..... 330
- Adaptive brake lights**..... 314
- Adaptive cruise control**..... 328
- Adaptive Highbeam Assist**
Activating/deactivating..... 221
- Adaptive Highbeam Assist Plus**
Switching on/off..... 223
- Additional door lock**..... 143
- Adjusting bass, mid-range and treble settings**
Advanced sound system..... 591
- Adjusting mid-range, treble and bass settings**
Advanced sound system..... 591
- Adjusting the balance/fader**
Advanced sound system..... 591
Burmester® 3D-surround sound system..... 590
- Adjusting the bass, mid-range and treble**
Burmester® 3D-surround sound system..... 589
- Adjusting the mid-range, treble and bass**
Burmester® 3D-surround sound system..... 589
- Adjusting the sound focus**
Burmester® 3D-surround sound system..... 591
- Adjusting treble, mid-range and bass settings**
Advanced sound system..... 591
Burmester® 3D-surround sound system..... 589
- Advanced sound system**
Adjusting the balance/fader..... 591
Adjusting treble, mid-range and bass settings..... 591
Calling up the sound menu..... 591
Information..... 591
Switching loudness normalisation on/off..... 591
- After-sales service**..... 594
- Air conditioning menu**
Air distribution..... 240
Calling up..... 237
Climate control..... 238
- Fragrance system..... 241
Front air conditioning..... 237
Ionisation..... 241
Rear compartment climate control..... 240
Selecting climate modes..... 239
- Air distribution**
Overview..... 239
Setting..... 233, 234, 240
- Air freshener system**..... 241
- Air inlet**..... 599
- Air pressure**..... 628
- Air suspension**..... 357
- Air vents**
Setting..... 248
- Air/water duct**..... 599
- Airbag**
Inflating..... 102
Overview..... 107
PASSENGER AIR BAG indicator lamps..... 96
Warning lamp..... 94
- Airflow**
Setting..... 233, 234

- AIRMATIC**
 GPS-based vehicle level..... 359
 Setting the vehicle level..... 358
 Vehicle levels..... 357
- Alarm system**..... 168
- All-wheel drive**..... 275
- Alternative route**..... 498
- Ambient lighting**..... 224
- AMG Active Sound, Vehicle sound**
 Selecting sound characteristic (steering-wheel button)..... 265
- AMG DYNAMIC PLUS package,**
 Power increase..... 306
- AMG DYNAMIC SELECT**
 Setting drive programs..... 271
- AMG Performance**
 Information..... 21
- AMG RIDE CONTROL +**
 Function..... 359
 Selecting the suspension setting..... 360
 Setting the vehicle level..... 361
- AMG steering wheel buttons**
 Setting..... 266
- AMG steering-wheel buttons**
 Function..... 265
- AMG TRACK PACE**
 Configuring..... 471
 Drag Race..... 470
 Function..... 467
 Telemetry display..... 471
 Track Race..... 468
- Android Auto**
 Connecting a mobile phone (wired)..... 542
 Connecting a mobile phone (wireless).... 543
 Ending..... 543
 Information..... 542
 Sound settings..... 543
 Transferred vehicle data..... 544
- Android smartphone**..... 541
- Animals**..... 103
- Anti-lock braking system**..... 306
- Anti-theft alarm system**..... 168
- Anti-theft protection**
 Additional door lock..... 143
 Immobiliser..... 168
- Apple CarPlay®**, Smartphone
 Connecting an iPhone® (cable)..... 540
 Connecting an iPhone® (wireless)..... 540
 Ending..... 541
 Notes..... 540
 Overview..... 539
 Sound settings..... 541
 Transferred vehicle data..... 544
- Apps, Mercedes me**
 Mercedes me calls..... 545
 Mercedes me connect..... 549
 Remote Parking Assist..... 382
 Selecting (MBUX multimedia system).... 552
- Assembly licence plate, front**..... 78
- Assistance system**..... 305
- Assistant display**
 Menu (driver display)..... 409
- ASSYST PLUS**
 Battery disconnection periods..... 595
 Service interval display..... 594
 Service requirements..... 594
- ATA**
 Deactivating the alarm..... 169
 Function..... 168

- Interior protection..... 170
- Interior protection function..... 170
- Tow-away protection..... 169
- Tow-away protection function..... 169
- ATTENTION ASSIST**
 - Function..... 315
 - Setting..... 317
- Attention assistant**..... 315
- Augmented reality**
 - MBUX route guidance..... 511
- Authorisations**
 - Setting..... 460
- Authorised workshop**..... 85
- Automatic car wash**..... 25, 599
- Automatic car wash mode**..... 601
- Automatic climate control**..... 238
- Automatic co-driver airbag shutoff**
 - Function..... 98
- Automatic distance control**..... 321
- Automatic driving lights**..... 213
- Automatic emergency call**..... 556
- Automatic front passenger airbag shutoff**
 - Information (child restraint system on the front passenger seat)..... 114
 - PASSENGER AIR BAG indicator lamps..... 96
- Automatic measures after an accident**..... 101
- Automatic mirror folding function**..... 231
- Automatic seat adjustment**..... 180
- Automatic transmission**..... 266, 267
- Autonomous braking**..... 336
- AVAS**..... 250
- Axle load**
 - Trailer operation..... 769
 - Trailer operation (Mercedes-AMG vehicles)..... 769
- B**
- Bad weather light**..... 217
- Ball neck**
 - Folding out/in..... 36, 394
 - Trailer coupling..... 396
- BAS**..... 306
- Basic information**..... 91
- Battery**
 - High-voltage battery..... 617
- Battery (12 V battery)**
 - Charging..... 48, 617
 - Notes..... 616
 - Replacing..... 618
 - Starting assistance..... 48, 617
- Battery (high-voltage on-board electrical system)**..... 763
- Battery (key)**..... 136
- Beginner driver mode**
 - Activating/deactivating..... 315
 - Function..... 314
- Belt**
 - Adjusting the height..... 94
 - Fastening..... 94
 - Notes on wearing correctly..... 93
 - Releasing..... 107
- Bicycle rack**
 - Load capacity..... 768
 - Load capacity (Mercedes-AMG vehicles)..... 768
 - Trailer operation..... 399

- Blind Spot Assist**
 Activating/deactivating..... 354
 Function..... 350
- Bluetooth®**
 Connecting a mobile phone..... 11, 525
 Information..... 460
 Setting up an Internet connection..... 563
 Switching on/off..... 460
- Bonnet**
 Active bonnet..... 596
 Opening/closing..... 596
- Boot floor**
 Opening..... 36, 200
- Boot lid**
 Closing..... 155
 HANDS-FREE ACCESS..... 158
 Limiter..... 160
 Opening..... 155
 Power closing function..... 155
 Switching the separate locking feature on/off..... 160
- Brake Assist**
 Active Brake Assist..... 336
 Brake Assist System..... 306
- Brake Assist System**..... 306
- Brake disks**..... 257
- Brake fluid**..... 759
- Brake force distribution**..... 312
- Brake lamps**
 Adaptive brake lights..... 314
- Brake pads**..... 257
- Brakes**
 ABS (Anti-lock Braking System)..... 306
 Active Brake Assist..... 336
 Adaptive brake lights..... 314
 BAS (Brake Assist System)..... 306
 Driving tips..... 257
 EBD (Electronic Brakeforce Distribution)..... 312
 Electric parking brake..... 299
 Handbrake..... 299
 HOLD function..... 312
 Limited braking effect (salt-treated roads)..... 257
 New/replaced brake pads/brake discs.. 257
 Parking brake..... 299
 Post-collision brake..... 101
 Recuperation..... 260
- Running-in notes..... 257
- Braking assistance**
 Active Brake Assist..... 336
 Brake Assist System..... 306
- Breakdown**
 Flat tyre..... 49, 610
 Overview of aids..... 70
 Tow-starting..... 624
 Towing methods..... 50, 619
 Transporting the vehicle..... 621
 Wheel change..... 636
- Burmester® 3D-surround sound system**
 Adjusting the balance/fader..... 590
 Adjusting the sound focus..... 591
 Adjusting treble, mid-range and bass settings..... 589
 Automatic loudness normalisation..... 590
 Calling up the sound menu..... 589
 Information..... 589
 Selecting the sound profile..... 590
- C**
- Call list**
 Deleting..... 534



















- Making a call..... 533
- Overview..... 533
- Selecting options..... 533
- Calling the customer centre for Mercedes-Benz..... 545**
- Calling up a web page..... 565**
- Calling up the sound menu**
 - Advanced sound system..... 591
 - Burmester® 3D-surround sound system..... 589
- Calls, Telephone operation**
 - Accepting..... 530
 - Activating functions during a call..... 530
 - Calls with several participants..... 530
 - Declining..... 530
 - Ending a call..... 530
 - Incoming call during an existing call..... 531
 - Making..... 530
 - Mercedes me..... 544
 - Telephone..... 530
 - Using overhead control panel..... 544
 - Using the international dialling code..... 531
- Camera**
 - 360° camera..... 366
- Activating using GPS (reversing camera)..... 371
- Button..... 370
- Care..... 604
- Cleaning..... 604
- Driver camera..... 456
- Function..... 366
- Information..... 304
- Manage activation points..... 371
- Opening the camera cover (reversing camera)..... 371
- Reversing camera..... 364
- Select view..... 371
- Car key..... 134**
- Car wash**
 - Automatic car wash..... 25, 599
 - High-pressure cleaner..... 601
 - Washing by hand..... 602
- Car-to-X-Communication**
 - Display on map..... 510
 - Overview..... 509
 - Sending hazard warnings..... 510
- Care**
 - Air/water duct..... 599
- Automatic car wash..... 25, 599
- Camera..... 604
- Car parts..... 604
- Decorative foil..... 603
- Display..... 605
- Exterior lighting..... 604
- Head-up display..... 605
- High-pressure cleaner..... 601
- Paint..... 602
- Plastic trim..... 605
- Real wood/trim elements..... 605
- Roof lining..... 605
- Seat belt..... 605
- Steering wheel..... 605
- Trailer hitch..... 604
- Vehicle interior..... 605
- Vehicle socket for the high-voltage battery..... 604
- Washing by hand..... 602
- Wheels/rims..... 604
- Caring for plastic trim..... 605**
- Caring for rims..... 604**
- Caring for the roof lining..... 605**
- Caring for the steering wheel..... 605**







































- | | | | | | |
|--|---------|--|--------------|--|-----|
| Carrier | 190 | Ending the charging process (direct current, mode 4)..... | 293 | Charging process | |
| Central display | | Indicator lamps on vehicle socket..... | 284 | Paying..... | 489 |
| Operating..... | 438 | Mains socket, mode 2..... | 280 | Charging settings | 296 |
| Central locking system | | Maximum charging current (mains socket)..... | 282 | Charging stations | |
| Button..... | 144 | Notes on charging the high-voltage battery..... | 276 | Showing on the map..... | 488 |
| Key..... | 135 | Notes on the high-voltage battery..... | 617 | Checking the coolant level | 598 |
| Centre airbag (driver, front passenger) | | Rapid charging station, mode 4..... | 282 | Child safety lock | |
| Inflating..... | 102 | Recuperation..... | 260 | Rear door..... | 130 |
| Centre airbag (driver's backrest) | 107 | Starting the charging process (alternating current, mode 2/3)..... | 285 | Side window (rear)..... | 132 |
| Centre airbag (driver's seat backrest) | | Starting the charging process (direct current, mode 4)..... | 290 | Child seat | |
| Information..... | 108 | Stowing the charging cable..... | 278 | Adjusting the vehicle seat..... | 125 |
| Charge level display | 295 | USB port..... | 38, 192, 206 | Approval categories..... | 116 |
| Charge level/charge display | 295 | Wallbox, mode 3..... | 281 | Basic instructions..... | 110 |
| Charging | | Wirelessly charging a mobile phone..... | 207 | Brief overview of most important points..... | 109 |
| 12 V battery..... | 48, 617 | Charging cable | | Fitting ISOFIX/i-Size..... | 127 |
| At time of departure..... | 296 | Control panel..... | 283 | Front passenger seat..... | 113 |
| Charge level display..... | 295 | Stowing..... | 278 | Overview of warning stickers..... | 113 |
| Charging cable control panel..... | 283 | Charging near destination | | Rearward-facing..... | 116 |
| Charging station, mode 3..... | 281 | Route..... | 492 | Recommendations for child restraint systems..... | 118 |
| Configuring weekly profile..... | 296 | | | Risks/dangers..... | 111 |
| Ending the charging process (alternating current, mode 2/3)..... | 288 | | | Seats suitable for belt-secured child restraint systems..... | 123 |











































- Seats suitable for i-Size child restraint systems..... 122
- Seats suitable for ISOFIX child restraint systems..... 120
- Securing to the front passenger seat with the seat belt..... 130
- Securing to the rear seat with the seatbelt..... 130
- Top Tether..... 128
- Without automatic co-driver airbag shut-off..... 116
- Children**
- Avoiding dangers in the vehicle..... 111
- Basic instructions..... 110
- Chock**..... 49, 635
- CI+ capable CA module, HD programmes**
- Calling up a menu..... 588
- CI+-capable CA module**
- Inserting a Smart Card..... 587
- City lighting**..... 217
- Classic menu display content**
- Selecting..... 407
- Clean varnish**..... 602
- Cleaning**
- Air/water duct..... 599
- Automatic car wash..... 25, 599
- Camera..... 604
- Car parts..... 604
- Decorative foil..... 603
- High-pressure cleaner..... 601
- Paint..... 602
- Real wood/trim elements..... 605
- Sensors..... 604
- Vehicle interior..... 605
- Vehicle socket for the high-voltage battery..... 604
- Washing by hand..... 602
- Cleaning carpets**..... 605
- Cleaning seat covers**..... 605
- Climate control, Air conditioning system**
- Activating/deactivating..... 236
- Activating/deactivating (rear operating unit)..... 236
- Activating/deactivating the A/C function (control panel)..... 237
- Air conditioning menu..... 237
- Air distribution..... 233, 234
- Air distribution settings..... 239
- Air vents (front)..... 248
- Air vents (rear)..... 249
- Airflow..... 233, 234
- Automatic control..... 238
- Automatically controlling (rear operating unit)..... 238
- Closing/opening the windows (air-recirculation button)..... 52, 53
- Defrosting the windscreen..... 237
- Demisting the windscreen..... 233, 234
- Demisting windows..... 240
- Fine particle status display..... 237
- Fragrance system..... 241, 242
- Immediate pre-entry climate control..... 247
- Inserting/removing the flacon (fragrance system)..... 242
- Ionisation..... 241
- Notes..... 233
- Operating unit..... 233, 234
- Pre-entry climate control for departure time..... 245
- Pre-entry climate control when the vehicle is unlocked..... 244
- Rear operating unit..... 235
- Rear window heater..... 233, 234
- Resetting the climate control settings..... 54





























- Setting..... 237
- Switching air-recirculation mode on/off..... 241
- Switching the A/C function on/off (MBUX)..... 238
- Synchronisation function..... 240
- Temperature..... 233, 234
- Ventilation with comfort opening..... 162
- Windscreen heater..... 243
- Climate control settings**
 - Resetting..... 54
- Co-driver airbag shutoff, PASSENGER AIR BAG OFF**..... 98
- COC papers, Certificate of conformity**..... 644
- Cockpit**
 - Overview (central display)..... 58
 - Overview (MBUX Hyperscreen)..... 60
- Collision detection (parked vehicle)**
 - Setting..... 302, 303
- Combination switch**
 - Lights..... 214
 - Windscreen wipers..... 226
- Comfort**
 - Information..... 20
- Communication module**
 - Disconnecting automatically from the Internet..... 562
 - Setting up an Internet connection..... 562
- Commuter route**..... 498
- Compass**..... 516
- Components subject to radio regulations**
 - Declaration of conformity..... 79
- Connection status**
 - Displaying..... 565
 - Overview..... 564
- Contacts, Address book, Phone book**
 - Calling up..... 532
 - Deleting..... 533
 - Importing..... 532
 - Importing (overview)..... 532
 - Information..... 531
 - Making a call..... 532
 - Name format..... 532
 - Note about suggestions..... 529
 - Options..... 533
 - Selecting options for suggestions..... 529
 - Storing..... 532
- Content sharing menu**
 - Calling up..... 449
 - Controlling media playback..... 450
 - Sharing MBUX display content..... 450
- Control element (MBUX multimedia system)**
 - Setting acoustic feedback..... 438
- Control elements**..... 74
- Convenience closing**..... 163
- Convenience feature**
 - Closing/opening the windows (air-recirculation button)..... 52, 53
- Convenience opening**..... 162
- Coolant**
 - Notes..... 760
- Cooling**..... 233, 234
- Copyright**..... 90
- Cornering light**..... 216
- Correct use**..... 85
- Cover**..... 164
- Cross traffic (warning)**..... 387
- Crosswind Assist**..... 310

- Cruise control**
 - activating/deactivating..... 319
 - Calling up a speed..... 319
 - Function..... 317
 - Requirements:..... 319
 - Setting a speed..... 319
 - Storing a speed..... 319
- Cup holder**
 - Rear..... 204
- D**
- Damage**
 - Limited protection..... 103
- Damping system ADS PLUS**
 - AIRMATIC..... 357
 - Setting the vehicle level..... 358
- Dashcam**
 - Configuring settings..... 522
 - Selecting a USB device..... 521
 - Starting/stopping a video recording..... 522
- Data processing in the vehicle**..... 87
- Data protection**
 - Granting authorisations..... 460
- Data protection rights**..... 90
- Data storage**
 - Data protection rights..... 90
 - Electronic control units..... 87
 - Online services..... 90
- Deactivating the alarm**..... 169
- Dealership**..... 85
- Declaration of conformity**
 - Components subject to radio regula-
tions..... 79
 - Electromagnetic compatibility..... 78
 - Jack..... 81
 - TIREFIT kit..... 82
- Decorative foil**..... 603
- Defrost function**..... 237
- Deployed components**
 - Limited protection..... 103
- Deployment situations**..... 102
- Destination**
 - Editing a suggestion..... 506
 - Editing intermediate destinations..... 497
 - Editing the previous destinations..... 506
 - Saving as a favourite..... 506
- Destination entry**
 - Accepting a destination suggestion..... 480
 - Entering a 3 word address..... 482
 - Entering an intermediate destination..... 497
 - Entering geo-coordinates..... 482
 - Selecting a contact..... 482
 - Selecting a received destination..... 484
 - Selecting from favourites..... 483
 - Selecting from the map..... 483
 - Selecting previous destinations..... 480
- Destination entry (multimedia system)**
 - Notes..... 478
 - Selecting a POI..... 480
- Detecting inattentiveness**..... 315
- Diagnostics connection**..... 84
- DIGITAL LIGHT**
 - Activating/deactivating..... 220
 - Active headlamps..... 216
 - Adaptive Highbeam Assist..... 220
 - Adaptive Highbeam Assist Plus..... 222
 - Assistance functions..... 217
 - Bad weather light..... 217
 - City lighting..... 217
 - Cornering light..... 216

- Dynamic low beam..... 215
- Enhanced fog light function..... 217
- Motorway mode..... 216
- Overview..... 215
- Topographical compensation..... 217
- Digital Owner's Manual**..... 72
- Digital Vehicle Key**
- Function..... 138
- managing..... 140
- Problem..... 143
- remove..... 141
- Setting up..... 139
- Starting the vehicle..... 255
- Unlocking setting..... 143
- Unlocking/locking the vehicle..... 142
- Direct commands**
- Voice commands for MBUX voice assistant..... 425
- DIRECT SELECT lever**
- Engages neutral..... 273
- Engaging drive position..... 275
- Engaging park position automatically..... 273
- Engaging reverse gear..... 273
- Function..... 272
- Selecting park position..... 273
- Disconnect device (high-voltage on-board electrical system)**..... 250
- Display**
- Care..... 605
- Display (driver's display)**
- Overview of displays..... 416
- Overview of displays (Mercedes-AMG vehicles)..... 417
- Display (MBUX multimedia system)**
- Settings..... 458
- Display message**
- Calling up on driver display..... 770
- Notes..... 770
- Display messages**
-  --- km/h..... 837
-  --- km/h..... 831
-  --- km/h..... 831
-  12 V on-board electrical system Visit workshop..... 853
-  Acoustic presence indicator inoperative..... 795
-  ATTENTION ASSIST Microsleep Take a break!..... 830
-  ATTENTION ASSIST: Take a break!..... 830
-  Automatic driving lights inoperative..... 783
-  Battery capacity too low Stop Charge immediately..... 800
-  Battery overheated Stop, everybody out! Outdoors if possible..... 801
-  Beginning emergency stop... 841, 846
-  Brake immediately..... 823
-  Camera view restricted See Owner's Manual..... 848
-  Change key batteries..... 778
-  Charger cable connected..... 798
-  Check brake fluid level..... 825
-  Check tyre(s)..... 855
-  Compressor is cooling..... 836

-  Coolant Stop Switch off the vehicle..... 796
-  Currently unavailable Charge high-voltage battery..... 793
-  Currently unavailable High-voltage battery charging incomplete..... 793
-  currently unavailable See Owner's Manual (ABS and ESP®)..... 826
-  currently unavailable See Owner's Manual (ESP®)..... 827
-  Digital Vehicle Key Charge device..... 782
-  Do not forget key..... 781
-  Fault Drive at max. 80 km/h..... 833, 834
-  Front left malfunction Consult workshop..... 772
-  Front left parking lights..... 786
-  Front left turn signal..... 788
-  Front right malfunction Consult workshop..... 772
-  Front right parking lights..... 786
-  Front right turn signal..... 789
-  Have high-voltage system checked See Owner's Manual..... 802
-  inoperative See Owner's Manual (ABS and ESP®)..... 827
-  inoperative See Owner's Manual (EBD, ABS and ESP®)..... 829
-  inoperative See Owner's Manual (ESP®)..... 828
-  Inoperative..... 852
-  Key being taught in Please wait.... 779
-  Key being taught in Please wait.... 782
-  Key does not belong to vehicle.... 782
-  Key not detected (red display message)..... 778
-  Key not detected (white display message)..... 778
-  Key not detected Place Digital Vehicle Key in inductive charging bracket..... 780
-  Key not detected..... 780
-  Left brake lamp..... 790
-  Left cornering light..... 788
-  Left daytime running lights..... 787
-  Left low beam..... 786
-  Left main beam..... 787
-  Left mirror turn signal..... 789
-  Left tail light..... 790
-  Left window airbag malfunction Consult workshop..... 775
-  Lowering..... 835
-  Malfunction See Owner's Manual..... 783
-  Malfunction See Owner's Manual..... 824
-  Malfunction Stop vehicle..... 824
-  Malfunction Visit workshop..... 804

 Malfunction Visit workshop.....	801	 Pre-entry climate control via key currently unavailable. High-voltage battery low.....	794	 Replace key See Owner's Manual.....	781
 Malfunction.....	804	 Rear axle steering currently malfunctioning.....	812	 Replace key.....	777
 Malfunction.....	801	 Rear axle steering Malfunction Stop immediately.....	813	 Reserve level Charge high-voltage battery.....	804
 Max. speed 20km/h.....	836	 Rear axle steering Malfunction Visit workshop.....	813	 Restraint system malfunction Consult workshop.....	771
 Maximum speed exceeded.....	832	 Rear axle steering Malfunction Visit workshop.....	813	 Restricted during trailer operation.....	849
 Number plate lamp.....	791	 Rear fog light.....	791	 Reversing light.....	791
 Off.....	838	 Rear left seat backrest not locked.....	815	 Right brake lamp.....	790
 Off.....	829	 Rear left turn signal.....	788	 Right cornering light.....	788
 Output and range reduced See Owner's Manual.....	802	 Rear right seat backrest not locked.....	815	 Right daytime running lights.....	787
 Parking brake See Owner's Manual.....	820	 Rear right turn signal.....	789	 Right low beam.....	786
 Parking brake Switch on vehicle to release.....	823	 Rectify tyre pressure.....	856	 Right main beam.....	787
 passive.....	831	 Reduce speed.....	858	 Right mirror turn signal.....	789
 Performance severely limited.....	805	 Reduce speed.....	836	 Right tail light.....	791
 Pre-entry climate control via key available again after starting vehicle.....	794	 Release parking brake.....	823	 Right window airbag malfunction Consult workshop.....	775
				 Rising.....	836

 Second row of seats, left Malfunction Consult workshop..... 773	 Switch on headlamps..... 783	 Washer fluid flap open..... 816
 Second row of seats, right Malfunction Consult workshop..... 774	 temporarily unavailable Sensors dirty..... 847	 Wheel sensor(s) missing..... 855
 Start the vehicle to charge the 12 V battery..... 854	 Third brake lamp..... 790	AC charging inoperative Consult workshop..... 799
 Steering malfunction Drive carefully Visit workshop..... 811	 Top up coolant See Owner's Manual..... 796	Active Blind Spot Assist currently unavailable See Owner's Manual..... 844
 Steering malfunction Increased physical effort See Owner's Manual..... 811	 Top up washer fluid..... 816	Active Blind Spot Assist inoperative..... 845
 Steering malfunction Stop immediately See Owner's Manual..... 812	 Towing not permitted See Owner's Manual..... 795	Active Blind Spot Assist unavailable when towing a trailer See Owner's Manual..... 845
 Stop Switch off the vehicle..... 804	 Trailer brake lamp..... 792	Active bonnet malfunction See Owner's Manual..... 814
 Stop vehicle Leave vehicle on to charge the 12 V battery..... 854	 Trailer coupling Check lock (white display message)..... 807	Active Brake Assist Functions currently limited See Owner's Manual..... 839
 STOP Vehicle level too low..... 835	 Trailer coupling Check lock (red display message)..... 809	Active Brake Assist Functions limited See Owner's Manual..... 840
 Stop vehicle See Owner's Manual..... 853	 Trailer left turn signal..... 792	Active Distance Assist available again..... 839
 suspended..... 838	 Trailer right turn signal..... 792	Active Distance Assist currently unavailable See Owner's Manual..... 838
 Switch off lights..... 784	 Trailer tail light..... 792	Active Distance Assist inoperative..... 838
	 Tyre(s) overheated..... 857	
	 Vehicle rising Please wait..... 837	
	 Warning tyre malfunction..... 856	

- Active Emergency Stop Assist currently unavailable See Owner's Manual... 841
- Active Emergency Stop Assist inoperative..... 842
- Active Lane Change Assist currently unavailable See Owner's Manual..... 842
- Active Lane Change Assist inoperative... 843
- Active Lane Keeping Assist currently unavailable See Owner's Manual..... 845
- Active Lane Keeping Assist functions restricted See Owner's Manual..... 846
- Active Lane Keeping Assist inoperative... 845
- Active Parking Assist and PARKTRONIC inoperative See Owner's Manual..... 851
- Active Steering Assist currently unavailable due to multiple emergency stops..... 841
- Active Steering Assist currently unavailable See Owner's Manual..... 840
- Active Steering Assist inoperative..... 840
- Active Stop-and-Go Assist currently unavailable see Owner's Manual..... 843
- Active Stop-and-Go Assist inoperative See Owner's Manual..... 843
- Adaptive Highbeam Assist currently unavailable See Owner's Manual..... 784
- Adaptive Highbeam Assist inoperative.... 785
- Adaptive Highbeam Assist Plus currently unavailable See Owner's Manual... 785
- Adaptive Highbeam Assist Plus inoperative..... 785
- Ambient light warning support inoperative..... 814
- AMG Ride Control Function limited See Owner's Manual..... 834
- Apply brake and start vehicle to shift out of P or N..... 817
- Apply brake to deselect P position..... 817
- Apply brake to engage D or R..... 817
- Apply brake to engage R..... 817
- Apply parking brake to park Visit workshop..... 817
- ATTENTION ASSIST Remain alert! (white display message)..... 830
- ATTENTION ASSIST Remain alert! (yellow display message)..... 830
- Auxiliary battery malfunction (white display message)..... 820
- Blind Spot Assist currently unavailable See Owner's Manual..... 844
- Blind Spot Assist inoperative..... 844
- Blind Spot Assist unavailable when towing a trailer See Owner's Manual..... 844
- Cannot start vehicle See Owner's Manual..... 795, 803
- Change steering wheel/ seat position until 6 dots are visible on the upper edge of the screen..... 850

Charging fault Please change charging method See Owner's Manual.....	798	Driver camera inoperative See Owner's Manual.....	850	High-voltage battery malfunction. No start in approx. XXX km Consult workshop (yellow display message).....	805
Check brake pads See Owner's Manual.....	825	Front passenger airbag disabled See Owner's Manual.....	775	Inoperative indicator lamp in driver display. Consult workshop.....	793
Check low beam setting (left/right-side traffic).....	784	Front passenger airbag enabled See Owner's Manual.....	776	Limited availability of Active Parking Assist manoeuvring assistant See Owner's Manual.....	852
Consult workshop without changing the transmission position.....	820	Hazard warning lamp system Malfunction.....	786	Limiter inoperative.....	832
Consult workshop without starting the vehicle again.....	802	Head-up display Brightness currently reduced See Owner's Manual.....	810	Low beam setting (left/right-side traffic) Manual adjustment only.....	784
Cruise control and Limiter inoperative....	831	Head-up display currently unavailable See Owner's Manual.....	810	N automatically activated Please engage transmission position again.....	819
Cruise control inoperative.....	831	Head-up display inoperative.....	810	N is selected Please select desired transmission position.....	819
Cruise control off.....	831	High-voltage battery malfunction. Consult workshop without starting the vehicle again.....	806	Not possible to unlock charging cable See Owner's Manual.....	798
DC charging inoperative Consult workshop.....	799	High-voltage battery malfunction. No start in approx. XXX km Consult workshop (red display message).....	806	Only select P when vehicle is stationary.....	816
DIGITAL LIGHT Functions limited.....	784				
Drive malfunction Achievable speed limited Stop soon.....	803				
Drive malfunction Achievable speed severely limited See Owner's Manual.....	803				

PARKTRONIC and manoeuvring assistant unavailable at rear when towing a trailer.....	851	PRE-SAFE PLUS inoperative See Owner's Manual.....	850	Snow chain mode Maximum speed exceeded.....	814
PARKTRONIC inoperative See Owner's Manual.....	851	Preparing drive system.....	800	Socket flap blocked Please open manually.....	797
Place the key in the marked space See Owner's Manual.....	779	RACE START cancelled.....	837	Speed limit (winter tyres) XXX km/h.....	832
Please charge the high-voltage battery. Otherwise the vehicle may not start.....	800	RACE START not possible See Owner's Manual.....	837	Speed Limit Assist currently unavailable See Owner's Manual.....	832
Please close socket flap manually. Anti-entrapment active.....	797	Reduced drive system performance See Owner's Manual.....	799	Speed Limit Assist inoperative.....	832
Please close socket flap manually. Automatic function inoperative.....	797	Restricted mode activated Output reduced.....	829	The camera's view of the driver is currently impeded Affected functions: see Owner's Manual.....	849
Please wait in READY status Warming battery See Owner's Manual.....	800	Reversing not poss. Consult workshop...	819	To switch off the vehicle, press the Start/Stop button for at least 3 seconds or 3 times.....	795
PRE-SAFE impulse side inoperative See Owner's Manual.....	850	Risk of vehicle rolling away Apply parking brake to park.....	818	Traffic Sign Assist currently unavailable See Owner's Manual.....	833
PRE-SAFE inoperative See Owner's Manual.....	850	Risk of vehicle rolling away Driver's door open Transmission not in P.....	818	Traffic Sign Assist inoperative.....	833
		Risk of vehicle rolling away N activated manually No automatic switch to P...	818	Transmission Malfunction Stop.....	819
		Searching for key in stowage tray or Digital Vehicle Key in inductive charging bracket... See Owner's Manual.....	779	Tyre press. monitor currently unavailable.....	854

- Tyre press. monitor inoperative..... 855
- Tyre pressure monitor inoperative No tyre pressure sensors..... 855
- Vehicle is ready to drive Shutdown occurs when locked or automatically in a few minutes..... 807
- Vehicle not currently being charged Charging station fault..... 798
- Wiper Malfunction..... 816
- Displaying road names/house numbers..... 512**
- Distance control..... 321**
- Distance warning..... 336**
- DISTRONIC..... 321**
- Door, Convenience doors**
- Additional door lock..... 143
 - Child safety lock (rear door)..... 130
 - Emergency key..... 153
 - Extend/retract door handles..... 145
 - Opening (from the inside)..... 144
 - Opening/closing comfort doors..... 148
 - Setting convenience doors..... 152
 - Unlocking (inside)..... 144
- Door control panel**
- Seat operation..... 68
- Door handles**
- Extending/retracting..... 145
- Drag Race, Drag race..... 470**
- Drinks holder..... 201**
- Drive Away Assist..... 386**
- Drive position..... 275**
- Drive program display..... 268, 269**
- Drive programs**
- AMG DYNAMIC SELECT..... 271
 - Selecting..... 268, 269
- Drive system**
- Manual switch-off..... 250
 - Starting (emergency operation mode).... 256
- Driver camera**
- Activating/deactivating..... 458
 - Function..... 456
- Driver display**
- Track Pace menu..... 411
- Driver's display, Instrument cluster**
- Assistant display..... 409
- Classic menu..... 407
- Head-up display..... 414
- Menus..... 404
- Navigation menu..... 412
- Notes..... 402
- Operating..... 403
- Service due date..... 594
- Service menu..... 409
- Sport menu..... 412
- Status displays..... 416
- Supersport menu..... 410
- Understated menu..... 407
- Warning/indicator lamps..... 62, 64, 858
- Driver's seat**
- Adjusting (Seat Comfort)..... 172
 - Adjusting electrically..... 174
 - Easy entry and exit feature..... 186
 - Seat heating..... 182
- Driving abroad**
- Light adjustment low beam..... 27, 212
- Driving safety system**
- ABS (Anti-lock Braking System)..... 306
 - Active Brake Assist..... 336
 - Active Lane Change Assist..... 334
 - Active Steering Assist..... 330

- Adaptive brake lights..... 314
ATTENTION ASSIST..... 315
BAS (Brake Assist System)..... 306
Blind Spot Assist/Active Blind Spot Assist..... 350
Cameras..... 304
Cruise control..... 317
EBD (Electronic Brakeforce Distribution)..... 312
ESP® (Electronic Stability Program)..... 307, 308
Hill Start Assist..... 313
HOLD function..... 312
Overview..... 305
Radar and ultrasonic sensors..... 304
Speed Limit Assist..... 342
STEER CONTROL..... 312
Traffic Sign Assist..... 345
Your responsibility..... 303
- Driving system**
AMG RIDE CONTROL +..... 359
- Driving tips**
Acoustic presence indicator (sound generator)..... 250
AMG DYNAMIC PLUS package..... 306
- Electric mode..... 250
General driving tips..... 257
Light adjustment when driving abroad..... 27, 212
Rear axle steering..... 259
Recuperation..... 260
Running-in notes..... 257
- Drowsiness detection**..... 315
- Duplicate key**..... 138
- Dynamic handling control system**..... 307
- Dynamic low beam**
Overview..... 215
- DYNAMIC SELECT**
Calling up the fuel consumption indicator..... 270
Configuring drive program I..... 269, 270
Displaying vehicle data..... 270
Drive program display..... 268, 269
Drive programs..... 266, 267
Function..... 266, 267
Selecting the drive program..... 268, 269
- E**
- E-mails**..... 423
- Easy entry feature**
Setting..... 188
- Easy exit feature**
Setting..... 188
- EBD, Electronic Brakeforce Distribution**..... 312
- ECO Assist**
Function..... 261
- ECO display**..... 260
- Electric Intelligence**
Route with charging stations..... 487
- Electric mode, Notes**..... 250
- Electric parking brake**
Applying automatically..... 299
Emergency braking..... 302
Manually applying/releasing..... 300
Releasing automatically..... 300
- Electrical fuses**..... 48, 624
- Electromagnetic compatibility**
Declaration of conformity..... 78
- Electronic Stability Program**..... 307, 308
- Emergency**
Emergency guide..... 56

- Fire extinguisher..... 46, 609
- First-aid kit (soft sided)..... 29, 47, 609
- Overview of aids..... 70
- Safety vest..... 28, 46, 608
- Warning triangle..... 609
- Emergency braking**
 - Active Brake Assist..... 336
 - Brake Assist System..... 306
 - Carrying out..... 302
 - Electric parking brake/handbrake..... 299
- Emergency call**
 - Automatic..... 556
 - Manual..... 556
- Emergency call system**
 - Mercedes me connect..... 55, 555
- Emergency key**
 - Door..... 153
 - Inserting/removing..... 136
- Emergency operation mode**
 - Starting the vehicle..... 256
- Emergency shutoff (high-voltage on-board electrical system)..... 250**
- Emergency start (drive system)..... 624**
- Emergency stop assistant..... 332**
- ENERGIZING Coach**
 - Calling up..... 476
 - Function..... 475
- ENERGIZING COMFORT**
 - Overview of programmes..... 473
 - Starting the programme..... 474
- Energy flow display**
 - Function/notes..... 472
- Engine**
 - Engine number..... 757
 - Starting (Digital Vehicle Key)..... 255
 - switching off (start/stop button)..... 297
- Engine electronics..... 644**
- Engine number..... 757**
- Engine starting**
 - Start/stop button..... 253
- Entering characters**
 - Function/notes..... 454
 - Handwriting recognition..... 456
 - On the touchscreen..... 454
 - Selecting the writing speed..... 456
 - Setting the keyboard language..... 456
- Environmentally friendly driving..... 73**
- ERA-GLONASS test mode..... 559**
- ESC, Electronic Stability Control..... 307**
- ESP®**
 - Activating/deactivating..... 310, 311
 - Adjusting (steering-wheel button)..... 310
 - Crosswind Assist..... 310
 - ESP® SPORT..... 308
 - Function..... 307, 308
 - Trailer stabilisation..... 310
- EU type approval number..... 757**
- Exit warning**
 - Blind Spot Assist/Active Blind Spot Assist..... 350
- Exiting a parking space**
 - Active Parking Assist..... 375
 - Drive Away Assist..... 386
 - PARKTRONIC..... 371
- Exterior lighting**
 - Care..... 604
 - Light adjustment when driving abroad..... 27, 212

Fuses

Cockpit.....	625
Front passenger footwell.....	625
Fuse assignment diagram.....	48, 624
Notes.....	48, 624
Rear.....	626

G

G-meter (driver's display, Sport menu).....	412
Gallery app	
Operating.....	552
General driving tips.....	257
Genuine parts.....	73
Global search	
Function.....	448
Overview.....	448
Glove compartment	
Opening/closing.....	39, 194
GPS-based vehicle level	
AIRMATIC.....	359
Setting.....	359
Grab handles.....	171
Gross mass.....	757

H

Handbrake.....	299
Handling characteristics	
Unusual.....	627
HANDS-FREE ACCESS.....	158
Hands-free system.....	523
Handwriting recognition.....	456
Haptic accelerator pedal, Pressure point.....	264
Hazard warning lights.....	45, 215
Hazard warnings	
Car-to-X-Communication.....	510
Head restraint	
Adjusting (rear).....	178
Adjusting manually (front).....	177
Removing/fitting (rear).....	179
Head-up display	
Care.....	605
Function.....	414
Memory function.....	189
Operating.....	415
Switching on/off.....	416
Headlamp flashing.....	214

Headlamp range control.....	217
Headlamps.....	212
Heating	
Activating/deactivating.....	236
Centre console.....	235
Climate control.....	233, 234
Rear window.....	234
Seat.....	182
Steering wheel.....	186
Windscreen.....	243
Help call	
Mercedes-Benz emergency call system.....	55, 555
High beam.....	214
High-pressure cleaner.....	601
High-voltage battery	
Charge level display.....	295
Charging at time of departure.....	296
Charging cable control panel.....	283
Charging duration.....	763
Charging station, mode 3.....	281
Configuring weekly profile.....	296
Connection types.....	763
Disconnect device.....	250

Ending the charging process (alternating current, mode 2/3).....	288	Indicator lamps on vehicle socket.....	284	Calling up.....	536
Ending the charging process (direct current, mode 4).....	293	Manual switch-off.....	250	Creating an e-mail.....	537, 538
Energy flow display.....	472	Hill Start Assist	313	Forwarding e-mail.....	538
General notes on charging.....	276	HOLD function		Managing e-mails.....	537
Mains socket, mode 2.....	280	Function.....	312	Marking a task as completed.....	537
Maximum charging current (mains socket).....	282	Switching on/off.....	312	Selecting functions (calendar entry).....	536
Notes.....	617	Home screen		Selecting functions (Tasks & Calls).....	537
Range.....	763	Central display.....	437		
Range maximisation.....	264			Incorrect behaviour by vehicle occupants	
Rapid charging station, mode 4.....	282			Limited protection.....	103
Recuperation.....	260			Increase in traffic information volume	
Starting the charging process (alternating current, mode 2/3).....	285			Setting.....	581
Starting the charging process (direct current, mode 4).....	290			Indicator lamps/warning lamps	
Stowing the charging cable.....	278			Driver's display.....	858
Type.....	763			PASSENGER AIR BAG.....	96
Voltage types.....	763	i-Size child restraint system		Individual drive program	
Wallbox, mode 3.....	281	Fitting.....	127	Configuring.....	269, 270
High-voltage on-board electrical system		Suitable seats.....	122	Inside rearview mirror	230
Charging cable control panel.....	283	Identification plate		Intelligent Light System	
Disconnect device.....	250	Engine.....	757	Activating/deactivating.....	220
		Vehicle.....	757	Interior lighting	
		Immediate pre-entry climate control	247	Ambient lighting.....	224
		Immobiliser	168	Setting.....	224
		Implied warranty	87	Switch-off delay time.....	226
		Importer information			
		Regulatory radio information.....	756		
		In-Car Office			
		Answering e-mail.....	538		

- Interior protection**..... 170
- Intermediate destination**
 Editing..... 497
 Starting the automatic service station search..... 499
- Internet**
 Calling up a web page..... 565
 Calling up the web browser settings..... 566
 Calling up web browser options..... 566
 Deleting a bookmark..... 567
 Deleting browser data..... 566
 Managing bookmarks..... 567
 Mercedes me connect..... 549
 Setting up a Wi-Fi hotspot..... 461
 Smartphone integration..... 20
 Web browser in the background..... 567
 Web browsers..... 566
- Internet connection**
 Cancelling permission (mobile phone).... 564
 Disconnecting automatically (communication module)..... 562
 Displaying the connection status..... 565
 Establishing..... 564
 Information..... 561
 Overview of connection status..... 564
- Restrictions..... 561
 Setting access data (Bluetooth®)..... 563
 Setting up (communication module)..... 562
 Setting up (Wi-Fi)..... 563
 Setup (Bluetooth®)..... 563
- Ionisation**..... 241
- iPhone®**
 Smartphone integration..... 539
- ISOFIX child restraint system**
 Fitting..... 127
 Suitable seats..... 120
- J**
- Jack**
 Declaration of conformity..... 81
 Storage location..... 49, 635
- Jump-start connection**..... 48, 617
- K**
- Key**
 acoustic locking verification signal..... 135
 Battery..... 136
 Deactivating a function..... 55, 135
- Emergency key..... 136
 Energy consumption..... 55, 135
 Function..... 134
 Key ring attachment..... 136
 Problem..... 138
 Replacement key..... 138
 Unlocking setting..... 135
- KEYLESS-GO**
 Deactivating..... 55, 135
 Locking/unlocking the vehicle..... 145
 Problem..... 147
 Unlocking setting..... 135
- Knee airbag**..... 107
- L**
- Lane Change Assistant**..... 334
Lane Keeping Assist..... 354
Lane recognition
 Active Lane Change Assist..... 334
 Active Lane Keeping Assist..... 354
- Language**
 Notes..... 462
 Setting..... 462

Last destinations

Selecting..... 480

Level control

AIRMATIC..... 357

AMG RIDE CONTROL +..... 359

Light adjustment

Driving abroad..... 27, 212

Light switch..... 212

Lighting

Dynamic low beam..... 215

Interior lighting..... 224

Lights

Active headlamps..... 216

Adaptive brake lights..... 314

Adaptive Highbeam Assist..... 220

Adaptive Highbeam Assist Plus..... 222

Assistance functions..... 217

Automatic driving lights..... 213

Bad weather light..... 217

City lighting..... 217

Combination switch..... 214

Cornering light..... 216

DIGITAL LIGHT..... 215

Dynamic low beam..... 215

Fog light (extended range)..... 217

Hazard warning lights..... 45, 215

High beam..... 214

Interior lighting..... 224

Light adjustment when driving abroad

..... 27, 212

Locator lighting..... 224

Motorway mode..... 216

Reading lamp..... 224

Rear fog light..... 213

Responsibility for lighting systems..... 212

Setting low beam..... 223

Switch-off delay time..... 224

Switching the Intelligent Light System

on/off..... 220

Topographical compensation..... 217

Turn signal light..... 214

Limiter

Activating/deactivating..... 319, 324

Buttons..... 319

Calling up a speed..... 319

Function..... 318

Passive mode..... 318

Permanent setting..... 321

Requirements:..... 319

Selecting..... 319

Setting a speed..... 319

Storing a speed..... 319

Live Traffic Information

Displaying the traffic map..... 507

Displaying traffic incidents..... 508

Extending a subscription..... 507

Information of the service provider..... 507

Registering on Mercedes me..... 507

Load capacity

Bicycle rack..... 768

Loading, Stowage compartments

Roof luggage rack..... 31, 200

Stowage space under the boot floor

..... 36, 200

Tie-down eyes..... 38, 199

Loading guidelines..... 190

Loads..... 190

Locator lighting..... 224

Locking/unlocking

Additional door lock..... 143

Automatic locking (MMS)..... 147

Digital Vehicle Key..... 142

Doors (from the inside)..... 144

- Emergency key..... 153
 KEYLESS-GO..... 145
 Mercedes me connect..... 143
- Loud sound**
 PRE-SAFE® Sound..... 99
- Low beam**
 Activating/deactivating..... 212
 Left-hand/right-hand traffic..... 223
 Light adjustment when driving abroad
 27, 212
 Setting..... 223
- lubricants**..... 759
- Luggage**..... 190
- Lumbar support**..... 176
- M**
- Maintaining safe distance**
 Active Distance Assist DISTRONIC..... 324
- Maintenance**..... 594
- Maintenance Management**
 Notes..... 595
 Transferred data..... 595
- Malfunction**
 Restraint system..... 94
- Manoeuvring brake function**..... 388
- Manoeuvring**
 Drive Away Assist..... 386
 Manoeuvring brake function..... 388
- Manoeuvring assistant**
 Activating/deactivating..... 389
 Cross traffic warning..... 387
 Drive Away Assist..... 386
 Manoeuvring brake function..... 388
- Map, Traffic map**
 Avoiding an area..... 514
 Avoiding an area (overview)..... 514
 Changing an area..... 514
 Charging stations..... 488
 Deleting an area..... 515
 Displaying online map contents..... 517
 Displaying Qibla..... 516
 Displaying the compass..... 516
 Displaying the map version..... 513
 Displaying the range..... 517
 Displaying the satellite map..... 517
 Displaying the traffic map..... 507
- Displaying weather information..... 517
 Map data..... 515
 Moving..... 512
 Route overview after start..... 512
 Selecting additional information..... 513
 Selecting POI symbols..... 512
 Setting the map scale..... 512
 Setting the map scale automatically..... 516
 Updating..... 29, 515
- Map functions**..... 512
- Massage programmes**..... 181
- Maximum full-stop braking**..... 306
- Maximum permissible gross vehicle mass**..... 757
- Maximum speeds**..... 762, 763
- MBUX**
 Dashcam..... 521
- MBUX Interior Assistant**
 Camera & parking..... 456
 Driver camera..... 456
- MBUX multimedia system**
 Adjusting the volume..... 453
 Air conditioning menu..... 237
 Authorisations..... 460

- Calling up the zero layer..... 434
- Display settings..... 458
- Drive programs..... 269, 270
- ENERGIZING COMFORT programmes (overview)..... 473
- ENERGIZING seat kinetics..... 472
- Factory setting..... 467
- Fingerprint sensor..... 439
- Global search..... 448
- Home screen..... 437
- Language settings..... 419
- Memory Park Assist..... 393
- Mercedes me & Apps..... 22, 551
- Operating the zero layer..... 434
- Overview..... 428
- Overview (Mercedes-AMG vehicles)..... 426
- Set collision detection..... 302, 303
- Setting keyboard and handwriting recognition..... 456
- Setting route-based speed adaptation.... 329
- Snow chain mode..... 628
- Starting the ENERGIZING COMFORT programme..... 474
- Steering wheel heater/seat heating..... 186
- Switching the sound on/off..... 451
- Touchscreen..... 438
- Zero layer..... 431
- MBUX Voice Assistant**
 - E-mails..... 423
 - Function..... 419
 - Language setting..... 420
 - Media voice commands..... 423
 - Online voice commands..... 424
 - Online voice control..... 422
 - Operable functions..... 420
 - Operating safety..... 419
 - Setting..... 420
 - Speech quality..... 421
 - Voice commands..... 422
 - Voice prompting..... 419
- Mecca**..... 516
- Media**
 - General information..... 19
- Media mode**
 - Adding a favourite song..... 574
 - Connecting Bluetooth® audio equipment..... 573
 - Connecting USB devices..... 572
 - Controlling media playback..... 574
 - Copyright and trademarks..... 570
- Information..... 575
- Information about the search function in categories..... 574
- Overview of the media menu..... 572
- Playing back similar music tracks..... 574
- Removing a favourite song..... 574
- Starting a search in categories..... 574
- Starting and operating playback..... 575
- Starting media playback..... 573
- Supported formats and data storage media..... 569
- Surprise mix..... 574
- Using the keyword search..... 574
- Medical aids**..... 86
- Memory function**
 - Head-up display..... 189
 - Outside mirrors..... 189
 - Seat..... 189
 - Steering wheel..... 189
- Memory Parking Assist**
 - Exiting a parking space..... 392
 - Function..... 389
 - Parking..... 391
 - Recording..... 390
 - Setting..... 393

- Menus (driver display)**
 - Track Pace..... 411
- Menus (driver's display), Steering-wheel buttons**
 - Assistant display..... 409
 - Classic menu..... 407
 - Navigation..... 412
 - Notes..... 404
 - Operating..... 405
 - Service..... 409
 - Sport..... 412
 - Supersport..... 410
 - Understated menu..... 407
- Mercedes me App**
 - Activating on-demand features..... 75
 - Calling up services..... 551
 - Calling up your user account..... 551
 - Unlinking the user account..... 551
- Mercedes me Apps**..... 22, 551
- Mercedes me calls**
 - Arranging a service appointment..... 547
 - Calling the Mercedes-Benz Customer Centre after automatic accident/breakdown detection..... 546
 - Calls via the overhead control panel..... 544
 - Consenting to the transfer of data..... 547
 - Information..... 545
 - Mercedes-Benz Customer Centre..... 545
 - Transferred data..... 547
- Mercedes me Charge, Paying**
 - Charging station display..... 489
- Mercedes me connect**
 - Accident/Breakdown Management..... 550
 - Information..... 549
 - Transferred data..... 550
- Mercedes-Benz emergency call system**
 - Automatic emergency call..... 556
 - Data processing..... 559
 - Data transfer..... 557
 - ERA-GLONASS test mode..... 559
 - Information..... 553
 - Manual emergency call..... 556
 - Overview..... 55, 555
 - Self-diagnosis..... 559
- Mercedes-Benz GenuineParts**..... 73
- Mercedes-Benz service centre**..... 85
- Message memory**..... 770
- Messages, Short messages**
 - Calling a message sender..... 535
 - Deleting..... 535
 - Dictating..... 534
 - Forwarding..... 535
 - MBUX voice commands..... 423
 - Overview..... 534
 - Read-aloud function..... 534
 - Reading..... 534
 - Replying..... 535
 - Sending..... 534
 - Setting the displayed text messages..... 534
 - Using a phone number or URL..... 535
- Mirror heater**..... 244
- Mirrors**
 - Mirror folding function..... 231
 - Outside mirrors..... 229
 - Rear-view mirror..... 230
- Mobile phone**
 - Authorising, Remote Parking Assist..... 385
 - Cancelling permission for Internet connection..... 564
 - Frequencies..... 645
 - Maximum transmission output..... 645
 - Notes on wireless charging..... 207

- | | | | | | |
|--|-----|--|---------|---|-----|
| Smartphone integration..... | 20 | Information..... | 17 | Neutral | 273 |
| Telephone..... | 20 | MBUX voice commands..... | 422 | NFC | 460 |
| Wireless charging (front)..... | 208 | Menu (driver display)..... | 412 | Nodding off | 315 |
| Wireless charging (rear passenger
compartment)..... | 209 | Overview..... | 477 | Notifications Centre | |
| Model type | 757 | Route with charging stations..... | 487 | Calling up a notification..... | 447 |
| Modification | | Updating the map data..... | 29, 515 | Editing a notification..... | 447 |
| Limited protection..... | 103 | Navigation announcements | | Message types..... | 446 |
| MOExtended tyres, Run-flat tyres | 610 | Activating/deactivating..... | 504 | Overview..... | 446 |
| Motorway mode | 216 | Adjusting the volume..... | 505 | Selecting actions..... | 447 |
| Multimedia system | 428 | Repeating..... | 505 | | |
| Music online | | Switching audio fadeout on/off..... | 505 | O | |
| Adding providers..... | 576 | Near Field Communication (NFC) | | Objects in the vehicle interior | |
| Calling up..... | 576 | Connecting a mobile phone to the | | Limited protection..... | 103 |
| Calling up the settings..... | 577 | MBUX multimedia system..... | 527 | Occupant presence reminder | |
| Requirements:..... | 576 | Information..... | 460 | Activating/deactivating..... | 133 |
| Search function..... | 577 | Switching mobile phones..... | 527 | Function..... | 133 |
| | | Using a mobile phone..... | 527 | Occupant safety | |
| | | Near-field communication | | Airbag..... | 107 |
| | | Activating/deactivating..... | 460 | Basic information..... | 91 |
| | | Near-field communication (NFC) | | Child seat..... | 110 |
| | | Starting the vehicle (Digital Vehicle | | Information on the child restraint sys- | |
| | | Key)..... | 255 | tem..... | 98 |
| | | Unlocking/locking the vehicle (digital | | Information on the correct seat position... | 92 |
| | | vehicle key)..... | 142 | Occupant presence reminder..... | 133 |

Parking space			
Finding.....	518		
PARKTRONIC	371		
PASSENGER AIR BAG			
Status display, front passenger airbag.....	96		
Pedestrian protection	596		
Permissible axle load	757		
Permitted towing methods			
Overview.....	618		
Pets in the vehicle	103		
Photos			
Gallery app.....	552		
PIN protection			
System PIN protection.....	463		
POI			
Selecting.....	480		
POI symbols			
Selecting.....	512		
Post-collision brake	101		
Power (driver's display, Sport menu)	412		
Power closing function			
Boot lid.....	155		
Power display			
Function/notes.....	416		
Power supply			
Start/stop button.....	252		
Switching on (start/stop button).....	252		
Pre-entry climate control			
activating/deactivating for departure			
time.....	246		
At departure time.....	246		
At time of departure.....	245		
immediate.....	247		
When vehicle is unlocked.....	244		
Pre-heating	244		
PRE-SAFE® , Anticipatory occupant protection			
Function.....	99		
PRE-SAFE® Sound.....	99		
Reversing measures.....	100		
PRE-SAFE® Impulse Side			
Function.....	100		
Inflating.....	102		
PRE-SAFE® PLUS			
Function.....	100		
Reversing measures.....	100		
Preventative occupant protection system			
.....	99, 100		
Program	266, 267		
Programme information			
TV channel.....	584		
Protection			
Limited.....	103		
Protection against collision			
Drive Away Assist.....	386		
Manoeuvring brake function.....	388		
Protection of the environment			
Driving style.....	73		
Take-back of end-of-life vehicles.....	73		
Pulling away			
Drive Away Assist.....	386		
Hill Start Assist.....	313		
Q			
Qibla	516		
QR code rescue card	48, 87		
Qualified specialist workshop	85		

R	
RACE START	
Activating.....	362
Activation conditions.....	362
Information.....	362
With boost function.....	362
Racetrack mode	
AMG steering-wheel buttons.....	265
Radar and ultrasonic sensors.....	304
Radio	
Activating.....	577
Activating/deactivating radio text.....	581
Calling up a slide show.....	580
Calling up the station list.....	578
Deleting stations.....	579
Displaying radio text.....	581
Editing station presets.....	579
Entering a frequency directly.....	31, 579
Frequency fix.....	580
Managing favourites.....	579
MBUX voice commands.....	423
Menu.....	19
Moving stations.....	579
Overview.....	578
Searching for a channel.....	31, 579
Setting a channel.....	578
Setting station tracking.....	580
Setting station tracking (Internet Radio).....	579
Setting the frequency band.....	578
Setting the traffic information service volume increase.....	581
Showing/hiding lyrics.....	581
Station suggestion.....	579
Storing radio stations.....	579
Switching a slide show off/on.....	580
Radio (audio system)	
Switching traffic announcements on/off.....	54, 580
Radio announcements	
Activating or deactivating.....	580
Selecting.....	580
Radio regulations	
Importer information.....	756
Regulatory radio identification.....	649
Specific absorption rate.....	754
Wireless applications.....	646

Rain closing function	
Side windows.....	162
Sliding sunroof.....	166
Rain sensor	
Side windows.....	162
Sliding sunroof.....	166
Windscreen wipers.....	226
Range	
Notes.....	402
Range maximisation, ERM (Extended Range Mode)	
Activating/deactivating.....	264
Function.....	264
Range monitor	
Activating/deactivating.....	488
Range on Map	
On map.....	491
REACH regulation.....	86
Reading lamp	
Interior lighting.....	224
Rear axle steering.....	259
Rear compartment climate control.....	240

- Rear door (child safety lock)
 - Securing..... 130
- Rear fog lamp..... 213
- Rear fog light..... 213
- Rear seat belt
 - Status display..... 95
- Rear window heater..... 233, 234
- Rear-view mirror
 - Automatic anti-dazzle mode..... 230
- Rearward-facing child seat
 - Information..... 116
- Recuperation
 - Function..... 260
 - Setting..... 261
- Recuperative braking (driver's display, Sport menu)..... 412
- Recycling..... 73
- Registration..... 85
- Remote Parking Assist
 - Authorising a mobile phone..... 385
 - Function..... 382
 - Operating..... 383
- Replacement key..... 138
- Resetting
 - MBUX reset function..... 467
- Responsibility
 - Driving safety systems..... 303
- Restraint system
 - Basic information..... 91
 - Basic instructions for children..... 110
 - Deployment situations..... 102
 - Functionality..... 94
 - Information on function..... 102
 - Information on the correct seat position... 92
 - Limited protection..... 103
 - Malfunction..... 94
 - Protection..... 92
 - Self-test..... 94
 - Warning lamp..... 94
- Reverse gear..... 273
- Reversing camera
 - 360° Camera..... 364
 - Activate via GPS..... 371
 - Function..... 364
 - Manage activation points..... 371
 - Opening the camera cover..... 371
- Roll away protection..... 312
- Roller sunblind
 - Sliding sunroof..... 164
- Roof luggage rack
 - Loading..... 31, 200
 - Securing..... 31, 200
- Route
 - Accepting a detour recommendation..... 493
 - Adjusting on the map..... 499
 - Alternative route..... 498
 - Calculating alternative routes..... 493
 - Calculating with Electric Intelligence..... 484
 - Charging near destination..... 492
 - Commuter route..... 498
 - Displaying destination information..... 495
 - Displaying the route list..... 497
 - Editing a stored route..... 500
 - Electric Intelligence..... 487
 - Electric Intelligence (overview)..... 486
 - Navigation..... 477
 - Planning..... 497
 - Range on Map service..... 491
 - Recording..... 500
 - Saving a recorded route..... 500
 - Selecting a type..... 492

- Selecting notifications..... 494
- Selecting options..... 493
- Selecting settings for charging stations (navigation with Electric Intelligence)..... 487
- Starting a saved route..... 500
- Starting the automatic service station search..... 499
- Switching the range monitor on/off..... 488
- Route guidance**
 - Cancelling..... 505
 - Changing direction..... 501
 - Destination reached..... 504
 - Lane recommendations..... 503
 - Motorway information..... 503
 - Notes..... 500
 - Off-road..... 505
- Route guidance with augmented reality**
 - Activating..... 511
 - Activating/deactivating the traffic light view..... 350
 - Displaying road names/house numbers..... 512
 - Overview..... 511
- Route-based speed adaptation**
 - Function..... 328
 - Setting..... 329
- Run-flat characteristics**..... 610
- Running-in notes**..... 257
- S**
- Safety system**..... 305
- Safety vest**..... 28, 46, 608
- Satellite map**..... 517
- Saving a destination suggestion as a favourite**..... 506
- Searching for a channel**..... 31, 579
- Seat, Front seat, Rear seat, Through-loading feature**
 - Adjusting (Seat Comfort)..... 172
 - Adjusting electrically..... 174
 - Automatic adjustment..... 180
 - Centre airbag (driver's backrest)..... 107
 - Configuring settings..... 180
 - Correct driver's seat position..... 171
 - ENERGIZING seat kinetics..... 472
 - Folding back the backrest (rear)..... 35, 197
- Folding the backrest forwards (rear)..... 33, 195
- Locking the backrest (rear)..... 198
- Lumbar support..... 176
- Massage programmes..... 181
- Memory function..... 189
- Resetting settings (massage programme)..... 181
- Settings..... 68
- Side airbag..... 107
- Workout programme..... 181
- Seat belt**
 - Activating/deactivating seat belt adjustment..... 101
 - Adjusting the height..... 94
 - Automatic tightening..... 101
 - Care..... 605
 - Fastening..... 94
 - Notes on wearing correctly..... 93
 - Rear seat belt status display..... 95
 - Releasing..... 107
 - Warning lamp..... 95
- Seat belt adjustment**
 - Activating/deactivating..... 101
 - Function..... 101

- Seat belt tensioners**
Inflating..... 102
- Seat belt warning**..... 95
- Seat heating**
Activating/deactivating..... 182
- Seat height**..... 174
- Seat kinetics**
Setting..... 472
- Seat ventilation**..... 183
- Second telephone**
Connecting..... 526
- Selecting the sound profile**
Burmester® 3D-surround sound system..... 590
- Selector lever**..... 272
- Self-test**
Automatic front passenger airbag shut off..... 96
Restraint system..... 94
- Sensors**
Cleaning..... 604
Information..... 304
- Service**
Menu (driver's display)..... 409
- Service centre**..... 85
- Service due date**..... 594
- Service interval display**..... 594
- Service station search**
Starting automatic search..... 499
- Setting the date format**..... 459
- Setting the distance unit**..... 462
- Settings**
Information..... 22
- Shortening the braking distance**
Brake Assist System..... 306
- Shunting support**..... 387
- Side airbag**..... 107
- Side window**
Close with key..... 163
Convenience closing..... 163
Convenience opening..... 162
Opening with the key..... 162
- Side windows**
Automatic function..... 162
- Child safety lock (rear)..... 132
Opening/closing..... 160
Problem..... 163
Rain closing function..... 162
- Skid chains**..... 41, 627
- Sliding roof**
Close with key..... 163
Opening with the key..... 162
- Sliding sunroof, Panorama sliding sunroof**
Automatic functions..... 166
Opening/closing..... 164
Problem..... 167
Rain closing function..... 166
- Smart Card**
Inserting..... 587
- Smartphone integration**
Apple CarPlay®/Android Auto..... 20
- Snow chain mode**..... 628
- Snow chains**..... 41, 627
- Socket**
12 V (front passenger footwell)..... 205
Trailer operation..... 396
- Socket flap**..... 276

- SOS button..... 544
- Sound
 - PRE-SAFE® Sound..... 99
 - Wheels/tyres..... 627
- Sound Experience
 - Calling up Sound Experience..... 592, 593
 - Information..... 592, 593
- Sound generator..... 250
- Sound settings
 - Adjusting treble, mid-range and bass settings..... 589
 - Automatic loudness normalisation..... 589
 - Calling up the sound menu..... 589
 - Setting the balance and fader..... 589
- Spare parts..... 73
- Spare wheel, Emergency spare wheel..... 642
- Specialist workshop..... 85
- Specific absorption rate (SAR)..... 754
- Speed
 - Limit, Limiter..... 318
 - Save, cruise control..... 324
 - Save, DISTRONIC..... 324
 - Save, Limiter..... 324
- Speed adjustment, route-based..... 328
- Speed control
 - Active Distance Assist DISTRONIC..... 321
 - Cruise control..... 317
 - Limiter..... 318
- Speed limit
 - Winter tyres..... 41, 321
- Speed Limit Assist
 - Setting..... 344
 - System limits..... 342
- Standing lights..... 212
- Start-off assist
 - Drive Away Assist..... 386
 - Hill Start Assist..... 313
- Start/stop button
 - Parking the vehicle..... 297
 - Starting the vehicle..... 253
 - Switching on the power supply / vehicle..... 252
- Starting assistance..... 48, 617
- Starting the engine
 - Start/stop button..... 253
- Starting-off aid
 - Drive Away Assist..... 386
 - Hill Start Assist..... 313
- Station
 - Deleting..... 579
 - Entering a frequency directly..... 31, 579
 - Frequency fix..... 580
 - Managing favourites..... 579
 - Moving..... 579
 - Setting..... 578
 - Storing..... 579
- Station list
 - Calling up..... 578
- Station presets
 - Editing..... 579
- Station suggestion
 - Radio..... 579
- Station tracking
 - Setting..... 580
 - Setting (Internet Radio)..... 579
- Status display
 - Front passenger airbag..... 96
 - Rear seat belt..... 95

- Steer Assist**
 Active Steering Assist..... 330
 STEER CONTROL..... 312
- STEER CONTROL**..... 312
- Steering**
 Rear axle steering..... 259
- Steering wheel**
 Adjusting electrically..... 185
 Driver's airbag..... 107
 Manually adjusting..... 184
 Memory function..... 189
- Steering wheel adjustment**..... 185
- Steering wheel heater**
 Decoupling from the seat heating..... 186
- Stopping**
 Parking the vehicle..... 297
- Stowage areas**..... 38, 192
- Stowage space**
 Centre console (front)..... 193
 Front armrest..... 194
- Stowage space under the boot floor**..... 36, 200
- Stowage spaces**
 Armrest..... 38, 192
 Centre console (front)..... 38, 192
 Door..... 38, 192
 Glove compartment..... 38, 192
- Streaming online music**..... 576
- Suggestions**
 Configuring..... 463
 Deleting..... 464
- Supersport menu display content**
 Selecting..... 410
- Suspension**
 AIRMATIC..... 357
 AMG RIDE CONTROL +..... 359
 Selecting the suspension setting..... 360
 Setting the suspension level (AIR-
 MATIC)..... 358
 Setting the vehicle level..... 361
- Suspension level**
 Setting..... 361
- SVHC**
 Substances of very high concern..... 86
- Switch-off delay time**
 Exterior..... 224
 Interior..... 226
- Switching air-recirculation mode on/off**..... 241
- Switching loudness normalisation on/off**
 Advanced sound system..... 591
 Burmester® 3D-surround sound sys-
 tem..... 590
- System PIN protection**
 Activating/deactivating..... 463
- System settings**
 Activating/deactivating system PIN
 protection..... 463
 MBUX reset function..... 467
 Setting the distance unit..... 462
 Setting the time zone..... 458
 Setting the time/date format..... 459
 Switching near-field communication
 (NFC) on or off..... 460
 Transmission of the vehicle position..... 459
- T**
- Tabs**
 managing..... 567
- Take-back of end-of-life vehicles**..... 73
- Technical data**
 Axle load (trailer operation)..... 769

- Axle load (trailer operation),
(Mercedes-AMG vehicles)..... 769
- Fastening points of the trailer hitch..... 766
- High-voltage battery..... 763
- Information..... 644
- Maximum speeds..... 762, 763
- Mounting dimensions of a trailer hitch.... 766
- Overhang dimension of the trailer hitch.. 766
- Radio frequencies..... 645
- Radio regulations..... 649
- Specific absorption rate (SAR)..... 754
- Tongue weight..... 768
- Tongue weight (Mercedes-AMG vehicles)..... 768
- Towing capacity..... 767
- Trailer load (Mercedes-AMG vehicles).... 767
- Vehicle dimensions..... 761
- Telediagnosis**
 - Diagnostic data..... 595
- Telediagnosics**
 - Transferred data..... 596
- Telemetry display**..... 471
- Telephone, Smartphone**
 - Activating functions during a call..... 530
- Authorising a mobile phone Remote
Parking Assist..... 385
- Calls with several participants..... 530
- Changing a function..... 526
- Connecting a mobile phone..... 11, 525
- Connecting a mobile phone (Near
Field Communication (NFC))..... 527
- Disconnecting a mobile phone..... 527
- Emergency call..... 55, 555
- Importing contacts..... 532
- Importing contacts (overview)..... 532
- Incoming call during an existing call..... 531
- Information..... 15, 525
- Interchanging mobile phones..... 526
- MBUX voice commands..... 423
- Notes..... 523
- Notes on wireless charging (mobile
phone)..... 207
- Operating modes..... 525
- Reception and transmission volume..... 528
- Secure Simple Pairing..... 11, 525
- Setting the ringtone..... 529
- Smartphone integration..... 20
- Switching mobile phones (Near Field
Communication (NFC))..... 527
- Telephone menu overview..... 524
- Telephone operation..... 530
- Using Near Field Communication
(NFC)..... 527
- Voice recognition..... 529
- Wireless charging (mobile phone, rear)... 209
- Wirelessly charging a(mobile phone,
front)..... 208
- Telephone (audio system)**
 - Replacing a mobile phone..... 527
- Telephony operating modes**
 - Bluetooth® telephony..... 525
- Teletext**
 - Displaying..... 587
 - Overview..... 586
- Television, Digital TV**
 - MBUX voice commands..... 423
- Temperature**
 - Setting..... 233, 234
- Text messages**..... 423
- THERMATIC**
 - Air conditioning control panel..... 233
- THERMOTRONIC**
 - Air conditioning control panel..... 234





















- Tie-down eyes**..... 38, 199
- Time**
 Manual time setting..... 459
 Setting the time zone..... 458
 Setting the time/date format..... 459
- TIREFIT kit**, Tyre inflation compressor
 Declaration of conformity..... 82
 Storage location..... 50, 611
- Toll system**
 Windscreen..... 232
- Tone settings**
 Information..... 588
- Tongue weight**..... 768
- Tongue weight (Mercedes-AMG vehicles)**..... 768
- Top Tether**..... 128
- Topographical compensation**, Predictive headlamp range control..... 217
- Touch Control**
 Driver's display..... 403
 MBUX..... 437
 Setting the sensitivity..... 438
- Touch-sensitive controls**..... 74
- Touchscreen**
 Entering characters..... 454
 Switching haptic operation on and off.... 439
- Tow bar system**
 Towing away..... 401
- Tow-away protection**..... 169
- Tow-starting**..... 624
- Towing**
 Pulling/towing..... 401
 Towing methods..... 618
- Towing eye**
 Storage location..... 623
- Towing methods**
 Both axles on the ground..... 50, 619
 Overview..... 618
- Track Pace**
 Menu (driver display)..... 411
- Track Race**..... 468
- Traffic announcements (audio system)**
 Switching on/off..... 54, 580
- Traffic information**
 Car-to-X-Communication..... 509
 Displaying the traffic map..... 507
 Displaying traffic incidents..... 508
 Extending a Live Traffic Information subscription..... 507
 Information about Live Traffic Information..... 507
 Overview..... 506
 Registering Live Traffic Information..... 507
- Traffic Jam Assistant**..... 330
- Traffic light view**
 Activating/deactivating..... 350
 Information..... 350
- Traffic light warning/display**..... 345
- Traffic Sign Assist**
 Function..... 345
 Setting..... 349
- Trailer coupling**..... 36, 394
- Trailer drawbar**, Pulling/towing..... 401
- Trailer hitch**
 Axle load..... 769
 Axle load (Mercedes-AMG vehicles)..... 769
 Bicycle rack..... 399
 Care..... 604
 Coupling up/uncoupling a trailer..... 396
 Fastening points..... 766









- Folding the ball neck out/in..... 36, 394
- General notes..... 766
- Mounting dimensions..... 766
- Overhang dimension..... 766
- Socket..... 396
- Tongue weight..... 768
- Tongue weight (Mercedes-AMG vehicles)..... 768
- Towing capacity..... 767
- Trailer load (Mercedes-AMG vehicles).... 767
- Trailer operation**
- Active Blind Spot Assist..... 353
- Active Lane Keeping Assist..... 354
- Axle load..... 769
- Bicycle rack..... 399
- Coupling up/uncoupling a trailer..... 396
- Folding the ball neck out/in..... 36, 394
- Making settings..... 398
- Notes..... 393
- Socket..... 396
- Trailer stabilisation**..... 310
- Transferred vehicle data**
- Android Auto..... 544
- Apple CarPlay®..... 544
- Transmission**
- DIRECT SELECT lever..... 272
- Drive programs..... 266, 267
- DYNAMIC SELECT button..... 266, 267
- Engages neutral..... 273
- Engaging drive position..... 275
- Engaging reverse gear..... 273
- Selecting park position..... 273
- Transmission position display..... 272
- Transmission positions..... 272
- Transmission position display**..... 272
- Transporting**
- Vehicle..... 621
- Tuneln**
- Deleting stations..... 569
- Logging out..... 569
- Overview..... 568
- Registering..... 569
- Saving stations..... 569
- Selecting and connecting a station..... 568
- Selecting stream..... 569
- Setting options..... 569
- Turn signal indicator**..... 214
- Turn signal light**..... 214
- TV**
- Activating..... 582
- Adjusting the brightness..... 587
- Calling up the menu (CI+ capable CA module)..... 588
- Hiding encrypted TV channels..... 586
- Information..... 581
- MBUX voice commands..... 423
- Overview..... 583
- Picture settings..... 587
- Setting subtitles..... 586
- Setting the audio language..... 586
- Showing teletext..... 587
- Showing/hiding the full screen..... 583
- Teletext overview..... 586
- TV channel**
- Activating/deactivating channel fix..... 585
- Channel fix..... 584
- Channel list overview..... 585
- Country-specific character set..... 585
- EPG (electronic programme guide)..... 584
- Overview of favourites..... 585
- Selecting from the channel list..... 584
- Selecting from the control menu..... 583
- Selecting from the favourites..... 584

- Selecting in the background..... 584
- Storing..... 585
- Two-way radios**
 - Frequencies..... 645
 - Installation..... 644
 - Transmission output..... 645
- Type approval number EG**..... 757
- Tyre pressure**
 - Checking..... 631
 - Notes..... 628
 - TIREFIT kit..... 612
 - Tyre pressure table..... 629
- Tyre pressure monitoring system**
 - Function..... 630
 - Restarting..... 631
- Tyre pressure table**..... 629
- Tyre sealant**..... 612
- Tyre tread**..... 27, 40, 627
- Tyre-change tool**..... 49, 635
- Tyre-change tool kit**..... 49, 635
- Tyres**
 - Breakdown..... 49, 610
 - Checking..... 27, 40, 627
 - Checking the temperature..... 631
 - Fitting..... 640
 - Interchanging..... 635
 - MOExtended..... 610
 - Noise..... 627
 - Notes on fitting..... 632
 - Removing..... 640
 - Removing/fitting hub cap..... 637
 - Removing/fitting wheel trim..... 637
 - Replacing..... 632, 636
 - Selection..... 632
 - Snow chains..... 41, 627
 - Storing..... 635
 - TIREFIT kit..... 612
 - Tyre pressure table..... 629
 - Unusual handling characteristics..... 627
- U**
- Understated menu display content**
 - Selecting..... 407
- Unfastening**..... 107
- Units of measurement**
 - Setting..... 462
- Unlocking setting**
 - Digital Vehicle Key..... 143
- Updating software, System update, Update**
 - Error message..... 466
 - Information..... 464
 - Performing..... 464
- URL**
 - Sharing..... 567
- USB port**
 - Rear..... 206
 - Stowage compartments (front)..... 38, 192
- USB port (multimedia system)**
 - Connecting devices..... 572
- User profiles, Personalisation**
 - Adding a user..... 441
 - Notes..... 440
 - Overview..... 440
 - Requirements for use..... 440
 - Selecting a user..... 444
 - Selecting options..... 442
 - Synchronising..... 444
 - User-specific content..... 440

V

- Valet service mode**
 - Activating/deactivating..... 314
 - Function..... 314
- Variable limiter**..... 318
- Vehicle**, Starting, Switching on the ignition
 - Additional door lock..... 143
 - Correct use..... 85
 - Data storage..... 87
 - Diagnostics connection..... 84
 - Emergency key..... 153
 - Implied warranty..... 87
 - Information..... 21
 - KEYLESS-GO..... 145
 - lock automatically (MMS)..... 147
 - Lock/unlock (emergency key)..... 153
 - Locking/unlocking (from inside)..... 144
 - Lowering..... 641
 - Medical aids..... 86
 - QR code rescue card..... 48, 87
 - Raising..... 637
 - REACH regulation..... 86
 - Registration..... 85
 - Set collision detection..... 302, 303
 - Starting (Digital Vehicle Key)..... 255
 - Starting (emergency operation mode).... 256
 - Starting (start/stop button)..... 253
 - Stopping..... 297
 - SVHC/substances of very high concern... 86
 - Switching off..... 297
 - switching off (start/stop button)..... 297
 - Switching on (start/stop button)..... 252
 - Towing..... 401
 - Towing away..... 618
 - Transporting..... 621
 - unlocking/locking (digital vehicle key).... 142
 - ventilate / comfort opening..... 162
 - Voice commands for MBUX voice assistant..... 424
- Vehicle cameras**..... 304
- Vehicle data**
 - Display, MBUX..... 270
 - Displaying, DYNAMIC SELECT..... 270
 - Maximum speeds..... 762, 763
 - Transferring to Android Auto..... 544
 - Transferring to Apple CarPlay®..... 544
 - Vehicle height..... 761
- Vehicle height (Mercedes-AMG vehicles)..... 762
- Vehicle length..... 761
- Vehicle length (Mercedes-AMG vehicles)..... 762
- Vehicle width..... 761
- Vehicle width (Mercedes-AMG vehicle)... 762
- Weights..... 762
- Wheelbase..... 761
- Wheelbase (Mercedes-AMG vehicles).... 762
- Vehicle dimensions**..... 761
- Vehicle dimensions (Mercedes-AMG vehicles)**..... 762
- Vehicle identification number**..... 757
- Vehicle identification plate**
 - Axle load..... 757
 - EU type approval number..... 757
 - Gross mass..... 757
 - Model type..... 757
 - Paint code..... 757
 - VIN..... 757
- Vehicle key**..... 134
- Vehicle level**
 - AIRMATIC..... 357

- Setting (AIRMATIC)..... 358
- Vehicle location**
- Switching transmission on/off..... 459
- Vehicle position**
- Sharing with a contact..... 516
- Storing..... 505
- Vehicle sensors**..... 304
- Vehicle socket**
- Care..... 604
- Indicator lamps..... 284
- Vehicle start**
- Start/stop button..... 253
- Vehicle tool kit**
- TIREFIT kit..... 50, 611
- Towing eye..... 623
- Ventilation**..... 162, 248
- Vents**
- Air vents..... 248
- Video recordings**
- Gallery app..... 552
- VIN**
- Engine compartment..... 757
- Identification plate..... 757
- Seat..... 757
- Vision**
- Demisting windows..... 240
- Windscreen heater..... 243
- Voice assistant**
- Voice prompting..... 419
- Voice recognition**..... 529
- W**
- Warning system**..... 168
- Warning triangle**..... 29, 47, 609
- Warning/indicator lamp**
-  ABS warning lamp..... 867
-  Active Brake Assist warning lamp..... 872
-  ATTENTION ASSIST warning lamp..... 870
-  Brakes warning lamp (red)..... 866
-  Brakes warning lamp (yellow)..... 865
-  Electric parking brake indicator lamp (red)..... 865
-  Electric parking brake indicator lamp (yellow)..... 865
-  Electrical fault warning lamp..... 862
-  ESP® OFF warning lamp..... 869
-  ESP® warning lamp flashes..... 868
-  ESP® warning lamp lights up..... 868
-  Mercedes-Benz emergency call system warning lamp..... 874
-  Power steering warning lamp (red)..... 863
-  Power steering warning lamp (yellow)..... 863
-  Rear axle steering warning lamp (red)..... 864
-  Rear axle steering warning lamp (yellow)..... 863
-  Reduced-power warning lamp..... 861
-  Restraint system warning lamp..... 860
-  Seat belt warning lamp flashes..... 860
-  Seat belt warning lamp lights up... 861

-  Speed Limit Assist warning lamp..... 871
-  Suspension warning lamp (red).... 873
-  Suspension warning lamp (yellow)..... 872, 873
-  System error warning lamp..... 861
-  Traffic Sign Assist warning lamp... 871
-  Trailer hitch warning lamp..... 862
-  Tyre pressure monitoring system warning lamp flashes..... 874
-  Tyre pressure monitoring system warning lamp lights up..... 875
-  Warning lamp for distance warning..... 871
- Warning/indicator lamps**
- Driver's display..... 858
- PASSENGER AIR BAG..... 96
- Washer fluid**
- Topping up..... 23, 43, 599
- Windscreen washer fluid..... 42, 760
- Washing by hand**..... 602
- Water tank**..... 599
- Wear**
- Limited protection..... 103
- Weather information**..... 517
- Web browser**
- Calls up options..... 566
- Deleting browser data..... 566
- Web browsers**
- Calling up a web page..... 565
- Calling up the settings..... 566
- Deleting a bookmark..... 567
- Managing bookmarks..... 567
- Setting in the background..... 567
- Sharing URLs..... 567
- Tabs..... 567
- Weight information**..... 757
- What3words**
- Destination entry with a 3 word address..... 482
- Wheel change**
- Fitting a new wheel..... 640
- Lowering the vehicle..... 641
- Preparation..... 636
- Raising the vehicle..... 637
- Removing a wheel..... 640
- Removing/fitting hub caps..... 637
- Removing/fitting wheel trim..... 637
- Wheel rotation**..... 635
- Wheels**
- Breakdown..... 49, 610
- Care..... 604
- Checking..... 27, 40, 627
- Checking the tyre temperature..... 631
- Fitting..... 640
- Interchanging..... 635
- MOExtended..... 610
- Noise..... 627
- Notes on fitting..... 632
- Removing..... 640
- Removing/fitting hub cap..... 637
- Removing/fitting wheel trim..... 637
- Replacing..... 632, 636
- Selection..... 632
- Snow chains..... 41, 627
- Storing..... 635
- TIREFIT kit..... 612
- Tyre pressure..... 628
- Tyre pressure monitoring system..... 630
- Unusual handling characteristics..... 627

Wi-Fi

- Activating/deactivating..... 461
- Information on connection..... 460
- Setting up a hotspot..... 461
- Setting up an Internet connection..... 563

Window airbag..... 107**Windows**

- Care..... 604
- Convenience opening..... 162
- De-icing..... 237
- Opening with the key..... 162
- Opening/closing..... 160
- Opening/closing (air recirculation button)..... 52, 53
- Removing mist..... 240

Windscreen

- De-icing..... 237
- Demisting..... 233, 234
- Infrared reflective coating..... 232
- Radio waves..... 232
- Toll system..... 232

Windscreen heater..... 243**Windscreen washer fluid..... 42, 760****Windscreen washer system..... 23, 43, 599****Windscreen wipers**

- Activating/deactivating..... 226
- Replacing the wiper blades..... 23, 43, 227
- Replacing the wiper blades (wind-screen)..... 23, 43, 227

Winter operation

- Activating/deactivating snow chain mode..... 628
- Snow chains..... 41, 627

Winter tyres

- Limiter..... 41, 321
- Setting the permanent speed limit.... 41, 321

Wiper blades

- Care..... 604
- Replacing (windscreen)..... 23, 43, 227

Wipers..... 226**Wireless applications..... 646****Wireless charging**

- Mobile phone (front)..... 208
- Mobile phone (rear)..... 209
- Overview..... 207

Workout programme..... 181**Workshop..... 85****Z****Zero layer**

- Function..... 431
- Overview..... 432

Publication details

Germany

Internet

Further information about Mercedes-Benz vehicles and about Mercedes-Benz AG can be found on the following websites:

<https://www.mercedes-benz.com>

<https://group.mercedes-benz.com>

Documentation team

You are welcome to forward any queries or suggestions you may have regarding this Owner's Manual to the technical documentation team at the following address:

Mercedes-Benz AG, HPC: CAC, Customer Service,
70546 Stuttgart, Germany

©Mercedes-Benz AG: Not to be reprinted, translated or otherwise reproduced, in whole or in part, without written permission from Mercedes-Benz AG.

Vehicle manufacturer

Mercedes-Benz AG

Mercedesstraße 120

70372 Stuttgart

As at 07.10.22

F295 0041 02



Digital – in the vehicle

Discover the Operator's Manual in the multimedia system under "Vehicle". Begin with quick start, discover highlights and useful tips.



Vehicle document wallet

Here you can find comprehensive information about operating your vehicle and about services and guarantees in printed form.



Digital – on the Internet

You can find the Operator's Manual on the Mercedes-Benz homepage.



Digital – as an App

The Mercedes-Benz Guides App is available free-of-charge in familiar App stores.



Apple® iOS



Android™

Order no. F295 0041 02
Edition ÄJ2023-1a