



V60

RECHARGE

OWNER'S MANUAL



VÄLKOMMEN!

We hope your Volvo will give you many years of happy motoring. The vehicle is designed for the safety and comfort of you and your passengers. Volvo strives to design one of the world's safest passenger vehicles. Your Volvo is also designed to meet applicable safety and environmental requirements.

To increase your enjoyment of your Volvo, we recommend that you read the instructions and maintenance information contained in this

owner's manual. The owner's manual is also available as a mobile app (Volvo Manual) and on Volvo Cars support page (support.volvocars.com).

We also encourage everyone to always use seat belts in this and other vehicles. You should also not drive if you are under the influence of alcohol or medicines or if your ability to drive is for some other reason impaired.

TABLE OF CONTENTS

OWNER'S INFORMATION

Owner's information	16
Owner's Manual in the center display	17
Navigate in the Owner's Manual in the center display	18
Owner's manual in mobile devices	20
Volvo Cars support site	21
Using the Owner's Manual	21
The Owner's Manual and the environment	23

YOUR VOLVO

Contacting Volvo	26
Volvo ID	26
Creating and registering a Volvo ID	27
Drive-E – purer driving pleasure	28
IntelliSafe – driver support and safety	29
Sensus - connection and entertainment	30
Software Updates	33
Data recording	33
Terms and Conditions for Services	35
Customer Privacy Policy	35
Important information on accessories and extra equipment	36
Accessory installation	37
Connecting equipment to the vehicle's data link connector	37
Technician certification	38
Viewing the Vehicle Identification Number (VIN)	39
Volvo Structural Parts Statement	39
Change of market when importing or relocating	40
Driver distraction	41

SAFETY

Safety	44
Safety during pregnancy	45
Occupant safety	45
Reporting safety defects	46
Recall information	47
Whiplash Protection System	48
Seat belts	49
Buckling and unbuckling seat belts	50
Seat belt tensioners	52
Resetting the electric seat belt tensioners*	53
Door and seat belt reminders	54
Airbags	55
Driver/passenger side front airbags	56
Occupant weight sensor	59
Side airbags	62
Inflatable curtain	63
Safety mode	64
Starting and moving the vehicle when it is in safety mode	65
Child safety	66
Child restraints	68
Infant seats	70
Convertible seats	72
Booster cushions	74

Top tether anchors	75
Lower child seat attachment points	77
ISOFIX/LATCH lower anchors	77

DISPLAYS AND VOICE CONTROL

Displays and controls by the driver in a left-hand drive vehicle	80
Instrument panel	82
Instrument panel settings	84
Fuel gauge	85
Hybrid gauge	85
Hybrid battery gauge	86
Trip computer	87
Displaying trip data in the instrument panel	89
Resetting the trip odometer	90
Displaying trip statistics in the center display	90
Trip statistics settings	91
Date and time	92
Ambient temperature sensor	92
Indicator and warning symbols	93
Instrument panel licenses	96
App menu in instrument panel	102
Handling the App menu in the instrument panel	103
Messages in the instrument panel	104
Handling messages in the instrument panel	105
Handling messages saved from the instrument panel	106

Center display overview	108
Handling the center display	110
Activating and deactivating the center display	113
Navigating in the center display's views	113
Handling tiles in the center display	117
Function view in the center display	120
Moving apps and buttons in the center display	122
Symbols in the center display status bar	122
Using the center display keyboard	124
Changing keyboard language in the center display	127
Entering characters, letters and words by hand in the center display	127
Changing the appearance of the center display	129
Turning off and adjusting the volume of the center display system sounds	129
Changing system units of measurement	130
Changing system language	130
Changing settings in the center display's Top view	130
Opening contextual setting in the center display	131

Resetting user data when the vehicle changes owners	132
Resetting center display settings	132
Table of settings in the center display	133
Driver profiles	134
Selecting a driver profile	135
Changing a driver profile's name	135
Protecting a driver profile	136
Linking a remote key to a driver profile	136
Resetting driver profile settings	138
Messages in the center display	138
Handling messages in the center display	139
Handling messages saved from the center display	139
Head-up display*	140
Activating and deactivating the head-up display*	142
Head-up display settings*	142
Voice Control	143
Use voice recognition	144
Voice control for cellular phones	146
Voice control for radio and media	147
Voice control settings	148

LIGHTING

Lighting control and panel	150
Adjusting light functions via the center display	151
Parking lights	152
Daytime running lights	152
Low beams	153
Using high beam	154
Active high beam	155
Using turn signals	156
Active Bending Lights*	156
Front fog lights/corner illumination*	157
Rear fog light	158
Brake lights	159
Emergency brake lights	159
Hazard warning flashers	159
Using home safe lighting	160
Welcome Light	160
Interior Lighting	160
Adjusting interior lighting	162

WINDOWS, GLASS AND MIRRORS

Windows, glass and mirrors	164
Pinch protection for windows and sun curtains	164
Reset procedure for pinch protection	165
Power windows	165
Operating the power windows	166
Rearview/door mirrors	167
Adjusting the rearview mirror dimming function	168
Adjusting the door mirrors	168
Panoramic roof*	170
Operating the panoramic roof*	171
Auto closing the panoramic roof* sun curtain	173
Wiper blades and washer fluid	174
Using the windshield wipers	174
Using the rain sensor	175
Activating and deactivating the rain sensor's memory function	176
Using the windshield and headlight washers	177
Using the rear window wiper/washer	178
Using automatic rear window wiping when backing up	179

SEATS AND STEERING WHEEL

Manual front seats	182
Power* front seats	183
Adjusting the power* front seats	183
Storing positions for seats, mirrors and head-up display*	184
Using stored positions for seats, mirrors and head-up display*	185
Front seat massage* settings	186
Adjusting front seat massage settings*	187
Adjusting* front seat cushion length	188
Adjusting front seat side bolster settings*	189
Adjusting front seat lumbar support*	189
Adjusting the passenger seat from the driver's seat*	191
Folding down the rear seat backrests	192
Adjusting the rear seat head restraints	193
Steering wheel controls and horn	195
Adjusting the steering wheel	195

CLIMATE CONTROL

Climate	198	Activating and deactivating front seat ventilation*	213
Climate zones	198	Activating and deactivating the heated steering wheel*	214
Climate control sensors	199	Activating and deactivating automatic steering wheel heating*	214
Perceived temperature	199	Activating auto climate control	214
Climate control system voice commands	200	Activating and deactivating recirculation	215
Air quality	201	Activating and deactivating the recirculation timer setting	216
CleanZone*	201	Activating and deactivating max defroster	216
Clean Zone Interior Package*	202	Activating and deactivating the heated rear window and door mirrors	217
Interior Air Quality System*	202	Automatically activating and deactivating the heated rear window and door mirrors	218
Activating and deactivating the air quality sensor*	203	Setting the blower speed for the front seats	218
Passenger compartment air filter	203	Setting the temperature for the front seats	219
Advanced Air Cleaner*	204	Synchronize temperature	220
Air distribution	204	Activating and deactivating air conditioning	221
Adjusting air distribution	205	Parking climate	221
Opening, closing and directing air vents	205	Preconditioning	222
Air distribution options	207	Starting and stopping preconditioning	222
Climate system controls	210	Preconditioning timer	223
Activating and deactivating power front seats*	211		
Activating and deactivating the heated front seat*	212		
Activating and deactivating the heated rear seats*	212		

Adding and editing timer settings for preconditioning	224
Activating and deactivating preconditioning timer	225
Deleting preconditioning timer settings	225
Pre-cleaning*	226
Starting and stopping pre-cleaning*	226
Climate comfort retaining function	227
Starting and switching off the climate retaining function when parking	228
Parking climate symbols and messages	229
Heater	230
Parking heater	230
Additional heater	231
Activating and deactivating the auxiliary heater	231

KEY, LOCKS AND ALARM

Locking and unlocking	234	Antenna locations for the start and lock system	255
Lock indication	234	Locking and unlocking from inside the vehicle	256
Lock confirmation settings	236	Unlocking the tailgate from inside the vehicle	257
Remote key	236	Activating and deactivating child locks	257
Locking and unlocking using the remote key	239	Automatic locking when driving	258
Settings for remote and inside door unlock	240	Closing and locking the tailgate using the buttons*	259
Unlocking the tailgate using the remote key	241	Setting maximum opening height for the power tailgate*	261
Remote key range	241	Operating the tailgate with a foot movement*	261
Replacing the remote key's battery	242	Private Locking	262
Ordering additional remote keys	246	Activating and deactivating private locking	263
Care Key – restricted remote key	246	Alarm	264
Care Key settings	247	Arming and disarming the alarm	265
Detachable key blade	247		
Locking and unlocking with detachable key blade	248		
Electronic immobilizer	250		
Start and lock system type designations	250		
Keyless and touch-sensitive surfaces*	252		
Keyless locking and unlocking*	253		
Keyless unlock settings*	254		
Keyless tailgate unlock*	254		

DRIVER SUPPORT

Driver support systems	268	Cruise control standby mode	284	Activating or deactivating Curve Speed Assist (CSA)*	307
Speed-dependent steering wheel resistance	268	Adaptive Cruise Control*	284	Curve Speed Assist (CSA)* limitations	307
Electronic Stability Control	269	Adaptive Cruise Control* controls	286	Passing assistance*	308
Electronic Stability Control in sport mode	270	Adaptive Cruise Control* displays	286	Using passing assistance	308
Activating or deactivating Sport mode for Electronic Stability Control	271	Selecting and activating Adaptive Cruise Control*	287	Collision risk warning from driver support	309
Electronic Stability Control symbols and messages	272	Deactivating Adaptive Cruise Control*	288	Switching target vehicles with driver support	310
Connected Safety	274	Adaptive Cruise Control* standby mode	289	Adjusting set speed for driver support	311
Activating or deactivating Connected Safety	275	Adaptive Cruise Control* limitations	290	Setting time interval to the vehicle ahead	312
Connected Safety limitations	275	Switching between cruise control and Adaptive Cruise Control* in the center display	291	Drive modes when using time interval to vehicle	313
Road Sign Information*	276	Symbols and messages for Adaptive Cruise Control*	292	Auto-hold braking with driver support	313
Activating or deactivating Road Sign Information*	277	Pilot Assist*	294	Lane Keeping Aid	314
Road Sign Information* display	277	Pilot Assist* controls	296	Activating or deactivating Lane Keeping Aid	316
Road Sign Information and Sensus Navigation*	278	Pilot Assist* displays	297	Selecting type of assistance for Lane Keeping Aid	317
Speed limit and speed camera warnings from Road Sign Information*	278	Selecting and activating Pilot Assist*	298	Lane Keeping Aid limitations	317
Activating or deactivating warnings from Road Sign Information*	279	Deactivating Pilot Assist*	299	Lane Keeping Aid symbols and messages	318
Road Sign Information* limitations	280	Pilot Assist* standby mode	300	Lane Keeping Aid display	320
Cruise control	281	Temporarily deactivating steering assistance with Pilot Assist*	301	City Safety™	321
Selecting and activating cruise control	282	Pilot Assist* limitations	302	City Safety sub-functions	322
Deactivating cruise control	283	Pilot Assist* symbols and messages	304	Setting a warning distance for City Safety	324
		Curve Speed Assist (CSA)*	306		

Detecting obstacles with City Safety	325	Rear Collision Warning* limitations	341	Park Assist Camera*	359
City Safety in crossing traffic	327	BLIS*	342	Location and field of vision of Park Assist Cameras*	360
Limitations of City Safety in crossing traffic	328	Activating or deactivating BLIS	343	Park Assist Camera trajectory lines*	362
City Safety steering assistance for evasive maneuver	328	BLIS limitations	344	Park Assist sensor field	364
City Safety steering assistance limitations during evasive maneuvers	329	BLIS messages	345	Activating Park Assist Camera	365
Automatic braking during delayed evasive maneuvers with City Safety	329	Driver Alert Control	346	Park Assist Camera symbols and messages	367
City Safety braking for oncoming vehicles	330	Activating or deactivating Driver Alert Control	347	Park Assist Pilot*	369
City Safety limitations	331	Selecting guidance to a rest area if the Driver Alert Control warning has been given	347	Types of parking with Park Assist Pilot*	370
City Safety messages	334	Driver Alert Control limitations	348	Using Park Assist Pilot*	371
Steering assistance at risk of collision	335	Distance Alert*	348	Leaving a parallel parking space with Park Assist Pilot*	374
Activating or deactivating steering assistance during collision risks	336	Activating or deactivating Distance Alert	349	Park Assist Pilot* limitations	374
Run-Off Mitigation with steering assistance	336	Distance Alert limitations	349	Park Assist Pilot* messages	377
Steering assistance during collision risks from oncoming traffic	337	Cross Traffic Alert*	350	Radar sensor	378
Steering assistance during collision risks from behind*	338	Activating or deactivating Cross Traffic Alert*	351	Radar sensor type approval	379
Steering assistance during collision risks limitations	339	Cross Traffic Alert* limitations	351	Camera	381
Symbols and messages for steering assistance during collision risks	340	Cross Traffic Alert* messages	353	Camera/radar sensor limitations	381
Rear Collision Warning*	341	Park Assist*	354	Recommended camera and radar sensor maintenance	384
		Park Assist front, rear and sides*	355	Camera and radar unit symbols and messages	386
		Activating or deactivating Park Assist*	356		
		Park Assist limitations	357		
		Park Assist symbols and messages	358		

ELECTRIC MOTOR AND CHARGING

General information about electric vehicles	390
Charging the hybrid battery	391
Charging current	392
Charge cable	394
Charging cable residual current device	395
Charging cable temperature monitoring	397
Opening and closing the charging socket cover	397
Initiating hybrid battery charging	397
Charging status in the vehicle's charging socket	399
Charging status in the charging cable's control module	401
Charging status in the instrument panel	404
Stopping hybrid battery charging	406
Hybrid symbols and messages in the instrument panel	407
Long-term storage of vehicles with hybrid batteries	409

STARTING AND DRIVING

Starting the vehicle	412	Shifting gears with automatic transmission	428
Switching off the vehicle	414	Using the steering wheel paddles* to shift	429
Ignition modes	415	Shiftlock	431
Selecting ignition mode	416	The kickdown function	431
Brake functions	417	The Launch function*	431
Brakes	417	Automatic transmission symbols and messages	432
Brake Assist System	419	All Wheel Drive (AWD)	432
Braking on wet roads	420	Drive systems	432
Braking on salted roads	420	Starting and stopping the combustion engine	433
Maintenance of the brake system	420	Drive modes	434
Parking brake	421	Changing drive mode	438
Activating and deactivating the parking brake	421	Energy distribution using map data*	439
Settings for automatically activating the parking brake	423	Leveling control* and suspension	440
Parking on a hill	423	Adjusting suspension settings Polestar Engineered*	441
Parking brake malfunction	423	Economical driving	442
Auto-hold brakes	424	Range	443
Activating and deactivating Auto-hold at a standstill	425	Hold and Charge	445
Hill Start Assist	426	Preparing for a long trip	446
Braking assist after a collision	426	Winter driving	446
Regenerative braking*	426	Driving through standing water	447
Transmission	427	Opening/closing the fuel filler door	448
Automatic transmission	427		

Refueling	449
Fuel	450
Octane rating	451
Emission controls	453
Overheating of engine and transmission	453
Battery drain	454
Jump starting using another battery	455
Driving with a trailer	457
Trailer Stability Assist*	459
Checking trailer lights	460
Towing using a towline	461
Attaching and removing the towing eyelet	461
Recovery	462
HomeLink®*	463
Programming HomeLink®*	463
Using HomeLink®*	465
Type approval for HomeLink®*	466
Compass*	466
Activating and deactivating the compass*	467
Calibrating the compass*	467

AUDIO, MEDIA AND INTERNET

Audio, media and Internet	470	SiriusXM Travel Link®* - Notifications	489
Sound settings	470	SiriusXM Travel Link®* - Fuel	489
Sound experience*	471	SiriusXM Travel Link®* - Sports	491
Apps	472	Media player	491
Download apps	473	Playing media	492
Updating apps	473	Controlling and changing media	493
Deleting apps	474	Media searches	494
Radio	474	Gracenote®	495
Starting the radio	475	Video	496
Changing waveband and radio station	476	Playing video	496
Searching for a radio station	476	Playing DivX®	496
Storing radio channels in the Radio favorites app	477	Video settings	497
Radio settings	478	Streaming media via Bluetooth®	497
RBDS	478	Connecting a device via Bluetooth®	497
HD Radio™	479	Playing media via the USB port	498
Activating and deactivating the HD Radio™	480	Connecting a device via the USB port	498
HD Radio™ sub-channels	481	Technical specifications for USB devices	499
HD Radio™ limitations	481	Compatible file formats for media	499
SiriusXM® Satellite radio*	482	Apple® CarPlay®*	500
Using SiriusXM® Satellite radio*	483	Using Apple® CarPlay®*	501
Settings for SiriusXM® Satellite radio*	485	Settings for Apple® CarPlay®*	503
SiriusXM Travel Link®*	486	Tips for using Apple® CarPlay®*	503
SiriusXM Travel Link®* - Weather	487	Android Auto*	504

Using Android Auto*	505
Settings for Android Auto*	506
Tips for using Android Auto*	506
Phone	507
Connecting a phone to the car via Bluetooth for the first time	508
Connecting a phone to the car via Bluetooth automatically	510
Connecting a phone to the car via Bluetooth manually	510
Disconnecting a Bluetooth-connected phone	510
Switch between phones connected via Bluetooth	511
Disconnecting Bluetooth-connected devices	511
Handling phone calls	511
Handling text messages	512
Text message settings	513
Managing the phone book	514
Phone settings	514
Settings for Bluetooth devices	515
Internet-connected vehicle*	516
Connecting the vehicle to the Internet via a Bluetooth-connected phone	517
Connecting the vehicle to the Internet via a phone (Wi-Fi)	517

Connecting the vehicle to the Internet via vehicle modem (SIM card)	518
Vehicle modem settings	519
Sharing Internet from the vehicle via Wi-Fi hotspot (tethering)	520
No or poor Internet connection	521
Deleting Wi-Fi networks	521
Wi-Fi technology and security	522
Terms of use and data sharing	522
Activating and deactivating data sharing	523
Data sharing for services	523
Hard disk storage space	524
License agreement for audio and media	525

WHEELS AND TIRES

Tires	536
Tire direction of rotation	538
Tread wear indicator	539
Tire terminology	539
Tire sidewall designations	540
Uniform Tire Quality Grading	542
Checking tire pressure	543
Adjusting tire pressure	544
Recommended tire pressure	545
Tire pressure monitoring system*	545
Saving new reference values for tire inflation pressure monitoring*	547
Viewing tire pressure status in the center display*	548
Action when warned of low tire pressure	549
Tire inflation pressure monitoring system* messages	550
Changing a wheel	550
Tool kit	552
Jack*	553
Wheel bolts	553
Spare wheel	554
Handling the spare wheel	555
Snow tires	556
Snow chains	556

Tire sealing system	557
Using the tire sealing system	558
Inflate tires with the compressor included in the tire sealing system	562
Determining the vehicle's permitted weight	563

LOADING, STORAGE AND PASSENGER COMPARTMENT

Passenger compartment interior	566
Tunnel console	567
Electrical outlets	567
Using the electrical outlets	568
Using the glove compartment	569
Sun visors	570
Cargo compartment	570
Loading recommendations	571
Roof loads and load carriers	572
Grocery bag holders	572
Load anchoring eyelets	573
Rear seat ski hatch	574
Installing and removing the cargo compartment cover*	574
Operating the cargo compartment cover*	575
Installing and removing the steel cargo grid*	576
Installing and removing the cargo net*	578

MAINTENANCE AND SERVICE

Volvo's service program	582
Data transfer between vehicle and workshop over Wi-Fi	585
Download Center	585
Handling system updates via Download Center	586
Vehicle status	587
Scheduling service and repairs	587
Sending vehicle information to the workshop	588
Hoisting the vehicle	590
Climate control system service	593
Replacing a windshield with head-up display*	593
Opening and closing the hood	593
Engine compartment overview	595
Engine oil	596
Checking and filling engine oil	597
Coolant	599
Refilling coolant	599
Starter battery	601
Hybrid battery	603
Battery symbols	603
Battery recycling	604
Fuses and fuseboxes	604
Replacing fuses	605

Fuses in the engine compartment	606
Fuses under the glove compartment	613
Fuses in the cargo compartment	619
Replacing bulbs	624
Cleaning the interior	624
Cleaning the center display	625
Cleaning the head-up display* and instrument panel	626
Cleaning fabric upholstery and ceiling liner	626
Cleaning the seat belt	627
Cleaning textile floor and inlay mats	628
Cleaning leather upholstery*	628
Cleaning the leather steering wheel	629
Cleaning interior plastic, metal and wood surfaces	630
Cleaning the exterior	630
Polishing and waxing	631
Hand washing	632
Automatic car washes	633
High-pressure washing	634
Cleaning the wiper blades	635
Cleaning exterior plastic, rubber and trim components	635
Cleaning rims	636
Corrosion protection	637

Paintwork	637
Touching up minor paint damage	638
Color codes	639
Changing rear window wipers	639
Replacing windshield wiper blades	641
Putting the wiper blades in service position	642
Filling washer fluid	643

SPECIFICATIONS

Type designations	646
Dimensions	649
Weights	651
Towing capacity and tongue weight	652
Engine specifications	653
Engine oil specifications	654
Transmission fluid specifications	654
Brake fluid specifications	655
Fuel tank volume	655
Air conditioning specifications	655
Approved tire pressure	657

INDEX

Index

659

OWNER'S INFORMATION

Owner's information

Owner's information is available in several different formats, both digital and printed. The Owner's Manual is available on the vehicle's center display, as a mobile app and on Volvo Cars' support website. There is also a Quick Guide in the glove compartment, as well as a supplement to the Owner's Manual containing information about e.g. fuses, specifications, etc. A printed Owner's Manual can be ordered.

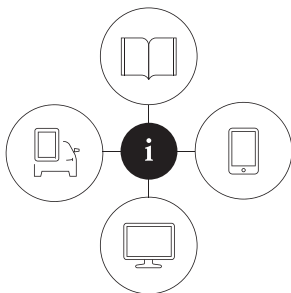

0000003

Vehicle's center display¹



In the center display, pull down Top view and tap **Owner's manual**. This gives you access to visual navigation with exterior and interior images of the vehicle. The information is searchable and is divided into categories.

Mobile app

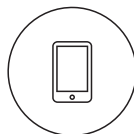

In App Store or Google Play, search for "Volvo Manual". Download the app to your smartphone or tablet and select your vehicle model. The app contains instructive videos and offers visual navigation, including exterior and interior images of the vehicle. The contents are searchable and the sections are designed to be easy to navigate.

Volvo Cars support site



Go to volvocars.com/support and select your country. Owner's Manuals are available here for viewing online and in PDF format. The support site also contains instructive videos and additional information and assistance concerning your vehicle and owning a Volvo. The website is available on most markets.

Printed information

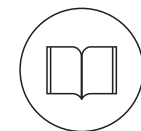

The glove compartment contains a printed supplement to the Owner's Manual¹, which contains information on fuses and specifications as well as a summary of important and practical information.

There is also a printed Quick Guide with useful information about the most commonly used features and functions in your vehicle.

Other printed information may also be provided in the vehicle, depending on equipment level, market, etc.

A printed Owner's Manual and accompanying supplement can also be ordered. Contact a Volvo retailer to order.

¹ For markets without Owner's Manuals in the center display, a complete printed manual is provided along with the vehicle.

! CAUTION

The driver is always responsible for operating the vehicle in a safe manner and adhering to all applicable laws and regulations. It is also important that the vehicle is operated, maintained and serviced according to Volvo's recommendations provided in the owner's information.

If the information in the center display differs from the printed information, the printed information always takes precedence.

i NOTE

Changing languages in the center display could mean that certain owner's information will not comply with national or local laws and regulations. Do not change to a language you do not speak well, as it can be difficult to find your way back through the menu.

Related information

- Owner's Manual in the center display (p. 17)
- Owner's manual in mobile devices (p. 20)
- Volvo Cars support site (p. 21)
- Using the Owner's Manual (p. 21)

Owner's Manual in the center display

A digital version of the Owner's Manual is available in the vehicle's center display².

The digital Owner's Manual can be accessed from Top view and in certain cases, the contextual Owner's Manual can also be accessed from Top view.

i NOTE

The digital Owner's Manual is not available during driving.

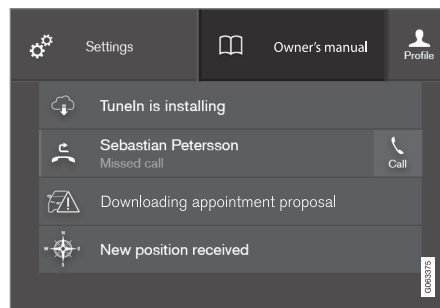
OWNER'S MANUAL

Top view with button for Owner's Manual.

To open the Owner's Manual, pull down Top view in the center display and tap **Owner's manual**.

The information in the Owner's Manual can be accessed directly via the Owner's Manual start page or via its Top menu.

² Available in most markets.

◀ Contextual Owner's Manual

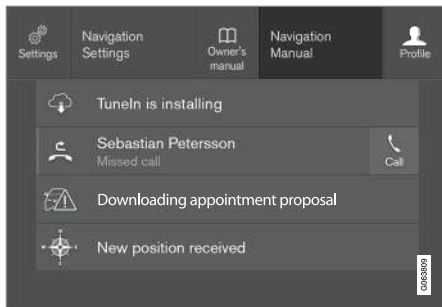

Top view with button for contextual Owner's Manual.

The contextual Owner's Manual is a shortcut to an article in the Owner's Manual describing the active function displayed on the screen. When a contextual Owner's Manual is available, it will be shown to the right of **Owner's manual** in Top view.

Tap the contextual Owner's Manual to open an article in the Owner's Manual related to the information displayed on the screen.

For example, tap **Navigation Manual** to open an article related to navigation.

Certain apps in the vehicle only. For downloaded third-party apps, it is e.g. not possible to access app-specific articles.

Related information

- Navigate in the Owner's Manual in the center display (p. 18)
- Navigating in the center display's views (p. 113)
- Download apps (p. 473)

Navigate in the Owner's Manual in the center display

The digital Owner's Manual can be accessed from the center display's Top view. The contents are searchable and the sections are designed to be easy to navigate.

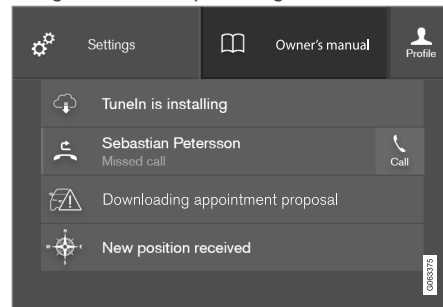

The Owner's Manual is accessed from Top view.

- To open the Owner's Manual, pull down Top view in the center display and tap **Owner's manual**.

There are a number of ways to find information in the Owner's Manual. The options can be accessed from the Owner's Manual start page and from the Top menu.

Opening the menu in the Top menu

- Tap  in the upper list in the Owner's Manual.
 - > A menu will open, displaying different options for finding information:

Start page



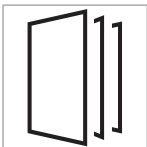

Tap the symbol to return to the Owner's Manual start page.

Categories



The articles in the Owner's Manual are structured into main and sub-categories. The same article may appear in several relevant categories in order to help make them easier to find.

1. Tap **Categories**.
 - > The main categories are listed.
2. Tap a main category ().
 - > A list of sub-categories () and articles () will appear.
3. Tap an article to open it.
To go back, tap the left arrow.

Featured articles

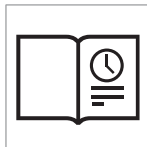

Tap the symbol to go to a page with links to a selection of useful articles about the vehicle's more commonly used features and functions. The articles can also be accessed via categories, but

have been collected here for quicker access. Tap an article to read it in its entirety.

Exterior and interior hotspots

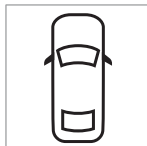

Exterior and interior overviews of the vehicle. Hotspots are provided for certain functions, components, etc. Tap a hotspot to come to a relevant article.



1. Press **Exterior** or **Interior**.
 - > Exterior or interior images of the vehicle are shown with hotspots. The hotspots lead to articles about the corresponding function, component, etc. Swipe the screen horizontally to scroll between the images.

2. Tap a hotspot.
 - > The title of a relevant article will be displayed.
3. Tap the title to open the article.



To go back, tap the left arrow.

Favorites



Tap the symbol to go to articles saved as favorites. Tap an article to read it in its entirety.

Saving or deleting favorite articles

Save an article as a favorite by tapping the  at the upper right when the article is open. When an article has been saved as a favorite, the star symbol will be filled in: .

To remove an article from the list of favorites, tap its star again.

Video

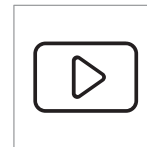

Tap the symbol to go to brief instructive videos for various functions in the vehicle.

◀ **Information**



Tap the symbol for information about the current version of the Owner's Manual in your vehicle and other useful information.

Using the search function in the Top menu

1. Tap  in the Owner's Manual upper menu. A keyboard will appear at the bottom of the screen.
2. Enter a search word, e.g. "seat belt".
 - > Suggested articles and categories will be displayed as characters are entered.
3. Tap the article or category to read it.

Related information

- Owner's Manual in the center display (p. 17)
- Using the center display keyboard (p. 124)
- Using the Owner's Manual (p. 21)

Owner's manual in mobile devices

The Owner's Manual is available as a mobile app³ and can be downloaded from the App Store and Google Play. The app is adapted for both smartphones and tablets.



The Owner's Manual can be downloaded as a mobile app from the App Store or Google Play. This QR code will take you directly to the app. You can also search for "Volvo manual" in the App Store or

Google Play.

The app contains videos and exterior/interior images of the vehicle. These images contain hotspots for various functions, components, etc., which lead directly to related information.

The contents are searchable and the sections are designed to be easy to navigate.

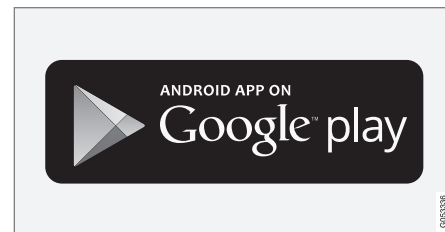
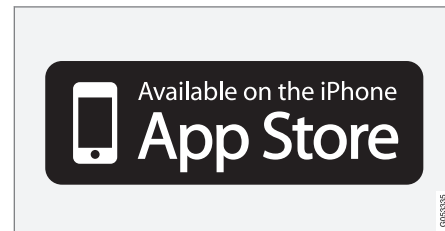

The mobile app is available on both App Store and Google Play.

Related information

- Using the Owner's Manual (p. 21)

³ Certain mobile devices.

Volvo Cars support site

Volvo Cars' website and support site contain additional information about your vehicle.

Online support

Go to volvocars.com/support to visit the site. The support site is available in most markets.

The site contains support for e.g. Internet-based services and functions, Volvo On Call, the navigation system* and apps. Videos and step-by-step instructions explain various procedures, such as how to connect the vehicle to the Internet via a cellular phone.

Downloadable information

Maps

For vehicles equipped with Sensus Navigation maps can be downloaded from the support site.

Mobile apps

Beginning with model year 2014, the Owner's Manual is available as an app for certain Volvo models. The Volvo On Call app can also be downloaded from the support site.

Owner's manuals in PDF format

Owner's Manuals are available for downloading in PDF format. Select the vehicle model and year to download the desired manual.

Contact

Contact information for customer support and your nearest Volvo retailer are available on the support site.

Related information

- Contacting Volvo (p. 26)
- Volvo ID (p. 26)

Using the Owner's Manual

To get to know your new vehicle, read the Owner's Manual before driving it for the first time.

Reading your Owner's Manual is a way to familiarize yourself with new features and functions, get advice on how to handle your vehicle in different situations, and to learn how to take advantage of everything your Volvo has to offer. Pay particular attention to the safety warnings provided in the Owner's Manual.

The intention of this owner's information is to explain all of the possible features, functions, options and accessories included in a Volvo vehicle. It is not intended as an indication or guarantee that all of these features, functions and options are included in every vehicle. Some terminology used may not exactly match terminology used in sales, marketing and advertising materials.

Volvo continuously works to develop and improve our products. Modifications can mean that information, descriptions and illustrations in the Owner's Manual differ from the equipment in the vehicle. We reserve the right to make changes without prior notice.

Do not remove this manual from the vehicle. If a problem should occur, you will not have the necessary information on where and how to get professional assistance.

© Volvo Car Corporation



◀ Option/accessory

In addition to standard equipment, the Owner's Manual also describes options (factory-installed equipment) and certain accessories (extra retrofitted equipment).

All, at the time of publication known, options and accessories are marked with an asterisk:

*

The equipment described in the Owner's Manual is not available in all vehicles. Vehicles may be equipped differently depending on market requirements and national or local laws and regulations.

For more information on which equipment is standard and which is an option or accessory, please contact your Volvo retailer.

Decals

There are various types of decals affixed in the vehicle to communicate important information in a clear manner. The importance of these decals is explained as follows, in descending order of importance.

Risk of injury

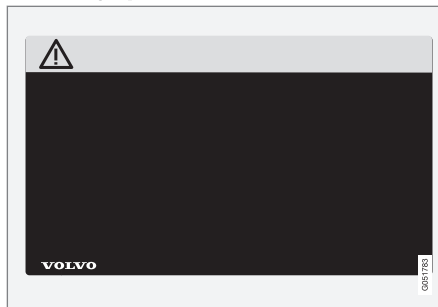

Black ISO symbols on a yellow warning field, white text/image on a black message field. Used to indicate potential danger. Ignoring a warning of this type could result in serious injury or death.

Risk of damage



White ISO symbols and white text/image on a black or blue warning field and message field. Used to indicate potential danger. Ignoring a warning of this type could result in damage.

Information



White ISO symbols and white text/image on a black message field.

i NOTE

The decals shown in the Owner's Manual do not claim to be exact reproductions of those found in the vehicle. The purpose is to show approximately how they look and about where they are located. The information that applies for your vehicle in particular is found on the decal on the vehicle.

Illustrations, images and video clips

Illustrations, images and video clips used in the Owner's Manual are sometimes generic and are intended to provide an overview or an example of a certain function or feature. They may vary depending on equipment level and market and may differ from the appearance of your vehicle.

Related information

- Owner's Manual in the center display (p. 17)
- Owner's manual in mobile devices (p. 20)
- Volvo Cars support site (p. 21)

The Owner's Manual and the environment

The Owner's Manual is printed on paper from responsibly managed forests.

The Forest Stewardship Council (FSC)[®] symbol certifies that the paper pulp in the printed Owner's Manual comes from FSC[®]-certified forests or other responsibly managed sources.

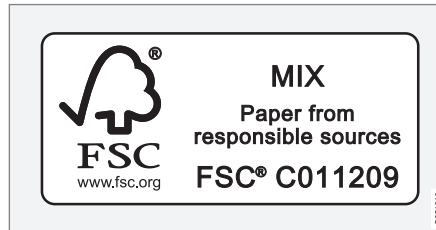

Related information

- Drive-E – purer driving pleasure (p. 28)

YOUR VOLVO

Contacting Volvo

Use the following contact information if you would like to get in touch with Volvo in the United States or Canada.

In the USA:

Volvo Car USA, LLC
Customer Care Center
1 Volvo Drive,
P.O. Box 914
Rockleigh, New Jersey 07647
1-800-458-1552
volvocars.com/us

In Canada:

Volvo Car Canada Ltd.
Customer Care Centre
9130 Leslie Street, Suite 101
Richmond Hill, Ontario L4B 0B9
1-800-663-8255
volvocars.com/ca

Volvo ID

Volvo ID is a personal ID that gives you access to a range of services using a single username and password.

NOTE

The available services can vary over time and depend on equipment level and market.

Examples of services:

- Volvo On Call-app - check your vehicle using your phone. You can check fuel level, find the nearest gas station and lock the vehicle remotely.
- Send to Car – send addresses from online map services directly to the vehicle.
- Send a request for service and repairs directly from the vehicle. The booking will then be completed via email.

NOTE

If the username/password for a service (e.g. Volvo On Call) is changed, the change will also automatically be applied to other services.

The creation of a Volvo ID is initiated through the Volvo On Call app or from the vehicle and then completed by email.

When a Volvo ID is registered in the vehicle, additional services are available. Multiple Volvo IDs can be used for the same vehicle, and multiple vehicles can be linked to the same Volvo ID.

Related information

- Creating and registering a Volvo ID (p. 27)
- Scheduling service and repairs (p. 587)

Creating and registering a Volvo ID

A Volvo ID can be created in two ways. If your Volvo ID was created with the Volvo On Call app, the Volvo ID must also be registered to the vehicle to enable access to the Volvo ID services.

Creating a Volvo ID with the Volvo ID app

1. Download the Volvo ID app from **Download Center** in the center display's App view.
2. Start the app and register a personal email address.
3. Follow the instructions that will be sent automatically to this email address.
 - > A Volvo ID has now been created and is automatically registered to the vehicle. The Volvo ID services can now be used.

Creating a Volvo ID using the Volvo On Call app¹

1. Download the latest version of the Volvo On Call app to your phone².
2. Choose to create a Volvo ID.
3. The website for creating a Volvo ID will open. Fill in the requested information.
4. Check the box to accept the terms and conditions.

5. Press the button to create your Volvo ID.
6. An email will be sent to the address you have provided. Click on the link in the email to activate your Volvo ID.
 - > Your Volvo ID is now ready to be used.

Registering your Volvo ID to the vehicle

If your Volvo ID was created using the Volvo On Call app, follow these steps to register the ID to the vehicle:

1. If you have not already done so, download the Volvo ID app from **Download Center** in the center display's App view.

NOTE

To download apps the vehicle must be connected to the internet.

2. Start the app and enter your Volvo ID/ email address.
3. Follow the instructions that will be automatically sent to the email address connected to your Volvo ID.
 - > Your Volvo ID has now been registered to the vehicle. The Volvo ID services can now be used.

Related information

- Volvo ID (p. 26)
- Download apps (p. 473)
- Handling system updates via Download Center (p. 586)
- Internet-connected vehicle* (p. 516)

¹ Vehicles with Volvo On Call.

² Can be downloaded from e.g. the Apple App Store or Google Play.

Drive-E – purer driving pleasure

Volvo is committed to the well-being of its customers. As a natural part of this commitment, we care about the environment in which we all live. Concern for the environment means an everyday involvement in reducing our environmental impact.

Volvo's environmental activities are based on a holistic view, which means we consider the overall environmental impact of a product throughout its complete life cycle. In this context, design, production, product use, and recycling are all important considerations. In production, Volvo has partly or completely phased out several chemicals including CFCs, lead chromates, asbestos, and cadmium; and reduced the number of chemicals used in our plants 50% since 1991.

Volvo was the first in the world to introduce into production a three-way catalytic converter with a Lambda sond, now called the heated oxygen sensor, in 1976. The current version of this highly efficient system reduces emissions of harmful substances (CO, HC, NOx) from the exhaust pipe by approximately 95 - 99% and the search to eliminate the remaining emissions continues. Volvo is the only automobile manufacturer to offer CFC-free retrofit kits for the air conditioning system of all models as far back as the 1975 model 240. Advanced electronic engine controls and cleaner fuels are bringing us closer to our goal. In addition to

continuous environmental refinement of conventional gasoline-powered internal combustion engines, Volvo is actively looking at advanced technology alternative-fuel vehicles.

When you drive a Volvo, you become our partner in the work to lessen the vehicle's impact on the environment. To reduce your vehicle's environmental impact, you can:

- Maintain proper air pressure in your tires. Tests have shown decreased fuel economy with improperly inflated tires.
- Follow the recommended maintenance schedule in your Warranty and Service Records Information booklet.
- Drive at a constant speed whenever possible.
- See a trained and qualified Volvo service technician as soon as possible for inspection if the check engine (malfunction indicator) light illuminates, or stays on after the vehicle has started.
- Properly dispose of any vehicle-related waste such as used motor oil, used batteries, brake pads, etc.
- When cleaning your vehicle, please use genuine Volvo car care products. All Volvo car care products are formulated to be environmentally friendly.

Recharge vehicles

- If possible, precondition the vehicle with the charging cable before driving.
- If preconditioning is not possible in cold weather, use the seat and steering wheel heating primarily. Avoid heating the entire passenger compartment, which reduces the hybrid battery's charge level.
- Choose the **Pure** drive mode to help minimize electric power consumption.
- In hilly terrain, put the gear selector in mode **B** to utilize the electric motor's braking function when the accelerator pedal is released. This helps charge the hybrid battery.

Related information

- Economical driving (p. 442)
- Range (p. 443)
- Starting and stopping preconditioning (p. 222)
- The Owner's Manual and the environment (p. 23)
- Air quality (p. 201)

IntelliSafe – driver support and safety

IntelliSafe is Volvo Cars' philosophy regarding vehicle safety. IntelliSafe consists of a number of systems³ that are designed to help make driving safer, prevent accidents and protect passengers and other road users.

WARNING

The functions are supplementary aids – they cannot manage all situations in all conditions.

The driver is always responsible for ensuring that the vehicle is driven in a safe manner and in accordance with applicable traffic rules and regulations.

Support

IntelliSafe has the following functions designed to help the driver operate the vehicle more safely.

- Active high beam
- Tunnel detection
- Pilot Assist
- Cross Traffic Alert*
- Blind Spot Information*
- Park Assist*
- Park Assist Pilot*

- Park Assist Camera*
- Road Sign Information*
- Electronic Stability Control
- Roll Stability Control
- Cruise control
- Adaptive Cruise Control*
- Rear Collision Warning
- Driver Alert Control
- All-Wheel Drive (AWD)⁴

Prevention

IntelliSafe has the following functions designed to help the driver prevent accidents.

- City Safety
- Distance Alert*
- Lane Keeping Aid
- **Collision Avoidance**

Protection

IntelliSafe has the following interacting functions to help protect the driver and passengers in certain situations in the event of an accident.

- Whiplash Protection System
- Seat belt with seat belt tensioner
- Airbags

NOTE

Read the individual parts about each system to fully understand the functions and be notified of important warnings.

Related information

- Active high beam (p. 155)
- Safety (p. 44)
- Driver support systems (p. 268)

³ Some of these systems are standard, while others are options. This may vary depending on market, vehicle model and model year.

⁴ All Wheel Drive

Sensus - connection and entertainment

Sensus makes it possible to use apps and turn your vehicle into a Wi-Fi hotspot.

This is Sensus



Sensus provides an intelligent interface and Internet connection to the digital world. An intuitive navigation structure offers access to relevant assistance, information and entertainment when it is needed, without distracting the driver.

Sensus includes all of the solutions in the vehicle related to entertainment, Internet connection and navigation*, and serves as the user interface between the driver and the vehicle. Sensus is what makes communication between you, the vehicle and the world around you possible.

Information when it's needed, where it's needed

The vehicle's displays present the right information at the right time. Information is presented in different displays depending on how it should be prioritized by the driver.

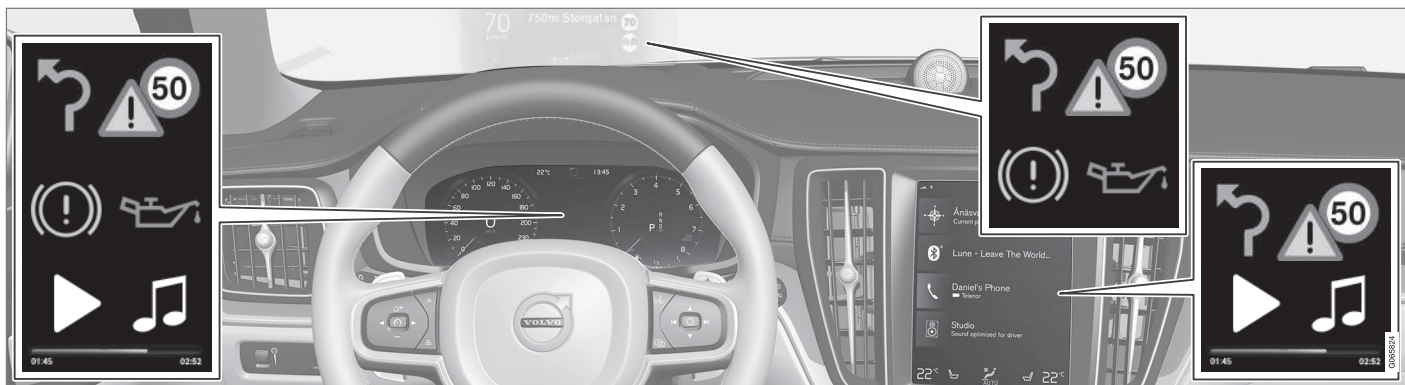

Different types of information are shown in different displays depending on how the information should be prioritized.

Head-up display*

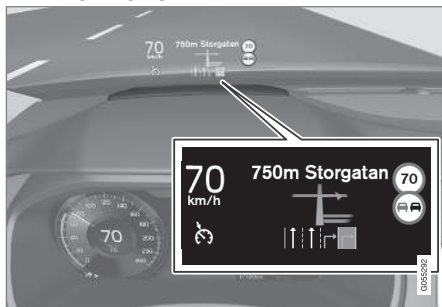

The head-up display presents information that the driver should react to immediately. For example, traffic warnings, speed informa-

tion and navigation messages*. Road sign information and incoming phone calls are also shown in the head-up display. These can be handled using the right-side steering wheel keypad or the center display.

Instrument panel



The instrument panel displays information such as speed, incoming phone calls or the



- ◀ track currently playing. It is controlled using the steering wheel keypads.

Center display



Many of the vehicle's main functions are controlled from the center display, a touchscreen that reacts to taps and other gestures. This minimizes the number of physical buttons and controls needed in the vehicle. The screen can also be operated while wearing gloves.

The center display is used to control e.g. the climate and entertainment systems and to adjust the power seats*. The information presented in the center display can be handled by the driver or by someone else in the vehicle.

Voice control system



The voice control system enables the driver to control certain vehicle functions without taking their hands off the wheel. The system can understand natural speech.

Use voice commands to e.g. play a song, make a phone call, increase the temperature in the passenger compartment or have a text message read aloud.

Related information

- Head-up display* (p. 140)
- Instrument panel (p. 82)
- Center display overview (p. 108)
- Voice Control (p. 143)
- Internet-connected vehicle* (p. 516)
- Sharing Internet from the vehicle via Wi-Fi hotspot (tethering) (p. 520)

Software Updates

So that you as a Volvo customer shall have the best possible experience from your car, Volvo is continuously developing the systems in the cars and the services that you are offered.

The software in your Volvo will be updated to the latest version when the vehicle is serviced at an authorized Volvo retailer. With the latest software update, you can take advantage of available improvements, including those that came with previous software updates.

For more information on available updates and answers to frequently asked questions, visit volvocars.com/support.

i NOTE

Functionality after updating may vary depending on market, model, model year and options.

Related information

- Sensus - connection and entertainment (p. 30)
- Handling system updates via Download Center (p. 586)

Data recording

As part of Volvo's commitment to safety and quality, certain information is recorded regarding vehicle operation, functionality and incidents.

US market only:

EDR

This vehicle is equipped with an "Event Data Recorder" (EDR). The main purpose of an EDR is to record, in certain crash or near crash-like situations, such as an air bag deployment or hitting a road obstacle, data that will assist in understanding how a vehicle's systems performed. The EDR is designed to record data related to vehicle dynamics and safety systems for a short period of time, typically 30 seconds or less. The EDR in this vehicle is designed to record such data as:

- How various systems in your vehicle were operating;
- Whether or not the driver and passenger safety belts were buckled/fastened;
- How far (if at all) the driver was depressing the accelerator and/or brake pedal; and,
- How fast the vehicle was traveling.

These data can help provide a better understanding of the circumstances in which crashes and injuries occur. NOTE: EDR data are recorded by your vehicle only if a non-

trivial crash situation occurs; no data are recorded by the EDR under normal driving conditions and no personal data (e.g., name, gender, age, and crash location) are recorded. However, other parties, such as law enforcement, could combine the EDR data with the type of personally identifying data routinely acquired during a crash investigation.

To read data recorded by an EDR, special equipment is required, and access to the vehicle or the EDR is needed. In addition to the vehicle manufacturer, other parties, such as law enforcement, that have the special equipment, can read the information if they have access to the vehicle or the EDR.

ASDR

This vehicle is equipped with an Active Safety Data Recorder (ASDR). This data recorder can record information related to the usage of the car, functional errors and active safety actuations (e.g. auto brake). The information saved is used by technicians for service and maintenance to diagnose and repair possible faults that has occurred in the vehicle and to fulfil certain legal requirements. The registered data can also, in congregated form, be used for research- and product development – purposes to continuously improve the safety and quality of Volvo Cars. For more information contact your local Volvo retailer.



◀◀ **Canadian market only:**

This vehicle is equipped with an “Event Data Recorder” (EDR). The main purpose of the EDR is to register and record data in traffic accidents or accident-like situations, e.g. if an airbag deploys or if the vehicle hits an obstacle in the road. This data is recorded in order to help understand how the vehicle's systems perform in these types of situations. The EDR is designed to record data related to vehicle dynamics and safety systems for a short period of time, usually 30 seconds or less.

The EDR in this vehicle is designed to record data in traffic accidents or accident-like situations such as:

- How the various systems in the vehicle performed;
- Whether the driver and passenger seat belts were tightened/buckled;
- The driver's use of the accelerator/brake pedal;
- How fast the vehicle was moving.

This data can help provide a better understanding of the circumstances in which traffic accidents and injuries occur. The EDR records data only if a non-trivial accident situation occurs. EDR does not record any data during normal driving conditions. The system also never registers data on who is driving the vehicle or the geographical location of the acci-

dent or near-accident. However, other parties, such as law enforcement, could combine the EDR data with the type of personally identifiable information that is routinely acquired during an accident investigation. Special equipment and access to either the vehicle or the EDR is required to read this recorded data.

In addition to the EDR, the vehicle is equipped with a number of computers that continuously control and monitor the vehicle's performance. These computers may record data during normal driving conditions, particularly if they detect a fault relating to the vehicle's operation and functionality or upon activation of the vehicle's active driver support functions (e.g. City Safety or the auto-brake function).

Some of this recorded data is required by technicians performing service and maintenance in order to diagnose and rectify any faults that may have occurred in the vehicle. The recorded information is also needed to enable Volvo to fulfill legal and other regulatory requirements. Information registered in the vehicle is stored in its computers until the vehicle is serviced or repaired.

In addition to the above, the recorded information may be used in aggregated form for research and product development purposes in order to continuously improve the safety and quality of Volvo vehicles.

Volvo will not provide this information to any third parties without the vehicle owner's consent. However, national legislation and regulations may require Volvo to disclose this type of information to law enforcement or other authorities that can claim a legal right to the information. Special technical equipment, which Volvo and workshops that have entered agreements with Volvo have access to, is required to read and interpret the recorded data. Volvo is responsible for ensuring that information provided to Volvo in conjunction with service and maintenance is stored and handled securely and in compliance with applicable legal requirements. For more information, please contact a Volvo retailer.

Vehicle Connectivity Module (VCM High)

Vehicles equipped with VCM High can collect data on the vehicle's safety functions as well as other functions in the vehicle. This data is collected for product development, quality follow-up, safety work and to improve and monitor the vehicle's quality and its safety functions. Data is also collected in order to manage Volvo Cars' warranty commitments and to comply with legal requirements related to engine emission data.

i NOTE

When collecting data, Volvo may use a small portion of the vehicle's data plan, up to 10 MB a month.

Related information

- Contacting Volvo (p. 26)
- Volvo Structural Parts Statement (p. 39)

Terms and Conditions for Services

Volvo offers services that help enhance the vehicle's safety and comfort.

These services comprise everything from assistance in emergencies to navigation and various maintenance services.

Before using the services, it is important to read support information about terms and conditions for the services at volvocars.com.

Related information

- Customer Privacy Policy (p. 35)

Customer Privacy Policy

Volvo respects and safeguards the personal privacy of everyone who visits our websites.

This policy refers to the handling of customer data and personal information. The purpose is to give current, past and potential customers a general understanding of:

- The circumstances in which we collect and process your personal data.
- The types of personal data we collect.
- Why we collect your personal data.
- How we process your personal data.

For more information on the policy, search for support information on volvocars.com.

Related information

- Terms of use and data sharing (p. 522)
- Terms and Conditions for Services (p. 35)
- Data recording (p. 33)

Important information on accessories and extra equipment

Incorrectly connected or installed accessories or extra equipment may have an adverse effect on the vehicle's electronics.

We strongly recommend that Volvo owners use only genuine, Volvo-approved accessories, and that accessory installations be performed only by a trained and qualified Volvo service technician. Certain accessories only work when the associated software is installed in the vehicle's computer system.

The equipment described in the Owner's Manual is not available in all vehicles. Vehicles may be equipped differently depending on market requirements and national or local laws and regulations.

Optional or accessory equipment may not be available in all countries or markets. Please note that some vehicles may be equipped differently, depending on special legal requirements. For more information on which equipment is standard and which is an option or accessory, please contact your Volvo retailer.

NOTE

Do not export your Volvo to another country before investigating that country's applicable safety and exhaust emission requirements. In some cases it may be difficult or impossible to comply with these requirements. Modifications to the emission control system(s) may render your Volvo not certifiable for legal operation in the U.S., Canada and other countries.

WARNING

CALIFORNIA proposition 65

Engine exhaust, some of its constituents, and certain vehicle components contain or emit chemicals known to the state of California to cause cancer, and birth defects or other reproductive harm. In addition, certain fluids contained in vehicles and certain products of component wear contain or emit chemicals known to the State of California to cause cancer, and birth defects or other reproductive harm.

WARNING

Certain components of this vehicle such as air bag modules, seat belt tensioners, adaptive steering columns, and button cell batteries may contain Perchlorate material. Special handling may apply for service or vehicle end of life disposal.

See www.dtsc.ca.gov/hazardouswaste/perchlorate.

WARNING

The driver is always responsible for operating the vehicle in a safe manner and for complying with current statutes and regulations.

It is also essential to maintain and service the vehicle according to Volvo's recommendations as stated in the owner's information and the service and warranty booklet.

If the on-board information differs from the printed owner's manual, the printed information always takes precedence.

Related information

- Accessory installation (p. 37)
- Connecting equipment to the vehicle's data link connector (p. 37)
- Using the Owner's Manual (p. 21)

Accessory installation

We strongly recommend that Volvo owners install only genuine, Volvo-approved accessories, and that accessory installations be performed only by a trained and qualified Volvo service technician. Certain functions only work when the associated software is installed in the vehicle's computer system.

- Genuine Volvo accessories are tested to ensure compatibility with the performance, safety, and emission systems in your vehicle. Additionally, a trained and qualified Volvo service technician knows where accessories may and may not be safely installed in your Volvo. In all cases, please consult a trained and qualified Volvo service technician before installing any accessory in or on your vehicle.
- Accessories that have not been approved by Volvo may or may not be specifically tested for compatibility with your vehicle.
- Any of your vehicle's performance and safety systems could be adversely affected if you install accessories that Volvo has not tested, or if you allow accessories to be installed by someone unfamiliar with your vehicle.
- Damage caused by unapproved or improperly installed accessories may not be covered by your new vehicle warranty. See your Warranty and Service Records Information booklet for more warranty

information. Volvo assumes no responsibility for death, injury, or expenses that may result from the installation of non-genuine accessories.

Related information

- Important information on accessories and extra equipment (p. 36)

Connecting equipment to the vehicle's data link connector

Incorrectly connected or installed software or diagnostic tools may have an adverse effect on the vehicle's electronics.

We strongly recommend that Volvo owners use only genuine, Volvo-approved accessories, and that accessory installations be performed only by a trained and qualified Volvo service technician. Certain accessories only work when the associated software is installed in the vehicle's computer system.

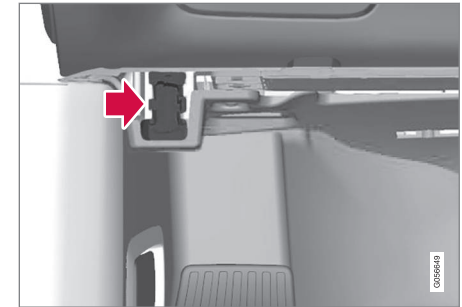

On-board Diagnostic (OBDII) socket under the dashboard on the driver's side.



i NOTE

Volvo Cars takes no responsibility for the consequences of connecting non-authorized equipment to the On-board Diagnostic (OBDII) socket. This socket should only be used by a trained and qualified Volvo service technician.

**Type approval
USA**

FCC ID: 2AGKKACUII-06

This device complies with part 15 of the FCC rules. Operation is subject to the following two conditions:

- (1) This device may not cause harmful interference, and
- (2) this device must accept any interference received, including interference that may cause undesired operation.

⚠ WARNING

Changes or modifications not expressly approved by the party responsible for compliance could void the user's authority to operate the equipment.

Canada

IC: 20839-ACUII06

This device complies with Industry Canada license-exempt RSS standards. Operation is subject to the following two conditions:

- (1) This device may not cause interference, and
- (2) this device must accept any interference received, including interference that may cause undesired operation.

Related information

- Important information on accessories and extra equipment (p. 36)

Technician certification

In addition to Volvo factory training, Volvo supports certification by the National Institute for Automotive Service Excellence (A.S.E.).

Certified technicians have demonstrated a high degree of competence in specific areas. Besides passing exams, each technician must also have worked in the field for two or more years before a certificate is issued. These professional technicians are best able to analyze vehicle problems and perform the necessary maintenance procedures to keep your Volvo at peak operating condition.

Recharge vehicles

Technicians performing work on a vehicle with electrification should also have the necessary training and specialized certification required for performing repairs and/or maintenance on a vehicle with electrification.

⚠ WARNING

A number of electrical components in Recharge vehicles use high-voltage current and can be extremely dangerous if handled incorrectly. These components and any orange wiring in the vehicle may only be handled by trained and qualified Volvo service technicians.

Viewing the Vehicle Identification Number (VIN)

When contacting a Volvo retailer, about e.g. your Volvo On Call subscription, your Vehicle Identification Number (VIN⁵) may be needed.

1. Tap **Settings** in the center display's Top view.
2. Proceed to **System** → **System Information** → **Vehicle Identification Number**.
 - > The vehicle identification number will be displayed.

The VIN can also be found:

- on the first page of the Warranty and Service Records Information booklet
- on the vehicle's registration card
- by looking at the dashboard through the vehicle's windshield.



The VIN has a similar location on all models.

Volvo Structural Parts Statement

Volvo is one of the leading companies for car safety.

Volvo engineers and manufactures vehicles designed to help protect vehicle occupants in the event of a collision.

Volvos are designed to absorb the impact of a collision. This energy absorption system including, but not limited to, structural components such as bumper reinforcement bars, bumper energy absorbers, frames, rails, fender aprons, A-pillars, B-pillars and body panels must work together to maintain cabin integrity and protect the vehicle occupants.

The supplemental restraint system including but not limited to air bags, side curtain air bags, and deployment sensors work together with the above components to provide proper timing for air bag deployment.

Due to the above, Volvo Car USA does not support the use of aftermarket, alternative or anything other than original Volvo parts for collision repair.

Volvo Car USA also recommends using Volvo-approved replacement glass. The use of aftermarket glass, particularly a windshield, can have an adverse effect on collision avoidance and advanced lighting systems.

⁵ Vehicle Identification Number

- ◀ In addition Volvo does not support the use or re-use of structural components from an existing vehicle that has been previously damaged. Although these parts may appear equivalent, it is difficult to tell if the parts have been previously replaced with non-OE parts or if the part has been damaged as a result of a prior collision. The quality of these used parts may also have been affected due to environmental exposure.

Related information

- Data recording (p. 33)

Change of market when importing or relocating

If you import a vehicle or move to another country, it is important that you register the vehicle in the new market to help ensure that online services work correctly, that the vehicle meets local laws and regulations, etc.

Visit an authorized Volvo retailer

Visit an authorized Volvo retailer for assistance registering the vehicle in the new market.

If you do not do this then you may experience that apps, Volvo On Call⁶, software downloads and other online services are affected and do not work correctly.

Creating a new Volvo ID in your new home market

When you relocate to another country you should create a Volvo ID in the new country.

If you have already created a Volvo ID in another country and want to use the same email address, you must first delete your Volvo ID in the region you originally created it. You can also create a new Volvo ID with another email address.

For vehicles with Volvo On Call⁶

Download the Volvo On Call app from the country the vehicle will be used in and link the app to your vehicle.

i NOTE
Visit an authorized Volvo retailer if you have imported or relocated with your vehicle to a new country.
Available services may vary depending on market and vehicle model.

i NOTE
If the vehicle is exported to another market, Volvo is not responsible for any adaptations to the vehicle in order to meet applicable requirements or laws in the country of import. For more information, see the Warranty and Service Records Information booklet or contact your Volvo workshop.

Related information

- Scheduling service and repairs (p. 587)

⁶ Applicable only to markets that have access to Volvo On Call.

Driver distraction

A driver has a responsibility to do everything possible to ensure his or her own safety and the safety of passengers in the vehicle and others sharing the roadway. Part of this responsibility is avoiding distractions, including performing activities that are not directly related to controlling the vehicle in the driving environment.

Your new Volvo is, or can be, equipped with feature-rich entertainment and communication systems. These include hands-free cellular telephones, navigation systems, and multipurpose audio systems. You may also own other portable electronic devices for your own convenience. When used properly and safely, they enrich the driving experience. Improperly used, any of these could cause a distraction.

For all of these systems, we want to provide the following warning that reflects the strong Volvo concern for your safety. Never use these devices or any feature of your vehicle in a way that distracts you from the task of driving safely. Distraction can lead to a serious accident. In addition to this general warning, we offer the following guidance regarding specific new features that may be found in your vehicle:

WARNING

- Never use a hand-held cellular telephone while driving. Some jurisdictions prohibit cellular telephone use by a driver while the vehicle is moving.
- If your vehicle is equipped with a navigation system, set and make changes to your travel itinerary only with the vehicle parked.
- Never program your audio system while the vehicle is moving. Program radio presets with the vehicle parked, and use your programmed presets to make radio use quicker and simpler.
- Never use portable computers or personal digital assistants while the vehicle is moving.

Related information

- Audio, media and Internet (p. 470)

SAFETY

Safety

The vehicle is equipped with a number of safety systems that work together to help protect the vehicle's driver and passengers in the event of an accident.

The vehicle is equipped with a number of sensors that may react in the event of an accident and activate different safety systems, such as the airbag system and seat belt tensioners. Depending on the specific conditions of the accident, e.g. collisions at certain angles, over-turning or swerving, the systems react differently to help provide good protection.

There are also mechanical safety systems such as the Whiplash Protection System. The vehicle is also built so that a large part of the force of a collision is distributed to the vehicle's members, pillars, floor, roof and other parts of the body.

After an accident, the vehicle's safety mode may be activated if any important function in the vehicle has been damaged.

Warning symbol in the instrument panel



The warning symbol in the instrument panel illuminates when the vehicle's electrical system is in ignition mode **II**. The symbol will go out after approx. 6 seconds if no faults are detected in the vehicle's safety systems.

WARNING

If the warning symbol remains illuminated or switches on while driving and the message **SRS airbag Service urgent Drive to workshop** is displayed in the instrument panel, this indicates that something in the safety system is not functioning properly. Volvo recommends contacting an authorized Volvo workshop for repairs as soon as possible.

WARNING

Never attempt to alter or repair any of the vehicle's safety systems yourself. Incorrectly performed repairs to any system could impair function and lead to serious injury. Volvo recommends contacting an authorized Volvo workshop.



If this dedicated warning symbol is not functioning, the general warning symbol will illuminate instead and the same message will be displayed in the instrument panel.

Related information

- Safety during pregnancy (p. 45)
- Occupant safety (p. 45)
- Reporting safety defects (p. 46)
- Recall information (p. 47)
- Seat belts (p. 49)

- Airbags (p. 55)
- Whiplash Protection System (p. 48)
- Safety mode (p. 64)
- Child safety (p. 66)

Safety during pregnancy

It is important that seat belts are worn correctly during pregnancy and that pregnant drivers adjust their seating position accordingly.

Seat belt

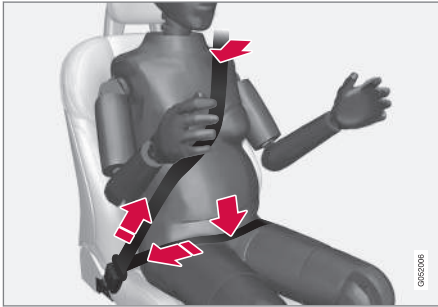

The seat belt should fit closely against the shoulder, with the diagonal section between the breasts and to the side of the stomach.

The lap section of the seat belt should lie flat over the thighs and as far as possible under the stomach. Never let it ride upward. Remove unnecessary slack and make sure the seat belt fits as close as possible to the body. Make sure there are no twists in the seat belt.

Seating position

As pregnancy progresses, pregnant drivers should adjust the seat and steering wheel to a

position that allows them to retain full control of the vehicle (which means they should be able to easily reach the steering wheel and foot pedals). Try to maintain as much distance as possible between the stomach and the steering wheel.

Related information

- Safety (p. 44)
- Seat belts (p. 49)
- Manual front seats (p. 182)
- Power* front seats (p. 183)

Occupant safety

Safety is Volvo's cornerstone.

Volvo's concern for safety

Our concern for safety dates back to 1927 when the first Volvo rolled off the production line. Three-point seat belts (a Volvo invention), safety cages, and energy-absorbing impact zones were designed into Volvo vehicles long before it was fashionable or required by government regulation.

We will not compromise our commitment to safety. We continue to seek out new safety features and to refine those already in our vehicles. You can help. We would appreciate hearing your suggestions about improving automobile safety. We also want to know if you ever have a safety concern with your vehicle. Call us in the U.S. at: 1-800-458-1552 or in Canada at: 1-800-663-8255.



◀ Occupant safety reminders

How safely you drive doesn't depend on how old you are but rather on:

- How well you see.
- Your ability to concentrate.
- How quickly you make decisions under stress to avoid an accident.

The following suggestions are intended to help you cope with the ever changing traffic environment.

- Never drink and drive.
- If you are taking any medication, consult your physician about its potential effects on your driving abilities.
- Take a driver-retraining course.
- Have your eyes checked regularly.
- Keep your windshield and headlights clean.
- Replace wiper blades when they start to leave streaks.
- Take into account the traffic, road, and weather conditions, particularly with regard to stopping distance.
- Never text while driving.
- Refrain from using or minimize the use of a cell phone while driving.

Related information

- Safety (p. 44)
- Reporting safety defects (p. 46)
- Recall information (p. 47)

Reporting safety defects

The following information will help you report any perceived safety-related defects in your vehicle.

Reporting safety defects in the U.S.

If you believe that your vehicle has a defect which could cause a crash or could cause injury or death, you should immediately inform the National Highway Traffic Safety Administration (NHTSA) in addition to notifying Volvo Car USA, LLC. If NHTSA receives similar complaints, it may open an investigation, and if it finds that a safety defect exists in a group of vehicles, it may order a recall and remedy campaign. However, NHTSA cannot become involved in individual problems between you, your retailer, or Volvo Car USA, LLC. To contact NHTSA, you may either call the Auto Safety Hotline tollfree at

1-888-327-4236

(TTY: 1-800-424-9153) or write to: NHTSA, U.S. Department of Transportation, Washington D.C. 20590.

You can also obtain other information about motor vehicle safety from <http://www.safercar.gov>, where you can also enter your vehicle's VIN (Vehicle Identification Number) to see if it has any open recalls.

Volvo strongly recommends that if your vehicle is covered under a service campaign, safety or emission recall or similar action, it should be completed as soon as possible. Please check with your local retailer or Volvo Car USA, LLC if your vehicle is covered under these conditions.

NHTSA can be reached at:

Internet:

<http://www.nhtsa.gov>

Telephone:

1-888-DASH-2-DOT
(1-888-327-4236).

Reporting safety defects in Canada

If you believe your vehicle has a defect that could cause a crash or could cause injury or death, you should immediately inform Transport Canada in addition to notifying Volvo Car Canada Ltd.

Transport Canada can be contacted at:

1-800-333-0510

Teletypewriter (TTY): 613 990-4500

Fax: 1-819-994-3372

Mailing Address: Transport Canada - Road Safety, 80 rue Noël, Gatineau, (Quebec) J8Z 0A1

Related information

- Safety (p. 44)
- Occupant safety (p. 45)
- Recall information (p. 47)
- Viewing the Vehicle Identification Number (VIN) (p. 39)

Recall information

On our website, click the "Owner" tab in the upper left-hand side of the screen and then click on the heading "Recall Information". Enter the vehicle identification number (VIN), which can be found at the bottom of the windshield. If your vehicle has any open Recalls, they will be displayed on this page.

You can also enter the Vehicle Identification Number in the search field on the National Highway Traffic Safety Administration's (NHTSA) website at: www.nhtsa.gov.

Volvo customers in Canada

For any questions regarding open recalls for your vehicle, please contact your authorized Volvo retailer. If your retailer is unable to answer your questions, please contact Volvo Customer Relations at 800-663-8255, Monday through Friday, 8:30 A.M. to 5:00 P.M. EST or volvocars.com/ca. You may also write us at:

Volvo Car Canada Ltd.

Customer Care Centre

9130 Leslie Street, Suite 101

Richmond Hill, Ontario L4B 0B9

www.tc.gc.ca

◀ Related information

- Safety (p. 44)
- Reporting safety defects (p. 46)
- Occupant safety (p. 45)

Whiplash Protection System

The Whiplash Protection System (WHIPS) is designed to help reduce the risk of whiplash-type injuries. The system consists of energy absorbing backrests and seat cushions as well as specially designed head restraints in the front seats.

WHIPS is activated in the event of a rear-end collision and adapted to the angle and speed of the collision and to the characteristics of the colliding vehicle.

When WHIPS is activated, the front seat backrests move rearward and the seat cushions move downward to change the seating positions of the driver and front seat passenger. This movement helps absorb some of the forces that could result in whiplash.

⚠ WARNING

WHIPS is a supplement to the seat belt. Always wear your seat belt.

⚠ WARNING

Do not attempt to alter or repair the seat or WHIPS on your own. Volvo recommends contacting an authorized Volvo workshop.

If the front seats have been subjected to severe stress, e.g. in a collision, the seats must be replaced. Even if the seats appear undamaged, some of their protective properties may have been lost.

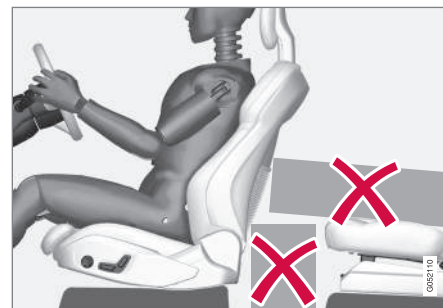

Do not place any objects on the floor behind or under the front seats or on the rear seat that could prevent WHIPS from functioning correctly.

⚠ WARNING

Do not squeeze box-like cargo between the rear seat cushion and the front seat backrest.

If the rear seat backrests are folded down, cargo must be secured to prevent it from sliding forward against the front seat backrests in the event of a collision.

⚠ WARNING

If a rear seat backrest is folded down or if a rear-facing child restraint is being used in the rear seat, the seat in front must be moved forward so that it does not come into contact with the backrest or child restraint.

- Power* front seats (p. 183)
- Rear Collision Warning* (p. 341)

Seating position

For WHIPS to provide good protection, the driver and passenger must be seated correctly and the system's function must not be impeded in any way.

Set the front seat to the correct seating position before starting to drive.

The driver and the front seat passenger should sit in the center of the seat with their heads as close as possible to the head restraints.

Related information

- Safety (p. 44)
- Manual front seats (p. 182)

Seat belts

Seat belts should always be worn by all occupants in your vehicle. Children should be properly restrained using an infant seat, adjustable child seat or booster cushion as determined by age, weight and height.

Most states and provinces make it mandatory for occupants of a vehicle to use seat belts.

Seat belt maintenance

Check periodically that the seat belts are in good condition. Use water and a mild detergent for cleaning. Check the seat belt mechanism's function as follows: attach the seat belt and pull rapidly on the strap.





WARNING

- Never repair the belt yourself. Repairs should only be performed by a trained and qualified Volvo service technician.
- Any device used to induce slack into the shoulder belt portion of the three-point belt system will have a detrimental effect on the amount of protection available in the event of a collision.
- The seat back should not be tilted too far back. The shoulder belt must be taut in order to function properly.
- Do not use any type of child restraint in the front passenger seat. We recommend that children who have outgrown these devices sit in the rear seat with the seat belt properly fastened.

Related information

- Safety (p. 44)
- Seat belt tensioners (p. 52)
- Buckling and unbuckling seat belts (p. 50)
- Door and seat belt reminders (p. 54)

Buckling and unbuckling seat belts

Make sure that all passengers have buckled their seat belts before starting to drive.

Buckling seat belts

1. Pull out the belt slowly and make sure it is not twisted or damaged.

NOTE

The seat belt is equipped with a seat belt retractor that will lock up in the following situations:

- if the belt is pulled out too quickly.
- during braking and acceleration.
- if the vehicle is leaning excessively.
- when driving in turns.
- if the automatic locking retractor/emergency locking retractor (ALR/ELR) is activated. Each seat belt (except for the driver's) is equipped with an ALR function, which is designed to keep the seat belt taut when installing a child restraint. ALR is activated when the seat belt is pulled out as far as possible. If this is done, a sound from the seat belt retractor will be audible, which is normal. The seat belt can now only be fed into the retractor, not pulled out. This function is automatically disabled when the seat belt is unbuckled and fully retracted.

2. Buckle the seat belt by pushing the latch plate into the receptacle.
 - > A distinct "click" indicates that the belt is locked into place.

WARNING

Always insert the seat belt latch plate into the belt buckle on the correct side. Failure to do so could cause the seat belts and belt buckles to malfunction in a collision. There is a risk of serious injury.

3. The height of the seat belts in the front seats can be adjusted.



Press the button on the seat belt holder and move the belt up or down.

Position the belt as high as possible without it chafing against the neck.

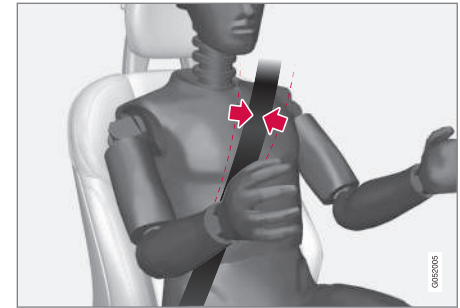

The belt should be positioned closely over the shoulder (against the collarbone, not down over the arm).

4. Tighten the lap section of the seat belt over the hips by pulling the diagonal section upward toward the shoulder.

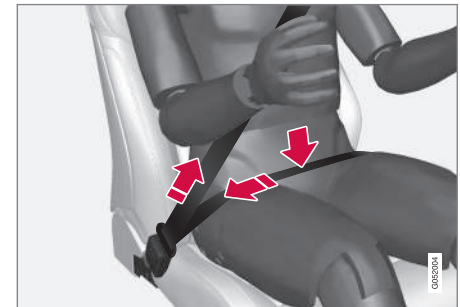

The lap section of the seat belt should be positioned low on the hips (not against the abdomen).



WARNING

Never use a seat belt for more than one occupant. Never wear the shoulder portion of the belt under the arm, behind the back or otherwise out of position. Such use could cause injury in the event of an accident. As seat belts lose much of their strength when exposed to violent stretching, they should be replaced after any collision, even if they appear to be undamaged.

WARNING

Do not use clips or fasten the belts around hooks or other parts of the interior. This will prevent the seat belt from fitting properly.

WARNING

Never damage the seat belts and never insert any foreign objects into the belt buckle. This may cause the seat belts and belt buckles to malfunction in a collision. There is a risk of serious injury.

Unbuckling seat belts

1. Press the red button on the seat belt receptacle and make sure the seat belt retracts fully into the retractor slot.
2. If it does not fully retract, guide the belt manually into the slot and make sure it does not hang loose.

Related information

- Seat belts (p. 49)
- Seat belt tensioners (p. 52)
- Door and seat belt reminders (p. 54)

Seat belt tensioners

The vehicle is equipped with standard and electric* seat belt tensioners that can help tension the seat belt in a critical situation or collision.

Standard seat belt tensioners

All seat belts are equipped with a standard seat belt tensioner.

In a collision of sufficiently violent force, the seat belt tensioners will tension the seat belts in order to more effectively restrain the occupants.

Electric seat belt tensioners*

The driver's and front passenger's seat belts are equipped with electric seat belt tensioners.

The seat belt tensioners interact and can be activated in conjunction with the City Safety and Rear Collision Warning driver support systems. In critical situations, such as if the vehicle brakes suddenly, begins to skid or runs off the road (e.g. if the vehicle rolls into a ditch, lifts off the ground or hits an obstacle in the road), or if there is a risk of collision, the seat belts can be pulled taut by the seat belt tensioner's electric motor.

The electric seat belt tensioner helps to position the occupant more effectively in the seat, which reduces the risk of the occupant striking the interior of the passenger compartment

and improves the effect of other safety systems such as the airbags.

When a critical situation has passed, the seat belt and the electric seat belt tensioner are reset automatically. However, they can also be reset manually.

CAUTION

If the passenger airbag is deactivated, the passenger-side electric seat belt tensioner may also be deactivated.

WARNING

Never attempt to alter or repair the seat belt on your own. Volvo recommends contacting an authorized Volvo workshop.

If the seat belt has been exposed to extreme forces, e.g. in conjunction with a collision, the entire seat belt must be replaced. Even if the seat belt appears undamaged, some of its protective properties may have been lost. Also replace the seat belt if it is worn or damaged. The new seat belt must be type approved and intended for the same seating position as the replaced seat belt.

Related information

- Seat belts (p. 49)
- Buckling and unbuckling seat belts (p. 50)

- Resetting the electric seat belt tensioners* (p. 53)
- City Safety™ (p. 321)
- Rear Collision Warning* (p. 341)

Resetting the electric seat belt tensioners*

The electric seat belt tensioners are designed to be reset automatically, but if the seat belt remains taut it can be reset manually.

1. Stop the vehicle in a safe location.
2. Unbuckle the seat belt and then rebuckle it.
 - > The seat belt and the electric seat belt tensioner will be reset.

WARNING

Never attempt to alter or repair the seat belt on your own. Volvo recommends contacting an authorized Volvo workshop.

If the seat belt has been exposed to extreme forces, e.g. in conjunction with a collision, the entire seat belt must be replaced. Even if the seat belt appears undamaged, some of its protective properties may have been lost. Also replace the seat belt if it is worn or damaged. The new seat belt must be type approved and intended for the same seating position as the replaced seat belt.

Related information

- Seat belt tensioners (p. 52)
- Seat belts (p. 49)

Door and seat belt reminders

This system is intended to remind occupants to buckle their seat belts and to alert the driver if a door, hood or other opening (trunk, sunroof, etc.) is open.

Graphics in the instrument panel

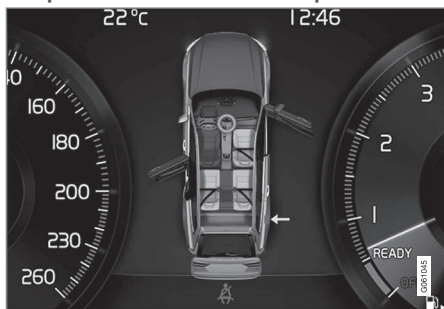

Graphics in the instrument panel with various types of warnings. The warning colors for the doors/tailgate vary depending on the vehicle's speed.

The instrument panel graphic shows the seats where seat belts are buckled and not buckled.

The same graphic also indicates if the hood, tailgate, fuel filler door or any door is open.

Confirm the graphic by briefly pressing the **O** button on the right-side steering wheel keypad.

Seat belt reminder



Reminder light in ceiling console.

A seat belt reminder light illuminates in the ceiling console and a warning symbol is displayed in the instrument panel.

The audible reminder varies depending on the vehicle's speed, driving time and distance driven.

A seat belt status graphic in the instrument panel indicates when the driver's or a passenger's seat belt is buckled or unbuckled.

Child seats are not included in the seat belt reminder system.

Front seats

An audible signal and an indicator light remind unbuckled occupants to fasten their seat belts.

Rear seat

The rear seat belt reminder has two functions:

- To indicate which seat belts are buckled in the rear seats. This will also be displayed in an instrument panel graphic.
- To provide audio and visual reminders if any seat belt in the rear seat is removed while the vehicle is in motion. The reminder will stop when the seat belt has been re buckled.

Door/hood/tailgate and fuel filler door reminder

If the hood, tailgate, fuel filler door or any door is not properly closed, this will be indicated by a graphic in the instrument panel. Stop the vehicle safely and close the open door, hood, etc.



If the vehicle is moving at a speed under approx. 10 km/h (6 mph), the information symbol will illuminate in the instrument panel.



If the vehicle is moving at a speed above approx. 10 km/h (6 mph), the warning symbol will illuminate in the instrument panel.

Related information

- Seat belts (p. 49)
- Buckling and unbuckling seat belts (p. 50)

Airbags

The vehicle is equipped with airbags and inflatable curtains for the driver and passengers.

WARNING

- If the airbag warning light stays on after the engine has started or if it illuminates while you are driving, have the vehicle inspected by a trained and qualified Volvo service technician as soon as possible.
- Never attempt to alter or repair any of the vehicle's safety systems yourself. Incorrectly performed repairs to any system could impair function and lead to serious injury. All work on these systems should be performed by a trained and qualified Volvo service technician.

WARNING

If your vehicle has become water-damaged in any way (e.g., soaked floor mats/standing water on the floor of the vehicle), do not attempt to start the engine. This may cause airbag deployment, which could result in serious injury. Volvo recommends towing the vehicle directly to an authorized Volvo workshop.

Before attempting to tow the vehicle:

1. Switch off the ignition for at least 10 minutes and disconnect the battery.
2. Follow the instructions for manually overriding the shiftlock system.

Deployed airbags

WARNING

If any of the airbags have deployed:

- Do not attempt to drive the vehicle. Have it towed to an authorized workshop.
- If necessary, seek medical attention.

Related information

- Safety (p. 44)
- Driver/passenger side front airbags (p. 56)
- Side airbags (p. 62)

- Inflatable curtain (p. 63)

Driver/passenger side front airbags

As a supplement to the seat belts, the vehicle is equipped with driver and passenger side front airbags.



Driver/passenger side front airbags.

In a frontal collision, the airbags help protect the driver's and passenger's head, neck, face and chest and the driver's knees and legs.

A collision of a sufficiently violent force will trigger the sensors and one or more airbags will inflate. The airbag helps cushion the initial impact of the collision for the passenger. The airbag deflates when compressed by the collision. A small amount of powder will also be released from the airbag. This may appear to be smoke and is normal. The entire process, from inflation to deflation of the airbag, occurs within tenths of a second.

i NOTE

The sensors react differently depending on the circumstances of the accident and whether or not the seat belt is used. This applies to all belt positions.

There may therefore be accident situations in which only one (or none) of the airbags are deployed. The sensors monitor the impact of the collision and react accordingly to deploy one, several or no airbags.

⚠ WARNING

The seat belt and the airbag work together. If the seat belt is not used or is used incorrectly, the airbag may not provide the intended protection in a collision.

To help prevent injury in the event the airbag is deployed, passengers should sit as upright as possible, with their feet on the floor and their backs against the seat backrest.

⚠ WARNING

Volvo recommends contacting an authorized Volvo workshop for repairs. Incorrectly performed repairs to the airbag system could impair function and lead to serious injury.

The front airbag system

The front airbag system includes gas generators surrounded by the airbags, and deceleration sensors that activate the gas generators, causing the airbags to be inflated with nitrogen gas.

As the movement of the seats' occupants compresses the airbags, some of the gas is expelled at a controlled rate to provide better cushioning. The belt tensioners minimize slack in the seat belts and are activated for occupants wearing their seat belts. The entire process, from inflation to deflation of the airbag, occurs within tenths of a second.

The location of the front airbags is indicated by **SRS AIRBAG** embossed on the steering wheel pad and above the glove compartment, and by decals on both sun visors and on the front and far right side of the dash.

The **driver's side front airbag** is folded and located in the steering wheel hub.

The **knee airbag** is folded on the underside of the dashboard on the driver's side. The text **AIRBAG** is embossed on the panel.

The **passenger's side front airbag** is folded behind a panel located above the glove compartment.

⚠ WARNING

- The airbags in the vehicle are designed to be a SUPPLEMENT to-not a replacement for-the three-point seat belts. For maximum protection, wear seat belts at all times. Be aware that no system can prevent all possible injuries that may occur in an accident.
- Never drive with your hands on the steering wheel pad/airbag housing.
- The front airbags are designed to help prevent serious injury. Deployment occurs very quickly and with considerable force. During normal deployment and depending on variables such as seating position, one may experience abrasions, bruises, swellings, or other injuries as a result of deployment of one or both of the airbags.
- When installing any accessory equipment, make sure that the front airbag system is not damaged. Any interference in the system could cause malfunction.

Front airbag deployment

- The front airbags are designed to deploy during certain frontal or front-angular collisions, impacts, or decelerations, depending on the crash severity, angle, speed and object impacted. The airbags may also

deploy in certain non-frontal collisions where rapid deceleration occurs.

- The airbag system's sensors, which trigger the front airbags, are designed to determine if the collision is powerful enough to activate the belt tensioners and/or the airbags.

However, not all frontal collisions activate the front airbags.

- If the collision involves a nonrigid object (e.g., a snow drift or bush), or a rigid, fixed object at a low speed, the front airbags will not necessarily deploy.
- Front airbags do not normally deploy in a side impact collision, in a collision from the rear or in a rollover situation.
- The amount of damage to the bodywork does not reliably indicate if the airbags should have deployed or not.

i NOTE

- Deployment of front airbags occurs only one time during an accident. In a collision where deployment occurs, the airbags and seat belt tensioners activate. Some noise occurs and a small amount of powder is released. The release of the powder may appear as smoke-like matter. This is a normal characteristic and does not indicate fire.
- Volvo's front airbags use special sensors that are integrated with the front seat buckles. The point at which the airbag deploys is determined by whether or not the seat belt is being used, as well as the severity of the collision.
- Collisions can occur where only one of the airbags deploys. If the impact is less severe, but severe enough to present a clear injury risk, the airbags are triggered at partial capacity. If the impact is more severe, the airbags are triggered at full capacity.



⚠️ WARNING

- Do not use child safety seats or child booster cushions/backrests in the front passenger's seat. We also recommend that occupants under 140 cm (4 feet 7 inches) in height who have outgrown these devices sit in the rear seat with the seat belt fastened. See also the Occupant Weight Sensor information.
- Never drive with the airbags deployed. The fact that they hang out can impair the steering of your vehicle. Other safety systems can also be damaged.
- The smoke and dust formed when the airbags are deployed can cause skin and eye irritation in the event of prolonged exposure.

Should you have questions about any component in the SRS system, please contact a trained and qualified Volvo service technician or Volvo customer support:

In the United States

Volvo Car USA, LLC

Customer Care Center

1 Volvo Drive

P.O. Box 914

Rockleigh, New Jersey 07647

1-800-458-1552

www.volvocars.com/us

In Canada

Volvo Car Canada Ltd.

Customer Care Centre

9130 Leslie Street, Suite 101

Richmond Hill, Ontario L4B 0B9

1-800-663-8255

www.volvocars.com/ca

Airbag decals



Airbag decal on the outside of both sun visors.

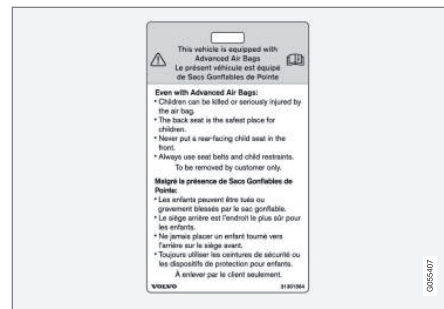

Passenger's side airbag decal.

⚠️ WARNING

- Children must never be allowed in the front passenger's seat.
- Occupants in the front passenger's seat must never sit on the edge of the seat, sit leaning toward the instrument panel or otherwise sit out of position.
- The occupant's back must be as upright as comfort allows and be against the seat back with the seat belt properly fastened.
- Feet must be on the floor, e.g., not on the dash, seat or out of the window.

WARNING

- No objects or accessory equipment, e.g. dashboard covers, may be placed on, attached to, or installed near the air bag cover (the area above the glove compartment) or the area affected by airbag deployment.
- There should be no loose articles, such as coffee cups on the floor, seat, or dashboard area.
- Never try to open the airbag cover on the steering wheel or the passenger's side dashboard. This should only be done by a trained and qualified Volvo service technician.
- Failure to follow these instructions can result in injury to the vehicle's occupants.

Related information

- Airbags (p. 55)
- Occupant weight sensor (p. 59)

Occupant weight sensor

The Occupant Weight Sensor (OWS) is designed to meet the regulatory requirements of Federal Motor Vehicle Safety Standard (FMVSS) 208 and is designed to disable (will not inflate) the passenger's side front airbag under certain conditions.

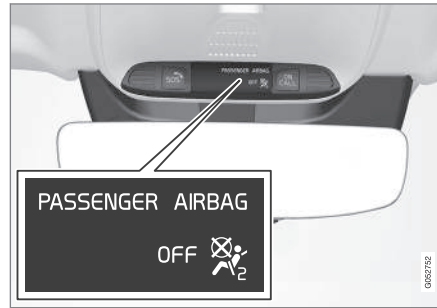

Occupant Weight Sensor (OWS) indicator light

Disabling the passenger's side front airbag

Volvo recommends that ALL occupants (adults and children) shorter than 140 cm (4 feet 7 inches) be seated in the back seat of any vehicle with a front passenger side airbag and be properly restrained for their size and weight.

The OWS works with sensors that are part of the front passenger's seat and seat belt. The sensors are designed to detect the presence

of a properly seated occupant and determine if the passenger's side front airbag should be enabled (may inflate) or disabled (will not inflate).

The OWS will disable (will not inflate) the passenger's side front airbag when:

- the front passenger's seat is unoccupied, or has small/medium objects in the front seat,
- the system determines that an infant is present in a rear-facing infant seat that is installed according to the manufacturer's instructions,
- the system determines that a small child is present in a forward-facing child restraint that is installed according to the manufacturer's instructions,
- the system determines that a small child is present in a booster seat,
- a child or a small person occupies the front passenger's seat.

The OWS uses a PASSENGER AIRBAG OFF indicator lamp which will illuminate and stay on to remind you that the passenger's side front airbag is disabled. The PASSENGER AIRBAG OFF indicator lamp is located in the overhead console, near the base of the rear-view mirror.



i NOTE

When the ignition is switched on, the OWS indicator light will illuminate for several seconds while the system performs a self-diagnostic test.

However, if a fault is detected in the system:

- The OWS indicator light will stay on
- The SRS warning light will come on and stay on and a text message will be displayed.

⚠ WARNING

If a fault in the system is detected and indicated as described, be aware that the passenger's side front airbag will not deploy in the event of a collision. In this case, the SRS system and Occupant Weight Sensor should be inspected by a trained and qualified Volvo service technician as soon as possible.

⚠ WARNING

- Never try to open, remove or repair any components in the OWS system. This could cause the system to malfunction. Maintenance or repairs should only be carried out by an a trained and qualified Volvo service technician.
- The front passenger's seat should not be modified in any way. This could reduce pressure on the seat cushion, which might interfere with the OWS system's function.

Passenger's seat occupancy status	OWS indicator light status	Passenger's side front airbag status
Seat unoccupied	OWS indicator light up	Passenger's side front airbag disabled
Seat occupied by low weight occupant/object ^A	OWS indicator light up	Passenger's side front airbag disabled
Seat occupied by heavy occupant/object	OWS indicator light is not lit	Passenger's side front airbag enabled

^A Volvo recommends that children always be properly restrained in appropriate child restraints in the rear seats. Do not assume that the passenger's side front airbag is disabled unless the PASSENGER AIRBAG OFF indicator lamp is lit. Make sure the child restraint is properly installed. If there is any doubt as to the status of the passenger's side front airbag, move the child restraint to the rear seat.

The OWS is designed to enable (may inflate) the passenger's side front airbag in the event of a collision anytime the system senses that a person of adult size is sitting properly in the front passenger's seat. The PASSENGER AIRBAG OFF indicator lamp will be off and remain off.

If a person of adult size is sitting in the front passenger's seat, but the PASSENGER AIR-

BAG OFF indicator lamp is on, it is possible that the person isn't sitting properly in the seat. If this happens:

- Turn the vehicle off and ask the person to place the backrest in an upright position.
- Have the person sit upright in the seat, centered on the seat cushion, with the person's legs comfortably extended.
- Restart the vehicle and have the person remain in this position for about two minutes. This will allow the system to detect that person and enable the passenger's frontal airbag.
- If the PASSENGER AIRBAG OFF indicator lamp remains on even after this, the person should be advised to ride in the rear seat.

This indicates limitations in OWS classification capability. It does not indicate OWS malfunction.

Modifications

If you are considering modifying your vehicle in any way to accommodate a disability, for example by altering or adapting the driver's or front passenger's seat(s) and/or airbag systems, please contact Volvo at:

In the United States

Volvo Car USA, LLC
Customer Care Center

1 Volvo Drive
P.O. Box 914
Rockleigh, New Jersey 07647
1-800-458-1552

In Canada

Volvo Car Canada Ltd.
Customer Care Centre
9130 Leslie Street, Suite 101
Richmond Hill, Ontario L4B 0B9
1-800-663-8255



WARNING

- No objects that add to the total weight on the seat should be placed on the front passenger's seat. If a child is seated in the front passenger's seat with any additional weight, this extra weight could cause the OWS system to enable the airbag, which might cause it to deploy in the event of a collision, thereby injuring the child.
- The seat belt should never be wrapped around an object on the front passenger's seat. This could interfere with the OWS system's function.
- The front passenger's seat belt should never be used in a way that exerts more pressure on the passenger than normal. This could increase the pressure exerted on the weight sensor by a child, and could result in the airbag being enabled, which might cause it to deploy in the event of a collision, thereby injuring the child.



⚠️ WARNING

- Keep the following points in mind with respect to the OWS system. Failure to follow these instructions could adversely affect the system's function and result in serious injury to the occupant of the front passenger's seat.
- The full weight of the front seat passenger should always be on the seat cushion. The passenger should never lift him/herself off the seat cushion using the armrest in the door or the center console, by pressing the feet on the floor, by sitting on the edge of the seat cushion, or by pressing against the backrest in a way that reduces pressure on the seat cushion. This could cause OWS to disable the front, passenger's side airbag.

⚠️ WARNING

- Do not place any type of object on the front passenger's seat in such a way that jamming, pressing, or squeezing occurs between the object and the front seat, other than as a direct result of the correct use of the Automatic Locking Retractor/Emergency Locking Retractor (ALR/ELR) seat belt.
- No objects should be placed under the front passenger's seat. This could interfere with the OWS system's function.

Related information

- Driver/passenger side front airbags (p. 56)

Side airbags

The side airbags, on the driver's and passenger sides, protect the chest and hip in a collision.



The side airbags are located in the front seats' outer backrest frames and help protect the driver and front seat passenger.

A collision of a sufficiently violent force will trigger the sensors and one or more side airbags will inflate. The side airbags inflate between the seat occupant and the door panel to help cushion the initial impact of the collision. The airbag deflates when compressed by the collision. The side airbags are normally only deployed on the side of the vehicle impacted by the collision.

⚠ WARNING

Volvo recommends contacting an authorized Volvo workshop for repairs. Incorrectly performed repairs to the side airbag system could impair function and lead to serious injury.

⚠ WARNING

Do not place any objects in the area between the outer edges of the seats and the door panels, as this could impair the function of the side airbags.

Volvo recommends only using seat covers approved by Volvo. Other seat covers could prevent the side airbags from functioning properly.

⚠ WARNING

The side airbag is a supplement to the seat belt. Always wear your seat belt.

Related information

- Airbags (p. 55)

Inflatable curtain

The inflatable curtain, Inflatable Curtain (IC), helps to prevent the driver and passengers from striking their heads on the inside of the vehicle during a collision.

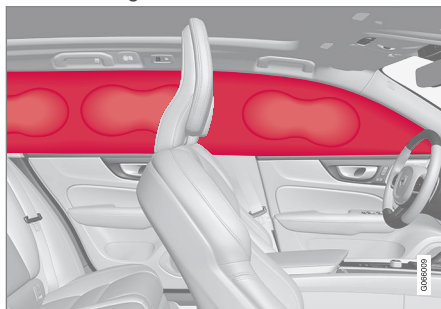

The inflatable curtains are installed along both sides of the inside of the roof and help protect occupants in the vehicle's outer seats. **IC AIRBAG** is embossed on the panels.

A collision of a sufficiently violent force will trigger the sensors and the inflatable curtain will inflate.

⚠ WARNING

Volvo recommends contacting an authorized Volvo workshop for repair. Incorrectly performed repairs to the inflatable curtain system could impair function and lead to serious injury.

⚠ WARNING

Never hang or attach heavy objects in the handle in the ceiling. The hooks are only intended for lightweight garments (not for hard objects such as umbrellas).

Never screw or mount anything to the vehicle's headlining, door pillars or side panels. This could impair the intended protective properties. Volvo recommends only using Volvo original parts that are approved for placement in these areas.

⚠ WARNING

If objects are loaded higher than the upper edge of the side windows, leave a 10 cm (4 in.) space between the objects and the window. Objects placed closer to this could impede the function of the inflatable curtain concealed inside the headlining.

⚠ WARNING

The inflatable curtain is a supplement to the seat belt. Always wear your seat belt.

◀ Related information

- Airbags (p. 55)

Safety mode

Safety mode is a feature that is triggered after a collision if there is potential damage to an important function in the vehicle, such as the fuel lines, sensors for one of the safety systems, the brake system, etc.

If the vehicle has been involved in a collision, the text **Safety mode See Owner's manual** may appear in the instrument panel along with the warning symbol if the panel is undamaged and the vehicle's electrical system is intact.

The message indicates that one or more of the vehicle's functions may be reduced.

WARNING

Never attempt to restart the vehicle if you smell fuel fumes when the message **Safety mode See Owner's manual** is displayed in the instrument panel. Leave the vehicle immediately.

If safety mode has been set, it may be possible to reset the system in order to start and move the vehicle a short distance, for example, if it is blocking traffic.

WARNING

Never attempt to perform repairs or reset electrical components on your own after the vehicle has been in safety mode. This could result in injury or prevent the vehicle from functioning properly. Volvo recommends having the vehicle inspected and reset to normal operating status by an authorized Volvo workshop after **Safety mode See Owner's manual** has been displayed.

WARNING

When the vehicle is in safety mode, it should not be towed behind another vehicle. It should be towed from the site on a tow truck. Volvo recommends towing the vehicle directly to an authorized Volvo workshop.

Related information

- Safety (p. 44)
- Starting and moving the vehicle when it is in safety mode (p. 65)
- Recovery (p. 462)

Starting and moving the vehicle when it is in safety mode

If safety mode has been set, it may be possible to reset the system in order to start and move the vehicle a short distance, for example, if it is blocking traffic.

Starting the vehicle when it is in safety mode

1. Check the vehicle for damage, particularly for fuel leakage. Make sure you do not detect any gasoline fumes.

If the damage to the vehicle is minor and there is no fuel leakage/fumes, you may attempt to start the engine.

WARNING

Never attempt to restart the vehicle if you smell fuel fumes when the message **Safety mode See Owner's manual** is displayed in the instrument panel. Leave the vehicle immediately.

2. Switch off the ignition.

3. Then try to start the vehicle.
 - > The vehicle's electrical system will perform a system check and then attempt to reset to normal operating mode. The message **Vehicle start System check, wait** will be displayed on the instrument panel during the check. This may take up to a minute.
4. When **Vehicle start System check, wait** is no longer displayed in the instrument panel, try again to start the vehicle.

CAUTION

If the message **Safety mode See Owner's manual** is still displayed, the vehicle should not be driven or towed behind another vehicle. If the vehicle needs to be moved, it must be towed on a tow truck. Even if no damage is apparent, there may be hidden damage that could make the vehicle impossible to control.

Moving the vehicle when it is in safety mode

1. If the message **Normal mode The car is now in normal mode** is displayed after attempting to start the engine, the vehicle may be moved carefully from its present position if, for example, it is blocking traffic.
2. Do not move the vehicle farther than absolutely necessary.

WARNING

When the vehicle is in safety mode, it should not be towed behind another vehicle. It should be towed from the site on a tow truck. Volvo recommends towing the vehicle directly to an authorized Volvo workshop.

Related information

- Safety mode (p. 64)
- Starting the vehicle (p. 412)
- Recovery (p. 462)

Child safety

Children should always be seated safely when traveling in the vehicle.

General information

Volvo recommends the proper use of restraint systems for all occupants including children. Remember that, regardless of age and size, a child should always be properly restrained in a vehicle.

Your vehicle is also equipped with ISOFIX/LATCH attachments, which make it more convenient to install child seats.

Some restraint systems for children are designed to be secured in the vehicle by lap belts or the lap portion of a lap-shoulder belt. Such child restraint systems can help protect children in vehicles in the event of an accident only if they are used properly. However, children could be endangered in a crash if the child restraints are not properly secured in the vehicle. Failure to follow the installation instructions for your child restraint can result in your child striking the vehicle's interior in a sudden stop.

Holding a child in your arms is NOT a suitable substitute for a child restraint system. In an accident, a child held in a person's arms can be crushed between the vehicle's interior and an unrestrained person. The child could also be injured by striking the interior, or by being

ejected from the vehicle during a sudden maneuver or impact. The same can also happen if the infant or child rides unrestrained on the seat. Other occupants should also be properly restrained to help reduce the chance of injuring or increasing the injury of a child.

All states and provinces have legislation governing how and where children should be carried in a vehicle. Find out the regulations existing in your state or province. Recent accident statistics have shown that children are safer in rear seating positions than front seating positions when properly restrained. A child restraint system can help protect a child in a vehicle. Here's what to look for when selecting a child restraint system:

It should have a label certifying that it meets applicable Federal Motor Vehicle Safety Standards (FMVSS 213) - or in Canada, CMVSS 213.

Make sure the child restraint system is approved for the child's height, weight and development - the label required by the standard or regulation, or instructions for infant restraints, typically provide this information.

In using any child restraint system, we urge you to carefully look over the instructions that are provided with the restraint. Be sure you understand them and can use the device properly and safely in this vehicle. A misused child restraint system can result in increased inju-

ries for both the infant or child and other occupants in the vehicle.

When a child has outgrown the child safety seat, you should use the rear seat with the standard seat belt fastened. The best way to help protect the child here is to place the child on a cushion so that the seat belt is properly located on the hips. Legislation in your state or province may mandate the use of a child seat or cushion in combination with the seat belt, depending on the child's age and/or size. Please check local regulations.

A specially designed and tested booster cushion and backrest can be obtained from your Volvo retailer. See also the article "Integrated booster cushion."



⚠ WARNING

- Do not use child safety seats or child booster cushions/backrests in the front passenger's seat. We also recommend that children under 140 cm (4 feet 7 inches) in height who have outgrown these devices sit in the rear seat with the seat belt fastened.
- On hot days, the temperature in the vehicle interior can rise very quickly. Exposure to these high temperatures for even a short period of time can cause heat-related injury or death. Small children are particularly at risk. Never leave children unattended in a vehicle.

Child seats should always be registered.

Volvo's recommendations

Why does Volvo believe that no child should sit in the front seat of a vehicle? It's quite simple really. A front airbag is a very powerful device designed, by law, to help protect an adult.

Because of the size of the airbag and its speed of inflation, a child should never be placed in the front seat, even if he or she is properly belted or strapped into a child safety seat. Volvo has been an innovator in the field of safety since it was founded. And we have no inten-

tion of resting on our laurels. But we need your help. Please remember to put your children in the back seat, and buckle them up.

⚠ WARNING

A child restraint should never be reused if:

- The vehicle has been involved in a collision, no matter how minor
- Its history is unknown
- It is older than the manufacturer's expiration date

Volvo has some very specific recommendations

- Always wear your seat belt.
- Airbags are a SUPPLEMENTAL safety device which, when used with a three-point seat belt can help reduce serious injuries during certain types of accidents. Volvo recommends that you do not disconnect the airbag system in your vehicle.
- Volvo strongly recommends that everyone in the vehicle be properly restrained.
- Volvo recommends that ALL occupants (adults and children) shorter than 140 cm (4 feet 7 inches) be seated in the rear seat of any vehicle with a front passenger side airbag.
- Drive safely!

Related information

- Safety (p. 44)
- Child restraints (p. 68)
- Activating and deactivating child locks (p. 257)

Child restraints

Suitable child restraints should always be used when children travel in the vehicle.

Child restraint systems



Infant seat

There are three main types of child restraint systems: infant seats, convertible seats and booster cushions. They are classified according to the child's age and size.

The child restraint should be secured using a three-point seat belt, ISOFIX/LATCH anchors or top tether anchors.

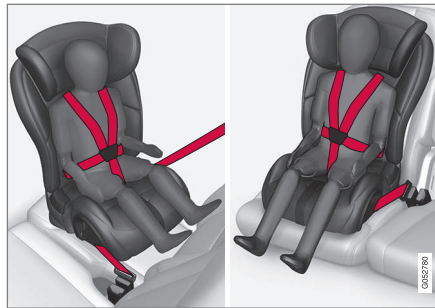

Convertible seat

WARNING

A child seat should never be used in the front passenger seat of any vehicle with a front passenger airbag - not even if the "Passenger airbag off" symbol near the rear-view mirror is illuminated. If the severity of an accident were to cause the airbag to inflate, this could lead to serious injury or death to a child seated in this position.



Booster cushion

WARNING

Always refer to the child restraint manufacturer's instructions for detailed information on securing the restraint.

⚠ WARNING

- When not in use, keep the child restraint system secured or remove it from the passenger compartment to help prevent it from injuring passengers in the event of a sudden stop or collision.
- A small child's head represents a considerable part of its total weight and its neck is still very weak. Volvo recommends that children up to age 4 travel, properly restrained, facing rearward. In addition, Volvo recommends that children should ride rearward facing, properly restrained, as long as possible.

ⓘ NOTE

Prolonged installation and use of the child restraint may damage the vehicle's interior. Volvo recommends using the kick guard accessory to help protect the vehicle's interior.

**Automatic Locking Retractor/
Emergency Locking Retractor (ALR/
ELR)**

To make child seat installation easier, each seat belt (except for the driver's belt) is equipped with a locking mechanism to help keep the seat belt taut.

When attaching the seat belt to a child seat:

1. Attach the seat belt to the child seat according to the child seat manufacturer's instructions.
2. Pull the seat belt out as far as possible.
3. Insert the seat belt latch plate into the buckle (lock) in the usual way.
4. Release the seat belt and pull it taut around the child seat.

A sound from the seat belt retractor will be audible at this time and is normal. The belt will now be locked in place. This function is automatically disabled when the seat belt is unlocked and the belt is fully retracted.

⚠ WARNING

Do not use child safety seats or child booster cushions/backrests in the front passenger's seat. We also recommend that children who have outgrown these devices sit in the rear seat with the seat belt properly fastened.

Child restraint registration and recalls

Child restraints could be recalled for safety reasons. You must register your child restraint to be reached in a recall. To stay informed about child safety seat recalls, be sure to fill

out and return the registration card that comes with new child restraints.

Child restraint recall information is readily available in both the U.S. and Canada. For recall information in the U.S., call the U.S. Government's Auto Safety Hotline at 1-800-424-9393 or go to <http://www-odi.nhtsa.dot.gov/cars/problems/recalls/register/childseat/index.cfm>. In Canada, visit Transport Canada's Child Safety website at <http://www.tc.gc.ca/roadsafety/childsafety/menu.htm>.

Related information

- Child safety (p. 66)
- Infant seats (p. 70)
- Convertible seats (p. 72)
- Booster cushions (p. 74)
- Top tether anchors (p. 75)
- Lower child seat attachment points (p. 77)
- ISOFIX/LATCH lower anchors (p. 77)

Infant seats

Suitable child restraints should always be used when children (depending on their age/size) are seated in the vehicle.

Securing an infant seat with a seat belt



Do not place the infant seat in the front passenger's seat

1. Place the infant seat in the rear seat of the vehicle.
2. Attach the seat belt to the infant seat according to the child restraint manufacturer's instructions.



Route the seat belt through the infant seat.

WARNING

- An infant seat must be in the rear-facing position only.
- The infant seat should not be positioned behind the driver's seat unless there is adequate space for safe installation.

WARNING

A child seat should never be used in the front passenger seat of any vehicle with a front passenger airbag - not even if the "Passenger airbag off" symbol near the rear-view mirror is illuminated. If the severity of an accident were to cause the airbag to inflate, this could lead to serious injury or death to a child seated in this position.

3.



Fasten the seat belt.

Fasten the seat belt by inserting the latch plate into the buckle (lock) until a distinct click is audible.



Pull out the shoulder section of the seat belt.

4. Pull the shoulder section of the seat belt out as far as possible to activate the belt's automatic locking function.

NOTE

The locking retractor will automatically release when the seat belt is unbuckled and allowed to retract fully.

5. Press the infant seat firmly in place, let the seat belt retract and pull it taut. A sound from the seat belt retractor's automatic locking function will be audible at this time and is normal. The seat belt should now be locked in place.



Check that the infant seat is properly secured.

6. Press and pull the infant seat along the direction of the seat belt to check that it is properly held in place by the seat belt.

WARNING

It should not be possible to move the child restraint more than 2.5 cm (1 in.) in any direction along the seat belt path.



When installing infant seats in the rear seat, Volvo recommends maintaining a distance of at least 50 mm (2 inches) from the front-most part of the infant seat to the rear-most part of the seat in front.

The infant seat can be removed by unbuckling the seat belt and letting it retract completely.

Related information

- Child restraints (p. 68)
- Convertible seats (p. 72)
- Booster cushions (p. 74)
- Top tether anchors (p. 75)

SAFETY

- Lower child seat attachment points (p. 77)
- ISOFIX/LATCH lower anchors (p. 77)

Convertible seats

Suitable child restraints should always be used when children (depending on their age/size) are seated in the vehicle.

Securing a convertible seat with a seat belt



Do not place the convertible seat in the front passenger's seat.

Convertible seats can be used in either a forward or rearward-facing position, depending on the age and size of the child.

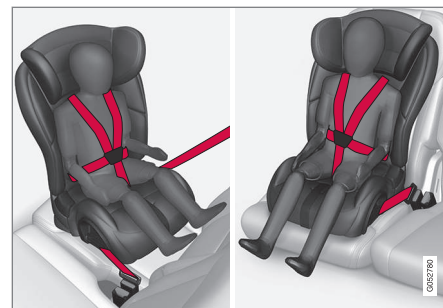

Route the seat belt through the convertible seat.

WARNING

Always use a convertible seat that is suitable for the child's age and size. See the convertible seat manufacturer's recommendations.

1. Place the convertible seat in the rear seat of the vehicle.

⚠ WARNING

- A small child's head represents a considerable part of its total weight and its neck is still very weak. Volvo recommends that children up to age 4 travel, properly restrained, facing rearward. In addition, Volvo recommends that children should ride rearward facing, properly restrained, as long as possible.
 - Convertible child seats should be installed in the rear seat only.
 - A rear-facing convertible seat should not be positioned behind the driver's seat unless there is adequate space for safe installation.
2. Attach the seat belt to the convertible seat according to the child restraint manufacturer's instructions.



Fasten the seat belt.

3. Fasten the seat belt by inserting the latch plate into the buckle (lock) until a distinct click is audible.
4. Pull the shoulder section of the seat belt out as far as possible to activate the belt's automatic locking function.

i NOTE

The locking retractor will automatically release when the seat belt is unbuckled and allowed to retract fully.

5. Press the convertible seat firmly in place, let the seat belt retract and pull it taut. A sound from the seat belt retractor's automatic locking function will be audible at this time and is normal. The seat belt should now be locked in place.



Pull out the shoulder section of the seat belt.

6. Push and pull the convertible seat along the seat belt path to ensure that it is held securely in place by the seat belt.



⚠️ WARNING

It should not be possible to move the child restraint more than 2.5 cm (1 in.) in any direction along the seat belt path.

The convertible seat can be removed by unbuckling the seat belt and letting it retract completely.

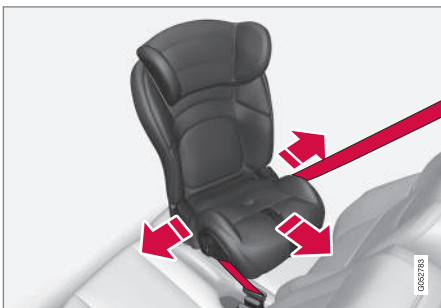

Ensure that the convertible seat is securely in place.

⚠️ WARNING

A child seat should never be used in the front passenger seat of any vehicle with a front passenger airbag - not even if the "Passenger airbag off" symbol near the rear-view mirror is illuminated. If the severity of an accident were to cause the airbag to inflate, this could lead to serious injury or death to a child seated in this position.

Related information

- Child restraints (p. 68)
- Infant seats (p. 70)
- Booster cushions (p. 74)
- Top tether anchors (p. 75)
- Lower child seat attachment points (p. 77)
- ISOFIX/LATCH lower anchors (p. 77)

Booster cushions

Suitable child restraints should always be used when children (depending on their age/size) are seated in the vehicle.

Securing a booster cushion



Position the child correctly on the booster cushion.

Booster cushions are recommended for children who have outgrown convertible seats.

1. Place the booster cushion in the rear seat of the vehicle.
2. With the child properly seated on the booster cushion, attach the seat belt to or around the cushion according to the manufacturer's instructions.

- Fasten the seat belt by inserting the latch plate into the buckle (lock) until a distinct click is audible.

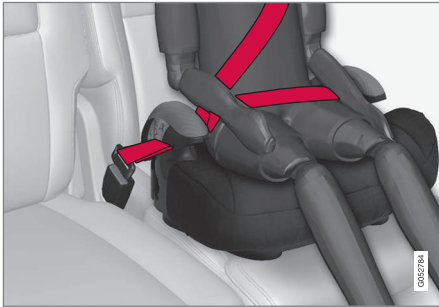

Positioning the seat belt.

- Ensure that the seat belt is pulled taut and fits snugly around the child.

⚠ WARNING

- The hip section of the three-point seat belt must fit snugly across the child's hips, not across the stomach.
- The shoulder section of the three-point seat belt should be positioned across the chest and shoulder.
- The shoulder belt must never be placed behind the child's back or under the arm.

Related information

- Child restraints (p. 68)
- Convertible seats (p. 72)
- Infant seats (p. 70)
- Top tether anchors (p. 75)
- Lower child seat attachment points (p. 77)
- ISOFIX/LATCH lower anchors (p. 77)

Top tether anchors

Your Volvo is equipped with child restraint top tether anchorages for all three seating positions in the rear seat. They are located on the rear side of the backrests.

Child restraint anchorages

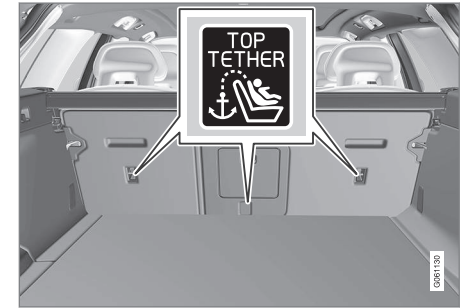

Top tether anchors and symbols on the rear side of the rear seat backrests. There is no symbol for the center anchor position.

◀◀ **Securing a child seat**

1. Place the child restraint on the rear seat.
2. Route the top tether strap under the head restraint and attach it to the anchor.
3. Attach the strap for the lower tether anchors in the lower ISOFIX/LATCH attachment points. If the child restraint is not equipped with straps for the lower tether anchors, or if the child restraint is used on the center seating position, follow the instructions for attaching a child restraint using the automatic locking seat belt.
4. Firmly tension all straps.

Refer also to the child seat manufacturer's instructions for information on securing the child seat.

i NOTE

If the vehicle is equipped with a cargo compartment cover, this must be removed before a child seat can be attached in the tether anchors.

⚠ WARNING

- Always refer to the recommendations made by the child restraint manufacturer.
- Volvo recommends that the top tether anchors be used when installing a forward-facing child restraint.
- Never route a top tether strap over the top of the head restraint. The strap should be routed beneath the head restraint.
- Child restraint anchorages are designed to withstand only those loads imposed by correctly fitted child restraints. Under no circumstances are they to be used for adult seat belts or harnesses. The anchorages are not able to withstand excessive forces on them in the event of collision if full harness seat belts or adult seat belts are installed to them. An adult who uses a belt anchored in a child restraint anchorage runs a great risk of suffering severe injuries should a collision occur.
- Do not install rear speakers that require the removal of the top tether anchors or interfere with the proper use of the top tether strap.

Related information

- Child restraints (p. 68)
- Lower child seat attachment points (p. 77)
- ISOFIX/LATCH lower anchors (p. 77)

Lower child seat attachment points

The rear seats are equipped with lower child seat attachment points.

The lower child seat attachment points are intended for use with certain rear-facing child restraints.

Always follow the manufacturer's installation instructions when attaching a child seat to the lower child seat attachment points.

Location of child seat attachment points

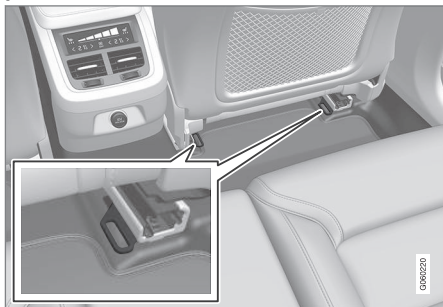

Location of child seat attachment points in the rear seat.

The child seat attachment points in the rear seat are located on the rear section of the front seat floor rails.

Related information

- Child restraints (p. 68)
- Top tether anchors (p. 75)
- ISOFIX/LATCH lower anchors (p. 77)

ISOFIX/LATCH lower anchors

Lower anchors for ISOFIX/LATCH-equipped child seats are located in the rear, outboard seats, hidden below the backrest cushions.

Using the ISOFIX/LATCH lower child seat anchors

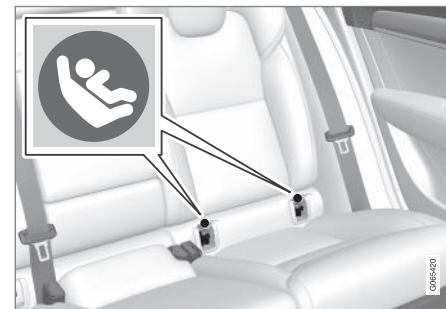

Location of the ISOFIX/LATCH anchors

Symbols on the seat back upholstery mark the ISOFIX/LATCH anchor positions as shown. To access the anchors, kneel on the seat cushion and locate the anchors by feel. Always follow your child seat manufacturer's installation instructions, and use both ISOFIX/LATCH lower anchors and top tethers whenever possible.

◀ To access the anchors

1. Put the child restraint in position.
2. Kneel on the child restraint to press down the seat cushion and locate the anchors by feel.
3. Fasten the attachment on the child restraint's lower straps to the ISOFIX/LATCH lower anchors.
4. Firmly tension the lower child seat straps according to the manufacturer's instructions.

⚠ WARNING

Volvo's ISOFIX/LATCH anchors conform to FMVSS/CMVSS standards. Always refer to the child restraint system's manual for weight and size ratings.

i NOTE

- The rear center seat is not equipped with ISOFIX/LATCH lower tether anchors. If a child restraint is used in this seat, attach the restraint's upper anchor strap (if equipped with these) to the top tether anchor point for this strap and secure the child restraint with the vehicle's center seat belt.
- Always follow your child seat manufacturer's installation instructions, and use both ISOFIX/LATCH lower anchors and top tethers whenever possible.

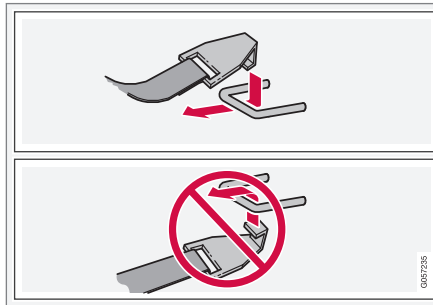

Fasten the attachment correctly to the ISOFIX/LATCH lower anchors

⚠ WARNING

- Be sure to fasten the attachment correctly to the anchor (see the illustration). If the attachment is not correctly fastened, the child restraint may not be properly secured in the event of a collision.
- The ISOFIX/LATCH lower child restraint anchors are only intended for use with child seats positioned in the outboard seating positions. These anchors are not certified for use with any child restraint that is positioned in the center seating position. When securing a child restraint in the center seating position, use only the vehicle's center seat belt.

Related information

- Child restraints (p. 68)
- Top tether anchors (p. 75)
- ISOFIX/LATCH lower anchors (p. 77)

DISPLAYS AND VOICE CONTROL

Displays and controls by the driver in a left-hand drive vehicle

The overviews show the location of the vehicle's displays and controls.

Steering wheel and dashboard

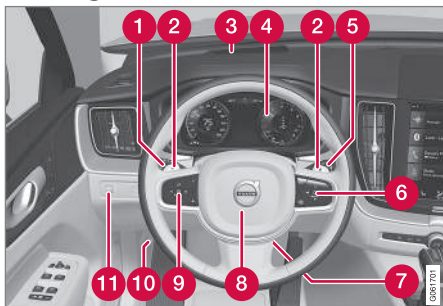

- 1 Parking lights, daytime running lights, low beams, high beams, turn signals, rear fog light, trip computer reset
- 2 Steering wheel paddles for manual shifting*
- 3 Head-up display*
- 4 Instrument panel
- 5 Wipers and washers, rain sensor*
- 6 Right-side steering wheel keypad
- 7 Steering wheel adjustment

- 8 Horn
- 9 Left-side steering wheel keypad
- 10 Hood open
- 11 Display lighting, tailgate unlock/open*/close*, halogen headlight height adjustment

Ceiling console



- 1 Front reading lights and courtesy lighting
- 2 Panoramic roof*
- 3 Ceiling console display **ON CALL** button
- 4 HomeLink®*

Center and tunnel console

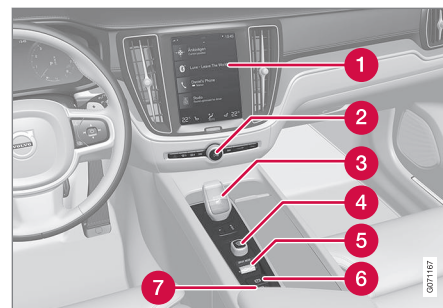

- 1 Center display
- 2 Hazard warning flashers, defrosting, media
- 3 Gear selector
- 4 Start knob
- 5 Drive modes
- 6 Parking brake
- 7 Auto-hold brakes

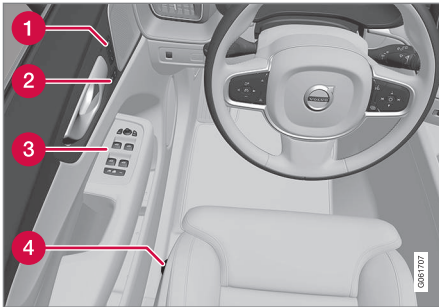
Driver's door

- 1 Memory for power front seat settings*, door mirrors and head-up display*
- 2 Central locking
- 3 Power windows, door mirrors, electric child locks*
- 4 Controls for front seat

Related information

- Manual front seats (p. 182)
- Adjusting the power* front seats (p. 183)
- Adjusting the steering wheel (p. 195)
- Lighting control and panel (p. 150)
- Starting the vehicle (p. 412)
- Instrument panel (p. 82)
- Center display overview (p. 108)
- Transmission (p. 427)

Instrument panel

The instrument panel displays information related to the vehicle and driving.

The instrument panel contains gauges, indicators and monitoring and warning symbols.

What is shown in the instrument panel varies depending on the equipment, settings and functions currently active.

The instrument panel is activated as soon as a door is opened, i.e. in ignition mode **O**. The panel will power down after a short period of time if it is not used. To reactivate it, do one of the following:

- Depress the brake pedal.
- Activate ignition mode **I**.

- Open one of the doors.

WARNING

If the instrument panel turns off, does not activate when the ignition is switched on, or part/all of the panel cannot be read, do not drive the vehicle. Consult a workshop immediately. Volvo recommends an authorized Volvo workshop.

WARNING

If the instrument panel is not functioning properly, information about brakes, airbags or other safety-related systems may not be displayed. The driver will then not be able to check the status of the vehicle systems or receive relevant warnings and information.



The illustration is generic - details may vary according to vehicle model.

Location in the instrument panel:

Left side	In the center	Right side
Speedometer	Indicator and warning symbols	Tachometer/Hybrid gauge ^A
Trip odometer	Ambient temperature sensor	Gear indicator
Odometer ^B	Clock	Drive Mode
Cruise control/speed limiter information	Message (also graphics in some cases)	Fuel gauge
Road sign information*	Door and seat belt status	Hybrid battery gauge
–	Hybrid battery's charge level	Distance to empty tank

Left side	In the center	Right side
–	Media player	Distance to discharged battery
–	Navigation system map*	Current fuel consumption
–	Phone	App menu (activated using steering wheel keypad)
–	Voice Control	–

A Depends on selected drive mode.

B Total distance.

Dynamic symbol

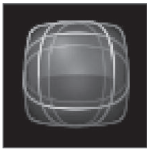

Dynamic symbol in basic mode.

In the center of the instrument panel is a dynamic symbol that changes appearance according to the type of message displayed. The severity of the control or warning symbol is indicated by a red or amber-colored marking around the symbol.



Example with indicator symbol.

An animation may be used to change the symbol into a graphic image to depict the location of a problem or to clarify information.

Related information

- Instrument panel settings (p. 84)
- Indicator and warning symbols (p. 93)
- Trip computer (p. 87)

- Messages in the instrument panel (p. 104)
- Handling the App menu in the instrument panel (p. 103)
- Drive modes (p. 434)

Instrument panel settings

Display settings for the instrument panel can be set in the instrument panel's App menu and in the center display's Settings menu.

Settings via instrument panel's app menu



The illustration is generic - details may vary according to vehicle model.

The app menu will open and can be controlled using the right-side steering wheel keypad.

The app menu can be used to set what information will be displayed in the instrument panel

- trip computer
- media player
- phone
- navigation system*.

Settings via center display

Selecting type of information

1. Tap **Settings** in the center display's Top view.
2. Tap **My Car** → **Displays** → **Driver Display Information**.
3. Select a background:
 - **Show no information in the background**
 - **Show information for current playing media**
 - **Show navigation even if no route is set**

Select theme

1. Tap **Settings** in the center display's Top view.
2. Tap **My Car** → **Displays** → **Display Themes**
3. Select a theme (appearance) for the instrument panel:
 - **Glass**
 - **Minimalistic**
 - **Performance**
 - **Chrome Rings**

Select language

1. Tap **Settings** in the center display's Top view.

2. Tap **System** → **System Languages and Units** → **System Language** to select language.

> A change made here will affect the language in all displays.

The settings are personal and saved automatically in the active driver profile.

Related information

- Instrument panel (p. 82)
- Handling the App menu in the instrument panel (p. 103)
- Changing settings in the center display's Top view (p. 130)

Fuel gauge

The fuel gauge in the instrument panel shows the fuel level in the tank.

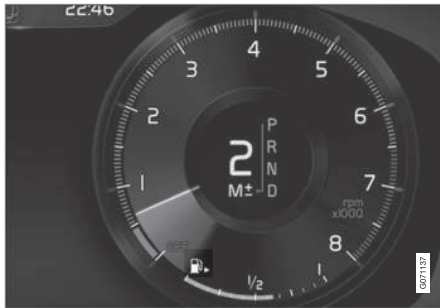

The illustration is generic - details may vary according to vehicle model.

The beige area in the fuel gauge indicates the amount of fuel left in the tank.

When the fuel level is low, the fuel pump symbol will illuminate with an amber-colored light. The trip computer also indicates the approximate distance that can be driven on the fuel remaining in the tank.

Related information

- Instrument panel (p. 82)
- Hybrid battery gauge (p. 86)
- Refueling (p. 449)
- Fuel tank volume (p. 655)

Hybrid gauge

In Hybrid and Pure drive modes, the instrument panel will display a hybrid gauge, which can help the driver achieve optimal driving economy.

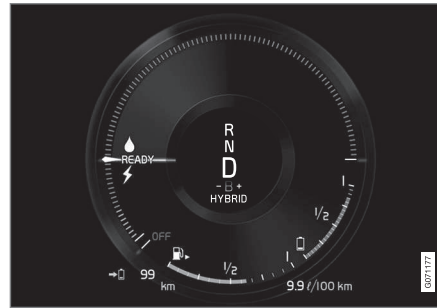

The hybrid gauge shows the ratio between the electric motor's current power consumption and the remaining available power. This information is shown in various ways.

Symbols in the hybrid gauge



Indicates the current available power from the electric motor. A solid symbol indicates that the electric motor is being used.



A hollow symbol indicates that the electric motor is not being used.



Indicates the power level when the internal combustion engine starts. A solid symbol indicates that the internal combustion engine is being used.



Indicates the power level when the internal combustion engine will start. A hollow symbol indicates that the internal combustion engine is not being used.



Indicates that the hybrid battery is being charged e.g. by lightly pressing the brake pedal.

Driver-requested power

The hybrid gauge displays the amount of power requested (utilized) by the driver through pressure on the accelerator pedal. The higher the reading on the scale, the more power utilized in the current gear. The mark between the lightning symbol and the drop symbol indicates the point at which the combustion engine will start.

◀◀ **For example:**



The vehicle has been started, but is stationary and no power is being requested.



The electric motor cannot supply the requested power and the internal combustion engine will start.



The vehicle is generating current to recharge the battery, e.g. during light braking or engine braking on a downslope.

Related information

- Drive modes (p. 434)
- Instrument panel (p. 82)
- Brakes (p. 417)
- Range (p. 443)
- Starting and stopping the combustion engine (p. 433)

Hybrid battery gauge



The hybrid battery gauge shows how much current is left in the hybrid battery.



The current in the hybrid battery is used to power the electric motor, but can also be used to heat or cool the vehicle. The trip computer calculates an approximate driving distance with the remaining current in the hybrid battery.

Symbols in the hybrid battery gauge



The  symbol in the hybrid battery gauge indicates that the **Hold** function is activated. The  symbol indicates that the **Charge** function is activated.

Related information

- Instrument panel (p. 82)
- Charging the hybrid battery (p. 391)
- Hold and Charge (p. 445)

Trip computer

The vehicle's trip computer registers data while driving such as mileage, fuel consumption and average speed.

To help promote fuel-efficient driving, data is recorded on both current and average fuel consumption. Data from the trip computer can be displayed in the instrument panel.

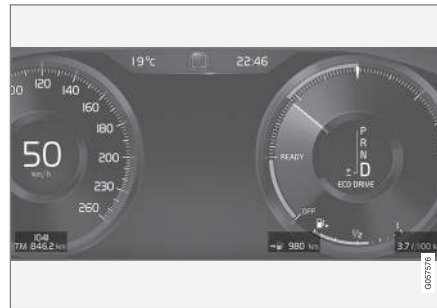

Example of trip computer information in the instrument panel. The illustration is generic - details may vary according to vehicle model.

The trip computer includes the following gauges:

- Trip odometer
- Odometer
- Current fuel consumption
- Distance to empty tank
- Distance to discharged battery

- Tourist - alternative speedometer

Unit standards for distance, speed, etc. can be changed via system settings in the center display.

Trip odometer

There are two trip odometers: TM and TA.

TM can be reset manually and TA is reset automatically if the vehicle is not used for four hours.

During a drive, the trip odometer registers data on:

- Mileage
- Driving time
- Average speed
- Average fuel consumption

The readings since the trip odometer's last reset are displayed.

Odometer

The odometer records the vehicle's total mileage. This reading cannot be reset.

Current fuel consumption

This gauge shows the vehicle's fuel consumption at that moment. The reading is updated about once a second.

Distance to empty tank



The trip computer calculates the distance that can be driven on the fuel remaining in the tank.

This calculation is based on average fuel consumption during the last 30 km (20 miles) and the amount of fuel remaining in the tank.

When the gauge displays "----", there is not enough fuel remaining to calculate the remaining mileage. Refuel as soon as possible.

NOTE

The information will change based on your driving style.

An economical driving style will generally increase how far you can drive on a certain amount of fuel.

Distance to discharged battery



This gauge shows the approximate distance that can be driven with the remaining current in the hybrid battery.

This calculation is based on average consumption with a normally loaded vehicle in normal driving conditions, and takes into account whether the air conditioning is on or off. Changing drive modes from **Hybrid** to **Pure** may increase the calculated distance because

Pure mode has reduced climate control settings (ECO Climate).

When the gauge displays "----", there is little charge remaining in the battery and electric motor range cannot be reliably calculated.

NOTE

The information will change based on your driving style.

An economical driving style will generally increase how far you can drive on a certain amount of fuel.

Starting values for fully charged hybrid battery

Because it is difficult to predict driving style and other factors that affect the range of electric motors, Volvo uses a starting value when the vehicle is fully charged. This starting value provides an "up to" amount instead of a prediction on the range of the electric current in the motor. The difference in starting value between **Hybrid** and **Pure** is because the vehicle is permitted to use more current from the hybrid battery in **Pure** mode, and because the vehicle switches to ECO Climate.

Mileage when using electric motor

To achieve the longest possible mileage when using the electric motor, the driver of an electric vehicle also needs to think about conserv-

ing electricity. The more electricity consumers (stereo, heated windows/mirrors/seats, very cold air from climate control system, etc.) that are active, the shorter the potential mileage.

NOTE

In addition to high electrical consumption in the passenger compartment, rapid acceleration, sudden braking, high speeds, heavy loads, low ambient temperatures and driving up hills can reduce possible driving distance.

Tourist - alternative speedometer

The alternative digital speedometer makes it easier to drive in countries where speed limit signs are shown in a different measurement unit than the one shown in the vehicle's gauges.

When used, the digital speed is displayed in the opposite unit to that shown in the analog speedometer. If **mph** is used in the analog speedometer, the equivalent speed in **km/h** will be shown in the digital speedometer.

Related information

- Displaying trip data in the instrument panel (p. 89)
- Resetting the trip odometer (p. 90)
- Displaying trip statistics in the center display (p. 90)

- Instrument panel (p. 82)
- Changing system units of measurement (p. 130)

Displaying trip data in the instrument panel

Data recorded and calculated by the trip computer can be displayed on the instrument panel.

This data is stored in a trip computer app. You can choose which information the instrument panel will display in the app menu.

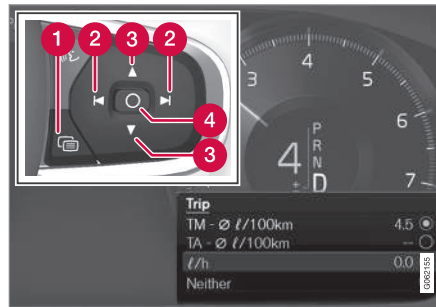

Open and navigate in the app menu¹ using the right-hand steering wheel keypad.

- 1 App menu
- 2 Left/right
- 3 Up/down
- 4 Confirm

1. Open the app menu in the instrument panel by pressing (1).
(The App menu cannot be opened while there is an unacknowledged message in the instrument panel. The message must be acknowledged by pressing the **O** button (4) before the App menu can be opened).
2. Navigate to the trip computer app by moving left or right using (2).
> The top four menu rows show measured values for trip odometer TM. The next four menu rows show measured values for trip odometer TA. Scroll up or down in the list using (3).

¹ The illustration is generic - details may vary according to vehicle model.

3. Scroll down to the option buttons to choose which information to show in the instrument panel:

- Odometer
- Distance to empty tank
- Distance to discharged battery
- Tourist (alternative speedometer)
- Mileage for trip odometer TM, TA or no display of mileage
- Current fuel consumption, average fuel consumption for TM or TA, or no display of fuel consumption

Select or clear a selection using the **O** button (4). The change will apply immediately.

Related information

- Trip computer (p. 87)
- Resetting the trip odometer (p. 90)

Resetting the trip odometer

Resetting the trip odometer using the left-side steering wheel lever.



- Reset all information in trip odometer TM (i.e. mileage, average fuel consumption, average speed and driving time) by pressing and holding the **RESET** button on the left-hand steering wheel lever.

Pressing the **RESET** button only resets the distance driven.

The TA trip odometer can not be manually reset. It resets automatically if the vehicle is not used for four hours or more.

Related information

- Trip computer (p. 87)

Displaying trip statistics in the center display

Trip computer statistics can be displayed graphically in the center display, providing an overview that facilitates more fuel-efficient driving.

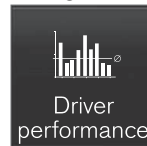

Open the **Driver performance** app in the App view to display trip statistics.

Each bar in the graph represents a driving distance of 1 kilometers, 10 kilometers or 100 kilometers (or miles). The bars are added from the right as you drive. The bar at the far right shows the data for the current trip.

Average fuel consumption and total driving time are calculated from the most recent reset of the trip statistics.

Fuel and electricity consumption are shown in separate graphs. The electricity consumption shows "net" consumption, i.e. consumed current minus regenerated current generated by braking.

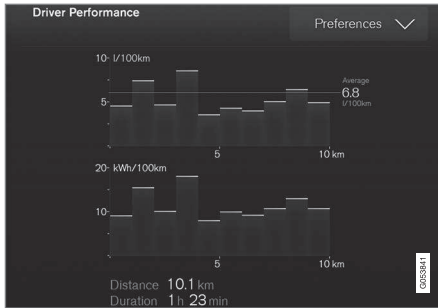

Trip computer statistics².

Related information

- Trip statistics settings (p. 91)
- Trip computer (p. 87)

Trip statistics settings

Trip statistics settings can be reset or adjusted.

1. Open the **Driver performance** app in the App view to display trip statistics.



2. Tap **Preferences** to

- change the graph scale. Select 1, 10 or 100 km/miles for the bar.
- reset data after each trip. Performed when the vehicle remains stationary for more than 4 hours.
- reset data for current trip.

Trip statistics, calculated average consumption, and total driving time are always reset simultaneously.

Unit standards for distance, speed, etc. can be changed via system settings in the center display.

Related information

- Displaying trip statistics in the center display (p. 90)
- Trip computer (p. 87)
- Resetting the trip odometer (p. 90)

² The illustration is generic - details may vary according to vehicle model.

Date and time

The clock is displayed in both the instrument panel and the center display.

Location of clock



Certain messages and other information may obscure the clock in the instrument panel.

In the center display, the clock is located on the upper right-hand side in the status bar.

Settings for date and time

- Select **Settings** → **System** → **Date and Time** in the center display's Top view to change settings for time and date format.

Adjust the date and time by tapping the up or down arrows on the touchscreen.

Automatic time for vehicles with GPS

When the vehicle is equipped with a navigation system, **Auto Time** is also available. The

time zone will then be automatically set to the vehicle's location. In some navigation systems, the current location must also be set to determine the correct time zone. If **Auto Time** is not selected, the time and date can be adjusted using the up and down arrows on the touchscreen.

Daylight savings time

In some countries, the **Auto Daylight Saving Time** setting can be selected to automatically change to daylight savings time. For other countries, the **Daylight Saving Time** setting can be selected manually.

Related information

- Instrument panel (p. 82)
- Changing settings in the center display's Top view (p. 130)

Ambient temperature sensor

The ambient temperature is shown in the instrument panel.

The sensor detects the temperature outside the vehicle.

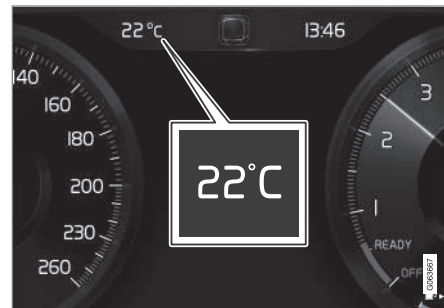

If the vehicle has been stationary, the sensor reading may be higher than the actual temperature.



When the ambient temperature is between -5 °C and $+2\text{ °C}$ (23 °F and 36 °F), a snowflake symbol will illuminate to alert the driver of the risk of slippery conditions.

The symbol is also temporarily lit in the head-up display* if the vehicle is equipped with one.

Change the measurement standard for the temperature sensor etc. via system settings in the center display's Top view.

* Option/accessory.

Related information

- Instrument panel (p. 82)
- Changing system units of measurement (p. 130)

Indicator and warning symbols

Indicator and warning symbols alert the driver that a function is active, that a symbol is working, or that an error or serious fault has occurred.

Red symbols

	<p>WARNING</p> <p>The red warning symbol illuminates to indicate that a fault has been detected that could affect safety or driveability. An explanatory message will be simultaneously displayed in the instrument panel.</p> <p>The warning symbol may also illuminate in combination with other symbols.</p>
	<p>Seat belt reminder</p> <p>Lights up or flashes when a someone in the vehicle has not fastened their seat belt.</p>

	<p>Airbags</p> <p>A fault has been detected in one of the vehicle's safety systems.</p> <p>Read the message in the instrument panel and contact a workshop. Volvo recommends contacting an authorized Volvo workshop.</p>
	<p>Fault in brake system</p> <p>A fault has occurred in the brake system.</p> <p>A</p> <p>Read the message in the instrument panel and contact a workshop. Volvo recommends contacting an authorized Volvo workshop.</p>
	<p>B</p>
	<p>Parking brake</p> <p>Steady glow: the parking brake is activated.</p> <p>A</p> <p>Flashing: a fault has occurred in the parking brake. Read the message in the instrument panel.</p>
	<p>B</p>









	<p>Fault in electrical system</p> <p>A fault has occurred in the electrical system.</p> <p>Read the message in the instrument panel and contact a workshop. Volvo recommends contacting an authorized Volvo workshop.</p>
	<p>High engine temperature</p> <p>The engine's temperature is too high. Read the message in the instrument panel.</p>





	<p>Collision risk</p> <p>City Safety warns the driver if there is a risk of a collision with another vehicle, pedestrian, cyclist or large animal.</p>
	<p>Low oil pressure</p> <p>The engine's oil pressure is too low. Stop the engine immediately and check the engine oil level. Add oil if necessary.</p> <p>If this symbol lights up and the oil level is normal, read the message in the instrument panel and contact a workshop. Volvo recommends contacting an authorized Volvo workshop.</p>

A Canadian models.
B US models.

Amber symbols

	<p>Information</p> <p>A problem has occurred in one of the vehicle's systems. Read the message in the instrument panel.</p> <p>The information symbol may also illuminate in combination with other symbols.</p>
	<p>Fault in brake system</p> <p>A fault has occurred in the brake system. Read the message in the instrument panel.</p>
<p>A</p>	
<p>B</p>	
<p>A</p>	<p>Fault in ABS system</p> <p>The system is not functioning properly. The vehicle's regular brakes will still work, but without the ABS function.</p>
<p>B</p>	



	<p>Emission control system</p> <p>Fault in emission control system. Have the vehicle checked by a workshop. Volvo recommends contacting an authorized Volvo workshop.</p>
	<p>Rear fog light</p> <p>Rear fog light on.</p>
	<p>Tire pressure system</p> <p>Tire pressure low.</p> <p>If there is a fault in the tire pressure system, the symbol will first flash for approximately 1 minute and then glow steadily. This may occur if the system cannot detect or alert the driver of low tire pressure as intended.</p>
	<p>Fault in headlight system</p> <p>A fault has occurred in the headlight system. Read the message in the instrument panel.</p>
	<p>Lane Keeping Aid</p> <p>Lane Keeping Aid is alerting/intervening.</p>

	<p>Reduced performance</p> <p>Temporary fault in driveline. Read the message in the instrument panel.</p>
	<p>Stability system</p> <p>Steady glow: a fault has occurred in the system.</p> <p>Flashing: the system is working.</p>
	<p>Stability system, Sport mode</p> <p>Sport mode is activated.</p>
Blue symbols	
	<p>Active high beam</p> <p>Active high beam is activated and on.</p>
	<p>High beams</p> <p>High beams on.</p>

Green symbols

 A	<p>Auto-hold brake</p> <p>The function is activated and the brakes or the parking brake are being used.</p>
	<p>Front fog light</p> <p>Front fog light on.</p>
	<p>Parking lights</p> <p>Parking lights on.</p>
	<p>Left/right turn signals</p> <p>Turn signal in use.</p>
	

White/gray symbols

	<p>Active high beam</p> <p>Active high beam is activated but not on.</p>
	<p>Preconditioning</p> <p>Engine and passenger compartment heater/air conditioning is preconditioning the vehicle.</p>





	<p>Lane Keeping Aid</p> <p>White symbol: Lane Keeping Aid is on and lane marker lines are detected.</p> <p>Gray symbol: Lane Keeping Aid is on but no lane marker lines are detected.</p>
	<p>Rain sensor</p> <p>The rain sensor is activated.</p>

Related information

- Instrument panel (p. 82)

Instrument panel licenses

A license is an agreement on the right to conduct a certain activity or the right to use someone else's right according to terms and conditions specified in the agreement. The following text is Volvo's agreement with the manufacturer or developer.

Boost Software License 1.0

Permission is hereby granted, free of charge, to any person or organization obtaining a copy of the software and accompanying documentation covered by this license (the "Software") to use, reproduce, display, distribute, execute, and transmit the Software, and to prepare derivative works of the Software, and to permit third-parties to whom the Software is furnished to do so, all subject to the following: The copyright notices in the Software and this entire statement, including the above license grant, this restriction and the following disclaimer, must be included in all copies of the Software, in whole or in part, and all derivative works of the Software, unless such copies or derivative works are solely in the form of machine-executable object code generated by a source language processor.

THE SOFTWARE IS PROVIDED "AS IS", WITHOUT WARRANTY OF ANY KIND, EXPRESS OR IMPLIED, INCLUDING BUT NOT LIMITED TO THE WARRANTIES OF MERCHANTABILITY, FITNESS FOR A

PARTICULAR PURPOSE, TITLE AND NON-INFRINGEMENT. IN NO EVENT SHALL THE COPYRIGHT HOLDERS OR ANYONE DISTRIBUTING THE SOFTWARE BE LIABLE FOR ANY DAMAGES OR OTHER LIABILITY, WHETHER IN CONTRACT, TORT OR OTHERWISE, ARISING FROM, OUT OF OR IN CONNECTION WITH THE SOFTWARE OR THE USE OR OTHER DEALINGS IN THE SOFTWARE.

BSD 4-clause "Original" or "Old" License

Copyright (c) 1982, 1986, 1990, 1991, 1993
The Regents of the University of California. All rights reserved.

Redistribution and use in source and binary forms, with or without modification, are permitted provided that the following conditions are met:

1. Redistributions of source code must retain the above copyright notice, this list of conditions and the following disclaimer.
2. Redistributions in binary form must reproduce the above copyright notice, this list of conditions and the following disclaimer in the documentation and/or other materials provided with the distribution.
3. All advertising materials mentioning features or use of this software must display the following acknowledgement: This product includes software developed by the University of California, Berkeley and its contributors.
4. Neither the name of the University nor the names of its contributors may be used to endorse or promote products derived from this software without specific prior written permission.

THIS SOFTWARE IS PROVIDED BY THE REGENTS AND CONTRIBUTORS "AS IS" AND ANY EXPRESS OR IMPLIED

WARRANTIES, INCLUDING, BUT NOT LIMITED TO, THE IMPLIED WARRANTIES OF MERCHANTABILITY AND FITNESS FOR A PARTICULAR PURPOSE ARE DISCLAIMED. IN NO EVENT SHALL THE REGENTS OR CONTRIBUTORS BE LIABLE FOR ANY DIRECT, INDIRECT, INCIDENTAL, SPECIAL, EXEMPLARY, OR CONSEQUENTIAL DAMAGES (INCLUDING, BUT NOT LIMITED TO, PROCUREMENT OF SUBSTITUTE GOODS OR SERVICES; LOSS OF USE, DATA, OR PROFITS; OR BUSINESS INTERRUPTION) HOWEVER CAUSED AND ON ANY THEORY OF LIABILITY, WHETHER IN CONTRACT, STRICT LIABILITY, OR TORT (INCLUDING NEGLIGENCE OR OTHERWISE) ARISING IN ANY WAY OUT OF THE USE OF THIS SOFTWARE, EVEN IF ADVISED OF THE POSSIBILITY OF SUCH DAMAGE.

BSD 3-clause "New" or "Revised" License

Copyright (c) 2011-2014, Yann Collet.

Redistribution and use in source and binary forms, with or without modification, are permitted provided that the following conditions are met:

1. Redistributions of source code must retain the above copyright notice, this list of conditions and the following disclaimer.
2. Redistributions in binary form must reproduce the above copyright notice, this list of conditions and the following

disclaimer in the documentation and/or other materials provided with the distribution.

3. Neither the name of the organisation nor the names of its contributors may be used to endorse or promote products derive from this software without specific prior written permission.

THIS SOFTWARE IS PROVIDED BY THE COPYRIGHT HOLDERS AND CONTRIBUTORS "AS IS" AND ANY EXPRESS OR IMPLIED WARRANTIES, INCLUDING, BUT NOT LIMITED TO, THE IMPLIED WARRANTIES OF MERCHANTABILITY AND FITNESS FOR A PARTICULAR PURPOSE ARE DISCLAIMED. IN NO EVENT SHALL THE COPYRIGHT HOLDER OR CONTRIBUTORS BE LIABLE FOR ANY DIRECT, INDIRECT, INCIDENTAL, SPECIAL, EXEMPLARY, OR CONSEQUENTIAL DAMAGES (INCLUDING, BUT NOT LIMITED TO, PROCUREMENT OF SUBSTITUTE GOODS OR SERVICES; LOSS OF USE, DATA, OR PROFITS; OR BUSINESS INTERRUPTION) HOWEVER CAUSED AND ON ANY THEORY OF LIABILITY, WHETHER IN CONTRACT, STRICT LIABILITY, OR TORT (INCLUDING NEGLIGENCE OR OTHERWISE) ARISING IN ANY WAY OUT OF THE USE OF THIS SOFTWARE, EVEN IF ADVISED OF THE POSSIBILITY OF SUCH DAMAGE.



◀ **BSD 2-clause "Simplified" license**

Copyright (c) <YEAR>, <OWNER> All rights reserved.

Redistribution and use in source and binary forms, with or without modification, are permitted provided that the following conditions are met:

1. Redistributions of source code must retain the above copyright notice, this list of conditions and the following disclaimer.
2. Redistributions in binary form must reproduce the above copyright notice, this list of conditions and the following disclaimer in the documentation and/or other materials provided with the distribution.

THIS SOFTWARE IS PROVIDED BY THE COPYRIGHT HOLDERS AND CONTRIBUTORS "AS IS" AND ANY EXPRESS OR IMPLIED WARRANTIES, INCLUDING, BUT NOT LIMITED TO, THE IMPLIED WARRANTIES OF MERCHANTABILITY AND FITNESS FOR A PARTICULAR PURPOSE ARE DISCLAIMED. IN NO EVENT SHALL THE COPYRIGHT OWNER OR CONTRIBUTORS BE LIABLE FOR ANY DIRECT, INDIRECT, INCIDENTAL, SPECIAL, EXEMPLARY, OR CONSEQUENTIAL DAMAGES (INCLUDING, BUT NOT LIMITED TO, PROCUREMENT OF SUBSTITUTE GOODS OR SERVICES; LOSS

OF USE, DATA, OR PROFITS; OR BUSINESS INTERRUPTION) HOWEVER CAUSED AND ON ANY THEORY OF LIABILITY, WHETHER IN CONTRACT, STRICT LIABILITY, OR TORT (INCLUDING NEGLIGENCE OR OTHERWISE) ARISING IN ANY WAY OUT OF THE USE OF THIS SOFTWARE, EVEN IF ADVISED OF THE POSSIBILITY OF SUCH DAMAGE.

The views and conclusions contained in the software and documentation are those of the authors and should not be interpreted as representing official policies, either expressed or implied, of the FreeBSD Project.

FreeType Project License

1. Copyright 1996-1999 by David Turner, Robert Wilhelm, and Werner Lemberg
Introduction The FreeType Project is distributed in several archive packages; some of them may contain, in addition to the FreeType font engine, various tools and contributions which rely on, or relate to, the FreeType Project. This license applies to all files found in such packages, and which do not fall under their own explicit license. The license affects thus the FreeType font engine, the test programs, documentation and makefiles, at the very least. This license was inspired by the BSD, Artistic, and IJG (Independent JPEG Group) licenses, which all encourage inclusion and use of

free software in commercial and freeware products alike. As a consequence, its main points are that: o We don't promise that this software works. However, we are interested in any kind of bug reports. ('as is' distribution) o You can use this software for whatever you want, in parts or full form, without having to pay us. ('royalty-free' usage) o You may not pretend that you wrote this software. If you use it, or only parts of it, in a program, you must acknowledge somewhere in your documentation that you've used the FreeType code. ('credits') We specifically permit and encourage the inclusion of this software, with or without modifications, in commercial products, provided that all warranty or liability claims are assumed by the product vendor. Legal Terms 0. Definitions Throughout this license, the terms 'package', 'FreeType Project', and 'FreeType archive' refer to the set of files originally distributed by the authors (David Turner, Robert Wilhelm, and Werner Lemberg) as the 'FreeType project', be they named as alpha, beta or final release. 'You' refers to the licensee, or person using the project, where 'using' is a generic term including compiling the project's source code as well as linking it to form a 'program' or 'executable'. This program is referred to as 'a program using the FreeType engine'. This license applies

to all files distributed in the original FreeType archive, including all source code, binaries and documentation, unless otherwise stated in the file in its original, unmodified form as distributed in the original archive. If you are unsure whether or not a particular file is covered by this license, you must contact us to verify this. The FreeType project is copyright (C) 1996-1999 by David Turner, Robert Wilhelm, and Werner Lemberg. All rights reserved except as specified below. 1. No Warranty THE FREETYPE ARCHIVE IS PROVIDED 'AS IS' WITHOUT WARRANTY OF ANY KIND, EITHER EXPRESSED OR IMPLIED, INCLUDING, BUT NOT LIMITED TO, WARRANTIES OF MERCHANTABILITY AND FITNESS FOR A PARTICULAR PURPOSE. IN NO EVENT WILL ANY OF THE AUTHORS OR COPYRIGHT HOLDERS BE LIABLE FOR ANY DAMAGES CAUSED BY THE USE OR THE INABILITY TO USE, OF THE FREETYPE PROJECT. As you have not signed this license, you are not required to accept it. However, as the FreeType project is copyrighted material, only this license, or another one contracted with the authors, grants you the right to use, distribute, and modify it. Therefore, by using, distributing, or modifying the FreeType project, you indicate that you

understand and accept all the terms of this license.

2. Redistribution Redistribution and use in source and binary forms, with or without modification, are permitted provided that the following conditions are met:
 - o Redistribution of source code must retain this license file ('licence.txt') unaltered; any additions, deletions or changes to the original files must be clearly indicated in accompanying documentation. The copyright notices of the unaltered, original files must be preserved in all copies of source files.
 - o Redistribution in binary form must provide a disclaimer that states that the software is based in part of the work of the FreeType Team, in the distribution documentation. We also encourage you to put an URL to the FreeType web page in your documentation, though this isn't mandatory. These conditions apply to any software derived from or based on the FreeType code, not just the unmodified files. If you use our work, you must acknowledge us. However, no fee need be paid to us.
3. Advertising The names of FreeType's authors and contributors may not be used to endorse or promote products derived from this software without specific prior written permission. We suggest, but do not require, that you use one or more of

the following phrases to refer to this software in your documentation or advertising materials: 'FreeType Project', 'FreeType Engine', 'FreeType library', or 'FreeType Distribution'.

4. Contacts There are two mailing lists related to FreeType:
 - o freetype@freetype.org Discusses general use and applications of FreeType, as well as future and wanted additions to the library and distribution. If you are looking for support, start in this list if you haven't found anything to help you in the documentation.
 - o devel@freetype.org Discusses bugs, as well as engine internals, design issues, specific licenses, porting, etc.
 - o <http://www.freetype.org> Holds the current FreeType web page, which will allow you to download our latest development version and read online documentation. You can also contact us individually at: David Turner <david.turner@freetype.org> Robert Wilhelm <robert.wilhelm@freetype.org> Werner Lemberg <werner.lemberg@freetype.org>

◀◀ **Libpng License**

This copy of the libpng notices is provided for your convenience. In case of any discrepancy between this copy and the notices in the file png.h that is included in the libpng distribution, the latter shall prevail.

COPYRIGHT NOTICE, DISCLAIMER, and LICENSE:

If you modify libpng you may insert additional notices immediately following this sentence.

libpng versions 1.0.7, July 1, 2000, through 1.0.13, April 15, 2002, are Copyright (c) 2000-2002 Glenn Randers-Pehrson and are distributed according to the same disclaimer and license as libpng-1.0.6 with the following individuals added to the list of Contributing Authors

Simon-Pierre Cadieux

Eric S. Raymond

Gilles Vollant

and with the following additions to the disclaimer:

There is no warranty against interference with your enjoyment of the library or against infringement. There is no warranty that our efforts or the library will fulfill any of your particular purposes or needs. This library is provided with all faults, and the entire risk of

satisfactory quality, performance, accuracy, and effort is with the user.

libpng versions 0.97, January 1998, through 1.0.6, March 20, 2000, are Copyright (c) 1998, 1999 Glenn Randers-Pehrson, and are distributed according to the same disclaimer and license as libpng-0.96, with the following individuals added to the list of Contributing Authors:

Tom Lane

Glenn Randers-Pehrson

Willem van Schaik

libpng versions 0.89, June 1996, through 1.0.6, May 1997, are Copyright (c) 1996, 1997 Andreas Dilger Distributed according to the same disclaimer and license as libpng-0.88, with the following individuals added to the list of Contributing Authors:

John Bowler

Kevin Braceley

Sam Bushell

Magnus Holmgren

Greg Roelofs

Tom Tanner

libpng versions 0.5, May 1995, through 0.88, January 1996, are Copyright (c) 1995, 1996 Guy Eric Schalnat, Group 42, Inc.

For the purposes of this copyright and license, "Contributing Authors" is defined as the following set of individuals:

Andreas Dilger

Dave Martindale

Guy Eric Schalnat

Paul Schmidt

Tim Wegner

The PNG Reference Library is supplied "AS IS". The Contributing Authors and Group 42, Inc. disclaim all warranties, expressed or implied, including, without limitation, the warranties of merchantability and of fitness for any purpose. The Contributing Authors and Group 42, Inc. assume no liability for direct, indirect, incidental, special, exemplary, or consequential damages, which may result from the use of the PNG Reference Library, even if advised of the possibility of such damage.

Permission is hereby granted to use, copy, modify, and distribute this source code, or portions hereof, for any purpose, without fee, subject to the following restrictions:

1. The origin of this source code must not be misrepresented.
2. Altered versions must be plainly marked as such and must not be misrepresented as being the original source.
3. This Copyright notice may not be removed or altered from any source or altered source distribution.

The Contributing Authors and Group 42, Inc. specifically permit, without fee, and encourage the use of this source code as a component to supporting the PNG file format in commercial products. If you use this source code in a product, acknowledgment is not required but would be appreciated.

A "png_get_copyright" function is available, for convenient use in "about" boxes and the like:

```
printf("%s",png_get_copyright(NULL));
```

Also, the PNG logo (in PNG format, of course) is supplied in the files "pngbar.png" and "pngbar.jpg (88x31) and "pngnow.png" (98x31).

Libpng is OSI Certified Open Source Software. OSI Certified Open Source is a certification mark of the Open Source Initiative.

Glenn Randers-Pehrson randeg@alum.rpi.edu
April 15, 2002

MIT License

Copyright (c) <year> <copyright holders>

Permission is hereby granted, free of charge, to any person obtaining a copy of this software and associated documentation files (the "Software"), to deal in the Software without restriction, including without limitation the rights to use, copy, modify, merge, publish, distribute, sublicense, and/or sell copies of the Software, and to permit persons to whom the Software is furnished to do so, subject to the following conditions:

The above copyright notice and this permission notice shall be included in all copies or substantial portions of the Software.

THE SOFTWARE IS PROVIDED "AS IS", WITHOUT WARRANTY OF ANY KIND, EXPRESS OR IMPLIED, INCLUDING BUT NOT LIMITED TO THE WARRANTIES OF MERCHANTABILITY, FITNESS FOR A PARTICULAR PURPOSE AND NONINFRINGEMENT. IN NO EVENT SHALL THE AUTHORS OR COPYRIGHT HOLDERS BE LIABLE FOR ANY CLAIM, DAMAGES OR OTHER LIABILITY, WHETHER IN AN ACTION OF CONTRACT, TORT OR OTHERWISE, ARISING FROM, OUT OF OR IN CONNECTION WITH THE SOFTWARE OR THE USE OR OTHER DEALINGS IN THE SOFTWARE.

zlib License

The zlib/libpng License Copyright (c) <year> <copyright holders>

This software is provided 'as-is', without any express or implied warranty. In no event will the authors be held liable for any damages arising from the use of this software.

Permission is granted to anyone to use this software for any purpose, including commercial applications, and to alter it and redistribute it freely, subject to the following restrictions:

1. The origin of this software must not be misrepresented; you must not claim that you wrote the original software. If you use this software in a product, an acknowledgment in the product documentation would be appreciated but is not required.
2. Altered source versions must be plainly marked as such, and must not be misrepresented as being the original software.
3. This notice may not be removed or altered from any source distribution.

◀ **SGI Free Software B License Version 2.0.** SGI FREE SOFTWARE LICENSE B (Version 2.0, Sept. 18, 2008)

Copyright (C) [dates of first publication] Silicon Graphics, Inc. All Rights Reserved. Permission is hereby granted, free of charge, to any person obtaining a copy of this software and associated documentation files (the "Software"), to deal in the Software without restriction, including without limitation the rights to use, copy, modify, merge, publish, distribute, sublicense, and/or sell copies of the Software, and to permit persons to whom the Software is furnished to do so, subject to the following conditions: The above copyright notice including the dates of first publication and either this permission notice or a reference to <http://oss.sgi.com/projects/FreeB/> shall be included in all copies or substantial portions of the Software.

THE SOFTWARE IS PROVIDED "AS IS", WITHOUT WARRANTY OF ANY KIND, EXPRESS OR IMPLIED, INCLUDING BUT NOT LIMITED TO THE WARRANTIES OF MERCHANTABILITY, FITNESS FOR A PARTICULAR PURPOSE AND NONINFRINGEMENT. IN NO EVENT SHALL SILICON GRAPHICS, INC. BE LIABLE FOR ANY CLAIM, DAMAGES OR OTHER LIABILITY, WHETHER IN AN ACTION OF CONTRACT, TORT OR OTHERWISE, ARISING FROM, OUT OF OR IN

CONNECTION WITH THE SOFTWARE OR THE USE OR OTHER DEALINGS IN THE SOFTWARE.

Except as contained in this notice, the name of Silicon Graphics, Inc. shall not be used in advertising or otherwise to promote the sale, use or other dealings in this Software without prior written authorization from Silicon Graphics, Inc.

Related information

- Instrument panel (p. 82)

App menu in instrument panel

The App menu in the instrument panel provides quick access to commonly used functions for certain apps.



The illustration is generic.

The App menu in the instrument panel can be used instead of the center display and is then controlled using the right-side steering wheel keypad. The app menu makes it easier to switch between different apps or functions within the apps without having to let go of the steering wheel.

App menu functions

Different apps provide access to different types of functions. The following apps and their functions can be controlled from the App menu:

App	Functions
Trip computer	Select a trip odometer, change instrument panel display settings, etc.
Media player	Select active source for media player.
Phone	Call a contact from the call list.
Navigation	Guide to destination, etc.

Related information

- Instrument panel (p. 82)
- Center display overview (p. 108)
- Handling the App menu in the instrument panel (p. 103)

Handling the App menu in the instrument panel

The App menu in the instrument panel is controlled using the right-side steering wheel keypad.

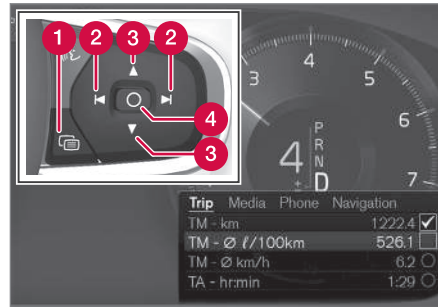

App menu and right-side steering wheel keypad. The illustration is generic.

- 1 Open/close
- 2 Left/right
- 3 Up/down
- 4 Confirm

Opening and closing the app menu

- Tap open/close (1).
 - > The App menu opens/closes.

NOTE

The App menu cannot be opened while there is an unacknowledged message in the instrument panel. The message must be acknowledged before the App menu can be opened.

The App menu turns off automatically after a period of inactivity or after certain selections are made.

Navigating and making selections in the App menu

1. Navigate between apps by tapping left or right (2).
 - > Functions for the previous/next app will be shown in the App menu.
2. Scroll through the functions for the selected app using the up or down arrows (3).
3. Confirm or make a selection for the function by pressing confirm (4).
 - > The function will be activated and, for some selections, the App menu will then close.

- ◀◀ The next time the App menu is opened, the functions for the most recently selected app will be displayed automatically.

Related information

- App menu in instrument panel (p. 102)
- Messages in the instrument panel (p. 104)

Messages in the instrument panel

The instrument panel shows messages in certain circumstances to inform or assist the driver.



Example of message in the instrument panel. The illustration is generic - details may vary according to vehicle model.

High-priority messages for the driver are displayed in the instrument panel.

The messages may appear in different parts of the instrument panel depending on what other information is currently being displayed. The message will disappear from the instrument panel after a short period of time or after it has been acknowledged or any required action has been taken. Messages that need to be saved are stored in the **Car Status** app, which can be opened from the App view in the center display.

The message may be shown along with graphics, symbols or buttons to e.g. acknowledge the message or accept a request.

Service messages

The following table lists a selection of important service messages and what they mean.

Message	Meaning
Stop safely^A	Stop and switch off the engine. Serious risk of damage - contact a workshop ^B .
Turn off engine^A	Stop and switch off the engine. Serious risk of damage - contact a workshop ^B .
Service urgent Drive to workshop^A	Contact a workshop ^B to have the vehicle inspected immediately.
Service required^A	Contact a workshop ^B to have the vehicle inspected as soon as possible.
Regular maintenance Book time for maintenance	Time for service - contact a workshop ^B . Shown before the next service date.
Regular maintenance Time for maintenance	Time for service - contact a workshop ^B . Shown on the next service date.

Message	Meaning
Regular maintenance Maintenance overdue	Time for service - contact a workshop ^B . Shown when the date for service has passed.
Temporarily off^A	A function has been temporarily deactivated and will be reactivated automatically while driving or after the engine is restarted.

^A Part of message, shown along with information on the location of the problem.

^B An authorized Volvo workshop is recommended.

Related information

- Handling messages in the instrument panel (p. 105)
- Handling messages saved from the instrument panel (p. 106)
- Messages in the center display (p. 138)

Handling messages in the instrument panel

Messages in the instrument panel are controlled using the right-side steering wheel keypad.



Examples of messages in the instrument panel and the right-side steering wheel keypad. The illustration is generic - details may vary according to vehicle model.

- 1 Left/right
- 2 Confirm

Some messages in the instrument panel contain one or more buttons for e.g. confirming the message or accepting a request.

◀ Handling new messages

For messages with buttons:

1. Navigate between the buttons by tapping left or right (1).
2. Confirm your selection by pressing confirm (2).
 - > The message will disappear from the instrument panel.

For messages without buttons:

- Close the message by pressing confirm (2) or let the message automatically time-out after a short period.
 - > The message will disappear from the instrument panel.

Messages that need to be saved are stored in the **Car Status** app, which can be opened from the App view in the center display. The message **Vehicle message stored in Car Status app** will simultaneously appear in the center display.

Related information

- Messages in the instrument panel (p. 104)
- Handling messages saved from the instrument panel (p. 106)
- Messages in the center display (p. 138)

Handling messages saved from the instrument panel

Messages saved from the instrument panel and center displays are handled in the center display.

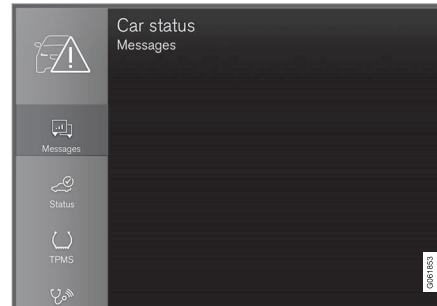

Saved messages can be viewed in the **Car Status** app.

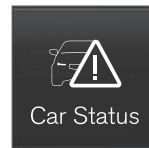

The messages displayed in the instrument panel that need to be saved are stored in the **Car Status** app in the center display. The message **Vehicle message stored in Car Status app** will simultaneously appear in the center display.

Reading saved messages

To read a saved message immediately:

- Tap the button to the right of the message **Vehicle message stored in Car Status app** in the center display.
 - > The saved message will be displayed in the **Car Status** app.

To read saved messages at a later time:

1. Open the **Car Status** app from App view in the center display.
 - > The app will open in the bottom tile of Home view.
2. Select the **Messages** tab in the app.
 - > A list of saved messages will be displayed.
3. Tap a message to expand/minimize it.
 - > More information about the message will appear in the list and the image to the left of the app will display information about the message in graphic form.

Handling saved messages

In expanded form, some messages have two buttons available for booking service or reading the Owner's Manual.

Booking service for saved messages:

- With the message in expanded form, tap **Request appoint./Call to make Appointment**³ for assistance booking service.
 - > With **Request appoint.:** The **Appointments** tab will open in the app and create a request for a service/repair appointment.
 - With **Call to make Appointment:** The phone app will open and call a service center to make an appointment for service or repairs.

Reading the Owner's Manual for saved messages:

- With the message in expanded form, tap **Owner's manual** to read relevant information about the message in the Owner's Manual.
 - > The Owner's Manual will open in the center display and provide information related to the message.

Saved messages in the app are automatically deleted each time the engine is started.

Related information

- Messages in the instrument panel (p. 104)
- Handling messages in the instrument panel (p. 105)
- Messages in the center display (p. 138)

³ Market dependent. Volvo ID and selected workshop also need to be registered.

Center display overview

Many of the vehicle's functions can be controlled from the center display. The center

display and its possibilities are presented below.

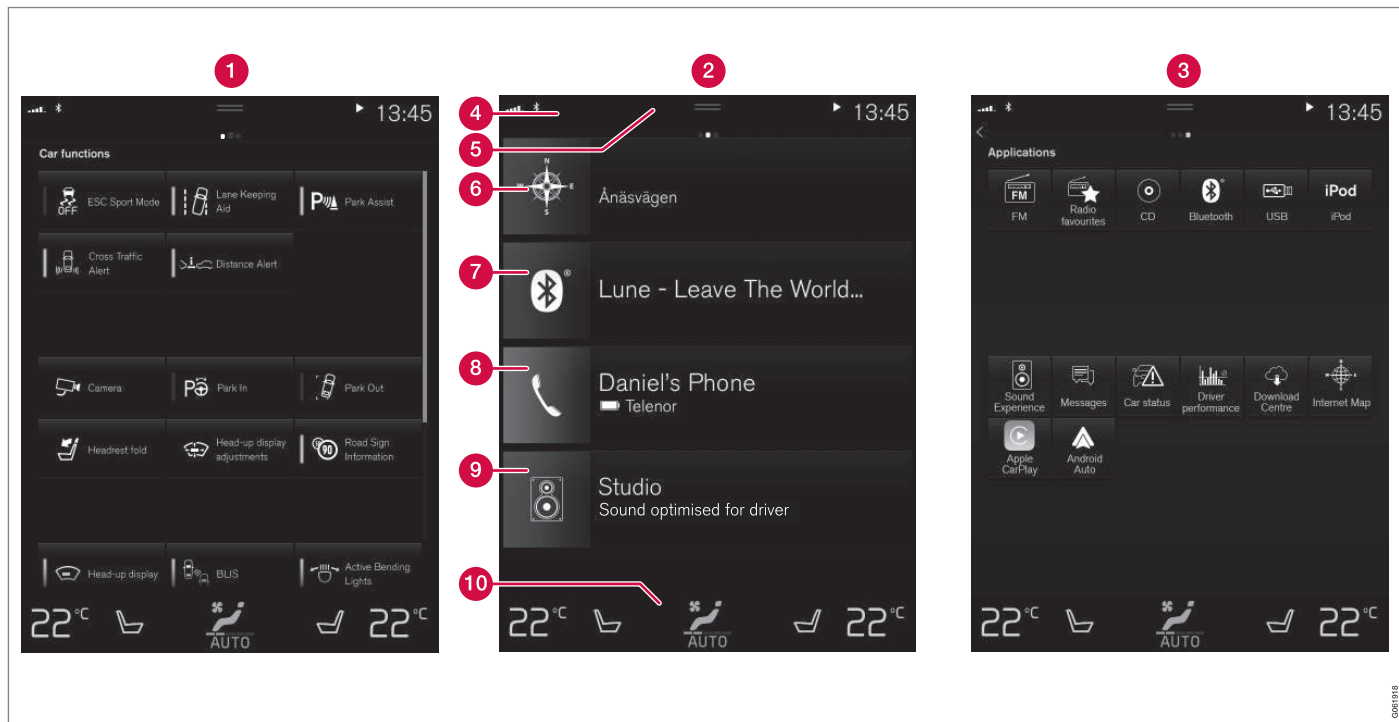

Three of the center display's basic views. Swipe to the right/left to access Function or App view⁴.

- 1 Function view – vehicle functions that can be activated or deactivated with one tap. Certain functions, called "trigger functions", open windows with settings options. One example is the **Camera**. Settings for the head-up display* are also started from Function view, but adjusted using the right-side steering wheel keypad.
- 2 Home view – the initial view displayed when the screen is turned on.
- 3 App view – shows downloaded apps (third-party apps) as well as apps for integrated functions, such as **FM radio**. Tap an app icon to open that app.
- 4 Status bar – current vehicle activities are shown at the top of the screen. Network and connection information is shown to the left of the status bar. Media-related information, the clock and information about background activities are shown to the right.
- 5 Top view – pull the tab down to open Top view. From here, you can access **Settings**, **Owner's manual**, **Profile** and messages stored in the vehicle. In certain cases, contextual setting (e.g. **Navigation Settings**) and the contextual Owner's Manual (e.g. **Navigation Manual**) can also be accessed in Top view.

- 6 Navigation – takes you to map navigation with e.g. Sensus Navigation*. Tap the tile to expand it.
- 7 Media – most recently used media-related apps. Tap the tile to expand it.
- 8 Phone – used to access phone-related functions. Tap the tile to expand it.
- 9 Fourth tile – most recently used apps or vehicle functions not associated with the other tiles. Tap the tile to expand it.
- 10 Climate row - information and direct interaction to set temperature and seat heating for example*. Tap the symbol in the center of the climate bar to open Climate view and additional setting options.

NOTE

The climate system can be used to cool down the media system in the center display if needed. In these cases, the message **Climate system Cooling the infotainment system** will be shown in the instrument panel.

Related information

- Handling the center display (p. 110)
- Navigating in the center display's views (p. 113)

- Function view in the center display (p. 120)
- Apps (p. 472)
- Symbols in the center display status bar (p. 122)
- Changing settings in the center display's Top view (p. 130)
- Opening contextual setting in the center display (p. 131)
- Owner's Manual in the center display (p. 17)
- Media player (p. 491)
- Phone (p. 507)
- Climate system controls (p. 210)
- Turning off and adjusting the volume of the center display system sounds (p. 129)
- Changing the appearance of the center display (p. 129)
- Changing system language (p. 130)
- Changing system units of measurement (p. 130)
- Cleaning the center display (p. 625)
- Messages in the center display (p. 138)

⁴ In right-hand drive vehicles, these views are mirror images of the ones shown here.

Handling the center display

Many of the vehicle's functions and features can be controlled and adjusted from the center display. The center display is a touchscreen that reacts to taps and other gestures.

Using the center display's touchscreen

The screen reacts differently depending on whether it is touched by dragging, swiping or



tapping. It is possible to e.g. move between different views, mark objects and scroll in a list by touching the screen in various ways.





An infrared light curtain just above the surface of the screen enables the screen to detect when a finger is directly in front of the screen. This technology makes it possible to use the screen even while wearing gloves.

Two people can interact with the screen at the same time, e.g. to adjust climate system settings for both the driver and passenger sides.

! **CAUTION**
Do not use sharp objects on the screen as this could cause scratches.

The following table presents the various procedures for using the screen:

Procedure	Gesture	Result
	Tap once.	Marks an object, confirms a selection or activates a function.
	Double-tap.	Zooms in on a digital object, such as a map.
	Press and hold.	Grabs hold of an object so it can be moved. Can be used to move apps or points on a map. Press and hold your finger on the screen and drag the object to the desired position.
	Tap once with two fingers.	Zooms out from a digital object, such as a map.

Procedure	Gesture	Result
	<p>Drag</p>	<p>Moves between screen views or scrolls in a list, text or a view. Press and hold to drag apps or points on a map. Drag horizontally or vertically over the screen.</p>
	<p>Swipe</p>	<p>Moves between screen views or scrolls in a list, text or a view. Drag horizontally or vertically over the screen. Note that touching the upper part of the screen could cause Top view to open.</p>
	<p>Stretch</p>	<p>Zooms in.</p>
	<p>Pinch</p>	<p>Zooms out.</p>

◀◀ Returning to Home view from another view

1. Briefly press the home button below the center display.
 - > The most recent Home view mode will be displayed.
2. Press briefly again.
 - > All of the Home view's tiles will return to standard mode.

i NOTE

In Home view's standard mode – short press on the Home button. An animation describing access to the various views is shown on the screen.

Scrolling in lists, articles or views

A scroll indicator is displayed on the screen when it is possible to scroll up or down in the view. Swipe down/up anywhere in the view.

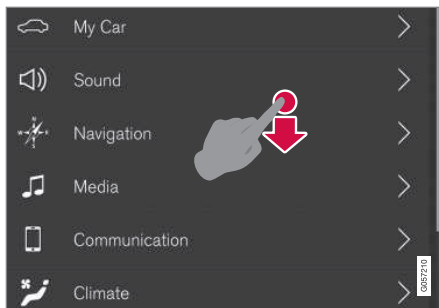

The scroll indicator will be shown in the center display when it is possible to scroll in the view.

Using the center display controls



Temperature control.

Digital controls are available for many of the vehicle's functions. For example, to set the temperature:

- drag the control to the desired temperature,
- tap + or – to raise or lower the temperature by degrees, or
- tap the desired temperature on the control.

Related information

- Activating and deactivating the center display (p. 113)
- Moving apps and buttons in the center display (p. 122)
- Using the center display keyboard (p. 124)

Activating and deactivating the center display

The center display can be temporarily switched off and reactivated using the home button under the screen.



Center display's home button.

When the home button is used, the screen will go dark and the touchscreen no longer reacts to touch. The climate bar will remain visible. All functions connected to the screen continue to operate, such as climate, audio, guiding* and apps. The center display screen can be cleaned when the display is dimmed. The dimming function can also be used to darken the screen so it is not a distraction while driving.

1. Press and hold the button beneath the screen.
 - > The screen will go dark (the climate bar will remain visible). All functions connected to the screen continue to operate.
2. To reactivate the screen, briefly press the Home button.
 - > The view that was displayed before the screen was turned off will be displayed again.

i NOTE

The screen cannot be turned off when a prompt to perform an action is being displayed on the screen.

i NOTE

The center display is turned off automatically when the engine is off and the driver's door is opened.

Related information

- Cleaning the center display (p. 625)
- Changing the appearance of the center display (p. 129)
- Center display overview (p. 108)

Navigating in the center display's views

There are five different basic views in the center display: Home view, Top view, Climate view, App view and Function view. The screen is automatically activated when the driver's door is opened.

Home view

Home view is the view displayed when the screen is activated. It consists of four tiles: **Navigation**, **Media**, **Phone** and a fourth tile.

An app or vehicle function selected from the App or Function views will start in the respective tile in Home view. **FM radio**, for example, will start in the **Media** tile.

The extra tile displays the most recently used app or vehicle function that is not related to the other three tiles.

The tiles display brief information about the respective apps.

i NOTE

When the vehicle is started, information on the current status of apps will be displayed in the respective tile in Home view.





NOTE

In Home view's standard mode – short press on the Home button. An animation describing access to the various views is shown on the screen.

NOTE

When the vehicle is moving:

- Certain functions (e.g. using the center display's keyboard) may be deactivated.
- Certain texts (e.g. those generated by apps) will be shortened to three rows. Tap the **Read out** button to have the entire message read aloud.
- Text messages will be shortened to one row. Tap the **Read out** button to have the entire message read aloud.

Status bar

Current vehicle activities are shown at the top of the screen in the status bar. Network and connection information is shown to the left of the status bar. Media-related information, the clock and information about background activities are shown to the right.

Top view

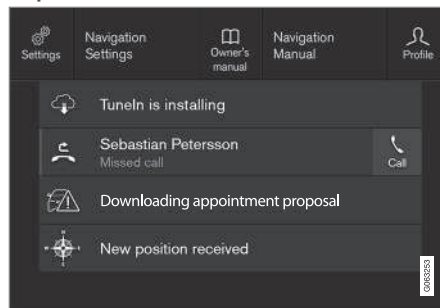

Top view when expanded.

There is a tab in the center of the status bar at the top of the screen. Open Top view by tapping the tab or by dragging/swiping from the top of the screen downward.

Top view always provides access to:

- **Settings**
- **Owner's manual**
- **Profile**
- The vehicle's stored messages.

In certain cases, Top view provides access to:

- Contextual setting (e.g. **Navigation Settings**). Change settings directly in Top view when an app (e.g. navigation) is being used.
- Contextual Owner's Manual (e.g. **Navigation Manual**). Access articles in

the digital Owner's Manual related to the content shown on the screen, directly in Top view.

To exit Top view, tap the screen outside Top view, press the Home button or tap the screen at the bottom of Top view and swipe upward. The views behind will become visible again and can be used.

NOTE

The top view is not available at start-up/shutdown or when a message is being shown on the screen. Similarly, it is not available when the climate view is shown.

Climate view

The climate bar is always visible at the bottom of the screen. The most common climate settings can be made directly there, such as setting temperature and seat heating*.



Tap the symbol in the center of the climate bar to open Climate view and access additional climate system settings.



Tap the symbol to close Climate view and return to a previous view.

App view

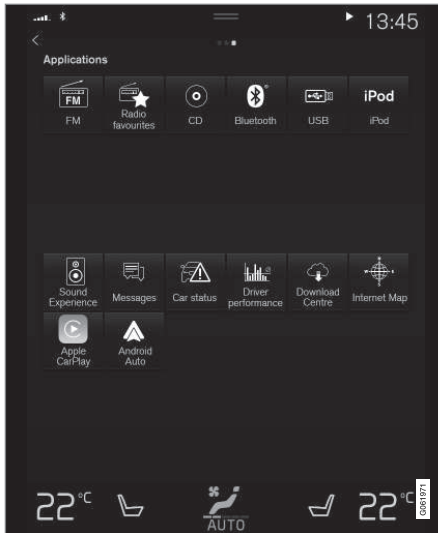

App view showing the vehicle's apps.

Swipe the screen from right to left⁵ to access the App view from the Home view. This view displays downloaded apps (third-party apps) as well as apps for integrated functions, such as **FM radio**. Brief information will be displayed directly in App view for certain apps, such as unread text messages for **Messages**.

Tap an app to open it. It will then be opened in its associated tile, e.g. **Media**.

Depending on the number of apps, it is possible to scroll down in App view. This is done by sweeping/dragging from the bottom upwards.

To return to Home view, swipe the screen from left to right⁵ or press the Home button.

Function view



Function view with buttons for various vehicle functions.

Swipe the screen from left to right⁵ to access Function view from Home view. From Function view, you can activate or deactivate various vehicle functions such as **BLIS***, **Lane Keeping Aid*** and **Park Assist***.

⁵ Applies for left-hand drive vehicles. For right-hand drive vehicles, swipe in the other direction.

- ◀◀ If there are many functions, you can also scroll downward through the view. This is done by sweeping/dragging from the bottom upwards.

Unlike in App view, where you tap an app to open it, in Function view, tapping a function activates or deactivates it. Certain functions (trigger functions) open in their own window when tapped.

To return to Home view, swipe the screen from right to left⁵ or press the Home button.

Related information

- Handling tiles in the center display (p. 117)
- Symbols in the center display status bar (p. 122)
- Changing settings in the center display's Top view (p. 130)
- Opening contextual setting in the center display (p. 131)
- Owner's Manual in the center display (p. 17)
- Driver profiles (p. 134)
- Climate system controls (p. 210)
- Apps (p. 472)
- Function view in the center display (p. 120)
- Center display overview (p. 108)

⁵ Applies for left-hand drive vehicles. For right-hand drive vehicles, swipe in the other direction.

Handling tiles in the center display

Home view consists of four tiles: **Navigation**, **Media**, **Phone** and a fourth tile. These views can be expanded.

◀ Expanding a tile from standard mode

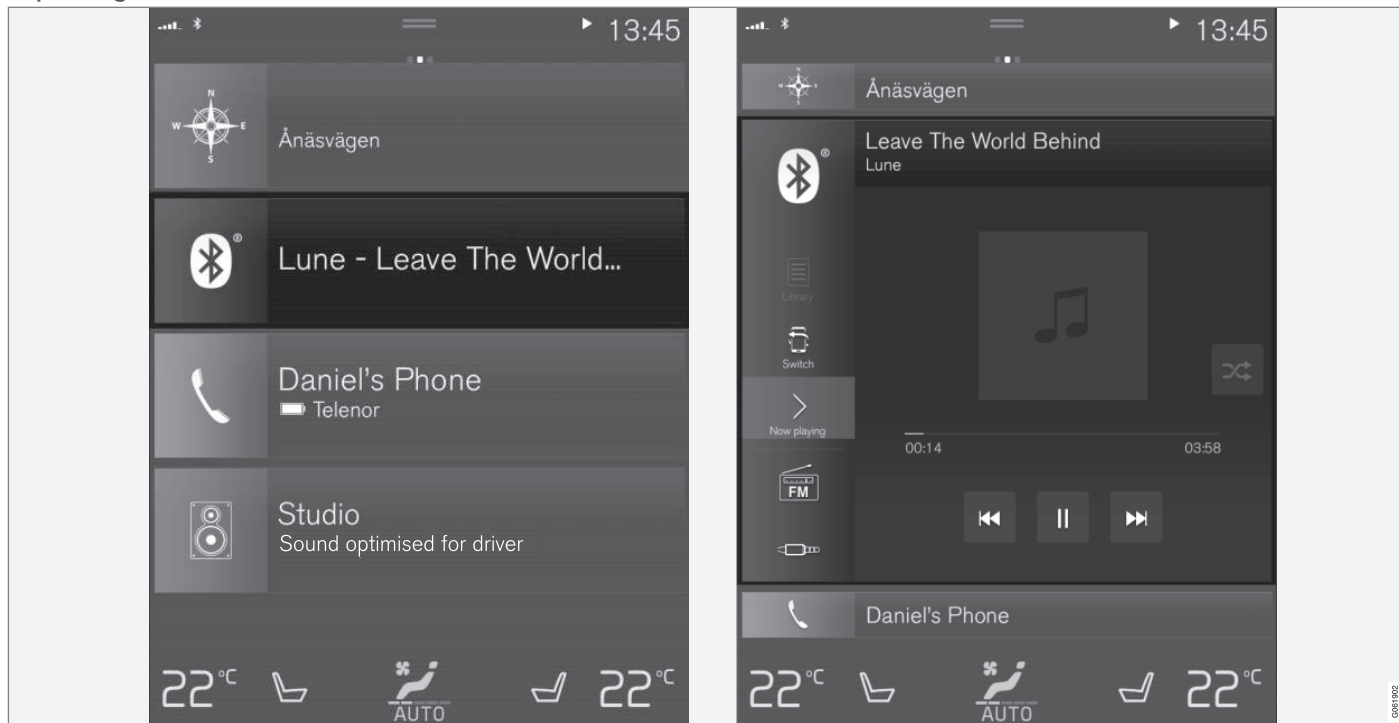

Standard mode and expanded mode of a tile in the center display.

Expanding a tile:

- For tiles **Navigation**, **Media** and **Phone**: Tap the screen anywhere in the tile. When a tile is expanded, the extra tile in Home view will be temporarily hidden. The other two tiles will be minimized and only show certain information. When the extra tile is tapped, the other three tiles are minimized and only certain information is displayed.

Expanded view provides access to the basic functions of the respective apps.

Closing an expanded tile:

- The tile can be closed in three different ways:
 - Tap the top section of the expanded tile.
 - Tap another tile (it will then be opened in expanded mode instead).
 - Press briefly on the Home button under the center display.

Opening or closing a tile in full-screen mode

The fourth tile⁶ and tile for **Navigation** can be opened in full-screen mode to show additional information and possible settings.

When a tile is opened in full-screen mode, no information from the other tiles is displayed.



In expanded mode, open the app in full-screen mode. Tap the symbol.



To return to expanded mode, tap the symbol or press the Home button under the screen.



Center display's home button.

You can always press the Home button to return to Home view. To return to Home view's standard view from full-screen mode, press the Home button twice.

Related information

- Handling the center display (p. 110)
- Activating and deactivating the center display (p. 113)
- Navigating in the center display's views (p. 113)

⁶ Does not apply to all apps or vehicle functions opened via the fourth tile.

Function view in the center display

Function view, which is one of the center display's basic views, contains all of the vehicle's function buttons. From the Home view,

navigate to Function view by swiping from left to right over the screen⁷.

Different types of buttons

There are three different types of buttons for vehicle functions; see below:

Type of button	Functions	Vehicle function affected
Function buttons	Have On/Off modes. When a function is active, an LED indicator light will illuminate to the left of the button's icon. Press the button to turn the function on or off.	Most buttons in Function view are function buttons.
Trigger buttons	Do not have On/Off modes. Pressing a trigger button opens a window for the function. This can be, for example, a window to change seat position.	<ul style="list-style-type: none"> • Camera • Headrest Fold • Head-up Display Adjustments
Parking buttons	Have On/Off and scanning modes. Similar to function buttons, but have an extra mode for parking scanning.	<ul style="list-style-type: none"> • Park In • Park Out

⁷ Applies for left-hand drive vehicles. For right-hand drive vehicles, swipe in the other direction.

Button modes



When a function or parking button's LED indicator is green, the function is activated (on). For some functions, an additional text explaining the function will be shown when the function is initially activated. The text will be displayed for a few seconds and then the button will be displayed with the LED indicator illuminated.

For **Lane Keeping Aid**, for example, the text **Works only at certain speeds** will be displayed when the button is pressed.

Press the button once briefly to activate or deactivate the function.

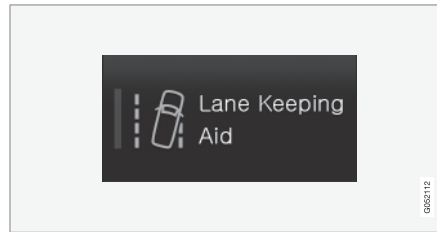

The function is deactivated when the LED indicator light is switched off.

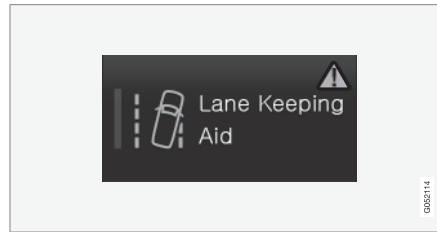

A warning triangle in the right-hand section of the button indicates that something is not working correctly.

Related information

- Handling the center display (p. 110)
- Navigating in the center display's views (p. 113)

Moving apps and buttons in the center display

The apps and buttons for vehicle functions can be moved and organized in the App and Function views.

1. Swipe from right to left⁸ to access App view or swipe from left to right⁸ to access Function view.
2. Press and hold an app or button.
 - > The app or button will change size and become slightly transparent. It can then be moved.
3. Drag the app or button to an available position in the view.

A maximum of 48 rows can be used to position apps or buttons. To move an app or button outside the visible view, drag it to the bottom of the view. New rows will be added and the app or button can be placed in one of these.

Apps or buttons placed below the view's normal display will not be visible on the screen.

Swipe the screen to scroll up or down in the view to display information outside the view.

NOTE
Hide the apps that are rarely or never used by moving them far down, outside of the visible view. This makes it easier to find the apps used more frequently.

NOTE
Apps and vehicle function buttons cannot be situated at spots already in use.







Related information

- Function view in the center display (p. 120)
- Apps (p. 472)
- Handling the center display (p. 110)













Symbols in the center display status bar

Overview of symbols displayed in the center display status bar.

The status bar shows current vehicle activities and in certain cases, also their status. Due to the limited space in the status bar, not all symbols will be displayed at all times.

Symbol	Meaning
	Connected to the Internet.
	Roaming activated.
	Cell phone network signal strength.
	Bluetooth device connected.
	Bluetooth activated but no device connected.
	Information sent to and from GPS.
	Connected to Wi-Fi network.

⁸ Applies for left-hand drive vehicles. For right-hand drive vehicles, swipe in the other direction.

Symbol	Meaning
	Tethering activated (Wi-Fi hot-spot). This means that the vehicle shares an available Internet connection.
	Vehicle modem activated.
	USB sharing active.
	Action in progress.
	Timer for preconditioning active. ^A
	Audio source being played.
	Audio source paused.
	Phone call in progress.
	Audio source muted.
	News broadcasts from current radio station. ^B
	Traffic information being received. ^B
	Clock.

^A Only hybrid models.

^B Not available in all markets.

Related information

- Navigating in the center display's views (p. 113)
- Messages in the center display (p. 138)
- Internet-connected vehicle* (p. 516)
- Connecting a device via the USB port (p. 498)
- Phone (p. 507)
- Date and time (p. 92)

Using the center display keyboard

You can use the keyboard in the center display to enter characters or to switch to handwriting mode to "write" letters and characters on the screen.

The keyboard can be used to enter characters (letters, numbers, symbols, etc.) to e.g. send text messages from the vehicle, enter passwords or search for information in the digital Owner's Manual.

The keyboard will only appear when it is possible to enter text on the screen.

NOTE

The keyboard cannot be used while the vehicle is moving.

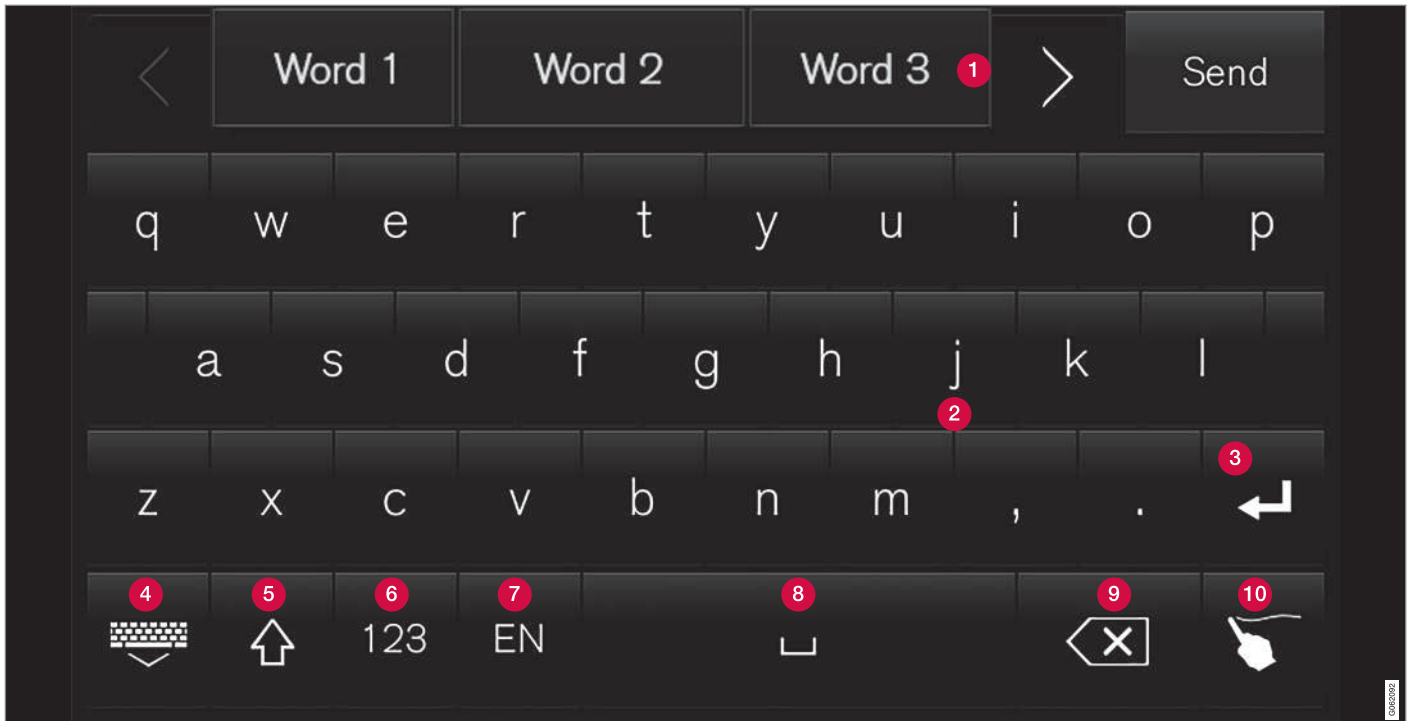

The illustration shows an overview of some of the buttons that may be shown on the keyboard. The appearance may vary depending on language settings and the context in which the keyboard is used.

- ◀ 1 Row showing suggestions for words or characters⁹. The suggested words change as new letters are entered. Scroll through the list of suggested words by tapping the right or left arrows. Tap a suggestion to select it. Please note that this function is not available in all languages. When unavailable, this row will not be shown on the keyboard.
- 2 Available characters are adapted to the language selected for the keyboard (see number 7 below). Tap a character to enter it.
- 3 Different buttons are displayed here depending on the context in which the keyboard is used, e.g. @ to enter an email address or the return key to **start a new line**.
- 4 This button hides the keyboard. In cases where this is not possible, the button will not be displayed.
- 5 Used to enter uppercase letters. Tap once to enter one uppercase letter and then continue with lowercase letters. Tap twice for caps lock (all text will be entered in uppercase letters). Tap again to return the keyboard to lowercase letters. In this mode, the first letter after a period, exclamation point or question mark will be automatically entered in uppercase form.

- 6 Used to enter numbers. The number keyboard (2) will then be displayed. Tap ABC, which is shown instead of 123 in number mode, to return to the keyboard with letters, or #\~ to display the keyboard with special characters.
- 7 Used to change the keyboard language, e.g. EN. The available characters and word suggestions (1) vary depending on the selected language. In order to toggle between keyboard languages, the languages must first be added under Settings.
- 8 Space bar.
- 9 Delete. Tap to delete characters one at a time. Press and hold to delete multiple characters quickly.
- 10 Used to change to handwriting mode. Tap the confirm button over the keyboard (not shown in illustration) once to confirm the text

that has been entered. The button's appearance differs depending on the context.

Variants of letters or characters

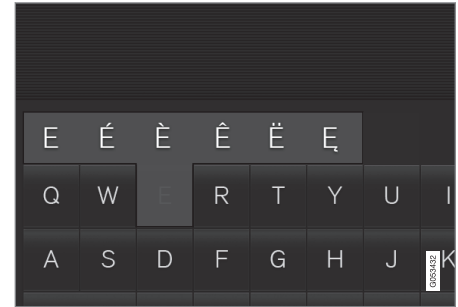

Variants of a letter or character, e.g. é or è, can be entered by pressing and holding the letter or character. A box containing possible variants of the letter or character will appear. Tap the desired variant. If no variant is selected, the original letter/character will be used.

Related information

- Changing keyboard language in the center display (p. 127)
- Entering characters, letters and words by hand in the center display (p. 127)
- Handling the center display (p. 110)
- Handling text messages (p. 512)

⁹ For Asian languages.

Changing keyboard language in the center display

In order to toggle between keyboard languages, the languages must first be added under **Settings**.

Adding or deleting languages in Settings

The keyboard is automatically set to the same language as the system language. The keyboard language can be manually changed without affecting the system language.

1. Tap **Settings** in Top view.
2. Tap **System** → **System Languages and Units** → **Keyboard Layouts**.
3. Select one or more languages in the list.
 - > It is now possible to toggle between the selected languages using the keyboard.

If no language has been selected under **Settings**, the keyboard will remain in the same language as the vehicle's system language.

Toggling between keyboard languages



If more than one language has been selected in **Settings**, the button in the keyboard can be used to switch between the different languages.

To toggle between keyboard languages from the list:

1. Press and hold the button.
 - > A list will appear.
2. Select the desired language. If more than four languages have been selected under **Settings**, you can scroll through the list shown on the keyboard.
 - > The keyboard and word suggestions will be adapted to the selected language.

To change keyboard language without displaying the list:

- Tap the button.
 - > The keyboard layout will change to the next language in the list without displaying the list.

Related information

- Changing system language (p. 130)
- Using the center display keyboard (p. 124)

Entering characters, letters and words by hand in the center display

Characters, letters and words can be entered in the center display by handwriting them on the touchscreen.



Tap the button on the center display's keyboard to switch from the keyboard to handwriting mode.

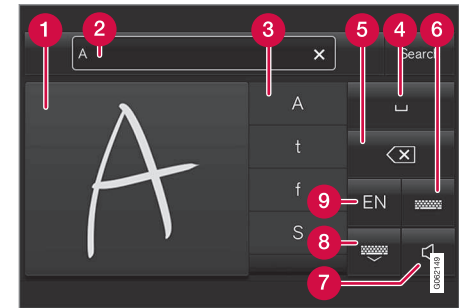

- 1 Space for entering characters/letters/ words/parts of words.
- 2 Text field displaying suggested characters or words¹⁰ as they are written on the screen (1).

¹⁰ Certain system languages only.

- ◀ 3 Suggestions for characters/letters/words/parts of words. You can scroll through the list.
- 4 Space bar. Blank spaces can be created by writing a dash (–) in the field for handwritten letters (1). See "Writing blank spaces in free-text fields" below.
- 5 Delete. Tap once to erase one character/letter at a time. Wait a moment before tapping again to erase the next character, letter etc.
- 6 Return to the standard keyboard layout.
- 7 Switch off/on screen tap sounds.
- 8 Hide the keyboard. In cases where this is not possible, the button will not be displayed.
- 9 Change language for text input.

Handwriting characters/letters/words

1. Write a character, a letter, a word or parts of a word in the field for handwritten letters (1). Write the word or part of the word vertically or horizontally.
 - > A number of suggestions for characters, letters or words will be displayed (3). The most likely will be shown at the top of the list.

! **CAUTION**

Do not use sharp objects on the screen as this could cause scratches.

2. The character/letter/word will be entered automatically after a short pause if no other action is taken.
 - > The character/letter/word at the top of the list will be used. Tap one of the other characters/letters/words in the list to use it instead.

Erasing/changing handwritten characters/letters

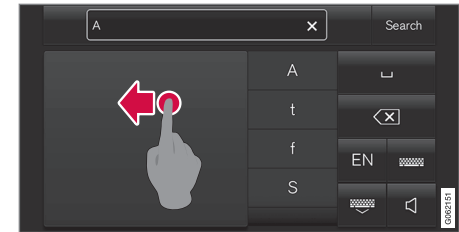

Erase text in the text field (2) by swiping over the handwriting field (1).

- Characters/letters can be erased or changed in several ways:
 - Tap the desired letter or word in the list (3).
 - Tap the delete button (5) to erase the letter and start again.
 - Swipe horizontally from right to left¹¹ over the handwriting field (1). Erase several letters at once by swiping over the area several times.
 - Tap the X box in the text field (2) to erase all written text.

¹¹ For Arabic keyboards, swipe in the other direction. Swiping from right to left will create a blank space.

New lines in free-text fields in handwriting mode

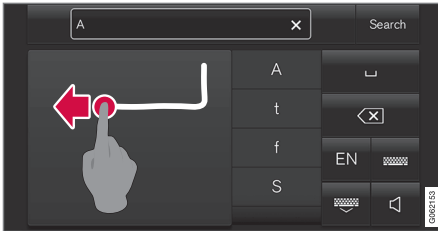

Create a new line by drawing above the characters in the handwriting field as shown in the illustration¹².

Writing blank spaces in free-text fields

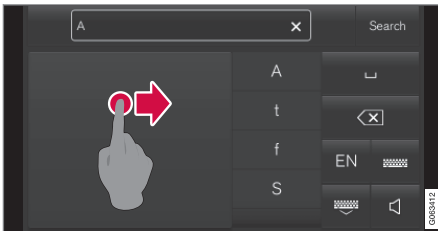

Make a blank space by drawing a line from left to right¹³.

Related information

- Using the center display keyboard (p. 124)

Changing the appearance of the center display

The appearance of the center display can be changed by selecting a different theme.

1. Tap **Settings** in the Top view.
2. Tap **My Car** → **Displays** → **Display Themes**.
3. Select a theme, e.g. **Minimalistic** or **Chrome Rings**.

In addition to these themes, you can also choose between **Normal** and **Bright**. In **Normal**, the background of the screen is dark and the text is light. This option is the default setting for all themes. If the bright version is selected, the background will be light and the text will be dark. This option can, for example, make the screen easier to see in bright day-light conditions.

These alternatives are always available for selection and are not affected by the ambient lighting.

Related information

- Changing settings in the center display's Top view (p. 130)
- Activating and deactivating the center display (p. 113)
- Cleaning the center display (p. 625)

Turning off and adjusting the volume of the center display system sounds

The volume of the center display system sounds can be adjusted or turned off completely.

1. Tap **Settings** in the Top view in the center display.
2. Tap **Sound** → **System Volumes**.
3. Pull the control under **Touch Sounds** to adjust the volume or turn off screen tap sounds. Pull the control to the desired sound level.

Related information

- Center display overview (p. 108)
- Changing settings in the center display's Top view (p. 130)
- Sound settings (p. 470)

¹² For Arabic keyboards, draw the same character, but in mirror image.

¹³ For Arabic keyboards, draw the line from right to left.

Changing system units of measurement

Unit settings are adjusted in the **Settings** menu in the center display.

1. Tap **Settings** in the Top view in the center display.
2. Proceed to **System → System Languages and Units → Units of Measurement**.
3. Choose a measurement standard:
 - **Metric** - kilometers, liters and degrees Celsius.
 - **Imperial** - miles, gallons and degrees Celsius.
 - **US** - miles, gallons and degrees Fahrenheit.

> The units in the instrument panel, center display and head-up display are changed.

Related information

- Center display overview (p. 108)
- Changing settings in the center display's Top view (p. 130)
- Changing system language (p. 130)

Changing system language

Language settings are adjusted in the **Settings** menu in the center display.

NOTE

Changing languages in the center display could mean that certain owner's information will not comply with national or local laws and regulations. Do not change to a language you do not speak well, as it can be difficult to find your way back through the menu.

1. Tap **Settings** in the Top view in the center display.
2. Proceed to **System → System Languages and Units**.
3. Select **System Language**.

A voice control symbol indicates that the language can be used for voice commands.

> Languages in the instrument panel, center display and head-up display are changed.

Related information

- Center display overview (p. 108)
- Changing settings in the center display's Top view (p. 130)
- Changing system units of measurement (p. 130)

Changing settings in the center display's Top view

You can change settings and information for many of the vehicle's functions via the center display.

1. Open Top view by tapping the tab at the top of the screen or by dragging/swiping from the top of the screen downward.
2. Tap **Settings** to open the Settings menu.

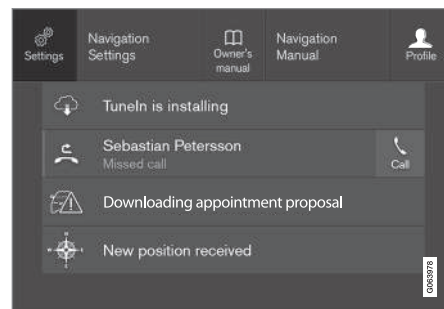

Top view with **Settings** button.

3. Tap one of the categories and sub-categories to navigate to the desired setting.
4. Change the setting(s). Different types of settings are changed in different ways.
 - > Changes are saved immediately.

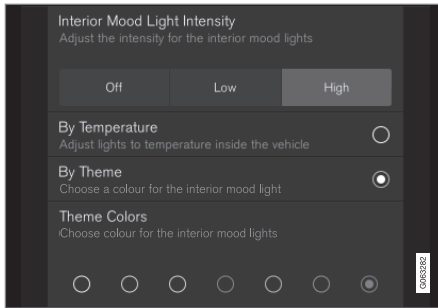

A sub-category in the Settings menu with various possible settings; has a multi-selection button and radio buttons.

Related information

- Center display overview (p. 108)
- Resetting center display settings (p. 132)
- Table of settings in the center display (p. 133)

Opening contextual setting in the center display

Most of the settings for the vehicle's basic apps can be changed directly in Top view in the center display via contextual settings.

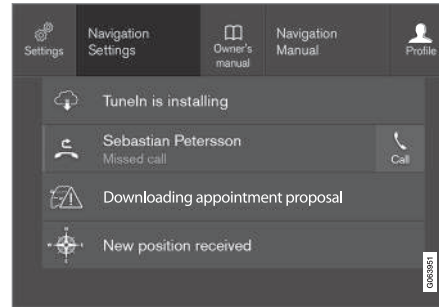

Top view with button for contextual settings.

Contextual setting is a shortcut for accessing specific settings related to the active function displayed on the screen. Apps that are factory-installed in your vehicle, e.g. **FM radio** and **USB**, are part of Sensus and are used to control the vehicle's integrated functions. The settings for these apps can be changed directly via contextual setting in Top view.

When contextual setting is available:

1. Pull down Top view when an app is in expanded form, e.g. **Navigation**.

2. Tap **Navigation Settings**.

> The navigation settings page will open.

3. Change the desired settings and confirm.

Tap **Close** or press the Home button under the center display to close Settings view.

Most of the vehicle's basic apps have this contextual setting option, but not all.

Third-party apps

Third-party apps are apps that are not factory-installed in the vehicle's system, but can be downloaded, e.g. **Volvo ID**. Settings for these apps are changed in the apps themselves, not in Top view.

Related information

- Changing settings in the center display's Top view (p. 130)
- Center display overview (p. 108)
- Resetting center display settings (p. 132)
- Download apps (p. 473)

Resetting user data when the vehicle changes owners

If the vehicle changes owners, all user data and system settings should be reset to factory defaults.

Vehicle settings can be reset at different levels. Reset all user data and system settings to their original factory defaults when the vehicle changes owner. It is also important to change the owner of the Volvo On Call service.

Related information

- Resetting center display settings (p. 132)
- Resetting driver profile settings (p. 138)

Resetting center display settings

All settings made in the center display's Settings menu can be reset to default values.

Two types of reset

There are two types of reset in the Settings menu:

- **Factory Reset**- erases all data and files and resets all settings to factory default.
- **Reset Personal Settings**- erases personal data and resets personalized settings to factory default.

Resetting settings

Follow these instructions to reset the settings.

NOTE

Factory Reset is only possible when the vehicle is stationary.

1. Tap **Settings** in the center display's Top view.
2. Proceed to **System** → **Factory Reset**.
3. Select the type of reset you would like to do.
 - > A pop-up window will appear.

4. Tap **OK** to confirm the reset.

For **Reset Personal Settings**, confirm the reset by tapping **Reset for the active profile** or **Reset for all profiles**.

> The selected settings will be reset.

Related information

- Center display overview (p. 108)
- Changing settings in the center display's Top view (p. 130)
- Table of settings in the center display (p. 133)

Table of settings in the center display

The center display's Settings menu has a number of main categories and sub-categories that contain settings and information for many of the vehicle's features and functions. There are seven main categories: **My Car**, **Sound**, **Navigation**, **Media**, **Communication**, **Climate** and **System**.

Each category, in turn, contains a number of sub-categories and possible settings. The table below shows the first level of sub-categories. The possible settings for a function or an area are described in more detail in their respective sections of the Owner's Manual.

Some settings are personal, which means that they can be saved to a **Driver Profiles**. Others are global, which means that they are not linked to a driver profile.

My Car

Sub-categories
Displays
IntelliSafe
Drive Preferences/Individual Drive Mode*
Lights and Lighting
Mirrors and Convenience

Sub-categories
Locking
Parking Brake and Suspension
Wipers
Sound
Sub-categories
Tone
Balance
System Volumes
Navigation
Sub-categories
Map
Route and Guidance
Traffic
Media
Sub-categories
AM/FM Radio
SiriusXM
SiriusXM Travel Link

Sub-categories
Gracenote®
Video
Communication
Sub-categories
Phone
Text Messages
Android Auto*
Apple CarPlay*
Bluetooth Devices
Wi-Fi
Vehicle Wi-Fi Hotspot
Vehicle Modem Internet
Volvo On Call
Volvo Service Networks

Climate

The **Climate** main category does not have any sub-categories.



◀ System

Sub-categories
Driver Profile
Date and Time
System Languages and Units
Privacy and Data
Keyboard Layouts
Voice Control*
Factory Reset
System Information

Related information

- Center display overview (p. 108)
- Changing settings in the center display's Top view (p. 130)
- Resetting center display settings (p. 132)

Driver profiles

Many of the vehicle's settings can be customized to the driver's personal preferences and saved in one or more driver profiles.

These personal settings are automatically saved in the active driver profile. Each key can be linked to one driver profile. When the linked key is used, the vehicle is customized to the specific settings of that driver profile.

Which settings are saved in driver profiles?

Many of the settings made in the vehicle will be automatically stored in the active driver profile if the profile is not protected. The vehicle has settings that can be made either personal or global. The personal settings are saved in driver profiles.

Settings that can be saved in a driver profile include, among other things, screens, mirrors, front seats, navigation*, audio and media system, language and voice control.

Some settings are global settings. These settings can be changed but are not saved to a specific driver profile. Changes to global settings affect all profiles.

Global settings

Global settings do not change when driver profiles are changed. They remain the same regardless of which driver profile is currently active.

Keyboard layout is an example of a global setting. If driver profile X is used to add additional keyboard languages, these languages will also be available for driver profile Y. The settings for keyboard layout are not saved to a specific driver profile - the settings are global.

Personal settings

If driver profile X has been used to e.g., set the brightness for the center display, driver profile Y will not be affected by this setting. It will only be saved to driver profile X because brightness setting is a personal setting.

Related information

- Selecting a driver profile (p. 135)
- Changing a driver profile's name (p. 135)
- Linking a remote key to a driver profile (p. 136)
- Protecting a driver profile (p. 136)
- Resetting driver profile settings (p. 138)
- Table of settings in the center display (p. 133)

Selecting a driver profile

When the center display starts up, the selected driver profile will be shown at the top of the screen. The most recently used driver profile will be active the next time the vehicle is unlocked. A different driver profile can be selected once the vehicle has been unlocked. However, if the remote key has been linked to a driver profile, this profile will be used instead.

There are three options for switching between driver profiles.

Option 1:

1. Tap the name of the driver profile shown at the top of the center display when the display starts up.
 - > A list will appear, showing driver profiles that can be selected.
2. Select desired driver profile.
3. Tap **Confirm**.
 - > The driver profile has now been selected and the system will load the settings stored in that profile.

Option 2:

1. Pull down Top view in the center display.
2. Tap **Profile**.
 - > The same list as in option 1 will be displayed.

3. Select desired driver profile.
4. Tap **Confirm**.
 - > The driver profile has now been selected and the system will load the settings stored in that profile.

Option 3:

1. Pull down Top view in the center display.
2. Tap **Settings** in the Top view in the center display.
3. Tap **System** → **Driver Profiles**.
 - > A list will appear, showing driver profiles that can be selected.
4. Select desired driver profile.
 - > The driver profile has now been selected and the system will load the settings stored in that profile.

Related information

- Driver profiles (p. 134)
- Navigating in the center display's views (p. 113)
- Changing a driver profile's name (p. 135)
- Linking a remote key to a driver profile (p. 136)

Changing a driver profile's name

It is possible to change the names of the different driver profiles used in the vehicle.

1. Tap **Settings** in the Top view in the center display.
2. Tap **System** → **Driver Profiles**.
3. Select **Edit Profile**.
 - > A menu will open in which the driver profile can be changed.
4. Tap the **Profile Name** box.
 - > A keyboard will be displayed and can be used to change the name. Tap  to close the keyboard.
5. Save the name change by pressing **Back** or **Close**.
 - > The name has now been changed.

NOTE

Profile names may not begin with a space. If a space is entered first, the profile name will not be saved.

Related information

- Selecting a driver profile (p. 135)
- Using the center display keyboard (p. 124)

Protecting a driver profile

It may not always be desirable to store settings made in the vehicle to the active driver profile. In these instances, the driver profile can be protected.

NOTE

Protecting a driver profile is only possible when the vehicle is stationary.

To protect a driver profile:

1. Tap **Settings** in the Top view in the center display.
2. Tap **System → Driver Profiles**.
3. Select **Edit Profile**.
 - > A menu will open in which the driver profile can be changed.
4. Tap **Protect Profile** to protect the profile.

5. Confirm your selection to protect the profile by tapping **Back/Close**.

- > When the profile is protected, settings made in the vehicle will not be automatically stored to the profile. The changes must instead be saved manually under **Settings → System → Driver Profiles → Edit Profile** by tapping **Save current settings to the profile**. If the profile is not protected, the settings will be automatically stored to the profile.

Related information

- Driver profiles (p. 134)

Linking a remote key to a driver profile

A remote key can be linked to a driver profile. This driver profile and all of its settings will then automatically be selected every time the vehicle is used with that particular remote key.

The first time the remote key is used, it is not linked to any specific driver profile. The **Guest** profile is automatically activated when the ignition is switched on.

A driver profile can also be selected manually without linking it to any key. When the vehicle is unlocked, the last active driver profile will be activated. If the key has ever been linked to a driver profile, it is not necessary to manually select a driver profile when using that particular key.

Linking a remote key to a specific driver profile

NOTE

A remote key can only be connected to a driver profile when the vehicle is stationary.

First select the profile you would like to link to the key (if that profile is not already active).

The active profile can then be linked to the key.

1. Tap **Settings** in the Top view in the center display.
2. Tap **System** → **Driver Profiles**.
3. Mark the desired profile. The display will return to Home view. The **Guest** profile cannot be linked to a remote key.
4. Pull down Top view again and tap **Settings** → **System** → **Driver Profiles** → **Edit Profile**.

5. Select **Connect key** to link the profile with the key. A driver profile can only be linked to the key currently being used in the vehicle. If there are any other keys in the vehicle, **More than one key is found, put the key you want to connect on backup reader** will be displayed.

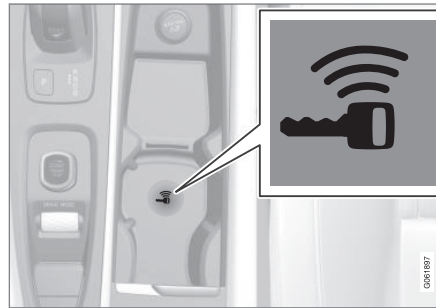

Location of the backup reader in the tunnel console.
 > When **Profile connected to key** is displayed, the key and driver profile have been linked.

6. Tap **OK**.
 - > The key used is now linked to the driver profile and will remain so as long as the **Connect key** box is not deselected.

Related information

- Driver profiles (p. 134)
- Changing a driver profile's name (p. 135)

- Remote key (p. 236)

Resetting driver profile settings

Settings that have been saved for one or more driver profiles can be reset when the vehicle is stationary.

i NOTE
Factory Reset is only possible when the vehicle is stationary.

1. Tap **Settings** in the Top view.
2. Tap **System** → **Factory Reset** → **Reset Personal Settings**.
3. Select option **Reset for the active profile**, **Reset for all profiles** or **Cancel**.

Related information

- Driver profiles (p. 134)
- Resetting center display settings (p. 132)

Messages in the center display

The center display shows messages in certain circumstances to inform or assist the driver.

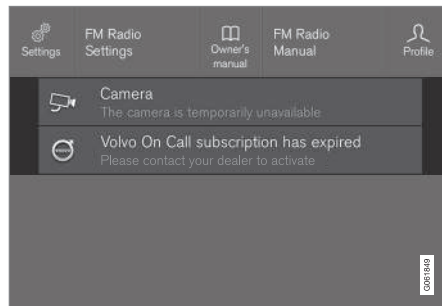

Example of message in the center display's Top view.

Messages with lower priority for the driver are shown in the center display.

Most of the messages are shown in the center display's status bar. The message will disappear from the status bar after a short period of time or after the required action has been taken. Messages that need to be saved are stored in Top view in the center display.

The message may be shown along with graphics, symbols or a button to e.g. activate/deactivate a function connected to the message.

Pop-up messages

Messages are sometimes shown as pop-up windows. Pop-up messages have a higher pri-

ority than messages shown in the status bar and require acknowledgment/action before they disappear.

Related information

- Handling messages in the center display (p. 139)
- Handling messages saved from the center display (p. 139)
- Messages in the instrument panel (p. 104)

Handling messages in the center display

Messages in the center display are handled in the center display's views.

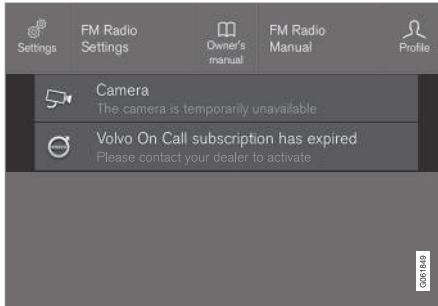

Example of message in the center display's Top view.

Some messages in the center display have a button (or several buttons in a pop-up message) to e.g. activate/deactivate a function related to the message.

Handling new messages

For messages with buttons:

- Tap the button to perform the action or let the message automatically time-out after a short period.
 - > The message will disappear from the status bar.

For messages without buttons:

- Close the message by tapping it or let the message automatically time-out after a short period.
 - > The message will disappear from the status bar.

Messages that need to be saved are stored in Top view in the center display.

Related information

- Messages in the center display (p. 138)
- Handling messages saved from the center display (p. 139)
- Messages in the instrument panel (p. 104)

Handling messages saved from the center display

Messages saved from the instrument panel and center displays are handled in the center display.

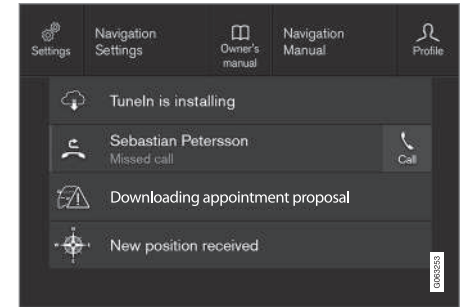

Examples of saved messages and possible selections in Top view.

Messages that have been shown in the center display and that need to be saved are stored in the center display's Top view.

◀ Reading saved messages

1. Open Top view in the center display.
 - > A list of saved messages will be displayed. Messages with an arrow to the right can be expanded.
2. Tap a message to expand/minimize it.
 - > More information about the message will appear in the list and the image to the left of the app will display information about the message in graphic form.

Handling saved messages

Some messages have a button to e.g. activate/deactivate a function related to the message.

- Tap the button to perform the action.

Saved messages in Top view are automatically deleted when the ignition is switched off.

Related information

- Messages in the center display (p. 138)
- Handling messages in the center display (p. 139)
- Messages in the instrument panel (p. 104)

Head-up display*

The head-up display is a complement to the instrument panel and projects information from the instrument panel onto the windshield. The projected images can only be seen from the driver's seat.



The head-up display projects warnings and information related to speed, cruise control functions, navigation, etc. onto the windshield in the driver's field of vision. Traffic information and incoming phone calls can also be shown on the head-up display.

i NOTE

The driver's ability to see information in the head-up display may be impeded by

- the use of polarizing sunglasses
- a driving posture in which the driver is not centered in the seat
- objects on the display unit's glass cover
- unfavorable lighting conditions.

i CAUTION

The information is projected from a display unit located in the dashboard. To help prevent damage to the display unit's glass cover, do not place any objects on the glass and prevent objects from falling onto it.

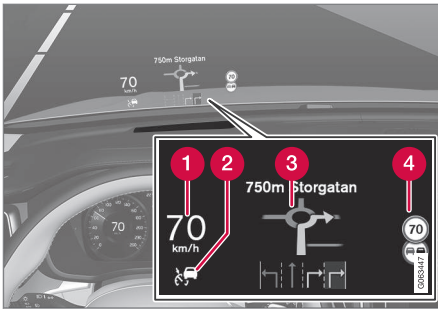

Examples of what might be shown on the display.

- 1 Speed
- 2 Cruise control
- 3 Navigation
- 4 Road signs

A number of symbols may be projected temporarily onto the head-up display including:



If the warning symbol appears, read the warning message in the instrument panel.



If the information symbol appears, read the warning message in the instrument panel.



The snowflake symbol will illuminate if there is a risk of slippery conditions.

NOTE

People with certain types of vision problems may experience headaches or eye strain when using the head-up display.

City Safety in head-up-display

If a collision warning is given, the information in the head-up display will be replaced by a City Safety warning signal. This graphic will illuminate even if the head-up display is turned off.

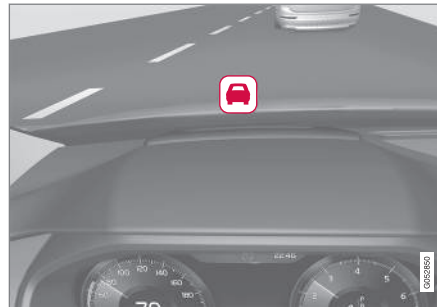

The warning symbol for City Safety will flash to get the driver's attention if there is a risk of collision.

Related information

- Activating and deactivating the head-up display* (p. 142)
- Cleaning the head-up display* and instrument panel (p. 626)
- Replacing a windshield with head-up display* (p. 593)

Activating and deactivating the head-up display*

The head-up display can be activated and deactivated when the vehicle has been started.



Press the **Head-up Display** button in the center display's Function view. An indicator light in the button will illuminate when the function is activated.

Related information

- Head-up display settings* (p. 142)
- Head-up display* (p. 140)

Head-up display settings*

Adjusting settings for the head-up display. Settings can be adjusted when the vehicle is started and a projected image is displayed on the windshield.

Selecting display options

Select the functions to be shown in the head-up display.

1. Tap **Settings** in the center display's Top view.
2. Tap **My Car** → **Displays** → **Head-Up Display Options**.
3. Select one or more functions:
 - **Show Navigation**
 - **Show Road Sign Information**
 - **Show Driver Support**
 - **Show Phone**

This setting is stored as a personal setting in the driver profile.

Adjusting brightness and height position



1. Press the **Head-up Display Adjustments** button in the center display's Function view.
2. Adjust the brightness of the projected image and the height position in the driver's field of vision using the right-side steering wheel lever.

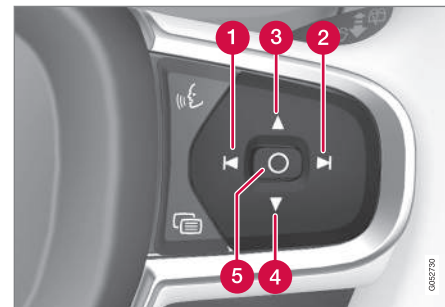

- 1 Decreasing brightness
- 2 Increasing brightness

- 3 Raising position
- 4 Lowering position
- 5 Confirm

The brightness of the graphic is automatically adapted to the light conditions in its background. Brightness is also affected by adjustments to the brightness of the other displays in the vehicle.

The height position can be stored in the front power seat's* memory function using the keypad in the driver's door.

Calibrating the horizontal position

If the windshield or display unit has been replaced, the head-up display's horizontal position may need to be calibrated. Calibration means that the projected image is rotated clockwise or counterclockwise.

1. Tap **Settings** in the center display's Top view.
2. Select **My Car** → **Displays** → **Head-Up Display Options** → **Head-Up Display Calibration**.
3. Calibrate the horizontal position of the image using the right-side steering wheel keypad.

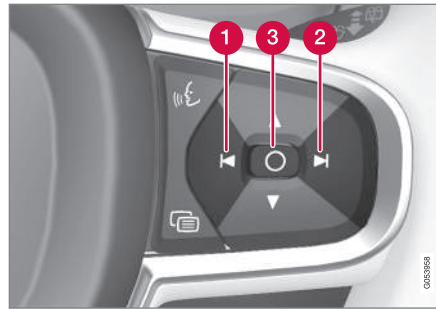

- 1 Rotate counterclockwise
- 2 Rotate clockwise
- 3 Confirm

Related information

- Head-up display* (p. 140)
- Activating and deactivating the head-up display* (p. 142)
- Driver profiles (p. 134)
- Storing positions for seats, mirrors and head-up display* (p. 184)

Voice Control

Voice control¹⁴ allows you to control functions in the vehicle, e.g. the climate control system, radio or a Bluetooth-connected phone, using spoken commands. In vehicles equipped with Sensus Navigation*, the navigation system can also be controlled using voice commands.

What is voice control?

Voice control is a driver support function that can simplify the use of various commands in your vehicle. It works in general like a regular application in which you input information in a set order in order to perform a task, but instead of typing on a keypad, you use voice commands. It can therefore be a good idea to familiarize yourself with how, and in what order, a voice command should be spoken to get the desired result.

You can control certain infotainment and climate control functions through the voice control system by using voice commands. The system can respond verbally and by displaying information in the instrument panel.

¹⁴ Certain markets only.



⚠ WARNING

The driver is always responsible for ensuring that the vehicle is operated in a safe manner and that all applicable traffic regulations are followed.

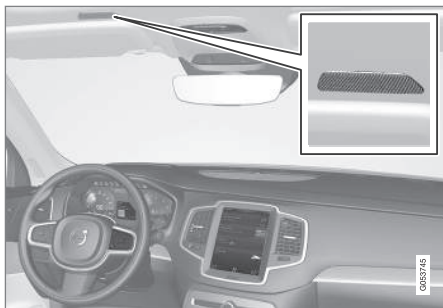

Voice control microphone

System updates

The voice control system is continuously improved. It is recommended to always have the latest version installed.

Download updates at volvocars.com/support.

ℹ NOTE

Not all system languages support voice control. If a language supports voice control, it is marked with a  symbol in the list of available system languages. Read more about where the information is found in the section on voice control settings.

Related information

- Use voice recognition (p. 144)
- Voice control for cellular phones (p. 146)
- Voice control for radio and media (p. 147)
- Climate control system voice commands (p. 200)
- Voice control settings (p. 148)

Use voice recognition

Starting voice control¹⁵



Voice commands are given through a "dialog" with the voice control system. Press the button for voice control  on the right-side steering wheel keypad to activate the system and initiate a voice command dialog. When you press the button, a beep will sound and the voice control symbol will appear in the instrument panel.

This shows that the system has begun listening and you can now begin speaking commands. As soon as you start speaking, the system will be trained to recognize and understand your voice. This takes several seconds and is done automatically, which means that you don't need to manually initiate any voice training.

¹⁵ Certain markets only.

These may include:

- Wait until after the tone, and then speak in your normal voice at a normal speed.
- Do not speak while the system is responding (the system is unable to process commands during this time).
- Avoid background noises in the passenger compartment by keeping doors, windows and the panoramic roof* closed.

i NOTE

Not all system languages support voice control. If a language supports voice control, it is marked with a  symbol in the list of available system languages. Read more about where the information is found in the section on voice control settings.



Generally, the system will listen for a basic command that is then followed by more detailed commands specifying what you want the system to do.

To change the audio volume of the system, turn the volume knob while the voice is speaking. It is possible to use other buttons while voice commands are being given. However, because other audio is silenced during dialog with the system, it is not possible to perform

any functions connected to audio using the buttons.

Canceling voice control

To cancel voice control, do one of the following:

- Briefly press  and say "Cancel".
- Press and hold the steering wheel keypad's voice command button  until two audible signals are given. This cancels voice control even when the system is speaking.

Voice control will also be canceled if you do not respond during a dialog. The system will first ask three times for a response and if the response is still not given, voice control will be automatically canceled.

To speed up communication and skip prompts from the system, press the voice control button  on the steering wheel keypad. This will interrupt the system's response and you can say the next command.

Voice command examples

1. Tap .

2. Say "Call [First name] [Last name] [number category]", e.g. "Call Robyn Smith cellular".

> The system will call the selected contact from the phone book. If the contact has several phone numbers (e.g. home, cell, work), the right category must also be given.

Commands/phrases

The following commands can usually be used in any situation:

- "Repeat" - repeats the most recent voice command in the current dialog.
- "Cancel" - cancels the dialog.¹⁶
- "Help" - initiates a help dialog. The system responds with commands that can be used in the current situation, an instruction or an example.

Commands for specific functions, such as phone and audio, are described in the sections related to that function.

¹⁶ Note that this only cancels the dialog when the system is not speaking. To do this, press and hold  until you hear two beeps.



◀ Numbers

Number commands can be given in different ways depending on the function to be controlled:

- **Phone numbers and zip codes** should be given by stating each number individually, e.g. "zero, three, one, two, two, four, four, three" (03122443).
- **Addresses** can be given by stating each number individually or in a group, e.g. "two, two" or "twenty-two" (22). For English and Dutch language settings, groups of numbers can also be said in sequence, e.g. "twenty-two, twenty-two" (22 22). For English, double or triple digits can also be used, e.g. "double zero" (00). Numbers in the range 0-2300 can be used.
- **Frequencies** can be given as "ninety-eight point eight" (98.8), "one hundred four point two" or "hundred and four point two" (104.2).

Speech rate and repeat mode

The speed at which the system speaks can be adjusted.

With repeat mode on, the system will repeat what you have said.

To change the speech rate or activate/deactivate repeat mode:

1. Tap **Settings** in the Top view.

2. Tap **System** → **Voice Control** and select settings.

- **Repeat Voice Command**
- **Speech Rate**

Related information

- Voice Control (p. 143)
- Voice control for cellular phones (p. 146)
- Voice control for radio and media (p. 147)
- Climate control system voice commands (p. 200)
- Voice control settings (p. 148)

Voice control for cellular phones¹⁷

Call a contact in the phone book, have a text message read aloud or dictate short messages using voice commands to a Bluetooth-connected phone.

To access a contact in the phone book, the voice command must contain the contact information entered in the phone book. If a contact, e.g. **Robyn Smith**, has several phone numbers listed in the phone book, a number category such as **home** or **cellular** can also be specified, i.e. "**Call Robyn Smith cellular**".

Tap  and say one of the following commands:

- "**Call [contact]**" - call the selected contact from the phone book.
- "**Call [phone number]**" - call a phone number.
- "**Recent calls**" - display the list of recent calls.
- "**Read message**" - read a text message aloud. If there are several messages, select the message to read aloud.
- "**Message to [contact]**" – the user is prompted to dictate a short message. The message will then be read aloud and the user can choose to send or re-dictate the message. The vehicle must be connected to the Internet to access this function.

i NOTE

Not all system languages support voice control. If a language supports voice control, it is marked with a  symbol in the list of available system languages. Read more about where the information is found in the section on voice control settings.

Related information

- Voice Control (p. 143)
- Use voice recognition (p. 144)
- Voice control for radio and media (p. 147)
- Climate control system voice commands (p. 200)
- Voice control settings (p. 148)
- Internet-connected vehicle* (p. 516)

Voice control for radio and media¹⁸

Voice commands for the radio and media players are shown below.

Tap  and say one of the following commands:

- **"Media"** - initiates a dialog for media and radio and displays examples of commands.
- **"Play [artist]"** - plays music by the selected artist.
- **"Play [song title]"** - plays the selected song.
- **"Play [song title] from [album]"** - plays the selected song from the selected album.
- **"Play [radio station]"** - starts the selected radio station.
- **"Tune to [frequency]"** - tunes to the selected radio frequency in the currently active waveband. If no radio source is active, the FM band will be started as default.
- **"Tune to [frequency] [waveband]"** - tunes to the selected radio frequency on the selected waveband.
- **"Radio"** - starts FM radio.
- **"Radio FM"** - starts FM radio.

- **"SiriusXM"** - starts SiriusXM radio*
- **"USB"** - starts playback from USB.
- **"iPod"** - starts playback from iPod.
- **"Bluetooth"** - starts playback from a Bluetooth-connected media source.
- **"Similar music"** - plays music from a USB-connected device with music similar to that currently playing.

i NOTE

Not all system languages support voice control. If a language supports voice control, it is marked with a  symbol in the list of available system languages. Read more about where the information is found in the section on voice control settings.

Related information

- Voice Control (p. 143)
- Use voice recognition (p. 144)
- Voice control for cellular phones (p. 146)
- Climate control system voice commands (p. 200)
- Voice control settings (p. 148)

¹⁷ Certain markets only.

¹⁸ Certain markets only.

Voice control settings¹⁹

Settings for the voice control system are made here.

Settings → System → Voice Control

Settings can be personalized in the following areas:

- Repeat Voice Command
- Gender
- Speech Rate

Sound settings

Select sound settings under:

Settings → Sound → System Volumes → Voice Control

Language settings

The voice control system is not available for all languages. The languages available for voice commands are indicated by the  icon in the list of languages.

Changing the language here will also change the language in the menus, messages and help texts.

Settings → System → System Languages and Units → System Language

Related information

- Voice Control (p. 143)
- Use voice recognition (p. 144)
- Voice control for cellular phones (p. 146)
- Climate control system voice commands (p. 200)
- Voice control for radio and media (p. 147)
- Sound settings (p. 470)
- Changing system language (p. 130)

¹⁹ Certain markets only.

LIGHTING

Lighting control and panel

The lighting panel and controls can be used to adjust both exterior and interior lighting. The lighting ring on the left-side steering wheel lever can be used to activate and adjust the exterior lighting. The brightness of the interior lighting can be adjusted using the thumb wheel on the dashboard.

Exterior lighting

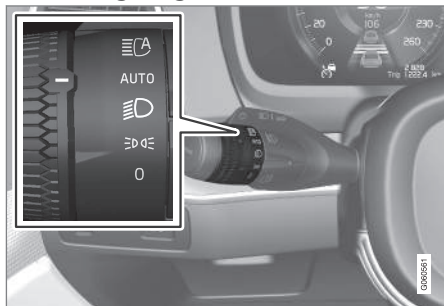

Lighting ring position.

When the vehicle's ignition is in mode **II**, the lighting ring positions have the following functions:

Position	Meaning
0	US: Daytime running lights and parking lights are off. Canada: Daytime running lights and parking lights are on. High beam flash can be used.
	Parking lights when the vehicle is parked. US: Daytime running lights are off. Canada: Daytime running lights are on. High beam flash can be used.
	Low beams and parking lights. High beams can be activated. High beam flash can be used.

Position	Meaning
AUTO	Daytime running lights and parking lights in daylight conditions. ^A Low beams and parking lights in weak daylight or dark conditions or when the front fog lights* and/or rear fog light are activated. Active high beam can be activated. High beams can be activated when low beams are on. High beam flash can be used.
	Active high beams on/off.

^A US models only: Daytime running lights and parking lights can be deactivated in the center display.

NOTE
Volvo recommends use of Daytime Running Lights in the US. Its use is mandatory in Canada.

Volvo recommends using position **AUTO** when the vehicle is in motion.

⚠ WARNING

The vehicle lighting system cannot in all situations determine when the daylight is too weak or not strong enough, e.g. when there is fog or rain.

The driver is always responsible for driving the vehicle with lighting that is safe for the traffic conditions and as specified by applicable traffic regulations.

Thumbwheel in instrument panel

Thumb wheel (to the left) for adjusting interior brightness.

Related information

- Adjusting light functions via the center display (p. 151)
- Interior Lighting (p. 160)
- Parking lights (p. 152)

- Using turn signals (p. 156)
- Using high beam (p. 154)
- Low beams (p. 153)
- Front fog lights/corner illumination* (p. 157)
- Rear fog light (p. 158)
- Active Bending Lights* (p. 156)
- Brake lights (p. 159)
- Emergency brake lights (p. 159)
- Hazard warning flashers (p. 159)

Adjusting light functions via the center display

A number of light functions can be adjusted and activated via the center display. These include active high beams, home safe lighting and approach lighting.

1. Tap **Settings** in the center display's Top view.
2. Tap **My Car** → **Lights and Lighting**.
3. Select **Exterior Lights** or **Interior Lighting** and then select the function that you would like to adjust.

Related information

- Lighting control and panel (p. 150)
- Active high beam (p. 155)
- Using home safe lighting (p. 160)
- Welcome Light (p. 160)
- Using turn signals (p. 156)
- Changing settings in the center display's Top view (p. 130)
- Function view in the center display (p. 120)

Parking lights

The parking lights can be used to help other road users see the vehicle if it is stopped or parked. Use the lighting ring on the steering wheel lever to turn on the parking lights.

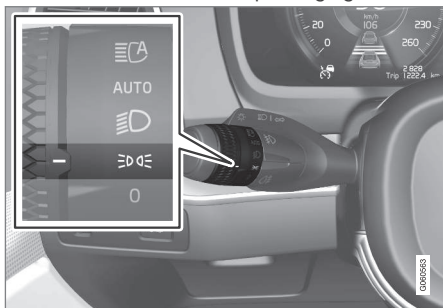

Lighting ring in the parking light position.

Turn the lighting ring to the  position to turn on the parking lights (the license plate lighting will also illuminate).

Canadian models: If the ignition is in the **II** position, the daytime running lights will illuminate instead of the front parking lights. With the lighting ring in this position, the parking lights will remain on regardless of what position the ignition is in.

US models: When **AUTO** mode is selected, the daytime running lights can be deactivated in the center display. The parking lights will also be deactivated. In weak daylight or dark

conditions, the parking lights and low beams will be illuminated.

In dark conditions, the rear parking lights also illuminate when the tailgate is opened to alert following traffic. This happens regardless of what position the lighting ring or ignition is in.

Related information

- Lighting control and panel (p. 150)
- Ignition modes (p. 415)

Daytime running lights

The vehicle has sensors that detect ambient lighting conditions. With the lighting ring in the **AUTO** position, the daytime running lights will always be activated when the ignition is in mode **II**. In weak daylight or dark conditions, the headlights automatically switch to low beams.

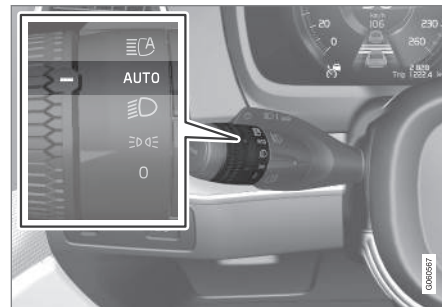

Lighting ring in **AUTO** position.

With the steering wheel lever's lighting ring in the **AUTO** position, the daytime running lights (DRL¹) will illuminate when the vehicle is driven in daylight conditions. The headlights will switch automatically from daytime running lights to low beams in weak daylight or dark conditions. The headlights will also switch to low beams if the front fog lights* and/or rear fog light are activated.

US models: When **AUTO** mode is selected, the daytime running lights can be deactivated in the center display. The parking lights will also be deactivated. In weak daylight or dark conditions, the parking lights and low beams will be illuminated.

US models: With the lighting ring in the **0** or **☰☑☒** position, the daytime running lights will be **off**.

Canadian models: With the lighting ring in the **0** or **☰☑☒** position, the daytime running lights will be on.

NOTE
Volvo recommends use of Daytime Running Lights in the US. Its use is mandatory in Canada.

WARNING
The system is an energy saving aid – it cannot in all situations determine when the daylight is too weak or not strong enough, e.g. when there is fog or rain.
The driver is always responsible for driving the vehicle with lighting that is safe for the traffic conditions and as specified by applicable traffic regulations.

Related information

- Lighting control and panel (p. 150)
- Ignition modes (p. 415)
- Low beams (p. 153)

Low beams

When driving with the lighting ring in the **AUTO** position, low beam will be automatically activated in weak daylight or dark conditions, when the ignition is in the **II** position.

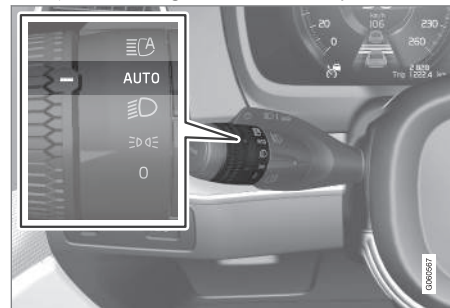

Lighting ring in **AUTO** position.

With the lighting ring in the **AUTO** position, the low beams will also be automatically activated if the rear fog light is activated.

With the lighting ring in the **☰☑☒** position, low beams will always be on when the ignition is in the **II** position.

¹ Daytime Running Lights

◀ Tunnel detection

The vehicle will detect if it enters a tunnel and shift from daytime running lights to low beams.

Note that the left-hand steering wheel lever must be in **AUTO** position for tunnel detection to work.

Related information

- Lighting control and panel (p. 150)
- Ignition modes (p. 415)
- Daytime running lights (p. 152)

Using high beam

High beam is operated via the left-hand steering wheel lever. High beam is the vehicle's strongest lighting and should be used when driving in dark conditions, provided it does not blind other road users, to improve visibility.



Steering wheel lever with lighting ring.

High beam flash

- ➔ Move the steering wheel lever slightly backward to the high beam flash mode. The high beams will illuminate until the lever is released.

High beams

- ➔ The high beams can be activated when the lighting ring is in mode **AUTO**² or

☰ . Activate high beams by moving the steering wheel lever forward.

- ➔ Deactivate by moving the steering wheel lever backward.

When the high beams are activated, the ☰ symbol will be illuminated in the instrument panel.

Related information

- Lighting control and panel (p. 150)
- Active high beam (p. 155)

² When the low beams are on.

Active high beam

Active high beams is a function that uses camera sensors in the upper edge of the windshield to detect the headlights of approaching vehicles or the taillights of the vehicle directly ahead. When either of these is detected, the vehicle's headlights will automatically switch from high beams to low beams.



Active high beams is indicated by the  symbol.

This function can be used in dark conditions when the vehicle's speed is approx. 20 km/h (approx. 12 mph) or higher. The function can also detect street lighting. When the camera sensor no longer detects an approaching vehicle or a vehicle ahead, the headlights will return to high beams after a second or two.

Activating active high beams

Active high beams can be activated and deactivated by turning the lighting ring on the left-side steering wheel lever to position .

The lighting ring will then return to **AUTO**.

When active high beams are activated, a white

 symbol will be displayed in the instrument panel. When high beams are on, the symbol will be blue.

If active high beams are deactivated when the high beams are on, the headlights will automatically switch to low beams.

Limitations for active high beams

The camera sensor on which the function is based has limitations.



If this symbol and the message **Active High Beam Temporarily unavailable** is displayed in the instrument panel, switching

between high and low beams must be done manually. The  symbol will go out when the message is displayed.



The same applies if this symbol along with the message **Windscreen sensor Sensor blocked, see Owner's manual** is

displayed.

Active high beams may be temporarily unavailable in certain situations, e.g. heavy fog or

rain. When active high beams become available again, or the windshield sensors are no longer blocked, the message will disappear and the  symbol will be displayed.

WARNING

Automatic high beam is an aid in using the best possible light based on prevailing conditions.

The driver is always responsible for manually switching between high and low beam when traffic situations or weather conditions require this.

Related information

- Lighting control and panel (p. 150)
- Using high beam (p. 154)
- Camera/radar sensor limitations (p. 381)

Using turn signals

The vehicle's turn signals are controlled using the left-side steering wheel lever. The turn signals flash three times or continuously, depending on how far up or down the lever is moved.



Turn signals.

Triple flash indicator

i Move the steering wheel lever up or down to the first position and release. The turn signals will flash three times. If the function is deactivated via the center display, the signals will flash once.

i	NOTE
<ul style="list-style-type: none"> • This automatic flashing sequence can be interrupted by immediately moving the lever in the opposite direction. • If the turn signal indicator flashes more quickly than normal, refer to the message in the instrument panel. 	

Continuous flashing sequence

i Move the lever up or down as far as possible.

The lever will stop in its end position and can be moved back manually or automatically by moving the steering wheel.

Related information

- Hazard warning flashers (p. 159)
- Adjusting light functions via the center display (p. 151)

Active Bending Lights*

Active Bending Lights (ABL) are designed to help provide extra illumination in curves and intersections. Depending on equipment level, vehicles with LED³ headlights* may be equipped with Active Bending Lights.

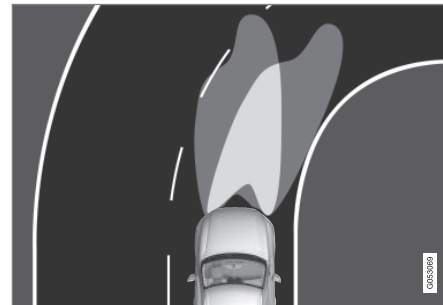

Headlight pattern with function deactivated (left) and activated (right).

Active Bending Lights follow the movement of the steering wheel to help provide extra illumination in curves and intersections, helping to improve visibility for the driver.

The function is automatically activated when the engine is started. If a fault is detected in the system, the  symbol will illuminate in the instrument panel and a message will be displayed.

³ LED (Light Emitting Diode)

The function is only active in weak daylight or dark conditions and only when the vehicle is moving and the low beams are on.

Deactivating/activating the function

The function is activated as the default factory setting and can be activated and deactivated in the center display's Function view:



Tap the **Active Bending Lights** button.

Related information

- Adjusting light functions via the center display (p. 151)
- Front fog lights/corner illumination* (p. 157)

Front fog lights/corner illumination*

The fog lights can be activated manually when driving in fog and are activated automatically when backing up to help augment the backup light.

If the vehicle is equipped with corner illumination*, the fog lights are activated automatically in weak daylight or dark conditions to illuminate the area diagonally in front of the vehicle.

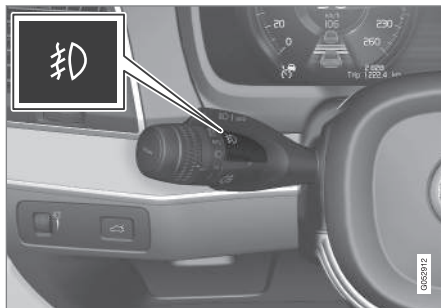

Front fog lights button.

The front fog lights can be turned on when the ignition is in mode **II** and the lighting ring is in position **AUTO**, **☰D** or **☰DE**.

Tap the button to activate or deactivate the function. The **☰D** symbol in the instrument panel comes on when the front fog lights are on.

The front fog lights turn off automatically when the ignition is switched off or when the lighting ring is in position **0**.

i	NOTE
Regulations concerning fog light use vary from country to country.	

Cornering illumination*

The front fog lamps can include the cornering lights function, which temporarily illuminates the area diagonally in front of the car in the direction the steering wheel is turned on a sharp bend, or in the direction shown by the direction indicators.

The function is activated in weak daylight or dark conditions when the lighting ring is in **AUTO** or **☰D** mode and the vehicle speed is less than about 30 km/h (about 20 mph).

Both cornering illumination are also illuminated as a complement to the taillights when reversing.

The function is activated as the default factory setting and can be activated and deactivated using the center display.

Related information

- Lighting control and panel (p. 150)
- Ignition modes (p. 415)
- Rear fog light (p. 158)



- Active Bending Lights* (p. 156)
- Adjusting light functions via the center display (p. 151)

Rear fog light

The rear fog light is considerably brighter than ordinary taillights and should only be used to help other road users see the vehicle when visibility is reduced by conditions such as fog, snow, smoke or dust.



Rear fog light button.

The fog lights are located on the right and left sides of the rear of the vehicle.

The rear fog light can only be switched on when the ignition is in **II** mode and the lighting ring is in position **AUTO** or **☰D**.

Press the button to switch on/off. The **☰** symbol in the instrument panel illuminates when the rear fog light is on.

The rear fog light turns off automatically when the ignition is switched off or when the steer-

ing wheel lever lighting ring is in position

0 or **☰D**.

i NOTE

Regulations concerning rear fog light use vary from country to country.

Related information

- Lighting control and panel (p. 150)
- Front fog lights/corner illumination* (p. 157)
- Ignition modes (p. 415)

Brake lights

The brake lights are automatically illuminated when braking.

The brake lights are illuminated when the brake pedal is depressed and when the brakes are automatically applied by a driver support system.

Related information

- Emergency brake lights (p. 159)
- Brake functions (p. 417)
- Driver support systems (p. 268)

Emergency brake lights

The emergency brake lights are activated to warn following vehicles of hard braking.

This function causes an additional taillight on each side of the vehicle to illuminate.

The emergency brake lights are activated in the event of hard braking or if the ABS system is activated and the vehicle is traveling at a high speed.

After the driver decelerates to a low speed and then releases the brake, the brake lights resume their normal brightness.

Related information

- Brake lights (p. 159)
- Brakes (p. 417)
- Hazard warning flashers (p. 159)

Hazard warning flashers

Hazard warning flashers warn other road users by all of the vehicle's turn signals being activated at the same time. The function can be used to warn about a traffic hazard.

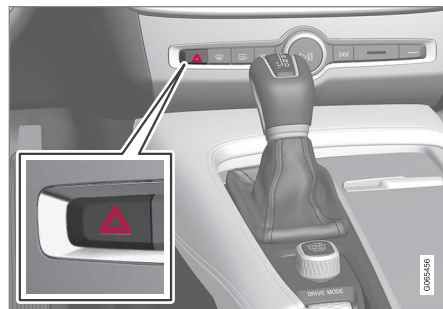

Hazard warning flashers button.

Press the button to activate the hazard warning flashers.

i NOTE

Regulations concerning the use of hazard warning flashers may vary from country to country.

Related information

- Emergency brake lights (p. 159)
- Using turn signals (p. 156)

Using home safe lighting

Some of the exterior lights remain on to illuminate the area around the vehicle. This is called home safe lighting.

To activate home safe lighting:

1. Switch off the ignition.
2. Push the left-side steering wheel lever toward the dashboard and release.
3. Exit the vehicle and lock the doors.
 - > A symbol in the instrument panel illuminates to indicate that the function is activated and exterior lighting switches on: Parking lights, headlights, license plate lighting and outer door handle lighting*.

The length of time home safe lighting remains illuminated can be set in the center display.

Related information

- Adjusting light functions via the center display (p. 151)
- Welcome Light (p. 160)

Welcome Light

Approach lighting is activated when the vehicle is unlocked and can be used to provide light as you walk toward the vehicle.

The function is activated when the remote key is used for unlocking. The parking lights, ceiling lights, footwell lights and trunk/cargo compartment lights are activated in daylight conditions. In weak daylight or dark conditions, the license plate lighting and outer door handle lighting* will also be activated, with the light directed toward the ground.

If no door is opened, the lights will remain illuminated for approx. 2 minutes. If a door is opened while the function is activated, the interior lighting and outer door handle lighting* will remain on for a longer period of time.

This function can be activated and deactivated in the center display.

Related information

- Adjusting light functions via the center display (p. 151)
- Using home safe lighting (p. 160)
- Remote key (p. 236)

Interior Lighting

The passenger compartment is equipped with several different types of lighting, e.g. general lighting, adjustable ambient lighting and reading lights.

All lighting in the passenger compartment can be turned on and off manually within 5 minutes after:

- the engine has been switched off and the ignition is in mode **O**.
- the vehicle is unlocked but has not been started.

Front ceiling lighting



The controls in the ceiling console for the front reading lights and courtesy lighting.

- 1 Reading light left side
- 2 Passenger compartment lighting

3 Courtesy lighting auto switch

4 Reading light right side

Reading lights

The reading lights on the right and left sides are switched on and off by briefly pressing the buttons in the ceiling console. To adjust the brightness, press and hold the button.

Passenger compartment lighting

Briefly press the button in the ceiling console to switch on or off the footwell lighting and ceiling lighting.

Courtesy lighting auto switch

Activate the auto switch by briefly pressing the **AUTO** button in the ceiling console. With Auto activated, the indicator light in the button and the courtesy lighting come on and are turned off as follows.

Courtesy lighting is switched on when:

- The vehicle is unlocked
- The vehicle is switched off
- A side door is opened.

Courtesy lighting is switched off when:

- The vehicle is locked
- The engine is started
- A side door is closed
- A side door has been open for approx. 2 minutes.

Rear roof lighting

Reading lights are located in the rear section of the vehicle and can also be used as passenger compartment lighting.



Reading lights over the rear seat.



In vehicles with panoramic roofs*, there are two lamp units, one on each side of the ceiling.

Briefly press the button on the light to turn on or off the reading lights. To adjust the brightness, press and hold the button.

Glove compartment lighting

The glove compartment lighting comes on or goes off when the glove compartment is opened or closed.

Vanity mirror lighting*

The vanity mirror lighting comes on or goes off when the cover over the mirror is opened or closed.

Ground lighting*

The ground lighting comes on or goes off when a door is opened or closed.

Doorsill lighting

The doorsill lighting comes on or goes off when a door is opened or closed.

Cargo compartment lighting

The cargo compartment lighting comes on or goes off when the cargo compartment is opened or closed.

Ambient Lighting

The ambient lighting comes on when the doors are opened and goes out when the vehicle is locked. Ambient lighting brightness can be adjusted in the center display and also fine-tuned using the thumb wheel in the dashboard.



◀◀ **Mood lighting***

The vehicle is equipped with LEDs that provide faint lighting in various colors. This lighting is on when the engine is running. Mood lighting can be adjusted in the center display and also fine-tuned using the thumb wheel in the dashboard.

Lighting in the door storage compartments

Lighting in the door storage compartments comes on when the doors are opened and goes out when the vehicle is locked. The brightness can be adjusted using the thumb wheel in the dashboard.

Lighting in the tunnel console's front cup holder

The lighting in front console cup holders switches on when the vehicle is unlocked and off when the vehicle is locked. The brightness can be adjusted using the thumb wheel in the dashboard.

Related information

- Adjusting interior lighting (p. 162)
- Lighting control and panel (p. 150)
- Ignition modes (p. 415)
- Passenger compartment interior (p. 566)

Adjusting interior lighting

Illumination in the vehicle varies depending on ignition mode. The interior lighting can be adjusted with a thumb wheel in the dashboard and certain light functions can also be adjusted via the center display.



The thumb wheel on the dashboard to the left of the steering wheel can be used to adjust the brightness of the display lighting, instrument lighting, ambient lighting and mood lighting*.

Adjust ambient decor lighting

1. Tap **Settings** in the Top view in the center display.
2. Tap **My Car → Lights and Lighting → Interior Lighting**.
3. Choose from among the following settings:
 - Under **Ambient Light Intensity**, select **Off**, **Low** or **High**.
 - Under **Ambient Light Level**, select **Reduced** or **Full**.

Adjusting mood lighting*

The vehicle is equipped with several LEDs that provide faint lighting in various colors. This lighting is on when the engine is running.

Changing the brightness

1. Tap **Settings** in the Top view in the center display.
2. Tap **My Car → Lights and Lighting → Interior Lighting → Interior Mood Lighting**.
3. Under **Interior Mood Light Intensity**, select **Off**, **Low** or **High**.

Changing the color of the light

1. Tap **Settings** in the Top view in the center display.
2. Tap **My Car → Lights and Lighting → Interior Lighting → Interior Mood Lighting**.
3. Choose **By Temperature** or **By Color** to change the color of the light.

If **By Temperature** is selected, the light will change according to the temperature set for the passenger compartment.

If **By Color** is selected, the subcategory **Theme Colors** can be used to make further adjustments.

Related information

- Interior Lighting (p. 160)
- Adjusting light functions via the center display (p. 151)
- Ignition modes (p. 415)

WINDOWS, GLASS AND MIRRORS

Windows, glass and mirrors

The vehicle is equipped with several different types of windows, glass and mirrors. Some of the windows in the car are laminated.

The windshield has laminated glass. Laminated glass is also available as an option for some other glass surfaces. Laminated glass is reinforced, which provides better protection against break-ins and improved soundproofing in the passenger compartment.

The panoramic roof* also has laminated glass.



The symbol shows the windows containing laminated glass.¹

Related information

- Pinch protection for windows and sun curtains (p. 164)
- Panoramic roof* (p. 170)
- Power windows (p. 165)
- Rearview/door mirrors (p. 167)
- Head-up display* (p. 140)
- Using the windshield wipers (p. 174)
- Using the windshield and headlight washers (p. 177)

- Activating and deactivating the heated rear window and door mirrors (p. 217)

Pinch protection for windows and sun curtains

All power windows and sun curtains* have a pinch protection function that is triggered if anything blocks them while they are opening or closing.

If pinch protection is activated, movement will stop and then retract automatically to approx. 50 mm (2 inches) from the point at which it was blocked (or to full ventilation position).

It is still possible to override pinch protection when closing is interrupted (e.g. due to ice) by pressing and holding down the control in the same direction.

If there is any problem with the pinch protection, a reset procedure can be tested.

WARNING

If the starter battery is disconnected, the function for automatic opening and closing must be reset to function correctly. A reset is required in order for the pinch protection to work.

Related information

- Reset procedure for pinch protection (p. 165)
- Operating the power windows (p. 166)
- Operating the panoramic roof* (p. 171)

¹ Does not apply to windshield and panoramic roof*, which are always laminated and therefore do not have this symbol.

Reset procedure for pinch protection

If you experience any problems with the electrical functions for the power windows, you can try to perform a reset.

⚠ WARNING

If the starter battery is disconnected, the function for automatic opening and closing must be reset to function correctly. A reset is required in order for the pinch protection to work.

Consult a workshop if you experience any problems with the panoramic roof.²

Resetting a power window

1. Start with the window in the closed position.
2. Then move the control in manual mode three times upward toward the closed position.
 - > The system will be automatically activated.

If the problem persists, contact a workshop.

Related information

- Pinch protection for windows and sun curtains (p. 164)
- Operating the power windows (p. 166)

Power windows

Every door has a control panel for the power windows. The driver's door has controls for operating all windows and for activating the child safety locks.

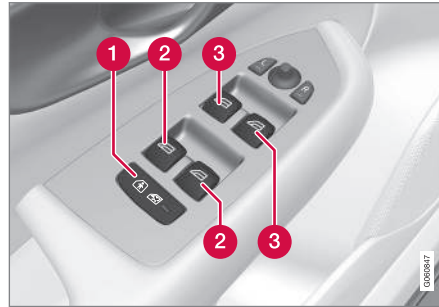

Driver's door control panel.

- 1 Electric child safety locks* that deactivate the controls in the rear doors to prevent the doors or windows from being opened from the inside.
- 2 Rear window controls.
- 3 Front window controls.

⚠ WARNING

Children, other passengers or objects can be trapped by the moving parts.

- Always operate the windows with caution.
- Do not allow children to play with the operating controls.
- Never leave a child alone in the vehicle.
- Remember to always cut the current to the power windows by setting the vehicle's electrical system to ignition mode **0** and then taking the key with you when leaving the vehicle.
- Never stick objects or body parts out through the windows, even if the vehicle electrical system is completely turned off.

Related information

- Operating the power windows (p. 166)
- Pinch protection for windows and sun curtains (p. 164)
- Reset procedure for pinch protection (p. 165)

² An authorized Volvo workshop is recommended.

Operating the power windows

All power windows can be operated using the control panel in the driver's door. The control panels in the other doors can be used to operate that particular door.

The power windows have pinch protection. If there is any problem with the pinch protection, a reset procedure can be tested.

WARNING

Children, other passengers or objects can be trapped by the moving parts.

- Always operate the windows with caution.
- Do not allow children to play with the operating controls.
- Never leave a child alone in the vehicle.
- Remember to always cut the current to the power windows by setting the vehicle's electrical system to ignition mode **O** and then taking the key with you when leaving the vehicle.
- Never stick objects or body parts out through the windows, even if the vehicle electrical system is completely turned off.



Operating the power windows.

- ➔ **Operating manually.** Move one of the controls slightly up or down. The power windows go up or down while the control is held in position.
- ➔ **Operating with automatic controls.** Move one of the controls up or down to its end position and release it. The window moves automatically to its fully closed/open position.

To use the power windows, the ignition must be in at least mode **I** or **II**. After the ignition has been switched off, the power windows can be operated for several minutes or until a door is opened. Only one control can be operated at a time.

It can also be operated using keyless opening* with the door handle.

WARNING

Make sure that no child or other passenger comes into contact with the windows as they are closing with keyless closing*.

NOTE

One way to reduce the pulsating wind noise heard when the rear windows are open is to also open the front windows slightly.

NOTE

The windows cannot be opened at speeds over approx. 180 km/h (ca 112 mph), but they can be closed.

The driver is always responsible for following applicable traffic regulations.

NOTE

It may not be possible to operate the windows in low temperatures.

Related information

- Power windows (p. 165)
- Pinch protection for windows and sun curtains (p. 164)
- Reset procedure for pinch protection (p. 165)

- Keyless locking and unlocking* (p. 253)
- Locking and unlocking using the remote key (p. 239)

Rearview/door mirrors

The rearview mirror and door mirrors can be used to improve the driver's visibility behind the vehicle.

Rearview mirror

The rearview mirror is equipped with Home-Link*, auto-dim* and compass*.

The rearview mirror can be adjusted manually.

Door mirrors

WARNING

The door mirror on the passenger side is curved to improve visibility. Objects in the mirror may appear farther away than they actually are.

The joystick in the drivers' door control panel is used to adjust the position of the door mirrors.

There are also several automatic settings that can also be connected to the memory function buttons for the power seat*.

Related information

- HomeLink®* (p. 463)
- Compass* (p. 466)
- Adjusting the rearview mirror dimming function (p. 168)
- Adjusting the door mirrors (p. 168)

- Storing positions for seats, mirrors and head-up display* (p. 184)
- Activating and deactivating the heated rear window and door mirrors (p. 217)

Adjusting the rearview mirror dimming function

Bright light entering the vehicle from behind, e.g. from the headlights of following vehicles, could reflect in the rearview mirror and door mirrors and cause a glare. Use the dimming function when light from behind is distracting.

Auto-dim

If bright light enters the vehicle from behind, the door mirrors will automatically dim when it is dark outside or when lighting conditions are low, for example when driving in tunnels. Auto-dim is always active when the engine is running, except when reverse gear is engaged.

i NOTE

Adjustments to the sensitivity level will not be noticeable immediately but will instead take effect after a short period of time.

The sensitivity level for dimming will affect both the rearview mirror and door mirrors.

To change the dimming sensitivity level:

1. Tap **Settings** in the Top view in the center display.
2. Tap **My Car** → **Mirrors and Convenience**.
3. Under **Rearview Mirror Auto Dimming**, select **Normal**, **Dark** or **Light**.

The rearview mirror has two sensors - one pointing forward and one pointing rearward - which work together to identify and eliminate glare. The forward-pointing sensor monitors ambient light, while the rearward-pointing sensor monitors light from the headlights of following vehicles.

For the door mirrors to be equipped with auto-dim, the rearview mirror must also be equipped with auto-dim.

i NOTE

If the sensors are obstructed by e.g. a parking permit, transponder, sunshade or objects on the seats or in the cargo compartment in a way that prevents light from reaching the sensors, the auto-dim function in the door and rearview mirrors will be reduced.

Related information

- Rearview/door mirrors (p. 167)
- Adjusting the door mirrors (p. 168)

Adjusting the door mirrors

To improve visibility to the rear, the door mirrors need to be adjusted to the driver's height and seating position.

There are several automatic settings that can also be connected to the memory function buttons for the power seat*.

Controls used for door mirrors



Door mirror controls.

The joystick in the drivers' door control panel is used to adjust the position of the door mirrors. The ignition must be in at least mode I.

1. Press the **L** button for the left door mirror or **R** for the right door mirror. The button will light up.
2. Adjust the position using the joystick located between the buttons.

3. Press the **L** or **R** button again. The light in the button will go out.

Automatically folding door mirrors*

The door mirrors can be automatically folded when driving or parking in tight spaces.

1. Press the **L** and **R** buttons at the same time.
2. Release the buttons after about 1 second. The mirrors will automatically stop when they are completely folded in.

Open the mirrors by pressing **L** and **R** at the same time. The mirrors will automatically stop when they reach the last-used setting.

Resetting the mirrors' position

A mirror that has been moved out of position manually (e.g. hit or bumped into) must be electrically returned to its original position for automatic folding* to function properly.

1. Fold in the mirrors by pressing the **L** and **R** buttons at the same time.
2. Open them again by pressing the **L** and **R** buttons at the same time.
3. Repeat the above procedure as needed.

The mirrors return to their original positions.

Tilting when parking³

The door mirrors can be tilted down to help give the driver a better view along the sides of the vehicle, e.g. of the curb when parking.

- Select reverse gear and press the **L** or **R** mirror button.

Please note that the button may need to be pressed twice depending on settings. When the door mirror is tilted down, the light in the button will flash. When reverse gear is engaged, the door mirrors will automatically start to move after 3 seconds and will reach their original position after about 8 seconds.

Automatically tilting when parking³

With this setting, the door mirrors will automatically tilt down when reverse gear is engaged. The folded position is preset and cannot be adjusted.

1. Tap **Settings** in the center display's Top view.
2. Tap **My Car → Mirrors and Convenience**.
3. Under **Exterior Mirror Tilt at Reverse**, select **Off**, **Driver**, **Passenger** or **Both** to activate/deactivate and to select which mirror to tilt.

To immediately return the door mirrors to their original position, press the **L** or **R** button twice.

Automatic folding when the vehicle is locked*

In the center display, you can set the door mirrors to retract/extend automatically when the vehicle is locked/unlocked with the key.

1. Tap **Settings** in the center display's Top view.
2. Tap **My Car → Mirrors and Convenience**.
3. Select **Fold Mirror When Locked** to activate/deactivate.

i NOTE

If the door mirrors are folded in manually using the **L** and **R** buttons and then the vehicle is locked, the mirrors will not automatically fold out when the vehicle is unlocked, even if this preference has been set. In this case, the mirrors must be folded out manually.

Related information

- Rearview/door mirrors (p. 167)
- Adjusting the rearview mirror dimming function (p. 168)
- Storing positions for seats, mirrors and head-up display* (p. 184)
- Activating and deactivating the heated rear window and door mirrors (p. 217)

³ Only on models equipped with a power driver's seat with memory buttons*.

Panoramic roof*

The panoramic roof is divided into two glass sections. The front section can be opened vertically at the rear edge (ventilation position) or horizontally (open position). The rear section cannot be moved.

The panoramic roof has a wind deflector and sun curtain made of perforated fabric (located beneath the glass sections) for extra protection in e.g. bright sunlight.



The panoramic roof and sun curtain are operated using the controls in the ceiling.

To operate the panoramic roof and sun curtain, the ignition must be in mode **I** or **II**.

WARNING

Children, other passengers or objects can be trapped by the moving parts.

- Always operate the windows with caution.
- Do not allow children to play with the operating controls.
- Never leave a child alone in the vehicle.
- Remember to always cut the current to the power windows by setting the vehicle's electrical system to ignition mode **0** and then taking the key with you when leaving the vehicle.
- Never stick objects or body parts out through the windows, even if the vehicle electrical system is completely turned off.

CAUTION

- Do not open the panoramic roof when load carriers are installed.
- Never place heavy objects on the panoramic roof.

CAUTION

- Remove ice and snow before opening the panoramic roof. Be careful not to scratch any surfaces or damage the trim.
- Do not operate the panoramic roof if it is frozen in place.

Wind blocker

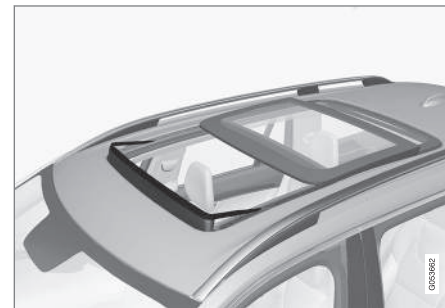

The panoramic roof is equipped with a wind blocker that folds up when the roof is open.

Related information

- Operating the panoramic roof* (p. 171)
- Auto closing the panoramic roof* sun curtain (p. 173)
- Pinch protection for windows and sun curtains (p. 164)

- Keyless locking and unlocking* (p. 253)
- Locking and unlocking using the remote key (p. 239)

Operating the panoramic roof*

The panoramic roof and sun curtain are operated using a control in the ceiling panel, and both are equipped with pinch protection.

WARNING

Children, other passengers or objects can be trapped by the moving parts.

- Always operate the windows with caution.
- Do not allow children to play with the operating controls.
- Never leave a child alone in the vehicle.
- Remember to always cut the current to the power windows by setting the vehicle's electrical system to ignition mode **0** and then taking the key with you when leaving the vehicle.
- Never stick objects or body parts out through the windows, even if the vehicle electrical system is completely turned off.

CAUTION

- Do not open the panoramic roof when load carriers are installed.
- Never place heavy objects on the panoramic roof.

CAUTION

- Remove ice and snow before opening the panoramic roof. Be careful not to scratch any surfaces or damage the trim.
- Do not operate the panoramic roof if it is frozen in place.

To operate the panoramic roof and sun curtain, the ignition must be in mode **I** or **II**.

It can also be operated using keyless opening* with the door handle.

WARNING

Make sure that no child or other passenger comes into contact with the windows as they are closing with keyless closing*.





CAUTION

Check that the panoramic roof is properly closed when closing.

The movement of the roof will stop if the control is released during manual operation or when the glass has reached the comfort⁴ or fully open/closed position. The movement of both the panoramic roof and the sun curtain is also stopped if the control in the ceiling is operated again in the direction opposite that of the current direction of movement.

The panoramic roof and sun curtain are also equipped with pinch protection. If there is any problem with the pinch protection, a rest procedure can be tested.

NOTE

For manual opening, the sun curtain must be completely open before the panoramic roof can be opened. For the reverse procedure, the panoramic roof must be completely closed before the sun curtain can be completely closed.

NOTE

It may not be possible to operate the windows in low temperatures.

Opening and closing ventilation position

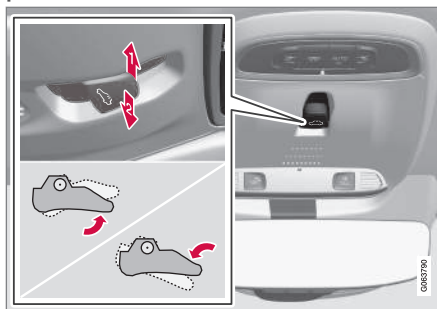

Ventilation position, rear edge raised.

- ➡ Open by pushing the control upward once.
- ➡ Close by pushing the control downward once.

When ventilation mode is selected, the rear edge of the front section of the roof is raised. If the sun curtain is fully closed when ventilation position is selected, it will automatically open approx. 50 mm (approx. 2 inches).

If the panoramic roof is closed from the ventilation position, the sun curtain will also automatically close.

Fully opening and closing the panoramic roof with the control in the ceiling

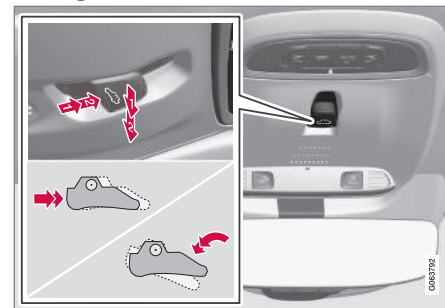

- ➡ Operation, manual mode
- ➡ Operation, automatic mode

⁴ The comfort position is a position which helps keep wind and resonance sounds to a comfortably low level.

Manual operation

1. To open the sun curtain, pull the control backward to the manual open mode.
2. To open the panoramic roof to the comfort position, pull the control backward a second time to the manual opening position.
3. To open the panoramic roof fully, pull the control backward a third time to the manual opening position.

Close by repeating the above procedure in reverse - push the control forward/down to the manual closing position.

Auto operation

1. To open the sun curtain to the fully open position, pull the control backward to the auto open mode and release.
2. To open the panoramic roof to the comfort position, pull the control backward a second time to the automatic opening position and release.
3. To open the panoramic roof fully, pull the control backward a third time to the automatic opening position and release.

Close by repeating the above procedure in reverse - push the control forward/down to the auto close position.

Automatic operation - rapid opening or closing

The panoramic roof and sun curtain can be opened or closed simultaneously:

- Open - press the control backward twice to the automatic operation position and release.
- Close - press the control forward/down twice to the automatic operation position and release.

Related information

- Panoramic roof* (p. 170)
- Auto closing the panoramic roof* sun curtain (p. 173)
- Pinch protection for windows and sun curtains (p. 164)
- Keyless locking and unlocking* (p. 253)
- Locking and unlocking using the remote key (p. 239)

Auto closing the panoramic roof* sun curtain

With this function, the sun curtain closes automatically 15 minutes after the vehicle has been locked if it is parked in hot weather. This is done to lower the passenger compartment temperature and protect the upholstery against being bleached by the sun.

The function is deactivated as the default factory setting and can be activated or deactivated using the center display.

1. Tap **Settings** in the Top view in the center display.
2. Tap **My Car** → **Locking**.

Select **Auto Close Sunroof Curtain** to activate/deactivate.

 NOTE

The sun curtain also closes when all windows are closed with keyless closing*.

Related information

- Panoramic roof* (p. 170)
- Operating the panoramic roof* (p. 171)
- Pinch protection for windows and sun curtains (p. 164)



- Keyless locking and unlocking* (p. 253)
- Locking and unlocking using the remote key (p. 239)

Wiper blades and washer fluid

The wipers and the washer fluid are designed to improve visibility and the headlight pattern.

Washer fluid direct from the wiper blades and heating* of the wiper blades gives improved vision.

When there is approximately 1 liter (1 qt) of washer fluid remaining, a message to refill will appear in the instrument panel.

Related information

- Using the rain sensor (p. 175)
- Using the windshield and headlight washers (p. 177)
- Using automatic rear window wiping when backing up (p. 179)
- Activating and deactivating the rain sensor's memory function (p. 176)
- Using the rear window wiper/washer (p. 178)
- Filling washer fluid (p. 643)
- Putting the wiper blades in service position (p. 642)
- Replacing windshield wiper blades (p. 641)
- Changing rear window wipers (p. 639)
- Using the windshield wipers (p. 174)

Using the windshield wipers

The windshield wipers are designed to clean the windshield. The right-side steering wheel lever is used to adjust windshield wiper settings.

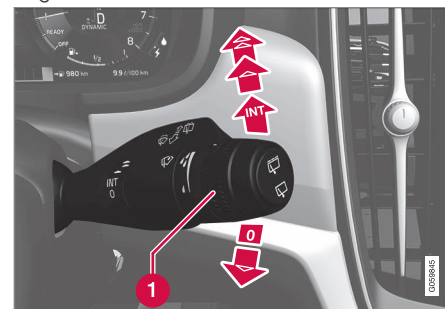

Right-hand steering wheel lever.

- 1 The thumb wheel is used to set rain sensor sensitivity and interval wiper speed.

Single sweep

- ▼ Move the lever down and release for a single sweep.

Wipers off

- 0 Move the lever to position 0 to turn off the windshield wipers.

Interval wipers

INT Move the lever upward to put the wipers in interval wiping mode. Set the number of sweeps per time unit with the thumb wheel when interval wipers are selected.

Continuous wipers

 Move the lever upward for the wipers to operate at normal speed.

 Move the lever upward again for the wipers to operate at high speed.

! CAUTION

Before activating the wipers, make sure that the wiper blades are not frozen in place and that any snow or ice on the windshield and rear window has been scraped away.

! CAUTION

Use plenty of washer fluid when the wipers clean the windshield. The windshield must be wet when the windshield wipers are working.

Related information

- Using the rain sensor (p. 175)
- Using the windshield and headlight washers (p. 177)

- Using automatic rear window wiping when backing up (p. 179)
- Wiper blades and washer fluid (p. 174)
- Activating and deactivating the rain sensor's memory function (p. 176)
- Using the rear window wiper/washer (p. 178)
- Filling washer fluid (p. 643)
- Putting the wiper blades in service position (p. 642)
- Replacing windshield wiper blades (p. 641)
- Changing rear window wipers (p. 639)

Using the rain sensor

The rain sensor monitors the amount of water on the windshield and automatically starts the windshield wipers. Rain sensor sensitivity can be adjusted using the thumb wheel on the right-hand steering wheel lever.

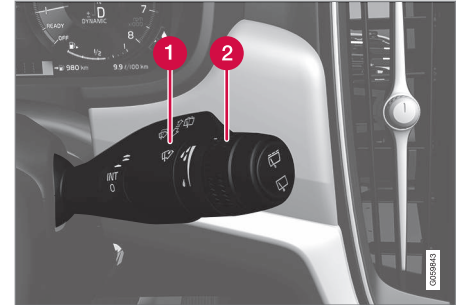

Right-hand steering wheel lever.

- 1** Rain sensor button
- 2** Thumb wheel, sensitivity/interval wiper speed

When the rain sensor is activated, the  rain sensor symbol will be displayed in the instrument panel.

Activating the rain sensor

When the rain sensor is activated, the engine must be running or the ignition in mode **I** or **II** while the windshield wiper lever is in position **0** or in the single sweep position.

- ◀◀ Activate the rain sensor by pressing the rain sensor button  .

Move the lever downward for an extra wiper sweep.

Turn the thumb wheel upward for increased sensitivity and downward for decreased sensitivity. The wipers will make one extra sweep when the thumb wheel is turned upward.

Deactivate the rain sensor

Deactivate the rain sensor by pressing the  rain sensor button or moving the lever upward to another wiper mode.

The rain sensor is automatically deactivated in ignition mode **O** or when the engine is switched off.

The rain sensor is also automatically deactivated when the wiper blades are put in the service position. The rain sensor will reactivate when service mode is switched off.

CAUTION

The windshield wipers may start inadvertently and be damaged in automatic car washes. Deactivate the rain sensor when the engine is running or when the ignition is in mode **I** or **II**. The symbol in the instrument panel will go out.

Related information

- Using the windshield and headlight washers (p. 177)
- Using automatic rear window wiping when backing up (p. 179)
- Wiper blades and washer fluid (p. 174)
- Activating and deactivating the rain sensor's memory function (p. 176)
- Using the rear window wiper/washer (p. 178)
- Filling washer fluid (p. 643)
- Putting the wiper blades in service position (p. 642)
- Replacing windshield wiper blades (p. 641)
- Changing rear window wipers (p. 639)
- Using the windshield wipers (p. 174)

Activating and deactivating the rain sensor's memory function

The rain sensor monitors the amount of water on the windshield and automatically starts the windshield wipers.

When the memory function is activated, the rain sensor button does not need to be pressed every time the vehicle is started:

1. Tap **Settings** in the center display's Top view.
2. Tap **My Car** → **Wipers**.
3. Select **Rain Sensor Memory** to activate/deactivate the memory function.

Related information

- Using the rain sensor (p. 175)
- Using the windshield and headlight washers (p. 177)
- Using automatic rear window wiping when backing up (p. 179)
- Wiper blades and washer fluid (p. 174)
- Using the rear window wiper/washer (p. 178)
- Filling washer fluid (p. 643)
- Putting the wiper blades in service position (p. 642)
- Replacing windshield wiper blades (p. 641)

- Changing rear window wipers (p. 639)
- Using the windshield wipers (p. 174)

Using the windshield and headlight washers

The windshield and headlight washers are designed to clean the windshield and headlights. Use the right-side steering wheel lever to start the windshield and headlight washers.

Starting the windshield and headlight washers



Washing function, right-hand steering wheel lever.

- Move the right-hand steering wheel lever toward the steering wheel to start the windshield and headlight washers.
 - > After the lever is released, the wipers make several extra sweeps.

! CAUTION

Avoid activating the washer system when it is frozen or the fluid reservoir is empty. Otherwise, there is a risk of damaging the pump.

Headlight washer*

To save washer fluid, the headlights are washed automatically according to a defined interval when the headlights are on.

Reduced washing

When there is about 1 liter (1 qt) of washer fluid left in the reservoir and the **Washer fluid Level low, refill** message is displayed in the instrument panel together with the  symbol, the washer fluid supply to the headlights is cut off. This is to prioritize windshield cleaning and visibility through it. The headlights are only washed if high or low beam is on.

Related information

- Using the rain sensor (p. 175)
- Using automatic rear window wiping when backing up (p. 179)
- Wiper blades and washer fluid (p. 174)
- Activating and deactivating the rain sensor's memory function (p. 176)
- Using the rear window wiper/washer (p. 178)



- Filling washer fluid (p. 643)
- Putting the wiper blades in service position (p. 642)
- Replacing windshield wiper blades (p. 641)
- Changing rear window wipers (p. 639)
- Using the windshield wipers (p. 174)

Using the rear window wiper/washer



The rear window washer/wiper is designed to clean the rear window. Use the right-side steering wheel lever to start and control the wiper/washer.

Activating the rear window wiper/washer

NOTE

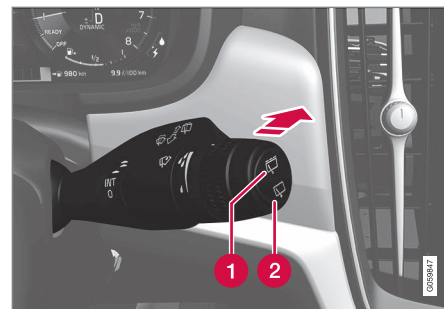
The rear window wiper motor is equipped with overheating protection that switches off the motor if it becomes overheated. The rear window wiper can be operated again after a cooling-down period.



- 1 Select  for interval rear window wiper.
 - 2 Select  for continuous rear window wiper.
- Move the right-side steering wheel lever forward to wash/wipe the rear window.

Related information

- Using the rain sensor (p. 175)
- Using the windshield and headlight washers (p. 177)
- Using automatic rear window wiping when backing up (p. 179)
- Activating and deactivating the rain sensor's memory function (p. 176)
- Wiper blades and washer fluid (p. 174)
- Filling washer fluid (p. 643)

- Putting the wiper blades in service position (p. 642)
- Replacing windshield wiper blades (p. 641)
- Changing rear window wipers (p. 639)
- Using the windshield wipers (p. 174)

Using automatic rear window wiping when backing up

If reverse gear is engaged while the windshield wipers are on, the rear window wipers will start. This function is deactivated when a different gear is selected.

1. Tap **Settings** in the Top view in the center display.
2. Tap **My Car** → **Wipers**.
3. Select **Auto Rear Wiper** to activate/deactivate automatic rear window wiping when backing up.

If the rear window wipers are already in continuous wiper mode, no change will be made when reverse gear is engaged.

Related information

- Using the rain sensor (p. 175)
- Using the windshield and headlight washers (p. 177)
- Wiper blades and washer fluid (p. 174)
- Activating and deactivating the rain sensor's memory function (p. 176)
- Using the rear window wiper/washer (p. 178)
- Filling washer fluid (p. 643)
- Putting the wiper blades in service position (p. 642)

- Replacing windshield wiper blades (p. 641)
- Changing rear window wipers (p. 639)
- Using the windshield wipers (p. 174)

SEATS AND STEERING WHEEL

Manual front seats

The front seats can be adjusted in a number of different ways to help enhance your seating comfort.

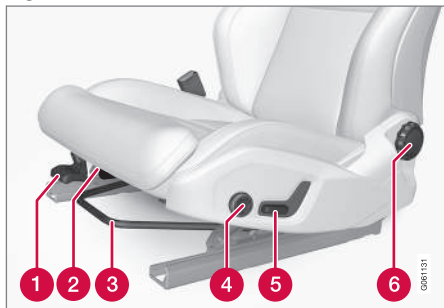

- 1 Raise/lower the front edge of the seat cushion* by moving the control up/down.¹
- 2 Change the length of the seat cushion* by pulling up the lever and moving the cushion forward/backward.
- 3 Move the seat forward/backward by lifting the handle and moving the seat to a suitable distance from the steering wheel and pedals. Check to make sure the seat is securely locked into place after its setting has been changed.
- 4 Adjust lumbar support* by pressing the button up/down/forward/rearward.²

¹ Only applies to the driver's seat.

² Applies for four-way lumbar support*. Two-way lumbar support* is adjusted forward/rearward.

- 5 Raise/lower the seat by moving the control up/down.
- 6 Change the backrest tilt by turning the knob on the backrest.

WARNING

- Do not adjust the seat while driving. The seat should be adjusted so that the brake pedal can be depressed fully. In addition, position the seat as far rearward as comfort and control allow.
- Check that the seat is securely locked into position after adjusting.

Related information

- Power* front seats (p. 183)
- Adjusting the power* front seats (p. 183)
- Storing positions for seats, mirrors and head-up display* (p. 184)
- Using stored positions for seats, mirrors and head-up display* (p. 185)
- Adjusting front seat massage settings* (p. 187)
- Adjusting* front seat cushion length (p. 188)
- Front seat massage* settings (p. 186)

- Adjusting front seat side bolster settings* (p. 189)
- Adjusting front seat lumbar support* (p. 189)
- Adjusting the passenger seat from the driver's seat* (p. 191)

Power* front seats

The front seats can be adjusted in a number of different ways to help enhance your seating comfort. The power seat can be moved forward/backward and up/down. The height and length* of the seat cushion and the tilt of the backrest can be adjusted. Lumbar support* can be adjusted up, down, forward and backward.³

The seats can be adjusted when the engine is running and for a certain period of time after the door has been unlocked without the engine running. They can also be adjusted for a short period after the engine is turned off.

! CAUTION

The power seats have an overload protector that is triggered if a seat is blocked by any object. If this occurs, remove the object and attempt to adjust the seat again.

Related information

- Manual front seats (p. 182)
- Adjusting the power* front seats (p. 183)
- Storing positions for seats, mirrors and head-up display* (p. 184)
- Using stored positions for seats, mirrors and head-up display* (p. 185)

- Adjusting front seat massage settings* (p. 187)
- Adjusting* front seat cushion length (p. 188)
- Front seat massage* settings (p. 186)
- Adjusting front seat side bolster settings* (p. 189)
- Adjusting front seat lumbar support* (p. 189)
- Adjusting the passenger seat from the driver's seat* (p. 191)

Adjusting the power* front seats

Set the desired seating position using the controls on the front seat cushion. To set the convenience functions, turn the multifunction control⁴ upward/downward.

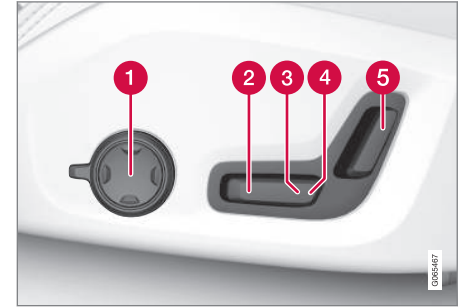

The illustration shows the controls in a vehicle with four-way lumbar support*. Vehicles with two-way lumbar support* do not have the rotary multifunction control.

- 1** In vehicles with four-way lumbar support*, turn the multifunction control⁴ up/down to set the convenience functions. In vehicles with two-way lumbar support*, use the round button to adjust the lumbar support forward/rearward.
- 2** Raise/lower the front edge of the seat cushion by moving the control up/down.

³ Applies for four-way lumbar support*. Two-way lumbar support* is adjusted forward/rearward.



SEATS AND STEERING WHEEL

- ◀◀ **3** Raise/lower the seat by moving the control up/down.
- 4** Move the seat forward/rearward by moving the control forward/rearward.
- 5** Change the backrest tilt by moving the control forward/backward.

Only one movement (forward/rearward/up/down) can be performed at a time.

The front seat backrests cannot be folded down completely.

Related information

- Manual front seats (p. 182)
- Power* front seats (p. 183)
- Storing positions for seats, mirrors and head-up display* (p. 184)
- Using stored positions for seats, mirrors and head-up display* (p. 185)
- Adjusting front seat massage settings* (p. 187)
- Adjusting* front seat cushion length (p. 188)
- Front seat massage* settings (p. 186)
- Adjusting front seat side bolster settings* (p. 189)
- Adjusting front seat lumbar support* (p. 189)

- Adjusting the passenger seat from the driver's seat* (p. 191)

Storing positions for seats, mirrors and head-up display*

Adjustment settings for the power* seat, door mirrors and head-up display* can be stored in the memory buttons.

Two different positions for the power* seat, door mirrors and head-up display* can be stored using the memory buttons. The buttons are located on the inside of either one or both* front doors.

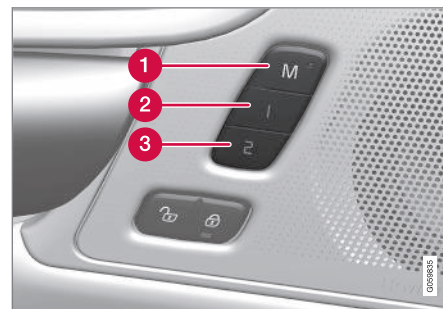

- 1** Button **M** for storing a setting.
- 2** Memory button.
- 3** Memory button.

⁴ Not available in vehicles with two-way lumbar support*.

Storing positions

1. Adjust the seat, door mirrors and head-up display to the desired position.
2. Press and hold the **M** button. The indicator light in the button will illuminate.
3. Within three seconds, press and hold the **1** or **2** button.
 - > When the position has been stored in the memory button, an audio signal will sound and the indicator light in the **M** button will go out.

If none of the memory buttons are pressed within three seconds, the **M** button will go out and no position will be stored.

The seats, door mirrors or head-up display must be readjusted before a new memory position can be set.

i NOTE

For the stored positions to work, all driver profiles need to be in **Protect Profile** mode.

Related information

- Manual front seats (p. 182)
- Power* front seats (p. 183)
- Adjusting the power* front seats (p. 183)
- Using stored positions for seats, mirrors and head-up display* (p. 185)
- Adjusting front seat massage settings* (p. 187)
- Adjusting* front seat cushion length (p. 188)
- Front seat massage* settings (p. 186)
- Adjusting front seat side bolster settings* (p. 189)
- Adjusting front seat lumbar support* (p. 189)
- Adjusting the passenger seat from the driver's seat* (p. 191)
- Adjusting the door mirrors (p. 168)
- Head-up display settings* (p. 142)
- Protecting a driver profile (p. 136)

Using stored positions for seats, mirrors and head-up display*

If the positions for the power* seat, door mirrors and head-up display* have been stored, they can be activated using the memory buttons.

Using a stored position

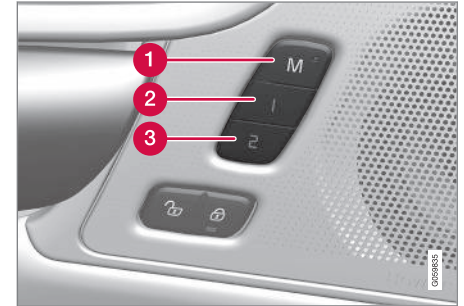

A stored position can be used with the front door open or closed:

Front door open

- Briefly press one of the memory buttons **1** (2) or **2** (3). The power seats, door mirrors and head-up display will move and stop at the positions stored in that button.



◀ Front door closed

- Press and hold one of the memory buttons **1** (2) or **2** (3) until the seat, door mirrors and head-up display stop in the positions stored in that memory button.

If the memory button is released, the seat, door mirrors and head-up display will stop moving.

WARNING

- This list point needs to be translated exactly to: "Because the driver's seat can be adjusted with the ignition off, children should never be left unattended in the vehicle.
- Movement of the seat can be STOPPED at any time by pressing any button on the power seat control panel.
- Do not adjust the seat while driving.
- The seat should be adjusted so that the brake pedal can be depressed fully. In addition, position the seat as far rearward as comfort and control allow.
- The seat rails on the floor must not be obstructed in any way when the seat is in motion.

NOTE

For the stored positions to work, all driver profiles need to be in **Protect Profile** mode.

Related information

- Manual front seats (p. 182)
- Power* front seats (p. 183)
- Adjusting the power* front seats (p. 183)
- Storing positions for seats, mirrors and head-up display* (p. 184)
- Adjusting front seat massage settings* (p. 187)
- Adjusting* front seat cushion length (p. 188)
- Front seat massage* settings (p. 186)
- Adjusting front seat side bolster settings* (p. 189)
- Adjusting front seat lumbar support* (p. 189)
- Adjusting the passenger seat from the driver's seat* (p. 191)
- Adjusting the door mirrors (p. 168)
- Head-up display settings* (p. 142)

Front seat massage* settings

The settings for the multifunctional seats can be adjusted using either the multifunction control on the side of the seat or the center display. The adjustment settings are shown in the center display.



Multifunction control, located on the side of the seat cushion.

Massage settings

The following massage settings are available:

- **On/Off:** Select **On/Off** to turn on/off the massage function.
- **Programs 1-5:** There are 5 preset massage programs. Select **Swell, Tread, Advanced, Lumbar** or **Shoulder**.
- **Intensity:** Select **Low, Normal** or **High**.
- **Speed:** Select **Slow, Normal** or **Fast**.

Restarting the massage function

The massage function turns off automatically after 20 minutes. The function is reactivated manually.

- Tap **Restart**, which is displayed in the center display, to restart the selected massage program.
 - > The massage program will restart. If no selection is made, the message will be stored in Top view.

Related information

- Manual front seats (p. 182)
- Power* front seats (p. 183)
- Adjusting the power* front seats (p. 183)
- Storing positions for seats, mirrors and head-up display* (p. 184)
- Using stored positions for seats, mirrors and head-up display* (p. 185)
- Adjusting front seat massage settings* (p. 187)
- Adjusting* front seat cushion length (p. 188)
- Adjusting front seat side bolster settings* (p. 189)
- Adjusting front seat lumbar support* (p. 189)
- Adjusting the passenger seat from the driver's seat* (p. 191)

Adjusting front seat massage settings*

The settings for the multifunctional seats can be adjusted using either the multifunction control on the seat or the center display. The adjustment settings are shown in the center display.

Adjusting front seat massage settings

The front seat backrests have a massage function. Air-filled cushions provide the massaging action and a number of settings are available.

The massage function can only be activated when the engine is running.

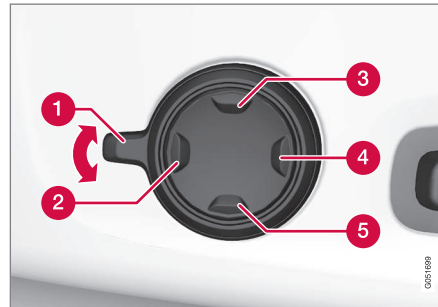

1. Activate the multifunction control by turning the control **1** upward/downward. The seat settings view will appear in the center display.

2. Select **Massage** in the seat settings view.
3. Select massage settings by tapping the center display or by moving the cursor up/down using the multifunction control's upper **3**/lower **5** buttons. Change a setting in the selected function by tapping the arrows on the center display or by using the multifunction control's front **2** / rear **4** buttons.

Related information

- Manual front seats (p. 182)
- Power* front seats (p. 183)
- Adjusting the power* front seats (p. 183)
- Storing positions for seats, mirrors and head-up display* (p. 184)
- Using stored positions for seats, mirrors and head-up display* (p. 185)
- Adjusting* front seat cushion length (p. 188)
- Front seat massage* settings (p. 186)
- Adjusting front seat side bolster settings* (p. 189)
- Adjusting front seat lumbar support* (p. 189)
- Adjusting the passenger seat from the driver's seat* (p. 191)

Adjusting* front seat cushion length

Depending on the selected equipment level, the length of the seat cushion can either be adjusted using the multifunction control* on the side of the seat cushion, or manually adjusted using the control on the front of the seat cushion.

Adjusting seat cushion length using the multifunction control

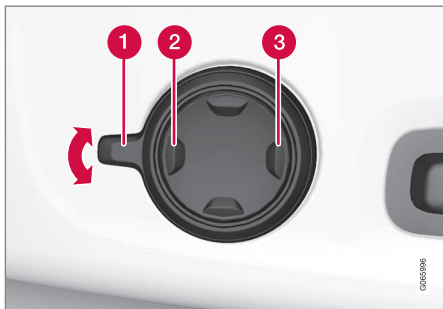

The multifunction control, located on the side of the seat cushion.

1. Activate the multifunction control by turning the control **1** upward/downward. The seat settings view will appear in the center display.

2. Select **Cushion extension** in the seat settings view.
 - Push in the front part of the four-way button **2** to extend the seat cushion.
 - Press the rear part of the four-way button **3** to shorten the seat cushion.

Manually adjusting seat cushion length

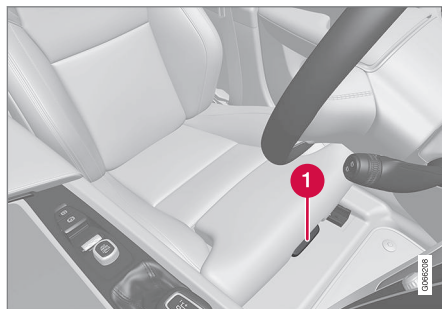

Control for adjusting seat cushion.

1. Grasp the **1** handle on the front of the seat and pull upward.
2. Adjust the length of the seat cushion.
3. Release the handle and make sure the seat cushion locks into position.

Related information

- Manual front seats (p. 182)
- Power* front seats (p. 183)
- Adjusting the power* front seats (p. 183)
- Storing positions for seats, mirrors and head-up display* (p. 184)
- Using stored positions for seats, mirrors and head-up display* (p. 185)
- Adjusting front seat massage settings* (p. 187)
- Front seat massage* settings (p. 186)
- Adjusting front seat side bolster settings* (p. 189)
- Adjusting front seat lumbar support* (p. 189)
- Adjusting the passenger seat from the driver's seat* (p. 191)

Adjusting front seat side bolster settings*

Enhance comfort in the front seat by adjusting the sides of the backrest.

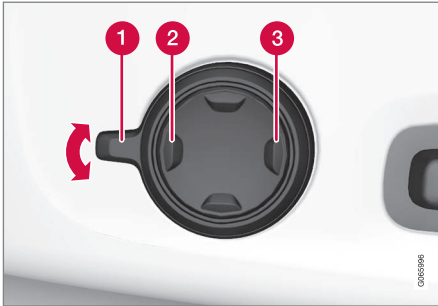

The multifunction control is located on the side of the seat cushion.

The side bolsters in the front seat backrests can be inflated/deflated to adjust the amount of support provided. The settings for the multifunctional seats can be adjusted using either the multifunction control on the seat or the center display. The adjustment settings are shown in the center display.

To adjust the side bolsters:

1. Activate the multifunction control by turning it upward/downward **1**. The seat settings view will appear in the center display.
2. Select **Side bolsters** in the seat settings view.
 - Press the front part of the four-way button to increase side bolster support **2**.
 - Press the rear part of the four-way button to decrease side bolster support **3**.

Related information

- Manual front seats (p. 182)
- Power* front seats (p. 183)
- Adjusting the power* front seats (p. 183)
- Storing positions for seats, mirrors and head-up display* (p. 184)
- Using stored positions for seats, mirrors and head-up display* (p. 185)
- Adjusting front seat massage settings* (p. 187)
- Adjusting* front seat cushion length (p. 188)
- Front seat massage* settings (p. 186)
- Adjusting front seat lumbar support* (p. 189)
- Adjusting the passenger seat from the driver's seat* (p. 191)

Adjusting front seat lumbar support*

Use the control on the side of the seat cushion to adjust the lumbar support.



Multifunction control, in vehicles with four-way lumbar support*.



Control in vehicles with two-way lumbar support*.



- ◀◀ Lumbar support is adjusted using the multifunction control in vehicles with four-way lumbar support*, or the round button in vehicles with two-way lumbar support*. The control is located on the side of the seat cushion. Depending on the selected equipment level, the lumbar support can be adjusted forward/rearward and up/down (four-way lumbar support) or forward/backward (two-way lumbar support).

Adjusting lumbar support in vehicles with four-way lumbar support

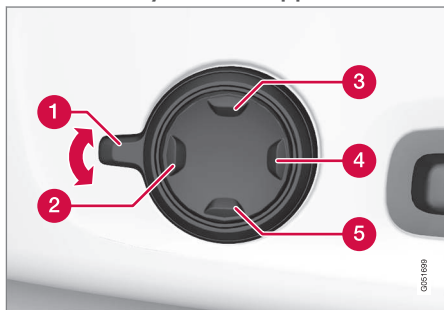

1. Activate the multifunction control by turning the control **1** upward/downward. The seat settings view will appear in the center display.

2. Select **Lumbar** in the seat settings view.

- Press the round button up **3**/down **5** to move the lumbar support upward/downward.
- Press the front part **2** of the button to increase lumbar support.
- Press the rear part **4** of the button to decrease lumbar support.

Adjusting lumbar support in vehicles with two-way lumbar support

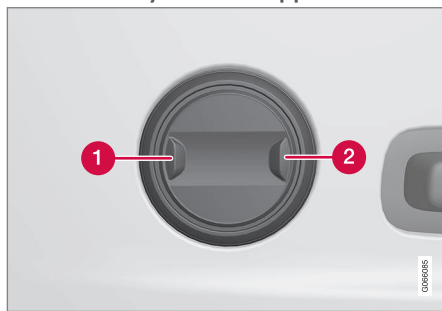

1. Press the front part **1** of the round button to increase lumbar support.
2. Press the rear part **2** of the round button to decrease lumbar support.

Related information

- Manual front seats (p. 182)
- Power* front seats (p. 183)
- Adjusting the power* front seats (p. 183)
- Storing positions for seats, mirrors and head-up display* (p. 184)
- Using stored positions for seats, mirrors and head-up display* (p. 185)
- Adjusting front seat massage settings* (p. 187)
- Adjusting* front seat cushion length (p. 188)
- Front seat massage* settings (p. 186)
- Adjusting front seat side bolster settings* (p. 189)
- Adjusting the passenger seat from the driver's seat* (p. 191)

Adjusting the passenger seat from the driver's seat*

The front passenger seat can be adjusted from the driver's seat.

Activating the function

The function is activated via the function view in the center display:



Tap the **Adjust Passenger Seat** button to activate.

Adjust passenger seat

The driver must adjust the passenger seat within 10 seconds of activating the function. If no adjustment is made within this time, the function will be deactivated.

The driver adjusts the passenger seat using the controls on the driver's seat:

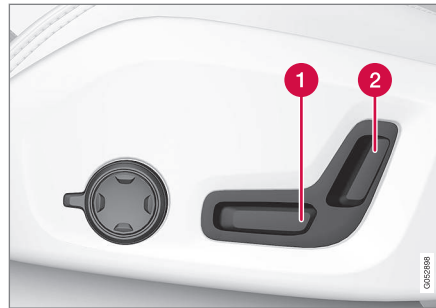

- 1 Move the passenger seat forward/rearward by moving the control forward/rearward.
- 2 Change the backrest tilt of the passenger seat by moving the control forward/backward.

Related information

- Manual front seats (p. 182)
- Power* front seats (p. 183)
- Adjusting the power* front seats (p. 183)
- Storing positions for seats, mirrors and head-up display* (p. 184)
- Using stored positions for seats, mirrors and head-up display* (p. 185)
- Adjusting front seat massage settings* (p. 187)

- Adjusting* front seat cushion length (p. 188)
- Front seat massage* settings (p. 186)
- Adjusting front seat side bolster settings* (p. 189)
- Adjusting front seat lumbar support* (p. 189)

Folding down the rear seat backrests

The rear seat backrest is split into two sections. The two sections can be folded forward individually.

⚠ WARNING

- Adjust the seat and ensure it locks into position before driving. Use caution when adjusting the seat. Uncontrolled or careless adjustments could lead to injury.
- Long objects must always be securely tied down to help prevent injury or damage in the event of sudden braking.
- Always turn off the engine and apply the parking brake when loading or unloading the vehicle.
- Put the gear selector in **P** to help prevent the gear selector from being inadvertently moved.

⚠ CAUTION

When the backrest is folded down, make sure there are no objects in the rear seat, and the seat belts are not buckled. Otherwise there is a risk of damage to the upholstery.

⚠ CAUTION

The armrest* in the center seat must be raised before the seat backrest is folded down.

The ski hatch must be closed before the seat backrest is folded down.

i NOTE

The front seats may need to be pushed forward and/or the backrest adjusted so that the rear seat backrests can be fully lowered.

Folding down the backrests

The vehicle must be stationary and at least one of the rear doors must be open before a backrest can be folded down.

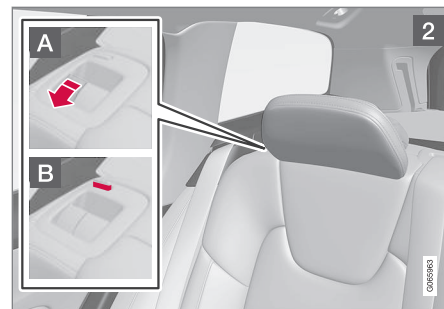
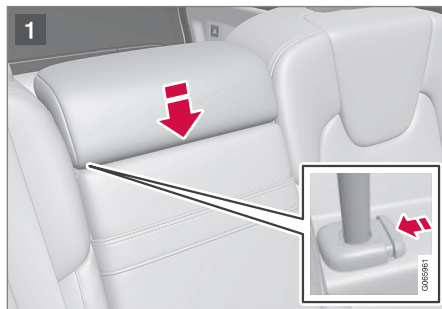

Make sure that the rear seat is unoccupied and that there are no objects on the seat.

- 1 Push down the center seat's head restraint manually.

- 2 Pull up the handle on the backrest **A** while folding down the backrest. The handle for the head restraint will be automatically pulled up when the backrest is lowered. A red indicator light near the backrest lock **B** indicates that the backrest is no longer locked.

i NOTE

When the backrest is folded down, the head restraint may come in contact with the seat cushion of the seat being folded down. Adjust the head restraints on the folded seat to help prevent damage to the fabric.

3. The backrest lock will release and the backrest will automatically fold down to the horizontal position.

Folding up the backrest

To fold up the backrest to the upright position manually:

1. Move the backrest upward/rearward.
2. Press the backrest until it locks into position.
3. Fold up the head restraints manually.

4. Adjust the center head restraint if necessary.

⚠ WARNING

When the backrest is restored to an upright position, the red indicator should no longer be visible. If it is still visible, the backrest is not locked in place.

⚠ WARNING

Make sure that the rear seat backrest and head restraint are locked securely in place after the seat is folded up.

The head restraints at the outer seats must always be raised when there is a passenger in one of these spots of the rear seat.

Related information

- Adjusting the rear seat head restraints (p. 193)
- Private Locking (p. 262)
- Activating and deactivating private locking (p. 263)

Adjusting the rear seat head restraints

Adjust the center head restraint in the rear seat to the seat occupant's height. Fold down the outboard head restraints* to improve rear visibility.

Adjusting the center seat head restraint

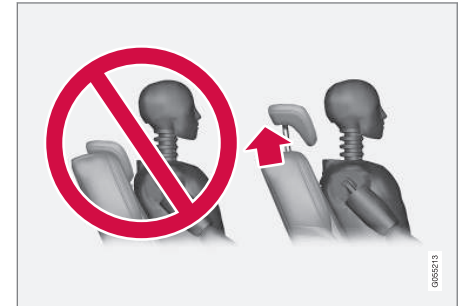

The center head restraint should be adjusted to suit the passenger's height. The entire back of the head should be covered if possible. Manually move the restraint up or down as needed.

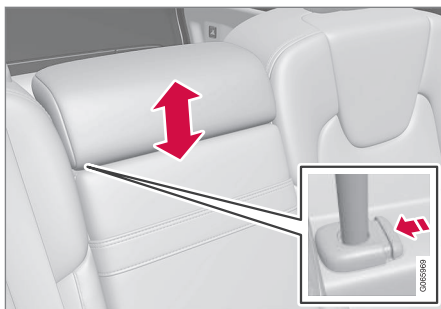

To lower the restraint, push and hold the button (see illustration) while carefully lowering the head restraint.

WARNING

The center seat head restraint must be in its lowest position when the seat is not occupied. When the center seat is occupied, the head restraint must be correctly adjusted to the passenger's height, covering the entire back of the head if possible.

Folding the rear seat outboard head restraints using the center display*

The outer head restraints can be folded via the center display's function view. The head restraint can be folded down when the vehicle is in ignition mode **O**.

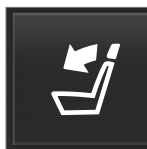

Tap the **Headrest Fold** button to activate/deactivate folding.

Manually push the head restraint until it clicks into position.

WARNING

Do not lower the head restraint if there are passengers in any of the rear seats.

WARNING

The head restraint must be locked in the upright position after it has been folded up.

Folding the rear seat outboard head restraints using the handle

The outboard head restraints can be folded using the handle on the top of the seat (see illustration **1**). Note that this method also folds down the backrests. To fold down only the head restraints, e.g. to improve visibility, use the center display* instead.



Related information

- Folding down the rear seat backrests (p. 192)

Steering wheel controls and horn

The steering wheel has a horn and controls for e.g. driver support systems and voice control.

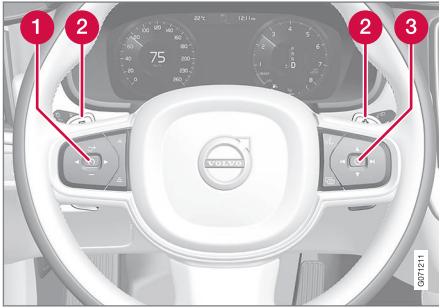

Steering wheel keypads and paddles*.

- 1 Driver support system controls.⁵
- 2 Paddle* for manually shifting gears (automatic transmission).
- 3 Controls for voice commands, accessing menus and messages, and handling phone calls.

Horn

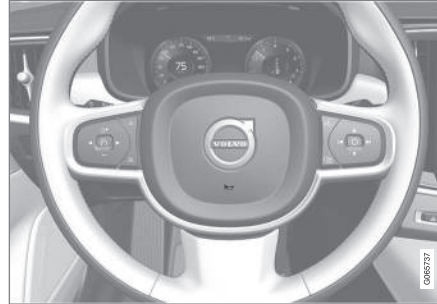

The horn is located in the center of the steering wheel.

Related information

- Adjusting the steering wheel (p. 195)

Adjusting the steering wheel

The steering wheel can be adjusted to various positions.

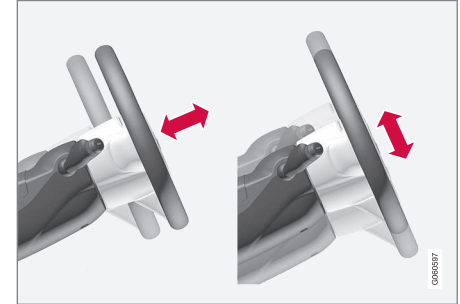

The steering wheel's reach and height can be adjusted.

WARNING

Adjust the steering wheel and ensure it locks into position before driving. Never adjust the steering wheel while driving.

⁵ Cruise Control, Adaptive Cruise Control*, Distance Alert* and Pilot Assist.

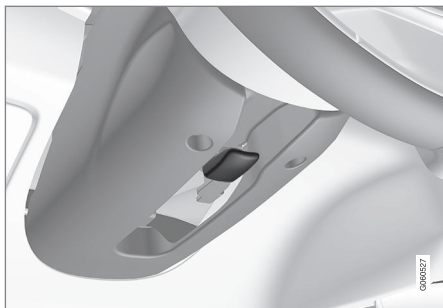

Steering wheel adjuster lever.

1. Move the lever forward to release the steering wheel.
2. Adjust the steering wheel to the desired position.
3. Pull the lever back to lock the steering wheel into place. If the lever is difficult to move, press or lift the steering wheel lightly while pulling the lever.

Related information

- Steering wheel controls and horn (p. 195)
- Adjusting the power* front seats (p. 183)
- Speed-dependent steering wheel resistance (p. 268)

CLIMATE CONTROL

Climate

The vehicle is equipped with electronic climate control. The climate system cools, heats and dehumidifies the air in the passenger compartment.

All of the climate system functions are controlled from the center display and the buttons on the center console.

Certain rear seat functions can also be controlled from the climate controls* on the rear of the tunnel console.

i NOTE

The climate system can be used to cool down the media system in the center display if needed. In these cases, the message **Climate system Cooling the infotainment system** will be shown in the instrument panel.

Related information

- Climate zones (p. 198)
- Climate control sensors (p. 199)
- Perceived temperature (p. 199)
- Climate control system voice commands (p. 200)
- Parking climate (p. 221)
- Heater (p. 230)
- Air quality (p. 201)

- Air distribution (p. 204)
- Climate system controls (p. 210)

Climate zones

The vehicle is divided into climate zones to make it possible to set different temperatures for different parts of the passenger compartment.

2-zone climate system

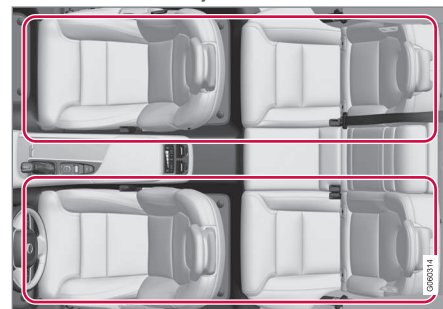

Climate zones with 2-zone climate system.

In 2-zone climate systems, the passenger compartment temperature can be set separately for the left and right sides of the vehicle.

Related information

- Climate (p. 198)

Climate control sensors

The climate system has a number of sensors to help regulate the climate settings in the vehicle. Do not cover or block the sensors with clothing or other objects.

Location of the sensors

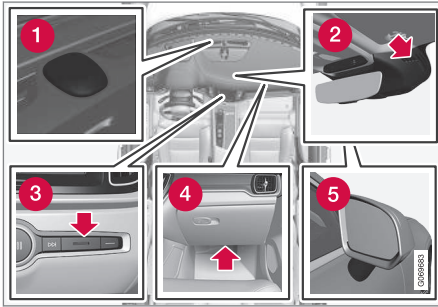

- 1 Sunlight sensors - on the upper side of the dashboard.
- 2 Humidity sensor - in the rearview mirror console.
- 3 Passenger compartment temperature sensor - near the buttons in the center console.
- 4 Airborne particulate matter sensor* – on the underside of the glove compartment.
- 5 Ambient temperature sensor - in the right-side door mirror.

On vehicles equipped with the Interior Air Quality System*, there is also an air quality sensor in the climate system's air intake.

Related information

- Climate (p. 198)
- Interior Air Quality System* (p. 202)

Perceived temperature

The climate control system regulates the climate in the passenger compartment based on perceived temperature, not actual temperature.

The selected passenger compartment temperature is based on the physical perception of the current ambient temperature, airflow speed, humidity, sunlight in the passenger compartment, etc.

The system has a sunlight sensor that detects which side of the vehicle the sunlight is shining on and adjusts the temperature accordingly. This means that the temperature of the air coming out of the vents may be different for the left and right sides, even if the temperature setting is the same for both sides.

Related information

- Climate (p. 198)

Climate control system voice commands¹

Voice commands can be used for the climate control system to e.g. change temperature, activate seat heating* or change blower speed.

Tap  and say one of the following commands:

- **"Climate"** - starts a command dialog for climate controls and provides examples of commands that can be used.
- **"Set temperature to X degrees"** - sets desired temperature.
- **"Raise temperature"/"Lower temperature"** - raises/lowers the set temperature.
- **"Sync temperature"** - synchronizes the temperature for all climate zones in the vehicle with the temperature set for the driver's side.
- **"Air on feet"/"Air on body"** - opens the desired air vent.
- **"Air on feet off"/"Air on body off"** - closes the desired air vent.
- **"Set fan to max"/"Turn off fan"** - changes blower speed to **Max/Off**.
- **"Raise fan speed"/"Lower fan speed"** - raises/lowers the set blower speed.
- **"Turn on auto"** - activates automatic climate control.
- **"Air condition on"/"Air condition off"** - activates/deactivates air conditioning.
- **"Recirculation on"/"Recirculation off"** - activates/deactivates air recirculation.
- **"Turn on defroster"/"Turn off defroster"** - activates/deactivates window and door mirror defrosting.
- **"Turn on max defroster"/"Turn off max defroster"** - activates/deactivates max defroster.
- **"Turn on rear defroster"/"Turn off rear defroster"** - Activates/deactivates heated rear window and door mirrors.
- **"Turn steering wheel heat on"/"Turn steering wheel heat off"** - activates/deactivates heated steering wheel*.
- **"Raise steering wheel heat"/"Lower steering wheel heat"** - raises/lowers the level of steering wheel heating*.
- **"Turn on seat heat"/"Turn off seat heat"** - activates/deactivates seat heating*.
- **"Raise seat heat"/"Lower seat heat"** - raises/lowers the level of seat heating*.
- **"Turn on seat ventilation"/"Turn off seat ventilation"** - activates/deactivates seat ventilation*.

- **"Raise seat ventilation"/"Lower seat ventilation"** - raises/lowers the level of seat ventilation*.

NOTE

Not all system languages support voice control. If a language supports voice control, it is marked with a  symbol in the list of available system languages. Read more about where the information is found in the section on voice control settings.

Related information

- Climate (p. 198)
- Voice Control (p. 143)
- Use voice recognition (p. 144)
- Voice control settings (p. 148)

¹ Certain markets only.

Air quality

The materials used in the passenger compartment and air filtering system have been selected to ensure a high level of air quality in the passenger compartment.

Materials used in the passenger compartment

The materials in the passenger compartment are designed to be pleasant and comfortable, even for people with asthma or allergies.

The materials have been developed and tested to reduce dust in the passenger compartment and make it easier to keep clean.

The mats in both the passenger compartment and cargo compartment can be easily removed for cleaning.

Use Volvo-recommended cleaning agents and car care products to clean the interior.

Air filtering systems

In addition to the passenger compartment air filter, the vehicle is also equipped with other air cleaning systems that help you maintain high air quality in the passenger compartment.

Related information

- Climate (p. 198)
- CleanZone* (p. 201)
- Clean Zone Interior Package* (p. 202)
- Interior Air Quality System* (p. 202)

- Advanced Air Cleaner* (p. 204)
- Passenger compartment air filter (p. 203)

CleanZone*

The CleanZone function monitors the conditions affecting good air quality in the passenger compartment and indicates whether they are fulfilled or not.

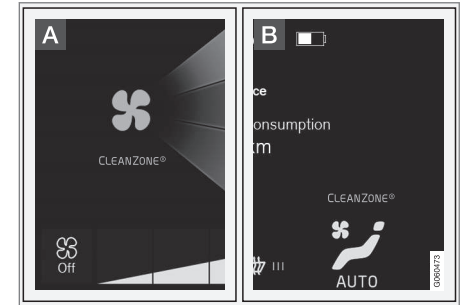

- A** The indicator is shown in the center display's Climate view.
- B** The indicator is shown in the climate bar when Climate view is not open.

If the conditions are not met, the text **Clean Zone** will be shown in white. When all the conditions are met, the text will change to blue.

The following conditions must be met:

- All doors and tailgate are closed.
- All side windows and panoramic roof* are closed.



- ◀◀ • The Interior Air Quality System* is activated.
- The blower is activated.
- Air recirculation is deactivated.

i NOTE

CleanZone does not indicate that the air quality is good, but only that the conditions for good air quality have been met.

Related information

- Air quality (p. 201)
- Clean Zone Interior Package* (p. 202)
- Interior Air Quality System* (p. 202)
- Passenger compartment air filter (p. 203)

Clean Zone Interior Package*

Clean Zone Interior Package (CZIP) is a series of modifications that filters even more allergy and asthma-inducing substances and other pollutants from the passenger compartment. CZIP includes the following:

- An enhanced function that starts the blower when the vehicle is unlocked using the remote key. The blower will then fill the passenger compartment with fresh air. The function starts when required and switches off automatically after a period of time or when one of the passenger compartment doors is opened. The amount of time the blower runs gradually decreases due to reduced need up until the vehicle is 4 years old.
- The fully automatic Interior Air Quality System (IAQS).

Related information

- Air quality (p. 201)
- CleanZone* (p. 201)
- Interior Air Quality System* (p. 202)
- Passenger compartment air filter (p. 203)

Interior Air Quality System*

Interior Air Quality System (IAQS) is a fully automatic air quality system that removes gases and particles to reduce odors and contaminants in the passenger compartment. IAQS is part of the Clean Zone Interior Package (CZIP) and removes air contaminants such as particles, hydrocarbons, nitric oxides and ground-level ozone.

If the system's air quality sensors detect contaminants in the outside air, the air intake closes and air recirculation is activated.

i NOTE

To ensure optimal air quality in the passenger compartment, the air quality sensor should always be engaged.

Recirculation is limited in cold weather to prevent fogging.

In the event of fogging, use the defroster functions for the windshield, side windows and rear window.

Related information

- Activating and deactivating the air quality sensor* (p. 203)
- Air quality (p. 201)
- CleanZone* (p. 201)

- Clean Zone Interior Package* (p. 202)
- Passenger compartment air filter (p. 203)

Activating and deactivating the air quality sensor*

The air quality sensor is part of the fully automated Interior Air Quality System (IAQS).

The air quality sensor can be switched on or off.

1. Tap **Settings** in the Top view in the center display.
2. Tap **Climate**.
3. Select **Air Quality Sensor** to activate/deactivate the air quality sensor.

Related information

- Interior Air Quality System* (p. 202)

Passenger compartment air filter

All air entering the passenger compartment through the climate control system intake is filtered.

Replacing the passenger compartment filter

To maintain the high performance of the climate control system, the filter must be replaced regularly. Follow Volvo's service schedule for recommended replacement intervals. When driving in areas with a lot of smog, dust, etc., the filter may need to be changed more frequently.

NOTE

There are two types of passenger compartment filters. Make sure that the correct filter is installed.

Related information

- Air quality (p. 201)
- CleanZone* (p. 201)
- Clean Zone Interior Package* (p. 202)
- Interior Air Quality System* (p. 202)

Advanced Air Cleaner*

Advanced Air Cleaner is a fully automatic air cleaner that traps airborne particulate matter, exhaust and other pollutants in the passenger compartment air filter, which improves the climate in the passenger compartment.

The function starts automatically when the blower starts.

Airborne particulate matter are also known as PM_{2.5} (particles smaller than 2.5 µm), and the concentrations of these particles in the vehicle are measured by one of the vehicle's climate control sensors. The concentration in the vehicle is presented in the downloadable app Air Quality.

Related information

- Air quality (p. 201)
- Interior Air Quality System* (p. 202)
- CleanZone* (p. 201)
- Clean Zone Interior Package* (p. 202)
- Passenger compartment air filter (p. 203)
- Climate control sensors (p. 199)

Air distribution

The climate system distributes incoming air through a number of vents in the passenger compartment.

Automatic and manual air distribution

When the auto-climate feature is on, air distribution is regulated automatically. Air distribution can also be controlled manually.

Adjustable air vents

Certain air vents in the vehicle are adjustable, which means they can be opened/closed and the direction of the air flow from the vent can be adjusted.

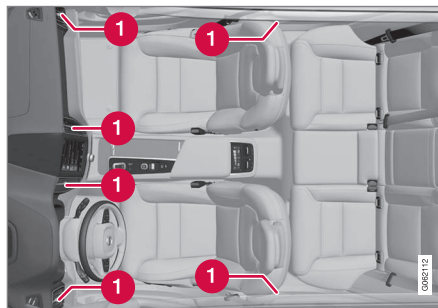

Location of adjustable air vents in the passenger compartment.

- 1 Four vents on the dashboard and one on each of the pillars between the front and rear doors.

Related information

- Climate (p. 198)
- Adjusting air distribution (p. 205)
- Opening, closing and directing air vents (p. 205)
- Air distribution options (p. 207)

Adjusting air distribution

Air distribution can be adjusted manually if needed.



1. Tap the symbol in the center of the climate bar to open Climate view in the center display.

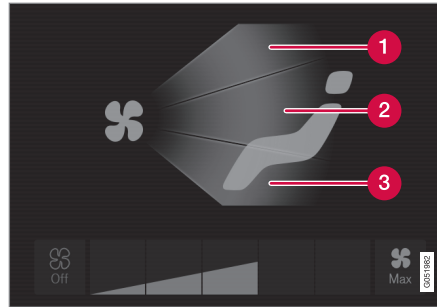

Air distribution buttons in Climate view.

- 1 Air distribution - windshield defrost vents
 - 2 Air distribution - dashboard and center console air vents
 - 3 Air distribution - floor air vents
2. Tap one or more air distribution buttons to open/close the airflow for that vent.
 - > The air distribution changes and the buttons will light up or go out.

Related information

- Air distribution (p. 204)
- Opening, closing and directing air vents (p. 205)
- Air distribution options (p. 207)

Opening, closing and directing air vents

Some of the air vents in the passenger compartment can be individually opened, closed and directed.

Misting can be eliminated by directing the outer air vents towards the door windows.

Direct the outer air vents into the passenger compartment to maintain a comfortable temperature in warm weather.

Opening and closing the air vents

Air vents on the dashboard:

- Turn the knob in the center of the air vent to open/close airflow from the vent.
 - When the mark on the knob is vertical, the airflow is strongest.

Air vents on the door pillars:

- Move the lever in the center of the air vent up/down to open/close the airflow from the vent.

The airflow is stopped when the lever is in the lowest position. In other positions, the airflow is constant.

Directing air flow

- Move the lever in the center of the air vent horizontally or vertically to direct the airflow from the vent.







◀◀ **Related information**

- Air distribution (p. 204)
- Adjusting air distribution (p. 205)
- Air distribution options (p. 207)





Air distribution options

Air distribution can be adjusted manually if needed. The following options are available.

	Air distribution	Purpose
	<p>If all air distribution buttons are deselected in manual mode, the climate control system will revert to automatic mode.</p>	
	<p>Main airflow from defroster vents. Some airflow from other vents.</p>	<p>Helps remove ice and condensation in cold and humid weather (blower speed should not be set too low).</p>
	<p>Main airflow from dashboard vents. Some airflow from other vents.</p>	<p>Provides effective cooling in warm weather.</p>
	<p>Main airflow from floor vents. Some airflow from other vents.</p>	<p>Provides heating or cooling in footwell areas.</p>





	Air distribution	Purpose
	<p>Main airflow from defroster and dashboard vents. Some airflow from other vents.</p>	<p>Provides a comfortable climate in warm and dry weather.</p>
	<p>Main airflow from defroster and floor vents. Some airflow from other vents.</p>	<p>Provides a comfortable climate and effective defogging in cold and humid weather.</p>
	<p>Main airflow from dashboard and floor vents. Some airflow from other vents.</p>	<p>Provides a comfortable climate in sunny, cool weather.</p>
	<p>Main airflow from defroster, dashboard and floor vents.</p>	<p>Provides balanced comfort in the passenger compartment.</p>

Related information

- Air distribution (p. 204)
- Opening, closing and directing air vents (p. 205)
- Adjusting air distribution (p. 205)

Climate system controls

The climate system functions are controlled from physical buttons on the center console, the center display, and the climate panel on the rear side of the tunnel console*.

Physical buttons in the center console

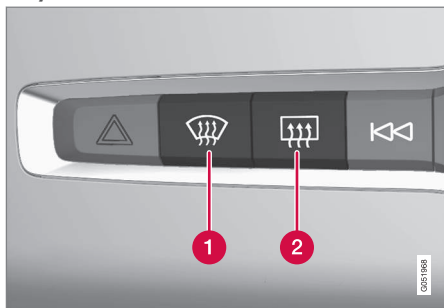

- 1 Button for max defroster.
- 2 Button for heated rear window and door mirrors.

Climate bar in the center display

The most common climate system functions can be controlled from the climate bar.

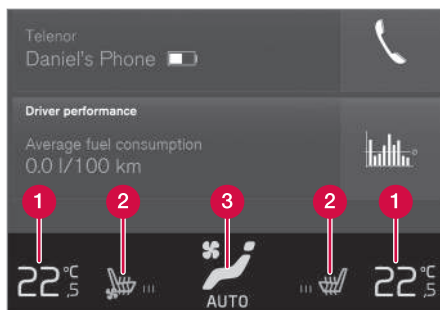

- 1 Temperature controls for driver and passenger side.
- 2 Controls for heated* and ventilated* driver and front passenger seat, as well as heated steering wheel*.
- 3 Button for opening Climate view. The graphic in the button shows activated climate system settings.

Climate view in the center display



Tap the symbol in the center of the climate bar to open Climate view.

Depending on equipment level, Climate view may be divided into several tabs. Toggle between the tabs by swiping the screen to the left/right or by tapping the desired heading.

Main climate

In addition to the functions in the climate bar, other main climate system functions can be controlled from the **Main climate** tab.

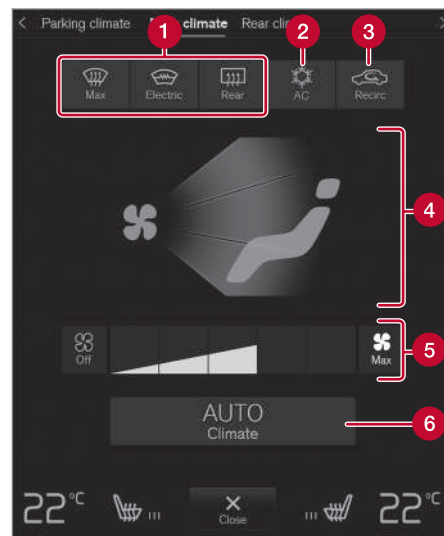

- 1 **Max, Rear** – Controls for defrosting windows and door mirrors.
- 2 **AC** - Air conditioning controls.
- 3 **Recirc** - Air recirculation controls.
- 4 Air distribution controls.

- 5 Blower control.
- 6 **AUTO** - Automatic climate control.

Parking climate

Parking climate functions can be controlled from the **Parking climate** tab.

Climate controls on the rear side of the tunnel console*

If the vehicle is equipped with heated rear seats*, there are physical buttons on the rear side of the tunnel console to control this function.

Related information

- Climate (p. 198)
 - Activating and deactivating power front seats* (p. 211)
 - Activating and deactivating the heated rear seats* (p. 212)
 - Activating and deactivating front seat ventilation* (p. 213)
 - Activating and deactivating the heated steering wheel* (p. 214)
 - Activating auto climate control (p. 214)
 - Activating and deactivating recirculation (p. 215)
 - Activating and deactivating max defroster (p. 216)
- Activating and deactivating the heated rear window and door mirrors (p. 217)
 - Setting the blower speed for the front seats (p. 218)
 - Synchronize temperature (p. 220)
 - Activating and deactivating air conditioning (p. 221)

Activating and deactivating power front seats*

The seats can be heated for added comfort for the driver and passengers in cold weather.



1. Tap the left- or right-side steering wheel and seat button in the center display's climate bar to open the controls for steering wheel and seat heating.

If the vehicle is not equipped with ventilated seats or heated steering wheel (for the driver's side), the button for seat heating is directly accessible in the climate bar.



2. Tap the seat heating button repeatedly to select one of the four levels: **Off**, **High**, **Medium** or **Low**.
 - > The level is changed and the set level is displayed in the button.





⚠ WARNING

Heated seats should not be used by people who have difficulty detecting temperature increases due to nerve damage or numbness or who for another reason may have difficulty operating the controls for seat heating.

Related information

- Climate system controls (p. 210)
- Activating and deactivating the heated front seat* (p. 212)

Activating and deactivating the heated front seat*

The seats can be heated for added comfort for the driver and passengers in cold weather. Seat heating can be set to automatically activate when the engine is started. When set to automatically activate, heating will be turned on at low ambient temperatures.

1. Tap **Settings** in the Top view in the center display.
2. Tap **Climate**.
3. Select **Auto Driver Seat Heating Level** and **Auto Passenger Seat Heating Level** to activate/deactivate automatic start of heated driver's and passenger seat.
 - > An "A" will be displayed next to the relevant seat heating button in the climate bar when auto start has been activated.
4. Select **Low, Medium** or **High** to select level after the function has been activated.

Related information

- Climate system controls (p. 210)
- Activating and deactivating power front seats* (p. 211)

Activating and deactivating the heated rear seats*

The seats can be heated for added comfort for the driver and passengers in cold weather.

Activating and deactivating the heated rear seats from the rear seat

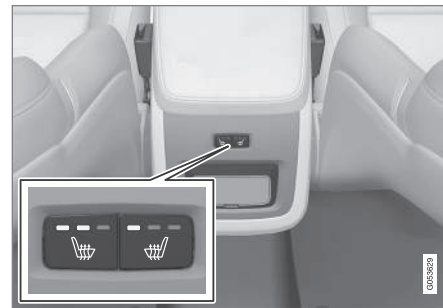

Buttons for seat heating on the rear side of the tunnel console.

- Press repeatedly on the left or right seat heating buttons on the rear side of the tunnel console to select one of four levels: **Off, High, Medium** or **Low**.
 - > The level is changed and the indicator lights in the button display the level.

⚠ WARNING

Heated seats should not be used by people who have difficulty detecting temperature increases due to nerve damage or numbness or who for another reason may have difficulty operating the controls for seat heating.

Related information

- Climate system controls (p. 210)

Activating and deactivating front seat ventilation*

The seats can be ventilated to provide **increased comfort in warm weather.**

The ventilation system consists of fans in the seats and backrest that draw air through the seat upholstery. The cooler the passenger compartment is, the greater the cooling effect of the ventilation. The system can be activated when the engine is running.



1. Tap the left- or right-side steering wheel and seat button in the center display's climate bar to open the controls for steering wheel and seat heating.

If the vehicle is not equipped with heated seats or heated steering wheel (for the driver's side), the button for seat ventilation is directly accessible in the climate bar.



2. Tap the seat ventilation button repeatedly to select one of the four levels: **Off, High, Medium or Low.**
 - > The level is changed and the set level is displayed in the button.

Related information

- Climate system controls (p. 210)

Activating and deactivating the heated steering wheel*

The steering wheel can be heated for added comfort in cold weather.



1. Tap the driver's side steering wheel and seat button in the climate bar in the center display to open the controls for steering wheel and seat heating.

If the vehicle is not equipped with heated or ventilated seats, the button for steering wheel heating is directly accessible in the climate bar.



2. Tap the steering wheel heating button repeatedly to select one of the four levels: **Off, High, Medium** or **Low**.
 - > The level is changed and the set level is displayed in the button.

Related information

- Climate system controls (p. 210)
- Activating and deactivating automatic steering wheel heating* (p. 214)

Activating and deactivating automatic steering wheel heating*

The steering wheel can be heated for added comfort in cold weather.

Steering wheel heating can be set to automatically activate when the engine is started. When set to automatically activate, heating will be turned on at low ambient temperatures.

1. Tap **Settings** in the Top view in the center display.
2. Tap **Climate**.
3. Select **Auto Steering Wheel Heating Level** to activate/deactivate automatic start of heated steering wheel.
 - > An "A" will be displayed next to the heated steering wheel button in the climate bar when auto start has been activated.
4. Select **Low, Medium** or **High** to select level after the function has been activated.

Related information

- Activating and deactivating the heated steering wheel* (p. 214)

Activating auto climate control

If auto climate control is activated, several climate system functions are controlled automatically.



1. Tap the symbol in the center of the climate bar to open Climate view in the center display.
2. Tap or press and hold **AUTO Climate**/**>**
 - Tap - air recirculation, air conditioning and air distribution are controlled automatically.
 - Press and hold - air recirculation, air conditioning and air distribution are controlled automatically. Temperature and blower speed are changed to standard settings: 22 °C (72 °F) and speed **3**.
 - > Auto climate mode is activated and the button lights up.

i NOTE

It is possible to change the temperature and blower speed without deactivating automatic climate control. Automatic climate control is deactivated when the air distribution is changed manually or when the max defroster is activated.

Related information

- Climate system controls (p. 210)

Activating and deactivating recirculation

The climate system's recirculation function helps shut out smog, smoke, exhaust fumes, etc. by reusing the air in the passenger compartment.



1. Tap the symbol in the center of the climate bar to open Climate view in the center display.



2. Tap **Recirc**.
 - > Air recirculation is activated/deactivated and the button lights up/goes out.

i CAUTION

If the air in the vehicle is recirculated too long, there is a risk of fogging on the inside of the windows.

i NOTE

Recirculation cannot be activated when the max defroster is on.

Related information

- Climate system controls (p. 210)
- Activating and deactivating the recirculation timer setting (p. 216)

Activating and deactivating the recirculation timer setting

The climate system's recirculation function helps shut out smog, smoke, exhaust fumes, etc. by reusing the air in the passenger compartment.

When the recirculation timer is activated, air recirculation will switch off automatically after 20 minutes.

1. Tap **Settings** in the Top view in the center display.
2. Tap **Climate**.
3. Tap **Recirculation Timer** to activate/deactivate the recirculation timer.

Related information

- Activating and deactivating recirculation (p. 215)

Activating and deactivating max defroster

Max defroster is used to quickly remove condensation and ice from windows.

Max defroster deactivates automatic climate control and air recirculation, activates the air conditioning, and changes blower speed to **5** and temperature to **HI**.

NOTE

The volume increases when the blower speed is changed to **5**.

When max defroster is deactivated, the climate system reverts to the previous settings.

Activating and deactivating max defroster from the center console

A button in the center console offers quick access to the max defroster.



Button in center console.

- Tap the button.
 - > Max defroster is activated/deactivated and the button lights up/goes out.

Activating and deactivating max defroster from the center display



1. Tap the symbol in the center of the climate bar to open Climate view in the center display.



2. Tap **Max**.
 - > Max defroster is activated/deactivated and the button lights up/goes out.

Related information

- Climate system controls (p. 210)

Activating and deactivating the heated rear window and door mirrors

The heated rear window and door mirrors are used to quickly remove condensation and ice from the glass.

Activating and deactivating the heated rear window and door mirrors from the center console

A button in the center console offers quick access to the heated rear window and door mirrors functions.



Button in center console.

- Tap the button.
 - > Heated windows and door mirrors are activated and the button lights up/goes out.

Activating and deactivating the heated rear window and door mirrors from the center display



1. Tap the symbol in the center of the climate bar to open Climate view in the center display.



2. Tap **Rear**.
 - > Heated windows and door mirrors are activated and the button lights up/goes out.

Related information

- Climate system controls (p. 210)
- Automatically activating and deactivating the heated rear window and door mirrors (p. 218)

Automatically activating and deactivating the heated rear window and door mirrors

The heated rear window and door mirrors are used to quickly remove condensation and ice from the glass.

It is possible to select whether rear window and door mirror heating should be automatically activated or deactivated when the engine is started. With automatic start activated, heating will be activated when there is a risk of ice or condensation on the windows or mirrors. Heating is automatically switched off when the window or door mirror is sufficiently warm and the condensation or ice is gone.

1. Tap **Settings** in the Top view in the center display.
2. Tap **Climate**.
3. Select **Auto Rear Defroster** to activate/deactivate automatic rear window and door heating.

Related information

- Activating and deactivating the heated rear window and door mirrors (p. 217)

Setting the blower speed for the front seats²

The blower can be set to several different automatically controlled speeds for the front seat.



1. Tap the symbol in the center of the climate bar to open Climate view in the center display.

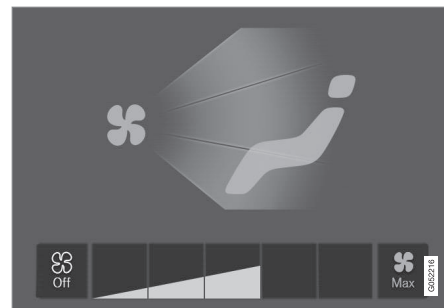

Blower control buttons in Climate view.

2. Tap the desired blower speed: **Off**, **1-5** or **Max**.
 - > The blower speed will be changed and the buttons for the set speed will light up.

! **CAUTION**

The air conditioning will not engage if the blower is turned off completely, which may cause fogging on the inside of the windows.

² The same setting applies to the rear seats with the 2-zone climate system.

i NOTE

The climate system automatically adapts airflow as needed within the set blower speed, which means that airflow speed may vary slightly within the same blower speed.

Related information

- Climate system controls (p. 210)

Setting the temperature for the front seats³

The temperature can be set to the desired number of degrees for the front seat climate zones.



Temperature buttons in the climate bar.

1. Tap the left- or right-side temperature buttons in the center display's climate bar to open the control.

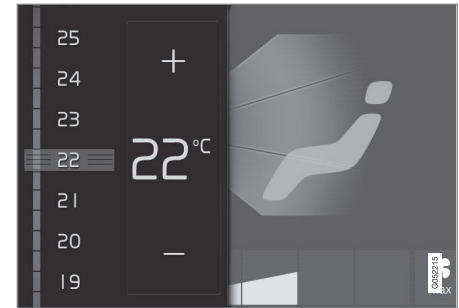

Temperature control.

2. Set the temperature by doing one of the following:
 - dragging the control to the desired temperature, or
 - tapping +– to raise/lower the temperature.

> The temperature will be set and the button will display the new temperature.

i NOTE

Heating/cooling cannot be accelerated by choosing a higher/lower temperature than the desired temperature.

³ The same setting applies to the rear seats with the 2-zone climate system.

◀◀ Related information

- Climate system controls (p. 210)

Synchronize temperature

The temperature in the different climate zones of the vehicle can be synchronized with the temperature set for the driver's side.

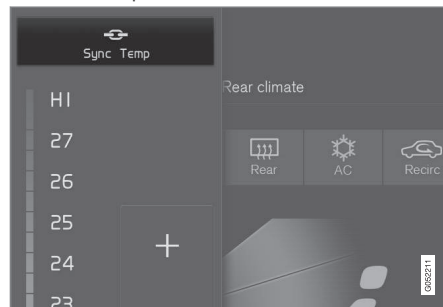

Synchronization button on the driver's side temperature control.

1. Tap the driver's side temperature button in the center display's climate bar to open the control.
2. Tap **Synchronize temperature**.
 - > The temperature for all of the vehicle's climate zones will be synchronized with the one set for the driver's side and the synchronization symbol will be displayed next to the temperature button.

Synchronization is stopped with another press on **Synchronize temperature** or by changing the temperature setting for a climate zone other than the driver's.

Related information

- Climate system controls (p. 210)

Activating and deactivating air conditioning

The air conditioning cools and dehumidifies incoming air as needed.

When the air conditioning is activated, it will be switched on and off automatically by the climate system as needed.



1. Tap the symbol in the center of the climate bar to open Climate view in the center display.



2. Tap **AC**.
 - > Air conditioning is activated/deactivated and the button lights up/goes out.

i NOTE

For optimal air conditioning function, close all the side windows and the panoramic roof*.

i NOTE

The air conditioning cannot be activated when the fan speed is set to **Off**.

Related information

- Climate system controls (p. 210)

Parking climate

Parking climate is an umbrella term for various functions that improve the passenger compartment climate when the vehicle is parked, e.g. preconditioning.



Parking climate functions are controlled from the **Parking climate** tab in the center display's Climate view.

Tap the symbol in the center of the climate bar to open Climate view.

Related information

- Climate (p. 198)
- Preconditioning (p. 222)
- Pre-cleaning* (p. 226)
- Climate comfort retaining function (p. 227)
- Parking climate symbols and messages (p. 229)

Preconditioning

Preconditioning is a climate function that, if possible, attempts to achieve a comfortable temperature in the passenger compartment before driving.

Preconditioning can be started immediately or started at a preset time using a timer.

The function utilizes several of the vehicle's systems:

- In cold weather, the parking heater heats the passenger compartment to a comfortable temperature.
- In warm weather, air conditioning cools the passenger compartment to a comfortable temperature.
- The electrically heated steering wheel* and seats* can be activated.
- Heating for the rear window and door mirrors is automatically activated as needed.

During preconditioning in a hot climate, condensation from the air conditions may drip under the vehicle. This is normal.

NOTE

Preconditioning is only available when the vehicle is plugged into an electrical outlet. A charging post that is not always active, e.g. due to a timer, can prevent preconditioning from functioning.

If the vehicle is not connected to an electrical socket it is still possible in a warm climate to achieve brief cooling of the passenger compartment by direct starting preconditioning.

NOTE

During preconditioning of the passenger compartment, the vehicle works to reach a comfortable temperature and not the temperature set in the climate system.

NOTE

Pre-cleaning* starts automatically when preconditioning is complete.

Related information

- Parking climate (p. 221)
- Starting and stopping preconditioning (p. 222)
- Preconditioning timer (p. 223)
- Pre-cleaning* (p. 226)

Starting and stopping preconditioning

Preconditioning heats or cools the passenger compartment, if possible, before driving. The function can be started in the center display or from a cellular phone.

Starting and stopping from the vehicle



1. Tap the symbol in the center of the climate bar to open Climate view in the center display.
2. Select the **Parking climate** tab.
3. Tap the boxes to select if seat/steering wheel heating should be activated along with preconditioning for each function.
4. Tap **Start Pre-con. & Cleaning**.
 - > Preconditioning starts/stops and the button lights up/goes out.

i NOTE

Preconditioning is only available when the vehicle is plugged into an electrical outlet. A charging post that is not always active, e.g. due to a timer, can prevent preconditioning from functioning.

If the vehicle is not connected to an electrical socket it is still possible in a warm climate to achieve brief cooling of the passenger compartment by direct starting preconditioning.

i NOTE

The vehicle doors and windows should be closed during preconditioning of the passenger compartment.

i NOTE

Pre-cleaning* starts automatically when preconditioning is complete.

Starting from app

A device with the Volvo On Call* app can be used to start preconditioning or check settings. Preconditioning heats or cools the passenger compartment (using the vehicle's air conditioning) to a comfortable temperature.

The passenger compartment can also be preconditioned using the Engine Remote Start (ERS)⁴ function using the Volvo On Call* app.

Related information

- Parking climate (p. 221)
- Preconditioning (p. 222)
- Preconditioning timer (p. 223)
- Pre-cleaning* (p. 226)

Preconditioning timer

The timer can be set to finish preconditioning at a predetermined time.

The timer can store up to 8 preset times for

- a time on a particular date
- a time on one or more days of the week, with or without the repeat function.

i NOTE

Preconditioning is only available when the vehicle is plugged into an electrical outlet. A charging post that is not always active, e.g. due to a timer, can prevent preconditioning from functioning.

If the vehicle is not connected to an electrical socket it is still possible in a warm climate to achieve brief cooling of the passenger compartment by direct starting preconditioning.

Related information

- Preconditioning (p. 222)
- Adding and editing timer settings for preconditioning (p. 224)
- Activating and deactivating preconditioning timer (p. 225)
- Deleting preconditioning timer settings (p. 225)

⁴ Certain markets only.

Adding and editing timer settings for preconditioning

The preconditioning timer can store up to 8 preset timer settings.

Adding a timer setting

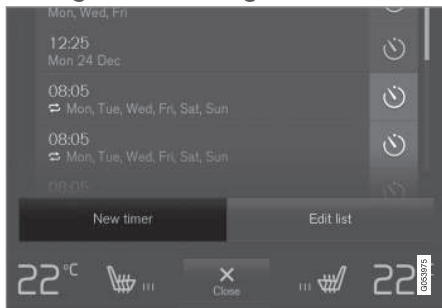

Button for adding a timer setting in the **Parking climate** tab in Climate view.

1. Open Climate view in the center display.
2. Select the **Parking climate** tab.

3. Tap **Add timer**.
> A pop-up window will appear.

i NOTE

It is not possible to add a time setting if there are already 8 settings for the timer. Delete a time setting to be able to add a new one.

4. Tap **Date** to set a time for a specific date.

Tap **Days** to set a time for one or more days of the week.

With **Days**: Activate/deactivate the repeat function by selecting/deselecting the **Repeat weekly** checkbox.

5. With **Date**: Select a date for preconditioning by scrolling in the date list using the arrows.

With **Days**: Select days of the week for preconditioning by tapping the buttons for the days.

6. Set the time at which preconditioning should be completed by scrolling using the arrows in the clock.
7. Tap **Confirm** to add a timer setting.
> The timer setting will be added to the list and activated.

Editing the timer setting

1. Open Climate view in the center display.
2. Select the **Parking climate** tab.
3. Tap the timer setting you would like to change.
> A pop-up window will appear.
4. To edit a timer setting, follow the procedures described under the heading "Adding a timer setting" above.

Related information

- Preconditioning (p. 222)
- Preconditioning timer (p. 223)
- Activating and deactivating preconditioning timer (p. 225)
- Deleting preconditioning timer settings (p. 225)

Activating and deactivating preconditioning timer

Timer settings in the preconditioning timer can be activated or deactivated as needed.



Timer buttons in the **Parking climate** tab in Climate view.

1. Open Climate view in the center display.
2. Select the **Parking climate** tab.
3. Activate/deactivate a timer setting by tapping the timer button to the right of the setting.
 - > The timer is activated/deactivated and the button lights up/goes out.

Related information

- Preconditioning (p. 222)
- Preconditioning timer (p. 223)

- Adding and editing timer settings for preconditioning (p. 224)
- Deleting preconditioning timer settings (p. 225)

Deleting preconditioning timer settings

A preconditioning timer setting that is no longer needed can be deleted.

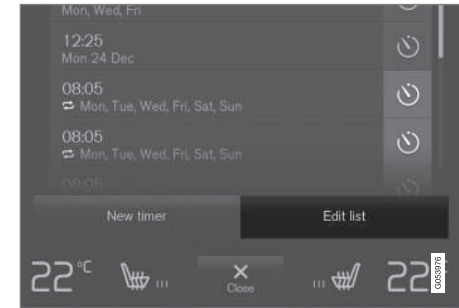

The button for editing a list/deleting a timer setting in the **Parking climate** tab in Climate view.

1. Open Climate view in the center display.
2. Select the **Parking climate** tab.
3. Tap **Edit list**.
4. Tap the editing icon to the right in the list.
 - > The icon will change to the text **Delete**.
5. Tap **Delete** to confirm.
 - > The timer setting will be deleted from the list.

◀ Related information

- Preconditioning (p. 222)
- Preconditioning timer (p. 223)
- Adding and editing timer settings for preconditioning (p. 224)
- Activating and deactivating preconditioning timer (p. 225)

Pre-cleaning*

Pre-cleaning of the vehicle before driving is used to improve the air quality in the passenger compartment.

It is only possible to activate pre-cleaning manually from the center display, but the function is also started automatically when preconditioning has finished.

The function uses the ventilation system to blow fresh air into the passenger compartment and then circulates the air through the climate system's passenger compartment air filter.

Related information

- Parking climate (p. 221)
- Starting and stopping pre-cleaning* (p. 226)
- Preconditioning (p. 222)

Starting and stopping pre-cleaning*

Pre-cleaning improves the air quality in the passenger compartment before driving. The function can be started in the center display or from a cellular phone.

Starting and stopping from the vehicle



1. Tap the symbol in the center of the climate bar to open Climate view in the center display.
2. Select the **Parking climate** tab.
3. Tap **Start Pre-cleaning**.
 - > Pre-cleaning starts/stops and the button lights up/goes out.

Starting from app*

A device with the Volvo On Call* app can be used to start pre-cleaning or check settings.

i NOTE

Pre-cleaning always starts automatically when preconditioning is complete.

Related information

- Parking climate (p. 221)
- Pre-cleaning* (p. 226)
- Preconditioning (p. 222)

Climate comfort retaining function

The climate in the passenger compartment can be maintained when the vehicle is parked, e.g. if the engine is turned off but the driver or passengers remain in the vehicle.

This function can only be direct-started from the center display.

The function utilizes several of the vehicle's systems:

- Residual heat from the engine is used to help heat the passenger compartment to a comfortable temperature.
- In warm weather, the ventilation system cools the passenger compartment by blowing air in from outside.

**NOTE**

Climate comfort maintenance will be deactivated if the vehicle is locked from the outside in order to avoid using residual engine heat unnecessarily. This function is intended to be used to maintain climate comfort when the driver or a passenger remains in the vehicle after the engine is turned off.

The climate comfort retaining function is limited in duration in cold weather depending on the amount of residual warmth available.

Related information

- Parking climate (p. 221)
- Starting and switching off the climate retaining function when parking (p. 228)

Starting and switching off the climate retaining function when parking

The climate retaining function maintains the climate settings in the vehicle after the engine has been switched off. The function can be activated in the center display.



1. Tap the symbol in the center of the climate bar to open Climate view in the center display.
2. Select the **Parking climate** tab.
3. Tap **Keep climate comfort**.
 - > The climate comfort retaining function will be activated/deactivated and the button light will go on/off.

NOTE

Maintained climate comfort is not possible when there is not sufficient residual engine heat to maintain the climate settings in the passenger compartment, or if the outside temperature is above approximately 20 °C (68 °F).

NOTE

Climate comfort maintenance will be deactivated if the vehicle is locked from the outside in order to avoid using residual engine heat unnecessarily. This function is intended to be used to maintain climate comfort when the driver or a passenger remains in the vehicle after the engine is turned off.

The climate comfort retaining function is limited in duration in cold weather depending on the amount of residual warmth available.





Related information

- Climate comfort retaining function (p. 227)

Parking climate symbols and messages

A number of symbols and messages related to parking climate may be displayed in the instrument panel.

Messages related to parking climate can also be displayed in a device that has the Volvo On Call* app.

Symbol	Message	Meaning
	Parking climate Service required	Parking climate is not functioning properly. Contact a workshop ^A to have the system checked as soon as possible.
	Parking climate Temporarily unavailable	Parking climate is temporarily not functioning properly. If the problem persists, contact a workshop ^A to have the system checked.
	Parking climate Unavailable Charge level too low	The parking climate cannot be activated because the hybrid battery's charge level is too low to start the parking heater. Start the vehicle.
	Parking climate Unavailable, not connected to power supply	The parking climate cannot be activated if the charging cable is not connected. Connect the charging cable.
	Parking climate Limited Charge level too low	Parking climate will only run for a limited time when the hybrid battery's charge level is too low. Start the vehicle.

^A An authorized Volvo workshop is recommended.

Related information

- Parking climate (p. 221)

Heater

The heater has two sub-functions that help warm the passenger compartment or engine in various situations.

The heater has two sub-functions:

- Parking heater - heats the passenger compartment as needed when the parking climate's preconditioning is activated.
- Auxiliary heater - heats the passenger compartment and engine while driving.

The heater is a high-voltage coolant heater and is mounted in the front right-side wheel housing.

Battery and charging

The heater is powered by the vehicle's hybrid battery. If the charge level in the hybrid battery is too low, the heater will switch off automatically and a message will be displayed in the instrument panel.

NOTE

Make sure that the battery has sufficient charge if the heater must be used. For the heater to be used for preconditioning, the vehicle must be plugged into an electrical outlet.

Related information

- Climate (p. 198)
- Parking heater (p. 230)
- Additional heater (p. 231)

Parking heater

The parking heater heats the passenger compartment as needed before driving if preconditioning is activated.

The parking heater is one of two sub-functions of the vehicle's heater. The heater is mounted in the front right-side wheel housing.

The parking heater starts automatically if the parking climate's preconditioning is activated and the passenger compartment needs to be heated.

Heater running time varies depending on factors such as battery charge level, passenger compartment temperature and ambient temperature, but it will never run for longer than 30 minutes.

NOTE

Make sure that the hybrid battery has sufficient charge if the parking heater must be used. For the heater to be used for preconditioning, the vehicle must be plugged into an electrical outlet.

Related information

- Heater (p. 230)
- Additional heater (p. 231)

Additional heater

The auxiliary heater helps heat the passenger compartment and engine while driving.

The auxiliary heater is one of two sub-functions of the vehicle's heater. The heater is mounted in the front right-side wheel housing.

The auxiliary heater is started and controlled automatically when extra heat is required while the vehicle is being driven.

It switches off automatically when the ignition is switched off.

Related information

- Heater (p. 230)
- Parking heater (p. 230)
- Activating and deactivating the auxiliary heater (p. 231)

Activating and deactivating the auxiliary heater

The auxiliary heater helps heat the passenger compartment and engine while driving.

It is possible to set whether automatic start for the auxiliary heater should be activated or deactivated.

1. Tap **Settings** in the Top view in the center display.
2. Tap **Climate**.
3. Select **Additional Heater** to activate/deactivate automatic start for the auxiliary heater.

NOTE

If automatic start of the auxiliary heater is deactivated, this may impair comfort in the passenger compartment since the climate system then does not have a heat source during electrical operation.

Related information

- Additional heater (p. 231)

KEY, LOCKS AND ALARM

Locking and unlocking

The vehicle can be locked and unlocked in several different ways.

The vehicle can be locked and unlocked

- using the buttons on the remote key
- with the detachable key blade (if the battery in the remote key is discharged)
- keyless* (Passive Entry), the remote key must be within range
- from inside the vehicle using the lock controls in the doors
- remote door unlocking with Volvo On Call.

There are also several types of remote keys that can be used.

For vehicles equipped with keyless locking and unlocking*, a smaller, lighter and buttonless key is provided (Key Tag).

A Care Key* (restricted key) makes it possible to set restrictions for some of the vehicle's functions e.g. maximum speed and maximum audio system volume.

Related information

- Locking and unlocking using the remote key (p. 239)
- Keyless locking and unlocking* (p. 253)
- Locking and unlocking from inside the vehicle (p. 256)
- Private Locking (p. 262)

- Alarm (p. 264)

Lock indication

The turn signals will flash when the vehicle is locked or unlocked.

Exterior confirmation

Locking

- The turn signals will flash once and the door mirrors will fold in¹ to confirm the vehicle is locked.

Unlocking

- The turn signals will flash twice and the door mirrors will fold out¹ to confirm the vehicle is unlocked.

The tailgate, hood and all doors must be closed for confirmation to be given. If only the driver's door is closed when the vehicle is locked², the vehicle will be locked but the turn signals will only flash to indicate locking when all doors and the tailgate and hood have been closed.

Lock and alarm indicators on the dashboard

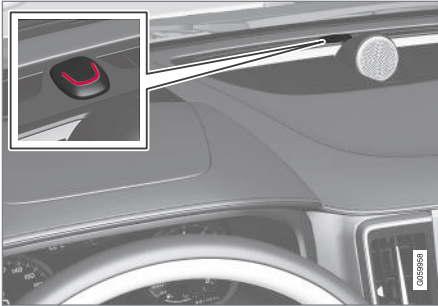

The locks and alarm indicator will display the status of the locking system:

- One long flash indicates locking.
- When the vehicle is locked, this will be indicated by short, pulsating flashes.
- Rapid flashing after disabling the alarm indicates that the alarm has been triggered.

Lock button indicators

Front door



Lock buttons with indicator lights in front door.

Illuminated indicator lights in both front door lock buttons indicate that all doors are locked. If any door is opened, the lights in both doors will go out.

Rear door*



Lock button with indicator light in rear door.

Illuminated indicator lights in each door indicate that that particular door is locked. If any door is unlocked and opened, the indicator light in that door will go out. The lights in the other doors will remain illuminated.

Other indicators

The approach lighting and home safe lighting functions may be activated when locking and unlocking.

Related information

- Lock confirmation settings (p. 236)
- Locking and unlocking (p. 234)
- Welcome Light (p. 160)
- Using home safe lighting (p. 160)

¹ Only vehicles with power folding mirrors.

² Does not apply to vehicles equipped with keyless locking/unlocking*.

Lock confirmation settings

Settings for how the vehicle confirms locking and unlocking can be adjusted in the center display's Settings menu.

To change the locking response settings:

1. Tap **Settings** in the center display's Top view.
2. Tap **My Car** → **Locking**.
3. Tap **Visible Locking Feedback** to select when the vehicle should provide a visible response:
 - **Lock**
 - **Unlock**
 - **Both**

Or turn off the function by marking **Off**.

4. Select to receive an audible response when locking the vehicle by marking **Audible Locking Feedback**.

To change the settings for folding door mirrors* when locking:

1. Tap **Settings** in the center display's Top view.
2. Tap **My Car** → **Mirrors and Convenience**.
3. Select **Fold Mirror When Locked** to activate or deactivate the function.

Related information

- Lock indication (p. 234)

Remote key

The remote key is used to lock and unlock doors and the tailgate. The remote key must be in the vehicle in order to start the engine.



Remote key³, Care Key and button-less key (Key Tag)*.

The remote key is not physically used to start the ignition because the vehicle is standard-equipped with keyless start (Passive Start). The key only needs to be in the front section of the passenger compartment.

For vehicles equipped with keyless locking and unlocking (Passive Entry)*, the engine can be started with the key anywhere in the vehicle. A smaller, lighter and button-less key (Key Tag) is also provided.

³ The illustration is generic - details may vary according to vehicle model.

The remote keys can be linked to different driver profiles to store personal settings in the vehicle.

WARNING

The remote key contains a button cell battery. Keep new and used batteries out of the reach of children. If batteries are swallowed, they can cause serious injury.

If any damage is detected, e.g. if the battery cover cannot be closed properly, do not use the product. Keep defective products out of the reach of children.

Remote key buttons



The remote key has four buttons, one on the left side and three on the right.

 **Locking** - Press once to lock the doors, tailgate and fuel filler door and arm the alarm.

Press and hold to close all windows.

 **Unlocking** - Press once to unlock the doors and tailgate and disarm the alarm.

Press and hold to open all windows at the same time. This total airing function can be used to e.g. quickly air out the vehicle in hot weather.

 **Tailgate** - Unlock and disarm the tailgate only. On vehicles equipped with the power tailgate*, press and hold to automatically open the tailgate. Press and hold to close

an open tailgate (an audible warning signal will be given).

 **Panic alarm** - Used to attract attention in emergency situations. Press and hold the button for at least 3 seconds or press twice within 3 seconds to activate the turn signals and horn. To deactivate, wait at least 5 seconds and press the button again. If no action is taken, the panic alarm will deactivate automatically after 3 minutes.

WARNING

If anyone is left in the vehicle, make sure that power to the power windows and panoramic roof* is cut off by always taking the remote key with you when you leave the vehicle.



NOTE

Be aware of the risk of locking the remote key in the vehicle.

- If the remote key or key tag is left in the vehicle, it will be deactivated when the vehicle is locked and the alarm set using another valid key. The key will be reactivated when the vehicle is unlocked.
- If the remote key or Care Key is left in the vehicle, it will be deactivated even if the vehicle is locked using Volvo On Call, and will be reactivated when the vehicle is unlocked using Volvo On Call or another valid key.

Button-less key (Key Tag)*

The button-less key⁴ provided with the keyless locking and unlocking function works in the same way as the regular remote key for keyless start, locking and unlocking. The key is waterproof up to a depth of approx. 10 meters (30 feet) for up to 60 minutes. It does not have a detachable key blade and its battery cannot be replaced.

Care Key - restricted remote key

A Care Key enables the vehicle owner to set a maximum speed limit for the vehicle. This limit

⁴ Also called sport key.

is intended to promote safe use of the vehicle, e.g. when it is loaned out.

Interference

Electromagnetic fields or obstructing objects may interfere with the remote key's functions for keyless start and keyless locking and unlocking*.

NOTE

Avoid storing the remote key near metal objects or electronic devices, e.g. cell phones, tablets, laptops or chargers – preferably no closer than 10-15 cm (4-6 in.).

If you experience interference, use the remote key's detachable blade to unlock the vehicle and then place the remote key in the backup reader in the tunnel console cup holder to disarm the alarm and start the vehicle.

NOTE

When the remote control key is placed in the cup holder, make sure that no other vehicle keys, metal objects or electronic devices (e.g. cell phones, tablets, laptops or chargers) are found in the cup holder. Multiple vehicle keys close to each other in the cup holder can disrupt their functionality.

WARNING

California Proposition 65

Operating, servicing and maintaining a passenger vehicle can expose you to chemicals including engine exhaust, carbon monoxide, phthalates, and lead, which are known to the State of California to cause cancer and birth defects or other reproductive harm. To minimize exposure, avoid breathing exhaust, do not idle the engine except as necessary, service your vehicle in a well ventilated area and wear gloves or wash your hands frequently when servicing your vehicle. For more information go to www.P65Warnings.ca.gov/passenger-vehicle.

Related information

- Starting the vehicle (p. 412)
- Locking and unlocking using the remote key (p. 239)
- Remote key range (p. 241)
- Replacing the remote key's battery (p. 242)
- Detachable key blade (p. 247)
- Care Key – restricted remote key (p. 246)
- Electronic immobilizer (p. 250)
- Linking a remote key to a driver profile (p. 136)

Locking and unlocking using the remote key

All doors and tailgate can be locked and unlocked simultaneously using the buttons on the remote key.

Locking with remote key



The illustration is generic - details may vary according to vehicle model.

- Press the  button on the remote key to lock the vehicle.

To activate the locking sequence, the driver's door must be closed⁵. If any of the other doors or the tailgate are open, they will be locked and the alarm will be armed once they are closed.

NOTE

Be aware of the risk of locking the remote key in the vehicle.

- If the remote key or key tag is left in the vehicle, it will be deactivated when the vehicle is locked and the alarm set using another valid key. The key will be reactivated when the vehicle is unlocked.
- If the remote key or Care Key is left in the vehicle, it will be deactivated even if the vehicle is locked using Volvo On Call, and will be reactivated when the vehicle is unlocked using Volvo On Call or another valid key.

Locking when the tailgate is open

NOTE

If the vehicle is locked and the tailgate is still open, make sure that the remote key is not left in the cargo compartment when the tailgate is closed and the entire vehicle is locked⁶.

⁵ If the vehicle is equipped with keyless locking/unlocking*, all side doors must be closed.

⁶ If the vehicle is equipped with keyless locking/unlocking and the key is detected inside the vehicle, the tailgate will not lock when it is closed.*

◀◀ **Unlocking with remote key**

- Press the  button on the remote key to unlock the vehicle.

Automatic relocking

If none of the doors or tailgate are opened within two minutes after being unlocked, they will automatically relock. This function reduces the risk of inadvertently leaving the vehicle unlocked.

Remote key not working

NOTE

Move closer to the vehicle and try to unlock it again.

If the remote key is not working to lock or unlock the vehicle, its battery may be discharged. Use the detachable key blade to lock/unlock the driver's door instead.

Related information

- Settings for remote and inside door unlock (p. 240)
- Unlocking the tailgate using the remote key (p. 241)
- Remote key (p. 236)
- Replacing the remote key's battery (p. 242)

- Locking and unlocking with detachable key blade (p. 248)

Settings for remote and inside door unlock

Several different sequences are available for remote unlocking.

To change this setting:

1. Tap **Settings** in the center display's Top view.
2. Tap **My Car** → **Locking** → **Remote and Interior Unlock**.
3. Select alternative:
 - **All Doors** – unlocks all doors at the same time.
 - **Single Door** – unlocks the driver's door. Press the remote key unlock button twice to unlock all doors.

The settings made here also affect central locking using the inside door handle.

Related information

- Locking and unlocking using the remote key (p. 239)
- Locking and unlocking from inside the vehicle (p. 256)

Unlocking the tailgate using the remote key

The remote key can be used to unlock the tailgate while keeping the rest of the vehicle locked.

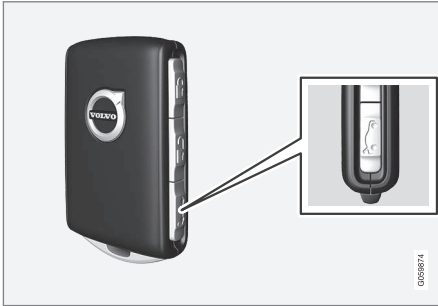

1. Press the  button on the remote key.
 - > The tailgate will be unlocked but remain closed.

The side doors remain locked and armed. The lock and alarm indicator on the dashboard will go out to indicate that the vehicle is no longer fully locked.

Press lightly on the rubberized pressure plate under the tailgate handle to open the tailgate. If the tailgate is not opened within 2 minutes, it will be relocked and the alarm armed.

2. With the optional power tailgate* -
 - Hold and press (about 1.5 seconds) the  button on the remote key
 - > The tailgate will unlock and open. However, the side doors will remain locked and armed.



Related information

- Locking and unlocking using the remote key (p. 239)

Remote key range

In order to function correctly, the remote key must be within a certain distance from the vehicle.

Manual use

The remote key's functions for e.g. locking and unlocking, which are activated by pressing  or , have a range of approx. 20 meters (65 feet) from the vehicle.

If the vehicle's locks do not react, move closer and try again.

Keyless* use

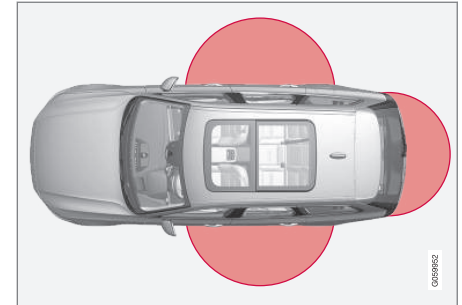

The shaded areas around the vehicle illustrate the range of the system's antennas.

For keyless use, a remote key or the Key Tag must be within the shaded areas shown in the illustration, i.e. a semicircle with a radius of



- ◀ approx. 1.5 meter (5 feet) along the sides of the vehicle or approx. 1 meter (3 feet) from the tailgate.

i NOTE

The functions of the remote control key can be disrupted by ambient radio waves, buildings, topographical conditions, etc. The vehicle can always be locked/unlocked using the key blade.

If the remote key is removed from the vehicle



If the remote key is removed from the vehicle while the engine is running, the warning message **Vehicle key not found Removed from vehicle** will be displayed in the instrument panel and an audible signal will sound when the last door is closed.

The message will disappear when the key is returned to the vehicle and the **O** button on the right-side steering wheel keypad is pressed or when the last door is closed again.

Related information

- Remote key (p. 236)
- Antenna locations for the start and lock system (p. 255)
- Keyless and touch-sensitive surfaces* (p. 252)

Replacing the remote key's battery

The battery in the remote key must be replaced when it is discharged.

i NOTE

All batteries have a limited service life and must eventually be replaced (does not apply for Key Tag). The battery's service life varies depending on how often the vehicle/key is used.



The remote key battery should be replaced if

- the information symbol illuminates and the message **Vehicle key bat. low** is displayed in the instrument panel
- the locks do not react after several attempts to lock or unlock the vehicle using the remote key within approx. 20 meter (65 feet) from the vehicle.

i NOTE

Move closer to the vehicle and try to unlock it again.

The battery in the smaller key without buttons⁷ (the Key Tag) cannot be replaced. A new

key can be ordered from an authorized Volvo workshop.

! CAUTION

An end-of-life Key Tag must be turned in to an authorized Volvo workshop. The key must be deleted from the vehicle because it can still be used to start the vehicle via backup start.

Opening the key and replacing the battery

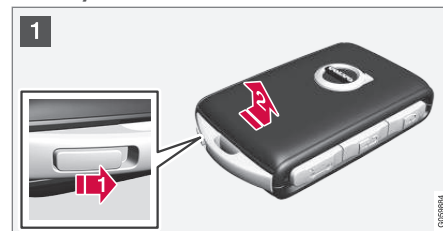

- 1** Hold the remote key with the front side (with the Volvo logo) facing up and move the button on the key ring section to the right. Slide the front cover slightly upward.
- 2** The cover will loosen and can be removed from the key.



2 **1** Turn the key over, move the button to the side and slide the rear cover slightly upward.

2 The cover will loosen and can be removed from the key.

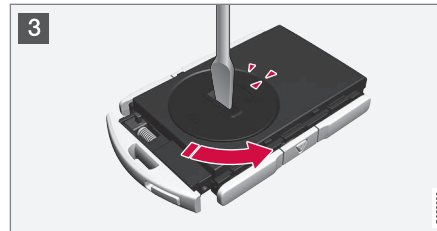

3 Use a screwdriver or similar object to turn the battery cover counterclockwise so the markers point to **OPEN**.

Remove the cover carefully by pressing e.g. a fingernail into the indentation.

Pry the cover up.

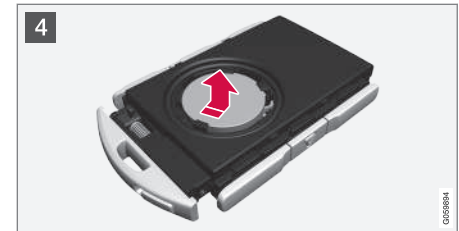

4 The battery's positive side (+) faces upward. Carefully pry out the battery as shown in the illustration.

! **CAUTION**

Avoid touching new batteries and their contact surfaces with your fingers as this will impair their function.

⁷ Included in vehicles equipped with keyless locking/unlocking*.

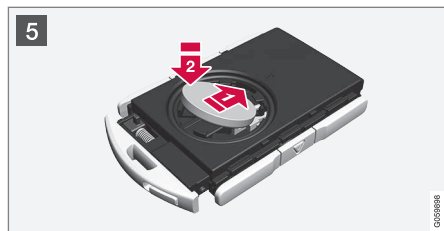

5 Insert a new battery with the positive side (+) facing upward. Do not touch the contact surfaces of the remote key battery.

1 Place the edge of the battery downward into the holder. Slide the battery forward until it locks into place under the two plastic catches.

2 Press the battery downward until it locks into place under the upper black plastic catch.

i NOTE
Use batteries with the designation CR2032, 3 V.

i NOTE
Volvo recommends that batteries used in the remote control key satisfy UN Manual of Test and Criteria, Part III, sub-section 38.3. The factory installed batteries and batteries replaced by an authorized Volvo workshop satisfy the above criterion.

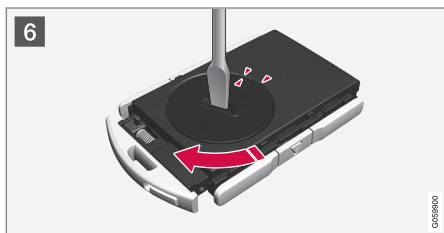

6 Replace the battery cover and turn it clockwise until it points to **CLOSE**.



7 **1** Put the rear cover back into position and press it down until it clicks into place.

2 Slide the cover back.

> A second click indicates that the cover is correctly positioned and locked into place.



- 8 **1** Turn the remote key over and press the front cover down until it clicks into place.
- 2** Slide the cover back.
- > An additional click indicates that the cover is correctly in place.

⚠ WARNING

Make sure the battery is positioned correctly with the right polarity. If the remote key will not be used for a prolonged period of time, remove the battery to avoid battery leakage and damage. Wear protective gloves when handling damaged batteries, as batteries that are damaged or leaking can cause corrosive damage in contact with the skin.

- Keep batteries out of the reach of children.
- Do not leave batteries lying out where they could be swallowed by children or pets.
- Never disassemble, short-circuit or place a battery into open fire.
- Do not charge non-rechargeable batteries, as this could cause an explosion.

Check the remote key for damage before using it. If any damage is detected, e.g. if the battery cover cannot be closed properly, do not use the product. Keep defective products out of the reach of children.

⚠ CAUTION

Be sure to dispose of end-of-life batteries in a way that protects the environment.

⚠ WARNING

California Proposition 65

Operating, servicing and maintaining a passenger vehicle can expose you to chemicals including engine exhaust, carbon monoxide, phthalates, and lead, which are known to the State of California to cause cancer and birth defects or other reproductive harm. To minimize exposure, avoid breathing exhaust, do not idle the engine except as necessary, service your vehicle in a well ventilated area and wear gloves or wash your hands frequently when servicing your vehicle. For more information go to www.P65Warnings.ca.gov/passenger-vehicle.

Related information

- Locking and unlocking with detachable key blade (p. 248)
- Starting the vehicle (p. 412)
- Remote key (p. 236)

Ordering additional remote keys

Two remote keys are provided with the vehicle. One Key Tag is also included if the vehicle is equipped with keyless locking/unlocking*. Additional keys can be ordered.

A total of 12 keys can be programmed and used for the same vehicle. An additional driver profile will be added for each new remote key. This also applies to the key tag.

Loss of a remote key

If you lose your remote key, you can order a replacement from a workshop - an authorized Volvo workshop is recommended. Bring the other remaining remote keys to the workshop. As an anti-theft measure, the code of the lost remote key must be erased from the system.

The current number of keys registered for the vehicle can be checked via driver profiles in the center display's Top view. Select **Settings** → **System** → **Driver Profiles**.

i NOTE

Volvo recommends that you order a new or duplicate remote key from an authorized Volvo workshop.

You can also obtain additional or duplicate remote keys from certain independent repair facilities and locksmiths that are qualified to make remote keys. Each key must be programmed to work with your vehicle.

A list of independent repair facilities and/or locksmiths known to Volvo that can cut and code replacement keys can be found:

- at volvocars.com
- by calling Volvo Customer Care 1-800-458-1552.

Related information

- Remote key (p. 236)

Care Key – restricted remote key

A Care Key enables the vehicle owner to set a maximum speed limit for the vehicle. This limit is intended to promote safe use of the vehicle, e.g. when it is loaned out.



A maximum vehicle speed can be defined for a Care Key. Otherwise, the Red Key functions in the same way as a standard remote key.

This restriction is intended to help reduce the risk of accidents and help the driver feel more secure when handing over the vehicle to e.g. a young driver, parking attendant or workshop.

Ordering a Care Key

One or more Care Key can be ordered from a Volvo retailer. A total of twelve keys can be programmed and used for the same vehicle. Up to ten may be restricted keys, but at least two must be standard remote keys.

Care Key limitations

The key is linked to a specific Care Key driver profile, and when it is active the key's settings cannot be changed. It is also not possible to switch to another driver profile, as this requires a regular remote key.

The driver profile is activated when the vehicle is unlocked using a Care Key without a regular remote key nearby.

NOTE

If the vehicle changes owners, the vehicle must be locked and then unlocked for a new driver profile to be activated.

Setting options

The following limitations are available:

- speed range: 50-180 km/h (30-112 mph)
- Increments: 1 km/h (1 mph)

Symbol	Meaning
	Speed limitation is active.

Related information

- Care Key settings (p. 247)
- Remote key (p. 236)

Care Key settings

Change maximum speed for a Care Key via the center display.

1. Unlock the vehicle using a regular remote key.
2. Tap **Settings** in the center display's Top view.
3. Tap **System** → **Driver Profiles** → **Care Key**.
4. Adjust desired settings.

Related information

- Care Key – restricted remote key (p. 246)

Detachable key blade

The remote key contains a detachable metal key blade that can be used to activate a number of functions and preform certain actions. A Volvo workshop can provide you with the key blade's unique code, which is recommended in case you need to order a new key blade.

Using the detachable key blade

The detachable key blade can be used to

- manually open the left-side front door if central locking cannot be activated with the remote key
- emergency lock all doors
- activate/deactivate the rear door mechanical child locks.

The button-less key⁸ does not have a detachable key blade. If needed, use the standard remote key's detachable key blade.

⁸ Included in vehicles equipped with keyless locking/unlocking*.

◀ Detaching the key blade



- 1 **1** Hold the remote key with the front side (with the Volvo logo) facing up and move the button on the key ring section to the right. Slide the front cover slightly upward.
 - 2** The cover will loosen and can be removed from the key.



- 2 **1** Remove the key blade by pulling it up.



- 3
 - 1** Put the key blade back into its designated spot in the remote key after use.
 - 1** Replace the cover by pressing it down until it clicks into place.
 - 2** Slide the cover back.
 - > An additional click indicates that the cover is correctly in place.

Related information

- Locking and unlocking with detachable key blade (p. 248)
- Remote key (p. 236)

Locking and unlocking with detachable key blade

The detachable key blade can be used to unlock the vehicle from the outside, e.g. if the battery in the remote key is discharged.

Unlocking

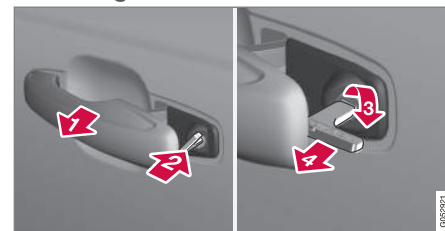

- 1** Pull the front left-hand door handle to its end position to access the lock cylinder.
- 2** Put the key in the lock cylinder.
- 3** Turn the key clockwise 45 degrees so that the key blade is pointing straight rearward.
- 4** Turn the key blade back 45 degrees to its original position. Remove the key from the lock cylinder and release the handle so that it returns to its original position against the vehicle.
5. Pull the door handle.
 - > The door will open.

i NOTE

When the door is unlocked using the detachable key blade and then opened, the alarm will be triggered. The alarm must be deactivated manually; see separate section.

Locking

The left-hand front door can be locked by inserting the detachable key into the door's lock cylinder.

The other doors have lock mechanisms in the side of the door that must be pushed in using the key blade. The door will then be locked mechanically and cannot be opened from the outside.

The doors can still be opened from inside.

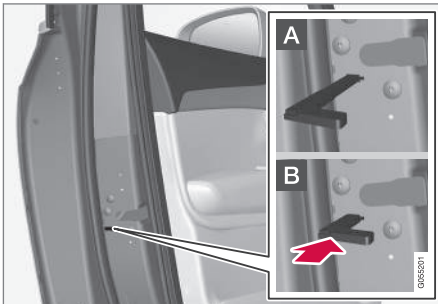

Manual door lock. This is not the child lock.

1. Remove the detachable key blade from the remote key.
2. Insert the key blade into the opening for the lock mechanism.
3. Push in the key until it stops, about 12 mm (0.5 inch).

A The door can be opened from both the outside and the inside.

B The door cannot be opened from the outside. To return to position A, open the door using the inside door handle.

i NOTE

- The door's lock controls only lock that specific door, not all doors simultaneously.
- A manually locked rear door with activated child lock cannot be opened from either the outside or the inside. The door can only be unlocked using the buttons on the key, the central locking button, the keyless locking system* or Volvo On Call.

Related information

- Detachable key blade (p. 247)
- Arming and disarming the alarm (p. 265)
- Starting the vehicle (p. 412)

- Replacing the remote key's battery (p. 242)
- Remote key (p. 236)

Electronic immobilizer

The electronic immobilizer is a start inhibitor that helps prevent the vehicle from being started by an unauthorized person.

The vehicle can only be started with the right remote key.

The following instrument panel error messages are related to the electronic immobilizer:

Symbol	Message	Meaning
	Vehicle key not found See Owner's manual	Remote key not recognized during start. Place the remote key on the key symbol in the cup holder and try to start the vehicle again.

Remote immobilizer with tracking system⁹

The vehicle is equipped with a system that makes it possible to track and locate the vehicle and to remotely activate the immobilizer to prevent the vehicle from being started. Contact your nearest Volvo retailer for more information and assistance activating the system.

⁹ Only certain markets and in combination with Volvo On Call.

The following instrument panel error messages are related to the remote immobilizer with tracking system:

Symbol	Message	Meaning
	Remotely immobilised Vehicle not possible to start	The remote immobilizer with tracking system is activated. The vehicle cannot be started. Contact Volvo On Call Service Center.

Related information

- Remote key (p. 236)
- Ordering additional remote keys (p. 246)

Start and lock system type designations

The following information contains type designations for the start and lock system.

Alarm system

USA FCC ID: MAYDA 5823(3)

This device complies with part 15 of the FCC rules. Operation is subject to the following conditions: (1) This device may not cause harmful interference, and (2) this device must accept any interference received, including interference that may cause undesired operation.

Canada IC: 4405A-DA 5823(3)

This device is subject to the following conditions: (1) This device may not cause interference, and (2) this device must accept any interference, including interference that may cause undesired operation of the device.

Remote keys (Passive Entry*/Passive Start)

USA

Volvo Standard Key FCC ID: YGO-HUF8423MS

Volvo Tag ID FCC ID: YGOHUF8432MS

* Option/accessory.

This device complies with part 15 of the FCC Rules. Operation is subject to the following two conditions:

(1) This device may not cause harmful interference, and (2) this device must accept any interference received, including interference that may cause undesired operation.

CAUTION: Changes or modifications not expressly approved by the party responsible for compliance could void the user's authority to operate the equipment.

Canada

Volvo Standard Key IC: 4008C-HUF8423MS

Volvo Tag ID IC: 4008C-HUF8432MS

This device complies with part 15 of the FCC Rules and Industry Canada license-exempt RSS standard(s). Operation is subject to the following two conditions:

(1) This device may not cause harmful interference, and (2) this device must accept any interference received, including interference that may cause undesired operation.

Le présent appareil est conforme aux CNR d'Industrie Canada applicables aux appareils radio exempts de licence. L'exploitation est autorisée aux deux conditions suivantes :

(1) l'appareil ne doit pas produire de brouillage, et (2) l'utilisateur de l'appareil doit accepter tout brouillage radioélectrique subi, même si le brouillage est susceptible d'en compromettre le fonctionnement.

Immobilizer and Passive Entry* / Passive Start systems

USA-FCC ID: LTQVO3134

This device complies with part 15 of the FCC rules. Operation is subject to the following two conditions:

(1) This device may not cause harmful interference, and

(2) this device must accept any interference received, including interference that may cause undesired operation.

Any changes or modification not expressly approved by the party responsible for compliance could void the user's authority to operate this equipment.

Canada-IC:3659A-VO3134

This device complies with Industry Canada license-exempt RSS standards. Operation is subject to the following two conditions:

(1) This device may not cause harmful interference, and (2) this device must accept any interference received, including interference that may cause undesired operation.

Related information

- Remote key (p. 236)

Keyless and touch-sensitive surfaces*

With the keyless locking and unlocking function, the remote key only needs to be within range, e.g. in a pocket or bag. The vehicle can then be locked or unlocked by touching the pressure-sensitive surface on the door handle.

Pressure-sensitive surfaces

Door handle

There are indentations on the outside of the outer door handles for locking, and pressure-sensitive surfaces on the inside of the handles for unlocking.

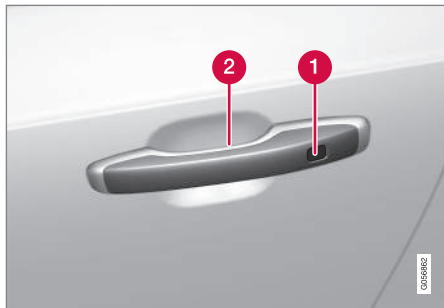

- 1 Pressure-sensitive indentation for locking
- 2 Pressure-sensitive surface for unlocking

i NOTE

It is important that only one pressure-sensitive surface is activated at a time. If the handle is grasped at the same time as the lock area is pressed, there is a risk that double commands may be sent. This may cause the requested action (locking/unlocking) to be delayed or not performed at all.

Tailgate handle

The tailgate handle has a rubberized pressure plate that can only be used for unlocking.

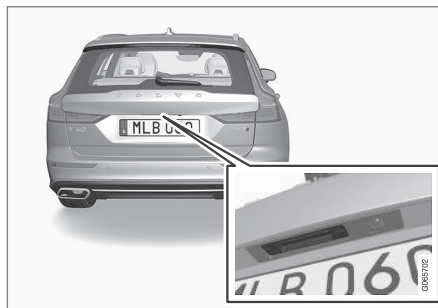

i NOTE

Please be aware that the system could be activated in a car wash if the remote key is within range.

Related information

- Keyless locking and unlocking* (p. 253)
- Keyless tailgate unlock* (p. 254)

Keyless locking and unlocking*

With keyless locking and unlocking, touching the pressure-sensitive indentation on the door handle will lock or unlock the vehicle.

i NOTE

One of the vehicle's remote keys must be within range for locking and unlocking to be possible.

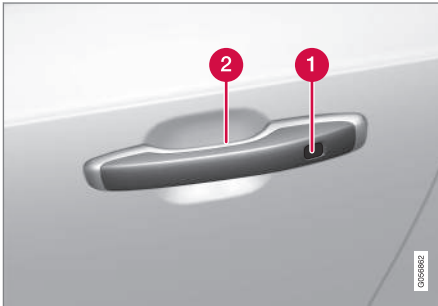

1 Pressure-sensitive indentation for locking

2 Pressure-sensitive surface for unlocking

i NOTE

Please be aware that the system could be activated in a car wash if the remote key is within range.

Keyless locking

All of the doors have to be closed before the vehicle can be locked. However, the tailgate can be open when a door handle is used for locking.

- Touch the marked area on the outside of one of the door handles after the door is closed. Or press the  button on the lower edge of the tailgate before it is closed.
 - > The lock indicator light on the dashboard will flash to confirm that the vehicle is locked.

To close all door windows at the same time - place your finger on the pressure-sensitive indentation on the outside of the door handle and hold it there until the side windows have closed.

Locking when the tailgate is open

If the vehicle is locked and the tailgate is still open, make sure that the remote key is not left in the cargo compartment when the tailgate is closed.

i NOTE

If the key is detected in the vehicle, the tailgate will not lock when it is closed.

Keyless unlocking

- To unlock, grasp a door handle or lightly press the rubberized button on the underside of the tailgate handle.
 - > The lock indicator light on the dashboard will stop flashing to confirm that the vehicle is unlocked.

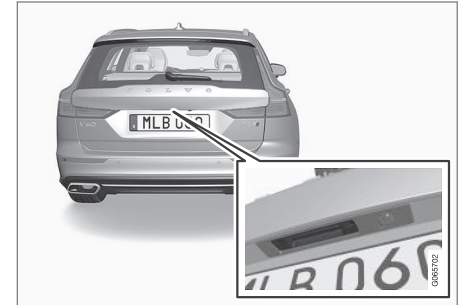

The rubberized button on the tailgate can only be used for unlocking.

Automatic relocking

If none of the doors or tailgate are opened within two minutes after being unlocked, they will automatically relock. This function reduces the risk of inadvertently leaving the vehicle unlocked.

◀ Related information

- Keyless unlock settings* (p. 254)
- Keyless tailgate unlock* (p. 254)
- Keyless and touch-sensitive surfaces* (p. 252)

Keyless unlock settings*

Several different sequences are available for keyless unlocking.

To change this setting:

1. Tap **Settings** in the center display's Top view.
2. Tap **My Car** → **Locking** → **Keyless Unlock**.
3. Select alternative:
 - **All Doors** – unlocks all doors at the same time.
 - **Single Door** – unlocks the selected door.

Related information

- Keyless locking and unlocking* (p. 253)
- Keyless and touch-sensitive surfaces* (p. 252)

Keyless tailgate unlock*

With keyless locking and unlocking, the tailgate can be unlocked by lightly touching the rubberized button on the tailgate handle.

i NOTE

One of the vehicle's remote keys must be within range behind the vehicle for unlocking to be possible.

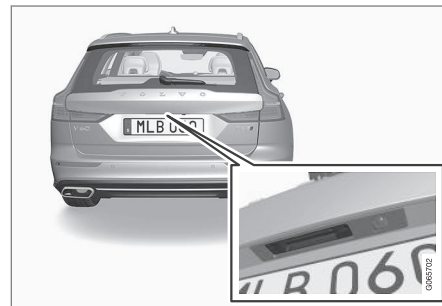

The tailgate is held closed by an electronic locking mechanism.

To open:

1. Lightly press the rubberized pressure plate on the underside of the tailgate handle.
 - > The lock will disengage.

- Lift the outer handle to open the tailgate.

⚠ CAUTION

- Only light pressure on the rubberized pressure plate is necessary to release the tailgate's locking mechanism.
- Use the handle to lift the tailgate and do not apply force to the rubberized pressure plate. Too much force can damage the pressure plate's electrical connections.

Hands-free unlocking of the tailgate is also possible using a foot movement under the rear bumper; see the separate section.

⚠ WARNING

Do not drive with the tailgate open. Toxic exhaust fumes can be sucked into the vehicle through the cargo compartment.

Related information

- Keyless locking and unlocking* (p. 253)
- Keyless and touch-sensitive surfaces* (p. 252)
- Remote key range (p. 241)
- Operating the tailgate with a foot movement* (p. 261)

¹⁰ Only in vehicles equipped with keyless locking and unlocking*.

Antenna locations for the start and lock system

The antennas for the keyless start system and keyless locking system* are integrated in the vehicle.

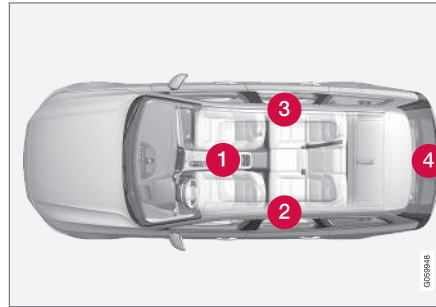

Location of the antennas:

- Under the cup holder in the front section of the tunnel console
- In the upper front section of the left-side rear door¹⁰
- In the upper front section of the right-side rear door¹⁰
- In the cargo compartment¹⁰

⚠ WARNING

Individuals with an implanted pacemaker should not allow the pacemaker to come closer than 22 cm (9 in.) to the Keyless system antennas. The aim of this is to prevent disturbances between the pacemaker and the Keyless system.

Related information

- Keyless and touch-sensitive surfaces* (p. 252)
- Remote key range (p. 241)

Locking and unlocking from inside the vehicle

The doors and tailgate can be locked and unlocked from inside the vehicle using the central lock buttons in the front doors.

Central locking



Button with indicator light for locking and unlocking in front door.

Unlocking using the front door buttons

- Press the  button to unlock all side doors and the tailgate.

Alternative unlocking method



Alternative unlocking method using side door opening handle¹¹.

- Pull either of the side door inside opening handles and release.
 - > Depending on the remote key settings, either all doors will be unlocked or just the selected door will be unlocked and opened.

To change this setting, tap **Settings** → **My Car** → **Locking** → **Remote and Interior Unlock** in the Top view of the center display.

Locking using the front door buttons

- Press the  button (both front doors must be closed).
 - > All doors and the tailgate will lock.

Locking using the rear door button*



Button with indicator light for locking/unlocking in rear door.

The lock buttons in the rear doors lock/unlock that particular door.

Unlocking the rear door

1. Pull the opening handle to unlock the rear door.
2. Pull the opening handle again to open the rear door¹².

¹¹ The illustration is generic - details may vary according to vehicle model.

¹² If the child lock is not activated.

Related information

- Settings for remote and inside door unlock (p. 240)
- Unlocking the tailgate from inside the vehicle (p. 257)
- Activating and deactivating child locks (p. 257)

Unlocking the tailgate from inside the vehicle

The tailgate can be unlocked from the inside using the button on the dashboard.

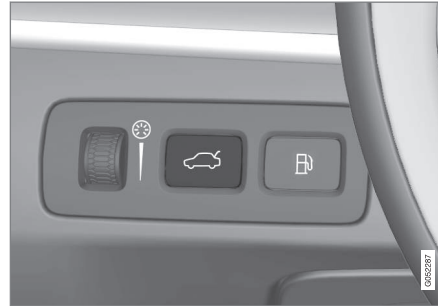

- Press the  button on the dashboard.
 - > The tailgate will unlock and can be opened from the outside by pressing the rubberized button on the handle.

With the optional power tailgate*:

- Press and hold the  button on the dashboard.
 - > The tailgate will open.

Related information

- Locking and unlocking from inside the vehicle (p. 256)

Activating and deactivating child locks

The child locks help prevent the rear doors from being able to be opened from the inside. The child lock can be either manual or electric*.

Manual child lock

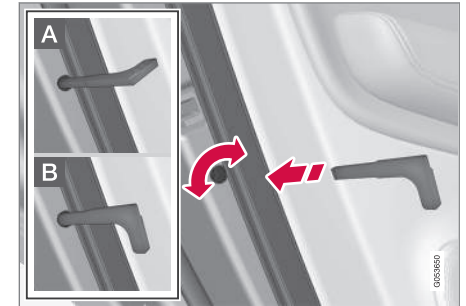

Manual child lock. This is not the manual door lock.

- Use the detachable key blade in the remote key to turn the control.
- A** The door cannot be opened from the inside.
- B** The door can be opened from both the outside and the inside.





NOTE

- The door's knob control only locks that specific door, not both rear doors simultaneously.
- There are no manual child locks on models equipped with electronic child locks.

Electric child lock*

The electric child lock can be activated and deactivated in any ignition mode higher than **O**. The lock can be activated and deactivated up to 2 minutes after the ignition is turned off if no door has been opened.



Button for activation and deactivation.

- Light on – lock is activated.
- Light off – lock is deactivated.

When the child lock is activated, the rear:

- windows can only be opened using the buttons in the driver's door.
- the rear doors cannot be opened from the inside.

If the child lock is activated when the vehicle is switched off, it will remain activated the next time the vehicle is started.

Symbols and messages

Symbol	Message	Meaning
	Rear child lock Activated	The child lock is activated.
	Rear child lock Deactivated	The child lock is deactivated.

Related information

- Locking and unlocking from inside the vehicle (p. 256)
- Detachable key blade (p. 247)

Automatic locking when driving

The doors and tailgate will automatically lock when the vehicle begins to move.

Related information

- Locking and unlocking from inside the vehicle (p. 256)

Closing and locking the tailgate using the buttons*

The buttons on the underside of the tailgate can be used to close and lock the vehicle automatically.

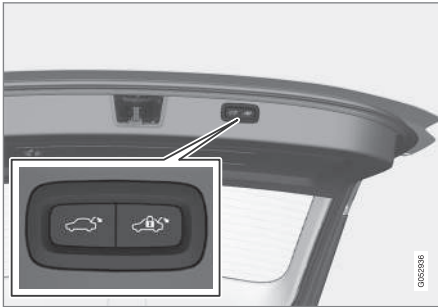

Location of button(s) on underside of tailgate.

! CAUTION

When operating the tailgate manually, open and close it slowly. If you encounter resistance, do not use force. This could lead to damage and loss of function.

Closing¹³

- Press the  button on the underside of the tailgate.
 - > The tailgate will close automatically and remain unlocked.

i NOTE

- The button remains active 24 hours after the tailgate was opened. After this time, the tailgate must be closed manually.
- If the tailgate has been open for more than 30 minutes, it will automatically close slowly.

Locking¹⁴

1. Press the  button on the underside of the tailgate.
2. Close the trunk lid manually.
 - > The tailgate and doors will lock¹⁵.

Closing and locking¹⁶

- Press the  button on the underside of the tailgate.
 - > The tailgate closes automatically and the vehicle locks¹⁵.

i NOTE

- One of the vehicle's remote keys must be within range for locking and unlocking to be possible.
- When the keyless locking or closing* functions are used, three audible signals will sound if the key is not detected close enough to the tailgate.

¹³ Vehicles with power-operated trunk lid.

¹⁴ Vehicles equipped with keyless locking/unlocking.

¹⁵ All doors must be closed for the vehicle to lock.

¹⁶ Vehicles with keyless locking/unlocking and power-operated tailgate.

Interrupting closing

- Press the button on the dashboard.
- Press the button on the remote key.
- Press the close button on the underside of the tailgate¹³.
- Press the rubberized pressure plate on the underside of the tailgate's outer handle.
- Using a foot movement*.

Tailgate movement is interrupted and stops. The tailgate can then be opened or closed manually.

If the tailgate stops near the closed position, it will open the next time it is activated.

Pinch protection

If anything obstructs the tailgate with enough force to prevent it from opening or closing, pinch protection will be activated.

- When opening - the tailgate will stop moving and an audible signal will sound.
- When closing - the tailgate will stop, a long audible signal will sound and the tailgate will return to the programmed maximum opening position.

⚠ WARNING

Be aware of the risk of injury when opening and closing.

Before opening or closing, make sure that no one is near the tailgate's range of motion. Serious injury could occur.

Always operate the tailgate with caution.

Preloaded springs

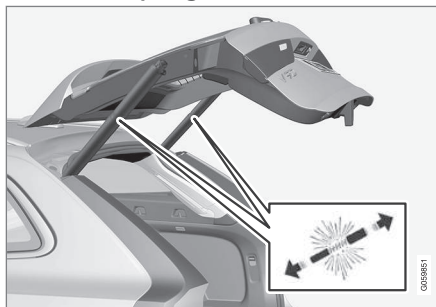

Preloaded springs for the power tailgate.

⚠ WARNING

Do not attempt to open or access the preloaded springs in the power tailgate struts. They are preloaded with high pressure and can cause injury if opened.

Related information

- Setting maximum opening height for the power tailgate* (p. 261)
- Operating the tailgate with a foot movement* (p. 261)
- Remote key range (p. 241)

¹³ Vehicles with power-operated trunk lid.

Setting maximum opening height for the power tailgate*

The tailgate can be set to stop opening at a certain height, for example if the tailgate needs to be opened in a garage with a low ceiling.

Setting maximum opening height

1. Open the tailgate manually to the desired opening height.
2. Press the  button on the lower edge of the tailgate and hold it for about 3 seconds.
 - > Two audio signals will sound to indicate that the position has been stored.

NOTE

It is not possible to program an opening position lower than half-open tailgate.

Resetting maximum opening position

1. Open the tailgate manually to the fully open position.
2. Press the  button on the lower edge of the tailgate and hold it for about 3 seconds.
 - > Two audio signals will sound to indicate that the stored position has been erased.

NOTE

- If the system has been working continuously for a prolonged period of time, it will be switched off to avoid overload. It can be used again after approximately 2 minutes.

Operating the tailgate with a foot movement*

To make it easier to operate the tailgate when your hands are full, it can be opened and closed by moving your foot in a forward kicking motion under the rear bumper.

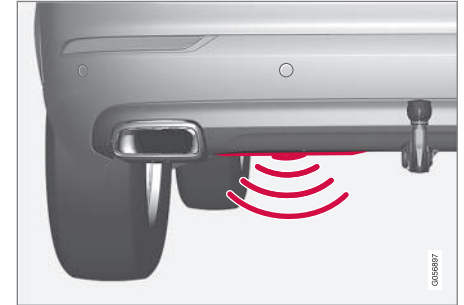

The sensor is located to the left of center under the rear bumper.

One of the vehicle's remote keys must be within range behind the vehicle, approx. 1 meter (3 feet), for opening and closing to be possible. This applies even if the vehicle is unlocked in order to prevent the trunk lid from inadvertently opening e.g. at a car wash.



◀◀ **Foot movement operation**



Kicking motion within the sensor's activation area.

- Make **one** forward kicking motion with your foot under the left section of the rear bumper. Take a step back. Do not touch the bumper.
 - > A brief audible signal will be heard when opening or closing is activated - the tailgate will open/close.

If several opening attempts have been made without the remote key in range behind the vehicle, foot movement operation will not be available for a short period of time.

Do not keep your foot under the vehicle in a kicking motion. This may prevent activation.

Interrupting opening or closing with a foot movement

- Make **one** forward kicking motion while the tailgate is opening or closing to stop its movement.

The remote key does not need to be within range of the vehicle to interrupt opening or closing of the tailgate.

If the tailgate stops near the closed position, it will open the next time it is activated.

i NOTE

There is a risk of reduced or lost function if there are large amounts of snow, ice, dirt, etc. on the rear bumper. Make sure to keep the bumper clean.

i NOTE

Please note that the system could be inadvertently activated in a car wash or similar if the remote key is within range.

Related information

- Keyless and touch-sensitive surfaces* (p. 252)
- Remote key range (p. 241)

Private Locking

The tailgate can be locked using the private locking function to prevent it from being opened, e.g. when the vehicle is left at a workshop or with a valet.



The function button for private locking is located in the center display's Function view. Depending on the current status of the lock, **Private Locking Unlocked** or **Private Locking Locked**

will be displayed.

Related information

- Activating and deactivating private locking (p. 263)

Activating and deactivating private locking

Private locking is activated using the function button in the center display and a PIN code.

NOTE

For the valet lock function to be activated the car must be in at least ignition mode I.

Two codes are used for private locking:

- A security code, which is created the first time the function is used.
- A PIN code, which is changed each time the function is activated.

Entering security code before initial use

The first time the function is used, a security code must be selected. This code can then be used to deactivate private locking if the selected PIN code has been forgotten or lost. The security code functions as a PUK (security) code for all PIN codes used for private locking.

Save the security code in a safe place.

To create a security code:

1. Tap the button for private locking in Function view.



- > A pop-up window will appear.
2. Enter the desired security code and press **Confirm**.
 - > The security code is saved. The private locking function is now ready for activation.

Activating private locking

1. Tap the button for private locking in Function view.



- > A pop-up window will appear.
2. Enter the code you would like to use to unlock the tailgate and tap **Confirm**.
 - > The tailgate will lock. A green indicator light will illuminate next to the button in Function view to confirm locked status.

Deactivating private locking

1. Tap the button for private locking in Function view.



- > A pop-up window will appear.
2. Enter the code used for locking and tap **Confirm**.
 - > The tailgate will unlock. The green indicator light next to the button in Function view will go out to confirm unlocked status.

Forgotten PIN code

If you have forgotten your PIN code or entered it incorrectly more than three times, the security code can be used to deactivate private locking.

If the vehicle is unlocked using Volvo On Call or the Volvo On Call app, private locking will be automatically deactivated.

Forgotten security code

If you have forgotten your security code, contact an authorized Volvo retailer for assistance deactivating private locking.



◀◀ **Related information**

- Private Locking (p. 262)

Alarm

The alarm emits sound and light signals if anyone without a valid remote key attempts to break into the vehicle or interferes with the start battery or alarm siren.

Alarm indicator

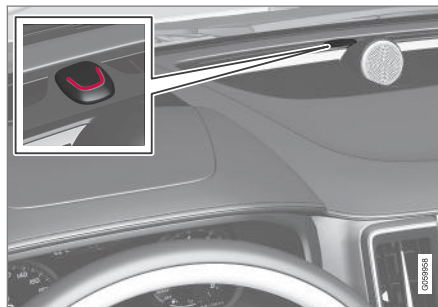

A red indicator light on the dashboard shows the status of the alarm:

- Indicator off - the alarm is disarmed.
- Indicator flashes once every two seconds - the alarm is armed.
- The indicator flashes quickly after the alarm has been disabled for up to 30 seconds or until the ignition is put in I mode – the alarm has been triggered.

When armed, the alarm will be triggered if:

- the hood, tailgate or any door is opened.
- a battery cable is disconnected.
- the alarm siren is disconnected.

Alarm signals

The following occurs if the alarm is triggered:

- A siren will sound for 30 seconds or until the alarm is turned off.
- The hazard warning flashers will flash for 5 minutes or until the alarm is turned off.

If the reason the alarm was triggered is not rectified, the alarm cycle will repeat up to 10 times¹⁷.

Symbols and messages

Symbol	Message	Meaning
	Alarm system failure Service required	Contact a workshop – an authorized Volvo workshop is recommended.

¹⁷ Certain markets only.

i NOTE

Do not attempt to repair or alter any of the components in the alarm system yourself. Any such attempt could affect the terms and conditions of your insurance policy.

Related information

- Arming and disarming the alarm (p. 265)

Arming and disarming the alarm

The alarm is armed when the vehicle is locked and disarmed when the vehicle is unlocked. The alarm can also be disarmed without a functioning key.

Arming and disarming the alarm

The alarm is armed when the vehicle is locked and disarmed when the vehicle is unlocked.

Disarming the alarm without a functioning remote key

The vehicle can be unlocked and disarmed even if the remote key is not functioning e.g. if the battery is discharged.

1. Open the driver's door using the detachable key blade.
 - > This will trigger the alarm.

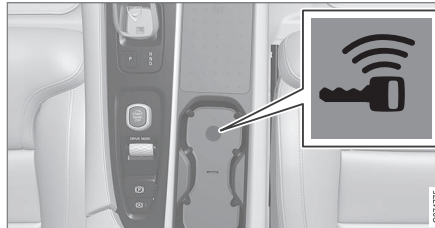

Location of the backup key reader in the cup holder.

2. Place the remote key on the key symbol in the backup reader in the tunnel console's cup holder.

3. Turn the start knob clockwise and release.
 - > The alarm will be disarmed.

Turning off a triggered alarm

- Press the unlock button on the remote key or put the ignition into mode **I** by turning the start knob clockwise and then releasing it.

Related information

- Alarm (p. 264)

DRIVER SUPPORT

Driver support systems

The vehicle is equipped with a number of driver support systems that can provide the driver with active or passive assistance in various situations.

The systems can, for example, help the driver:

- maintain a set speed
- maintain a set time interval to the vehicle ahead
- help prevent a collision by warning the driver and applying the brakes
- park the vehicle.

Some of the systems are standard and others are options. This also varies from market to market.

Related information

- IntelliSafe – driver support and safety (p. 29)
- Speed-dependent steering wheel resistance (p. 268)
- Electronic Stability Control (p. 269)
- Connected Safety (p. 274)
- City Safety™ (p. 321)
- Road Sign Information* (p. 276)
- Cruise control (p. 281)
- Adaptive Cruise Control* (p. 284)
- Pilot Assist* (p. 294)

- Curve Speed Assist (CSA)* (p. 306)
- Passing assistance* (p. 308)
- Lane Keeping Aid (p. 314)
- Steering assistance at risk of collision (p. 335)
- Rear Collision Warning* (p. 341)
- BLIS* (p. 342)
- Driver Alert Control (p. 346)
- Distance Alert* (p. 348)
- Cross Traffic Alert* (p. 350)
- Park Assist* (p. 354)
- Park Assist Camera* (p. 359)
- Radar sensor (p. 378)
- Camera (p. 381)

Speed-dependent steering wheel resistance

Speed-dependent power steering increases the steering wheel resistance in pace with the vehicle's speed, which can help give the driver an enhanced feeling of control and stability. Steering is stiffer on highways. When parking and at low speeds, it will be easier to move the steering wheel.

Reduced power

In rare situations, the power steering may need to work at reduced power and the steering wheel may then feel more difficult to move. This may happen when the power steering becomes too hot and needs to be temporarily cooled. It can also happen if there is a disturbance in power supply.



If there is reduced power, the message **Power steering Assistance temporarily reduced** and this symbol are shown in the instrument panel.

While the power steering is working at reduced power, the driver support functions and systems with steering assistance are not available.

⚠ WARNING

If the temperature rises too high, the power steering may be forced to switch off completely. In such a situation, the driver display shows the message **Power steering failure Stop safely** along with a symbol.

Changing the level of steering wheel resistance*

In INDIVIDUAL drive mode, the level of steering wheel resistance can be adjusted.

1. Tap **Settings** in the center display's Top view.
2. Select **My Car → Drive Modes → Steering Force**.

Steering wheel resistance settings can only be accessed if the vehicle is stationary or is moving straight ahead at a low speed.

Related information

- Driver support systems (p. 268)
- Drive modes (p. 434)

Electronic Stability Control

The Electronic Stability Control (ESC¹) function helps the driver avoid skidding and improves the vehicle's directional stability.



This symbol will be displayed in the instrument panel when the system is intervening.

When the system has intervened to apply the brakes, a pulsing sound may be heard and the vehicle may accelerate more slowly than expected when the accelerator pedal is depressed.

The system consists of the following sub-functions:

- Stability control²
- Spin control and active yaw control
- Engine drag control
- Trailer Stability Assist

⚠ WARNING

- The function is supplementary driver support intended to facilitate driving and help make it safer – it cannot handle all situations in all traffic, weather and road conditions.
- The driver is advised to read all sections in the Owner's Manual about this function to learn of its limitations, which the driver must be aware of before using the function.
- Driver support functions are not a substitute for the driver's attention and judgment. The driver is always responsible for ensuring the vehicle is driven in a safe manner, at the appropriate speed, with an appropriate distance to other vehicles, and in accordance with current traffic rules and regulations.

Stability control²

This function helps control the driving and braking force of each individual wheel in an attempt to stabilize the vehicle.

Spin control and active yaw control

This function is active at low speeds and brakes the wheels that are spinning to transfer

¹ Electronic Stability Control

² Also called traction control.

- ◀ additional power to wheels that are not spinning.

This function can also help prevent the wheels from spinning while the vehicle is accelerating.

Engine drag control

Engine drag control (EDC³) can help prevent inadvertent wheel lock, e.g. after downshifting or using engine braking when driving at low speeds on a slippery surface.

Inadvertent wheel lock while driving could impair the driver's ability to steer the vehicle.

Trailer Stability Assist*⁴

Trailer Stability Assist (TSA⁵) is designed to help stabilize a vehicle that is towing a trailer if the vehicle and trailer have begun to sway.

NOTE

Trailer Stability Assist is deactivated if **ESC Sport Mode** is activated.

Related information

- Driver support systems (p. 268)
- Activating or deactivating Sport mode for Electronic Stability Control (p. 271)

³ Engine Drag Control

⁴ Trailer Stability Assist is included if the vehicle is equipped with a Volvo original towbar.

⁵ Trailer Stability Assist

⁶ Electronic Stability Control

⁷ Trailer Stability Assist

- Electronic Stability Control symbols and messages (p. 272)
- Trailer Stability Assist* (p. 459)

Electronic Stability Control in sport mode

The stability system (ESC⁶) is always activated and cannot be switched off. However, the driver can select **ESC Sport Mode**, which offers more active driving characteristics.

With the **ESC Sport Mode** sub-function selected, intervention from the system is reduced and more lateral movement is permitted, giving the driver more control of the vehicle than usual.

When **ESC Sport Mode** is selected, the function may seem to be disabled even though it continues to assist the driver.

NOTE

When **ESC Sport Mode** is selected, the trailer stabilizer (TSA⁷) is switched off.

ESC Sport Mode also helps provide more traction, even if the vehicle gets stuck or is driving on a loose surface such as deep snow or loose sand.

Related information

- Electronic Stability Control (p. 269)
- Activating or deactivating Sport mode for Electronic Stability Control (p. 271)
- Trailer Stability Assist* (p. 459)

Activating or deactivating Sport mode for Electronic Stability Control

The stability system (ESC⁸) is always activated and cannot be switched off. However, the driver can select Sport mode, which offers more active driving characteristics.



Activate or deactivate the function using this button in the center display's Function view.

- Illuminated button indicator light – the function is activated.
- Extinguished button indicator light – the function is deactivated.



When **ESC Sport Mode** is activated, this symbol will illuminate with a steady glow in the instrument panel. It will remain on until the driver deactivates the function or until the engine is turned off.

The system will return to normal mode the next time the engine is started.

The **ESC Sport Mode** function cannot be selected when any of the following functions are activated:

- Cruise control
- Adaptive Cruise Control*
- Pilot Assist*

Related information



- Electronic Stability Control in sport mode (p. 270)
- Electronic Stability Control (p. 269)

⁸ Electronic Stability Control



Electronic Stability Control symbols and messages

A number of symbols and messages related to Electronic Stability Control (ESC⁹) may be

displayed in the instrument panel. Several examples are provided below.

Symbol	Message	Meaning
	Steady glow for approx. 2 seconds	System check when the engine is started.
	Flashing light	The system is actively operating.
	Steady glow	Sport mode is activated. NOTE! The system is not deactivated in this mode, but has partially reduced functionality.

⁹ Electronic Stability Control

Symbol	Message	Meaning
	ESC Temporarily off	The system's functionality has been temporarily reduced due to high brake system temperatures. The function will be automatically reactivated when the brakes have cooled.
	ESC Service required	The system is not functioning properly. Stop the vehicle in a safe place, turn off the engine and then restart it.

A text message can be erased by briefly pressing the  button in the center of the right-side steering wheel keypad.

If the message persists: Contact a workshop – an authorized Volvo workshop is recommended.

Related information

- Electronic Stability Control (p. 269)

Connected Safety¹⁰

Connected Safety communicates information between your vehicle and other vehicles via the Internet¹¹. The function is designed to notify the driver of any hazardous road conditions ahead.

The function can notify the driver if another vehicle further down the road has activated its hazard warning flashers or detected slippery road conditions. You will also be notified if your own vehicle detects slippery road conditions.

Connected Safety can assist the driver with the following:

- Hazard warning flashers alert
- Slippery road alerts

Connected Safety communication between vehicles only works for vehicles that are equipped with the function and have it activated.

Hazard warning flashers alert

If your vehicle's hazard warning flashers are activated, information on this can be sent to other vehicles approaching your location.



When your vehicle approaches a vehicle with its hazard warning flashers on, this symbol will appear in the instrument panel.

In vehicles equipped with a head-up display, the warning symbols for Connected Safety will also be displayed there.

Slippery road alerts

If your own car detects reduced friction between your tires and the road, information on this can be sent to vehicles approaching your own car's position.



As the vehicle approaches the area affected, this symbol will be displayed in the instrument panel to alert the driver of slippery road conditions. Drivers of other vehicles receiving information via

Connected Safety will receive similar notifications as they approach the area.

In vehicles equipped with a head-up display, the warning symbols for Connected Safety will also be displayed there.

⚠ WARNING

- The function is supplementary driver support intended to facilitate driving and help make it safer – it cannot handle all situations in all traffic, weather and road conditions.
- The driver is advised to read all sections in the Owner's Manual about this function to learn of its limitations, which the driver must be aware of before using the function.
- Driver support functions are not a substitute for the driver's attention and judgment. The driver is always responsible for ensuring the vehicle is driven in a safe manner, at the appropriate speed, with an appropriate distance to other vehicles, and in accordance with current traffic rules and regulations.

Related information

- Driver support systems (p. 268)
- Activating or deactivating Connected Safety (p. 275)
- Connected Safety limitations (p. 275)
- Internet-connected vehicle* (p. 516)

¹⁰ Not available in all markets.

¹¹ There may be a charge for transmitting data over the Internet, depending on your service plan.

Activating or deactivating Connected Safety

For Connected Safety to be able to share information about road conditions with other drivers, the function must be activated. If you do not wish to share information, the function can be deactivated.



Activate or deactivate the function using this button in the center display's Function view.

- Illuminated button indicator light – the function is activated.
- Extinguished button indicator light – the function is deactivated.

At activation, the driver must accept the special terms and conditions shown in the display before an Internet connection¹² can be established. The driver must, for example, accept that data is sent from the vehicle using the driver's cellular phone.

Even when your vehicle is not connected to the Internet, you will still be notified if the system in your own vehicle detects slippery road conditions. For Connected Safety to function at full capacity, your vehicle needs to be connected to the Internet.

Related information

- Connected Safety (p. 274)
- Internet-connected vehicle* (p. 516)
- Terms of use and data sharing (p. 522)
- Connected Safety limitations (p. 275)

Connected Safety limitations

Information on vehicles with activated hazard warning flashers or which have detected slippery road conditions is not always communicated between all vehicles in the affected area.

This may be the case if:

- No or insufficient Internet connection.
- The maneuvers (steering wheel movements, acceleration or braking) made by the vehicles on slippery surfaces are too weak for friction between the tires and road to be detected.
- Vehicles that have detected slippery road conditions or activated hazard warning flashers have not activated the function.
- Vehicles that have detected slippery road conditions or activated hazard warning flashers are not equipped with the function.
- Insufficient GPS/satellite navigation may prevent warnings.
- Slippery road conditions were detected or hazard warning flashers were activated on a road that is not registered in the Volvo Cars database.
- Connected Safety is not developed on all markets and does not cover all areas. Con-

¹² There may be a charge for transmitting data over the Internet, depending on your service plan.



◀◀ sult a Volvo retailer for more information on covered areas.

⚠ WARNING

- In certain situations, the function may give false warnings of slippery road conditions.
- The function cannot always detect other vehicles with activated hazard warning factors or detect all stretches of road with slippery conditions.

Related information

- Connected Safety (p. 274)
- Internet-connected vehicle* (p. 516)

Road Sign Information*

The Road Sign Information (RSI)¹³ function can help the driver observe speed-related road signs.

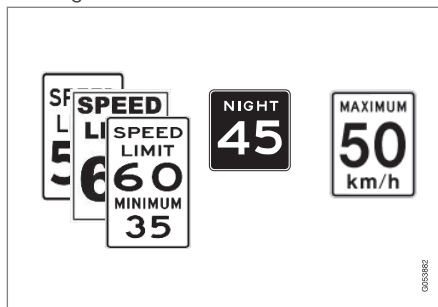

Examples of signs that can be detected¹⁴.

If the vehicle passes a speed limit sign, it will be displayed in the instrument panel and the head-up display*.

There are also subfunctions for Road Sign Information (RSI)¹⁵ that can alert the driver if the speed limit has been exceeded or if there are speed cameras nearby.

i NOTE
In certain markets, the Road Sign Information* function is only available in combination with Sensus Navigation*.

⚠ WARNING

- The function is supplementary driver support intended to facilitate driving and help make it safer – it cannot handle all situations in all traffic, weather and road conditions.
- The driver is advised to read all sections in the Owner's Manual about this function to learn of its limitations, which the driver must be aware of before using the function.
- Driver support functions are not a substitute for the driver's attention and judgment. The driver is always responsible for ensuring the vehicle is driven in a safe manner, at the appropriate speed, with an appropriate distance to other vehicles, and in accordance with current traffic rules and regulations.

¹³ Road Sign Information

¹⁴ Road signs differ according to market – the illustrations shown here are just some examples.

¹⁵ Road Sign Information

Related information

- Driver support systems (p. 268)
- Activating or deactivating Road Sign Information* (p. 277)
- Road Sign Information* display (p. 277)
- Road Sign Information and Sensus Navigation* (p. 278)
- Speed limit and speed camera warnings from Road Sign Information* (p. 278)
- Road Sign Information* limitations (p. 280)

Activating or deactivating Road Sign Information*

The Road Sign Information (RSI¹⁶) function is optional – the driver can choose to have the function activated or deactivated.



Activate or deactivate the function using this button in the center display's Function view.

- Illuminated button indicator light – the function is activated.
- Extinguished button indicator light – the function is deactivated.

Related information

- Road Sign Information* (p. 276)
- Road Sign Information* limitations (p. 280)

Road Sign Information* display

Road Sign Information (RSI¹⁷) displays road signs in different ways depending on the sign and situation.

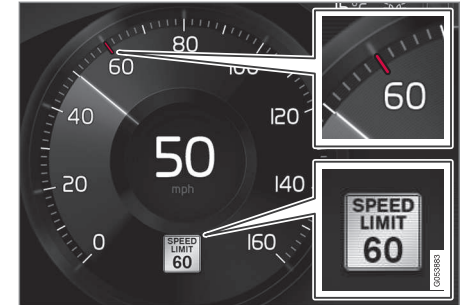

Example¹⁸ of registered speed information.

When the function has registered a speed limit sign, the sign will be displayed as a symbol in the instrument panel and a colored marking will be shown in the speedometer's speed scale.

If the vehicle is equipped with Sensus Navigation*, speed-related information will also be retrieved from map data, which means that the instrument panel can display or change information about speed limits even if the vehicle has not passed a speed-related sign.

¹⁶ Road Sign Information

¹⁷ Road Sign Information

¹⁸ Road signs differ according to market – the illustrations shown here are just examples.

Signs for "School" and "Children playing"



If the warning sign "School" or "Children playing" is included in the satellite navigator's map data¹⁹, a symbol of this type will be displayed in the instrument panel.

Related information

- Road Sign Information* (p. 276)
- Road Sign Information* limitations (p. 280)

Road Sign Information and Sensus Navigation*

If the vehicle is equipped with Sensus Navigation*, speed-related information will be provided in the following situations:

- In cases where the speed limit is given indirectly, e.g. signs for highways or other major roads.
- If a previously detected speed sign is deemed to be no longer valid and no new sign has been passed.

i NOTE

In certain markets, the Road Sign Information* function is only available in combination with Sensus Navigation*.

i NOTE

If a downloaded third-party app is used for navigation, there is no support for speed-related information.

Related information

- Road Sign Information* (p. 276)

Speed limit and speed camera warnings from Road Sign Information*

There are subfunctions for Road Sign Information (RSI²⁰) that can alert the driver if the speed limit has been exceeded or if there are speed cameras nearby.



Example of speed camera and speed limit information in the instrument panel

Speed limit warning



When Speed Warning is activated, the symbol for the current speed limit in the instrument panel²¹ will flash temporarily if that speed is exceeded.

¹⁹ Only vehicles with Sensus Navigation*.

²⁰ Road Sign Information

²¹ Road signs differ by market – the illustration shown here is just an example.

The driver can be alerted if the vehicle is exceeding a detected speed limit and is approaching a speed camera.

Speed Limit Warning warns the driver if the vehicle's speed has exceeded the applicable speed limit or the stored maximum speed. The warning will be repeated once after about 30 seconds in that speed limit area if the driver does not slow down.

An additional warning will not be provided unless the vehicle's speed is reduced by at least 5 km/h (3 mph) and then exceeds the speed limit again or the vehicle enters a new/different speed limit area.

i NOTE

For an audible alert to be provided if the speed is exceeded, the **Speed Limit Warning** function must be activated and the **Road Sign Audio Warning** sub-function must be **On**. Audible alerts are provided if the vehicle's speed exceeds the speed displayed by Road Sign Information in the instrument panel.

Speed camera warning



Vehicles equipped with Road Sign Information and Sensus Navigation can provide information on upcoming speed cameras in the instrument panel²².

If the vehicle exceeds a detected speed limit with the **Speed Limit Warning** function activated, the driver is given a speed warning when the vehicle is approaching a speed camera if the navigation map for the vehicle's current location contains information on speed cameras.

i NOTE

It is possible to receive an audible alert for speed cameras regardless of the vehicle's speed and whether or not the speed limit is exceeded, even if the **Road Sign Audio Warning** function is deactivated.

Related information

- Road Sign Information* (p. 276)
- Activating or deactivating warnings from Road Sign Information* (p. 279)
- Road Sign Information* limitations (p. 280)

Activating or deactivating warnings from Road Sign Information*

The Road Sign Information (RSI²³) sub-function **Speed Limit Warning** is optional – the driver can choose to have the subfunction activated or deactivated.

Activating Speed Warning

1. Select **Settings** → **My Car** → **IntelliSafe** → **Road Sign Information** in the center display's Top view.
2. Select **Speed Limit Warning**.
 - > The function is activated and a speed limit selector is displayed.

Adjusting the Speed Warning limit

The driver can adjust the settings to be alerted at a higher speed than the posted speed limit.

1. Select **Settings** → **My Car** → **IntelliSafe** → **Road Sign Information** in the center display's Top view.
2. Select **Speed Limit Warning**.
 - > The function is activated and a speed limit selector is displayed.

²² Information on speed cameras on the navigation map is not available for all markets/areas.

²³ Road Sign Information

- ◀ 3. Tap the up/down arrows on the screen to adjust the speed at which the Speed Warning will be given.



Please note that the set warning limit will not be used when a speed camera symbol is displayed in the instrument panel.

Activating audible alert for Speed Warning

1. Select **Settings** → **My Car** → **IntelliSafe** → **Road Sign Information** in the center display's Top view.
2. Select/deselect **Road Sign Audio Warning** to activate/deactivate the audible alert.

When **Road Sign Audio Warning** is activated, the driver will also be alerted if the vehicle is approaching a one-way/"no-entry" road or entrance.

Activating speed camera alerts

If the vehicle is equipped with Sensus Navigation* and map data contains information on speed cameras, the driver can choose to receive an audible alert if the vehicle is approaching a speed camera.

1. Select **Settings** → **My Car** → **IntelliSafe** → **Road Sign Information** in the center display's Top view.
2. Select/deselect **Speed Camera Audio Warning** to activate/deactivate the speed camera audible alert.

Related information

- Road Sign Information* (p. 276)
- Speed limit and speed camera warnings from Road Sign Information* (p. 278)
- Road Sign Information* limitations (p. 280)

Road Sign Information* limitations

Road Sign Information (RSI²⁴) functionality may be reduced in certain situations.

The function could have reduced functionality due to e.g.:

- faded road signs
- signs located in a curve in the road
- twisted or damaged signs
- signs positioned high above the road
- fully/partially obstructed or poorly positioned signs
- signs partially or fully covered by frost, snow and/or dirt
- digital road maps²⁵ that are outdated, incorrect or do not contain speed information²⁶

i NOTE

In certain markets, the Road Sign Information* function is only available in combination with Sensus Navigation*.

²⁴ Road Sign Information

i NOTE

Certain types of bike carriers that are connected to the trailer socket may be interpreted as a connected trailer by the RSI function. In such cases, the instrument panel may indicate incorrect speed information.

i NOTE

The function uses the vehicle's camera and radar sensor, which has certain general limitations.

Related information

- Road Sign Information* (p. 276)
- Camera/radar sensor limitations (p. 381)

Cruise control

Cruise Control (CC²⁷) can help the driver maintain an even speed to provide a more relaxing driving experience on highways and long, straight roads with even traffic flows.

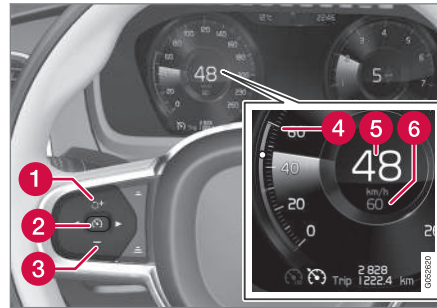

Function buttons and symbols

- 1** : Activates Cruise Control from standby mode and resumes the set speed
- 1** : Increases the set speed
- 2** : **From standby mode** – activates Cruise Control and sets the current speed
- 2** : **From active mode** – deactivates/puts Cruise Control in standby mode
- 3** : Reduces the set speed

- 4** Marker for set speed
- 5** The vehicle's current speed
- 6** Set speed

i NOTE

In vehicles equipped with Adaptive Cruise Control*(ACC²⁸), it is possible to switch between Cruise Control and Adaptive Cruise Control.

²⁵ Vehicles equipped with Sensus Navigation*.

²⁶ Map data and speed information is not available for all areas.

²⁷ Cruise Control

²⁸ Adaptive Cruise Control



⚠ WARNING

- The function is supplementary driver support intended to facilitate driving and help make it safer – it cannot handle all situations in all traffic, weather and road conditions.
- The driver is advised to read all sections in the Owner's Manual about this function to learn of its limitations, which the driver must be aware of before using the function.
- Driver support functions are not a substitute for the driver's attention and judgment. The driver is always responsible for ensuring the vehicle is driven in a safe manner, at the appropriate speed, with an appropriate distance to other vehicles, and in accordance with current traffic rules and regulations.

Using engine braking instead of applying the brakes

Cruise Control regulates speed by lightly applying the brakes. On downgrades, it can sometimes be desirable to roll a bit faster and let speed be reduced instead by engine braking alone. The driver can temporarily disengage the Cruise Control braking function.

To disengage CC:

- Press the accelerator pedal about halfway down and then release it.
 - > Cruise Control will automatically disengage the automatic brake function and speed will only be reduced using the engine braking function.

Related information

- Driver support systems (p. 268)
- Selecting and activating cruise control (p. 282)
- Deactivating cruise control (p. 283)
- Cruise control standby mode (p. 284)
- Adjusting set speed for driver support (p. 311)
- Switching between cruise control and Adaptive Cruise Control* in the center display (p. 291)

Selecting and activating cruise control

The Cruise Control (CC²⁹) function must be selected and activated in order to regulate speed.

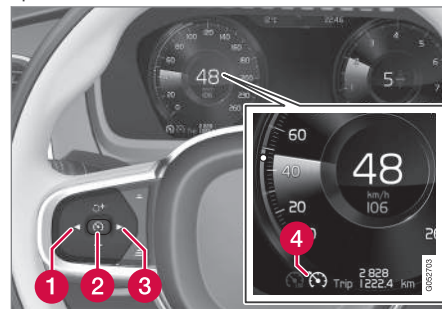

In order to start Cruise Control from standby mode, the vehicle's current speed must be 30 km/h (20 mph) or higher.

1. Press the ◀ (1) or ▶ (3) button on the steering wheel keypad and scroll to the cruise control symbol  (4).
 - > Gray symbol – cruise control is in standby mode.

²⁹ Cruise Control

2. When cruise control is selected, press  (2) on the steering wheel keypad to activate.
 - > White symbol – cruise control starts and the current speed is stored as the maximum speed. The lowest speed that can be set is 30 km/h (20 mph).

Reactivating cruise control to the last stored speed

- When cruise control is selected, press  on the steering wheel keypad to activate.
 - > The Cruise Control marking in the instrument panel will change from GRAY to WHITE and the vehicle will then return to the most recently set speed.

WARNING

A noticeable increase in speed may follow when the speed is resumed with the  steering wheel button.



Related information

- Cruise control (p. 281)
- Deactivating cruise control (p. 283)
- Cruise control standby mode (p. 284)

Deactivating cruise control

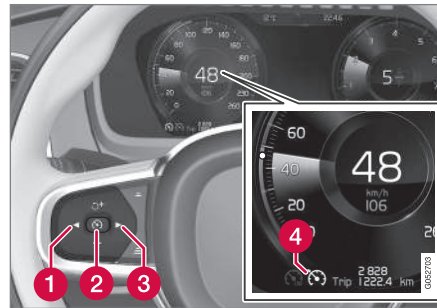
Cruise control (CC³⁰) can be deactivated and switched off.



1. Press the  button on the steering wheel (2).
 - > The symbol and markings turn gray – cruise control goes into standby mode.
2. Press the  (1) or  (3) buttons on the steering wheel to select another function.
 - > The cruise control symbol and marking (4) in the instrument panel will go out and the stored maximum speed will be erased.

Related information

- Cruise control (p. 281)
- Switching between cruise control and Adaptive Cruise Control* in the center display (p. 291)
- Selecting and activating cruise control (p. 282)
- Cruise control standby mode (p. 284)

Cruise control standby mode

Cruise control (CC³¹) can be deactivated and put in standby mode. This may happen automatically or be due to driver intervention. Standby mode means that the function is selected in the instrument panel but not activated. In standby mode, cruise control will not regulate speed.

Standby mode due to action by the driver

Cruise control will be deactivated and put in standby mode if any of the following occurs:

- The brakes are applied.
- The gear selector is moved to **N**.
- The vehicle is driven faster than the set speed for more than 1 minute.

The driver must then control the vehicle's speed.

Temporarily increasing speed using the accelerator pedal, e.g. when passing another vehicle, will not affect the setting. The vehicle will return to the set speed when the accelerator pedal is released.

Automatic standby mode

The function may automatically go into standby mode if one of the following occurs:

- The wheels lose traction.
- The engine speed (rpm) is too low/high.
- The temperature in the brake system becomes too high.
- The vehicle's speed goes below 30 km/h (20 mph).

The driver must then control the vehicle's speed.

Related information

- Cruise control (p. 281)
- Selecting and activating cruise control (p. 282)
- Deactivating cruise control (p. 283)

Adaptive Cruise Control*³²

Adaptive Cruise Control (ACC³³) can help the driver to maintain a constant speed, combined with a preset time interval to the vehicle in front.

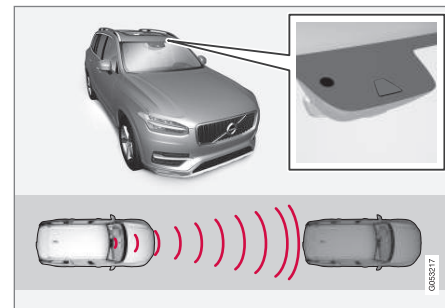

The camera/radar sensor measures the distance to the vehicle ahead.

Adaptive Cruise Control can help provide a more relaxed driving experience on long trips on highways or long, straight roads with even traffic flows.

The driver sets a speed and a time interval to the vehicle ahead. If the camera/radar sensor detects a slower-moving vehicle ahead, your vehicle's speed will be automatically adapted according to the set time interval to that vehicle.

³¹ Cruise Control

³² Depending on market, this function can be either standard or optional.

³³ Adaptive Cruise Control

cle. When there are no longer slower-moving vehicles ahead, the vehicle will return to the set speed.

If the Curve Speed Assist (CSA)* function is activated, it may also affect the vehicle's speed.

Adaptive Cruise Control is designed to:

- smoothly regulate speed. The driver must apply the brakes in situations requiring immediate braking. For example, when there are great differences in speed between vehicles or if the vehicle ahead brakes suddenly. Due to limitations in the radar sensor, braking may occur unexpectedly or not at all.
- follow a vehicle ahead in the same lane and maintain a time interval to that vehicle set by the driver. If the radar sensor does not detect a vehicle ahead, it will instead maintain the speed set by the driver. This will also happen if the speed of the vehicle ahead exceeds the set speed for your vehicle.

WARNING

- The function is supplementary driver support intended to facilitate driving and help make it safer – it cannot handle all situations in all traffic, weather and road conditions.
- The driver is advised to read all sections in the Owner's Manual about this function to learn of its limitations, which the driver must be aware of before using the function.
- Driver support functions are not a substitute for the driver's attention and judgment. The driver is always responsible for ensuring the vehicle is driven in a safe manner, at the appropriate speed, with an appropriate distance to other vehicles, and in accordance with current traffic rules and regulations.

CAUTION

Only a workshop may perform maintenance on driver support components – an authorized Volvo workshop is recommended.

Related information

- Driver support systems (p. 268)
- Adaptive Cruise Control* controls (p. 286)

- Adaptive Cruise Control* displays (p. 286)
- Selecting and activating Adaptive Cruise Control* (p. 287)
- Adaptive Cruise Control* limitations (p. 290)
- Symbols and messages for Adaptive Cruise Control* (p. 292)
- Collision risk warning from driver support (p. 309)
- Setting time interval to the vehicle ahead (p. 312)
- Adjusting set speed for driver support (p. 311)
- Auto-hold braking with driver support (p. 313)
- Switching target vehicles with driver support (p. 310)
- Passing assistance* (p. 308)
- Contacting Volvo (p. 26)

Adaptive Cruise Control*³⁴ controls

A summary of how Adaptive Cruise Control (ACC³⁵) is controlled using the left-side steering wheel keypad and how the function is shown in the display.

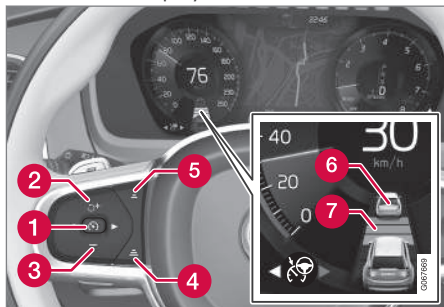

- 1 : From standby mode - activates and sets the current speed
- 1 : From active mode - deactivates/ puts in standby mode
- 2 : Activates the function from standby mode and resumes the set speed
- 2 **+** : Increases the set speed
- 3 **-** : Reduces the set speed

- 4 Increases the time interval to the vehicle ahead
- 5 Reduces the time interval to the vehicle ahead
- 6 Target vehicle indicator: the function has detected and is following a target vehicle using the set time interval
- 7 Symbol for time interval to the vehicle ahead

Related information

- Adaptive Cruise Control* (p. 284)
- Adaptive Cruise Control* limitations (p. 290)

Adaptive Cruise Control*³⁶ displays

The following illustrations show how Adaptive Cruise Control (ACC³⁷) can appear in the various displays in different situations.

Speed

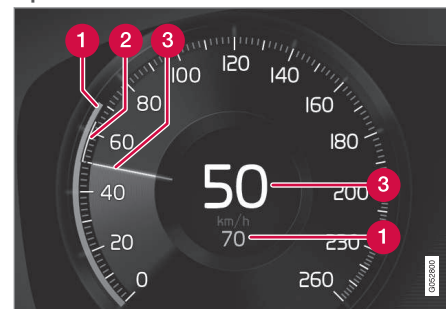

Speed indicators

- 1 Set speed
- 2 Speed of the vehicle ahead
- 3 The current speed of your vehicle

³⁴ Depending on market, this function can be either standard or optional.

³⁵ Adaptive Cruise Control

³⁶ Depending on market, this function can be either standard or optional.

Time interval



Adaptive Cruise Control will only regulate the time interval to the vehicle ahead when the distance symbol shows two vehicles. A speed interval will be marked at the same time.

When driving

In the following illustration, Road Sign Information* (RSI)³⁸ indicates that the maximum permitted speed is 130 km/h (80 mph).

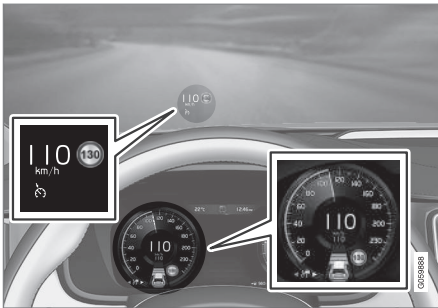

The previous illustration shows that Adaptive Cruise Control is set to maintain a speed of 110 km/h (68 mph) and that there is no target vehicle ahead to follow.

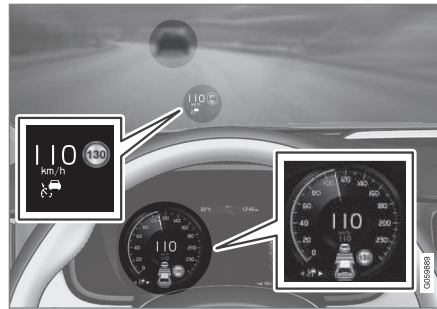

The previous illustration shows that Adaptive Cruise Control is set to maintain a speed of 110 km/h (68 mph) and is following a target vehicle ahead, which is traveling at the same speed.

Related information

- Adaptive Cruise Control* (p. 284)
- Adaptive Cruise Control* limitations (p. 290)

Selecting and activating Adaptive Cruise Control³⁹

Adaptive Cruise Control (ACC)⁴⁰ must first be selected and then activated before it can regulate speed and distance.

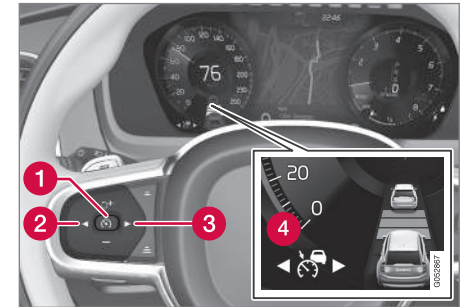

To start the function:



- The driver's seat belt must be buckled and the driver's door must be closed.
- There must be a vehicle ahead (target vehicle) within a reasonable distance or

³⁷ Adaptive Cruise Control

³⁸ Road Sign Information

³⁹ Depending on market, this function can be either standard or optional.

◀◀ your vehicle's current speed must be at least 15 km/h (9 mph).

1. Press the ◀ (2) or ▶ (3) button on the steering wheel keypad and scroll to the Adaptive Cruise Control symbol  (4).
 - > Gray symbol – Adaptive Cruise Control is in standby mode.
2. When Speed Limiter is selected, press  (1) on the steering wheel keypad to activate.
 - > White symbol – Speed Limiter starts and the current speed is stored as the maximum speed.

Reactivating Adaptive Cruise Control to the last stored speed

- When Adaptive Cruise Control is selected, press  on the steering wheel keypad to activate.
 - > The Cruise Control marking in the instrument panel will change from GRAY to WHITE and the vehicle will then return to the most recently set speed.

⚠ WARNING

A noticeable increase in speed may follow when the speed is resumed with the .

Related information

- Adaptive Cruise Control* (p. 284)
- Deactivating Adaptive Cruise Control* (p. 288)
- Switching between cruise control and Adaptive Cruise Control* in the center display (p. 291)
- Adaptive Cruise Control* limitations (p. 290)

Deactivating Adaptive Cruise Control*⁴¹

Adaptive Cruise Control (ACC⁴²) can be deactivated and switched off.

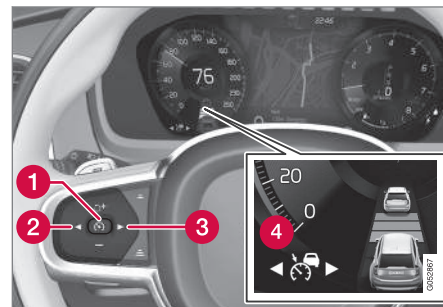

1. Press the  button on the steering wheel (1).
 - > The symbol and markings turn gray – Adaptive Cruise Control goes into standby mode. The time interval indicator light and any symbols for the target vehicle will go out.

⁴⁰ Adaptive Cruise Control

⁴¹ Depending on market, this function can be either standard or optional.

⁴² Adaptive Cruise Control

2. Press the ◀ (2) or ▶ (3) buttons on the steering wheel to select another function.
 - > The Adaptive Cruise Control symbol and marking (4) in the instrument panel will go out and the stored maximum speed will be erased.

WARNING

- If Adaptive Cruise Control is in standby mode, the driver must intervene and regulate both speed and distance to the vehicle ahead.
- If the vehicle comes too close to a vehicle ahead when Adaptive Cruise Control is in standby mode, the driver can be warned of the short distance by the Distance Alert* function.

Related information

- Adaptive Cruise Control* (p. 284)
- Selecting and activating Adaptive Cruise Control* (p. 287)
- Switching between cruise control and Adaptive Cruise Control* in the center display (p. 291)
- Adaptive Cruise Control* limitations (p. 290)

Adaptive Cruise Control*⁴³ standby mode

Adaptive Cruise Control (ACC⁴⁴) can be deactivated and put in standby mode. This may happen automatically or be due to driver intervention.

Standby mode means that the function is selected in the instrument panel but not activated. In standby mode, Adaptive Cruise Control will not regulate speed or distance to the vehicle ahead.

Standby mode due to action by the driver

Adaptive Cruise Control will be deactivated and put in standby mode if any of the following occurs:

- The brakes are applied.
- The gear selector is moved to **N**.
- The vehicle is driven faster than the set speed for more than 1 minute.

Temporarily increasing speed using the accelerator pedal, e.g. when passing another vehicle, will not affect the setting. The vehicle will return to the set speed when the accelerator pedal is released.

WARNING

- If Adaptive Cruise Control is in standby mode, the driver must intervene and regulate both speed and distance to the vehicle ahead.
- If the vehicle comes too close to a vehicle ahead when Adaptive Cruise Control is in standby mode, the driver can be warned of the short distance by the Distance Alert* function.

Automatic standby mode

WARNING

With automatic standby mode, the driver is warned by an acoustic signal and a message on the instrument panel.

- The driver must then regulate vehicle speed, apply the brakes if necessary, and maintain a safe distance to other vehicles.

The function may automatically go into standby mode if one of the following occurs:

- One of the systems that Adaptive Cruise Control is dependent on stops working,

⁴³ Depending on market, this function can be either standard or optional.

⁴⁴ Adaptive Cruise Control

- ◀◀ such as Electronic Stability Control (ESC⁴⁵).
- The driver opens the door.
 - The driver unbuckles the seat belt.
 - The engine speed (rpm) is too low/high.
 - One or more of the wheels lose traction.
 - The brake temperature is high.
 - The parking brake is applied.
 - The camera and radar unit is covered by snow or heavy rain (the camera lens/radar waves are blocked).
 - Your vehicle's speed goes below 5 km/h (3 mph) and ACC cannot determine if the vehicle ahead is stationary or if it is another object, e.g. a speed bump.
 - Your vehicle's speed goes below 5 km/h (3 mph) and the vehicle ahead turns so that ACC no longer has a vehicle to follow.

Related information

- Adaptive Cruise Control* (p. 284)
- Selecting and activating Adaptive Cruise Control* (p. 287)
- Deactivating Adaptive Cruise Control* (p. 288)
- Adaptive Cruise Control* limitations (p. 290)

⁴⁵ Electronic Stability Control

⁴⁶ Depending on market, this function can be either standard or optional.

Adaptive Cruise Control*⁴⁶ limitations

Adaptive Cruise Control (ACC⁴⁷) may have limited functionality in certain situations.

Steep roads and/or heavy loads

Adaptive Cruise Control is primarily intended to be driven on flat roads. The function may not be able to maintain the correct time interval to the vehicle ahead when driving down steep hills. The driver should be extra attentive and prepared to apply the brakes.

Do not use Adaptive Cruise Control if the vehicle is carrying a heavy load or towing a trailer.

Drive mode unavailable

The **Off Road** drive mode cannot be selected if Adaptive Cruise Control is activated.

WARNING

- This is not a collision avoidance system. The driver is always responsible and must intervene if the system fails to detect a vehicle ahead.
- The function does not brake for people or animals and does not brake for small vehicles, such as bikes and motorcycles. Similarly, it does not brake for low trailers, oncoming, slow-moving or stationary vehicles and objects.
- Do not use the function in demanding situations, such as in city traffic, at intersections, on slippery surfaces, with a lot of water or slush on the road, in heavy rain/snow, in poor visibility, on winding roads, or on on/off ramps.

NOTE

The function uses the vehicle's camera and radar sensor, which has certain general limitations.

Related information

- Adaptive Cruise Control* (p. 284)
- Camera/radar sensor limitations (p. 381)

Switching between cruise control and Adaptive Cruise Control*⁴⁸ in the center display



When the regular cruise control (CC⁴⁹) is selected in the instrument panel, you can switch to Adaptive Cruise Control (ACC⁵⁰) in the center display's Function view.



Activate or deactivate the function using this button in the center display's Function view.

- GREEN button indicator light – Adaptive Cruise Control is deactivated and the regular cruise control is in standby mode.
- GRAY button indicator light – regular cruise control is deactivated and the Adaptive Cruise Control is in standby mode.

A symbol in the instrument panel indicates which cruise control system is active

Cruise control (CC)	Adaptive Cruise Control (ACC)
	

^A WHITE symbol: The function is active. GRAY symbol: Standby mode

Related information

- Adaptive Cruise Control* (p. 284)
- Cruise control (p. 281)

⁴⁷ Adaptive Cruise Control

⁴⁸ Depending on market, this function can be either standard or optional.

⁴⁹ Cruise Control

⁵⁰ Adaptive Cruise Control





Symbols and messages for Adaptive Cruise Control*⁵¹

A number of symbols and messages relating to Adaptive Cruise Control (ACC⁵²) may be

displayed in the instrument panel and/or the head-up display*.

⁵¹ Depending on market, this function can be either standard or optional.

⁵² Adaptive Cruise Control

Symbol	Message	Meaning
	The symbol is WHITE	The vehicle is maintaining the stored speed.
	Adaptive Cruise Contr. Unavailable The symbol is GRAY	Adaptive Cruise Control is in standby mode.
	Adaptive Cruise Contr. Service required The symbol is GRAY	The system is not functioning as intended. Contact a workshop – an authorized Volvo workshop is recommended.
	Windscreen sensor Sensor blocked, see Owner's manual	Clean the windshield in front of the camera and radar sensors.

A text message can be erased by briefly pressing the  button in the center of the right-side steering wheel keypad.

If the message persists: Contact a workshop – an authorized Volvo workshop is recommended.

Related information

- Adaptive Cruise Control* (p. 284)
- Contacting Volvo (p. 26)

Pilot Assist^{*53}

Pilot Assist can help the driver keep the vehicle in the current traffic lane and maintain an even speed and a set time interval to the vehicle ahead.

Get to know Pilot Assist

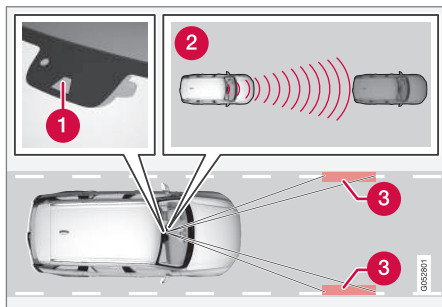

The camera/radar sensor monitors the distance to the vehicle ahead and detects lane markings.

- 1 Camera and radar sensor
- 2 Distance monitor
- 3 Lane marker line monitors

Pilot Assist helps to steer the vehicle, and you may need to drive a few miles with Pilot Assist before you feel completely at home with the function. It is important to be familiar with all

of the function's applications and limitations in order to take advantage of all it has to offer.

The Pilot Assist function is primarily intended for use on highways and other major roads where it can help provide a more comfortable and relaxing driving experience.

The driver sets the desired speed and distance to the vehicle ahead. Pilot Assist monitors the distance to the vehicle ahead and the traffic lane's side markers using the camera. The system maintains the set time interval to the vehicle ahead by automatically adjusting your vehicle's speed and keeps your vehicle in its lane by providing steering assistance.

If the Curve Speed Assist (CSA)* function is activated, it may also affect the vehicle's speed.

Pilot Assist regulates speed by accelerating and braking. It is normal for the brakes to emit a slight sound when they are being used to adjust speed.

Pilot Assist is designed to:

- smoothly regulate speed. The driver must apply the brakes in situations requiring immediate braking. For example, when there are great differences in speed between vehicles or if the vehicle ahead brakes suddenly. Due to limitations in the

camera and radar sensor, braking may occur unexpectedly or not at all.

- follow a vehicle ahead in the same lane and maintain a time interval to that vehicle set by the driver. If the radar sensor does not detect a vehicle ahead, it will instead maintain the speed set by the driver. This will also happen if the speed of the vehicle ahead exceeds the set speed for your vehicle.

The vehicle's position in the traffic lane

When Pilot Assist helps to steer, it attempts to position the vehicle halfway between the visible lane marking lines. For a smoother drive, it is a good idea to allow the vehicle to find a good position. The driver can always adjust the position him/herself by increasing steering input. It is important for the driver to make sure the vehicle is positioned safely in the lane.

If Pilot Assist does not position the vehicle appropriately in the lane, the driver should turn off Pilot Assist or switch to Adaptive Cruise Control*.

⁵³ Depending on market, this function can be either standard or optional.

Steering assistance

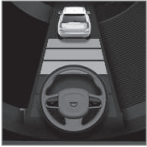

The color of the steering wheel symbol indicates the current status of steering assistance:

- GREEN indicates that steering assistance is active
- GRAY (as shown in illustration) indicates that steering assistance is deactivated.

Pilot Assist's steering assistance is based on monitoring the direction of the vehicle ahead and the traffic lane's side marker lines. The driver can override Pilot Assist's steering recommendations at any time and steer in another direction, e.g. to change lanes or avoid obstacles on the road.

If the camera/radar sensor cannot detect the lane's side marker lines or if Pilot Assist is unable for some other reason to clearly interpret the lane, Pilot Assist will temporarily deactivate steering assistance until it can once again interpret the lane markings. However, the speed and distance warnings will remain active. The driver will be alerted by slight vibrations in the steering wheel that the function has been temporarily deactivated.

WARNING

Pilot Assist is deactivated automatically and resumes working without prior notice.

In curves and forks in the road

Pilot Assist is designed to interact with the driver. The driver should never wait for steering assistance from Pilot Assist, but instead should always be ready to increase his or her own steering efforts, particularly in curves.

When the vehicle is approaching an off-ramp or a fork in the road, the driver should steer toward the desired lane so that Pilot Assist can detect the desired direction of travel.

Hands on the steering wheel

Pilot Assist only functions if the driver's hands are on the steering wheel. It is also important for the driver to always continue to be active and alert when driving since Pilot Assist is unable to read all situations and may toggle between off and on without prior warning.



If Pilot Assist detects that the driver's hands are not on the steering wheel, the system will provide a symbol and a text message in the instrument panel to instruct the driver to actively steer the

vehicle.

If the driver's hands are still detected on the steering wheel after a few seconds have passed, the instructions to actively steer the vehicle will be repeated, accompanied by an audible signal.

If Pilot Assist still does not detect the driver's hands on the steering wheel after a few more seconds have passed, the audible signal will become intense and the steering function will switch off. Pilot Assist must then be reactivated by pressing the  button on the steering wheel.

WARNING

- The function is supplementary driver support intended to facilitate driving and help make it safer – it cannot handle all situations in all traffic, weather and road conditions.
- The driver is advised to read all sections in the Owner's Manual about this function to learn of its limitations, which the driver must be aware of before using the function.
- Driver support functions are not a substitute for the driver's attention and judgment. The driver is always responsible for ensuring the vehicle is driven in a safe manner, at the appropriate speed, with an appropriate distance to other vehicles, and in accordance with current traffic rules and regulations.



CAUTION

Only a workshop may perform maintenance on driver support components – an authorized Volvo workshop is recommended.

Related information

- Driver support systems (p. 268)
- Selecting and activating Pilot Assist* (p. 298)
- Pilot Assist* displays (p. 297)
- Pilot Assist* limitations (p. 302)
- Pilot Assist* symbols and messages (p. 304)
- Pilot Assist* controls (p. 296)
- Collision risk warning from driver support (p. 309)
- Switching target vehicles with driver support (p. 310)
- Setting time interval to the vehicle ahead (p. 312)
- Adjusting set speed for driver support (p. 311)
- Auto-hold braking with driver support (p. 313)
- Passing assistance* (p. 308)
- Contacting Volvo (p. 26)

Pilot Assist*⁵⁴ controls

A summary of how Pilot Assist is controlled using the right-side steering wheel keypad and how the function is shown in the display.

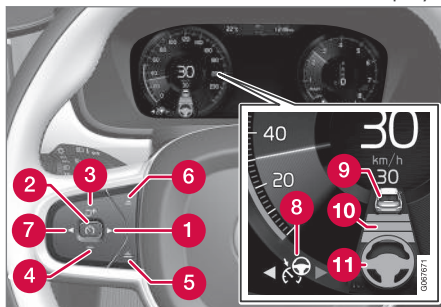

Function buttons and symbols.

- 1 ▶: Switches from Adaptive Cruise Control* to Pilot Assist
- 2 🚗: **From standby mode** - activates Pilot Assist and sets the current speed
- 2 🚗: **From active mode** - deactivates/ puts Pilot Assist in standby mode
- 3 🔄: Activates Pilot Assist from standby mode and resumes the set speed and time interval
- 3 +: Increases the set speed

- 4 - : Reduces the set speed
- 5 Increases the time interval to the vehicle ahead
- 6 Reduces the time interval to the vehicle ahead
- 7 ⏪: Switches from Pilot Assist to Adaptive Cruise Control
- 8 Function symbol
- 9 Symbols for target vehicle
- 10 Symbol for time interval to the vehicle ahead
- 11 Symbol for activated/deactivated steering assistance

Related information

- Pilot Assist* (p. 294)

⁵⁴ Depending on market, this function can be either standard or optional.

Pilot Assist⁵⁵ displays

The following illustrations show how Pilot Assist can appear in the various displays in different situations.

Speed

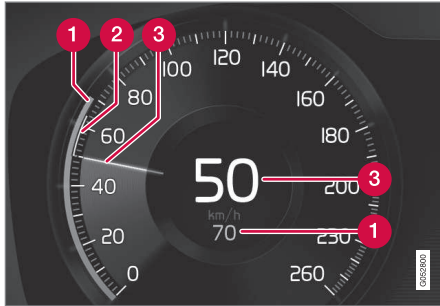

Speed indicators.

- 1 Set speed
- 2 Speed of the vehicle ahead
- 3 The current speed of your vehicle

Time interval

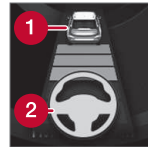

Pilot Assist will only regulate the time interval to the vehicle ahead when the distance symbol shows a vehicle (1) over the steering wheel symbol.

Pilot Assist's steering assistance is only active when the steering wheel symbol (2) changes from GRAY to GREEN.

When driving

In the following illustration, Road Sign Information (RSI⁵⁶) indicates that the maximum permitted speed is 130 km/h (80 mph).

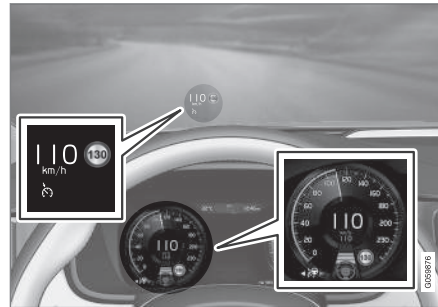

The previous illustration shows that Pilot Assist is set to maintain a speed of 110 km/h

(68 mph) and that there is no target vehicle ahead to follow.

Pilot Assist will not provide any steering assistance because it cannot detect the lane's side marking lines.

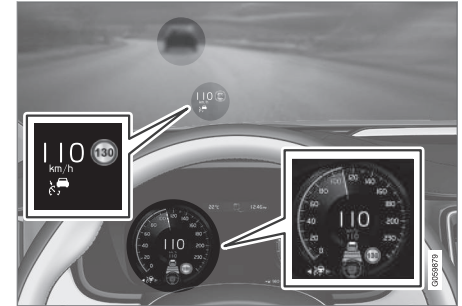

The previous illustration shows that Pilot Assist is set to maintain a speed of 110 km/h (68 mph) and is following a target vehicle ahead that is traveling at the same speed.

Pilot Assist will not provide any steering assistance because it cannot detect the lane's side marking lines.

⁵⁵ Depending on market, this function can be either standard or optional.

⁵⁶ Road Sign Information

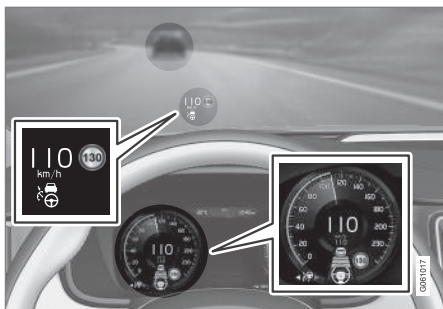

The previous illustration shows that Pilot Assist is set to maintain a speed of 110 km/h (68 mph) and is following a target vehicle ahead that is traveling at the same speed.

In this example, Pilot Assist will also provide steering assistance because it can detect the lane's side marking lines.

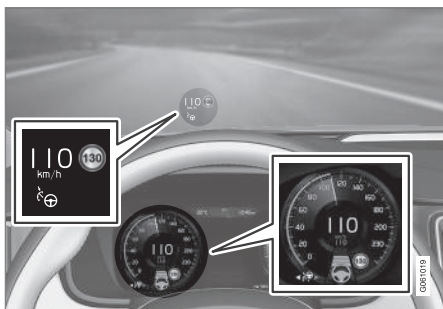

The previous illustration shows that Pilot Assist is set to maintain a speed of 110 km/h (68 mph) and that there is no target vehicle ahead to follow.

Pilot Assist will provide steering assistance because it can detect the lane's side marking lines.

Related information

- Pilot Assist* (p. 294)
- Pilot Assist* limitations (p. 302)

Selecting and activating Pilot Assist*⁵⁷

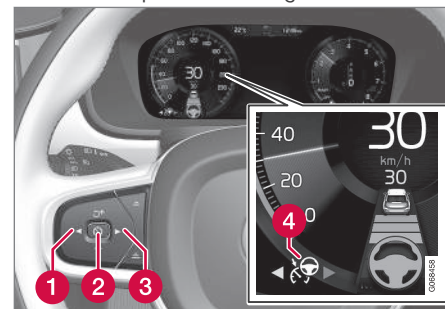

Pilot Assist must first be selected and then activated before it can regulate speed and distance and provide steering assistance.



A green steering wheel indicates that Pilot Assist is providing steering assistance.

To start Pilot Assist.

- The driver's seat belt must be buckled and the driver's door must be closed.
- The side markings of the lane must be clearly visible and detected by the vehicle.
- There must be a vehicle ahead (target vehicle) within a reasonable distance or your vehicle's current speed must be at least 15 km/h (9 mph).
- The speed must not exceed 140 km/h (87 mph).

- The driver must keep their hands on the steering wheel.
 - There must be a vehicle ahead (target vehicle) within a reasonable distance or your vehicle's current speed must be at least 15 km/h (9 mph).
1. Press the ◀ (1) or ▶ (3) button on the steering wheel keypad and scroll to the Pilot Assist symbol  (4).
 - > Gray symbol – Pilot Assist is in standby mode.
 2. When Pilot Assist is selected, press  (2) on the steering wheel keypad to activate.
 - > White symbol – Pilot Assist starts and the current speed is stored as the maximum speed.

Reactivating Pilot Assist to the last stored speed

- When Pilot Assist is selected, press  on the steering wheel keypad to activate.
 - > The Cruise Control marking in the instrument panel will change from GRAY to WHITE and the vehicle will then return to the most recently set speed.

WARNING

A noticeable increase in speed may follow when the speed is resumed with the  steering wheel button.

Related information

- Pilot Assist* (p. 294)
- Deactivating Pilot Assist* (p. 299)
- Pilot Assist* limitations (p. 302)

Deactivating Pilot Assist*⁵⁸

Pilot Assist can be deactivated and switched off.

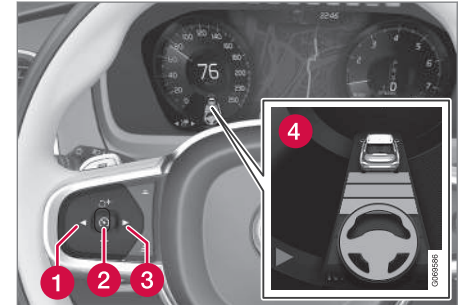

A green steering wheel indicates that Pilot Assist is providing steering assistance.

1. Press the  button on the steering wheel (2).
 - > The symbol and markings turn gray – Pilot Assist goes into standby mode. The time interval indicator light and any symbols for the target vehicle will go out.

⁵⁷ Depending on market, this function can be either standard or optional.

⁵⁸ Depending on market, this function can be either standard or optional.

- ◀ 2. Press the ◀ (1) or ▶ (3) buttons on the steering wheel to select another function.
- > The Pilot Assist symbol and marking (4) in the instrument panel will go out and the stored maximum speed will be erased.

WARNING

- With Pilot Assist in standby mode, the driver must intervene and steer and regulate both speed and distance to the vehicle ahead.
- If the vehicle comes too close to a vehicle ahead when Pilot Assist is in standby mode, the driver is instead warned of the short distance by the Distance Alert* function.

Related information

- Adaptive Cruise Control* (p. 284)
- Selecting and activating Adaptive Cruise Control* (p. 287)
- Switching between cruise control and Adaptive Cruise Control* in the center display (p. 291)
- Adaptive Cruise Control* limitations (p. 290)
- Temporarily deactivating steering assistance with Pilot Assist* (p. 301)

Pilot Assist*⁵⁹ standby mode

Pilot Assist can be deactivated and put in standby mode. This may happen automatically or be due to driver intervention. Standby mode means that the function is selected in the instrument panel but not activated. In standby mode, Pilot Assist will not regulate the speed or distance to the vehicle ahead or provide steering assistance.

Standby mode due to action by the driver

Pilot Assist will be deactivated and put in standby mode if any of the following occurs:

- The brakes are applied.
- The gear selector is moved to **N**.
- A turn signal is used for more than 1 minute.
- The vehicle is driven faster than the set speed for more than 1 minute.

Automatic standby mode

WARNING

With automatic standby mode, the driver is warned by an acoustic signal and a message on the instrument panel.

- The driver must then regulate vehicle speed, apply the brakes if necessary, and maintain a safe distance to other vehicles.

The function may automatically go into standby mode if one of the following occurs.

- One of the systems that Pilot Assist is dependent on stops working, such as Electronic Stability Control⁶⁰.
- The driver's hands are not on the steering wheel.
- The driver opens the door.
- The driver unbuckles the seat belt.
- The engine speed (rpm) is too low/high.
- One or more of the wheels lose traction.
- The brake temperature is high.
- The parking brake is applied.
- The camera and radar unit is covered by snow or heavy rain (the camera lens/radar waves are blocked).

⁵⁹ Depending on market, this function can be either standard or optional.

* Option/accessory.

- Your vehicle's speed goes below 5 km/h (3 mph) and Pilot Assist cannot determine if the vehicle ahead is stationary or if it is another object, e.g. a speed bump.
- Your vehicle's speed goes below 5 km/h (3 mph) and the vehicle ahead turns so that Pilot Assist no longer has a vehicle to follow.

Related information

- Pilot Assist* (p. 294)
- Selecting and activating Pilot Assist* (p. 298)
- Deactivating Pilot Assist* (p. 299)
- Pilot Assist* limitations (p. 302)

Temporarily deactivating steering assistance with Pilot Assist*⁶¹

Pilot Assist steering assistance can be temporarily deactivated and reactivated without prior warning.

When the turn signals are used, Pilot Assist's steering assistance will be temporarily deactivated. When the direction indicator is turned off, steering assistance is reactivated automatically if the lane's edge markings can still be detected.

If Pilot Assist cannot clearly interpret the lane's side marker lines or if the camera/radar sensor is unable for some other reason to clearly interpret the lane, Pilot Assist will temporarily deactivate steering assistance. However, the speed and distance warnings will remain active. Steering assistance will resume when the side marker lines can once again be interpreted. In these situations, the driver may be alerted through slight vibrations in the steering wheel that steering assistance is temporarily deactivated.

Related information

- Pilot Assist* (p. 294)
- Selecting and activating Pilot Assist* (p. 298)
- Deactivating Pilot Assist* (p. 299)

- Pilot Assist* limitations (p. 302)

⁶⁰ Electronic Stability Control

⁶¹ Depending on market, this function can be either standard or optional.

Pilot Assist^{*62} limitations

Pilot Assist functionality may be reduced in certain situations.

Pilot Assist is a driver support function designed to simplify driving and assist the driver in many situations. However, the driver is always responsible for maintaining a suitable distance to vehicles or objects around it and ensuring that the vehicle is correctly positioned in the traffic lane.

WARNING

In some situations, Pilot Assist may have trouble helping the driver properly or may be deactivated automatically – we advise against using Pilot Assist in such cases. Examples of such situations include:

- the lane markings are unclear, worn, missing, cross each other, or there are multiple sets of road markings.
- the lane division changes, e.g. when lanes split or merge, and at off-ramps.
- when there is road construction and sudden changes to the road surface, e.g. when the lines may no longer mark the correct route.
- edges or other lines than lane markings are present on or near the road, e.g. curbs, joints or repairs to the road surface, edges of barriers, roadside edges or strong shadows.
- the lane is narrow or winding.
- the lane contains ridges or holes.
- weather conditions are poor, e.g. rain, snow or fog or slush or reduced visibil-

ity with poor light conditions, back-lighting, wet road surface, etc.

The driver should also note that Pilot Assist has the following limitations:

- High curbs, roadside barriers, temporary obstacles (traffic cones, safety barriers, etc.) are not detected. Alternatively, they may be detected incorrectly as lane markings, with a subsequent risk of contact between the vehicle and such obstacles. The driver is responsible for ensuring that the vehicle maintains a suitable distance from such obstacles.
- The camera and radar sensors do not have the capacity to detect all oncoming objects and obstacles in traffic environments, e.g. potholes, stationary obstacles or objects that completely or partially block the route.
- Pilot Assist does not "see" pedestrians, animals, etc.
- The steering assistance is limited in force, which means that Pilot Assist cannot always help the driver to steer and keep the vehicle within the lane.
- In vehicles equipped with Sensus Navigation*, the function is able to use

⁶² Depending on market, this function can be either standard or optional.

information from map data, which could cause variations in performance.

- Pilot Assist will be switched off if the speed-dependent power steering wheel resistance is working at reduced power, e.g. during cooling due to overheating.

WARNING

Pilot Assist should only be used if there are clear lane lines painted on each side of the lane. All other use will increase the risk of contact with nearby obstacles that cannot be detected by the functions.

WARNING

- This is not a collision avoidance system. The driver is always responsible and must intervene if the system fails to detect a vehicle ahead.
- The function does not brake for people or animals and does not brake for small vehicles, such as bikes and motorcycles. Similarly, it does not brake for low trailers, oncoming, slow-moving or stationary vehicles and objects.
- Do not use the function in demanding situations, such as in city traffic, at intersections, on slippery surfaces, with a lot of water or slush on the road, in heavy rain/snow, in poor visibility, on winding roads, or on on/off ramps.

The driver can always correct or adjust steering assistance provided by Pilot Assist by turning the steering wheel to the desired position.

Steep roads and/or heavy loads

Pilot Assist is primarily intended to be driven on flat roads. The function may not be able to maintain the correct time interval to the vehicle ahead when driving down steep hills. The driver should be extra attentive and prepared to apply the brakes.

Do not use Pilot Assist if the vehicle is carrying a heavy load or towing a trailer.

NOTE

Pilot Assist cannot be activated if a trailer, bike carrier or similar is connected to the vehicle electrical system.

Drive mode unavailable

The **Off Road** drive mode cannot be selected when Pilot Assist is activated.

NOTE



The function uses the vehicle's camera and radar sensor, which has certain general limitations.

Related information

- Pilot Assist* (p. 294)
- Camera/radar sensor limitations (p. 381)
- Speed-dependent steering wheel resistance (p. 268)
- Drive modes (p. 434)

Pilot Assist^{*63} symbols and messages

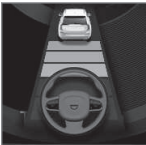
A number of symbols and messages relating to Pilot Assist may be displayed in the instrument panel and/or the head-up display*.

Symbol	Message	Meaning
	Gray steering wheel symbol	Indicates that steering assistance is deactivated. When Pilot Assist is providing steering assistance, the steering wheel is green.
	Symbol for hands on the steering wheel	The system cannot detect the driver's hands on the steering wheel. Place your hands on the steering wheel and actively steer the vehicle.
	Windscreen sensor Sensor blocked, see Owner's manual	Clean the windshield in front of the camera and radar sensors.

A text message can be erased by briefly pressing the  button in the center of the right-side steering wheel keypad.

If the message persists: Contact a workshop – an authorized Volvo workshop is recommended.

⁶³ Depending on market, this function can be either standard or optional.

Related information

- Pilot Assist* (p. 294)
- Pilot Assist* limitations (p. 302)
- Contacting Volvo (p. 26)

Curve Speed Assist (CSA)*⁶⁴

Curve Speed Assist can help the driver reduce speed before sharp turns if the preset speed for the driver support function Adaptive Cruise Control* or Pilot Assist* is determined to be too high.



As the function reduces the vehicle's speed, this symbol will be displayed in the instrument panel.

This assessment is performed using information from map data in the vehicle's navigation system, Sensus Navigation*. After the turn, the vehicle will resume the previously set speed.

The driver can cancel the function at any time by braking or using the accelerator pedal.

WARNING

- The function is supplementary driver support intended to facilitate driving and help make it safer – it cannot handle all situations in all traffic, weather and road conditions.
- The driver is advised to read all sections in the Owner's Manual about this function to learn of its limitations, which the driver must be aware of before using the function.
- Driver support functions are not a substitute for the driver's attention and judgment. The driver is always responsible for ensuring the vehicle is driven in a safe manner, at the appropriate speed, with an appropriate distance to other vehicles, and in accordance with current traffic rules and regulations.

Drive modes

Cornering assistance varies depending on the selected drive mode. If drive mode cannot be selected, the function will use the **Comfort** option. In **Dynamic** mode, cornering will be sporty, with slightly more powerful acceleration coming out of curves.

Related information

- Activating or deactivating Curve Speed Assist (CSA)* (p. 307)
- Curve Speed Assist (CSA)* limitations (p. 307)
- Driver support systems (p. 268)
- Adaptive Cruise Control* (p. 284)
- Pilot Assist* (p. 294)
- Drive modes (p. 434)

⁶⁴ This function is only available on some markets.

Activating or deactivating Curve Speed Assist (CSA)*

The Curve Speed Assist (CSA) function can be activated as a supplement to Adaptive Cruise Control* or Pilot Assist*. The driver can also deactivate the function.



Activate or deactivate the function using this button in the center display's Function view.

- GREEN button indicator light – the function is activated.
- GRAY button indicator light – the function is deactivated.

The next time the engine is started, the last used setting is reactivated or the key's driver profile settings are followed⁶⁵.

Related information

- Curve Speed Assist (CSA)* (p. 306)
- Curve Speed Assist (CSA)* limitations (p. 307)

Curve Speed Assist (CSA)*⁶⁶ limitations

Curve Speed Assist (CSA) functionality may be reduced in certain situations. The driver should be aware of the following limitations:

- Curve Speed Assist (CSA) may have limited performance on small roads and in densely populated areas.
- At off-ramps or intersections, Curve Speed Assist (CSA) may temporarily switch off.
- If the satellite navigator's⁶⁷ map data is not updated, Curve Speed Assist (CSA) may have limited functionality.
- Curve Speed Assist (CSA) functionality may be limited if the satellite navigator⁶⁷ has lost contact with the satellite system.
- On new or rebuilt roads, map data may be incorrect.
- The risk of reduced grip due to adverse weather or road conditions is not taken into account when calculating suitable cornering speed.

i NOTE

The function uses the vehicle's camera and radar sensor, which has certain general limitations.

Related information

- Curve Speed Assist (CSA)* (p. 306)
- Activating or deactivating Curve Speed Assist (CSA)* (p. 307)
- Camera/radar sensor limitations (p. 381)

⁶⁵ These alternatives are market dependent.

⁶⁶ This function is only available on some markets.

⁶⁷ Only with Volvo Sensus Navigation* installed.

Passing assistance*

Passing assistance can assist the driver when passing other vehicles. The function can be used with Adaptive Cruise Control* or Pilot Assist*.

When Adaptive Cruise Control or Pilot Assist is following another vehicle and you indicate that you intend to pass that vehicle by using the turn signal⁶⁸, the system will begin accelerating toward the vehicle ahead **before** your vehicle has moved into the passing lane.

The function will then delay a speed reduction to avoid early braking as your vehicle approaches a slower-moving vehicle.

The function remains active until your vehicle has passed the other vehicle.

WARNING

Please note that this function can be activated in more situations than just passing another vehicle, such as when a direction indicator is used to indicate a lane change or before exiting to another road – the vehicle will then briefly accelerate.

WARNING

- The function is supplementary driver support intended to facilitate driving and help make it safer – it cannot handle all situations in all traffic, weather and road conditions.
- The driver is advised to read all sections in the Owner's Manual about this function to learn of its limitations, which the driver must be aware of before using the function.
- Driver support functions are not a substitute for the driver's attention and judgment. The driver is always responsible for ensuring the vehicle is driven in a safe manner, at the appropriate speed, with an appropriate distance to other vehicles, and in accordance with current traffic rules and regulations.

Related information

- Driver support systems (p. 268)
- Using passing assistance (p. 308)
- Adaptive Cruise Control* (p. 284)
- Pilot Assist* (p. 294)

Using passing assistance

Passing assistance can be used with Adaptive Cruise Control* or Pilot Assist*. Several conditions must be met for passing assistance to be possible.

In order to activate passing assistance:

- your vehicle must be following a vehicle ahead (target vehicle)
- your vehicle's **current speed** must be at least 70 km/h (43 mph)
- **the set speed** must be high enough to safely pass another vehicle.

To start passing assistance:

- Turn on the left turn signal.
 - > Passing assistance will start.

⁶⁸ Only the left-hand turn signal for left-hand drive vehicles, or right-hand turn signal for right-hand drive vehicles.

⚠ WARNING

The driver should be aware that if conditions suddenly change when using Passing Assistance, the function may implement an undesired acceleration in certain conditions.

Some situations should be avoided, e.g. if:

- the vehicle is approaching an exit in the same direction as passing would normally occur
- the vehicle ahead slows before your vehicle has had time to switch to the passing lane
- traffic in the passing lane slows down

Situations of this type can be avoided by temporarily putting Adaptive Cruise Control or Pilot Assist in standby mode.

Related information

- Passing assistance* (p. 308)
- Adaptive Cruise Control* (p. 284)
- Pilot Assist* (p. 294)
- Adaptive Cruise Control* standby mode (p. 289)
- Pilot Assist* standby mode (p. 300)

Collision risk warning from driver support

The driver support systems Adaptive Cruise Control* and Pilot Assist* can help alert the driver if the distance to the vehicle ahead suddenly decreases to an unsafe distance.

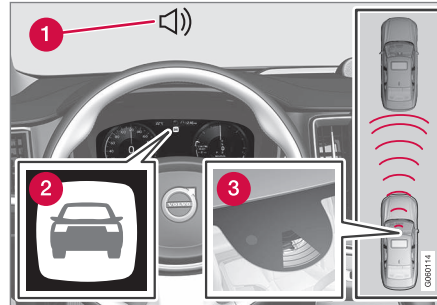

Collision warning audible signal and symbol

- 1 Audible signal at risk of collision
- 2 Collision warning symbol
- 3 Camera/radar sensor distance monitoring

Adaptive Cruise Control and Pilot Assist use approx. 40% of the braking capacity. If a situation requires more braking force than driver support can provide, and if the driver does not apply the brakes, a warning light and audible warning signal will be activated to alert the driver that immediate action is required.

⚠ WARNING

The driver support system only issues a warning for vehicles detected by its radar unit – thus, a warning may come after a delay or not at all. Never wait for a warning. Apply the brakes when necessary.

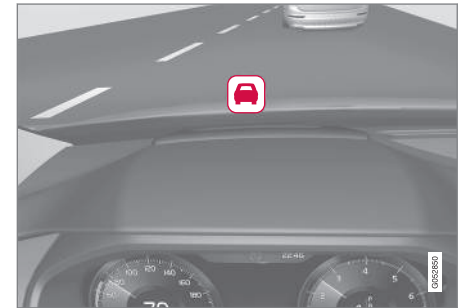

Collision warning symbol on the windshield

In vehicles equipped with a head-up display*, a flashing warning symbol will be displayed on the windshield.

i NOTE

Visual warnings on the windshield may be difficult to notice in cases of strong sunlight, reflections, extreme light contrasts, or if the driver is wearing sunglasses or is not looking straight ahead.



◀◀ **Related information**

- Driver support systems (p. 268)
- Adaptive Cruise Control* (p. 284)
- Pilot Assist* (p. 294)
- Distance Alert* (p. 348)
- Head-up display* (p. 140)

Switching target vehicles with driver support

At certain speeds, vehicles with automatic transmissions and the driver support functions Adaptive Cruise Control* and Pilot Assist* can switch target vehicles.

Switching target vehicles

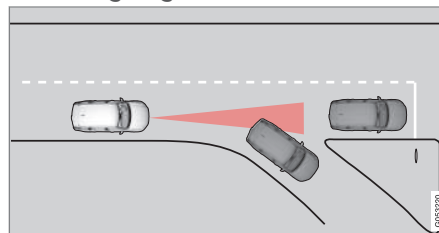

If the target vehicle ahead turns suddenly, there may be stationary traffic ahead.

When driver support is actively following another vehicle at speeds **under** 30 km/h (20 mph) and switches targets from a moving vehicle to a stationary vehicle, driver support will brake for the stationary vehicle.

⚠ WARNING

When driver support follows another vehicle at speeds **over** approx. 30 km/h (20 mph) and changes target vehicle – from a moving vehicle to a stationary one – driver support will **ignore** the stationary vehicle and instead accelerate to the stored speed.

- The driver must then intervene and apply the brakes.

Automatic standby mode when switching targets

Driver support disengages and goes into standby mode if:

- your vehicle's speed goes under 5 km/h (3 mph) and driver support cannot determine if the target vehicle is stationary or if it is another object, e.g. a speed bump.
- your vehicle's speed goes under 5 km/h (3 mph) and the vehicle ahead turns so that driver support no longer has a vehicle to follow.

Related information

- Driver support systems (p. 268)
- Adaptive Cruise Control* (p. 284)
- Pilot Assist* (p. 294)

Adjusting set speed for driver support

It is possible to adjust set speeds for the cruise control, Adaptive Cruise Control* and Pilot Assist* functions.

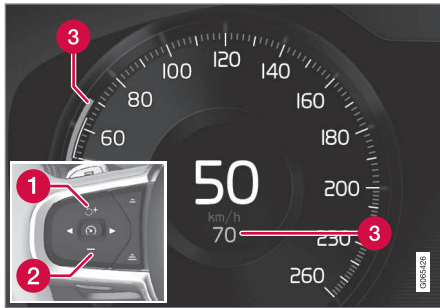

- 1 + : Increases the set speed
- 2 - : Reduces the set speed
- 3 Set speed

- Change a set speed by pressing the + (1) or - (2) buttons briefly or by pressing and holding them:
 - **Brief press:** Each press changes the speed in +/- 5 km/h (+/- 5 mph) increments.
 - **Press and hold:** Release the button when the set speed indicator (3) has moved to the desired speed.
- > The most recently set speed will be stored.

i NOTE

For vehicles without Adaptive Cruise Control*, speed instead increases by +/- 1km/h (+/- 1 mph) each time the button is pressed.

Pressing the accelerator pedal

If speed is increased by depressing the accelerator pedal while pressing the + (1) button on the steering wheel, the vehicle's speed when the button is pressed will be stored as the set speed.

Temporarily increasing speed using the accelerator pedal, e.g. when passing another vehicle, will not affect the setting. The vehicle will return to the set speed when the accelerator pedal is released.

Possible speed

Automatic transmission

The driver support functions can follow another vehicle at speeds from a standstill up to 200 km/h (125 mph).

Pilot Assist can provide steering assistance from near-stationary speeds up to 140 km/h (87 mph).

The lowest speed that can be set is 30 km/h (20 mph). When following another vehicle, ACC can monitor that vehicle's speed and slow your own vehicle down to a standstill, but it is not possible to set speeds lower than 30 km/h (20 mph).

Related information

- Driver support systems (p. 268)
- Cruise control (p. 281)
- Adaptive Cruise Control* (p. 284)
- Pilot Assist* (p. 294)

Setting time interval to the vehicle ahead

The time interval to the vehicle ahead can be set for the functions Adaptive Cruise Control*, Pilot Assist* and Distance Alert*.



Different time intervals to the vehicle ahead can be selected and are shown in the instrument panel as 1–5 horizontal bars. The more bars, the longer the time interval. One bar represents an interval of

approx. 1 second to the vehicle ahead. 5 bars represents approx. 3 seconds.

i NOTE

When the symbol in the instrument panel shows a vehicle and a steering wheel, Pilot Assist follows a vehicle ahead at a preset time interval.

When only a steering wheel is shown, there is no vehicle ahead within a reasonable distance.

i NOTE

When the symbol in the instrument panel shows two vehicles, Adaptive Cruise Control is following the vehicle ahead at a preset time interval.

When only one vehicle is shown, there is no vehicle ahead within a reasonable distance.

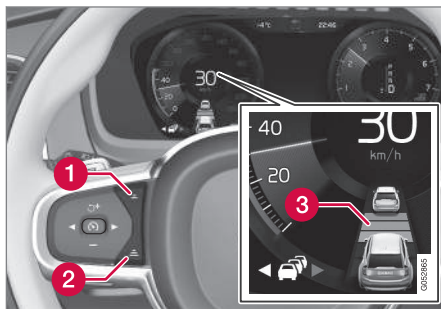

Controls for setting a time interval.

- 1** Reduce the time interval
 - 2** Increase the time interval
 - 3** Distance indicator
- Press the (1) or (2) button to decrease or increase the time interval.
- > The distance indicator (3) shows the current time interval.

In order to help your vehicle follow the vehicle ahead as smoothly and comfortably as possible, Adaptive Cruise Control allows the time interval to vary noticeably in certain situations. At low speeds, when the distance to the vehicle ahead is short, Adaptive Cruise Control increases the time interval slightly.

i NOTE

- The greater the vehicles' speed, the greater the distance between them for a set time interval.
- Only use the time intervals permitted by local traffic regulations.
- If driver support does not seem to respond with a speed increase when activated, it may be because the time interval to the vehicle ahead is shorter than the set time interval.

⚠ WARNING

- Only use a time interval suitable for the current traffic conditions.
- The driver should be aware that short time intervals give them limited time to react and act to any unforeseen traffic situation.

Related information

- Drive modes when using time interval to vehicle (p. 313)
- Driver support systems (p. 268)
- Adaptive Cruise Control* (p. 284)
- Pilot Assist* (p. 294)
- Distance Alert* (p. 348)
- Head-up display* (p. 140)

Drive modes when using time interval to vehicle

The driver can choose different drive modes to determine how driver support should maintain a time interval to the vehicle ahead. Settings are made using the **DRIVE MODE** controls.

Select one of the following:

- **Pure** - Driver support will focus on providing good fuel economy, which will increase the time interval to the vehicle ahead.
- **Hybrid** - Driver support will focus on following the set time interval to the vehicle ahead as smoothly as possible.
- **Power** - Driver support will focus on following the set time interval to the vehicle ahead more exactly, which could mean faster acceleration and heavier braking.

Related information

- Setting time interval to the vehicle ahead (p. 312)
- Driver support systems (p. 268)
- Drive modes (p. 434)

Auto-hold braking with driver support

The driver support functions Adaptive Cruise Control* and Pilot Assist* have a special brake function in slow traffic and while stationary. In certain situations, the parking brake will be applied to keep the vehicle at a standstill.

Braking function in slow traffic and at a standstill

In slow-moving, stop-and-go traffic or when stopped at a traffic light, driving will resume automatically if the vehicle is stopped for less than approx. 3 seconds. If it takes more than 3 seconds for the vehicle ahead to begin moving again, the driver support function will go into standby mode and the auto-hold brake function will activate.

- The function can be reactivated by:
 - Pressing the  button on the steering wheel keypad.
 - Pressing the accelerator pedal.
- > The function will resume following the vehicle ahead if it begins to move within approx. 6 seconds.

WARNING

A noticeable increase in speed may follow when the speed is resumed with the  steering wheel button.





WARNING

The driver support system only issues a warning for obstacles detected by its radar sensor – thus, a warning may come after a delay or not at all.

- Never wait for a warning or assistance. Apply the brakes when necessary.

NOTE

Driver support can keep the vehicle stationary for no more than 5 minutes – after that time the parking brake is applied and the function is deactivated.

The parking brake must be released before driver support can be reactivated.

Deactivation of the Auto-hold brake function

In certain situations, auto-hold will be deactivated when the vehicle is at a standstill and the function will go into standby mode. This means that the brakes will be released and the vehicle could begin to roll. The driver must actively apply the brakes to keep the vehicle stationary.

This can occur if:

- The driver depresses the brake pedal.
- The parking brake is applied.

- The gear selector is moved to the **P**, **N** or **R** position.
- The driver puts Adaptive Cruise Control or Pilot Assist in standby mode.

Auto Activate Parking Brake

The parking brake will be applied if the function is keeping the vehicle stationary using the brakes and:

- The driver opens the door or unbuckles his/her seat belt.
- The function has kept the vehicle at a standstill for more than approx. 5 minutes.
- The brakes overheat.
- The driver switches off the engine.

Related information

- Driver support systems (p. 268)
- Adaptive Cruise Control* (p. 284)
- Pilot Assist* (p. 294)
- Brake functions (p. 417)

Lane Keeping Aid

Lane Keeping Aid (LKA⁶⁹) is designed to actively steer the vehicle on freeways, highways and other major roads to help the driver reduce the risk of the vehicle unintentionally veering out of the lane.

Lane Keeping Aid steers the vehicle back into the lane and/or alerts the driver using vibrations in the steering wheel.

Lane Keeping Aid is active at speeds between 65–200 km/h (40–125 mph) on roads with clearly visible traffic lane marker lines.

On narrow roads, the function may be unavailable and go into standby mode. The function will become available again when the road becomes sufficiently wide.

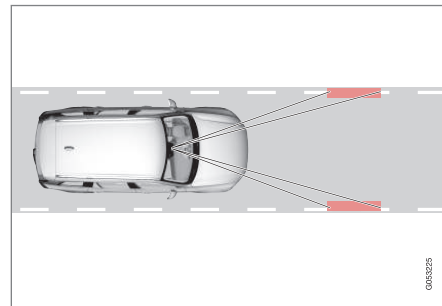

A camera monitors the road/traffic lane's marker lines.

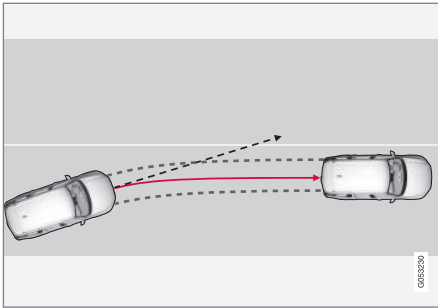

Lane Keeping Aid steers the vehicle back into its lane.

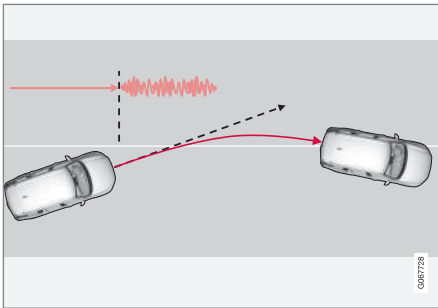

Lane Keeping Aid alerts the driver using vibrations in the steering wheel.

Depending on the settings used, Lane Keeping Aid functions in different ways:

- **Assist** enabled: When the vehicle approaches a lane marker line, the function will actively steer the vehicle back into the lane using light pressure on the steering wheel.
- **Warning** enabled: If the vehicle is about to move over a lane marker line, the driver will be alerted by vibrations in the steering wheel.

There is also an option for activating steering assistance and alerts at the same time.

NOTE

When the direction indicators/turn signals are activated, the Lane Keeping Aid does not provide any warning or intervene with steering.

WARNING

- The function is supplementary driver support intended to facilitate driving and help make it safer – it cannot handle all situations in all traffic, weather and road conditions.
- The driver is advised to read all sections in the Owner's Manual about this function to learn of its limitations, which the driver must be aware of before using the function.
- Driver support functions are not a substitute for the driver's attention and judgment. The driver is always responsible for ensuring the vehicle is driven in a safe manner, at the appropriate speed, with an appropriate distance to other vehicles, and in accordance with current traffic rules and regulations.

◀ Lane Keeping Aid does not intervene

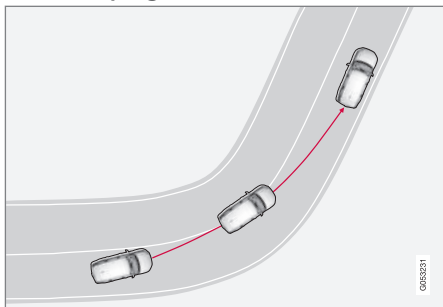

Lane Keeping Aid does not intervene in sharp inside curves.

In certain cases, such as when a turn signal is used or when "straightening out" an inside curve, Lane Keeping Aid will not provide steering assistance or alerts.

Hands on the steering wheel

Steering assistance with Lane Keeping Aid only functions if the driver's hands are on the steering wheel, which the system continuously monitors.



If the driver's hands are not on the steering wheel, an audible signal will be given and a message will instruct the driver to actively steer the vehicle:

- **Lane Keeping Aid – Apply steering**

If the driver does not begin to steer the vehicle, the function will go into standby mode and this message will be displayed:

- **Lane Keeping Aid – Standby until steering applied**

The function will then be unavailable until the driver begins actively steering the vehicle again.

Related information

- Driver support systems (p. 268)
- Activating or deactivating Lane Keeping Aid (p. 316)
- Lane Keeping Aid limitations (p. 317)
- Lane Keeping Aid symbols and messages (p. 318)

Activating or deactivating Lane Keeping Aid

The Lane Keeping Aid (LKA⁷⁰) function is optional – the driver can choose to have the function activated or deactivated.



Activate or deactivate the function using this button in the center display's Function view.

- GREEN button indicator light – the function is activated.
- GRAY button indicator light – the function is deactivated.

Related information

- Lane Keeping Aid (p. 314)
- Selecting type of assistance for Lane Keeping Aid (p. 317)
- Lane Keeping Aid limitations (p. 317)

Selecting type of assistance for Lane Keeping Aid

The driver can determine what types of assistance Lane Keeping Aid (LKA⁷¹) should provide if the vehicle veers from its lane.

1. Select **Settings** → **My Car** → **IntelliSafe** in the center display's Top view.
2. Under **Lane Keeping Aid Mode**, select what assistance the function should provide:
 - **Assist** the driver will receive steering assistance but no warning.
 - **Warning** – the driver is only warned through vibrations in the steering wheel.
 - **Both** – the driver receives steering assistance and a warning through vibrations in the steering wheel.

Related information

- Lane Keeping Aid (p. 314)

Lane Keeping Aid limitations

In certain demanding driving conditions, Lane Keeping Aid (LKA⁷²) may not be able to properly assist the driver. In these situations, it is recommended that the function be deactivated.

Examples of such situations include:

- road work
- winter driving conditions
- poor road surfaces
- a very sporty driving style
- bad weather with reduced visibility
- roads with indistinct or no lane markings
- sharp edges or lines other than the lane's side markings
- when speed-dependent power steering wheel resistance is working at reduced power – e.g. during cooling due to overheating.

The function cannot detect barriers, railings or similar obstacles at the side of the lane.

NOTE

The function uses the vehicle's camera and radar sensor, which has certain general limitations.

Related information

- Lane Keeping Aid (p. 314)
- Speed-dependent steering wheel resistance (p. 268)
- Camera/radar sensor limitations (p. 381)

⁷⁰ Lane Keeping Aid



⁷¹ Lane Keeping Aid

⁷² Lane Keeping Aid



Lane Keeping Aid symbols and messages

A number of symbols and messages related to Lane Keeping Aid (LKA⁷³) may be displayed in the instrument panel. Several examples are provided below.

played in the instrument panel. Several examples are provided below.

Symbol	Message	Meaning
	Driver support system Reduced functionality Service required	The system is not functioning as intended. Contact a workshop ^A .
	Windscreen sensor Sensor blocked, see Owner's manual	The camera's ability to detect the lane in front of the vehicle is reduced.

⁷³ Lane Keeping Aid

Symbol	Message	Meaning
	Lane Keeping Aid Apply steering	LKA's steering assistance is disabled when the driver's hands are not on the wheel. Follow the instructions and steer the vehicle.
	Lane Keeping Aid Standby until steering applied	LKA will go into standby mode until the driver begins steering the vehicle again.

^A An authorized Volvo workshop is recommended.

A text message can be erased by briefly pressing the  button in the center of the right-side steering wheel keypad.

If a message cannot be erased, contact a workshop^A.

Related information

- Lane Keeping Aid (p. 314)
- Lane Keeping Aid display (p. 320)
- Lane Keeping Aid limitations (p. 317)

Lane Keeping Aid display

Lane Keeping Aid (LKA⁷⁴) uses symbols in the instrument panel for various situations.



Some examples of symbols and descriptions of the situations in which they might appear are provided below.

Available



Available – the marker lines in the symbol are WHITE.

Lane Keeping Aid is able to detect one or both of the traffic lane's side marker lines.

Unavailable

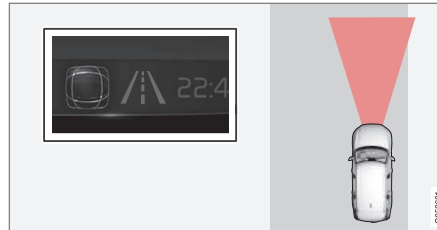

Unavailable – the marker lines in the symbol are GRAY.

Lane Keeping Aid is unable to detect the lane marker lines, the vehicle's speed is too low or the road is too narrow.

Steering/warning indicator



Steering/warning – the marker lines in the symbol are COLORED.

Indicates that the Lane Keeping Aid system is alerting the driver and/or attempting to steer the vehicle back into the lane.

Related information

- Lane Keeping Aid (p. 314)
- Lane Keeping Aid limitations (p. 317)

⁷⁴ Lane Keeping Aid

City Safety™

City Safety⁷⁵ can alert the driver with light, sound and pulsations in the brake pedal to help the driver detect pedestrians, cyclists, large animals and vehicles.

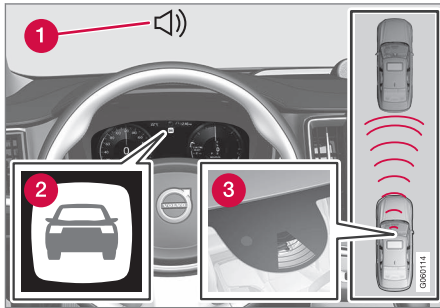

Function overview

- 1 Audible signal at risk of collision
- 2 Collision warning symbol
- 3 Camera/radar sensor distance monitoring

The function can help the driver avoid a collision in e.g. stop-and-go traffic, when changes in the traffic ahead and driver distraction could lead to an incident. City Safety activates a brief, forceful braking in an attempt to stop your vehicle immediately behind the vehicle or object ahead.

The function assists the driver by automatically applying the brakes if there is an imminent risk of a collision and the driver does not react in time by braking and/or steering away.

City Safety is activated in situations in which the driver should have applied the brakes much earlier, which means that the system will not be able to assist the driver in all situations. The function is designed to be activated as late as possible to help avoid unnecessary intervention. Automatic braking will only be applied after or during a collision warning.

Normally, the occupants of the vehicle will not be aware of City Safety except when the system intervenes when a collision is imminent.

WARNING

- The function is supplementary driver support intended to facilitate driving and help make it safer – it cannot handle all situations in all traffic, weather and road conditions.
- The driver is advised to read all sections in the Owner's Manual about this function to learn of its limitations, which the driver must be aware of before using the function.
- Driver support functions are not a substitute for the driver's attention and judgment. The driver is always responsible for ensuring the vehicle is driven in a safe manner, at the appropriate speed, with an appropriate distance to other vehicles, and in accordance with current traffic rules and regulations.

Related information

- Driver support systems (p. 268)
- City Safety sub-functions (p. 322)
- Setting a warning distance for City Safety (p. 324)
- Detecting obstacles with City Safety (p. 325)

⁷⁵ This function is not available on all markets.

- City Safety braking for oncoming vehicles (p. 330)
- Automatic braking during delayed evasive maneuvers with City Safety (p. 329)
- City Safety in crossing traffic (p. 327)
- City Safety steering assistance for evasive maneuver (p. 328)
- City Safety limitations (p. 331)
- City Safety messages (p. 334)

City Safety sub-functions

City Safety⁷⁶ can help prevent a collision or lower the vehicle's speed at the point of impact. The function consists of several sub-functions.

Ability to reduce speed

If the difference in speed between your vehicle and the obstacle is greater than the speeds specified below, the City Safety auto-brake function cannot prevent a collision, but it can help mitigate its effects.

Vehicles

City Safety can help prevent a collision with a vehicle ahead by reducing your vehicle's speed by up to 60 km/h (37 mph).

Cyclists

City Safety can help prevent a collision with a cyclist ahead by reducing your vehicle's speed by up to 50 km/h (30 mph).

Pedestrians

City Safety can help prevent a collision with a pedestrian ahead by reducing your vehicle's speed by up to 45 km/h (28 mph).

Large animals

If there is a risk of colliding with a large animal, City Safety can help reduce your vehicle's speed by up to 15 km/h (9 mph).

The braking function for large animals is primarily intended to mitigate the force of a collision at higher speeds. Braking is most effective at speeds above 70 km/h (43 mph) and less effective at lower speeds.

City Safety steps

City Safety carries out three steps in the following order:

1. Collision warning
2. Brake assistance
3. Auto-brake

⁷⁶ This function is not available on all markets.

1 - Collision warning

The driver is first alerted to the risk of an imminent collision.

In vehicles equipped with a head-up display*, a flashing warning symbol will be displayed on the windshield.



Collision warning symbol on the windshield

i NOTE

Visual warnings on the windshield may be difficult to notice in cases of strong sunlight, reflections, extreme light contrasts, or if the driver is wearing sunglasses or is not looking straight ahead.

City Safety can detect pedestrians, cyclists or vehicles that are stationary, are moving in the same direction as your vehicle and are ahead of your vehicle. City Safety can also detect

pedestrians, cyclists or large animals that are crossing the road in front of your vehicle.

If there is a risk of a collision with a pedestrian, large animal, cyclist or another vehicle, the driver will be alerted with light, sound and pulsations in the brake pedal. At lower speeds, during hard braking or if the accelerator pedal is pressed, the brake pedal pulsation warning will not be given. The intensity of the brake pedal pulsations varies according to the vehicle's speed.

2 - Brake assistance

If the risk of a collision increases after the collision warning, brake support will be activated.

If the system determines that the pressure the driver is exerting on the brake pedal is insufficient to prevent the collision, brake support will increase pressure.

3 - Auto-brake

The automatic braking function is activated at the last moment.

If the driver has not taken evasive action by this stage and a collision is imminent, the automatic braking function will be triggered. This occurs whether or not the driver is pressing the brake pedal. Full braking force will be applied to reduce the speed at impact or reduced braking effect will be applied if this is sufficient to avoid the collision.

The seat belt tensioner may be activated when the automatic braking function is triggered.

In certain situations, auto-braking may begin with a limited braking force before applying full braking force.

If City Safety has prevented a collision, the vehicle will be kept at a standstill until the driver takes action. If the vehicle has slowed to avoid colliding with a slower-moving vehicle ahead, your speed will be reduced to that vehicle's speed.

Auto-braking can always be cancelled if the driver presses hard on the accelerator pedal.

i NOTE

When City Safety activates the brakes, the brake lights come on.

When City Safety applies the brakes, a text message will appear in the instrument panel to notify the driver that the function is/was activated.

⚠ WARNING

City Safety may not be used to change how the driver operates the vehicle. The driver must not only rely on City Safety to brake the vehicle.



◀◀ **Related information**

- City Safety™ (p. 321)
- City Safety in crossing traffic (p. 327)
- City Safety braking for oncoming vehicles (p. 330)
- City Safety limitations (p. 331)
- Head-up display* (p. 140)
- Seat belt tensioners (p. 52)

Setting a warning distance for City Safety

City Safety⁷⁷ is always active, but the function's warning distance can be adjusted.

NOTE

The City Safety function cannot be deactivated. It is activated automatically each time the engine/electric motor is started.

The alert distance determines the sensitivity of the system and regulates the distance at which the light, sound and brake pulsations will be activated.

To select warning distance:

1. Select **Settings** → **My Car** → **IntelliSafe** in the center display's Top view.
2. Under **City Safety Warning**, tap **Late**, **Normal** or **Early** to set the desired warning distance.

If the driver feels that the **Early** setting is giving too many warnings or finds them irritating, the **Normal** or **Late** warning distance settings can be selected instead.

If the driver feels that the warnings are too frequent and distracting, the warning distance can be reduced. This will reduce the total

number of warnings, but it will also result in City Safety providing warnings at a later stage.

The **Late** warning distance setting should therefore only be used in exceptional cases, such as when a more dynamic driving style is preferred.

⁷⁷ This function is not available on all markets.

⚠ WARNING

- No automatic system can guarantee 100% correct function in all situations. You should therefore never test use of City Safety in the direction of people, animals or vehicles – this could lead to severe damage, serious personal injury or even death.
- City Safety warns the driver if there is a risk of collision, but the function cannot reduce the driver's reaction time.
- Even if the warning distance has been set to **Early**, warnings may be perceived as late in certain situations – e.g. when there are large speed differences or if the vehicle ahead suddenly brakes heavily.
- With the warning distance set to **Early**, warnings come further in advance. This may cause the warnings to come more frequently than with warning distance **Normal**, but is recommended since it can make City Safety more effective.

Related information

- City Safety™ (p. 321)
- City Safety limitations (p. 331)
- Rear Collision Warning* (p. 341)

Detecting obstacles with City Safety

City Safety⁷⁸ can help the driver detect other vehicles, cyclists, large animals and pedestrians.

Vehicles

City Safety can detect most vehicles that are stationary or are moving in the same direction as your vehicle. In some cases, it can also detect oncoming vehicles and crossing traffic.

For City Safety to be able to detect a vehicle in the dark, its headlights and taillights must be on and clearly visible.

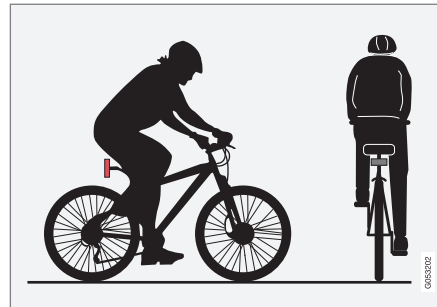
Cyclists

Examples of what City Safety would interpret to be a cyclist: clear body and bicycle shapes.

For good performance, the system's function for cyclist detection needs the clearest possible information about the contours of the bicycle and of the cyclist's head, arm, shoulders, legs, torso and lower body in combination with normal human movements.

If large portions of the cyclist's body or the bicycle itself are not visible to the function's camera, it will not be able to detect a cyclist.

The system can only detect adult cyclists riding on bicycles intended for adults.

⚠ WARNING

City Safety is supplementary driver support, but it cannot detect all cyclists in all situations and, for example, cannot see:

- partially obscured cyclists.
- cyclists if the contrast to the cyclist's background is poor.
- cyclists in clothing that hides their body contour.
- bikes loaded with large objects.

Warnings and brake interventions may occur late or not at all. The driver is always responsible for ensuring that the vehicle is driven correctly and with a safety distance suitable for the speed.

⁷⁸ This function is not available on all markets.

◀ Pedestrians

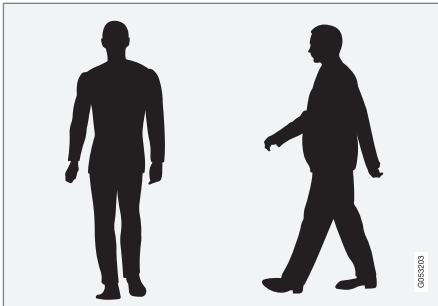

Examples of what the system considers to be a pedestrian: clear body contours.

For good performance, the system's function for pedestrian detection needs the clearest possible information about the contours of the pedestrian's head, arm, shoulders, legs, torso and lower body in combination with normal human movements.

In order to detect a pedestrian, there must be a contrast to the background, which could depend on clothing, weather conditions, etc. If there is little contrast, the person may be detected late or not at all, which may result in a delayed reaction from the system or no reaction at all.

City Safety can detect pedestrians even in dark conditions if they are illuminated by the vehicle's headlights.

⚠ WARNING

City Safety is supplementary driver support, but it cannot detect all pedestrians in all situations and, for example, cannot see:

- partially obscured pedestrians, people in clothing that hides their body contour or pedestrians shorter than 80 cm (32 in.).
- pedestrians if the contrast to the pedestrian's background is poor.
- pedestrians who are carrying large objects.

Warnings and brake interventions may occur late or not at all. The driver is always responsible for ensuring that the vehicle is driven correctly and with a safety distance suitable for the speed.

Large animals

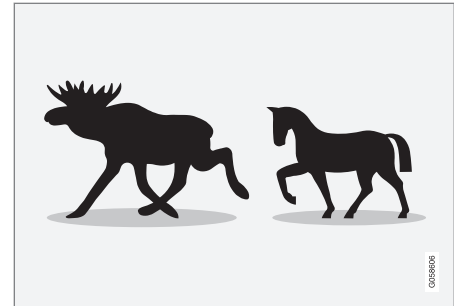

Examples of what City Safety would interpret as a large animal: stationary or moving slowly and with clear body contours.

For good performance, the system's function for detecting large animals (e.g. moose, horses, etc.) needs the clearest possible information about body contours. This entails being able to detect the animal straight from the side in combination with normal movements for that animal.

If parts of the animal's body are not visible to the function's camera, the system will not be able to detect the animal.

City Safety can detect large animals even in dark conditions if they are illuminated by the vehicle's headlights.

⚠ WARNING

City Safety is supplementary driver support, but it cannot detect all large animals in all situations and, for example, cannot see:

- partially obscured larger animals.
- larger animals seen from the front or from behind.
- running or fast moving larger animals.
- larger animals if the contrast to the animal's background is poor.
- smaller animals such as cats and dogs.

Warnings and brake interventions may occur late or not at all. The driver is always responsible for ensuring that the vehicle is driven correctly and with a safety distance suitable for the speed.

Related information

- City Safety™ (p. 321)
- City Safety limitations (p. 331)

City Safety in crossing traffic

City Safety⁷⁹ can assist the driver when turning into the path of an oncoming vehicle in an intersection.

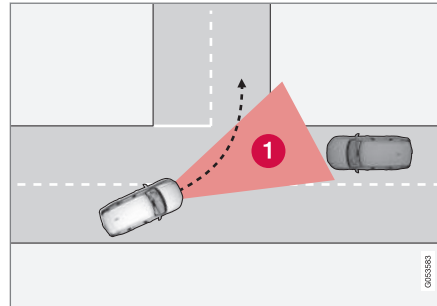

- 1 Sector in which City Safety can detect an oncoming vehicle in crossing traffic.

In order for City Safety to detect an oncoming vehicle in situations where there is a risk of a collision, that vehicle must be within the sector in which City Safety can analyze the situation.

The following criteria must also be met:

- your vehicle's speed must be at least 4 km/h (3 mph)
- your vehicle must be making a left turn
- the oncoming vehicle's headlights must be on

⁷⁹ This function is not available on all markets.

Related information

- City Safety™ (p. 321)
- City Safety limitations (p. 331)

Limitations of City Safety in crossing traffic

In certain situations, it may be difficult for City Safety to help the driver avoid a collision with crossing traffic.

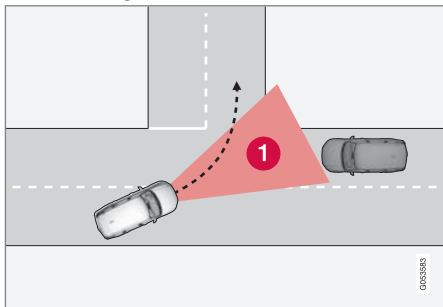

For example:

- On slippery roads when Electronic Stability Control (ESC) is actively operating.
- If an approaching vehicle is detected at a late stage.
- If the oncoming vehicle is partially obstructed by another vehicle or object.
- If the oncoming vehicle's headlights are off.
- If the oncoming vehicle is moving erratically and e.g. suddenly changes lanes at a late stage.

i NOTE

The function uses the vehicle's camera and radar sensor, which has certain general limitations.

Related information

- City Safety in crossing traffic (p. 327)
- City Safety limitations (p. 331)
- Camera/radar sensor limitations (p. 381)

City Safety steering assistance for evasive maneuver

City Safety steering assistance can help the driver steer away from a vehicle/obstacle when it is not possible to avoid a collision by braking alone. City Safety steering assistance is always activated and cannot be switched off.

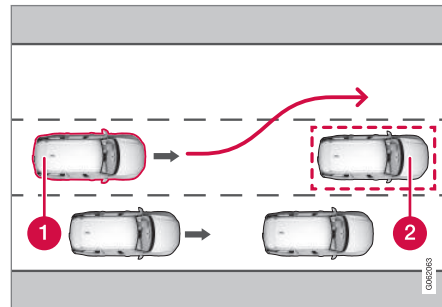

- 1** Your vehicle swerves away
- 2** Slow-moving/stationary vehicle or obstacle.

City Safety helps provide assistance by strengthening the driver's steering movements, but only if the driver has begun evasive action and the system detects that the driver's steering movements are not sufficient to avoid a collision.

The brake system is used simultaneously to further strengthen steering movements. The

function also helps stabilize the vehicle after it has passed the obstacle.

City Safety steering assistance can detect:

- vehicles
- cyclists
- pedestrians
- large animals

Related information

- City Safety™ (p. 321)
- City Safety steering assistance limitations during evasive maneuvers (p. 329)
- City Safety limitations (p. 331)

City Safety steering assistance limitations during evasive maneuvers

City Safety steering assistance may have limited functionality in certain situations and not intervene, e.g.:

- at speeds outside the range of 50-100 km/h (30-62 mph)
- if the driver does not take evasive action
- if speed-dependent power steering wheel resistance is working at reduced power – e.g. during cooling due to overheating.

NOTE

The function uses the vehicle's camera and radar sensor, which has certain general limitations.

Related information

- City Safety steering assistance for evasive maneuver (p. 328)
- City Safety limitations (p. 331)
- Speed-dependent steering wheel resistance (p. 268)
- Camera/radar sensor limitations (p. 381)

Automatic braking during delayed evasive maneuvers with City Safety

City Safety⁸⁰ can assist the driver by automatically braking the vehicle when it is not possible to avoid a collision by steering alone. City Safety assists the driver by periodically attempting to predict possible "escape routes" to the sides of the vehicle in the event a slow-moving or stationary vehicle were to be detected at a late stage.

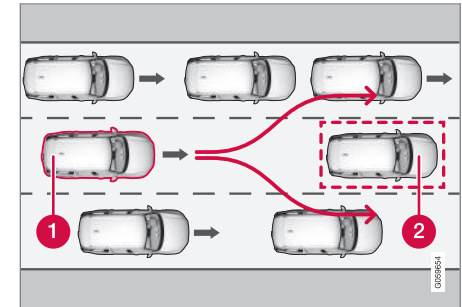

Your vehicle (1) cannot detect any potential escape routes for veering away from the vehicle ahead (2) and may therefore apply the brakes at an earlier stage.

- 1 Own vehicle
- 2 Slow-moving/stationary vehicles

⁸⁰ This function is not available on all markets.

- City Safety will not intervene to automatically apply the brakes if it is possible for the driver to avoid a collision by steering the vehicle.

However, if City Safety determines that an evasive maneuver would not be possible due to traffic in the adjacent lane(s), the function can assist the driver by automatically starting to apply the brakes at an earlier stage.

Related information

- City Safety™ (p. 321)
- City Safety limitations (p. 331)

City Safety braking for oncoming vehicles

City Safety can help you apply the brakes for an oncoming vehicle in your lane.

If an oncoming vehicle veers into your lane and a collision is unavoidable, City Safety can help reduce your vehicle's speed to attempt to mitigate the force of the collision.

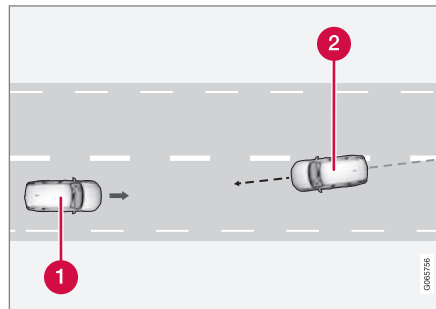

- 1 Own vehicle
- 2 Oncoming vehicles

The following criteria must be met for the function to work:

- your vehicle's speed must be above 4 km/h (3 mph)
- the road must be straight

- your lane must have clear side lane markings
- your vehicle must be positioned straight in your lane
- the oncoming vehicle must be positioned within your vehicle's lane markings
- the oncoming vehicle's headlights must be on
- the function can only handle “front-to-front” collisions
- the function can only detect vehicles with four wheels.

WARNING

Warnings and brake interventions due to an imminent collision with an oncoming vehicle always come very late.

Related information

- City Safety™ (p. 321)
- City Safety limitations (p. 331)

City Safety limitations

City Safety⁸¹ functionality may be reduced in certain situations.

Surroundings

Low objects

Hanging objects, such as flags for overhanging loads or accessories such as auxiliary lights or front protective grids that extend beyond the height of the hood, may limit City Safety functionality.

Slippery road conditions

The extended braking distance on slippery roads may reduce City Safety's capacity to help avoid a collision. In these types of situations, the Anti-lock Braking System and Electronic Stability Control (ESC⁸²) are designed for optimal braking power with maintained stability.

Backlighting

The visual warning signal in the windshield may be difficult to detect in bright sunlight, if there are reflections, or if the driver is wearing sunglasses or not looking straight ahead.

Heat

If the temperature in the passenger compartment is high due to e.g. bright sunlight, the visual warning signal in the windshield may be temporarily disabled.

Camera and radar sensor's field of vision

The camera's field of vision is limited and in certain situations, it may be unable to detect pedestrians, large animals, cyclists or vehicles, or it may detect them later than expected.

Vehicles that are dirty may be detected later than clean vehicles, and in dark conditions, motorcycles may be detected late or not at all.

If a text message displayed in the instrument panel indicates that the camera or radar sensor is obstructed, it may be difficult for City Safety to detect pedestrians, large animals, cyclists, vehicles or lane markings in front of the vehicle. City Safety functionality may therefore be reduced.

Text messages may not be displayed for all situations in which the windshield sensors are blocked. The driver must therefore always keep the windshield in front of the camera/radar sensor clean.

CAUTION

Only a workshop may perform maintenance on driver support components – an authorized Volvo workshop is recommended.

Driver intervention

Backing up

City Safety is temporarily deactivated when the vehicle is backing up.

Low speed

City Safety is not activated at very low speeds under 4 km/h (3 mph). The system will therefore not intervene in situations in which your vehicle is approaching another vehicle very slowly, such as when parking.

Active driver

Action by the driver always has priority. City Safety will therefore not react or will react at a later stage with a warning or intervention in situations in which the driver is clearly steering and operating the accelerator pedal, even if a collision is unavoidable.

An active and aware driving style may therefore delay collision warnings and intervention in order to minimize unnecessary warnings.

⁸¹ This function is not available on all markets.

⁸² Electronic Stability Control

« Important warnings

WARNING

The driver support system only issues a warning for obstacles detected by its radar sensor – thus, a warning may come after a delay or not at all.

- Never wait for a warning or assistance. Apply the brakes when necessary.

WARNING

- Warnings and brake interventions can be triggered late or not at all if the traffic situation or external influences prevent the camera and radar unit from properly detecting pedestrians, cyclists, large animals or vehicles ahead of the vehicle.
- To be able to detect vehicles at night, its front and rear lights must work and illuminate clearly.
- The camera and radar unit have a limited range for pedestrians and cyclists – the system can provide effective warnings and brake interventions if the relative speed is lower than 50 km/h (30 mph). For stationary or slow-moving vehicles, warnings and brake interventions are effective at vehicle speeds of up to 70 km/h (43 mph). Speed reduction for large animals is less than 15 km/h (9 mph) and can be achieved at vehicle speeds over 70 km/h (43 mph). At lower speeds, the warning and brake intervention for large animals is less effective.
- Warnings for stationary or slow-moving vehicles and large animals can be disengaged due to darkness or poor visibility.
- Warnings and brake interventions for pedestrians and cyclists are disengaged at vehicle speeds over 80 km/h (50 mph).
- Do not place, affix or mount anything on the inside or outside of the windshield, or in front of or around the camera and radar unit – this could disrupt camera-based functions.
- Objects, snow, ice or dirt in the area of the camera sensor can reduce the function, disengage it completely or give an improper function response.

⚠ WARNING

- The City Safety auto-brake function can prevent a collision or reduce collision speed, but to ensure full brake performance the driver should always depress the brake pedal – even when the car auto-brakes.
- The warning and steering assistance are only activated if there is a high risk of collision – you must therefore never wait for the collision warning or City Safety to intervene.
- Warnings and brake interventions for pedestrians and cyclists are disengaged at vehicle speeds over 80 km/h (50 mph).
- City Safety does not activate auto-braking intervention during heavy acceleration.

i NOTE

The function uses the vehicle's camera and radar sensor, which has certain general limitations.

Settings menu, your vehicle is not equipped with this function.

In the center display's Top view, tap:

- **Settings → My Car → IntelliSafe**

Related information

- City Safety™ (p. 321)
- Camera/radar sensor limitations (p. 381)

Market limitations

City Safety is not available in all countries. If City Safety is not shown in the center display's

City Safety messages

A number of messages related to City Safety may be displayed in the instrument panel.

Several examples are provided below.

Message	Meaning
City Safety Automatic intervention	When City Safety is braking or has activated the automatic braking function, one or more symbols may illuminate in the instrument panel and a text message may be displayed.
City Safety Reduced functionality Service required	The system is not functioning as intended. Contact a workshop ^A .

^A An authorized Volvo workshop is recommended.

A text message can be erased by briefly pressing the  button in the center of the right-side steering wheel keypad.

If a message cannot be erased, contact a workshop^A.

Related information

- City Safety™ (p. 321)

Steering assistance at risk of collision

The **Collision avoidance** function can help the driver reduce the risk of the vehicle leaving its lane unintentionally and/or colliding with another vehicle or obstacle by actively steering the vehicle back into its lane and/or swerving.

The function consists of these subfunctions:

- Run-Off Mitigation with steering assistance
- Steering assistance during collision risks from oncoming traffic
- Steering assistance during collision risks from behind*

After the system has automatically intervened, this text message will appear in the instrument panel:

Collision avoidance – Automatic intervention

WARNING

- The function is supplementary driver support intended to facilitate driving and help make it safer – it cannot handle all situations in all traffic, weather and road conditions.
- The driver is advised to read all sections in the Owner's Manual about this function to learn of its limitations, which the driver must be aware of before using the function.
- Driver support functions are not a substitute for the driver's attention and judgment. The driver is always responsible for ensuring the vehicle is driven in a safe manner, at the appropriate speed, with an appropriate distance to other vehicles, and in accordance with current traffic rules and regulations.

NOTE

It is always the driver who must decide how much the vehicle should be in control – the vehicle can never take command.

Related information

- Driver support systems (p. 268)
- Activating or deactivating steering assistance during collision risks (p. 336)

- Run-Off Mitigation with steering assistance (p. 336)
- Steering assistance during collision risks from oncoming traffic (p. 337)
- Steering assistance during collision risks from behind* (p. 338)
- Steering assistance during collision risks limitations (p. 339)
- Symbols and messages for steering assistance during collision risks (p. 340)

Activating or deactivating steering assistance during collision risks

The steering assistance function is optional – the driver can choose to have it activated or deactivated.



Activate or deactivate the function using this button in the center display's Function view.

- GREEN button indicator light – the function is activated.
- GRAY button indicator light – the function is deactivated.

The function is automatically activated each time the engine is started⁸³.

i NOTE

When the **Collision avoidance** function is deactivated, all subfunctions of the following are deactivated:

- Steering assistance at risk of run-off
- Steering assistance at risk of head-on collision
- Steering assistance during collision risks from behind*

Although it is possible to deactivate the function, the driver is advised to keep it activated since it can help improve driving safety in most cases.

Related information

- Steering assistance at risk of collision (p. 335)
- Steering assistance during collision risks limitations (p. 339)

Run-Off Mitigation with steering assistance

Steering assistance has several sub-functions. Run-Off Mitigation with steering assistance can help the driver and reduce the risk of the vehicle inadvertently running off the road by actively steering the vehicle back onto the road.

This function has two activation levels for intervention:

- Steering assistance only
- Steering assistance with braking

Steering assistance only

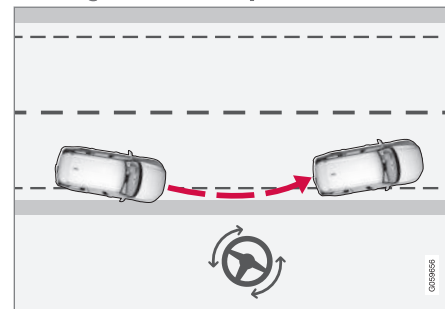

Intervention with steering assistance

⁸³ On some markets, the setting that was active when the engine was switched off is reactivated.

Steering assistance with braking

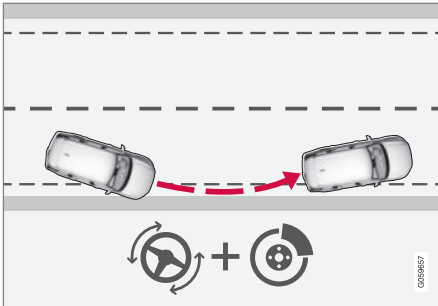

Intervention with steering assistance and braking

Braking intervention assists in situations where steering assistance alone is not sufficient. Braking force is automatically adapted according to the situation at the moment the vehicle begins to run off the road.

The function is active at speeds between 65-140 km/h (40-87 mph) on roads with clearly visible traffic lane markings/lines.

The system uses a camera to monitor the edges of the road and the painted side marker lines. If the vehicle is about to cross the edge of the road, the function will attempt to steer the vehicle back onto the road. If this is not sufficient to keep the vehicle on the road, the brakes will also be applied.

However, the function will **not** provide either steering assistance or braking if the turn signal

is used. The function will also not be activated if it detects that the driver is actively operating the vehicle.

Related information

- Steering assistance at risk of collision (p. 335)
- Steering assistance during collision risks limitations (p. 339)

Steering assistance during collision risks from oncoming traffic

Steering assistance has several sub-functions. Steering assistance during collision risks from oncoming traffic can help a distracted driver who has not noticed that the vehicle is veering out of the lane.

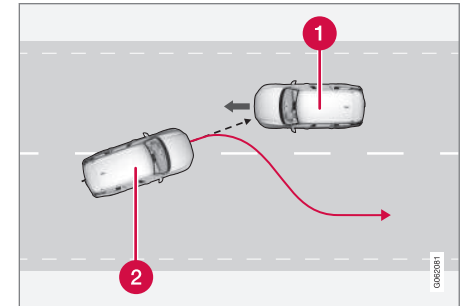

The function provides assistance by swerving your vehicle back into your own lane.

- 1 Oncoming vehicles
- 2 Own vehicle

When steering assistance is activated, collision warning for driver support will also be activated. However, the brake pedal pulsations that are part of collision warning will not be activated.

- ◀ The function is active at speeds between 60-140 km/h (37-87 mph) on roads with clearly visible traffic lane markings/lines.

If your vehicle is starting to veer from your own lane and a vehicle is approaching from the opposite direction, this function can help the driver steer the vehicle back into its own lane.

However, the function will **not** provide steering assistance if the turn signal is used. The function will also not be activated if it detects that the driver is actively operating the vehicle.

Related information

- Steering assistance at risk of collision (p. 335)
- Collision risk warning from driver support (p. 309)
- Steering assistance during collision risks limitations (p. 339)

Steering assistance during collision risks from behind*

Steering assistance has several sub-functions. If you become distracted and do not notice your vehicle starting to veer out of the lane while another vehicle is approaching from behind or is in your vehicle's blind spot, Steering assistance during collision risks from behind can help provide assistance.

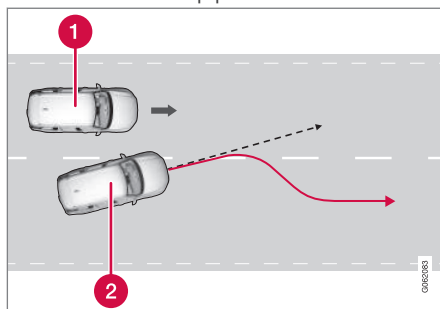

The function provides assistance by steering your vehicle back into your own lane.

- 1 Another vehicle in blind spot zone
- 2 Own vehicle

If your vehicle is beginning to veer out of your lane while another vehicle is in your blind spot or another vehicle is rapidly approaching in the

next lane, this function can help the driver steer the vehicle back into its own lane.

Even if the driver intentionally changes lanes using a turn signal without noticing another vehicle approaching, the function can provide assistance.

The function is active at speeds between 60-140 km/h (37-87 mph) on roads with clearly visible traffic lane markings/lines.

The lights in the door mirrors will flash while steering assistance is being provided, whether or not the BLIS⁸⁴ function is activated. An audible signal will also sound.

Related information

- Steering assistance at risk of collision (p. 335)
- BLIS* (p. 342)
- Steering assistance during collision risks limitations (p. 339)

⁸⁴ Blind Spot Information

Steering assistance during collision risks limitations

The function may have limited functionality in certain situations and not intervene, e.g.:

- for smaller vehicles such as motorcycles
- if more than half of your vehicle has moved into the adjacent lane
- on roads/lanes with indistinct or no side lane markings
- outside the speed range 60-140 km/h (37-87 mph)
- when speed-dependent power steering wheel resistance is working at reduced power – e.g. during cooling due to overheating.

Functionality may also be reduced in other situations, such as:

- road work
- winter driving conditions
- narrow roads
- poor road surfaces
- a very sporty driving style
- bad weather with reduced visibility.

In these demanding driving conditions, the function may not be able to properly assist the driver. In these situations, it is recommended that it is turned off.

NOTE

The function uses the vehicle's camera and radar sensor, which has certain general limitations.



Related information

- Steering assistance at risk of collision (p. 335)
- Run-Off Mitigation with steering assistance (p. 336)
- Steering assistance during collision risks from oncoming traffic (p. 337)
- Steering assistance during collision risks from behind* (p. 338)

Symbols and messages for steering assistance during collision risks

A number of symbols and messages related to steering assistance may be displayed in

the instrument panel. Several examples are provided below.

Symbol	Message	Meaning
	Collision avoidance Automatic intervention	When the function is activated, a message will appear to alert the driver.
	Windscreen sensor Sensor blocked, see Owner's manual	The camera's ability to detect the lane in front of the vehicle is reduced.

A text message can be erased by briefly pressing the  button in the center of the right-side steering wheel keypad.

If the message persists: Contact a workshop – an authorized Volvo workshop is recommended.

Related information

- Steering assistance at risk of collision (p. 335)
- Steering assistance during collision risks limitations (p. 339)

Rear Collision Warning*⁸⁵

The Rear Collision Warning⁸⁶ (RCW) function can help the driver avoid rear-end collisions from vehicles approaching from behind.

The function can alert drivers of following vehicles of the risk of a collision by rapidly flashing the turn signals.

If, at a speed below 30 km/h (20 mph), the function detects that the vehicle is in danger of being hit from behind, the seat belt tensioners may tension the front seat belts. The Whiplash Protection System will also be activated in a collision.

Immediately before a collision from behind, the function may also activate the brakes in order to reduce the forward acceleration of the vehicle during the collision. However, the brakes will only be applied if your vehicle is stationary. The brakes will be immediately released if the accelerator pedal is depressed.

The function is automatically activated each time the engine is started.

WARNING

- The function is supplementary driver support intended to facilitate driving and help make it safer – it cannot handle all situations in all traffic, weather and road conditions.
- The driver is advised to read all sections in the Owner's Manual about this function to learn of its limitations, which the driver must be aware of before using the function.
- Driver support functions are not a substitute for the driver's attention and judgment. The driver is always responsible for ensuring the vehicle is driven in a safe manner, at the appropriate speed, with an appropriate distance to other vehicles, and in accordance with current traffic rules and regulations.

Related information

- Driver support systems (p. 268)
- Rear Collision Warning* limitations (p. 341)
- Whiplash Protection System (p. 48)

Rear Collision Warning*⁸⁷ limitations

In some situations, it may be difficult for Rear Collision Warning (RCW) to warn the driver of a collision risk.

This may be the case if:

- the vehicle approaching from the rear is detected at a late stage
- the vehicle approaching from the rear changes lanes at a late stage
- a trailer, bicycle holder or similar is connected to the vehicle's electrical system - the function will then be automatically deactivated.

NOTE

In certain markets RCW does **not** warn with the direction indicators due to local traffic regulations – in such cases, that part of the function is deactivated.

NOTE

The function uses the vehicle's camera and radar sensor, which has certain general limitations.

⁸⁵ Warning of collision from the rear.

⁸⁶ This function is not available on all markets.

⁸⁷ Warning of collision from the rear.

◀◀ **Related information**

- Rear Collision Warning* (p. 341)
- Setting a warning distance for City Safety (p. 324)
- Camera/radar sensor limitations (p. 381)

BLIS*

The BLIS⁸⁸ function is designed to help provide assistance in heavy traffic with several lanes moving in the same direction by helping the driver to detect the presence of vehicles in the "blind spot" area behind and to the side of the vehicle.



Location of BLIS indicator light

BLIS is a driver support system designed to alert the driver of:

- vehicles in your "blind spot"
- vehicles approaching rapidly in adjacent lanes.

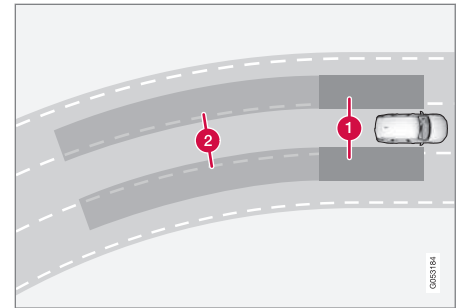

BLIS overview

- 1 Blind spot zone
- 2 Rapidly approaching vehicle zone

The system is designed to react to:

- vehicles passing your vehicle
- vehicles that are rapidly approaching your vehicle from behind.

When BLIS detects a vehicle in zone 1 or a rapidly approaching vehicle in zone 2, an indicator light will illuminate in the relevant rear-view mirror and glow steadily. If the driver then uses the turn signal on the side in which the warning has been given, the indicator light will become brighter and begin flashing.

BLIS is active when your vehicle is traveling at a speed over 10 km/h (6 mph).

⁸⁸ Blind Spot Information

If a passing vehicle's speed is more than 15 km/h (9 mph) faster than your vehicle, BLIS will not react.

i NOTE

The light illuminates on the side of the vehicle where the system has detected the vehicle. If the vehicle is passed on both sides simultaneously, both lights come on.

⚠ WARNING

- The function is supplementary driver support intended to facilitate driving and help make it safer – it cannot handle all situations in all traffic, weather and road conditions.
- The driver is advised to read all sections in the Owner's Manual about this function to learn of its limitations, which the driver must be aware of before using the function.
- Driver support functions are not a substitute for the driver's attention and judgment. The driver is always responsible for ensuring the vehicle is driven in a safe manner, at the appropriate speed, with an appropriate distance to other vehicles, and in accordance with current traffic rules and regulations.

Related information

- Driver support systems (p. 268)
- Activating or deactivating BLIS (p. 343)
- BLIS limitations (p. 344)
- BLIS messages (p. 345)

Activating or deactivating BLIS

The BLIS⁸⁹ function can be activated or deactivated.



Activate or deactivate the function using this button in the center display's Function view.

- GREEN button indicator light – the function is activated.
- GRAY button indicator light – the function is deactivated.

If BLIS is activated when the engine is started, the indicator lights in the rearview mirrors will flash once.

If BLIS is deactivated when the engine is turned off, it will remain off the next time the engine is started and the indicator lights will not illuminate.

Related information

- BLIS* (p. 342)
- BLIS limitations (p. 344)

⁸⁹ Blind Spot Information

BLIS limitations

BLIS⁹⁰ functionality may be reduced in certain situations.

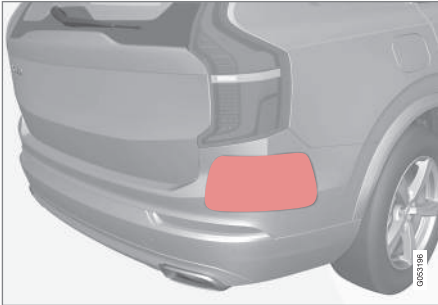

Keep the marked area clean (on both the left and right sides of the vehicle)⁹¹.

Examples of limitations:

- Dirt, ice and snow covering the sensors may reduce functionality and prevent the system from providing warnings.
- The BLIS function is automatically deactivated if a trailer, bicycle holder or similar is connected to the vehicle's electrical system.
- For BLIS to function effectively, bicycle holders, luggage racks or similar should not be mounted on the vehicle's towbar.

⁹⁰ Blind Spot Information

⁹¹ Note: This illustration is general and details may vary depending on model.

WARNING

- BLIS does not work in sharp curves.
- BLIS does not work when the vehicle is being reversed.

NOTE

The function uses the vehicle's radar sensors, which have certain general limitations.

Related information

- BLIS* (p. 342)
- Camera/radar sensor limitations (p. 381)

BLIS messages

A number of messages related to BLIS⁹² may be displayed in the instrument panel. Several examples are provided below.

Message	Meaning
Blind spot sensor Service required	The system is not functioning as intended. Contact a workshop ^A .
Blind spot system off Trailer attached	BLIS and CTA ^B have been deactivated because a trailer has been connected to the vehicle's electrical system.

^A An authorized Volvo workshop is recommended.

^B Cross Traffic Alert*

A text message can be erased by briefly pressing the  button in the center of the right-side steering wheel keypad.

If a message cannot be erased, contact a workshop^A.

Related information

- BLIS* (p. 342)
- Cross Traffic Alert* (p. 350)

⁹² Blind Spot Information

Driver Alert Control

The Driver Alert Control (DAC) function is designed to help alert the driver to erratic behavior, e.g. if the driver is distracted or showing signs of fatigue.

The objective of the function is to detect slowly deteriorating driving behavior and is primarily intended to be used on major roads. The function is not intended for use in city traffic.

DAC is activated when the vehicle's speed exceeds 65 km/h (40 mph) and remains active as long as speeds are above 60 km/h (37 mph).

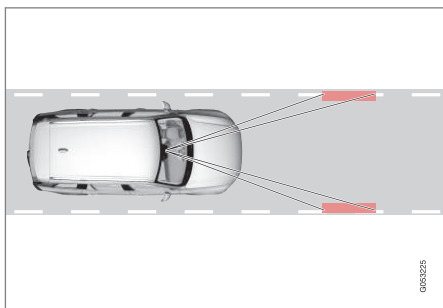

Driver Alert Control detects the vehicle's position in the traffic lane.

A camera monitors the traffic lane's marker lines and compares the direction of the road

with the driver's movements of the steering wheel.

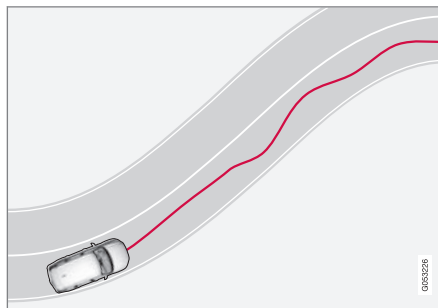

The vehicle is moving erratically in the lane.



If driving behavior becomes considerably erratic, the driver will be alerted by this symbol in the instrument panel, an audible signal and the message **Time for a**

break.

If the vehicle is equipped with Sensus Navigation* and the **Rest Stop Guidance** function is activated, suggestions will also be provided for suitable places to take a break.

The warning will be repeated after a short time if driving behavior does not improve.

WARNING

Driver Alert Control must not be used to extend a period of driving. The driver should plan in breaks at regular intervals and make sure they are well rested.

WARNING

An alarm from Driver Alert Control should be taken very seriously since a sleepy driver is often not aware of their own condition.

If the alarm sounds or you feel fatigued:

- Stop the vehicle safely as soon as possible and rest.

Studies have shown that it is just as dangerous to drive while tired as it is to drive under the influence of alcohol or other stimulants.

⚠ WARNING

- The function is supplementary driver support intended to facilitate driving and help make it safer – it cannot handle all situations in all traffic, weather and road conditions.
- The driver is advised to read all sections in the Owner's Manual about this function to learn of its limitations, which the driver must be aware of before using the function.
- Driver support functions are not a substitute for the driver's attention and judgment. The driver is always responsible for ensuring the vehicle is driven in a safe manner, at the appropriate speed, with an appropriate distance to other vehicles, and in accordance with current traffic rules and regulations.

Related information

- Driver support systems (p. 268)
- Activating or deactivating Driver Alert Control (p. 347)
- Selecting guidance to a rest area if the Driver Alert Control warning has been given (p. 347)
- Driver Alert Control limitations (p. 348)

Activating or deactivating Driver Alert Control

The Driver Alert Control (DAC) function can be activated or deactivated.

1. Tap **Settings** in the center display's Top view.
2. Select **My Car → IntelliSafe → Driver Alert**.
3. Select/deselect **Alertness Warning** to activate/deactivate the function.

Related information

- Driver Alert Control (p. 346)
- Driver Alert Control limitations (p. 348)

Selecting guidance to a rest area if the Driver Alert Control warning has been given

In vehicles equipped with Sensus Navigation*, the driver can activate a guide that can automatically suggest a suitable rest stop if the Driver Alert Control (DAC) warning is given.

The **Rest Stop Guidance** function can be switched on or off.

1. Tap **Settings** in the center display's Top view.
2. Select **My Car → IntelliSafe → Driver Alert**.
3. Select/deselect **Rest Stop Guidance** to activate/deactivate the function.

Related information

- Driver Alert Control (p. 346)
- Driver Alert Control limitations (p. 348)

Driver Alert Control limitations

Driver Alert Control (DAC) functionality may be reduced in certain situations.

In certain situations, the system may provide a warning even if it has not detected a change in driving behavior, e.g.:

- in strong crosswinds
- on grooved road surfaces.

⚠ WARNING

In certain cases, driving behavior might not be affected despite the driver's fatigue – when using the Pilot Assist* function – resulting in the driver not getting a warning from DAC.

It is therefore very important to always stop and take a break at the slightest sign of fatigue, regardless of whether the function has issued a warning or not.

i NOTE

The function uses the vehicle's camera and radar sensor, which has certain general limitations.

Related information

- Driver Alert Control (p. 346)
- Camera/radar sensor limitations (p. 381)

Distance Alert*⁹³

The Distance Alert function can help the driver become aware if the time interval to the vehicle in front is too short. The vehicle must be equipped with a head-up display* in order to display Distance Alert.



Symbol for Distance Alert on the windshield with head-up display

In vehicles equipped with a head-up display, a symbol will be displayed on the windshield as long as the time interval to the vehicle ahead is shorter than the set time interval. However, the **Show Driver Support** function must be activated under Settings in the vehicle's menu system.

Distance Alert is active at speeds above 30 km/h (20 mph) and only reacts for

vehicles ahead moving in the same direction as your vehicle. No distance information is provided for oncoming, slow-moving or stationary vehicles.

i NOTE

Visual warnings on the windshield may be difficult to notice in cases of strong sunlight, reflections, extreme light contrasts, or if the driver is wearing sunglasses or is not looking straight ahead.

i NOTE

Distance Alert is deactivated while Adaptive Cruise Control* or Pilot Assist* is active.

⚠ WARNING

Distance Alert only reacts if the time interval to the vehicle ahead is shorter than the preset value – vehicle speed is not affected.

⁹³ Distance Alert

⚠ WARNING

- The function is supplementary driver support intended to facilitate driving and help make it safer – it cannot handle all situations in all traffic, weather and road conditions.
- The driver is advised to read all sections in the Owner's Manual about this function to learn of its limitations, which the driver must be aware of before using the function.
- Driver support functions are not a substitute for the driver's attention and judgment. The driver is always responsible for ensuring the vehicle is driven in a safe manner, at the appropriate speed, with an appropriate distance to other vehicles, and in accordance with current traffic rules and regulations.

Related information

- Activating or deactivating Distance Alert (p. 349)
- Distance Alert limitations (p. 349)
- Setting time interval to the vehicle ahead (p. 312)
- Collision risk warning from driver support (p. 309)
- Head-up display* (p. 140)

Activating or deactivating Distance Alert⁹⁴

Distance Alert can be turned off. The function is only available in vehicles that can display information on the windshield with a head-up display*.



Activate or deactivate the function using this button in the center display's Function view.

- GREEN button indicator light – the function is activated.
- GRAY button indicator light – the function is deactivated.

Distance Alert is automatically activated each time the engine is started.

Related information

- Distance Alert* (p. 348)
- Distance Alert limitations (p. 349)

Distance Alert limitations⁹⁵

Distance Alert functionality may be reduced in certain situations. The function is only available in vehicles that can display information on the windshield with a head-up display*.

⚠ WARNING

- Detection ability may be affected by vehicle size, e.g. motorcycles, which can cause the warning light to come on at a shorter time interval than that set or cause the warning to be temporarily absent.
- Very high speeds can cause the light to come on at a shorter time interval than that set due to limitations in the range of the radar unit.

i NOTE

The function uses the vehicle's camera and radar sensor, which has certain general limitations.

Related information

- Distance Alert* (p. 348)
- Camera/radar sensor limitations (p. 381)
- Head-up display* (p. 140)

Cross Traffic Alert*⁹⁶

Cross Traffic Alert(CTA) is a supplementary driver support system to BLIS⁹⁷ that is intended to help the driver detect vehicles crossing behind the vehicle while backing up.

The **auto-brake** subfunction can help the driver stop the car if there is a risk of collision with an unobserved vehicle.

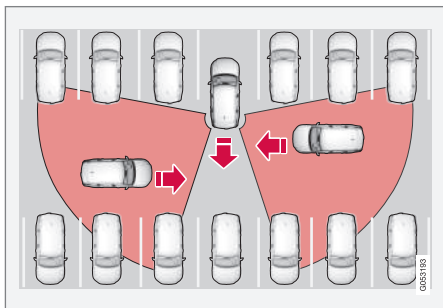

Examples of areas in which Cross Traffic Alert can help the driver detect obstacles while backing up.

The function is primarily designed to detect vehicles, but in certain cases can also detect pedestrians or smaller objects such as bicycles.

The function is only active when the vehicle is moving backward or reverse gear is engaged.

If the function detects that something is approaching your vehicle from the side:

- an audible signal will sound from either the left or right speaker, depending on which side of your vehicle the object is approaching from.
- an icon will illuminate in the **Park Assist System** graphic on the screen.
- an icon will appear in the Park Assist Camera's Top view.



Illuminated Cross Traffic Alert icon in the **Park Assist System** graphic on the screen.

If the driver does not pay attention to the warning from the function and a collision is unavoidable, the **auto brake** function will intervene to stop the vehicle and a text will be shown on the instrument panel to explain why the vehicle was braked.

WARNING

- The function is supplementary driver support intended to facilitate driving and help make it safer – it cannot handle all situations in all traffic, weather and road conditions.
- The driver is advised to read all sections in the Owner's Manual about this function to learn of its limitations, which the driver must be aware of before using the function.
- Driver support functions are not a substitute for the driver's attention and judgment. The driver is always responsible for ensuring the vehicle is driven in a safe manner, at the appropriate speed, with an appropriate distance to other vehicles, and in accordance with current traffic rules and regulations.

⁹⁴ Distance Alert

⁹⁵ Distance Alert

⁹⁶ Warning for crossing traffic when the vehicle is backing up.

⁹⁷ Blind Spot Information

Related information

- Driver support systems (p. 268)
- Activating or deactivating Cross Traffic Alert* (p. 351)
- Cross Traffic Alert* limitations (p. 351)
- Cross Traffic Alert* messages (p. 353)
- BLIS* (p. 342)
- Park Assist* (p. 354)

Activating or deactivating Cross Traffic Alert*⁹⁸

The driver can choose to deactivate the Cross Traffic Alert (CTA) function.



Activate or deactivate the function using this button in the center display's Function view.

- GREEN button indicator light – the function is activated.
- GRAY button indicator light – the function is deactivated.

The function is automatically activated each time the engine is started.

Related information

- Cross Traffic Alert* (p. 350)
- Cross Traffic Alert* limitations (p. 351)
- Cross Traffic Alert* messages (p. 353)

Cross Traffic Alert*⁹⁹ limitations

The Cross Traffic Alert (CTA) function with **auto brake** may have limited functionality in certain situations. Auto-brake is active at speeds under 15 km/h (9.3 mph).

WARNING

The **auto-brake** sub-function can only detect and apply the brakes for other moving vehicles – **not** for e.g. stationary obstacles, cyclists or pedestrians.

The function has certain limitations – the sensors, for example, cannot "see" through other parked vehicles or objects blocking the vehicle.

Below are a few examples of situations in which the function's field of vision may be initially limited and approaching vehicles may therefore not be detected until they are very close to your vehicle:

⁹⁸ Warning for crossing traffic when the vehicle is backing up.

⁹⁹ Warning for crossing traffic when the vehicle is backing up.

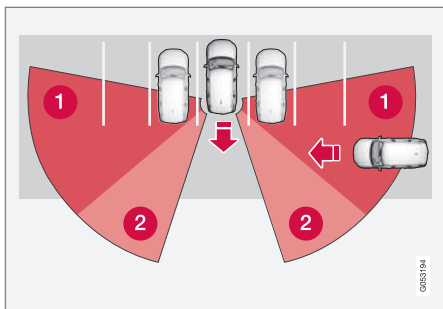

The vehicle is parked very far into a parking space.

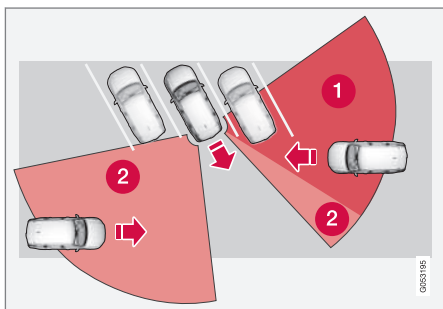

In a diagonal parking space, Cross Traffic Alert may be completely "blind" on one side of your vehicle.

- 1 Blind zone.
- 2 The function's field of vision.

However, as you back your vehicle slowly out of a parking space, CTA's field of vision

changes in relation to the obstructing vehicle/object and its blind zone is reduced.

Examples of further limitations

- The **auto brake** subfunction only detects vehicles in motion and may therefore **not** "see" and brake for e.g. stationary obstacles, a cyclists or a pedestrian.
- Dirt, ice and snow covering the sensors may reduce functionality and prevent the system from providing warnings.
- CTA is automatically deactivated if a trailer, bicycle holder or similar is connected to the vehicle's electrical system.
- For CTA to function effectively, bicycle holders, luggage racks or similar should not be mounted on the vehicle's towbar.

NOTE

The function uses the vehicle's radar sensors, which have certain general limitations.

Related information

- Cross Traffic Alert* (p. 350)
- Camera/radar sensor limitations (p. 381)

Cross Traffic Alert*¹⁰⁰ messages

A number of messages related to Cross Traffic Alert (CTA) may be displayed in the

instrument panel. Several examples are provided below.

Message	Meaning
Blind spot sensor Service required	The system is not functioning as intended. Contact a workshop ^A .
Blind spot system off Trailer attached	BLIS ^B and CTA have been deactivated because a trailer has been connected to the vehicle's electrical system.

^A An authorized Volvo workshop is recommended.

^B Blind Spot Information System

A text message can be erased by briefly pressing the  button in the center of the right-side steering wheel keypad.

If a message cannot be erased, contact a workshop^A.

Related information

- Cross Traffic Alert* (p. 350)
- BLIS* (p. 342)
- Cross Traffic Alert* limitations (p. 351)

¹⁰⁰Warning for crossing traffic when the vehicle is backing up.

Park Assist*

The Park Assist function (PAS¹⁰¹) uses sensors to help the driver when maneuvering in tight spaces by indicating distances to obstacles using audible signals and graphics in the center display.



Display view showing obstacle zones and sensor sectors.

The center display shows an overview of the vehicle in relation to objects that have been detected.

The marked sector indicates where the obstacle is located. The closer the vehicle symbol is to a marked sector forward/rearward, the closer the detected obstacle is to your vehicle.

The side sectors change color as the distance between the vehicle and an object decreases.

The audible signals will also speed up the closer the obstacle is to the vehicle. The volume of the audio system will be automatically lowered.

Audible signals for obstacles in front and to the sides of the vehicle are active when the vehicle is moving but will cease after the vehicle has been stationary for approx. 2 seconds. Audible signals for obstacles behind the vehicle will remain active even when the vehicle is stationary.

If a detected obstacle is within approx. 30 cm (1 ft) from the front or rear of the vehicle, the tone will become constant and the active sensor field closest to the vehicle symbol will be filled in.

At distances within approx. 25 cm (0.8 ft) from an obstacle to the sides of the vehicle, a rapid pulsing signal will be given and the active sector fields will change color from ORANGE to RED.

The volume of the Park Assist audible signals can be adjusted while the signal is being given using the **>||** knob or in the center display's Top view under **Settings**.

i NOTE

Besides in the sector closest to the vehicle symbol, audible warnings are only provided for objects located directly in the vehicle's path.

⚠ WARNING

- The function is supplementary driver support intended to facilitate driving and help make it safer – it cannot handle all situations in all traffic, weather and road conditions.
- The driver is advised to read all sections in the Owner's Manual about this function to learn of its limitations, which the driver must be aware of before using the function.
- Driver support functions are not a substitute for the driver's attention and judgment. The driver is always responsible for ensuring the vehicle is driven in a safe manner, at the appropriate speed, with an appropriate distance to other vehicles, and in accordance with current traffic rules and regulations.

¹⁰¹ Park Assist System

Related information

- Driver support systems (p. 268)
- Park Assist front, rear and sides* (p. 355)
- Activating or deactivating Park Assist* (p. 356)
- Park Assist symbols and messages (p. 358)
- Park Assist limitations (p. 357)

Park Assist front, rear and sides*

Park Assist (PAS¹⁰²) behaves differently depending on which part of the vehicle is approaching an obstacle.

Front camera

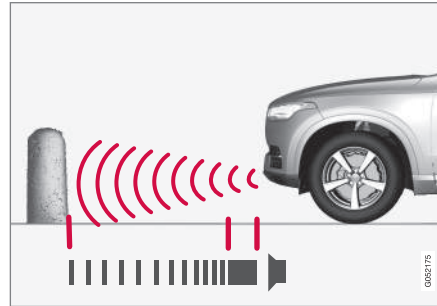

The warning signal has a continuous tone when the obstacle is less than approx. 30 cm (1 ft) from the vehicle.

The Park Assist system's front sensors are automatically activated when the engine is started. They are active at speeds below 10 km/h (6 mph).

The distance monitored extends approx. 80 cm (2.5 ft) in front of the vehicle.

i NOTE

The Park Assist system is deactivated when the parking brake is used or when **P** is selected on vehicles with automatic transmission.

i CAUTION

When installing auxiliary lights: Make sure these do not obscure the sensors – the auxiliary lights could be perceived as an obstacle.

Back

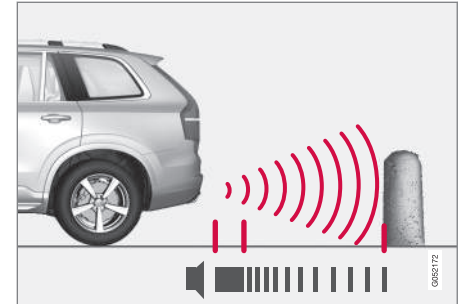

The warning signal has a continuous tone when the obstacle is less than approx. 30 cm (1 ft) from the vehicle.

- ◀◀ The rear sensors will be activated if the vehicle begins rolling backward or if reverse gear is engaged.

The distance monitored extends approx. 1.5 meters (5 ft) behind the vehicle.

The Park Assist system's rear sensors will be automatically deactivated if the vehicle is backing up with a trailer connected to the vehicle's electrical system.

i NOTE

When reversing with e.g. a trailer or bike carrier on the trailer hitch – without Volvo original trailer cables – the Parking Assist system may have to be turned off manually to prevent the sensors from reacting to these.

Side sensors

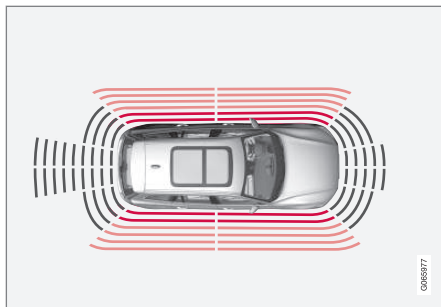

The warning signal will begin pulsating rapidly when the obstacle is less than approx. 25 cm (0.8 ft) from the vehicle.

Park Assist's side sensors are automatically activated when the engine is started. They are active at speeds below 10 km/h (6 mph).

The distance monitored is approx. 25 cm (0.8 ft) out from the sides.

The detection area of the side sensors increases significantly, however, when the steering angle of the front wheel increases and depending on the position of the steering wheel, obstacles up to approx. 90 cm (3 ft) diagonally behind or in front of the vehicle can be detected.

Related information

- Park Assist* (p. 354)
- Park Assist sensor field (p. 364)

Activating or deactivating Park Assist*

The Park Assist function (PAS¹⁰³) can be activated or deactivated.

Park Assist's front and side sensors are automatically activated when the engine is started. The rear sensors are activated if the vehicle is moving backward or reverse gear is engaged.



Activate or deactivate the function using this button in the center display's Function view.

- GREEN button indicator light – the function is activated.
- GRAY button indicator light – the function is deactivated.

In vehicles equipped with Park Assist Camera*, Park Assist can also be activated or deactivated from the relevant camera view.

Related information

- Park Assist* (p. 354)
- Park Assist limitations (p. 357)

Park Assist limitations

Park Assist (PAS¹⁰⁴) may not be able to detect all conditions in all situations and functionality may therefore be limited in certain cases.

The driver should be aware of the following limitations for Park Assist:

WARNING

- The parking sensors have dead/blind spots where objects cannot be detected.
- Pay particular attention to people and animals near the vehicle.
- Bear in mind that the front end of the vehicle may swing out towards oncoming traffic during the parking maneuver.

WARNING



Be extra cautious when reversing if this symbol is shown when a trailer, bike carrier or similar is attached and electrically connected to the vehicle.

The symbol indicates that the rear parking assist sensors are **deactivated** and will not warn of any obstacles.

CAUTION

Objects such as chains, thin and glossy poles or low obstacles may end up in the "signal shadow" and then go temporarily undetected by the sensors – the pulsating tone may then unexpectedly stop instead of becoming a constant tone as expected.

The sensors cannot detect high objects, such as protruding ramps.

- In such situations, pay extra attention and maneuver/drive the vehicle very slowly or stop the current parking maneuver – there may be a high risk of damage to the vehicle or other objects since information from the sensors is not always reliable in such situations.

CAUTION

In some circumstances, the Park Assist System may produce false warnings due to external sound sources with the same ultrasonic frequencies as those the system works with.

Examples of such sources are horns, wet tires on asphalt, pneumatic brakes, exhaust noise from motorcycles, etc.

NOTE

When a trailer hitch is configured with the vehicle electrical system, the trailer hitch protrusion is included when the function measures the distance to objects behind the vehicle.

Related information

- Park Assist* (p. 354)

103Park Assist System

104Park Assist System

Park Assist symbols and messages

Symbols and messages for the Park Assist system (PAS¹⁰⁵) may be displayed in the

instrument panel and/or the center display. Several examples are provided below.

Symbol	Message	Meaning
		The rear Park Assist sensors are turned off and no acoustic warnings for obstacles/objects will be provided.
	Park Assist System Sensors blocked, cleaning needed	One or more of the sensors are blocked. Check and clean/remove the obstacle as soon as possible.
	Park Assist System Unavailable Service required	The system is not functioning as intended. Contact a workshop ^A .

^A An authorized Volvo workshop is recommended.

A text message can be erased by briefly pressing the  button in the center of the right-side steering wheel keypad.

If a message cannot be erased, contact a workshop^A.

Related information

- Park Assist* (p. 354)
- Park Assist limitations (p. 357)

¹⁰⁵Park Assist System

Park Assist Camera*

The Park Assist Camera (PAC¹⁰⁶) can assist the driver when maneuvering in tight spaces by indicating obstacles using the camera screen and graphics in the center display. The Park Assist Camera is a support function that is automatically activated when reverse gear is engaged. It can also be started manually from the center display.



Example camera view.

- 1 **Zoom**¹⁰⁷ - zoom in/out
- 2 **360° view*** - activate/deactivate all cameras
- 3 **PAS**¹⁰⁸ – activates/deactivates Park Assist system sensors

- 4 **Lines** - activate/deactivate trajectory lines
- 5 **Towbar*** - activate/deactivate trajectory lines for towbar*¹⁰⁹
- 6 **CTA*** - activate/deactivate Cross Traffic Alert

Objects/obstacles may be closer to the vehicle than they appear on the display.

WARNING

- The parking sensors have dead/blind spots where objects cannot be detected.
- Pay particular attention to people and animals near the vehicle.
- Bear in mind that the front end of the vehicle may swing out towards oncoming traffic during the parking maneuver.

¹⁰⁶Park Assist Camera

¹⁰⁷The trajectory lines will not be displayed when zooming in.

¹⁰⁸Park Assist System

¹⁰⁹Not available for all models and markets.





WARNING

- The function is supplementary driver support intended to facilitate driving and help make it safer – it cannot handle all situations in all traffic, weather and road conditions.
- The driver is advised to read all sections in the Owner's Manual about this function to learn of its limitations, which the driver must be aware of before using the function.
- Driver support functions are not a substitute for the driver's attention and judgment. The driver is always responsible for ensuring the vehicle is driven in a safe manner, at the appropriate speed, with an appropriate distance to other vehicles, and in accordance with current traffic rules and regulations.

Related information

- Driver support systems (p. 268)
- Location and field of vision of Park Assist Cameras* (p. 360)
- Park Assist Camera trajectory lines* (p. 362)
- Park Assist sensor field (p. 364)
- Activating Park Assist Camera (p. 365)

¹¹⁰ Park Assist Camera

- Park Assist Camera symbols and messages (p. 367)
- Camera/radar sensor limitations (p. 381)
- Park Assist* (p. 354)
- Cross Traffic Alert* (p. 350)

Location and field of vision of Park Assist Cameras*

The Park Assist Cameras (PAC¹¹⁰) can display a 360° panoramic view as well as separate views for each of the four cameras: rear, front, left and right.

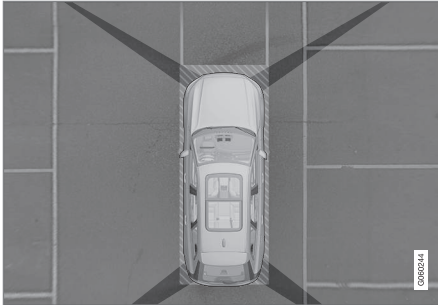
360° view*

The location of the cameras and their approximate fields of vision.

The **360° view** function activates all Park Assist Cameras and all four sides of the vehicle are shown in the center display at once to help the driver see what is around the vehicle while maneuvering at low speeds.

From the 360° view, each camera view can be activated separately:

- Tap the screen to select the camera's field of vision, e.g. in the area in front/above the front camera.



The active cameras will be indicated by a camera symbol on the vehicle symbol in the center display.

If the vehicle is equipped with **Park Assist System***, the distance to detected obstacles will be illustrated by fields in different colors.

The cameras can be activated automatically or manually.

Back

The rear camera is located above the license plate.

The rear camera shows a wide area behind the vehicle. On certain models, part of the bumper and the towbar (if installed) may be visible.

Objects on the center display may appear to be leaning slightly. This is normal.

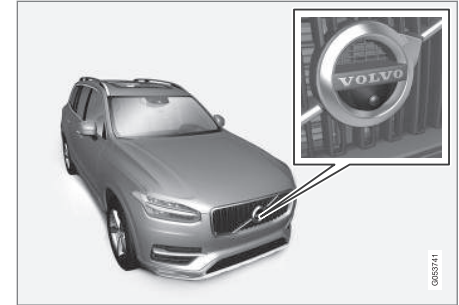
Front camera

The front Park Assist Camera is located in the grille.

The front camera can be useful when pulling out from areas with limited visibility, such as when pulling out of a garage. The front camera is active at speeds up to 25 km/h (16 mph) and is automatically turned off when the vehicle exceeds this speed.

If the vehicle does not reach a speed of 50 km/h (30 mph) and speed falls below 22 km/h (14 mph) within 1 minute after the front camera turns off, the camera will be reactivated.



◀ Side cameras



The side cameras are located in the rearview mirrors.

The side cameras can show views along each side of the vehicle.

Related information

- Park Assist Camera* (p. 359)
- Activating Park Assist Camera (p. 365)
- Camera/radar sensor limitations (p. 381)

Park Assist Camera trajectory lines*

The Park Assist Cameras (PAC¹¹¹) use trajectory lines and fields on the screen to indicate the vehicle's position in relation to its immediate surroundings.



Example of trajectory lines

The trajectory lines show the anticipated trajectory for the vehicle's outermost dimensions

based on the current position of the steering wheel and can help simplify parallel parking, backing into tight spaces or attaching a trailer.

The lines on the screen are projected as if they were painted lines on the ground behind the vehicle and are directly affected by the way in which the steering wheel is turned. This makes it possible for the driver to see path the vehicle will take, even if he/she turns the steering wheel.

These lines also indicate the outermost limits that any object (towbar, rearview mirrors, corners of the body, etc.) extends out from the vehicle.

i	NOTE
<ul style="list-style-type: none"> • When reversing with a trailer that is not electrically connected to the vehicle, the screen guide lines show the path the vehicle will take – not the trailer. • The screen does not show guide lines when a trailer is electrically connected to the vehicle's electrical system. • Guide lines are not shown when zooming in. 	

¹¹¹ Park Assist Camera

! CAUTION

- Bear in mind that when the rearward camera view is selected, the screen only shows the area behind the vehicle – pay attention to the sides and front of the vehicle when steering while reversing.
- The same applies to the reverse – pay attention to what is happening with the rear parts of the vehicle when the front camera view is selected.
- Note that the guide lines show the **shortest** path – pay extra attention to ensure that the vehicle sides do not come in contact with/travel over anything when steering while driving forward or that the vehicle front moves toward/over anything when steering while reversing.

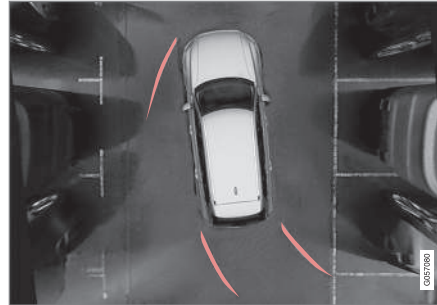
Trajectory lines in 360° view*

360° view with trajectory lines

In the 360° view, trajectory lines are shown behind, in front of, or to the sides of the vehicle, depending on the direction of travel.

- When driving forward: Front lines
- When backing up: Side lines and rear lines

When the front or rear camera is selected, the trajectory lines will be shown regardless of the vehicle's direction of travel.

With a side camera selected, the trajectory lines will only be shown if the vehicle is backing up.

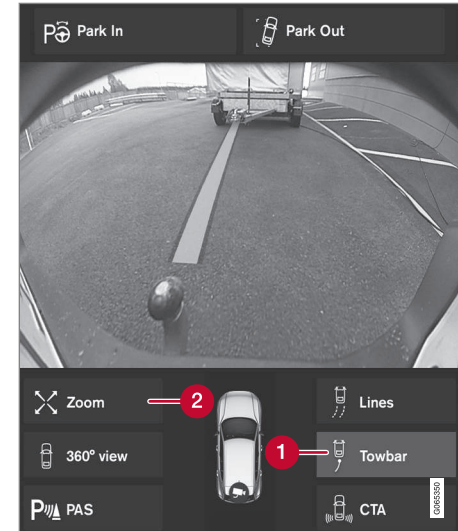
Trajectory lines for a towbar*

Towbar with trajectory line

- 1 Towbar** - activate trajectory lines for towbar.
- 2 Zoom** - zoom in/out.

To use the camera when hitching a trailer:



- ◀ 1. Tap **Towbar** (1).
 - > The trajectory line for the towbar's anticipated path toward the vehicle will appear and the vehicle's trajectory lines will disappear.

Trajectory lines cannot be displayed for both the vehicle and the towbar at the same time.
- 2. Tap **Zoom** (2) for a close-up view for more precise maneuvering.
 - > The camera will zoom in.

Related information

- Park Assist Camera* (p. 359)
- Location and field of vision of Park Assist Cameras* (p. 360)
- Camera/radar sensor limitations (p. 381)

Park Assist sensor field

If the vehicle is equipped with Park Assist (PAS¹¹²), distances will be shown in the Park Assist Camera's (PAC¹¹³) 360° view with colored fields for each sensor that has detected an obstacle.

Front and rear sensors



The screen can display colored sensor fields on the vehicle symbol.

The front and rear fields change colors (from YELLOW to ORANGE to RED) as the vehicle moves closer to an obstacle.

Field color rearward	Distance in meters (feet)
Yellow	0.6-1.5 (2.0-4.9)
Orange	0.3-0.6 (1.0-2.0)
Red	0-0.3 (0-1.0)

Field color forward	Distance in meters (feet)
Yellow	0.6-0.8 (2.0-2.6)
Orange	0.3-0.6 (1.0-2.0)
Red	0-0.3 (0-1.0)

When the sensor field color is red, the audible pulsing sounds will change to a continuous tone.

112 Park Assist System
113 Park Assist Camera

Side sensor fields

Warning signals vary depending on the vehicle's intended direction of travel. Depending on the steering wheel position, warnings may be given for obstacles diagonally in front of or behind the vehicle, not only directly behind the vehicle.

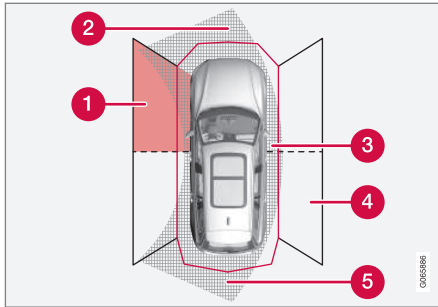

Parking sensor sectors where obstacles can be detected.

- 1 Left-side front sensor field
- 2 Obstacle sector in the vehicle's intended direction of travel forward – varies according to steering wheel position
- 3 Sector with RED field color and rapidly pulsing tone

- 4 Right-side rear sensor field
- 5 Obstacle sector in the vehicle's intended direction of travel rearward – varies according to steering wheel position.

The color of the side field changes as the vehicle moves closer to the object – from YELLOW to RED.

Side field color	Distance in meters (feet)
Yellow	0.25–0.9 (0.8–3.0)
Red	0–0.25 (0–0.8)

When the sensor field is RED, the audible pulsing signal will become more rapid.

Related information

- Park Assist* (p. 354)
- Park Assist Camera* (p. 359)
- Location and field of vision of Park Assist Cameras* (p. 360)
- Camera/radar sensor limitations (p. 381)

Activating Park Assist Camera

The Park Assist Camera (PAC¹¹⁴) is automatically activated when reverse gear is engaged or can be started manually using one of the center display's function buttons.

Camera view when backing up

When reverse gear is engaged, the screen shows the rear view¹¹⁵.

Camera view when manually activating the camera



Activate the Park Assist Camera using this button in the center display's Function view.

The screen will first show the most recently used camera

view. However, each time the engine is started, the previous side view will be replaced by the 360° view and a previously displayed zoomed-in rear view will be replaced by the regular rear view.

- GREEN button indicator light – the function is activated.
- GRAY button indicator light – the function is deactivated.

¹¹⁴ Park Assist Camera

¹¹⁵ In Canada, it is also possible to choose the 360° view. For the US, rear view is standard and cannot be changed.



◀◀ **Automatically deactivating the camera**

Front view switches off when the vehicle's speed reaches 25 km/h (16 mph) to help avoid distracting the driver. It will be automatically reactivated if the vehicle's speed falls below 22 km/h (14 mph) within 1 minute as long as the vehicle's speed has not exceeded 50 km/h (31 mph).

Other camera views switch off at 15 km/h (9 mph) and are not reactivated.



Related information

- Park Assist Camera* (p. 359)
- Park Assist limitations (p. 357)
- Camera/radar sensor limitations (p. 381)

Park Assist Camera symbols and messages

Symbols and messages for the Park Assist Camera (PAC¹¹⁶) may be displayed in the

instrument panel and/or the center display.
Several examples are provided below.

Symbol	Message	Meaning
		The rear Park Assist sensors are turned off and no acoustic warnings or field markings for obstacles/objects will be provided.
		The camera is not functioning properly.
	Park Assist System Sensors blocked, cleaning needed	One or more of the sensors are blocked. Check and clean/remove the obstacle as soon as possible.
	Park Assist System Unavailable Service required	The system is not functioning as intended. Contact a workshop ^A .

^A An authorized Volvo workshop is recommended.

¹¹⁶ Park Assist Camera

DRIVER SUPPORT

- ◀◀ A text message can be erased by briefly pressing the  button in the center of the right-side steering wheel keypad.

If a message cannot be erased, contact a workshop^A.

Related information

- Park Assist Camera* (p. 359)
- Camera/radar sensor limitations (p. 381)

Park Assist Pilot*

Park Assist Pilot (PAP¹¹⁷) can help the driver maneuver the vehicle when parking. The function can also assist with steering when pulling out from a parallel parking space. The function first checks whether there is sufficient space and then helps the driver steer the vehicle into the space.

The center display uses symbols, graphics and messages to inform the driver of what steps need to be taken and when.

WARNING

- The function is supplementary driver support intended to facilitate driving and help make it safer – it cannot handle all situations in all traffic, weather and road conditions.
- The driver is advised to read all sections in the Owner's Manual about this function to learn of its limitations, which the driver must be aware of before using the function.
- Driver support functions are not a substitute for the driver's attention and judgment. The driver is always responsible for ensuring the vehicle is driven in a safe manner, at the appropriate speed, with an appropriate distance to other vehicles, and in accordance with current traffic rules and regulations.

- Park Assist Pilot* messages (p. 377)

Related information

- Driver support systems (p. 268)
- Types of parking with Park Assist Pilot* (p. 370)
- Using Park Assist Pilot* (p. 371)
- Leaving a parallel parking space with Park Assist Pilot* (p. 374)
- Park Assist Pilot* limitations (p. 374)

Types of parking with Park Assist Pilot*

Park Assist Pilot (PAP¹¹⁸) can be used for both parallel and perpendicular parking.

Parallel parking

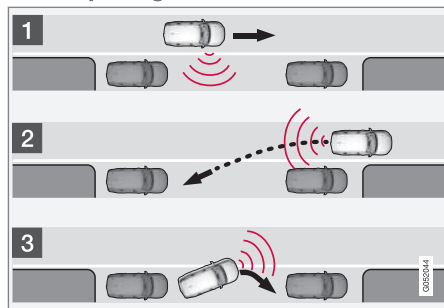

Overview of parallel parking.

The function helps park the vehicle using the following steps:

1. The system searches for and measures potential parking spaces.
2. The vehicle is steered while it is backing into the parking space.
3. The vehicle's position in the space is adjusted by driving forward/backward.

The **Park Out** function can also help the driver pull out of parking spaces.

Perpendicular parking

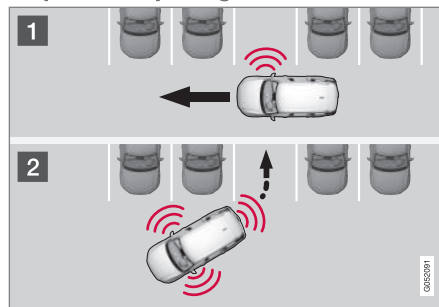

Perpendicular parking overview.

The function helps park the vehicle using the following steps:

1. The system searches for and measures potential parking spaces.
2. The vehicle is steered while it is backing into the space and its position is adjusted by driving forward/backward.

i NOTE

Leaving a parking space with the **Park Out** function should only be used in connection with parallel parking – it does not work for perpendicular parking.

Related information

- Park Assist Pilot* (p. 369)
- Leaving a parallel parking space with Park Assist Pilot* (p. 374)

¹¹⁸ Park Assist Pilot

Using Park Assist Pilot*

Park Assist Pilot (PAP¹¹⁹) helps the driver park using three different steps. The function can also help the driver pull out of a parking space.

The function measures the space and steers the vehicle. The driver's role is to:

- keep close watch of the area around the vehicle
- follow the instructions on the center display
- change gears (reverse/forward) – an audible signal indicates when the driver needs to change gears
- regulating and maintaining a safe speed
- applying the brakes and stopping the vehicle.

Information about the actions required by the driver are provided in the center display using symbols, graphics and/or text.

The function can be activated if the following criteria have been met after the engine is started:

- No trailer is hitched to the vehicle
- Your vehicle's speed is lower than 30 km/h (20 mph).

i NOTE

The distance between the vehicle and parking spots should be 0.5–1.5 meters (1.6–5.0 ft) when the function is looking for parking.

Parking with Park Assist Pilot

The function helps park the vehicle using the following steps:

1. The system searches for and measures potential parking spaces.
2. The vehicle is steered while it is backing into the parking space.
3. The vehicle is positioned in the parking space (the driver may be prompted to shift gears and apply the brakes).

Searching and measuring potential parking spots



The function can be activated in the center display's Function view.

It can also be accessed from the camera views.

- GREEN button indicator light – the function is activated.
- GRAY button indicator light – the function is deactivated.

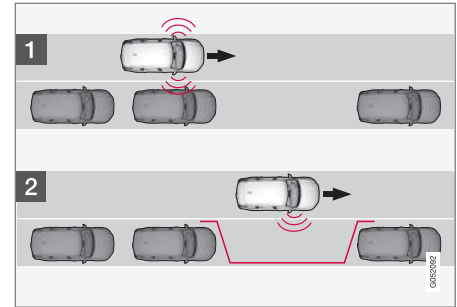

Parallel parking search overview.

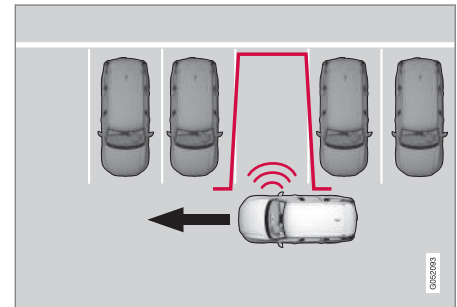

Perpendicular parking search overview.

Vehicle speed may not exceed 30 km/h (20 mph) when parking.

1. Tap **Park In** in Function view or in Camera view.
 - > The function will search for a potential parking space and measure it to determine if it is big enough.
2. Be prepared to stop the vehicle when a graphic and message in the center display indicate that a suitable parking space has been found.
 - > A pop-up window will appear.
3. Select **Parallel parking** or **Perpendicular parking** and engage reverse gear.

NOTE

The function searches for space for parking, shows instructions and guides the vehicle on its passenger side. But, if so desired the vehicle can be parked on the driver's side of the street:

- Activate the turn signals on the driver's side – the system will then search for space to park on that side of the vehicle instead.

Backing into a parking space

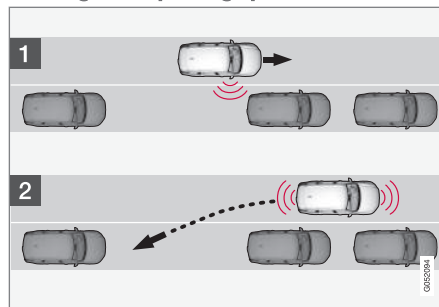

Backing into a parallel parking spot overview.

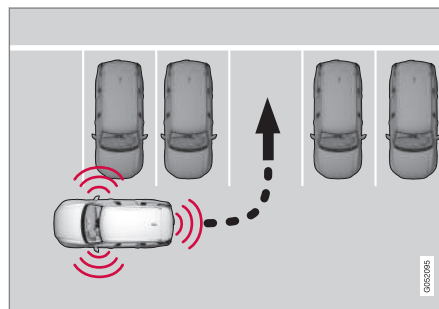

Backing into a perpendicular parking spot overview.

1. Make sure the path behind your vehicle is clear and engage reverse gear.

2. Back up slowly and carefully without touching the steering wheel and do not exceed a speed of 7 km/h (4 mph).
3. Be prepared to stop the vehicle when instructed to do so by a graphic and message in the center display.

NOTE

- Keep your hands away from the steering wheel when the function is activated.
- Make sure that the steering wheel is not hindered in any way and can rotate freely.
- To achieve the best results – wait until the steering wheel is finished turning before beginning to drive forward/in reverse.

Positioning the vehicle in the parking space

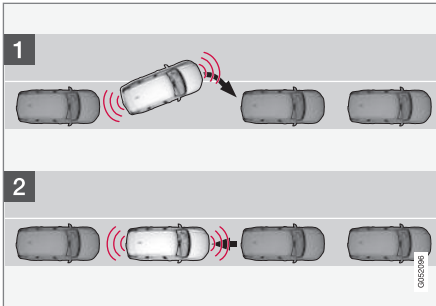

Parallel parking positioning overview.

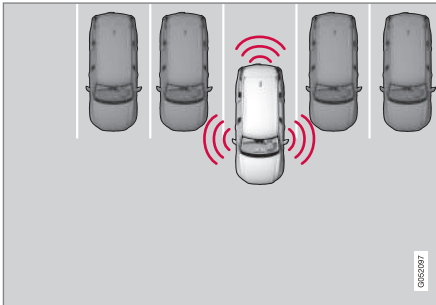

Perpendicular parking positioning overview.

1. Move the gear selector to the gear instructed by the system. Wait until the steering wheel turns and then drive slowly forward.
2. Be prepared to stop the vehicle when instructed to do so by a graphic and message in the center display.
3. Engage reverse gear and back up slowly.
4. Be prepared to apply the brakes when instructed to do so by a graphic and message in the center display.

The function will switch off automatically and a graphic and message will appear to indicate that parking has been completed. Adjustments can always be made by the driver afterward. Only the driver can determine when the vehicle is correctly parked.

CAUTION

The warning distance is shorter when the sensors are used by Park Assist Pilot (PAP¹²⁰) compared to when they are used by the Parking Assist system.

Auto-brake during a parking sequence

If, while parking, the parking sensors detect a vehicle or pedestrian in the vehicle's intended direction of travel behind or in front of the

vehicle, the auto-brake function will bring the vehicle to a standstill.

A pop-up message will then appear in the instrument panel and the driver can tap **Cancel** to cancel the parking sequence or **Resume** to continue the parking sequence.

After selecting **Resume**:

- Check that the area around the vehicle is free of obstructions and follow the instructions on the center display, such as:

To continue – Gently accelerate away from object.

Related information

- Park Assist Pilot* (p. 369)
- Park Assist Pilot* limitations (p. 374)

Leaving a parallel parking space with Park Assist Pilot*

The **Park Out** function can help the driver to pull out of a parking space when the vehicle is parallel-parked.

NOTE

Leaving a parking space with the **Park Out** function should only be used in connection with parallel parking – it does not work for perpendicular parking.



The **Park Out** function is activated in the center display's Function view or in Camera view.

- GREEN button indicator light – the function is activated.
 - GRAY button indicator light – the function is deactivated.
1. Tap **Park Out** in Function view or in Camera view.
 2. Move the gear selector to the suitable position (e.g. D or R) for the direction in which you will be pulling out of the parking space.

3. Be prepared to stop the vehicle when instructed to do so by a graphic and message in the center display. Follow the instructions in the same way as for the parking procedure.

Note that the steering wheel can "spring" back when the procedure is completed and the driver may need to turn the steering wheel back to the maximum position in order to pull out of the parking space.

If the function determines that the driver can pull out of the parking space without any extra maneuvers, the function will be deactivated, even if it seems as though the vehicle is not completely out of the parking space.

Related information

- Park Assist Pilot* (p. 369)
- Park Assist Pilot* limitations (p. 374)

Park Assist Pilot* limitations

Park Assist Pilot (PAP¹²¹) may not be able to detect all conditions in all situations and functionality may therefore be limited.

The driver should be aware of the following limitations for Park Assist Pilot.

WARNING

- The parking sensors have dead/blind spots where objects cannot be detected.
- Pay particular attention to people and animals near the vehicle.
- Bear in mind that the front end of the vehicle may swing out towards oncoming traffic during the parking maneuver.

CAUTION

Objects situated higher than the detection area of the sensors are not included when the parking maneuver is calculated, which could cause the function to swing into the parking space too early. Such parking spaces should be avoided for this reason.

¹²¹ Park Assist Pilot

The parking sequence is cancelled

A parking sequence will be cancelled if:

- the driver moves the steering wheel
- the vehicle's speed exceeds 7 km/h (4 mph)
- the driver taps **Cancel** in the center display
- when the anti-lock brakes or the Electronic stability control are engaged - e.g. when a wheel loses grip on a slippery road
- when speed-dependent power steering wheel resistance is working at reduced power – e.g. during cooling due to overheating
- when, while parking, the parking sensors detect a vehicle or pedestrian in the vehicle's intended direction of travel behind or in front of the vehicle, the auto-brake function will bring the vehicle to a standstill.

A message in the center display will explain why the parking sequence was cancelled.

CAUTION

Under certain circumstances, the function may not be able to find parking spaces – one reason may be that the sensors are disrupted by external sound sources that emit the same ultrasonic frequencies that the system works with.

Examples of such sources include horns, wet tires on asphalt, pneumatic brakes, exhaust noise from motorcycles, etc.

NOTE

Dirt, ice and snow covering the sensors reduce their function and can make measurement impossible.

Driver responsibility

The driver should keep in mind that the function is a parking aid – not an infallible fully automatic system. The driver must always be prepared to take control and cancel a parking sequence if necessary.

There are a number of things to keep in mind when parking, including:

- The driver is always responsible for determining if the space suggested by the function is suitable for parking.
- Do not use the function when using snow chains or a temporary spare tire.
- Do not use the function if there are any objects protruding from the vehicle.
- Heavy rain or snowfall may inhibit PAP's ability to accurately measure a parking space.
- While searching and measuring the parking space, the function may be unable to detect objects located far into the space.
- PAP may not suggest parking spaces on narrow streets if it does not detect sufficient space for maneuvering the vehicle.
- Use approved tires¹²² inflated to the correct tire pressure because this affects the function's ability to provide parking assistance.
- The function is based on the way the vehicles are parked behind and in front of your parking space. If they are, for example, parked too close to the curb, there is a risk that your vehicle's tires or wheel rims

¹²²"Approved tires" refers to tires of the same type and make as the vehicle's original, factory-installed tires.

- ◀◀ could be damaged by the curb during the parking procedure.
- Perpendicular parking spaces may not be detected or may be suggested unnecessarily if a parked vehicle is sticking out more than other parked vehicles.
- The function is intended to provide parking assistance on straight streets, not sections of street with sharp curves or bends. Always make sure that your vehicle is parallel to relevant parking spaces when the function is measuring the parking space.

Related information

- Park Assist Pilot* (p. 369)
- Speed-dependent steering wheel resistance (p. 268)
- Camera/radar sensor limitations (p. 381)

Park Assist Pilot* messages

Messages for Park Assist Pilot (PAP¹²³) may be displayed in the instrument panel and/or

the center display. Several examples are provided below.

Message	Meaning
Park Assist System Sensors blocked, cleaning needed	One or more of the sensors are blocked. Check and clean/remove the obstacle as soon as possible.
Park Assist System Unavailable Service required	The system is not functioning as intended. Contact a workshop ^A .

^A An authorized Volvo workshop is recommended.

A text message can be erased by briefly pressing the  button in the center of the right-side steering wheel keypad.

If a message cannot be erased, contact a workshop^A.

Related information

- Park Assist Pilot* (p. 369)
- Park Assist Pilot* limitations (p. 374)

¹²³Park Assist Pilot

Radar sensor

The radar sensor is used by several driver support systems to detect other vehicles.



Location of radar sensor

The radar sensor is used by the following functions:

- Distance Alert*
- Adaptive Cruise Control*
- Pilot Assist*
- Lane Keeping Aid
- City Safety
- Steering assistance at risk of collision

Any modifications to the radar sensor may make its use illegal.

Related information

- Driver support systems (p. 268)
- Camera/radar sensor limitations (p. 381)

- Recommended camera and radar sensor maintenance (p. 384)
- Radar sensor type approval (p. 379)

Radar sensor type approval

The type approval for the vehicle's radar units for adaptive cruise control* (ACC¹²⁴), Pilot Assist* and BLIS¹²⁵ are found here.

Market	ACC & PA	BLIS	Type approval
Canada	✓		FCC ID: L2C0054TR IC: 3432A-0054TR FCC ID: L2C0055TR IC: 3432A-0055TR
		✓	Canada Standard RSS-310
USA	✓		FCC ID: L2C0054TR IC: 3432A-0054TR FCC ID: L2C0055TR IC: 3432A-0055TR
		✓	FCC ID: NBG01RS4

This device complies with Part 15 of the FCC Rules and with Industry Canada license-exempt RSS standard(s). Operation is subject to the following two conditions:

- (1) This device may not cause harmful interference, and
- (2) This device must accept any interference received, including interference that may cause undesired operation.

Ce dispositif de radiocommunication de catégorie II respecte la norme CNR-310 d'Industrie Canada. Le présent appareil est conforme aux CNR d'Industrie Canada

applicables aux appareils radio exempts de licence. L'exploitation est autorisée aux deux conditions suivantes:

- (1) l'appareil ne doit pas produire de brouillage, et
- (2) l'utilisateur de l'appareil doit accepter tout brouillage radioélectrique subi, même si le brouillage est susceptible d'en compromettre le fonctionnement.

Cet appareil est conforme aux CNR d'Industrie Canada applicables aux appareils radio exempts de licence. L'exploitation est autorisée à condition que l'appareil ne

produise pas de brouillage préjudiciable et qu'il accepte tout brouillage, même celui susceptible d'en compromettre le fonctionnement.

CAUTION TO USERS: Changes or modifications not expressly approved by the party responsible for compliance could void the user's authority to operate the equipment. The term "IC;" before the radio certification number only signifies that Industry Canada technical specifications were met.

Note: This equipment complies with radiation exposure limits set forth for an uncontrolled

¹²⁴Adaptive Cruise Control

¹²⁵Blind Spot Information



- ◀◀ environment. This equipment should be installed and operated with minimum distance of 20 cm between the radiator and your body.

For detailed information about type approval, go to volvocars.com/support.

Related information

- Radar sensor (p. 378)
- Adaptive Cruise Control* (p. 284)
- Pilot Assist* (p. 294)
- BLIS* (p. 342)

Camera

The camera is used by several driver support systems to e.g. detect lane marker lines or road signs.



Location of the camera

The camera is used by the following functions:

- Adaptive Cruise Control*
- Pilot Assist*
- Lane Keeping Aid*
- Steering assistance at risk of collision
- City Safety
- Driver Alert Control*
- Road Sign Information*
- Active high beams*
- Park Assist*

Related information

- Driver support systems (p. 268)
- Camera/radar sensor limitations (p. 381)
- Recommended camera and radar sensor maintenance (p. 384)

Camera/radar sensor limitations

The camera and radar sensor used by several of the driver support functions has certain limitations, which also affect the functions using the camera and radar sensor. The driver should be aware of the following limitations:



◀ Common camera and radar limitations

Obstructed camera



The area marked in the illustration must be cleaned regularly and kept free of decals, objects, solar film, etc.

The camera is located on the upper interior section of the windshield along with the radar sensor.

Do not place, affix or mount anything on the inside or outside of the windshield, or in front of or around the camera and radar sensor – this could disrupt camera and radar-based functions. It could cause functions to be reduced, deactivated completely or to produce an incorrect function response.

High temperatures

If the temperature in the passenger compartment is very high, the camera/radar sensor

will switch off temporarily for approx. 15 minutes after the engine is started to protect its electronic components. When the temperature has cooled sufficiently, the camera/radar sensor will automatically restart.

Damaged windshield

i NOTE

Failure to take action could result in reduced performance for the driver support systems that use the camera and radar unit. It could cause functions to be reduced, deactivated completely or to produce an incorrect function response.

To avoid the risk of malfunction of the driver support systems that use the radar sensor, the following also apply:

- If there are cracks, scratches or stone chips on the windshield in front of any of the camera and radar sensor "windows" and this covers an area of about 0.5 × 3.0 mm (0.02 × 0.12 in.) or more, contact a workshop to have the windshield replaced¹²⁶.
- Volvo advises **against** repairing cracks, scratches or stone chips in the area in front of the camera and radar sensor – the

entire windshield should instead be replaced.

- Before replacing the windshield, contact a workshop¹²⁶ to verify that the right windshield has been ordered and installed.
- The same type of windshield wipers or wipers approved by Volvo should be used for replacement.
- If the windshield is replaced, the camera and radar sensor must be recalibrated by a workshop¹²⁶ to help ensure proper functioning of all of the vehicle's camera and radar-based systems.

Additional radar limitations

Vehicle speed

The radar sensor's ability to detect a vehicle ahead is significantly reduced if the speed of the vehicle ahead differs greatly from your vehicle's speed.

¹²⁶An authorized Volvo workshop is recommended.

Limited field of vision

The radar sensor has a limited field of vision. In some situations, it may detect a vehicle later than expected or not at all.

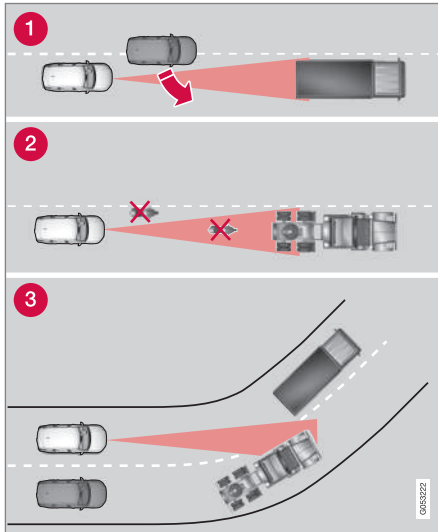

The radar sensor's field of vision

- 1 The radar sensor's detection of vehicles very close to your vehicle may be delayed in certain situations, e.g. if a vehicle pulls

in between your vehicle and the vehicle directly ahead.

- 2 Small vehicles, such as motorcycles, or vehicles that are not driving in the center of the lane may remain undetected.
- 3 In curves, the radar may detect the a different vehicle than intended or lose sight of a target vehicle.

Low trailers

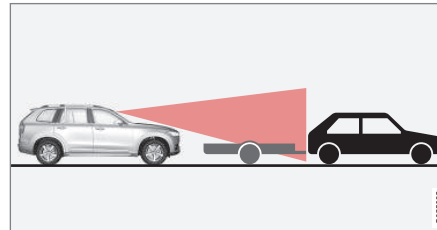

Low trailer in the radar shadow

Low trailers may also be difficult or even impossible for the radar to detect. The driver should be extra alert when driving behind vehicles towing low trailers when Adaptive Cruise Control* or Pilot Assist* is activated.

Additional camera limitations

Reduced visibility

Cameras have the same limitations as the human eye. In other words, their "vision" is impaired by adverse weather conditions such as heavy snowfall/rain, dense fog, swirling

dust/snow, etc. These conditions may reduce the function of systems that depend on the camera or cause these systems to temporarily stop functioning.

Strong sunlight, reflections from the road surface, ice or snow covering the road, a dirty road surface, or unclear lane marker lines may drastically reduce the camera's ability to detect the side of a lane, a pedestrian, a cyclist, a large animal or another vehicle.



◀ Additional Park Assist Camera* limitations

Blind sectors

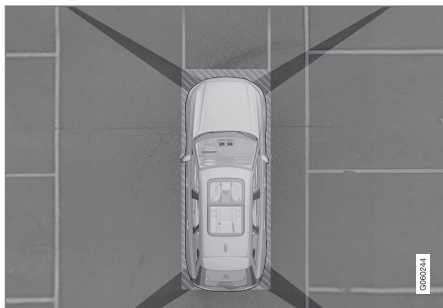

There are "blind" sectors between the cameras' fields of vision.

With the Park Assist Camera's 360° view* selected, objects/obstacles may not be detected if they are located in the "joints" where the edges of the individual camera views meet.

⚠ WARNING

Even if it seems as though only a fairly small section of the screen image is obstructed, this may mean that a relatively large sector is hidden and obstacles there may not be detected until they are very near the vehicle.

Lighting conditions

The camera image is automatically adjusted according to the current lighting conditions. This means that the brightness and quality of the image may vary slightly. Poor lighting conditions may result in reduced image quality.

i NOTE

A bike carrier and other accessories mounted on the rear of the vehicle can obscure the camera's view.

Related information

- Camera (p. 381)
- Radar sensor (p. 378)
- Recommended camera and radar sensor maintenance (p. 384)
- Park Assist Camera* (p. 359)
- Volvo Cars support site (p. 21)

Recommended camera and radar sensor maintenance

In order for the camera and radar units to function properly, they must be kept free of dirt, ice, snow, etc. and should be washed regularly with water and car washing detergent.

i NOTE

Dirt, ice and snow covering the sensors could cause false warnings, reduced function, or no function.

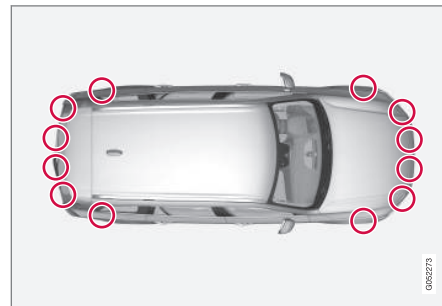

Location of the Park Assist sensors

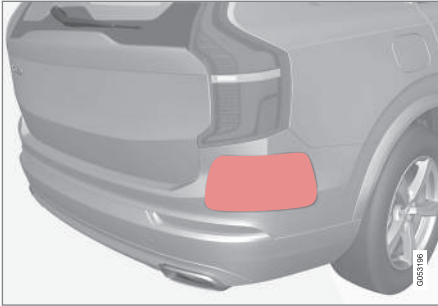

Location of rear radar sensors. Keep the marked area clean (on both the left and right sides of the vehicle).

- For best possible performance, it is important to keep the areas in front of the sensors clean.
- Do not attach any objects, tape or decals to the surface of the sensors.
- Clean the camera lenses regularly using lukewarm water and car washing detergent. Wash gently to avoid scratching the lens.

! CAUTION

Only a workshop may perform maintenance on driver support components – an authorized Volvo workshop is recommended.

Related information

- Camera (p. 381)
- Radar sensor (p. 378)
- Camera/radar sensor limitations (p. 381)
- Park Assist Camera* (p. 359)

Camera and radar unit symbols and messages

Here are examples of some of the messages and symbols related to the camera and radar units that may be displayed in the instrument panel.

Sensor blocked



If this symbol and the message **Windscreen sensor Sensor blocked, see Owner's manual** is displayed in the instrument panel, it means that the camera and radar unit are unable to detect other vehicles, cyclists, pedestrians and large animals in front of the vehicle and that the vehicle's camera and radar-based functions may be obstructed.

The following table shows some of the situations that can cause the message to be displayed, and suggested actions:

Cause	Action
The area of the windshield in front of the camera/radar sensor is dirty or covered by ice or snow.	Clean the windshield in front of the camera/radar sensor and remove dirt, ice and snow.
Thick fog, heavy rain or snow is blocking the radar signals or the camera's range of visibility.	No action. Heavy precipitation may sometimes prevent the camera/radar sensor from functioning.
Water or snow is spraying/swirling up and blocking the radar signals or the camera's range of visibility.	No action. Very wet or snow-covered roads may sometimes prevent the camera/radar sensor from functioning.
There is dirt between the inside of the windshield and the camera/radar sensor.	Consult a workshop to have the area of the windshield on the inside of the camera's casing cleaned. An authorized Volvo workshop is recommended.
Bright sunlight.	No action. The camera/radar sensor will reset automatically when lighting conditions improve.

Defective camera



If a camera sector is dark and contains this symbol, this indicates that the camera is not functioning properly.



The vehicle's left-side camera is malfunctioning.

A dark camera sector may also be displayed in the following situations, but **without** the defective camera symbol:

- a door is open
- the tailgate is open
- a rearview mirror is folded in

Rear Park Assist Camera

⚠ WARNING



Be extra cautious when reversing if this symbol is shown when a trailer, bike carrier or similar is attached and electrically connected to the vehicle.

The symbol indicates that the rear parking assist sensors are **deactivated** and will not warn of any obstacles.

Related information

- Camera (p. 381)
- Radar sensor (p. 378)
- Camera/radar sensor limitations (p. 381)
- Volvo Cars support site (p. 21)

ELECTRIC MOTOR AND CHARGING

General information about electric vehicles

Recharge vehicles are driven just like any other vehicle, but certain functions differ from a vehicle powered exclusively by gasoline. The electric motor powers the vehicle primarily at low speeds; the gasoline engine is used at higher speeds or during more active driving.

The instrument panel displays Recharge-specific information - charging information, selected drive mode, distance to discharged battery and hybrid battery charge level.

Different drive modes can be selected while driving, e.g. electric power only or, if more power is needed, a combination of electric and gasoline power. The vehicle calculates a combination of driveability, driving experience, environmental impact and fuel economy for the selected drive mode.

In order to function optimally, the hybrid battery (and its electrical drive systems) and the gasoline engine (and its drive systems) must be at the correct operating temperature. Battery capacity can be considerably reduced if the battery is too cold or too hot. Preconditioning prepares the vehicle's drive systems and passenger compartment before driving to help reduce both wear and energy consumption. It also helps increase the hybrid battery's range.

The hybrid battery which powers the electric motor is recharged using the charging cable. It can also be recharged during light braking and through engine braking in gear position **B**. The combustion engine can also help recharge the hybrid battery.

Important

No electrical current

Keep in mind that if there is no electrical current to the vehicle, i.e. the ignition is switched off or the start battery is discharged, certain functions such as power brakes, power steering, etc. will be limited.

WARNING

The power brakes only work when the electric motor or combustion engine is running.

Towing not permitted

Never tow the vehicle behind another vehicle, as this could damage the electric motor.

Exterior engine noise

Because there is no sound from the engine when only the electric motor is running, the vehicle is equipped with artificial exterior background noise. This sound is intended to help warn children, pedestrians, cyclists, animals, etc. outside the vehicle of the vehicle's approach.

High-voltage electrical current

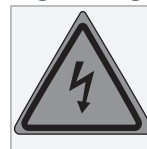

WARNING

A number of electrical components in the vehicle use high-voltage current and can be extremely dangerous if handled incorrectly. These components and any orange wiring in the vehicle may only be handled by trained and qualified Volvo service technicians.

Do not touch anything that is not clearly described in this Owner's Manual.

Related information

- Charging the hybrid battery (p. 391)
- Hybrid gauge (p. 85)
- Drive modes (p. 434)
- Starting and stopping preconditioning (p. 222)
- Hybrid battery (p. 603)
- Automatic transmission (p. 427)
- Towing using a towline (p. 461)

Charging the hybrid battery

In addition to the conventional fuel tank, your vehicle is also equipped with a rechargeable lithium-ion hybrid battery.

WARNING

California Proposition 65

Operating, servicing and maintaining a passenger vehicle can expose you to chemicals including engine exhaust, carbon monoxide, phthalates, and lead, which are known to the State of California to cause cancer and birth defects or other reproductive harm. To minimize exposure, avoid breathing exhaust, do not idle the engine except as necessary, service your vehicle in a well ventilated area and wear gloves or wash your hands frequently when servicing your vehicle. For more information go to www.P65Warnings.ca.gov/passenger-vehicle.

The hybrid battery can be recharged using the charging cable stored in a storage space in the cargo compartment.

WARNING

The hybrid electrical system in your vehicle uses high voltage electrical current. Any damage to this system or to the hybrid battery may result in the danger of overheating, fire, or serious injury. If the vehicle is involved in a collision or subjected to flooding, fire, etc., have it inspected by a trained and qualified Volvo service technician. Prior to this inspection, the vehicle should be parked outdoors at a safe distance from any building or potentially flammable materials.

The hybrid battery's charging time depends on the charging current used.

NOTE

The capacity of the hybrid battery diminishes somewhat with age and use, which could result in increased use of the gasoline engine and consequently, slightly higher fuel consumption.

WARNING

If the hybrid battery needs to be replaced, this may only be done by a Volvo retailer or authorized Volvo workshop.

Charging cable handle and charging socket



Charging cable handle and charging socket.

Charging status is indicated in three ways:

- Indicator on the charging cable's control module.
- Indicator light in the vehicle's charging socket.
- Images and text in the instrument panel.

The start battery is charged while the hybrid battery is charging and stops charging when the hybrid battery is fully charged.

If the hybrid battery's temperature is below -10 °C (14 °F) or above 40 °C (104 °F), some of the vehicle's functions may be reduced or not available at all.

- ◀◀ The electric motor cannot be used if the battery's temperature is too low or too high. If the PURE drive mode is selected, the gasoline engine will start.

Charging with fixed control module in accordance with mode 3¹

In certain markets, the control module is installed within a charging station connected to an electrical outlet. In this case, the charging cable does not have its own control module. You must therefore use the charging station's charging cable and follow the instructions on the charging station.

Energy recovery during braking



Indicator in the instrument panel during energy recovery.

Energy is regenerated to the battery when the brake pedal is depressed lightly or during engine braking.

The function is available in all drive modes together with gear selector position **D** or **B**.

Related information

- Charge cable (p. 394)
- Charging current (p. 392)
- Opening and closing the charging socket cover (p. 397)
- Initiating hybrid battery charging (p. 397)
- Stopping hybrid battery charging (p. 406)
- Charging status in the charging cable's control module (p. 401)
- Charging status in the vehicle's charging socket (p. 399)
- Charging status in the instrument panel (p. 404)
- Hybrid symbols and messages in the instrument panel (p. 407)
- Automatic transmission (p. 427)
- Changing drive mode (p. 438)
- Long-term storage of vehicles with hybrid batteries (p. 409)
- Regenerative braking* (p. 426)

Charging current

Charging current is used to charge the hybrid battery and precondition the vehicle. Charging is performed by connecting a charging cable between the vehicle's charging socket and a 120/240 V electrical socket (alternating current).

When the charging cable is activated, a message will be displayed in the instrument panel and an indicator light in the vehicle's charging socket will illuminate. Charging current is primarily used for battery charging, but is also used for preconditioning. The vehicle's start battery is charged along with the hybrid battery.

! CAUTION

Never detach the charging cable from the 120/240 V outlet (AC, alternating current) while charging is in progress – the 120/240 V outlet could be damaged in such circumstances. Always interrupt charging first and then disconnect the charging cable – first from the vehicle's charging socket and then from the 120/240 V outlet.

¹ European standard - EN 61851-1.

! CAUTION

Make sure that the fuse to the wall outlet can handle the current specified for the charging cable.

i NOTE

- In extremely cold or hot weather, part of the charging current is used to heat/cool the hybrid battery and the passenger compartment, resulting in a longer charging time.
- The charging time is longer if preconditioning has been selected. The time required depends primarily on the ambient temperature.

Charging time

Charging time may vary. The following charging times apply when charging is not affected by current being drawn from the climate system or any other function. If charging seems to be taking more time than shown in the table, this should be investigated.

Charging times for charging with 200-240 V

Amperage (A) ^A	Charging time (hours)
6	8
10	4
16	3

^A Maximum charging current may vary from market to market.

Charging times for charging with 100-120 V

Amperage (A) ^A	Charging time (hours)
6	17
10	9
16	6

^A Maximum charging current may vary from market to market.

Fuse

There are normally several 120/240 V power consumers in one fuse circuit, which means that more than one power consumer (e.g. lighting, vacuum cleaner, electric drill, etc.) may use the same fuse.

Related information

- Charge cable (p. 394)
- Charging status in the charging cable's control module (p. 401)

- Charging status in the instrument panel (p. 404)
- Charging status in the vehicle's charging socket (p. 399)
- Starting and stopping preconditioning (p. 222)
- Stopping hybrid battery charging (p. 406)

Charge cable

The charging cable and its control module are used to charge the vehicle's hybrid battery.



The charging cable is stored in a storage compartment under the cargo compartment floor.

⚠ WARNING

Only use the charging cable provided with your vehicle or a replacement cable purchased from a Volvo retailer.

Specifications, charging cable

Enclosure class	IP67
Compliance	SAE J1772
Ambient temperature	-32 °C to 50 °C (-25 °F till 122 °F)

⚠ WARNING

- The charging cable must be grounded when in use. It is equipped with a cord with a grounding conductor and a grounding plug. The plug must be inserted into an appropriate outlet that is properly installed and grounded in accordance with all local codes and ordinances and is not damaged in any way.
- Children should be supervised when in the vicinity of the charging cable when it is plugged in.
- High voltage is present in your electric meter housing and power distribution service panel. Contact with high voltage can cause death or serious personal injury.
- Do not use the charging cable if it is damaged in any way. A damaged or malfunctioning charging cable may only be repaired by a workshop – an authorized Volvo workshop is recommended.
- Always position the charging cable so that it will not be driven over, stepped on, tripped over or otherwise damaged, or cause personal injury.
- Disconnect the charger from the wall outlet before cleaning it.

- Never connect the charging cable to an extension cord or a multiple plug socket.
 - Do not use one or more adapters between the charging cable and the electric outlet.
 - Do not use an external timer between the charging cable and the electrical outlet.
- Also, refer to the manufacturer's instructions for using the charging cable and its components.

⚠ CAUTION

Power strips, external timers, adapters, extension cords, surge protectors or similar devices must not be used together with the charging cable since this may involve a risk of fire, electric shocks, etc.

Do not use an external timer or adapter between the 120/240 V outlet (AC, alternating current) and the charging cable.

! CAUTION

Never detach the charging cable from the 120/240 V outlet (AC, alternating current) while charging is in progress – the 120/240 V outlet could be damaged in such circumstances. Always interrupt charging first and then disconnect the charging cable – first from the vehicle's charging socket and then from the 120/240 V outlet.

! CAUTION

Wipe the charging cable with a clean cloth lightly moistened with water or a mild detergent. Do not use chemicals or solvents.

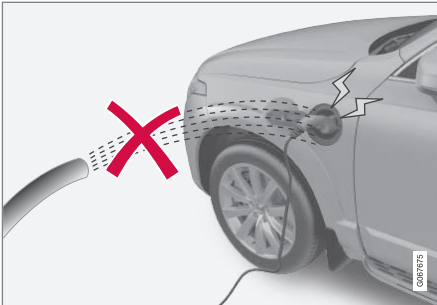
**⚠ WARNING**

The charging cable and its components must not be rinsed or immersed in water.

! CAUTION

Avoid exposing the charging module and its plug to direct sunlight. In such cases, the overheating protection in the plug could reduce or cut off charging of the hybrid battery.

Related information

- Charging status in the charging cable's control module (p. 401)
- Charging cable residual current device (p. 395)
- Charging cable temperature monitoring (p. 397)
- Charging the hybrid battery (p. 391)

Charging cable residual current device

The charging cable has a circuit breaker that helps protect against current overloads and thermal overheating.

⚠ WARNING

Charging the hybrid battery may only be done from approved, grounded 120/240 V outlets (AC, alternating current). If the electrical circuit or electrical socket's capacity is not known, let a licensed electrician inspect the electrical circuit's capacity. Using a charge level that exceeds the electrical circuit's or electrical outlet's capacity may start a fire or damage the electrical circuit.



⚠ WARNING

- The charging cable's residual current breaker helps protect the vehicle's charging system but cannot ensure that an current overload will never occur.
- Never use visibly worn or damaged electrical outlets. Doing so could lead to fires or serious injury.
- Never connect the charging cable to an extension cord.
- Maintenance or replacement of the hybrid battery may only be performed by a trained and qualified Volvo service technician.
- Do not use any charging cable other than the recommended one.
- Do not use an external timer between the charging cable and the electrical outlet.
- Do not use any adapters between the charging cable and the electrical outlet.

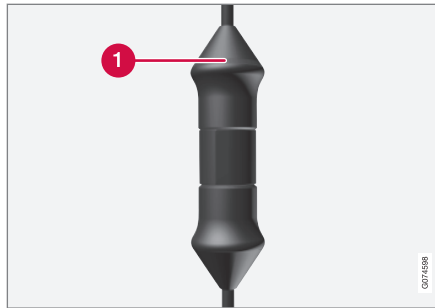

Control module's LED² indicator.

1 LED indicator

If the charging cable's residual current device is triggered, the LED indicator will light up red. Have the outlet checked by a licensed electrician or try using another wall outlet.

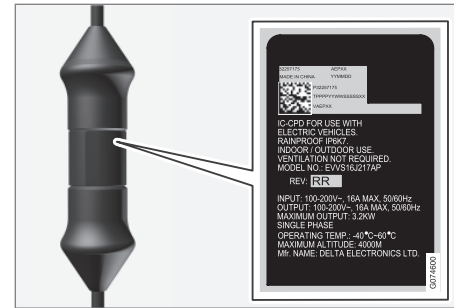

⚠ CAUTION

- Check the capacity of the socket.
- Other electronic equipment connected on the same fuse circuit must be disconnected if the total load is exceeded.
- Do not connect the charging cable if the socket is damaged.

Related information

- Charge cable (p. 394)
- Charging status in the charging cable's control module (p. 401)

² LED (Light Emitting Diode)

Charging cable temperature monitoring

To help ensure the vehicle's hybrid battery is reliably charged each time it is connected, charging is stopped if the temperature in the charging cable becomes too high and reaches a critical limit.

! CAUTION

If charging is often inadvertently interrupted, have the charging cable and the vehicle's charging system inspected by a trained and qualified Volvo service technician.

Related information

- Charge cable (p. 394)
- Charging status in the charging cable's control module (p. 401)

Opening and closing the charging socket cover

The cover for the hybrid battery's charging socket opens manually.



- ➔ Press in the rear edge of the charger door and release.
- ➔ Open the door.

Perform the following steps in reverse to close the charger door.

Related information

- Initiating hybrid battery charging (p. 397)
- Stopping hybrid battery charging (p. 406)
- Charging the hybrid battery (p. 391)

Initiating hybrid battery charging

The hybrid battery is charged by connecting a charging cable between the vehicle and a 120/240 V outlet (alternating current).

Only use the charging cable supplied with the car or a replacement cable recommended by Volvo.

! CAUTION

Never connect the charging cable if there is a risk of a thunderstorm or there is lightning.



⚠ WARNING

- The charging cable must be grounded when in use. It is equipped with a cord with a grounding conductor and a grounding plug. The plug must be inserted into an appropriate outlet that is properly installed and grounded in accordance with all local codes and ordinances and is not damaged in any way.
- Children should be supervised when in the vicinity of the charging cable when it is plugged in.
- High voltage is present in your electric meter housing and power distribution service panel. Contact with high voltage can cause death or serious personal injury.
- Do not use the charging cable if it is damaged in any way. A damaged or malfunctioning charging cable may only be repaired by a workshop – an authorized Volvo workshop is recommended.
- Always position the charging cable so that it will not be driven over, stepped on, tripped over or otherwise damaged, or cause personal injury.
- Disconnect the charger from the wall outlet before cleaning it.

- Never connect the charging cable to an extension cord or a multiple plug socket.
 - Do not use one or more adapters between the charging cable and the electric outlet.
 - Do not use an external timer between the charging cable and the electrical outlet.
- Also, refer to the manufacturer's instructions for using the charging cable and its components.

⚠ CAUTION

Make sure that the 120/240 V outlet (AC, alternating current) has a power capacity sufficient for charging electric vehicles. If you are uncertain of the capacity, have the outlet checked by a licensed electrician.

Note that the engine must be turned off before beginning charging.

Take out the charging cable from the storage compartment under the cargo area.

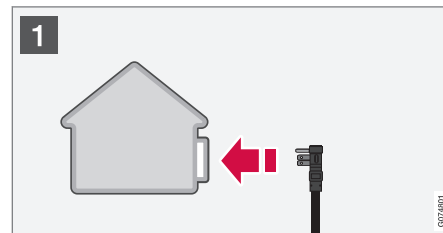

1 Plug the charging cable into a 120/240 V outlet. Never use an extension cord.

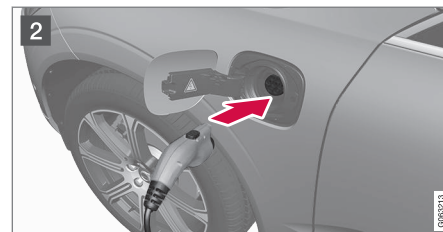

2 Open the charger door. Push the charging handle all the way into the vehicle's socket.

2. The charging cable handle will lock into place and charging will begin within 5 seconds. When charging starts, the green LED light in the charging socket will begin to flash. The approximate remaining charging time or the charging status will be displayed in the instrument panel.

Charging may be temporarily interrupted if the vehicle is unlocked. If the charging cable remains plugged into the charging socket, charging will resume after a moment.

! CAUTION

Never detach the charging cable from the 120/240 V outlet (AC, alternating current) while charging is in progress – the 120/240 V outlet could be damaged in such circumstances. Always interrupt charging first and then disconnect the charging cable – first from the vehicle's charging socket and then from the 120/240 V outlet.

During charging, condensation from the air conditioning may form under the vehicle. This is normal and is caused by the hybrid battery cooling.

Related information

- Charging the hybrid battery (p. 391)
- Opening and closing the charging socket cover (p. 397)
- Charging status in the vehicle's charging socket (p. 399)
- Charging status in the instrument panel (p. 404)
- Charging status in the charging cable's control module (p. 401)
- Stopping hybrid battery charging (p. 406)

Charging status in the vehicle's charging socket

The charging status is indicated by an LED light in the charging socket.

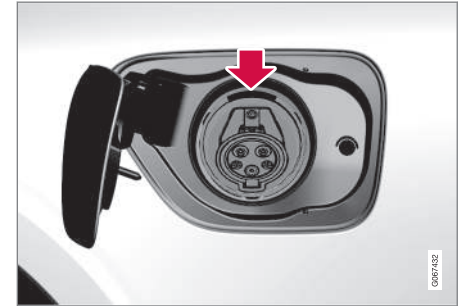

Location of the LED indicator light in the vehicle's charging socket.

The LED indicator light shows the current charge status during charging. If the LED indicator light is not illuminated, check to make sure the cable is securely connected in the wall outlet and in the outlet in the vehicle. A white, red or yellow light illuminates when the passenger compartment lighting is activated and will remain illuminated for a short time after the passenger compartment lighting has gone out.



LED indicator light's color	Meaning
White	Courtesy light
Yellow	Wait mode ^A – waiting for charging to start.
Flashing green	Charging is in progress ^B .
Green	Charging completed ^C
Red	Malfunction.

^A E.g. after a door has been opened or if the charging cable handle is not locked in place.

^B The more slowly the light flashes, the closer the battery is to being fully charged.

^C The light will go out after a short time.

Related information

- Charging the hybrid battery (p. 391)
- Charging status in the instrument panel (p. 404)
- Charging status in the charging cable's control module (p. 401)
- Stopping hybrid battery charging (p. 406)

Charging status in the charging cable's control module

The indicator on the charging cable's control module shows the status of charging in progress and completed charging.



Control module's LED³ indicator.

1 LED indicator

³ LED (Light Emitting Diode)

ELECTRIC MOTOR AND CHARGING



LED	Status	Meaning	Recommended action
Off	Charging is not possible.	No power supply to the charging cable.	<ol style="list-style-type: none"> 1. Unplug the charging cable from the outlet. 2. Plug the charging cable back into the outlet or use another outlet. 3. If the problem persists, contact Volvo Support.
White light	Charging possible.	The charging cable is ready to be plugged into the vehicle.	<p>If the LED indicator is white but charging is not possible:</p> <ol style="list-style-type: none"> 1. Unplug the charging cable from the charging socket. 2. Plug the charging cable back into the charging socket. 3. If the indicator does not begin flashing white within about 10 seconds, first unplug the charging cable from the charging socket and then unplug it from the wall outlet. Plug the charging cable back into the charging socket and the outlet. 4. If the problem persists, contact Volvo Support.
Flashing white	Charging is in progress.	<p>The vehicle's electronic system has initiated charging</p> <p>Charging is in progress.</p>	Wait until the batteries are fully charged.
Steady red light	Charging is not possible.	Temporary error.	<ol style="list-style-type: none"> 1. Unplug the charging cable from the charging socket. 2. Wait a few seconds. 3. Plug the charging cable back into the charging socket. 4. If the problem persists, contact Volvo Support.
Flashing red light	Charging is not possible.	Serious error.	First unplug the charging cable from the charging socket and then from the electrical outlet. If the problem persists, contact Volvo Support.



Related information

- Charging the hybrid battery (p. 391)
- Charging status in the vehicle's charging socket (p. 399)
- Charging status in the instrument panel (p. 404)
- Stopping hybrid battery charging (p. 406)

Charging status in the instrument panel

This information is displayed as long as the instrument panel is active.

Charging status is indicated in the instrument panel using both graphics and messages.

Graphic	Message	Meaning
	<p>Fully charged at: [Time] displayed along with an animated blue pulsing light through the charging cable.</p>	<p>Charging is in progress and the approximate time at which the battery will be fully charged is displayed.</p>
	<p>Charging complete is displayed. An image will be superimposed over the graphic of the vehicle with a green LED indicator light in the socket.</p>	<p>The battery is fully charged.</p>
	<p>Charging error will be displayed. The LED indicator light in the charging socket will be red.</p>	<p>Malfunction. Make sure the charging cable is correctly connected to the vehicle's charging socket and to the 120/240 V outlet (alternating current).</p>

 NOTE

If the instrument panel is not used, it will go dark after a period of time. To reactivate the display:

- depress the brake pedal,
- open one of the doors, or
- put the ignition in mode **I** by turning the **START** knob clockwise and then releasing.

Related information

- Charging the hybrid battery (p. 391)
- Hybrid symbols and messages in the instrument panel (p. 407)
- Charging status in the vehicle's charging socket (p. 399)
- Charging status in the charging cable's control module (p. 401)
- Stopping hybrid battery charging (p. 406)

Stopping hybrid battery charging

To stop charging of the hybrid battery, unlock the vehicle, unplug the charging cable from the vehicle's charging socket and then unplug the cable from the 120/240 V outlet (alternating current).

! CAUTION

Before the charging cable is removed from the vehicle's charging socket, the vehicle must be unlocked using the unlock button on the remote key. This must be done even if the vehicle's doors are already unlocked. If the vehicle is not unlocked using the unlock button, the charging cable or system may be damaged.

i NOTE

Always unlock the vehicle so that charging is cut off before the connection to the 120/240 V outlet (AC, alternating current) is disconnected. Note that the charging cable must be disconnected from the vehicle's charging socket before it is disconnected from the 120/240 V outlet, partly to prevent damage to the system and partly to prevent unintentional interruption of charging.

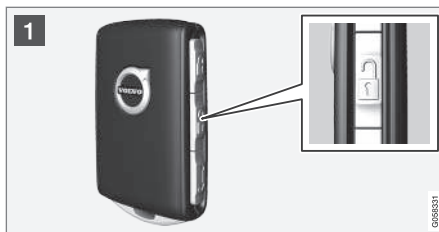

- 1 Unlock the vehicle with the remote key. Charging will stop.

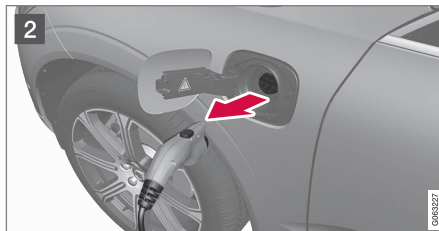

- 2 Press the lock button on the charging cable's handle. The handle will be released/unlocked. Unplug the cable from the vehicle's charging socket and close the charger door.

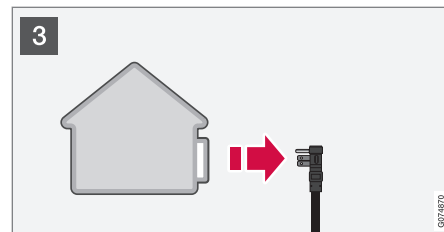

- 3 Unplug the cable from the 120/240 V outlet.

Stow the charging cable in the storage compartment under the cargo area floor.

Charging cable automatically locks

If the charging cable cannot be removed from the charging socket, it will automatically lock into place again after unlocking to maximize charging and range and to enable preconditioning before driving. The charging cable can be removed again if the vehicle is unlocked using the remote key. For vehicles with Passive Entry*, the handle can be used to lock and unlock.







Related information

- Opening and closing the charging socket cover (p. 397)
- Charge cable (p. 394)
- Charging the hybrid battery (p. 391)
- Initiating hybrid battery charging (p. 397)



Hybrid symbols and messages in the instrument panel

A number of symbols and messages relating to the Recharge may be displayed in the

instrument panel. They may also appear in combination with general indicator and warning symbols and disappear when the necessary action has been taken.

Symbol	Message	Meaning
	12 V Battery Charging fault, service urgent. Drive to workshop	Battery fault. Contact a workshop ^A to have the battery checked as soon as possible.
	12 V Battery Charging fault Stop safely	Battery fault. Stop the vehicle as soon as possible and contact a workshop ^A to have the battery checked.
	12 V Battery Fuse failure Service required	Battery fault. Contact a workshop ^A to have the system checked as soon as possible.
	HV battery Overheated, stop safely	The hybrid battery's temperature seems to be rising at an abnormal rate. Stop the vehicle and turn off the engine. Wait at least 5 minutes before driving. Call a workshop ^A or inspect the vehicle to make sure everything seems normal before continuing to drive.
	Reduced performance Max vehicle speed limited	The hybrid battery's charge level is too low for driving at high speeds. Charge the battery as soon as possible.
	Propulsion system Harsh behavior at low speed, vehicle ok to use	The hybrid system is not functioning properly. Contact a workshop ^A to have the system checked as soon as possible.



Symbol	Message	Meaning
	Hybrid system failure Service required	The hybrid system is not functioning. Contact a workshop ^A to have the system checked as soon as possible.
	Charge cable Remove before start	Displayed when the driver attempts to start the vehicle with the charging cable still connected. Remove the charging cable and close the charger cover.

^A An authorized Volvo workshop is recommended.

Related information

- Initiating hybrid battery charging (p. 397)
- Stopping hybrid battery charging (p. 406)
- Charging the hybrid battery (p. 391)
- Indicator and warning symbols (p. 93)
- Hybrid gauge (p. 85)
- Hybrid battery gauge (p. 86)

Long-term storage of vehicles with hybrid batteries

To help minimize degradation of the hybrid battery if the vehicle is not driven for a prolonged period (longer than 1 month) the hybrid battery charge level should be kept at approx. 25% according to the gauge in the instrument panel.

Do as follows:

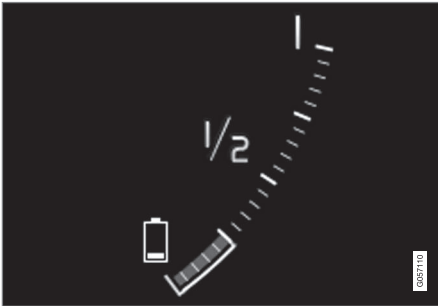

1. If the hybrid battery charge level is high, drive the vehicle until the charge level is approximately 25%. If the charge level is low, charge the battery until the level reaches approximately 25%.

2. If the vehicle is not driven for more than 6 months or the hybrid battery's charge level is noticeably below the 25% mark, charge the battery to about 25% to help compensate for the natural battery discharge that occurs in long-term storage. Regularly check the charge level using the gauge in the instrument display.

i NOTE

Store the vehicle in as cool a location as possible to minimize battery aging during long-term storage. In the summer, park the vehicle indoors or in a shady location, whichever is cooler.

Related information

- Initiating hybrid battery charging (p. 397)
- Hybrid battery gauge (p. 86)
- Charging the hybrid battery (p. 391)

STARTING AND DRIVING

Starting the vehicle

The vehicle can be started using the start knob in the tunnel console when the remote key is in the passenger compartment.



Start knob in the tunnel console.

⚠ WARNING

Before starting:

- Buckle your seat belt.
- Adjust the seat, steering wheel and mirrors.
- Make sure you can fully depress the brake pedal.

The remote key is not physically used to start the ignition because the vehicle is equipped with the keyless Passive Start system.

To start the vehicle:

⚠ CAUTION

The vehicle cannot be started if the charging cable is still plugged in. Make sure to pull out the charging cable from the charging socket before starting the vehicle.

1. The remote key must be inside the vehicle. For vehicles with Passive Start, the key must be in the front section of the passenger compartment. With the optional keyless locking/unlocking function*, the key can be anywhere in the vehicle.
2. Press and hold down the brake pedal¹ as far as possible.
3. Turn the start knob clockwise and release. The control will automatically return to the original position.

⚠ WARNING

- Never use more than one inlay mat at a time on the driver's floor. If any other type of floor mat is used, remove the original mat from the driver's seat floor before driving. All types of mats must be securely anchored in the attachment points in the floor. Make sure the floor mat does not impede the movement of the brake pedal or accelerator pedal in any way, as this could be a serious safety hazard.
- Volvo's floor mats are specially manufactured for your vehicle. They must be properly secured in the attachment points in the floor to help ensure they cannot slide and become trapped under the pedals.

The starter motor will crank until the engine starts or until overheating protection is triggered.

During normal start conditions, the vehicle's electric motor will be prioritized and the gasoline engine will remain off. This means that once the start knob is turned clockwise, the electric motor has been "started" and the vehicle is ready to be driven. The warning and information symbols in the instrument panel

¹ If the vehicle is moving, it is only necessary to turn the start knob clockwise to start the engine.

will go out and the selected theme will be displayed to indicate that the electric motor is activated.

In some situations such as in cold weather or if the hybrid battery's charge level is too low the gasoline engine will start instead.

Error messages

If the **Vehicle key not found** message is shown in the instrument panel at start, place the remote key at the backup reader and then make a new start attempt.



Location of the backup reader in the tunnel console.

i NOTE

When the remote key is placed in the backup reader, make sure that no other vehicle keys, metal objects or electronic devices (e.g. cellular phones, tablets, laptops or chargers) are in the backup reader. Multiple vehicle keys close to each other in the backup reader can disrupt their functionality.

If **Vehicle start System check, wait** is displayed in the instrument panel while attempting to start the vehicle, wait until the message disappears and try again to start the vehicle.

! CAUTION

If the engine has not responded after 3 attempts – wait for 3 minutes before starting a new attempt. Starting capability increases if the starter battery is given time to recover.

i NOTE

The vehicle cannot be started if the hybrid battery is discharged.

! WARNING

Never remove the remote control key from the vehicle while driving.

! WARNING

- Always remove the remote key from the passenger compartment when you leave the vehicle and make sure the ignition is in mode **O**.
- Always put the gear selector in **P** and apply the parking brake before leaving the vehicle. Never leave the vehicle unsupervised while the engine is running.
- Always open the garage door fully and make sure that ventilation is very good before starting the engine in a garage. The exhaust fumes produced by the vehicle contain carbon monoxide, which is invisible and odorless but very toxic.



! CAUTION

- When starting in cold weather, the automatic transmission may shift up at slightly higher engine speeds than normal until the automatic transmission fluid reaches normal operating temperature.
- Do not race a cold engine immediately after starting. This could prevent fluids from properly lubricating vital components in the engine before it has reached the proper operating temperature.
- The engine should be idling when the gear selector is moved. Never accelerate until the gear is fully engaged. Accelerating rapidly before a gear is properly engaged could lead to harder wear of components.
- To help prevent the transmission oil from overheating, select **P** or **N** when idling at a standstill for prolonged periods of time.

i NOTE

With a cold start, idling speed may be considerably higher than normal for certain engine types. This is done to get the emissions system up to normal operating temperature as quickly as possible, which minimizes exhaust emissions and protects the environment.

Related information

- Switching off the vehicle (p. 414)
- Ignition modes (p. 415)
- Adjusting the steering wheel (p. 195)
- Jump starting using another battery (p. 455)
- Selecting ignition mode (p. 416)

Switching off the vehicle

The vehicle can be switched off using the start knob in the tunnel console.



Start knob in the tunnel console.

To switch off the vehicle:

- Turn the start knob clockwise and release to switch off the vehicle. The control will automatically return to the original position.

If the vehicle rolls:

- Turn clockwise and hold the knob until the vehicle switches off.

Related information

- Starting the vehicle (p. 412)
- Ignition modes (p. 415)
- Adjusting the steering wheel (p. 195)

- Jump starting using another battery (p. 455)
- Selecting ignition mode (p. 416)

Ignition modes

The vehicle's ignition can be put in various modes (levels) to make different functions available.

To enable the use of a limited number of functions when the engine is not running, the ignition can be put in one of three different levels: **0**, **I** and **II**. These levels are referred to as "ignition modes" in the Owner's Manual.

The following table shows which functions are available in each ignition mode:

Mode	Functions
0	<ul style="list-style-type: none"> • The odometer, clock and temperature gauge are illuminated^A. • The power* seats can be adjusted. • The power windows can be used. • The center display is activated and can be used^A. • The infotainment system can be used^A. <p>In this mode, the functions are available for a limited time and then switch off automatically.</p>





Mode	Functions
I	<ul style="list-style-type: none"> The panoramic roof, power windows, 12-volt electrical socket in the passenger compartment, Bluetooth, navigation, phone, blower and windshield wipers can be used. The power seats can be adjusted. The 12-volt electrical socket* in the cargo compartment can be used. <p>Electrical current will be taken from the battery in this ignition mode.</p>
II	<ul style="list-style-type: none"> The headlights illuminate. Warning/indicator lights illuminate for 5 seconds. A number of other systems are activated. However, seat and rear window heating can only be activated when the engine is running. <p>This ignition mode uses a lot of current from the battery and should be avoided whenever possible!</p>

^A Also activated when the door is opened.

Related information

- Starting the vehicle (p. 412)
- Adjusting the steering wheel (p. 195)
- Jump starting using another battery (p. 455)
- Selecting ignition mode (p. 416)

Selecting ignition mode

The vehicle's ignition can be put in various modes (levels) to make different functions available.

Selecting an ignition mode



Start knob in the tunnel console.

- Ignition mode 0** – Unlock the vehicle and keep the remote key in the passenger compartment.

i NOTE

To set level **I** or **II** **without** engine start – do **not** depress the brake pedal (or clutch pedal for vehicles with manual transmission) when selecting this ignition mode.

- Ignition mode I** – Turn the start knob clockwise and release it. The control will

automatically return to the original position.

- **Ignition mode II** – Turn the start knob clockwise and hold it there for approx. 5 seconds. Release the knob, which will automatically return to its original position.
- **Back to ignition mode O** – To return to ignition mode **O** from modes **I** and **II**, turn the start knob clockwise and release it. The control will automatically return to the original position.

Related information

- Starting the vehicle (p. 412)
- Switching off the vehicle (p. 414)
- Ignition modes (p. 415)
- Adjusting the steering wheel (p. 195)
- Jump starting using another battery (p. 455)

Brake functions

The vehicle's brakes are used to reduce speed or prevent the vehicle from rolling. In addition to the wheel brakes and parking brakes, the vehicle is also equipped with a number of automatic brake assist functions. These systems provide assistance by e.g. the driver not needing to depress the brake pedal at a traffic light or when starting up a hill.

Depending on how the vehicle is equipped, the following brake assist functions may be included:

- Auto-hold brake function at a standstill (Auto Hold)
- Hill Start Assist (Hill Start Assist)
- Braking assist after a collision
- City Safety

Related information

- Brakes (p. 417)
- Parking brake (p. 421)
- Auto-hold brakes (p. 424)
- Braking assist after a collision (p. 426)
- Hill Start Assist (p. 426)
- City Safety™ (p. 321)

Brakes

The brake pedal is used to apply the vehicle's regular brakes, which are part of the brake system.

The vehicle is equipped with two brake circuits. If one brake circuit is damaged, the brake pedal may go down further when depressed. More pressure will then be required from the driver for normal braking effect.

WARNING

The power brakes only work when the electric motor or combustion engine is running.

If the brake pedal is used when the vehicle is switched off, the pedal must be depressed with greater pressure, past the normal braking position, in order to brake the vehicle.

In very hilly areas or when driving with a heavy load, gear position **B** can be used to augment the brakes with engine braking.

Anti-lock brakes

The vehicle is equipped with an Anti-lock Braking System (ABS²), which helps prevent the wheels from locking and helps maintain steering control when braking. Vibrations may

STARTING AND DRIVING

- ◀ be felt from the brake pedal when ABS is operating, which is normal.

After the vehicle is started, a brief test of the ABS system is automatically performed when the driver releases the brake pedal. An additional automatic test of the system may be performed when the vehicle is traveling at a low speed. During the test, the brake pedal may feel as though it is pulsating.

Light braking charges the hybrid battery



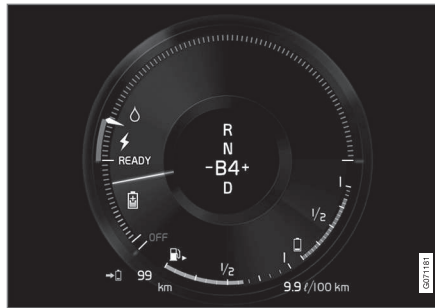

When the brakes are applied lightly, the electric motor braking function is used. This converts the vehicle's kinetic energy into electrical energy, which is used to charge the hybrid battery. When the battery is being charged with the electric motor braking function, this will be indicated in the instrument panel.





When the battery is being charged with the electric motor braking function, this will be indicated in the instrument panel.

This function is active at speeds in the range of 150-5 km/h (93-3 mph). When braking at speeds outside of this range, or during harder braking, the hydraulic braking system is used to augment braking. This is indicated in the instrument panel with the pointer down in the red area.

Symbols in the instrument panel

Symbol	Meaning
 A	Check the brake fluid level. If the level is low, fill brake fluid and check to determine the reason for the loss of brake fluid.
 B	
 A	Fault in pedal sensor.
 B	

Symbol	Meaning
	Steady glow for 2 seconds after the engine is started: Automatic function check.
A	
	Steady glow for more than 2 seconds: Fault in the ABS system. The vehicle's regular brake system is still working, but without the ABS function.
B	
	If the message Brake pedal Characteristics changed Service required is displayed, the "Brake-by-wire" system is not functioning properly. The brake pedal must be depressed with greater pressure, past the normal braking position, in order to brake the vehicle.

A In Canada.
B In the U.S.

WARNING

If the warning symbols for both brake fault and ABS fault are lit simultaneously, there may be a fault in the brake system.

- If the brake fluid reservoir level is normal when this occurs, drive carefully to the nearest workshop to have the brake system checked - an authorized Volvo workshop is recommended.
- If the brake fluid has fallen below the **MIN** level in the brake fluid reservoir, the vehicle should not be driven until the brake fluid has been filled. The reason for the brake fluid loss must be checked.

Related information

- Brake Assist System (p. 419)
- Auto-hold brakes (p. 424)
- Hill Start Assist (p. 426)
- Braking on wet roads (p. 420)
- Braking on salted roads (p. 420)
- Maintenance of the brake system (p. 420)
- Brake lights (p. 159)

Brake Assist System

The brake enhancing system, (BAS³), helps increase braking force and can thereby reduce braking distance.

The system monitors the driver's braking habits and increases braking force when necessary. Braking force can be increased up to the point at which the ABS intervenes.

Related information

- Brakes (p. 417)

³ Brake Assist System

Braking on wet roads

Prolonged driving in heavy rain without braking may cause braking effect to be slightly delayed the first time the brakes are applied. This may also occur after washing the vehicle. It will then be necessary to apply greater pressure to the brake pedal. You should therefore maintain a greater distance to the vehicle ahead.

Firmly apply the brakes after washing the vehicle or driving on wet roads. This helps warm up the brake discs, enabling them to dry more quickly and protecting them against corrosion. Consider the current traffic situation when braking.

Related information

- Brakes (p. 417)
- Braking on salted roads (p. 420)

Braking on salted roads

When driving on salted roads, a layer of salt may form on the brake discs and brake pads. This could increase stopping distance. Maintain an extra large safety distance to the vehicle ahead. Make sure to also:

- Apply the brakes from time to time to help remove salt. Make sure braking does not pose a risk to any other road users.
- Gently apply the brakes when you have finished driving and before driving again.

Related information

- Brakes (p. 417)
- Braking on wet roads (p. 420)

Maintenance of the brake system

Regularly check the brake system components for wear.

To keep the vehicle as safe and reliable as possible, follow the Volvo service schedule specified in the Warranty and Maintenance Records Information booklet. After replacing brake pads and brake discs, braking effect is not adapted until they are "broken in" by driving a few hundred kilometers (miles). Compensate for the reduced braking effect by applying greater pressure to the brake pedal. Volvo recommends only using brake pads approved for your Volvo.

CAUTION

The brake system's components should be regularly checked for wear.

Contact a workshop for advice on how to do this or let a workshop perform the inspection - an authorized Volvo workshop is recommended.

Related information

- Brakes (p. 417)

Parking brake

The parking brake helps keep the vehicle stationary by mechanically locking two wheels.



The parking brake controls are located in the tunnel console between the seats.

When the electric parking brake is being applied, a faint sound can be heard from the brake's electric motor. This sound can also be heard during the automatic function check of the parking brake.

If the vehicle is stationary when the parking brake is activated, it will only be applied to the rear wheels. If it is activated while the vehicle is moving, the normal brakes will be used on all four wheels. Braking will be transferred to only the rear wheels when the vehicle is almost stopped.

Related information

- Activating and deactivating the parking brake (p. 421)
- Parking on a hill (p. 423)
- Parking brake malfunction (p. 423)
- Auto-hold brakes (p. 424)

Activating and deactivating the parking brake



Use the parking brake to help keep the vehicle stationary when it is parked.

Activating the parking brake



1. Pull up the control.
 - > The symbol in the instrument panel will illuminate when the parking brake is activated.
2. Make sure the vehicle is stationary.

Symbol in the instrument panel

Symbol	Meaning
	The symbol will be illuminated when the parking brake is activated.
A	A flashing symbol indicates that a fault has been detected. Read the message in the instrument panel.
	
B	

A Canadian models.
B US models.

Automatic activation

The parking brake is applied automatically

- when the ignition is switched off and the setting for automatically activating the parking brake is activated in the center display.
- when the gear selector is moved to **P** on a steep hill.
- if the auto-hold brake (automatic brake at standstill) function is activated and
 - the vehicle has been stationary for a prolonged period of time (5-10 minutes).
 - the vehicle is switched off.
 - the driver has left the vehicle.

Emergency braking

In an emergency, the parking brake can be activated when the vehicle is moving by pulling and holding up the control. The braking process is canceled when the control is released or if the accelerator pedal is depressed.

NOTE

In case of emergency braking at high speeds, a signal sounds during the brake procedure.

Deactivating the parking brake



Deactivating manually

The parking brake can only be deactivated if the engine is running.

1. Depress the brake pedal firmly.

2. Press the control.

- > The parking brake will release and the symbol in the instrument panel will go out.

Deactivating automatically

1. Start the vehicle.
2. Depress the brake pedal firmly. Move the gear selector to **D** or **R** and press the accelerator pedal.
 - > The parking brake will release and the symbol in the instrument panel will go out.

NOTE

For automatic deactivation to be possible, the driver's seat belt must be buckled or the driver's door closed.

Related information

- Settings for automatically activating the parking brake (p. 423)
- Parking brake malfunction (p. 423)
- Parking brake (p. 421)
- Parking on a hill (p. 423)

Settings for automatically activating the parking brake

Choose whether the parking brake should be activated automatically when the vehicle is switched off.

To change this setting:

1. Tap **Settings** in the center display's Top view.
2. Tap **My Car → Parking Brake and Suspension** and select or deselect the **Auto Activate Parking Brake** function.

Related information

- Activating and deactivating the parking brake (p. 421)
- Parking brake (p. 421)

Parking on a hill

Always use the parking brake when parking on a hill.

WARNING

Always apply the parking brake when parking on an incline. Selecting a gear or putting the automatic transmission in **P** may not be sufficient to keep the vehicle stationary in all situations.

If the vehicle is pointing uphill:

- Turn the front wheels so they are pointing **away from** the curb.

If the vehicle is pointing downhill:

- Turn the front wheels so they are pointing **toward** the curb.

Heavy load uphill

Heavy loads, such as a trailer, could cause the vehicle to roll backward when the parking brake is released automatically on steep uphill gradients. To help avoid this, pull the control upward while you are driving away. Release the control when the vehicle gains traction.

Related information

- Activating and deactivating the parking brake (p. 421)

Parking brake malfunction

If you are unable to deactivate or activate the parking brake after several attempts, contact an authorized Volvo workshop.

A audible warning signal will sound if the parking brake is activated while the vehicle is being driven.

If the vehicle must be parked before the problem is rectified, turn the wheels as when parking on an incline and put the gear selector in **P**.





Low battery charge level

If the battery charge level is too low, it will not be possible to activate or deactivate the parking brake. Connect an auxiliary battery to the vehicle if the battery is discharged.

Replacing brake pads

Due to the design of the electric parking brake, the rear brake pads must be replaced by a workshop. An authorized Volvo workshop is recommended.

◀ Symbols in the instrument panel

Symbol	Meaning
 A	A flashing symbol indicates that a fault has been detected. See the message in the instrument panel.
 B	
 A	Fault in the brake system. See the message in the instrument panel.
 B	
	Information message in the instrument panel.

A Canadian models.
 B US models.

Related information

- Activating and deactivating the parking brake (p. 421)
- Parking on a hill (p. 423)
- Starter battery (p. 601)
- Volvo's service program (p. 582)

Auto-hold brakes

With the Auto-hold brake function, the driver can release the brake pedal and the brakes will remain applied, for example, when the vehicle has stopped at a traffic light or intersection.



When the vehicle stops, the brakes are activated automatically. The function can use either the normal brakes or the parking brakes to keep the vehicle stationary and works on flat surfaces or hills. If the driver has their seat belt fastened and/or if the driver's door is closed, the brakes will disengage automatically when the vehicle starts driving.

	NOTE
When braking to a stop on an uphill or downhill gradient, depress the brake pedal with slightly more force than usual before releasing to ensure that the vehicle cannot move at all.	

The parking brake is activated if

- the vehicle is switched off.
- the driver's door is opened
- the driver's seat belt is removed
- the vehicle has been stationary for a prolonged period of time (5-10 minutes)

Symbols in the instrument panel

Symbol	Meaning
	This symbol illuminates when the function is using the normal brakes to keep the vehicle stationary.
 A	This symbol illuminates when the function is using the parking brake to keep the vehicle stationary.
 B	

A Canadian models.

B US models.

Related information

- Activating and deactivating Auto-hold at a standstill (p. 425)
- Brakes (p. 417)
- Parking brake (p. 421)
- Hill Start Assist (p. 426)

Activating and deactivating Auto-hold at a standstill

The Auto-hold brake function at a standstill is activated with the button in the tunnel console.



- Press the button in the tunnel console to activate or deactivate the function.
 - > The indicator light in the button will illuminate when the function is activated. The function will remain active the next time the vehicle is started.

When shutting off



If the function is active and holding the vehicle stationary using the normal brakes (A symbol lit in the instrument panel), the brake pedal must be depressed while pressing the button in order to deactivate Auto-hold.

- The function will remain off until it is reactivated.
- When Auto-hold is switched off, Hill Start Assist (HSA) will remain active to help prevent the vehicle from rolling backward when starting up a hill.

Related information

- Auto-hold brakes (p. 424)

Hill Start Assist

The function for assisting when starting the vehicle on inclines (HSA⁴) helps prevent the vehicle from rolling backward when starting on an uphill gradient. When backing up a hill, HSA helps prevent the vehicle from rolling forward.

The function retains pressure from the brake pedal in the brake system for several seconds after the brake pedal has been released.

This temporary braking effect is released after a few seconds or when the driver begins driving.

Hill Start Assist is activated when the vehicle is stopped on steep inclines. The function is available even when the Auto-hold brake function is switched off.

Related information

- Auto-hold brakes (p. 424)
- Brakes (p. 417)

Braking assist after a collision

In a collision in which the activation level is reached for the pyrotechnic seat belt tensioners or airbags, or if a collision with a large animal is detected, the vehicle's brakes will be automatically activated. This function is intended to help prevent or reduce the effects of any subsequent collision.

After a serious collision, it may no longer be possible to control and steer the vehicle. In order to avoid or mitigate a possible further collision with a vehicle or an object in the vehicle's path, the brake assist system is activated automatically to help stop the vehicle safely.

If braking is not appropriate, e.g. if there is a risk of being hit by passing traffic, the driver can override the system by depressing the accelerator pedal.

This function assumes that the brake system is intact after a collision.

Related information

- Rear Collision Warning* (p. 341)
- BLIS* (p. 342)
- Brake functions (p. 417)

Regenerative braking*

The vehicle recovers kinetic energy during braking in order to reduce fuel consumption and emissions.



The battery symbol is shown in the driver display when the car is generating power for the battery.

The function is available in all drive modes together with gear selector position **D** or **B**.

Activating brake regeneration

Brake regeneration is activated by gentle pressure on the brake pedal or during engine braking.

Regeneration increases during engine braking if manual gear selector position **B** is selected.

Related information

- Drive modes (p. 434)
- Shifting gears with automatic transmission (p. 428)

⁴ Hill Start Assist

Transmission

The transmission is part of the vehicle's drive-line (power transmission) between the engine and the drive wheels. The function of the transmission is to change gears depending on speed and power needs.

The vehicle has an 8-speed automatic transmission and an electric motor for rear-wheel drive. The number of gears allows the engine's torque and power band to be effectively utilized.

Two of the gears are overdrive gears that save fuel when driving at a constant engine speed. Both the gear selector and the steering wheel paddles can be used to shift up or down manually. The selected gear selector position will be displayed in the instrument panel.

Related information

- Automatic transmission (p. 427)

Automatic transmission

Gear position is selected automatically to make driving as energy efficient as possible. The transmission also has a manual mode.

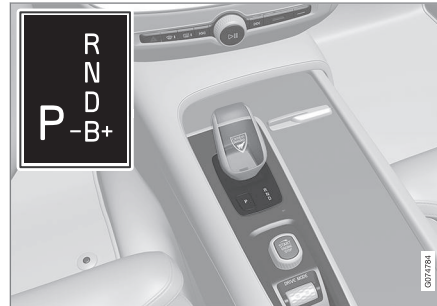

Overview of gear selector and gear shift pattern in the instrument panel.

The selected gear selector position is displayed in the instrument panel:

P, R, N, D or B.

Related information

- Shifting gears with automatic transmission (p. 428)
- Using the steering wheel paddles* to shift (p. 429)
- Shiftlock (p. 431)
- The kickdown function (p. 431)
- The Launch function* (p. 431)

- Automatic transmission symbols and messages (p. 432)

Shifting gears with automatic transmission

Change gear position by pushing the spring-loaded gear selector forward or rearward, or to the side for manual shifting.

Selecting gears



Gear selector and gear selector positions overview.

Gear selector positions

Parking – P



Gear selector and P position overview.

Parking is activated using the **P** button located next to the gear selector.

In the **P** position, the transmission is mechanically locked.

Select **P** position when the vehicle is parked. The vehicle can be started when it is in **P** position. The vehicle must be stationary when **P** is selected.

When parking – apply the parking brake before shifting to position **P**.

WARNING

Always apply the parking brake when parking on an incline. Selecting a gear or putting the automatic transmission in **P** may not be sufficient to keep the vehicle stationary in all situations.

NOTE

The gear selector must be in position **P** in order to lock the vehicle and set the alarm.

Help functions

The system will switch to the **P** position automatically:

- if the ignition is switched off while **D** or **R** is selected.
- if the driver unbuckles the seat belt and opens the driver's door while the vehicle is running with a gear other than **P** selected.

To park a vehicle with an unbuckled seat belt and open door – end **P** mode by shifting to **R** or **D** again.

If the vehicle is switched off in gear position **N**, it will not automatically switch to the **P** position. This makes it possible to wash the vehicle in an automatic car wash.

Reverse – R

Select **R** when backing up. The vehicle must be stationary when **R** is selected.

Neutral – N

In **N** position, the vehicle can roll freely. The vehicle can be started when it is in **N** position. Apply the parking brake if the vehicle is stationary with the gear selector in the **N** position.

To move to another gear position when **N** is selected, the brake pedal must be depressed and the ignition in mode **II**.

D drive mode

D is the normal driving gear position. The transmission shifts up or down automatically depending on acceleration and speed.

The vehicle must be stationary when the gear selector is moved from **R** to **D**.

Brake – B

Brake position in instrument panel overview.

With position **B**, it is possible to shift gears manually. When the accelerator pedal is released, the electric motor brakes the vehicle and the hybrid battery is recharged at the same time.

B position is selected by moving the gear selector rearward from **D**.

- Push the gear selector to the right toward "+" (plus) and release to shift up one gear.
- Push the gear selector to the left toward "-" (minus) and release to shift down one gear.
- Push the gear selector rearward to return to **D** mode.

For smooth shifting and engine performance, the transmission will shift down automatically if the vehicle's speed becomes too low for the selected gear.

Related information

- Automatic transmission (p. 427)
- Shiftlock (p. 431)
- Using the steering wheel paddles* to shift (p. 429)
- The kickdown function (p. 431)

Using the steering wheel paddles* to shift

The steering wheel paddles are a supplement to the gear selector and make it possible to shift manually without removing your hands from the steering wheel.

The function is available in position **D** or **B**.



- 1 "-": Shift down one gear.
- 2 "+": Shift up one gear.

Change

To shift:

- Pull one of the paddles toward the steering wheel and then release.

As long as the engine speed (rpm) is within the permissible range for the selected gear, a gear shift will take place each time a paddle is



STARTING AND DRIVING

- ◀ pulled. The current gear will be displayed in the instrument panel.

In the **B** position, the paddles are automatically activated.



Instrument panel when the paddles are activated for shifting in manual mode.

Activating the steering wheel paddles in the D position

To be able to shift gears using the paddles, they must be activated:

- Pull one of the paddles toward the steering wheel.
 - > A number in the instrument panel indicates the current gear being used.



Instrument panel when the paddles are activated for shifting.

Turning off the steering wheel paddles in the D position

Manual deactivation

- Pull the right paddle (+) toward the steering wheel and hold it there until the number in the instrument panel goes out.
 - > The transmission will return to the **D** position.

Automatic deactivation

The steering wheel paddles will switch off after a short time if they are not being used. The number of the current gear will no longer be displayed in the instrument panel. If engine braking is currently being used, the paddles will remain active until engine braking stops.

Related information

- Automatic transmission (p. 427)
- Shifting gears with automatic transmission (p. 428)

Shiftlock

The automatic transmission's shiftlock function helps prevent inadvertently moving the gear selector between different positions.

Automatic shiftlock

The automatic shiftlock has a separate safety system.

From Park – P or Neutral – N

To move the gear selector from **P** or **N** to another gear selector position, the brake pedal must be depressed and the ignition in mode **II**. For some transmission variants, the engine must be running.

If the gear selector is in **N** and the vehicle has been stationary for at least 3 seconds (with or without the engine running), the gear selector will be locked in that position.

Messages in the instrument panel

If the gear selector is locked in position a message will appear in the instrument panel e.g. **Gear lever Press brake pedal to activate gear lever.**

There is no mechanical shiftlock function.

Related information

- Automatic transmission (p. 427)
- Shifting gears with automatic transmission (p. 428)

The kickdown function

Kickdown can be used when maximum acceleration is needed e.g. when passing. When the accelerator pedal is depressed all the way to the floor (past the normal full accelerator position), the transmission will automatically engage kickdown, i.e. immediately shift down to a lower gear.

If the accelerator pedal is released from the kickdown position, the transmission will automatically shift up again.

Safety function

The transmission control module is equipped with a downshift protection feature to help prevent the engine from overheating.

In some conditions, the transmission will prevent downshifting/kickdown if this would lead to such high engine speed (rpm) that the engine could be damaged. If the driver still attempts downshifting or kickdown at a high rpm, nothing will happen and the original gear will remain selected.

With kickdown, the vehicle can downshift one or more steps at a time depending on the engine speed. The vehicle upshifts when the engine reaches its maximum rpm to prevent engine damage.

Related information

- Automatic transmission (p. 427)

The Launch function*

Launch can be used to provide maximum acceleration from a standstill. The function is available for the drive modes: **Hybrid, Constant AWD, Power and Individual.**

Activating Launch

Make sure that the vehicle is stationary and that the wheels are pointing straight ahead.

1. Put the gear selector in **D** position.
2. Depress the brake pedal fully.
3. Then fully depress the accelerator pedal.
4. Release the brake pedal within 2 seconds.

i NOTE

If the Launch function does not work, wait a few minutes to let the driveline reach working temperature before trying again.

! CAUTION

The driveline is exposed to wear when using Launch and the function is therefore only available a limited number of times.

Related information



- Automatic transmission (p. 427)

Automatic transmission symbols and messages

If a problem occurs with the transmission, a symbol and a message are displayed in the instrument panel.

CAUTION

Check the operating temperature of the transmission to help avoid damage to any of the drive system components. If there is a risk of overheating, a warning symbol will appear in the instrument panel and a text message will be displayed. Follow the recommendations given.

Symbol	Meaning
	A fault has occurred in the transmission. Read the message in the instrument panel.
	Hot or overheated transmission. Read the message in the instrument panel.
	Temporary fault in driveline. Read the message in the instrument panel.

Related information

- Automatic transmission (p. 427)

All Wheel Drive (AWD)

All-wheel drive (AWD⁵), also called four-wheel drive, means that power is distributed to all four wheels, which improves traction.

The electric motor that powers the rear wheels enables electronic all-wheel drive functionality. All-wheel drive reacts differently depending on which drive mode is selected.

Related information

- Drive modes (p. 434)
- Transmission (p. 427)

Drive systems

The vehicle combines a combustion engine for the front wheels and an electric motor for the rear wheels.

Two drive systems

Depending on the selected drive mode and power available in the electric motor, the drive systems can either be used separately or in tandem.

The electric motor gets its energy from a hybrid battery located under the tunnel console. The hybrid can be charged from a wall outlet or in a special charging station. The combustion engine can also charge the hybrid battery using a special high-voltage generator.

Both the combustion engine and the electric motor can generate power directly to the wheels. An advanced control system coordinates both the drive systems to help optimize driving economy.

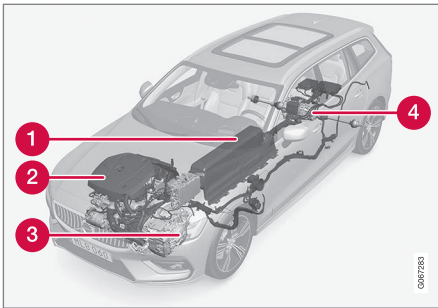

- 1 Hybrid battery - The hybrid battery's function is to store electrical current. This energy is provided by plugging the charging cable into an electrical outlet, through regenerative braking or from the high-voltage generator. This provides current to power the electric motor and to temporarily power the electrical air conditioning to precondition the passenger compartment.
- 2 Combustion engine - The combustion engine starts when the charge level in the hybrid battery is too low to provide the power output requested by the driver.
- 3 High-voltage generator⁶ - Charges the hybrid battery. Starter for the combustion

engine. Can provide the combustion engine with extra electrical current.

- 4 Electric motor - Powers the vehicle using electricity. Can provide extra torque and power during acceleration. Provides electrical all-wheel drive functionality. Regenerates braking energy into electrical current.

Related information

- General information about electric vehicles (p. 390)
- Starting and stopping the combustion engine (p. 433)
- Drive modes (p. 434)
- Transmission (p. 427)

Starting and stopping the combustion engine

An advanced control system determines the distance that the vehicle can be driven on the combustion engine, electric motor, or both at the same time. When driving on only the electric motor, the vehicle may automatically start the combustion engine due to outside circumstances, e.g. low ambient temperatures. This is completely normal. The combustion engine will also always start when the hybrid battery is nearly fully discharged.

Climate settings at low temperatures

At low ambient temperatures, the combustion engine will sometimes start automatically to help achieve the desired passenger compartment temperature and air quality. The amount of time the combustion engine is running can be affected by

- lowering the temperature
- reducing blower speed
- activating **Pure** drive mode.

Using the electric motor in hot or cold weather

At very low or high ambient temperatures, the electric motor's driving range and power may be reduced and affect how often the combustion engine automatically starts.

⁵ All Wheel Drive

⁶ CISG (Crank Integrated Starter Generator) – combined high-voltage generator and starter.

◀ Emission control system

To help ensure that the emission control system is as energy-efficient as possible, the combustion engine will run for several minutes after it is started. The amount of time the combustion engine needs to be used varies depending on the temperature of the three-way catalytic converter.

WARNING

California Proposition 65

Operating, servicing and maintaining a passenger vehicle can expose you to chemicals including engine exhaust, carbon monoxide, phthalates, and lead, which are known to the State of California to cause cancer and birth defects or other reproductive harm. To minimize exposure, avoid breathing exhaust, do not idle the engine except as necessary, service your vehicle in a well ventilated area and wear gloves or wash your hands frequently when servicing your vehicle. For more information go to www.P65Warnings.ca.gov/passenger-vehicle.

Related information

- Drive systems (p. 432)
- Economical driving (p. 442)
- Range (p. 443)
- Drive modes (p. 434)

Drive modes

Drive modes affect the vehicle's driving characteristics in different ways to enhance and simplify the driving experience in certain types of situations.

Drive modes enable easy access to the vehicle's many functions and settings in different driving situations. Each drive mode is adapted to help optimize driving characteristics.

- Steering
- Engine/transmission/all-wheel drive
- Brakes
- Shock absorbers
- Instrument panel
- Climate control settings

Select the drive mode that is adapted to the current driving conditions. Keep in mind that not all drive modes are available in all situations.

Available drive modes

WARNING

Please be aware that there is no sound from the engine when the vehicle is being powered by the electric motor and it may be difficult to detect by children, pedestrians, cyclists and animals. This is particularly true at low speeds e.g. in parking lots.

WARNING

Do not leave the vehicle in an unventilated area with a drive mode activated and the combustion engine switched off. The engine will start automatically if the charge level in the hybrid battery is low and the resulting exhaust gases can be very harmful to people and animals.

Hybrid

- This is the default mode in which the electric motor and combustion engine work together.

The vehicle starts in **Hybrid** mode. The control system uses both the electric motor and the gasoline engine – separately or in tandem – and adapts utilization with regard to performance, fuel consumption and comfort. Driving capacity on the electric motor alone is determined by factors such as the hybrid battery's charge level, the need for heat or cooling in the passenger compartment, etc.

If there is sufficient charge in the battery, it is possible to drive solely on electric power. When the accelerator pedal is pressed, only the electric motor will be activated until the battery reaches a certain charge level. Above this level, the current in the battery cannot supply the power requested by the accelerator pedal and the combustion engine will start.

When the hybrid battery's charge level is low, the combustion engine will start more frequently to save the remaining current in the battery. Charge the hybrid battery from a 120-240 volt outlet using a charging cable, or activate **Charge** in Function view to reset the option of only using the electric motor.

This drive mode is designed for low energy consumption with a mix between the electric motor and gasoline engine, without compro-

promising on climate comfort or driving experience. When faster acceleration is requested by the driver, the electric driveline will be utilized to help provide maximum additional power.

The vehicle also monitors the driving conditions and automatically engages all-wheel drive if necessary. All-wheel drive and extra electric power are always available regardless of the battery's charging status.

Information in the instrument panel

When driving in Hybrid mode, a hybrid gauge will be displayed in the instrument panel. The gauge will indicate the amount of electrical current required when the driver depresses the accelerator pedal. The marker between the lightning and the drop shows how much current is available.



The instrument panel gauge when both the electric motor and the combustion engine are being used.



The instrument panel also shows how much current is being restored to the battery (regenerated) during light braking.

« Pure

- Uses the electric motor only, with the lowest possible energy consumption and carbon dioxide emissions.

This drive mode prioritizes the use of the hybrid battery. Certain climate system functions are reduced to provide the longest distance using only electricity.

Pure mode is available when the hybrid battery is sufficiently charged. Even in **Pure** mode, the combustion engine will start if the charge level in the battery gets too low. The combustion engine will also start

- if the vehicle's speed goes above 125 km/h (78 mph)
- if the driver requests more power than the electric motor can provide
- if factors such as cold weather affect the system or components.

i NOTE

The combustion engine may start temporarily in certain situations when **Pure** drive mode is used. This is to provide the wheels with the desired torque in driving situations that require higher loads, such as when towing a trailer or driving up a hill.

This drive mode is adapted for the longest possible driving distance with electric propul-

sion and is primarily intended for use in city driving. **Pure** helps provide the lowest possible consumption even when the hybrid battery is fully discharged. ECO climate is activated to control the climate in the passenger compartment, and in slippery road conditions slightly more wheel spin may be permitted before all-wheel drive is automatically activated.

ECO Climate

In **Pure** mode, ECO climate is automatically activated in the passenger compartment to help reduce energy consumption.

i NOTE

When the **Pure** drive mode is activated, settings for certain climate system and electricity consuming functions are reduced. Some of these settings can be reset manually, but full functionality will only be restored by leaving **Pure** mode or adapting the **Individual** drive mode to full climate system functionality.

If condensation forms on the windows, tap the max defroster button, which will function normally.

Constant AWD

- Improves the vehicle's traction and handling by increasing all-wheel drive.

This drive mode locks the vehicle in all-wheel drive. An adapted distribution between front

and rear axle torque provides effective control, stability and traction, e.g. on slippery roads or when towing a heavy trailer or another vehicle. The **Constant AWD** drive mode is always available regardless of the hybrid battery's charge status.

Both the combustion engine and the electric motor are engaged to enable all-wheel drive, which results in higher fuel consumption.

In the other drive modes, the vehicle automatically adapts the need for all-wheel drive according to the road surface, and can activate the electric motor or start the combustion engine as needed.

Power

- The vehicle gets sportier driving characteristics and a faster acceleration response.

This drive mode adapts the combined power from the combustion engine and the electric motor by providing power to both the front and rear wheels. Gear shifting will be faster and more distinct and the transmission will prioritize gears with a higher traction force. Steering response is faster and suspension is stiffer.

Both the combustion engine and the electric motor are engaged to enable all-wheel drive, which results in higher fuel consumption.

This drive mode is adapted for optimal performance and response during acceleration. It changes the throttle response, gear shifting program and turbo boost system. Chassis settings and steering and brake response are also optimized. The **Power** drive mode is always available regardless of the hybrid battery's charge status.

Power mode is also available in a **Polestar Engineered*** version.

Individual

- Customizes drive mode to personal preferences.

Select one of the drive modes as a basis and adjust the settings to achieve your preferred driving characteristics. These settings will be stored in your driver profile.

Individual drive mode is only available if it has been activated in the center display.

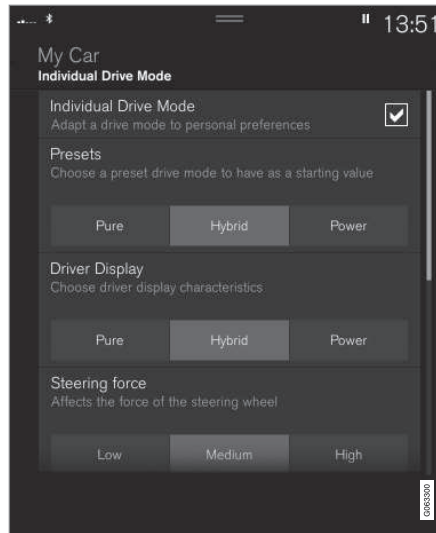

Settings view⁷ for Individual drive mode.

1. Tap **Settings** in the Top view.
2. Tap **My Car** → **Individual Drive Mode** and select **Individual Drive Mode**.

3. Under **Presets**, select one of the following drive modes as a basis: **Pure**, **Hybrid**, **Power** or **Polestar Engineered***.

The following settings can be modified:

- **Driver Display**
- **Steering Force**
- **Powertrain Characteristics**
- **Brake Characteristics**
- **Suspension Control**
- **ECO Climate**

Using the electric or combustion engine

An advanced control system determines the distance that the vehicle can be driven on the combustion engine, electric motor, or both at the same time.

Its primary function is to use the motor/engine and the current available in the hybrid battery as efficiently as possible based on the characteristics of the various drive modes and the power output requested by the driver by pressing the accelerator pedal.

In certain cases, temporary limitations in the system or mandatory functions to help maintain a low overall emissions level may result in greater use of the combustion engine.

⁷ The illustration is generic - details may vary according to vehicle model.

◀◀ **Related information**

- Changing drive mode (p. 438)
- Range (p. 443)
- Energy distribution using map data* (p. 439)
- Hybrid gauge (p. 85)
- General information about electric vehicles (p. 390)
- Regenerative braking* (p. 426)

Changing drive mode

Select the drive mode that is adapted to the current driving conditions.

The drive mode is changed using the control in the tunnel console.

Keep in mind that not all drive modes are available in all situations.

To change drive mode:



1. Press the **DRIVE MODE** control.
 - > A pop-up menu will appear in the center display.
2. Roll the wheel upward or downward to the desired drive mode.

3. Press the drive mode control or tap its button in the center display to confirm the selection.
 - > The selected drive mode is shown in the instrument panel.

Related information

- Drive modes (p. 434)

Energy distribution using map data*

In **Hybrid** drive mode, the vehicle is powered by both the electric motor and the gasoline engine. If a destination has been selected in the navigation system*, the Predictive Efficiency⁸ function can use map data to distribute electric power consumption throughout the trip.

In addition to map data, the function also takes into account speed limits, traffic conditions and differences in altitude.

The electric motor is primarily used when driving at low speeds, for example during stop-and-go city driving. The gasoline engine is primarily used when driving at high speeds and can, under favorable conditions, generate electricity to the electric motor.

Requirements for the function

Certain conditions must be met for the function to be possible:

- A destination must be set in the navigation system and the distance to the destination must be longer than the possible range using only the electric motor.
- **Hybrid** drive mode must be selected.
- The **Hold** and **Charge** functions must be disabled.

⁸ Only certain markets.

Usage tips

If you commute and it is not possible to charge the vehicle at work, enter your workplace as a waypoint and your home as the destination. Discharging of the hybrid battery will then be distributed over the entire commute to and from work.

Add similar commutes, i.e. the route between two charges, as **Favorites** in the navigation system to facilitate access.

Related information

- Regenerative braking* (p. 426)
- Drive modes (p. 434)
- Range (p. 443)

Leveling control* and suspension

Self-leveling and suspension functions are controlled automatically.

Shock absorbers (Four-C)

On vehicles equipped with Four-C, the shock absorbers are adapted to the selected drive mode and the current vehicle speed. The shock absorbers are normally set to help optimize comfort and are adjusted continuously according to the road surface and the vehicle's acceleration, braking and cornering.

Manually adjustable shock absorbers*

The suspension on Polestar Engineered* vehicles can be manually adjusted. There are three recommended modes: Performance, engineered and Comfort.

Performance mode

In Performance mode, the vehicle's suspension feels stiffer.

Engineered, factory setting

Engineered is designed for daily driving.

Comfort mode

In Comfort mode, the vehicle's suspension feels softer.

Symbols and messages

If a problem occurs with the leveling control, a message will be displayed in the instrument panel.

Symbol	Message	Meaning
	Suspension Service required	A fault has occurred. Visit a workshop ^A as soon as possible.

^A An authorized Volvo workshop is recommended.

Related information

- Drive modes (p. 434)
- Adjusting suspension settings Polestar Engineered* (p. 441)

Adjusting suspension settings Polestar Engineered*

The shock absorber settings can be adjusted for driving in other conditions or on particular road surfaces.

Location of adjustment knobs

There are four adjustment knobs, two for the front shock absorbers and two for the rear. There are adjustment knobs above each wheel. The adjustment knobs for the front wheels are located under the engine compartment hood. The adjustment knobs for the rear wheels are located above each wheel in the wheel housing.

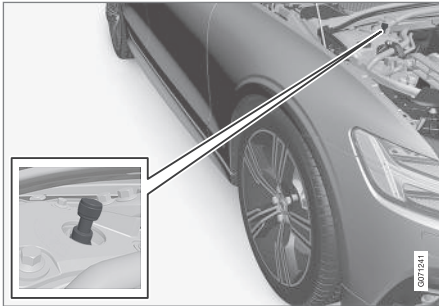

Location of adjustment knob, front wheel.

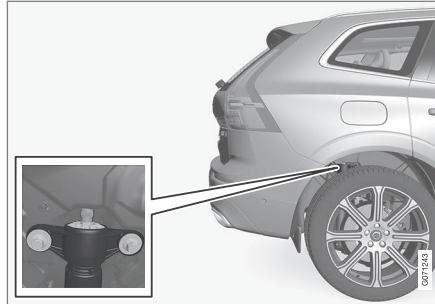

Location of adjustment knob, rear wheel.

i NOTE

Each adjustment knob has 22 adjustment positions. The closer to position 0 the knob is set, the stiffer the suspension.

Adjusting front suspension settings

Make sure the adjustment knob is set to 0 before starting the adjustment. This makes it easier to determine what adjustment position is set.



Turn the adjustment knob clockwise or counterclockwise to change the adjustment position.

- 1** Turn the knob clockwise until it stops to get to adjustment position 0.
- 2** Turn the knob counterclockwise to the desired adjustment position. You should feel and hear a click each time the adjustment position is changed.
 - > Then follow the same procedure for the second shock absorber.

Adjusting rear suspension settings

The rear adjustment knobs are located above the tire inside the wheel housing. To access the rear adjustment knobs, the vehicle must be raised using a jack; see separate section.



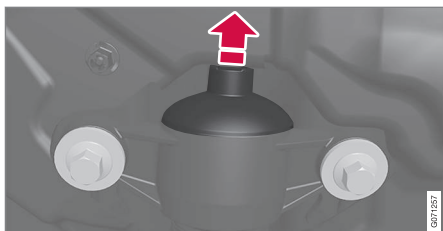

The rubber cap is located above the adjustment knob.

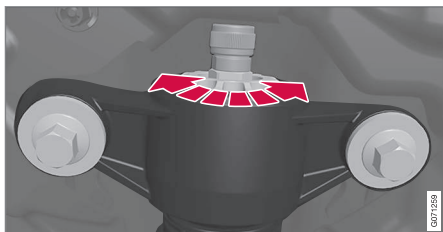

Turn the adjustment knob clockwise or counterclockwise to change the adjustment position.

- 1 Remove the protective rubber cap over the adjustment knob.
- 2 Turn the knob clockwise until it stops to get to adjustment position 0.

- 3 Turn the adjustment knob counterclockwise to the desired adjustment position. You should feel and hear a click each time the adjustment position is changed.
 - > When the desired position has been reached, replace the protective rubber cap. Then follow the same procedure for the second shock absorber.

i NOTE

For optimal performance, Volvo recommends setting the adjustment knobs to the same position for each axle.

Recommended positions

Position	Front	Rear
Performance mode	adjustment position 2	adjustment position 4
Engineered, factory setting	adjustment position 6	adjustment position 9
Comfort mode	adjustment position 12	adjustment position 15

Related information

- Hoisting the vehicle (p. 590)
- Leveling control* and suspension (p. 440)

Economical driving

To achieve the longest possible driving range, the driver should plan the trip and adapt driving style and speed to the current situation.

Before driving

- Whenever possible, precondition the vehicle before driving by connecting the charging cable to an electrical outlet.
- If preconditioning is not possible when it is cold outside, use seat and steering wheel heating first. Avoid heating the entire passenger compartment to reduce the amount of current being taken from the hybrid battery.
- The type of tires and inflation pressure used could affect energy consumption – consult an authorized Volvo retailer for advice on suitable tires.
- Remove unnecessary items from the vehicle - the heavier the load, the higher the fuel consumption.

While driving

- Activate **Pure** drive mode.
- Activate the **Hold** function at high speeds when traveling farther than is possible using the hybrid battery's capacity.
- Whenever possible, avoid using the **Charge** function to charge the hybrid battery.

- Maintain a steady speed and a generous following distance to traffic ahead to minimize braking.
- When braking, the hybrid battery is charged by braking lightly using the brake pedal.
- Higher speeds increase energy consumption because air resistance increases with speed.
- In a cold climate, reduce heating of the windshield/rear window, mirrors, seats and the steering wheel.
- Avoid driving with the windows open.
- Do not use the accelerator pedal to keep the vehicle stationary on an uphill gradient. Instead, activate the auto-hold brake function at a standstill.
- If possible, turn off the climate system when driving shorter distances after preconditioning.
- Displaying trip statistics in the center display (p. 90)
- Auto-hold brakes (p. 424)
- Hold and Charge (p. 445)

After driving

- If possible, park in a climate-controlled garage with vehicle charging outlets or stations.

Related information

- Regenerative braking* (p. 426)
- Range (p. 443)
- Checking tire pressure (p. 543)

Range

A number of factors can affect vehicle range. The ability to achieve a long driving range varies according to the outside conditions and to how the vehicle is driven.

The certified value for the vehicle's range should not be considered an expected driving range. The certified value is obtained during special test cycles and is primarily intended to be used for comparisons between different vehicles.

Range in the instrument panel



When the vehicle leaves the factory, or after a factory reset, range is based on the certified value

Once the vehicle has been driven for a while, range is instead based on historical driving patterns. The amount of history used depends on the battery's charge level. The lower the



STARTING AND DRIVING

- ◀ charge level of the hybrid battery, the more quickly the range adapts to changed driving patterns.

Factors affecting driving range

There are a number of other factors in addition to historical trip data that affect range. The longest range is achieved under very favorable conditions when all factors positively influence range.

Factors affecting range include:

- speed
- climate control settings
- topography
- preconditioning
- tires and tire pressure
- the current traffic situation
- temperature and weather
- road conditions.

Range based on speed and ambient temperature

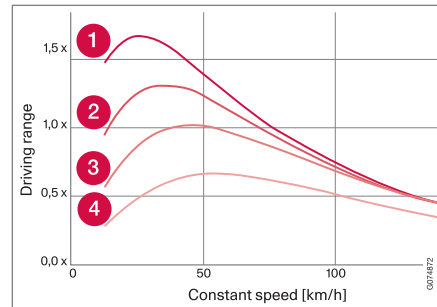

- 1 20 °C (68 °F) ambient temperature and passenger compartment climate control off.
- 2 20 °C (68 °F) ambient temperature and passenger compartment climate control on.
- 3 35 °C (95 °F) ambient temperature and passenger compartment climate control on.
- 4 -10 °C (14 °F) ambient temperature and passenger compartment climate control on.

The graph shows the approximate relationship between constant speed and driving range. Driving at a lower constant speed helps increase the electric motor's driving range.

Higher ambient temperature and deactivated climate system are also more favorable for range.

Related information

- Displaying trip statistics in the center display (p. 90)
- Checking tire pressure (p. 543)

Hold and Charge

In certain situations, it can be useful to control the hybrid battery's charge level while driving. This is possible with the **Hold** and **Charge** functions.

Hold and **Charge** are available in all drive modes. The functions will switch off if **Pure** drive mode is activated.

Activating Hold and Charge

The functions can be activated in the center display's Function view.

Hold



Battery level sustained for later use.

This function retains the charge in the hybrid battery for the electric motor and saves available electrical current for use at a later time, such as when driving in an urban area.

The vehicle will function as in normal hybrid driving with a discharged battery - in addition to reusing energy from e.g. regenerative braking, the combustion engine will be used more frequently to maintain the charge in the battery.

Charge



Engine charges hybrid battery.

This function charges the hybrid battery with the help of the combustion engine for increased use of the electric motor at a later time.

Symbols in the instrument panel



The  symbol is displayed in the hybrid battery gauge when Hold is activated.

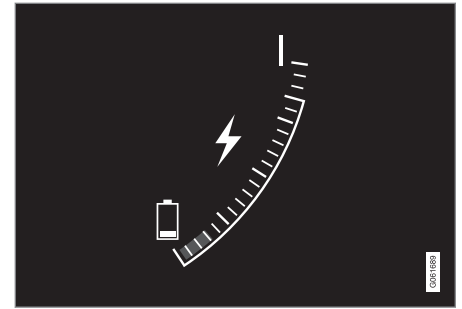

The  symbol is displayed in the hybrid battery gauge when Charge is activated.

Related information

- Range (p. 443)
- Hybrid gauge (p. 85)

Preparing for a long trip

It is important to have the vehicle's systems and equipment checked carefully before driving long distances.

Check that

- the engine is running properly and that fuel consumption is normal
- there are no leaks (fuel, oil or other fluid)
- the brake pedal is functioning properly
- all lights work
- tire tread depth and air pressure are at correct levels. Change to snow tires when driving in areas where there is a risk of snowy or icy roads
- the start battery is sufficiently charged
- the wiper blades are in good condition

Related information

- Checking tire pressure (p. 543)
- Filling washer fluid (p. 643)
- Winter driving (p. 446)
- Economical driving (p. 442)
- Vehicle modem settings (p. 519)
- Loading recommendations (p. 571)
- Driving with a trailer (p. 457)
- Pilot Assist* (p. 294)
- Tire sealing system (p. 557)

Winter driving

It is important to check the vehicle before driving in cold/snowy conditions to make sure it can be driven safely.

Before the cold season arrives:

- Make sure the engine coolant contains 50% antifreeze. This mixture helps protect the engine from frost erosion down to approx. $-35\text{ }^{\circ}\text{C}$ ($-31\text{ }^{\circ}\text{F}$). Do not mix different types of antifreeze as this could pose a health risk.
- Keep the fuel tank well filled to prevent condensation from forming.
- Check the viscosity of the engine oil. Oil with low viscosity (thinner oil) improves cold-weather starting and reduces fuel consumption when driving with a cold engine.
- Check the condition and charge level of the start battery. Cold weather places greater demands on the start battery and reduces its capacity.
- Use washer fluid containing antifreeze to help prevent ice from forming in the washer fluid reservoir.

See separate section for engine oil recommendations.

Slippery driving conditions

To help optimize traction and roadholding, Volvo recommends using snow tires on all wheels whenever there is a risk of snow or ice on the road.

NOTE

Certain countries require use of winter tires by law. Not all countries permit the use of studded tires.

Practice driving on slippery surfaces under controlled conditions to learn how the vehicle reacts.

Related information

- Engine oil specifications (p. 654)
- Snow tires (p. 556)
- Snow chains (p. 556)
- Braking on salted roads (p. 420)
- Braking on wet roads (p. 420)
- Filling washer fluid (p. 643)
- Starter battery (p. 601)
- Replacing windshield wiper blades (p. 641)
- Changing rear window wipers (p. 639)
- Refilling coolant (p. 599)

Driving through standing water

It may be necessary to drive the vehicle through standing water e.g. deep puddles or flooding on the road. This must be done with great caution.

To help prevent damage to the vehicle when driving through water:

- Do not drive in water higher than the floor of the vehicle. If possible, check the depth of the water at its deepest point before driving through it. Be particularly careful when driving through flowing water.
- Do not drive faster than walking speed.
- Do not stop the vehicle in the water. Drive carefully forward or back the vehicle out of the water.
- Remember that waves created by passing vehicles could cause the water level to rise above the vehicle's floor level.
- Avoid driving through salt water to help avoid the risk of corrosion.

CAUTION

Parts of the vehicle (e.g. engine, transmission, driveline, electrical components, etc.) can be damaged if the vehicle is driven through water higher than its floor level. Damage to any components caused by flooding, vapor lock or insufficient oil is not covered under warranty.

If the engine stalls while the vehicle is in water, do not attempt to restart it. Have the vehicle towed on the bed of a tow truck to a workshop - an authorized Volvo workshop is recommended.

CAUTION

Because it can be difficult to determine the water depth, Volvo recommends not driving through standing or running water. The driver is always responsible for operating the vehicle in a safe manner and adhering to all applicable laws and regulations.

When you have passed the water, press lightly on the brake pedal and check that the brakes are functioning properly. Water, mud, slush, etc. can make the brake linings slippery, resulting in delayed braking effect.

If the vehicle is equipped with a trailer coupling contact, clean the contact after driving in water or mud.

Related information

- Recovery (p. 462)

Opening/closing the fuel filler door

A button on the instrument panel is used to unlock the fuel filler door.



An arrow next to the fuel pump symbol in the instrument panel indicates the side of the vehicle on which the fuel filler door is located.



1. Press the button on the dashboard.
 - > Pressure equalization in the fuel tank causes a slight delay before the fuel filler door opens. The message **Preparing for refuel Fuel lid will be unlocked when ready** will appear in the instrument panel. When the system is ready, the message **Fuel tank Ready for refueling** will be shown. If the gasoline engine is activated when the button is pressed, it will usually be deactivated and the vehicle will switch to electric propulsion.

i NOTE

Refueling must be done within approximately 15 minutes of opening the fuel filler door. After this time, the valve opened by pushing the button for opening the fuel filler door will close and it will no longer be possible to refuel without the pump's nozzle switching off.

If the valve is closed before refueling is complete - press the button again and wait until the driver display shows the message **Fuel tank Ready for refueling**.

2. After refueling, press the fuel filler door lightly to close it.

Related information

- Refueling (p. 449)

Refueling

The fuel tank is equipped with a fuel filling system without a cover.

Refueling the vehicle at a service station

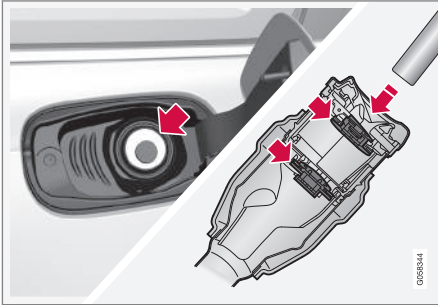

It is important to insert the pump's nozzle past both of the two flaps in the fuel filler pipe before beginning fueling.

Instructions for fueling:

1. Turn off the engine and open the fuel filler door.

i NOTE

Refueling must be done within approximately 15 minutes of opening the fuel filler door. After this time, the valve opened by pushing the button for opening the fuel filler door will close and it will no longer be possible to refuel without the pump's nozzle switching off.

If the valve is closed before refueling is complete - press the button again and wait until the driver display shows the message **Fuel tank Ready for refueling.**

2. Select a fuel approved for use in the vehicle. For more information on approved fuels, see the section on "Fuel".
3. Insert the pump's nozzle into the fuel filler pipe's opening. There are two flaps just inside the fuel filler pipe and the pump's nozzle must push both of these flaps open before fuel can be added.

4. Avoid overfilling the tank. Do not press the handle on the filler nozzle again after it has initially stopped pumping.
 - > The fuel tank is now filled.

i NOTE

An over-full tank may overflow in hot weather.

! CAUTION

Avoid spilling gasoline during refueling. In addition to causing damage to the environment, gasolines containing alcohol can cause damage to painted surfaces, which may not be covered under the New Vehicle Limited Warranty.

Refueling from a fuel container

When filling from a fuel container, use the funnel provided in a foam block under the floor hatch in the cargo compartment.

1. Open the fuel filler door.
2. Insert the funnel into the fuel filler pipe's opening. There are two flaps just inside the fuel filler pipe and the tube section of the funnel must push both of these flaps open before fuel can be added.





WARNING

California Proposition 65

Operating, servicing and maintaining a passenger vehicle can expose you to chemicals including engine exhaust, carbon monoxide, phthalates, and lead, which are known to the State of California to cause cancer and birth defects or other reproductive harm. To minimize exposure, avoid breathing exhaust, do not idle the engine except as necessary, service your vehicle in a well ventilated area and wear gloves or wash your hands frequently when servicing your vehicle. For more information go to www.P65Warnings.ca.gov/passenger-vehicle.

Related information

- Opening/closing the fuel filler door (p. 448)
- Fuel (p. 450)

Fuel

Volvo recommends the use of detergent gasoline to control engine deposits.

Deposit control gasoline (gasoline with detergent additives)

Detergent gasoline is effective in keeping injectors and intake valves clean. Consistent use of deposit control gasolines will help ensure good driveability and fuel economy. If you are not sure whether the gasoline contains deposit control additives, check with the service station operator.

NOTE

Volvo recommends not using external fuel injector cleaning systems, e.g. do not add detergent additives to gasoline before or after refueling.

Unleaded fuel

All Volvo vehicles have a three-way catalytic converter and must only use unleaded gasoline. US and Canadian regulations require that pumps delivering unleaded gasoline are labeled "UNLEADED". Only the nozzles of these pumps will fit in your vehicle's fuel filler inlet. It is unlawful to dispense leaded fuel into a vehicle labeled "unleaded gasoline only". Leaded gasoline damages the three-way catalytic converter and the heated oxygen sensor

system. Repeated use of leaded gasoline will lessen the effectiveness of the emission control system and could result in loss of emission warranty coverage. State and local vehicle inspection programs will make detection of misfueling easier, possibly resulting in emission test failure for misfueled vehicles.

NOTE

Some U.S. and Canadian gasolines contain an octane enhancing additive called methyl-cyclopentadienyl manganese tricarbonyl (MMT). If such fuels are used, your Emission Control System performance may be affected, and the Check Engine Light (malfunction indicator light) located on your instrument panel may light. If this occurs, please return your vehicle to a trained and qualified Volvo service technician for service.

Gasoline containing alcohol and ethers, "Oxygenated fuels"

Some fuel suppliers sell gasoline containing "oxygenates" which are usually alcohols or ethers. In some areas, state or local laws require that the service pump be marked indicating use of alcohols or ethers. However, there are areas in which the pumps are unmarked. If you are not sure whether there is alcohol or ethers in the gasoline you buy, check with the service station operator. To

meet seasonal air quality standards, some areas require the use of "oxygenated" fuel.

Volvo permits the use of the following "oxygenated" fuels. However, the specified octane ratings must still be met.

Alcohol - Ethanol

Fuels containing up to 10% ethanol by volume may be used. Ethanol may also be referred to as Ethyl alcohol, or "Gasohol".

Ethers - MTBE/ETBE: Fuels containing up to 22% MTBE/ETBE by volume may be used.

Methanol

Do not use gasolines containing methanol (methyl alcohol, wood alcohol). This practice can result in vehicle performance deterioration and can damage critical parts in the fuel system. Such damage may not be covered under the New Vehicle Limited Warranty.

Related information

- Octane rating (p. 451)
- Opening/closing the fuel filler door (p. 448)
- Refueling (p. 449)
- Emission controls (p. 453)

Octane rating

Volvo requires premium fuel (91 octane⁹ or higher) for all T5, T6 and T8 engines, and recommends AKI 93 for optimal performance and fuel economy. See decal examples in illustrations 1 and 2.

Minimum octane

Decals



Illustration 1: Sample fuel pump octane label⁹.

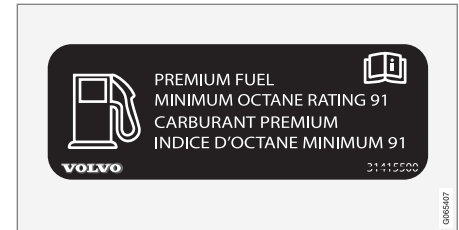

Illustration 2: Decal on the inside of the fuel filler flap on vehicles that require premium fuel¹⁰.

TOP TIER Detergent Gasoline

Volvo endorses the use of "TOP TIER Detergent Gasoline" where available to help maintain engine performance and reliability. TOP TIER Detergent Gasoline meets a new standard jointly established by leading automotive manufacturers to meet the needs of today's advanced engines. Qualifying gasoline retailers (stations) will, in most cases, identify their gasoline as having met the "TOP TIER Detergent Gasoline" standards.

i NOTE

Information about TOP TIER Detergent Gasoline is available at toptiergas.com

⁹ AKI (Anti Knock Index) is an average value of RON (Research Octane Number) and MON (Motor Octane Number) - (RON)+(MON)/2

¹⁰ For supplementary information - see the car's Service and Warranty Booklet.



i NOTE

When switching to higher octane fuel or changing gasoline brands, it may be necessary to fill the tank more than once before a difference in engine operation is noticeable.

Fuel Formulations

Do not use gasoline that contains lead or manganese as a knock inhibitor, and do not use lead additives. Besides damaging the exhaust emission control systems on your vehicle, lead has been strongly linked to certain forms of cancer.

Many fuels contain benzene as a solvent. Unburned benzene has been strongly linked to certain forms of cancer. If you live in an area where you must fill your own gas tank, take precautions. These may include:

- standing upwind away from the filler nozzle while refueling
- refueling only at gas stations with vapor recovery systems that fully seal the mouth of the filler neck during refueling
- wearing neoprene gloves while handling a fuel filler nozzle.

Use of Additives

With the exception of gas line antifreeze during winter months, do not add solvents, thickeners, or other store-bought additives to your vehicle's fuel, cooling, or lubricating systems. Overuse may damage your engine, and some of these additives contain organically volatile chemicals. Do not needlessly expose yourself to these chemicals.

⚠ WARNING

Never carry a cell phone that is **switched on** while refueling your vehicle. If the phone rings, this may cause a spark that could ignite gasoline fumes, resulting in fire and injury.

⚠ WARNING

Carbon monoxide is a poisonous, colorless, and odorless gas. It is present in all exhaust gases. If you ever smell exhaust fumes inside the vehicle, make sure the passenger compartment is ventilated, and immediately return the vehicle to a trained and qualified Volvo service technician for correction.

Demanding driving

In demanding driving conditions, such as when towing a trailer or driving in hot weather or for prolonged periods at high altitudes, it

may be a good idea to switch to a higher-octane fuel (AKI⁹ 91 or higher) or to switch to another brand of gasoline in order to fully utilize the vehicle's engine capacity and optimize traction.

Related information

- Fuel (p. 450)
- Emission controls (p. 453)

⁹ AKI (Anti Knock Index) is an average value of RON (Research Octane Number) and MON (Motor Octane Number) - $(RON)+(MON)/2$

Emission controls

Three-way catalytic converter

- Keep your engine properly tuned. Certain engine malfunctions, particularly involving the electrical, fuel or distributor ignition systems, may cause unusually high three-way catalytic converter temperatures. Do not continue to operate your vehicle if you detect engine misfire, noticeable loss of power or other unusual operating conditions, such as engine overheating or back-firing. A properly tuned engine will help avoid malfunctions that could damage the three-way catalytic converter.
- Do not park your vehicle over combustible materials, such as grass or leaves, which can come into contact with the hot exhaust system and cause such materials to ignite under certain wind and weather conditions.
- Excessive starter cranking (in excess of one minute), or an intermittently firing or flooded engine can cause three-way catalytic converter or exhaust system overheating.
- Remember that tampering or unauthorized modifications to the engine, the Engine Control Module, or the vehicle may be illegal and can cause three-way catalytic converter or exhaust system overheating. This includes: altering fuel injection

settings or components, altering emission system components or location or removing components, and/or repeated use of leaded fuel.

NOTE

Unleaded fuel is required for vehicles with three-way catalytic converters.

Heated oxygen sensors

The heated oxygen sensors monitor the oxygen content of the exhaust gases. Readings are fed into a control module that continuously monitors engine functions and controls fuel injection. The ratio of fuel to air into the engine is continuously adjusted for efficient combustion to help reduce harmful emissions.

Related information

- Octane rating (p. 451)
- Fuel (p. 450)

Overheating of engine and transmission

In certain driving conditions, such as driving in mountainous areas or hot weather, there is a risk of the engine or transmission overheating, especially when carrying heavy loads.

- Engine power may be temporarily limited.
- Remove any auxiliary lights mounted in front of the grille when driving in hot weather.
- If the temperature in the engine's cooling system becomes too high, a warning symbol will appear in the instrument panel along with the message **Engine temperature High temperature Stop safely**. Pull over to a safe location and let the engine idle for a few minutes to cool down.
- If the message **Engine temperature High temperature Turn off engine or Engine coolant Level low, turn off engine** is displayed, stop the vehicle and turn off the engine.
- If the transmission begins to overheat, an alternative gear shifting program will be selected. An integrated protective function will also be activated, the warning symbol will illuminate and the message **Transmission warm Reduce speed to lower temperature or Transmission hot Stop safely, wait for cooling** will be displayed.





- ◀ played in the instrument panel. Follow the recommendations given by reducing speed or stopping the vehicle safely and letting the engine idle for a few minutes to let the transmission cool.
- If the vehicle begins to overheat, the air conditioning may be temporarily switched off.
 - After a prolonged period of driving in demanding conditions, do not turn off the engine immediately after stopping.

i NOTE

It is normal for the engine's cooling fan to operate for a short time after the engine is switched off.

Symbols in the instrument panel

Symbol	Meaning
	High engine temperature. Follow the recommendations provided.
	Low coolant level. Follow the recommendations provided.
	Transmission hot/overheated/cooling. Follow the recommendations provided.

Related information

- Refilling coolant (p. 599)
- Driving with a trailer (p. 457)
- Preparing for a long trip (p. 446)

Battery drain

The electrical functions in the vehicle drain the battery to varying degrees. Avoid using ignition mode II when the engine is switched off. Use ignition mode I instead, as this uses less electrical current.

Note that certain accessories may also drain power from the electrical system. Do not use functions that use a lot of electrical current when the engine is turned off. Examples of such functions are:

- blower
- headlights
- windshield wipers
- audio system (especially at high volume).

If the starter battery voltage is low, a message is shown in the driver display. The vehicle's energy-saving function will then turn off or reduce certain functions, such as the blower and/or the audio system.

- To charge the battery, start the engine and let it run for at least 15 minutes (driving charges the battery faster than letting the engine idle).

Related information

- Starter battery (p. 601)
- Ignition modes (p. 415)

Jump starting using another battery

If the start battery is discharged, current from another battery can be used to start the vehicle.

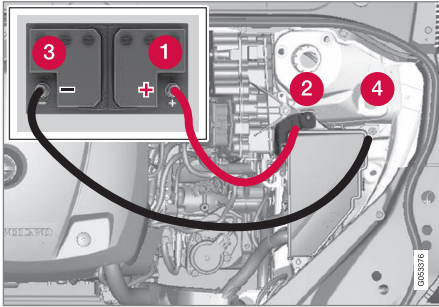

Jumper cable connecting points.

! CAUTION

The charging point of the vehicle is only intended for jump starting the vehicle in question. The charging point is not intended for jump-starting another vehicle. Using the charging point to start another vehicle could cause a fuse to blow, which would cause the charging point to stop working.

If a fuse has blown, **12 V Battery Fuse failure Service required** will be displayed in the

instrument panel. Volvo recommends contacting an authorized Volvo workshop.

To avoid short circuits or other damage, the following steps are recommended when jump starting the battery:

1. Put the ignition in mode **0**.
2. Make sure the auxiliary battery (the battery used to jump start the discharged battery) has a voltage of 12 volts.
3. If the auxiliary battery is in another vehicle, turn off that vehicle's engine and make sure that the vehicles are not touching each other.
4. Clamp the red jumper cable onto the auxiliary battery's positive (+) terminal (1).
5. Fold back the cover over your vehicle's positive (+) jump start terminal (2).
6. Clamp the other end of the red jumper cable to your vehicle's positive (+) jump start terminal (2).
7. Clamp the black jumper cable onto the auxiliary battery's negative (-) terminal (3).
8. Clamp the other end of the black jumper cable to your vehicle's negative (-) ground point (4).
9. Make sure the jumper cables are securely attached to help prevent sparks while jump starting.
10. Start the engine of the assisting vehicle and let it run for a few minutes at a higher idling speed than normal, about 1500 rpm.

! CAUTION

Connect the jump cable carefully to prevent short circuits with other components in the engine compartment.

STARTING AND DRIVING

- ◀ 11. Start your vehicle's engine. If the engine does not start, allow an additional 10 minutes of charging time and then try to start the engine again.

NOTE

When the engine is started under normal conditions, the vehicle's electrical drive motor is prioritized – the gasoline engine remains off. This means that after the start knob has been turned clockwise, the electric motor has "started" and the vehicle is ready to be driven. Start of the electric motor is indicated by the indicator lights on the instrument panel going out and its pre-selected theme illuminating.

CAUTION

Do not touch the connections between the cable and the vehicle during the start attempt. Risk of sparking.

12. Remove the jumper cables in the reverse order – first the black cables and then the red cables.
- Make sure that none of the clamps of the black jumper cables come into contact with either vehicle's positive (+) jump start terminals or either of the red jumper cable's connected clamps.

WARNING

PROPOSITION 65 WARNING! Battery posts, terminals, and related accessories contain lead and lead compounds, chemicals known to the state of California to cause cancer and reproductive harm. Wash hands after handling.

WARNING

- Batteries generate hydrogen gas, which is flammable and explosive.
- Do not connect the jumper cable to any part of the fuel system or to any moving parts. Avoid touching hot manifolds.
- Battery fluid contains sulfuric acid. Do not allow battery fluid to contact eyes, skin, fabrics or painted surfaces.
- If contact occurs, flush the affected area immediately with water. Obtain medical help immediately if eyes are affected.
- Never expose the battery to open flame or electric spark. Do not smoke near the battery. Failure to follow the instructions for jump starting can lead to injury.

NOTE

The vehicle cannot be started if the hybrid battery is discharged.

Related information

- Starting the vehicle (p. 412)
- Ignition modes (p. 415)
- Adjusting the steering wheel (p. 195)
- Selecting ignition mode (p. 416)

Driving with a trailer

There are a number of things to consider when towing a trailer, such as the towbar, the trailer and how the load is distributed in the trailer.

Load-carrying capacity is determined by the vehicle's curb weight. The total weight of all passengers and any installed accessories, e.g. towbar, reduces the vehicle's load-carrying capacity by the corresponding amount.

- Towbars used on the vehicle must be approved for the applicable use.
- Distribute the load on the trailer so that the weight on the towbar complies with the specified maximum towball weight. The tongue weight is calculated as part of the vehicle's payload.
- Increase the tire pressure to the recommended pressure for a full load.
- The engine is subjected to more load than usual when towing a trailer.
- Towing a trailer affects the vehicle's handling, durability and driving economy.
- Do not drive with a heavy trailer when the vehicle is very new. Wait until the mileage has reached at least 1000 km (620 miles).
- On long and steep downgrades, the vehicle's brakes are subjected to much more load than usual. When manually shifting, downshift and adapt speed accordingly.
- Follow applicable regulations regarding permitted speed and weight.
- Drive slowly when towing a trailer up a long and steep incline.
- The maximum trailer weights given only apply to altitudes up to 1000 meters (3280 feet) above sea level. At higher altitudes, engine power (and thus the vehicle's climbing ability) is decreased due to the reduced air density, and the maximum trailer weight must therefore be reduced. The weight of the vehicle and trailer must be decreased by 10% for each additional 1000 m (3280 feet) or part thereof.
- Avoid driving with a trailer on inclines of more than 12%.
- Avoid overloading and other incorrect use.
- The trailer's brakes must be balanced with the vehicle's brakes to help ensure safe stops (follow applicable local regulations).

CAUTION

- Bumper-attached trailer hitches must not be used on Volvos, nor should safety chains be attached to the bumper.
- Trailer hitches attaching to the vehicle rear axle must not be used.
- Never connect a trailer's hydraulic brake system directly to the vehicle brake system, nor a trailer's lighting system directly to the vehicle lighting system. Consult your nearest authorized Volvo retailer for correct installation.
- When towing a trailer, the trailer's safety chains or wire must be correctly fastened to the attachment points provided in the trailer hitch on the vehicle. The safety chain or wire must never be fastened to or wound around the towing ball.

NOTE

The optional detachable trailer hitch may not be available in all markets or on all models. Consult your Volvo retailer.





i NOTE

Extreme weather conditions, towing a trailer, high altitude and lower fuel grade than recommended are factors that can significantly increase the vehicle's fuel consumption.

Trailer weights

⚠ WARNING

Please adhere to the recommendations provided for trailer weight. If the recommendations are not followed, the vehicle and trailer may be difficult to control during evasive maneuvers and braking.

i NOTE

The specified maximum trailer weights are those permitted by Volvo. National vehicle regulations may set additional restrictions on trailer weight and speed. The trailer hitches may be certified for higher towing weights than the vehicle is permitted to tow.

Self-leveling suspension*

The vehicle's self-leveling system attempts to keep the vehicle at a constant level, regardless of load (up to the maximum permitted weight). When the vehicle is stationary, the rear end of

the vehicle will be slightly lowered, which is normal.

Driving in hilly terrain or hot weather

In certain conditions, there is a risk of overheating when driving with a trailer. If overheating of the engine and drive system is detected, a warning symbol will illuminate in the instrument panel and a message will appear.

The automatic transmission adapts the gear for the current load and engine speed.

Steep inclines

Do not lock the automatic transmission into a higher gear than what the engine can handle – it is not always preferable to drive in high gears at low rpm.

Parking on a hill

1. Depress the brake pedal.
2. Apply the parking brake.
3. Put the gear selector in **P**.
4. Release the brake pedal.

Put chocks behind the wheels when the vehicle is parked on a hill with a trailer attached.

Starting on a hill

1. Depress the brake pedal.
2. Put the gear selector in **D**.
3. Release the parking brake.
4. Release the brake pedal and start driving.

Related information

- Trailer Stability Assist* (p. 459)
- Checking trailer lights (p. 460)
- Towing capacity and tongue weight (p. 652)
- Overheating of engine and transmission (p. 453)

Trailer Stability Assist*

Trailer Stability Assist (TSA¹¹) is part of the ESC¹² stability system and is a function designed to help stabilize a vehicle that is towing a trailer when the vehicle and trailer have begun to sway. The function is added when installing a towbar. Contact a Volvo retailer for more information.

Reasons for swaying

A vehicle towing a trailer may begin to sway for various reasons. Normally this only occurs at high speeds. However, if the trailer is overloaded or unevenly distributed, e.g. too far back, there is a risk of swaying even at low speeds.

Swaying may be caused by factors such as:

- The vehicle and trailer are hit by a sudden, strong crosswind.
- The vehicle and trailer are traveling on an uneven road or over a bump.
- Sudden movements of the steering wheel.

Once swaying has begun, it can be difficult or impossible to stop it. This makes the vehicle and trailer difficult to control and there is a risk of swerving into oncoming traffic or driving off the road.

¹¹ Trailer Stability Assist

¹² Electronic Stability Control

Trailer Stability Assist function

Trailer Stability Assist continuously monitors the vehicle's movements, particularly lateral movements. If swaying is detected, the brakes are applied individually on the front wheels, which has a stabilizing effect on the vehicle and trailer. This is often enough to enable the driver to regain control of the vehicle.

If the Trailer Stability Assist function's first attempt is not adequate to stop the swaying motion, the brakes are applied on all wheels and engine power is temporarily reduced. As the swaying motion begins to decrease and the vehicle and trailer have once again become stable, TSA stops regulating the brakes/engine power and the driver regains control of the vehicle.

i NOTE

Trailer Stability Assist is deactivated if the driver activates **ESC Sport Mode** in the center display's menu system.

Trailer Stability Assist may not intervene if the driver tries to compensate for the swaying motion by moving the steering wheel rapidly, because the system will then not be able to determine if it is the trailer or the driver causing the swaying.



When Trailer Stability Assist is activated, the ESC symbol is displayed in the instrument panel.

i NOTE

A vehicle software update is required when a towbar is retrofitted. Contact a Volvo retailer.

Related information



- Driving with a trailer (p. 457)
- Electronic Stability Control (p. 269)

Checking trailer lights

When connecting a trailer, make sure that all of the lights on the trailer are functioning before starting to drive.

Trailer turn signals and brake lights

If one or more of the turn signals or brake lights on the trailer is not working, a symbol and message will be displayed in the instrument panel. The other lights on the trailer must be checked manually by the driver before the vehicle is driven.

Symbol	Message
	<ul style="list-style-type: none"> Trailer turn indicator Right turn indicator malfunction Trailer turn indicator Left turn indicator malfunction
	<ul style="list-style-type: none"> Trailer brake light Malfunction

If any of the trailer's turn signal lights is not working, the turn signal symbol in the instrument panel will also flash more quickly than normal.

Trailer rear fog light

When a trailer is connected, the vehicle's rear fog light may not illuminate and rear fog light functionality is instead transferred to the

trailer. If this is the case, check to see if the trailer is equipped with a rear fog light before activating the vehicle's fog lights when driving with a trailer to help ensure safe operation.

Checking trailer lights*

Automatic check

When the trailer has been connected to the vehicle's electrical system, its lights can be checked by automatically activating them. This function helps the driver check that the trailer's lights are functioning correctly before starting to drive.

In order to perform this check, the vehicle must be switched off.

- When a trailer is connected to the towbar, the message **Automatic Trailer Lamp Check** will appear in the instrument panel.
- Acknowledge the message by pressing the **O** button on the right-side steering wheel keypad.
 - The light check will begin.
- Get out of the vehicle to perform the check.
 - All of the lights on the trailer will begin flashing, and then illuminate separately one at a time.
- Visually check that all of the trailer's lights are functioning correctly.

- After a short time, all of the trailer's lights will start flashing again.
 - The light check is completed.

Disabling the automatic check

The automatic light check can be disabled in the center display.

- Tap **Settings** in the Top view.
- Tap **My Car → Lights and Lighting**.
- Deselect **Automatic Trailer Lamp Check**.

Manual check

If the automatic check has been disabled, the check can be started manually.

- Tap **Settings** in the Top view.
- Tap **My Car → Lights and Lighting**.
- Select **Manual Trailer Lamp Check**.
 - The light check will begin. Get out of the vehicle to perform the check.

Related information

- Driving with a trailer (p. 457)

Towing using a towline

This section refers to one vehicle being towed behind another using a towline.

Never attempt to tow the vehicle behind another vehicle as this could damage the electric motor. The vehicle must instead be lifted onto a tow truck and transported with all four wheels on the bed or lifting platform of the truck (no wheels may touch the road).

Towing another vehicle

Towing another vehicle requires a lot of power - use the **Constant AWD** drive mode. This helps charge the hybrid battery and improve the vehicle's driving and roadholding characteristics.

Before towing another vehicle, check applicable speed limit regulations.

Jump starting

Never attempt to tow the vehicle to start the engine, as this could damage the electric motor. Use an auxiliary battery if the start battery's charge level is so low that the engine cannot be started.

! CAUTION

Attempts to tow-start the vehicle could cause damage to the electrical drive motor and three-way catalytic converter.

Related information

- Attaching and removing the towing eyelet (p. 461)
- Hazard warning flashers (p. 159)
- Recovery (p. 462)
- Jump starting using another battery (p. 455)
- Selecting ignition mode (p. 416)
- Transmission (p. 427)

Attaching and removing the towing eyelet

Use the towing eyelet to tow another vehicle. Screw the towing eyelet securely into place in the threaded outlet behind the cover on the right-hand side of the rear bumper.

i NOTE

If the vehicle is equipped with a towbar, there is no rear attachment for the towing eye.

Attaching the towing eyelet

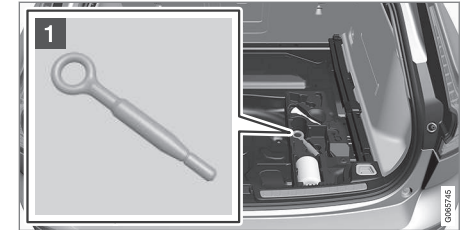

- 1 Take out the towing eyelet, which is stored in a foam block under the floor in the cargo compartment.

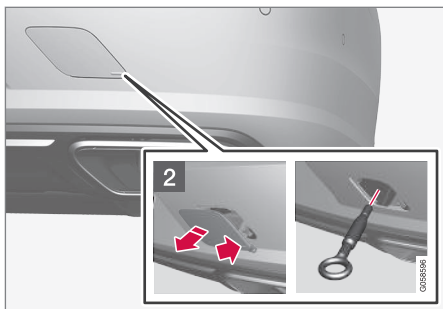

- 2** Remove the cover by pressing on the mark with a finger while folding out the opposite side/corner.
- > The cover turns along its center line and can then be removed.

3. Screw the towing eyelet in as far as possible.

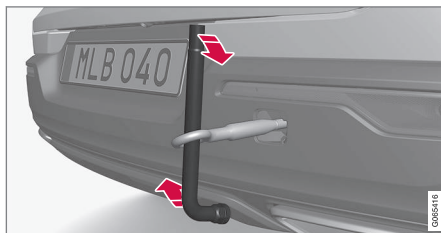

Fasten the eyelet securing by, for example, inserting a lug wrench* through it and using this as a lever.

! CAUTION

It is important that the towing eye is screwed in securely as far as possible.

Removing the towing eyelet

- Unscrew the towing eyelet after use and return it to the foam block.
- Replace the cover on the bumper.

Related information

- Towing using a towline (p. 461)
- Recovery (p. 462)
- Tool kit (p. 552)

Recovery

This section refers to transporting the vehicle with a tow truck or similar vehicle.

Call a professional towing service for assistance.

In certain conditions, the towing eyelet can be used to pull the vehicle onto a flatbed tow truck.

! CAUTION

Note that the vehicle must always be towed raised with all wheels on the tow truck.

The vehicle's location and ground clearance determine if it can be lifted onto a tow truck. If the incline of the tow truck is too steep or if the ground clearance under the vehicle is insufficient, attempting to pull it up may result in damage. In this case, the vehicle should only be lifted with the tow truck's lifting equipment.

⚠ WARNING

No person or object should be behind the tow truck when the vehicle is lifted onto the bed of the truck.

Related information

- Attaching and removing the towing eyelet (p. 461)

HomeLink®*13

HomeLink®14 is a programmable remote control, integrated in the vehicle electrical system, that can control up to three different devices (e.g. garage door opener, alarm system, outdoor and indoor lighting) and thereby replace the remote controls for these.

General

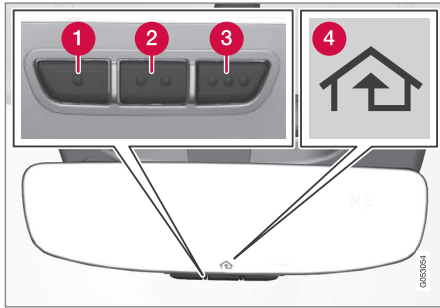

The illustration is generic – the design may vary.

- 1 Button 1
- 2 Button 2
- 3 Button 3
- 4 Indicator light

HomeLink® is delivered integrated in the rear-view mirror. The HomeLink® panel consists of three programmable buttons and an indicator light in the mirror.

For more information about HomeLink®, please visit: homelink.com or call 1-800-355-3515.

Save the original remote controls for future programming (e.g. for use in another vehicle).

! CAUTION

The button programming should be cleared if the vehicle is sold.

Related information

- Using HomeLink®* (p. 465)
- Programming HomeLink®* (p. 463)
- Type approval for HomeLink®* (p. 466)

Programming HomeLink®*15

Follow these instructions to program HomeLink®, reset all programming, or program individual buttons.

i NOTE

In some vehicles, the ignition must be on or in the "accessory position" before HomeLink® can be programmed or used. It can be a good idea to put new batteries in the remote control being replaced by HomeLink® for faster programming and better radio signal transmission. The HomeLink® buttons should be reset before programming.

! WARNING

While HomeLink® is being programmed, the garage door or gate being programmed may be activated. Make sure that no one is near the door or gate during programming. When programming a garage door opener, it is advised to park outside of the garage.

13 Certain markets only.

14 HomeLink and the HomeLink house symbol are registered trademarks of Gentex Corporation.

15 Certain markets only.

STARTING AND DRIVING

1. Point the remote control at the HomeLink® button to be programmed and hold it about 2-8 cm (1-3 inches) from the button. Do not obstruct the HomeLink® indicator light.

Note: Some remote controls are more effective at programming HomeLink® from a distance of about 15-20 cm (6-12 inches). Keep this in mind if you experience any programming difficulties.

2. Press and hold both the remote control button and the HomeLink® button to be programmed.

3. Do not release the buttons until the indicator light has stopped flashing slowly (about once a second) and either flashes quickly (about 10 times a second) or glows steadily.

> **If the indicator light glows steadily:**
Indication that programming is complete. Press the programmed button twice to activate.

If the indicator light flashes quickly:
The device being programmed with HomeLink® may have a security function that requires an extra step. Try pressing the programmed button twice to see whether the programming works. Otherwise, continue with the following steps.

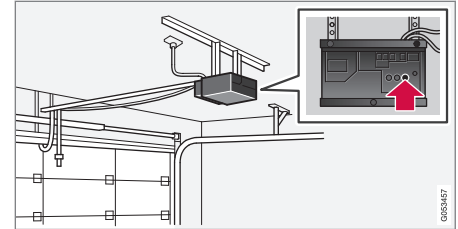

4. Locate the "training" button¹⁶ on the receiver for the e.g. garage door opener. It is usually located near the antenna bracket on the receiver.
5. Press and release the "training" button once. Programming must be completed within 30 seconds after pressing the button.
6. Press and release the HomeLink® button to be programmed. Repeat the press/hold/release sequence a second time. For some receivers, the sequence may need to be repeated a third time.
 - > Programming is now completed and the garage door, gate, etc. should now be activated when the programmed button is pressed.

If you experience any difficulties programming, please contact HomeLink® at: homelink.com, or call 1-800-355-3515.

¹⁶ The name and color of the button varies depending on the manufacturer.

Programming individual buttons

To program an individual HomeLink® button:

1. Press and hold the desired button for about 20 seconds.
2. When the indicator light on HomeLink® starts flashing slowly, it is possible to program as usual.

Note: If the button you are reprogramming does not program with a new device, it will return to the previously saved programming.

Resetting the HomeLink® buttons

It is only possible to reset all HomeLink® buttons at once. It is not possible to reset individual buttons. Individual buttons can only be reprogrammed.

- Press and hold the outer buttons (1 and 3) on HomeLink® for about 10 seconds.
 - > When the indicator light goes from a steady glow to flashing, the buttons have been reset and are ready for reprogramming.

Related information

- Using HomeLink®* (p. 465)
- HomeLink®* (p. 463)
- Type approval for HomeLink®* (p. 466)

Using HomeLink®*¹⁷

Once HomeLink® is programmed, it can be used instead of the separate remote controls. Press and hold the programming button. The garage door, gate, alarm system, etc. will be activated (this may take several seconds). If the button is held down for more than 20 seconds, reprogramming will begin. The indicator light will glow steadily or flash when the button has been pressed. The original remote controls may be used concurrently with HomeLink® if desired.

NOTE

When the ignition is switched off, HomeLink® will be active for at least 7 minutes.

NOTE

HomeLink® cannot be used if the vehicle is locked and the alarm is armed* from the outside.

WARNING

- If you use HomeLink® to open a garage door or gate, be sure no one is near the gate or door while it is in motion.
- Do not use HomeLink® with any garage door opener that lacks safety stop and reverse features as required by U.S. federal safety standards (this includes any garage door opener model manufactured before April 1, 1982). A garage door that cannot detect an object - signaling the door to stop and reverse - does not meet current U.S. federal safety standards. For more information, contact HomeLink at: homelink.com.

Related information

- HomeLink®* (p. 463)
- Programming HomeLink®* (p. 463)
- Type approval for HomeLink®* (p. 466)

¹⁷ Certain markets only.

Type approval for HomeLink®*¹⁸

FCC (USA) and IC (Canada)

This device complies with FCC rules part 15 and Industry Canada RSS-210. Operation is subject to the following two conditions: (1) This device may not cause harmful interference, and (2) This device must accept any interference that may be received including interference that may cause undesired operation.

WARNING

The transmitter has been tested and complies with FCC and IC rules. Changes or modifications not expressly approved by the party responsible for compliance could void the user's authority to operate the device.¹⁹

Type approval for EU

Gentex Corporation hereby declares that HomeLink® Model UAHL5 complies with the Radio equipment directive 2014/53/EU.

Wavelengths within which the radio equipment operates:

- 433.05MHz-434.79MHz <10mW E.R.P.
- 868.00MHz-868.60MHz <25mW E.R.P.

- 868.70MHz-868.20MHz <25mW E.R.P.
- 869.40MHz-869.65MHz <25mW E.R.P.
- 869.70MHz-870.00MHz <25mW E.R.P.

Certificate holder address: Gentex Corporation, 600 North Centennial Street, Zeeland MI 49464, USA

For further details, search for support information on type approval at volvocars.com

Related information

- HomeLink®* (p. 463)

Compass*

An integrated compass²⁰ in the upper right corner of the rearview mirror shows the direction the vehicle is traveling.

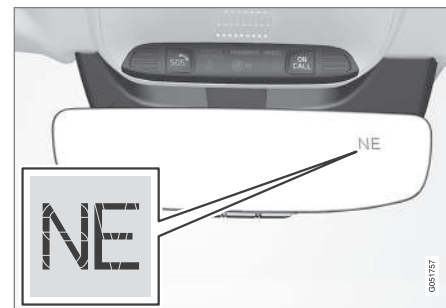

Rearview mirror with compass.

Eight different compass directions are shown with the abbreviations: **N** (north), **NE** (northeast), **E** (east), **SE** (southeast), **S** (south), **SW** (southwest), **W** (west) and **NW** (northwest).

Related information

- Activating and deactivating the compass* (p. 467)
- Calibrating the compass* (p. 467)

¹⁸ Certain markets only.

¹⁹ The term "IC:" before the certification/registration number only signifies that Industry Canada technical specifications were met.

²⁰ Rearview mirror with compass is available as an option only on certain markets and models.

Activating and deactivating the compass*

An integrated compass²¹ in the upper right corner of the rearview mirror shows the direction the vehicle is traveling.

The compass is automatically activated when the vehicle is started.

To deactivate/activate the compass manually:

- Use a paper clip or similar object to press the button on the bottom of the mirror.
 - > If the compass is deactivated when the vehicle is switched off, it will not be activated the next time the vehicle is started. The compass will then need to be activated manually.

Related information

- Compass* (p. 466)
- Calibrating the compass* (p. 467)

Calibrating the compass*

The globe is divided into 15 magnetic zones. The compass²² should be calibrated if the vehicle is driven from one zone to another.

1. Stop the vehicle in a large, open area away from steel constructions and high-voltage power lines.
2. Start the engine and switch off all electrical equipment (climate system, wipers, etc.) and make sure all doors are closed.

i NOTE

Calibration may fail or not even be initiated if electrical equipment is not turned off.

3. Hold the button on the bottom of the rearview mirror pressed for about 3 seconds (using e.g. a paper clip). The number of the current magnetic zone is shown.

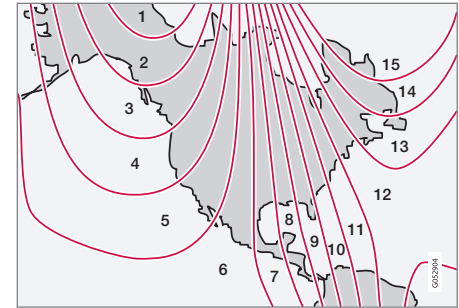

Magnetic zones.

4. Press the button on the underside of the mirror repeatedly until the desired magnetic zone (1–15) appears (see the map of magnetic zones).
5. Wait until the display again shows **C**, or press and hold the button on the underside of the rearview mirror for approx. 6 seconds until **C** is displayed.
6. Drive slowly in a circle at a speed of no more than 10 km/h (6 mph) until a compass direction is shown in the display. This indicates that calibration is complete. Drive in a circle two more times to fine-tune the calibration.

²¹ Rearview mirror with compass is available as an option only on certain markets and models.

²² Rearview mirror with compass is available as an option only on certain markets and models.

- ◀ 7. **Vehicles with heated windshields***: If C is shown in the display when the windshield heating function is activated, perform step 6 above with the heating function on.
- 8. Repeat the above procedure as needed.

Related information

- Compass* (p. 466)
- Activating and deactivating the compass* (p. 467)

AUDIO, MEDIA AND INTERNET

Audio, media and Internet

The audio and media system consists of a media player and a radio. A cellular phone can also be connected through Bluetooth to use hands-free functions or play music in the vehicle. When the vehicle is connected to the Internet, it is also possible to use apps to play media.

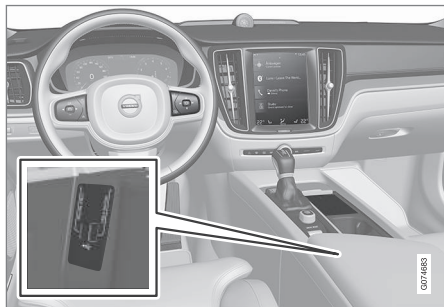

Audio and media overview

The functions can be controlled using voice commands, the steering wheel keypad or the center display. The number of speakers and amplifiers varies depending on the audio system installed in the vehicle.

System updates

The audio and media system is continuously improved. It is recommended to download system updates as soon as they are available.

Related information

- Media player (p. 491)
- Radio (p. 474)
- Phone (p. 507)
- Internet-connected vehicle* (p. 516)
- Apps (p. 472)
- Voice Control (p. 143)
- Ignition modes (p. 415)
- Driver distraction (p. 41)
- Handling system updates via Download Center (p. 586)
- License agreement for audio and media (p. 525)

Sound settings

Sound reproduction quality is preset but can also be adjusted.

The system's volume is normally adjusted using the volume control below the center display or the right-side steering wheel keypad. This applies, for example, when playing music or the radio or during phone calls and active traffic messages.

Sound reproduction

The audio system is precalibrated using digital signal processing. This calibration takes into account speakers, amplifiers, passenger compartment acoustics, listener position, etc. for each combination of vehicle model and audio system. There is also a dynamic calibration that takes into account the volume control setting and the vehicle's speed.

Personal settings

Different settings are available in Top view under **Settings** → **Sound** depending on the vehicle's sound system.

Premium Sound* (Bowers & Wilkins)

- **Tone** - setting for e.g. bass, treble, equalizer, etc.
- **Balance** - balance between right/left and front/rear speakers.
- **System Volumes** – adjusts volume in the various systems of the car, e.g. **Voice**

Control, Park Assist and Phone Ringtone.

High Performance Pro* (Harman Kardon)

- **Equalizer** - setting of equalizer.
- **Balance** - balance between right/left and front/rear speakers.
- **System Volumes** – adjusts volume in the various systems of the car, e.g. **Voice Control, Park Assist and Phone Ringtone.**

High Performance

- **Tone** - setting for e.g. bass, treble, equalizer, etc.
- **Balance** - balance between right/left and front/rear speakers.
- **System Volumes** – adjusts volume in the various systems of the car, e.g. **Voice Control, Park Assist and Phone Ringtone.**

Related information

- Sound experience* (p. 471)
- Media player (p. 491)
- Voice control settings (p. 148)
- Phone settings (p. 514)
- Audio, media and Internet (p. 470)
- Internet-connected vehicle* (p. 516)

Sound experience*

Sound experience is an app that provides access to additional sound settings.

Open **Sound Experience** from the center display's App view. Depending on the sound system installed in the vehicle, the following settings are possible:

Premium Sound* (Bowers & Wilkins)

- **Studio** – sound settings can be adjusted to be primarily adapted for **Driver, All and Rear.**
- **Individual stage** - surround sound mode with settings for intensity and enclosure.
- **Concert hall** - reproduces the acoustics of Gothenburg's Concert Hall.
- **Jazz club** – reproduces the acoustics of the Nefertiti Jazz Club.



Reproduces the acoustics of the Nefertiti Jazz Club.

High Performance Pro* (Harman Kardon)

- **Seat Optimization** – sound settings can be adjusted to be primarily adapted for **Driver, All and Rear.**
- **Surround** - surround sound mode with level settings.
- **Tone** - setting for e.g. bass, treble, equalizer, etc.

Related information

- Sound settings (p. 480)
- Navigating in the center display's views (p. 113)

Apps

The App view contains apps that provide access to certain vehicle services.

Swipe the center display screen from right to left¹ to access the App view from the Home view. This view displays downloaded apps (third-party apps) as well as apps for integrated functions, such as **FM radio**.

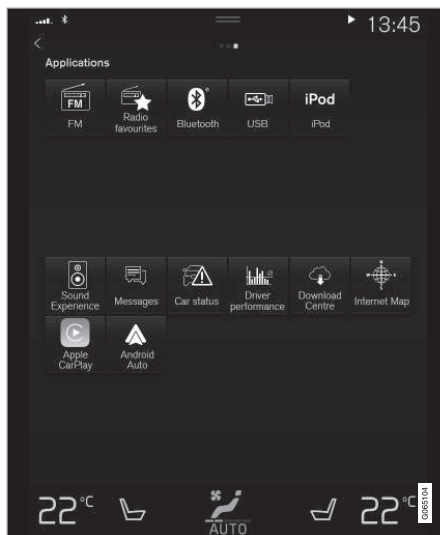

App view. (generic illustration; basic apps vary depending on market and model)

Several basic apps are always available. More apps such as web radio and music services can be downloaded when the car is connected to the Internet.

Some apps can only be used when the vehicle is connected to the Internet.

Start an app by pressing the app in the center display's app view.

All apps used should be updated to the latest version.

Related information

- Download apps (p. 473)
- Updating apps (p. 473)
- Deleting apps (p. 474)
- Apple® CarPlay®* (p. 500)
- Android Auto* (p. 504)
- Internet-connected vehicle* (p. 516)
- Hard disk storage space (p. 524)
- Terms of use and data sharing (p. 522)

¹ Applies for left-hand drive vehicles. For right-hand drive vehicles, swipe in the other direction.

Download apps

New apps can be downloaded when the vehicle is connected to the Internet.

i NOTE

Data downloading can affect other services such as transfer data, e.g. web radio. If the affect on other services is experienced as problematic, the download can be interrupted. Alternatively, it may be appropriate to switch off or cancel other services.

i NOTE

When downloading using a phone, pay extra attention to the data traffic costs.

1. Open the **Download Center** app in App view.



2. Select **New apps** to open a list of apps that are available but are not installed in the vehicle.

3. Tap on the row for an app in order to expand in the list and get more information about the app.
4. Select **Install** to start the download and installation of the app.
 - > The current status of the download and installation will be shown.

If a download cannot be started immediately, a message will be displayed. The app will remain in the list and it will be possible to reattempt downloading.

Canceling a download

- Tap **Abort** to cancel a download in progress.

Note that only a download can be cancelled. An installation cannot be cancelled once it has begun.

Related information

- Apps (p. 472)
- Updating apps (p. 473)
- Deleting apps (p. 474)
- Internet-connected vehicle* (p. 516)
- Handling system updates via Download Center (p. 586)
- Hard disk storage space (p. 524)

Updating apps

Apps can be updated when the vehicle is connected to the Internet.

i NOTE

Data downloading can affect other services such as transfer data, e.g. web radio. If the affect on other services is experienced as problematic, the download can be interrupted. Alternatively, it may be appropriate to switch off or cancel other services.

i NOTE

When downloading using a phone, pay extra attention to the data traffic costs.

If an app is being used while an update is in progress, it will be restarted to complete the update.

Update all

1. Open the **Download Center** app in App view.



2. Select **Install all**.
 - > The update will begin.



◀ Update certain apps

1. Open the **Download Center** app in App view.
2. Select **Application updates** to open a list of all available updates.
3. Find the desired app and select **Install**.
> The update will begin.

Related information

- Apps (p. 472)
- Download apps (p. 473)
- Deleting apps (p. 474)
- Handling system updates via Download Center (p. 586)
- Internet-connected vehicle* (p. 516)

Deleting apps

When the vehicle is connected to the Internet, it is possible to uninstall apps. If the app is being used, it must be closed before it can be uninstalled.

1. Open the **Download Center** app in App view.

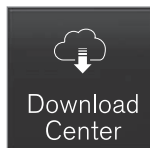

2. Select **Application updates** to open a list of all installed apps.
3. Find the desired app and select **Uninstall** to begin uninstalling the app.
> When the app has been uninstalled, it will be removed from the list.

Related information

- Apps (p. 472)
- Download apps (p. 473)
- Updating apps (p. 473)
- Handling system updates via Download Center (p. 586)
- Internet-connected vehicle* (p. 516)

Radio

The radio can receive broadcasting from the FM waveband with HD Radio™ Technology and SiriusXM® Satellite radio*. When the vehicle has an Internet connection, it is also possible to listen to web radio.

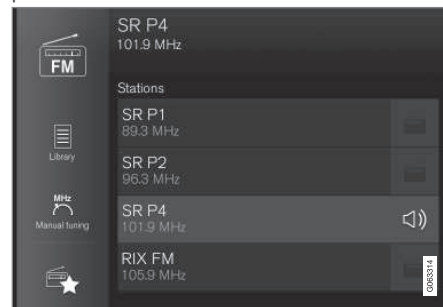

The radio can be controlled using voice commands, the right-side steering wheel keypad or the center display.

Related information

- Starting the radio (p. 475)
- Changing waveband and radio station (p. 476)
- Storing radio channels in the Radio favorites app (p. 477)

- Radio settings (p. 478)
- RBDS (p. 478)
- HD Radio™ (p. 479)
- SiriusXM® Satellite radio* (p. 482)
- Internet-connected vehicle* (p. 516)
- Voice control for radio and media (p. 147)
- Media player (p. 491)

Starting the radio

The radio is started from the center display's App view.

1. Open the desired waveband (e.g. **FM**) from App view.

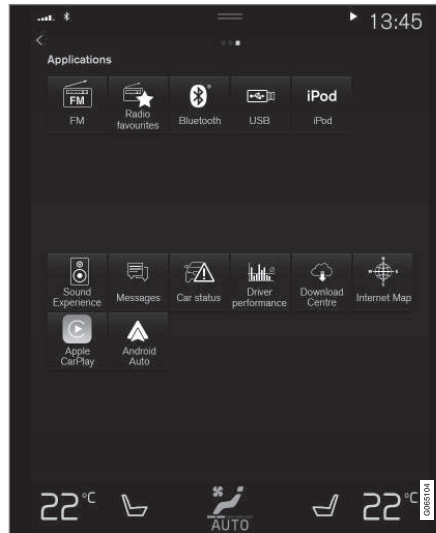

2. Select a radio station.

Related information

- Radio (p. 474)
- Searching for a radio station (p. 476)

- Changing waveband and radio station (p. 476)
- Storing radio channels in the Radio favorites app (p. 477)
- Radio settings (p. 478)
- Voice control for radio and media (p. 147)

Changing waveband and radio station

Instructions for changing wavebands, waveband lists and radio stations in the selected list are provided here.

Changing wavebands

Swipe from App view on the center display and select the desired waveband (e.g. **FM**) or open the App menu in the instrument panel with the right-side steering wheel keypad and make your selection there.

Changing a list in a waveband

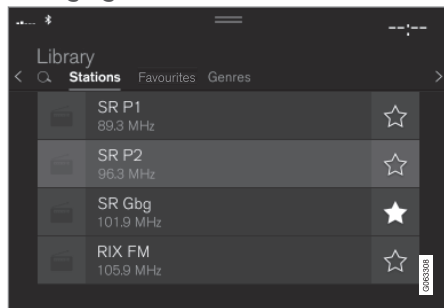

1. Tap **Library**.
2. Select playback from **Stations**, **Favorites** or **Genres**.
3. Tap the desired station in the list.

Favorites – only plays selected favorite channels.

Genres - only plays channels broadcasting the selected genre or program type, e.g. pop, classical, etc.

Changing radio stations in a selected list

- Press **⏮** or **⏭** under the center display or on the right-side steering wheel keypad.
 - > Move step-by-step through the selected list.

It is also possible to change radio station in the selected list via the center display.

Related information

- Radio (p. 474)
- Searching for a radio station (p. 476)
- Voice control for radio and media (p. 147)
- Storing radio channels in the Radio favorites app (p. 477)
- Radio settings (p. 478)
- App menu in instrument panel (p. 102)

Searching for a radio station

The radio automatically compiles a list of the radio stations that are sending out the strongest signals in the vehicle's current location.

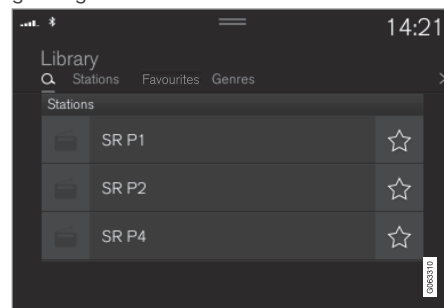

Searching is performed in different ways depending on the waveband selected:

- FM, stations, genres and frequency.
1. Tap **Library**.
 2. Tap **🔍**.
 - > Search view will displayed and the keyboard will open.
 3. Enter a search word/phrase.
 - > The search will start and change as characters are entered. Search results will be displayed by category.

Searching for a station manually



Searching manually makes it possible to find and tune to stations that are not on the automatically compiled list of the strongest stations in the area.

- Tap **Manual tuning**, drag the control or tap **⏮** or **⏭**. Press and hold to skip to the next available station in the frequency band. You can also use the right-side steering wheel keypad.

Related information

- Radio (p. 474)
- Starting the radio (p. 475)
- Changing waveband and radio station (p. 476)
- Voice control for radio and media (p. 147)
- Radio settings (p. 478)

Storing radio channels in the Radio favorites app

It is possible to add a radio station in the **Radio favorites** app and in the list of favorites for the waveband (e.g. FM). Instructions for adding and removing radio channels are provided below.

Radio favorites



The radio favorites app shows stored radio channels from all wavebands.

1. Open the **Radio favorites** app from App view.
2. Tap the desired station in the list to listen.

Adding and deleting radio favorites

1. Tap **☆** to add a radio channel to the waveband's list of favorites or the Radio favorites app.
2. Tap **Library**, select **Edit** and tap **🗑** to delete a radio channel from the list of favorites.

When you delete a radio channel from the Radio favorites app, the channel will also be deleted from that waveband's list of favorites.

Related information

- Radio (p. 474)
- Starting the radio (p. 475)
- Searching for a radio station (p. 476)
- Changing waveband and radio station (p. 476)
- Voice control for radio and media (p. 147)
- Radio settings (p. 478)
- App menu in instrument panel (p. 102)

Radio settings

There are a number of different radio functions that can be activated and deactivated.

Canceling a traffic message

A current broadcast (e.g. a traffic message) can be temporarily interrupted by pressing

 in the right-side steering wheel keypad or tapping **Cancel** in the center display.

Activating and deactivating radio functions

Pull down Top view and select **Settings** → **Media** and the desired waveband to see available functions.

FM Radio

- **HD Radio FM:** HD Radio™ Technology; makes it possible to achieve a sound quality comparable with a CD.
- **Show Broadcast Information:** shows information on program content, artists, etc.
- **Freeze Program Name:** select to stop the program service name from scrolling continuously. Instead it freezes after 20 seconds.

SiriusXM® Satellite radio*

Pull down Top view and select **Settings** → **Media** → **SiriusXM** to show a list of available options.

Related information

- Radio (p. 474)
- Settings for SiriusXM® Satellite radio* (p. 485)
- Symbols in the center display status bar (p. 122)

RBDS

RBDS radio

RBDS (Radio Broadcast Data System) enables certain functionality², such as:

- Searches for program types or new broadcasts
- Text information about currently broadcast programs

Related information

- Radio (p. 474)
- Radio settings (p. 478)

HD Radio™

HD Radio is a brand name registered by the DTS, Inc.³. They are the developer of a broadcasting technology called IBOC or In Band On Channel, which refers to the method of transmitting a digital radio broadcast signal centered on the same frequency as the FM station's present frequency.

Introduction



Display when the radio is receiving an HD Radio broadcast (generic illustration)

i NOTE

HD Radio volume may fade in and out at times due to coverage limitations.

The IBOC system is referred to as a "hybrid" since it is both analog and digital. During hybrid operation, receivers still continue to receive the analog (non-digital) signal. HD Radio receivers incorporate both modes of reception, where the receiver will automatically switch to the analog signal if the digital signal cannot be decoded or is lost by the receiver.

When you have tuned to an HD Radio station, the **HD** symbol will appear in the infotainment system display. The symbol will be displayed in different colors:

- **Grayed-out symbol:** no HD Radio broadcast reception
- **White symbol:** the radio is actively receiving an HD broadcast
- **Orange symbol:** the radio is receiving an HD broadcast with digital sound

More information about HD Radio and IBOC can be found on DTS, Inc.'s website, www.dts.com.

Artist Experience™

A radio station's logo and album art can be displayed. If a station opts to provide this information, it is broadcast once every 12 minutes, which means that there may be a delay before the logo/album art appear on the

screen. The radio can store 100 station logos so the next time the radio is tuned to the same station, the logo will be displayed immediately. Album art is synched with the artist that you are currently listening to.

Ball game mode

This feature means that a main FM station (HD1) will broadcast live events, where the content of the programming is more important than sound quality, in analog mode only to help prevent the delay between analog and digital broadcasting. The HD Radio symbol will be white during live broadcasts and "Live" will be displayed next to the symbol.

Benefits of digital broadcasting

- Better sound (FM sounds near CD quality).
- Some FM frequencies offer a greater number of listening choices through multicasting (consisting of a frequency's main channel and any sub-channels that may also be available on that particular frequency.)
- When receiving a digital signal there is no multipath disturbance or hisses/pops/cracking due to outside influences.

² Certain stations only.

³ HD Radio™ technology is manufactured under license from DTS, Inc. U.S. and Foreign Patents. HD Radio™ and the HD and HD Radio logos are proprietary trademarks of DTS, Inc.

◀◀ **How HD Radio™ Technology broadcasting works**

HD Radio works similarly to conventional radio and broadcasts of this type are available in many areas of the United States. However, there are a few key differences:

- Instead of transmitting one analog signal, stations send out a bundled signal – both analog and digital.
- An HD Radio receiver can receive both digital and analog broadcasts. Depending on the terrain and location of the vehicle (which will influence the signal strength), the receiver will determine which signal to receive.

Related information

- Radio (p. 474)
- Activating and deactivating the HD Radio™ (p. 480)
- HD Radio™ sub-channels (p. 481)
- HD Radio™ limitations (p. 481)
- Changing waveband and radio station (p. 476)
- Searching for a radio station (p. 476)

Activating and deactivating the HD Radio™

HD Radio is deactivated when the car leaves the factory.

When listening to an HD Radio station and driving through areas with weak HD signals (fringe areas), you may experience that the radio repeatedly switches between analog/digital and digital/analog reception. If this happens, it may be desirable to switch HD off.

Carry out the following to activate or deactivate HD Radio:

1. Drag down the top view and tap on **Settings**.
2. Press **Media** and **FM Radio**.
3. Press **HD Radio FM** to activate/deactivate the function.

If HD radio is deactivated, the radio will be unable to receive digital broadcasts but it will continue to function as a conventional radio (analog FM receiver). Please note that when HD is switched off, it will not be possible to tune in to sub-channels.

Activating or deactivating HD Radio only affects the currently selected waveband.

Related information

- HD Radio™ (p. 479)
- HD Radio™ sub-channels (p. 481)

- HD Radio™ limitations (p. 481)
- Opening contextual setting in the center display (p. 131)

HD Radio™ sub-channels

In many cases, a main HD Radio station (FM wavebands only) will also have sub-channels offering additional types of programming or music.

Sub-channels



Example of an HD Radio station with sub-channels

If any sub-channels are available, they will listed below the main channel on the screen. In this example, WILD-FM HD2 is a sub-channel.

Selecting sub-channels

To listen to a station's sub-channel(s), tap the station on the screen or press the forward/back arrow keys on the right-side steering wheel keypad or below the screen.

Sub-channels can also be saved as radio favorites.

If you tap a sub-channel favorite, it may take up to **6 seconds** before the channel becomes audible. If you tap a station while you are out of digital range of the transmitter, **No reception** will be displayed.

Related information

- HD Radio™ (p. 479)
- Activating and deactivating the HD Radio™ (p. 480)
- Changing waveband and radio station (p. 476)
- Searching for a radio station (p. 476)
- HD Radio™ limitations (p. 481)

HD Radio™ limitations

Limitations

- **Main channel vs. sub-channels (FM only):** The main channel is the only channel that can receive in hybrid mode (both digital and analog). If a frequency has sub-channels, they are broadcast in digital mode only. The main FM channel will be displayed as, for example, "WRIF-FM HD1". The sub-FM channels will be displayed as "WRIF-FM HD2", "WRIF-FM HD3", etc.
- **Reception coverage area:** Due to current IBOC transmitter power limitations, the reception coverage area in digital mode is somewhat more limited than the station's analog coverage area. Be aware that, like all radio transmission technology, terrain, time of day, vegetation and buildings can have a positive or negative effect on radio reception.
- **Analog to digital/digital to analog blending:** Analog to digital blending will occur as the signal strength reaches a pre-set threshold in the receiver. This will be noticeable in fringe areas (areas with weak reception) and is normal.



NOTE

There may be a noticeable difference in sound quality when a change from analogue to digital or digital to analogue occurs, such as:

- Volume increase or decrease
- Equalizer settings, i.e., Bass/ Mid-range/Treble cut or boost
- Time alignment (Digital program material in extreme cases can be as much as 8 seconds behind the analogue). This will be noticeable as a "stuttering" effect.

The above items are dependant on the broadcaster's equipment settings and do not indicate a fault in the vehicle's radio receiver or antenna systems.

Related information

- HD Radio™ (p. 479)
- Activating and deactivating the HD Radio™ (p. 480)
- HD Radio™ sub-channels (p. 481)

SiriusXM® Satellite radio*

The SiriusXM® Satellite system broadcasts from a number of high elevation satellites in geosynchronous orbit.

Listening to satellite radio

The digital signals from the satellites are line-of-sight, which means that physical obstructions such as bridges, tunnels, etc, may temporarily interfere with signal reception.

Avoid any obstructions, such as metallic objects transported on roof racks or in a ski box, or other antennas that may impede signals from the SiriusXM® satellites.

Selecting SiriusXM® Satellite radio mode

1. From the center display's Home view, swipe from right to left to come to App view.



2. Tap the SiriusXM® Satellite radio icon.

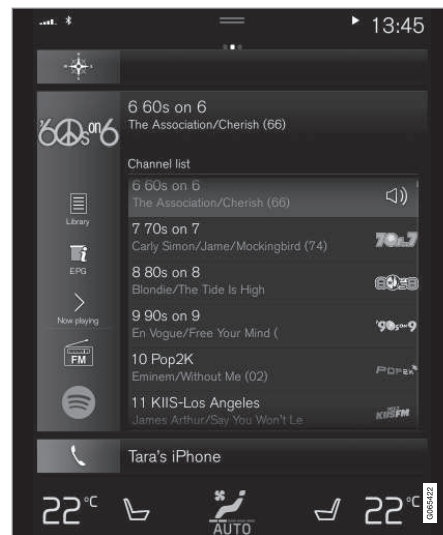

Home view with SiriusXM® Satellite radio activated

If there is no subscription activated, tap channel 1, where you will be prompted on the screen to phone SiriusXM®.

If a cell phone is paired and connected to the vehicle, you can also subscribe by:

1. From Home view, pull down the Settings menu.

- Open the settings menu for SiriusXM® Satellite radio.
- Tap **Unsubscribed Services**.
- To call SiriusXM®, enter the phone number. They will activate the subscription of your choice. This may take several minutes.

When the subscription has been activated, tap the SiriusXM® Satellite radio icon to start the function and display the channel list included in your subscription.

Related information

- Radio (p. 474)
- Using SiriusXM® Satellite radio* (p. 483)
- Settings for SiriusXM® Satellite radio* (p. 485)
- SiriusXM Travel Link®* (p. 486)

Using SiriusXM® Satellite radio*

SiriusXM® Satellite radio offers several features for finding and listening to music, news, sporting events, etc. being broadcast on satellite radio stations.

SiriusXM® Satellite radio functions

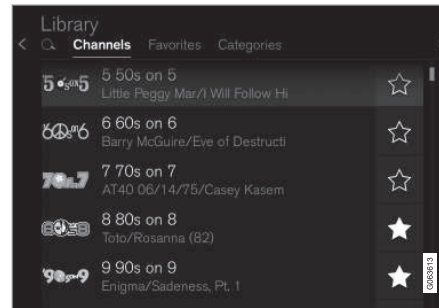

With SiriusXM® Satellite radio activated, tap **Library** to display a screen offering the following functions:

- **Search** (the magnifying glass icon)
- **Channels**
- **Favorites**
- **Categories**

If you have used this view previously, you will be returned to the most recently used one.

Search

Tap the magnifying glass to display a screen where you can enter text using the center display's keyboard or by writing in the free-text field to search for e.g., a station number, an artist, song title, etc.

Channels

Tap to display a complete list of the channels included in your subscription. Tap a channel name to listen. If a subscription to a channel has expired, its name will be grayed-out on the screen.

For quick access to a channel that you often listen to, tap the star to the right of the channel's name. It will then be added to your list of favorites.

Favorites

Tap to display the channels that you have added to this list. Tap a channel name to listen.



◀ Categories/Genres

Tap to display the categories available. Tap a category or genre name to display the channels that it contains and then tap a channel to listen.

If you have activated alerts (see the “Alerts” section below) and an alert is activated for an artist, song or team, temporary virtual categories will also be created and displayed. The channels currently broadcasting the song, artist or broadcasting a program with the selected team will be listed in a virtual category.

EPG (Electronic Program Guide)

On the center display's Home view, tap **EPG** for information about e.g., when a program is being broadcast and its name, description, artist, etc. If no information is currently available, **No information** will be displayed.

Alerts

If this feature has been selected under **SiriusXM Settings**, the **Alerts** button will be displayed on the Home view.

To add e.g. an artist's name, song title or a sports team to the list of alerts:

1. Tune to a channel that is broadcasting a song, game, etc., of your choice.
2. Tap the **Alerts** button.

3. A pop-up window will be displayed showing a list of alerts (nothing will be displayed if the selected channel does not support the alert function).
4. Select one of the alternatives in list (only one can be selected at a time).
5. The song/artist/team will now be added to the list of alerts. Favorite sports teams can also be added to the list using “Game Alert” in the SiriusXM satellite radio settings.
 - > When your choice is being broadcast on a channel, you will be informed by a pop-up.

iTunes tagging

From the center display's Top view, tap **SiriusXM Settings**. Tap the **iTunes Tagging** menu. Tap the **iTunes Tagging** box to activate/deactivate this function and tap **Close** to return to Home view. Tap **Tags List** to display a list of all tagged songs.

If the function is activated, the **iTunes tag** button will be displayed in Home view. If a song is played that you would like to buy in the iTunes store, tap this button while the song is playing to tag it. If a song with **iTunes Tagging** information is available, the button will be selectable. Tap the button to tag the song. If you would like to buy a tagged song via iTunes, Tap the iTunes tag button.

To buy a song in iTunes, begin by connecting an iPhone/iPod/iPad to the USB port in the tunnel console. The iTunes tagging list will automatically be transferred to the device and removed from the list in the vehicle. If the device is connected when a song is tagged, the data will automatically be saved in the device. To purchase the song, consult the iTunes support page.

Related information

- SiriusXM® Satellite radio* (p. 482)
- Entering characters, letters and words by hand in the center display (p. 127)
- Settings for SiriusXM® Satellite radio* (p. 485)
- Settings for SiriusXM® Satellite radio* (p. 485)
- Connecting a device via the USB port (p. 498)

Settings for SiriusXM® Satellite radio*

There are numerous settings that can be made to enhance your SiriusXM® Satellite radio listening experience.

Settings

Drag down the top view and tap on **Settings** → **Media** → **SiriusXM**. The following alternatives will be displayed:

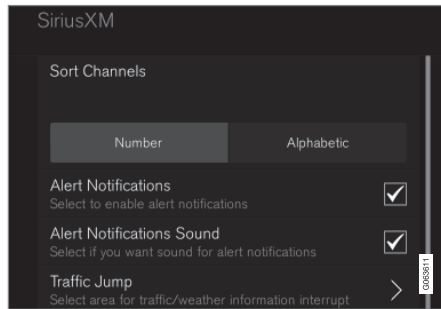

Traffic Jump

Tap to display a list of cities from which you can choose to get traffic/weather information (or **Traffic jump off** to deactivate the feature). Tap to select a city (**JUMP** will be displayed on the Home screen next to **Library**). Tap **Back** to return to the list of settings or **Close** to return to the Home screen.

From the Home screen, tap **JUMP** to activate the function. When traffic/weather information is available from the selected city, the radio will automatically tune to the channel providing the information. When the information/announcement is finished, the radio will automatically return to the channel that you were previously listening to.

During an announcement, tap **JUMP** to interrupt the message and return to the station that you were currently listening to.

Alert Notifications

Tap the box to activate/deactivate. When activated, you will be notified if a song, artist, etc. that you have selected is playing. You will be asked if you want to listen.

Alert Notifications Sound

Opt to receive an audible alert when one of your selected choices is being played.

Sort Channels

Select how to sort your channels list.

iTunes Tagging

Tap to display a menu with the options: **iTunes Tagging** and **Tags List**. With this feature activated, songs can be tagged for later purchase from the iTunes store.

Game Alerts

Tap to display a list of sports.

Tap a sport to display a list of teams and tap a box on the right side of the screen to select a

team as a favorite. An alert will then be provided when information about the team is being broadcast.

Tap **Confirm** below the list to return to the list of sports.

Tap **Back** to return to the list of settings or **Close** to return to the main screen.

Unsubscribed Services

If you have a SiriusXM® Satellite radio subscription, any channels not included in the subscription will be listed here. Call SiriusXM™ to subscribe. The phone number will be shown on the screen. If a cell phone is paired and connected to the vehicle, tap the phone number to make the call.

Skipped Stations

Tap to display a list of channels that you would like to skip (hide). Hide channels from the channel list by tapping the boxes to the right of the screen. Skipped (hidden) channels will not be shown in the channel list. However, a channel previously selected as a favorite will still be displayed in the list of favorites, even if has been added to the skip list.

Skipped Categories

Tap to display a list of categories. Tap a category to skip (hide) it. It will not be displayed in the list of categories.



◀ Related information

- SiriusXM® Satellite radio* (p. 482)
- Using SiriusXM® Satellite radio* (p. 483)

SiriusXM Travel Link®*

SiriusXM Travel Link is a subscription feature offered by SiriusXM® satellite radio* that can provide information about e.g., weather forecasts, weather alerts, service stations, sports, etc. in the vicinity of the vehicle.

Starting SiriusXM Travel Link



NOTE

SiriusXM Travel Link services are only available in vehicles equipped with the Sensus Navigation system.

From the center display's App view, tap **Travel Link** to activate the feature. A disclaimer text will be displayed. Tap **OK** to display a list of SiriusXM Travel Link services:

- Alerts
- Fuel
- Sports
- Weather
- Favorites

In order to use one or more of these services, the user has to subscribe to the ones desired.

To subscribe to a SiriusXM Travel Link service:

1. Open the center display's Top view.
2. Tap **Settings**.

3. Tap **Media**.

4. Press **SiriusXM Travel Link** and **Subscription Status**.

- > To subscribe, call the phone number listed on the screen.

Any services not subscribed will be grayed out and contain the text **Service not subscribed**.

When the services have been activated (subscribed), tap the one of your choice to start it.

The following applies for all of the SiriusXM Travel Link services:

- Pressing the **Back** button will take you back to the previous screen
- Pressing the **Close** button will take you to the **SiriusXM Travel Link** home screen.

i NOTE

If the **Close** button is used to return to the **SiriusXM Travel Link** home screen, the following applies (the **Weather** service is used here as an example):

- If you have already used the **Weather** function, tapping **Weather** again in the **SiriusXM Travel Link** home screen **before using any other SiriusXM Travel Link service** will return you to the point where you left the **Weather** service.
- If another **SiriusXM Travel Link** service is used (e.g., **Fuel**, **Sports**, etc.) before you return to the **Weather** service, you will be returned to the default **Weather** view (in this case, **Local**).

The same principle applies to all of the **SiriusXM Travel Link** services.

Favorites

Many SiriusXM Travel Link selections can be saved for easy access as favorites by tapping the "star" icon next to the selection where applicable.

To display a list of your stored selections, tap the **Favorites** application in the SiriusXM Travel Link home screen.

Related information

- SiriusXM® Satellite radio* (p. 482)
- SiriusXM Travel Link®* - Fuel (p. 489)
- SiriusXM Travel Link®* - Sports (p. 491)
- SiriusXM Travel Link®* - Weather (p. 487)
- SiriusXM Travel Link®* - Notifications (p. 489)

SiriusXM Travel Link®* - Weather

This SiriusXM Travel Link service provides weather-related information near the vehicle, at a local ski resort, etc.

From the SiriusXM Travel Link home screen, to display weather-related information:

- Tap the **Weather** button to display this screen.

At the top of the screen, the following categories will be displayed:

- Search (the magnifying glass icon)
- **Local**
- **Ski condition**
- **Areas**
- **Favorites**

Tap the category of your choice.

Search

Tap the magnifying glass icon. If the function is supported in the current context, a keyboard will appear on the screen. Enter the text of your choice and tap **Search** for detailed information from the SiriusXM Travel Link database.



« Local⁴

Information from the closest weather station will be displayed and the following alternatives are available:

- **Map view**
- **Today**
- **5 days**

Map view

Tap the map to display it in full-screen mode. Tap **Back** to return to the original map view.

Tap **Map options** to display the following alternatives.

- **Weather radar**
- **Storm attributes**
- **Surface features**
- **Tropical storm tracks**
- **Winds**

Tap the relevant box to the right of the option to select/deselect it. Tap **Done** to confirm and return to the previous screen or **Cancel**.

Today

Tap to see the current temperature, or the temperature in 3/6 hours.

Tap **Back** to return to the **Local** screen or **Close** to return to the SiriusXM Travel Link home screen.

5 days

Tap to see weather information for the coming 5 days.

Tap **Back** to return to the **Local** screen or **Close** to return to the SiriusXM Travel Link home screen.

Ski condition

Tap to display a list of ski areas in the vicinity of the vehicle. Tap a name in the list for information such as if the ski area is open/closed, temperature, wind conditions, snow conditions, the number of lifts that are in operation, etc.

- Weather locations
- Ski location

Tap Map view to display a map and a weather legend.

Tap **Map options** to display the following alternatives.

- **Weather radar**
- **Storm attributes**
- **Surface features**
- **Tropical storm tracks**
- **Winds**

Tap the relevant box to the right of the option to select/deselect it. Tap **Done** to confirm and return to the previous screen or **Cancel**.

Areas

Tap **Areas** to display a list of areas/locations in states from the SiriusXM Travel Link database.

Scroll to a state and tap to display:

- **Weather locations:** tap arrow to the right to display a list of towns. Scroll to desired town and tap for detailed weather information. You can choose Map view, today, 5 days or Favorites (star)
- **Ski locations:** tap arrow at right to display local ski areas. Tap an area for detailed info.

For information about storing a location, state, town, etc. as a favorite, see the heading "Favorites" in the article "SiriusXM Travel Link."

Related information

- SiriusXM Travel Link^{®*} (p. 486)
- SiriusXM Travel Link^{®*} - Fuel (p. 489)
- SiriusXM Travel Link^{®*} - Sports (p. 491)
- SiriusXM Travel Link^{®*} - Notifications (p. 489)

⁴ This is the weather default unless another alternative has been selected.

SiriusXM Travel Link®* - Notifications

This SiriusXM Travel Link service provides notifications of potential weather problems or other emergency situations in the vicinity of the vehicle.

From the SiriusXM Travel Link home screen, to show notifications:

- Tap the **Alerts** button to display this screen.
- If any notifications are currently available, a message will appear at the top of the screen. They can also be listed from the **Settings** menu in the center display's Top view.
- If no notifications are available, **No active alerts** will be displayed.

Types of notifications

To select the types of notifications to be displayed:

1. From the **Alerts** screen, tap the **Select alerts** button at the bottom of the screen.
2. This displays the types of notifications that can be displayed. Tap the box to the right of each type of notification to select/deselect it.
3. Tap **Done** when you have made your selections. You will return to the **Alerts** screen.

Information about a notification

If any notifications have been displayed on the screen, tap one for more detailed information (i.e., the location of the weather problem on a map and a description of the situation).

If a phone number is available in a notification, a **Call** button will be displayed. Tap this button for additional information.

Related information

- SiriusXM Travel Link®* (p. 486)
- SiriusXM Travel Link®* - Fuel (p. 489)
- SiriusXM Travel Link®* - Sports (p. 491)
- SiriusXM Travel Link®* - Weather (p. 487)

SiriusXM Travel Link®* - Fuel⁵

This SiriusXM Travel Link service provides information and guidance to service stations near the vehicle providing the type of fuel that you prefer/require for your vehicle.

From the SiriusXM Travel Link home screen, to show fuel information:

- Tap the **Fuel** button to display the main fuel screen.

The following categories are shown:

- Search (the magnifying glass icon)
- **Nearby**
- **Recommended**
- **Favorites**
- **Brands**

Tap one of the alternatives to display its screen.

NOTE

In each of the categories listed, tapping the **Select fuel type** button near the bottom of the screen opens a sub-view where you can specify the type of fuel preferred/required (**Regular, Midrange, Premium, Diesel, Electric 120V**, etc.) Tap **Done** to return to the previous screen.



◀ Search

Tap the magnifying glass icon. If the function is supported in the current context, a keyboard will appear on the screen. Enter the text of your choice and tap **Search** for detailed information if available.

Nearby

Tap for a list of service stations in the vicinity of the vehicle, with the nearest station at the top of the list.

The following information will be provided where available:

- For vehicles using gasoline, the price information for regular gasoline (unless another grade/type of fuel has been selected in **Select fuel type**)
- For electric vehicles/hybrids, information about charging stations, showing the total number of charging ports and the number of ports currently not in use
- The distance to the station
- A star icon to set the service station as a favorite

Tap the name of a service station to display more detailed information.

For guidance to the service station, tap the **Start navigation** or **Add as waypoint** buttons. See the Sensus Navigation* supplement

for additional information about using the navigation system.

Recommended

Tap for a list of service stations near the vehicle, displayed according to the price of regular gasoline (unless another grade/type of fuel has been selected in **Select fuel type**) or of stations offering the greatest number of available charging ports for electric vehicles/hybrids. The station offering the lowest price/most available charging ports will be displayed at the top of the list. Tap the name of a service station to display more detailed information.

Favorites

Tap for a list of service stations that have been stored as favorites. Tap the name of a service station to display more detailed information.

In addition to the **Select fuel type** button at the bottom of the screen, tap the **Edit** button to delete individual stations from the list or tap **Delete** to clear the list. Tap **Done** to return to the previous screen.

Brands

1. Tap **Brands** to display a list of service station brands in the area.

2. Tap a brand to display a list of service stations affiliated with that brand (BP, Exxon, etc.).
3. Tap the name of a service station to display more detailed information.

In addition to the **Select fuel type** button at the bottom of the screen, tap the **Sort** button to arrange the list according to **Nearest** or **Cheapest/Recommended**. Tap **Done** to return to the previous screen.

Related information

- SiriusXM Travel Link®* (p. 486)
- SiriusXM Travel Link® - Notifications (p. 489)
- SiriusXM Travel Link® - Sports (p. 491)
- SiriusXM Travel Link® - Weather (p. 487)

⁵ This service is not available in Canada.

SiriusXM Travel Link®* - Sports

This SiriusXM Travel Link service provides information about sporting events, tournaments, teams, leagues, etc.

From the SiriusXM Travel Link home screen, to display sports information:

- Tap the **Sports** button to display the main sports screen.

A number of sports categories will be listed (Football, Baseball, Basketball, etc.)

Tap a sport to select a league in that sport (NFL, MLB, etc.) or a sport organization (PGA, LPGA, etc.).

The following is an example of the result of tapping Baseball:

1. MLB (Major League Baseball) will be displayed.
2. Tap MLB to display the two leagues in Major League Baseball (American League or National League).
3. Tap one of the league names to display the divisions in the league.

4. Tap one of the divisions to display:

- **In progress:** play-by-play information about a match/game/tournament currently in progress. Continue tapping to display. In the detailed view, you can also select a radio station that is currently broadcasting an ongoing sporting event
- **Headlines for MLB:** tap to display brief headline information
- **Scheduled:** schedules for coming matches, games, etc.
- **Scores:** match/game results

The same principle applies to all sports.

Related information

- SiriusXM Travel Link®* (p. 486)
- SiriusXM Travel Link®* - Notifications (p. 489)
- SiriusXM Travel Link®* - Fuel (p. 489)
- SiriusXM Travel Link®* - Weather (p. 487)

Media player

The media player can play audio from external audio sources connected via USB port or Bluetooth. It can also play video format via the USB port.

When the vehicle is connected to the Internet, it is also possible to listen to web radio, audio books and to access music services via apps.

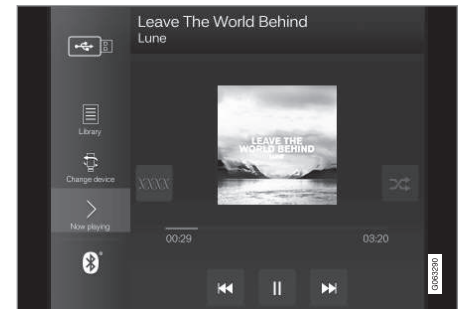

The media player is controlled from the center display. Several functions can also be controlled using voice commands or the right-side steering wheel keypad.

The radio, which is also handled by the media player, is described in a separate section.



◀ Related information

- Playing media (p. 492)
- Controlling and changing media (p. 493)
- Media searches (p. 494)
- Apps (p. 472)
- Radio (p. 474)
- Video (p. 496)
- Streaming media via Bluetooth® (p. 497)
- Playing media via the USB port (p. 498)
- Internet-connected vehicle* (p. 516)

Playing media

The media player is controlled from the center display. Several other functions can also be controlled using the right-side steering wheel keypad or by using voice commands.

The radio can also be controlled in the media player. See the section describing the radio.

Starting a media source

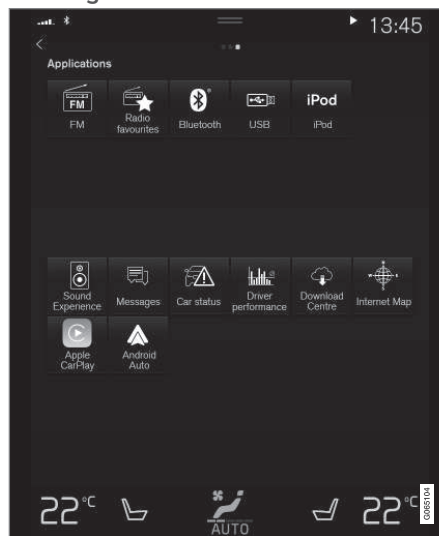

App view. (Generic illustration; basic apps vary depending on market and model).

USB flash drive

1. Inset a USB flash drive.
2. Open the **USB** app from App view.
3. Select the track you would like to play.
 - > Playback will begin.

MP3 player and iPod®

i NOTE

To start playback from an iPod, the iPod app must be used (not USB).

When an iPod is used as source, the car's audio and media system has a menu structure similar to the iPod player's own menu structure.

1. Connect a media source.
2. Start playback in the connected media source.
3. Open the app (**iPod**, **USB**) from App view.
 - > Playback will begin.

Bluetooth-connected device

1. Activate Bluetooth in the media source.
2. Connect a media source.
3. Start playback in the connected media source.
4. Open the **Bluetooth** app from App view.
 - > Playback will begin.

Media with Internet connection

Media playback from apps with Internet connection:

1. Connect the vehicle to the Internet.
2. Open the app from the App view.
 - > Playback will begin.

Read the separate section on how to download apps.

Video

1. Connect a media source.
2. Open the **USB** app from App view.
3. Tap the title you would like to play.
 - > Playback will begin.

Apple CarPlay

CarPlay is described in a separate section.

Android Auto

Android Auto is described in a separate section.

Related information

- Handling the App menu in the instrument panel (p. 103)
- Radio (p. 474)
- Controlling and changing media (p. 493)
- Connecting a device via the USB port (p. 498)
- Connecting a device via Bluetooth® (p. 497)

- Download apps (p. 473)
- Internet-connected vehicle* (p. 516)
- Video (p. 496)
- Apple® CarPlay®* (p. 500)
- Android Auto* (p. 504)
- Voice control for radio and media (p. 147)
- Compatible file formats for media (p. 499)

Controlling and changing media

Media playback can be controlled using voice commands, the steering wheel keypad or the center display.



The media player can be controlled using voice commands, the right-side steering wheel keypad or the center display.

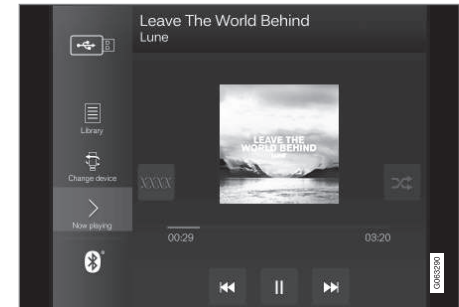

Volume - turn the knob under the center display or tap ▲ ▼ on the right-side steering wheel keypad to raise or lower the volume.

Play/pause - tap the image for the track you would like to play, or press the button below the center display or ○ on the right-side steering wheel keypad.



◀◀ Changing track/song - tap the desired track in the center display, or press ◀◀ or ▶▶ below the center display or on the right-side steering wheel keypad.

Rewinding/fast-forwarding - tap the time axis in the center display and drag it sideways, or press and hold ◀◀ or ▶▶ below the center display or on the right-side steering wheel keypad.

Changing media source - select from among previous sources in the app, tap the desired app in App view or use the right-side steering wheel keypad to select the app in the app menu .



Library - tap the button to play from the library.



Shuffle - tap the button to play tracks in a random order.



Similar - tap the button to use Gracenote to search for similar music on the USB device and create a playlist from the music found. The playlist can contain up to 50 tracks.



Change device - tap the button to toggle between USB devices when more than one is connected.

Related information

- Media player (p. 491)
- Media searches (p. 494)
- Sound settings (p. 470)
- Apps (p. 472)
- Gracenote® (p. 495)
- Voice control for radio and media (p. 147)

Media searches

Searches can be performed to locate a specific artist, composer, song title, album, video, audio book or playlist. If the vehicle is connected to the Internet, it is also possible to search for podcasts (online digital media).

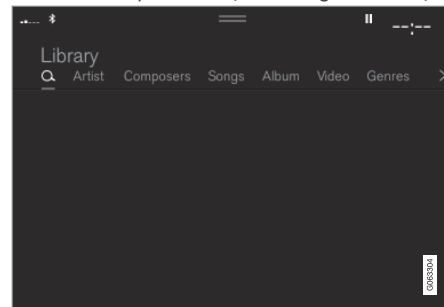

1. Tap .
- > Search view will displayed and the keyboard will open.
2. Enter a search word/phrase.
3. Tap **Search**.
- > A search will be performed on connected devices and the results will be displayed by category.

Swipe the screen horizontally to display each category separately.

Related information

- Media player (p. 491)
- Internet-connected vehicle* (p. 516)
- Playing media (p. 492)
- Entering characters, letters and words by hand in the center display (p. 127)

Gracenote®

Gracenote identifies artists, albums, tracks and any associated images that can be displayed during playback.

Gracenote MusicID® is a standard for music recognition. It can identify and analyze the metadata of music files and present information about the music. Metadata from different sources may sometimes be inconsistent or insufficient.

Because Gracenote supports phonetic processing of artist name, album titles and genres, voice commands can be used to control music playback.

1. Tap **Settings** in the Top view.
2. Tap **Media** → **Gracenote**® .
3. Choose settings for Gracenote data:
 - **Gracenote**® **Online Search** - search Gracenote's online database for currently playing media.
 - **Gracenote**® **Multiple Results** - select how Gracenote data should be displayed if there are multiple search results.
 - 1 - the file's original data will be used.
 - 2 - Gracenote data will be used.
 - 3 - Gracenote or original data can be selected.
 - **None** - no result will be displayed.

Updating Gracenote

The contents of the Gracenote database are continuously updated. Download the latest update to take advantage of improvements.

For information and to download, see volvocars.com/support.

Related information

- Playing media (p. 492)
- License agreement for audio and media (p. 525)
- Voice control for radio and media (p. 147)

Video

The media player can play videos from **USB-connected devices**.

Video is not available when the vehicle is moving; only audio will be played. Video will resume when the vehicle is stationary.

Information on compatible media formats is provided in a separate section.

Related information

- Playing video (p. 496)
- Playing DivX® (p. 496)
- Video settings (p. 497)
- Compatible file formats for media (p. 499)

Playing video

The **USB** app in App view is used to play videos.

1. Connecting media source (USB device).
2. Open the **USB** app from App view.
3. Tap the title you would like to play.
> Playback will begin.

If the USB device also contains music and audio tracks, it may be difficult to locate the video files. To find them, go to **Library** and select the video tab.

Related information

- Video (p. 496)
- Playing DivX® (p. 496)
- Video settings (p. 497)
- Compatible file formats for media (p. 499)

Playing DivX®

The DivX Certified® device must be registered to play purchased DivX video-on-demand (VOD) movies.

1. Tap **Settings** in the Top view.
2. Tap **Video → DivX® VOD** to get a registration code.
3. Go to vod.divx.com for more information and to complete the registration process.

Related information

- Video (p. 496)
- Playing video (p. 496)
- Video settings (p. 497)
- Compatible file formats for media (p. 499)

Video settings

You can change some language settings for video playback.

Audio Language and **Subtitle Language** can be adjusted with the video player in full-screen mode or by opening Top view and tapping

Settings → **Media** → **Video**.

Related information

- Video (p. 496)

Streaming media via Bluetooth®

The vehicle's media player is equipped with Bluetooth and can play audio files from Bluetooth-enabled external devices such as cellular phones and tablets.

In order for the media player to be able to wirelessly play audio files from an external device, the device must be connected to the vehicle via Bluetooth.

Related information

- Connecting a device via Bluetooth® (p. 497)
- Connecting a phone to the car via Bluetooth for the first time (p. 508)
- Playing media (p. 492)
- Compatible file formats for media (p. 499)

Connecting a device via Bluetooth®

Connect a Bluetooth® device to the vehicle to wirelessly play media and give the vehicle an Internet connection if it is available.

Many cellular phones on the market currently offer wireless Bluetooth® technology, but not all phones are fully compatible with the vehicle.

The procedure for connecting a media device is the same as for connecting a cellular phone to the vehicle via Bluetooth®.

Related information

- Streaming media via Bluetooth® (p. 497)
- Connecting a phone to the car via Bluetooth for the first time (p. 508)
- Playing media (p. 492)

Playing media via the USB port

External audio sources, such as an iPod® or MP3 player, can be connected to the audio system via the vehicle's USB port.

Devices with rechargeable batteries can be charged when they are connected via the USB port and the ignition is in mode **I**, **II** or the engine is running.

The content on the external source can be read faster if it only contains data of a compatible format. Video files can also be played via the USB port.

Some MP3 players have their own file system that the vehicle has support for.

Related information

- Connecting a device via the USB port (p. 498)
- Playing media (p. 492)
- Video (p. 496)
- Ignition modes (p. 415)
- Technical specifications for USB devices (p. 499)
- Apple® CarPlay®* (p. 500)
- Android Auto* (p. 504)

Connecting a device via the USB port

External audio sources, such as an iPod® or MP3 player, can be connected to the audio system via any of the vehicle's USB ports. If the vehicle has two USB ports, the phone must be connected to the port with the white frame to use Apple CarPlay* or Android Auto*.

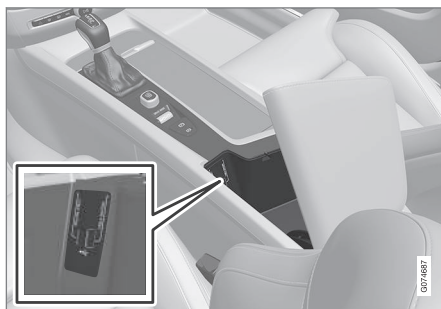

USB ports (type A) in the tunnel console. Route the cable forward to help avoid pinching when the cover is closed.

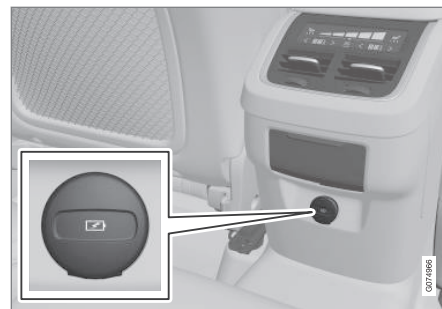

USB ports (type C) on rear of tunnel console for charging phones, tablets, etc.⁶

Related information

- Playing media (p. 492)
- Playing media via the USB port (p. 498)
- Media player (p. 491)
- Technical specifications for USB devices (p. 499)
- Technical specifications for USB devices (p. 499)
- Apple® CarPlay®* (p. 500)
- Android Auto* (p. 504)

⁶ It is not possible to playback media in the car's audio or media system via this input.

Technical specifications for USB devices

For the contents of USB devices to be read, the following specifications must be met. Any folder structures will not be shown in the center display during playback.

	Max. number
Files	15 000
Folders	1 000
Folder levels	8
Playlists	100
Tracks in a playlist	1 000
Subfolders	No limit

Technical specifications for the USB-A connector

- Type A port
- Version 2.0
- Voltage 5 V
- Max. current 2.1 A

Technical specifications for the USB-C connector

- Type C port
- Version 3.1
- Voltage 5 V

- Max. current 3.0 A

Related information

- Playing media via the USB port (p. 498)

Compatible file formats for media

In order to play media, the following file formats must be used.

Audio files

For- mat	File extension	Codec
MP3	.mp3	MPEG1 Layer III, MPEG2 Layer III, MP3 Pro (mp3 compatible), MP3 HD (mp3 compatible)
AAC	.m4a, .m4b, .aac	AAC LC (MPEG-4 part III Audio), HE-AAC (aacPlus v1/v2)
WMA	.wma	WMA8/9, WMA9/10 Pro
WAV	.wav	LPCM
FLAC	.flac	FLAC

Video files

Format	File extension
MP4	.mp4, .m4v
MPEG-PS	.mpg, .mp2, .mpeg, .m1v





Format	File extension
AVI	.avi
AVI (DivX)	.avi, .divx
ASF	.asf, .wmv

Subtitles

Format	File extension
SubViewer	.sub
SubRip	.srt
SSA	.ssa

DivX®

DivX-certified devices have been tested for high-quality DivX (.divx, .avi) video playback. When you see the DivX logo, you have the freedom to play your favorite DivX videos.

Profile	DivX Home Theater
Video codec	DivX, MPEG-4
Resolution	720x576
Audio speed (bit rate)	4.8Mbps
Frame rate	30 fps
File extension	.divx, .avi
Max. file size	4 GB

Audio codec	MP3, AC3
Subtitles	XSUB
Special functions	Multiple subtitles, multiple audio, resume play
Reference	Meets all requirements of the DivX Home Theater profile. Visit divx.com for more information and software tools to convert your files into DivX Home Theater video.

Related information

- Media player (p. 491)
- Video (p. 496)
- Playing DivX® (p. 496)

Apple® CarPlay®*

With CarPlay⁷, you can listen to music, make phone calls, get driving instructions, send/receive messages and use Siri, all while remaining focused on driving.

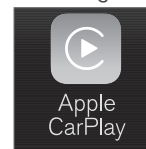



CarPlay works with select iOS devices. If the car does not already support CarPlay, this can be retrofitted. Contact a Volvo retailer to install CarPlay.

Information about supported apps and compatible iOS devices are available on the Apple website: www.apple.com/ios/carplay/. Using apps that are not compatible with CarPlay may sometimes mean that the connection between the device and the vehicle is broken. Please note that Volvo is not responsible for the content of CarPlay.

When using map navigation via CarPlay, guidance will only be shown on the center display and not in the instrument panel or head-up display.

When navigation is started through Apple CarPlay, any current route guidance from the vehicle's own systems will be discontinued.

CarPlay apps can be controlled from the center display, an iOS device or with the right-side steering wheel keypad (for certain functions). The apps can also be voice-controlled

using Siri. Press and hold the  button on the steering wheel to start voice control with Siri. Press briefly to activate the vehicle's own voice control system. If Siri cuts off too soon, press and hold the  ⁸ button on the steering wheel..

By using Apple CarPlay you acknowledge the following: Apple CarPlay is a service provided by Apple Inc. under its terms and conditions. Volvo Cars is thus not responsible for Apple CarPlay or its features/applications. When using Apple CarPlay, certain information from your car (including its position) is transferred to your iPhone. In relation to Volvo Cars, you are fully responsible for your and any others person's use of Apple CarPlay.

Related information

- Using Apple[®] CarPlay^{®*} (p. 501)
- Settings for Apple[®] CarPlay^{®*} (p. 503)
- Voice Control (p. 143)
- Resetting center display settings (p. 132)

⁷ Availability may vary depending on market.

⁸ Apple and CarPlay are registered trademarks of Apple Inc.

⁹ Availability may vary depending on market.

Using Apple[®] CarPlay^{®*}

To use CarPlay⁹, the Siri voice control must be activated in your iOS device. The device must also have an Internet connection via Wi-Fi or a mobile network for all functions to work.

Connecting an iOS device and starting CarPlay

NOTE

CarPlay can only be used if Bluetooth is disabled. A cell phone or media player connected to the vehicle via Bluetooth will therefore not be available when CarPlay is active. An alternative source must be used to provide an Internet connection for the vehicle's apps. Use Wi-Fi or the vehicle's integrated modem.

To start CarPlay from an iOS device that has not previously been connected:

1. Connect an iOS device that supports CarPlay to the USB port. If there are two USB ports, use the one with the white frame.

2. Read the terms and conditions and then tap **Accept** to connect.
 - > The CarPlay tile will open and compatible apps will be displayed.
3. Tap the desired app.
 - > The app will start up.



◀ Starting CarPlay

To start CarPlay from an iOS device that has previously been connected:

1. Connect an iOS device to the USB port. If there are two USB ports, use the one with the white frame.
 - > **If the auto start setting is selected** – the name of the device will be displayed. The CarPlay tile will open automatically when Home view is displayed when the iOS device is connected.
2. If the CarPlay tile does not open automatically, tap the name of the device. The CarPlay tile will open and compatible apps will be displayed.
3. If any other app is active in the same tile, tap **Apple CarPlay** in App view.
 - > The CarPlay tile will open and compatible apps will be displayed.
4. Tap the desired app.
 - > The app will start up.

CarPlay will run in the background if another app is started, or is already active when the device is connected, in the same view. To display CarPlay in the tile, tap the CarPlay icon in App view.

Switching connection between CarPlay and iPod

CarPlay to iPod

1. Tap **Settings** in the Top view.
2. Proceed to **Communication** → **Apple CarPlay**.
3. Uncheck the box for the iOS device that should no longer start CarPlay automatically when the USB cable is connected.
4. Remove and then reinsert the iOS device into the USB port.
5. Open the **iPod** app from App view.

iPod to CarPlay

1. Tap **Apple CarPlay** in App view.
2. Read the information in the pop-up window and then tap **OK**.
3. Remove and then reinsert the iOS device into the USB port.
 - > The Apple CarPlay tile will open and compatible apps will be displayed¹⁰.

Related information

- Connecting a device via the USB port (p. 498)
- Apple® CarPlay®* (p. 500)
- Settings for Apple® CarPlay®* (p. 503)

- Connecting the vehicle to the Internet via a phone (Wi-Fi) (p. 517)
- Connecting the vehicle to the Internet via vehicle modem (SIM card) (p. 518)
- Voice Control (p. 143)

¹⁰ Apple, CarPlay, iPhone and iPod are registered trademarks of Apple Inc.

Settings for Apple® CarPlay®*

Settings for an iOS device connected through CarPlay^{11,12}.

Automatic start

1. Tap **Settings** in the Top view.
2. Tap **Communication** → **Apple CarPlay** and select the desired setting:
 - Check the box - CarPlay will start automatically when the USB cable is connected.
 - Uncheck the box - CarPlay will not start automatically when the USB cable is connected.

A maximum of 20 iOS devices can be stored in the list, which may be worth noting if many people share the vehicle, e.g. in a car pool. When the list is full and a new device is connected, the oldest one will be deleted.

To delete the list, the settings must be reset in the center display (factory reset).

System Volumes

1. Tap **Settings** in the Top view.

2. Tap **Sound** → **System Volumes** to change the settings for the following:

- **Voice Control**
- **Navi Voice Guidance**
- **Phone Ringtone**

Related information

- Apple® CarPlay®* (p. 500)
- Using Apple® CarPlay®* (p. 501)
- Resetting center display settings (p. 132)

Tips for using Apple® CarPlay®*

Here are some useful tips for when you use CarPlay¹³.

- Update your iOS device with the latest version of the iOS operating system and ensure that the apps have been updated.
- In the event of a problem with CarPlay, unplug the iOS device from the USB port and then plug it in again. Otherwise, try to close the app on the device that is not working and then restart the app, or try closing all apps and restart your device.
- If the apps do not appear when CarPlay starts (black screen), try minimizing and expanding the tile for CarPlay.
- Using apps that are not compatible with CarPlay may sometimes cause the connection between the iOS device and the vehicle to be broken. Information about supported apps and compatible devices can be found on Apple's website. You can also search for CarPlay in the App Store to find information about apps that are compatible with CarPlay in your market.
- You can use Siri to write or dictate messages or have them read aloud. Messages are read aloud and dictated in the language selected in the Siri settings. When

¹¹ Apple and CarPlay are registered trademarks of Apple Inc.

¹² Availability may vary depending on market.

¹³ Availability may vary depending on market.



- ◀◀ you write/dictate messages, no text will be shown in the vehicle's center display, but the text will be shown in your iOS device. When using Siri, note that it is the phone's microphones that are used and the quality therefore depends on the phone's location.
- If the device is connected to the vehicle through Bluetooth, the connection will be broken when CarPlay is used. Resume Internet connection in the vehicle by tethering using the device's Wi-Fi hotspot.
- Some of CarPlay's functions (such as voice calls and messages) interrupt the use of the vehicle's own functions and CarPlay will instead be automatically displayed. If you do not wish this to happen, deselect display of the corresponding function in CarPlay under the phone's notification settings.
- CarPlay only works with iPhone¹⁴.

i NOTE

Availability and functionality can vary depending on market.

Related information

- Apple® CarPlay®* (p. 500)
- Connecting the vehicle to the Internet via a phone (Wi-Fi) (p. 517)

Android Auto*

Android Auto¹⁵ lets you listen to music, make calls, get driving directions and use apps customized for your vehicle from an Android device. Android Auto can be used with selected Android devices.

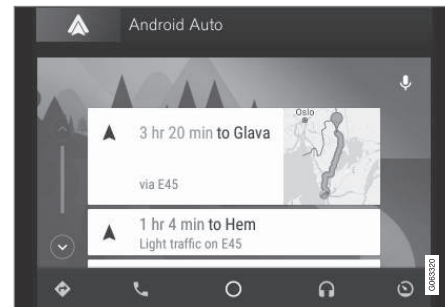

For information on supported apps and compatible Android devices, please go to www.android.com/auto/. For third-party apps, see Google Play. Please note that Volvo is not responsible for the content of Android Auto.

Android Auto is started from App view. After Android Auto has been initially started, the app will start automatically the next time the device is connected. The automatic start setting can be deactivated in Settings.

¹⁴ Apple, CarPlay and iPhone are registered trademarks owned by Apple Inc.

¹⁵ Availability may vary depending on market.

i NOTE

When a device is connected to Android Auto, it is possible to stream to another media player via Bluetooth. Bluetooth is active while Android Auto is in use.

When using navigation guidance provided by Android Auto, navigation will only be shown on the center display and not in the instrument panel or head-up display.

Android Auto can be controlled from the center display, with the right-side steering wheel keypad or by using voice commands. Press and hold the steering wheel button  to start the Google Assistant and press briefly to deactivate it.

By using Android Auto, you acknowledge the following: Android Auto is a service provided by Google Inc. under its terms and conditions. Volvo Cars is not responsible for Android Auto or its features or applications. When you use Android Auto, your car transfers certain information (including its location) to your connected Android phone. You are fully responsible for your and any other person's use of Android Auto.

Related information

- Using Android Auto* (p. 505)
- Settings for Android Auto* (p. 506)

Using Android Auto*

To use the **Android Auto**¹⁶ app, the app must be installed on the Android device and the device must be connected to the vehicle's USB port.

i NOTE

For installation of Android Auto to be possible, the vehicle must be equipped with two USB ports (USB hub)*. If the car only has one USB port then it is not possible to use Android Auto.

Connecting an Android device for the first time

1. Connect the Android device to the USB port with the white frame.
2. Read the information in the pop-up window and then tap **OK**.
3. Tap **Android Auto** in App view.
4. Read the terms and conditions and then tap **Accept** to connect.
 - > The Android Auto tile will open and compatible apps will be displayed.
5. Tap the desired app.
 - > The app will start up.

From a previously connected Android device

1. Connect the device to the USB port with the white frame.
 - > **If the auto start setting is selected** - the name of the device will be displayed.
2. Tap the name of the device – the Android Auto tile will open and compatible apps will be displayed.
3. **If the automatic start setting is not activated** - open the **Android Auto** app from App view.
 - > The Android Auto tile will open and compatible apps will be displayed.
4. Tap the desired app.
 - > The app will start up.

Android Auto will run in the background if another app is started in the same tile. To display Android Auto in the tile, tap the Android Auto icon in App view.

Related information

- Android Auto* (p. 504)
- Settings for Android Auto* (p. 506)
- Connecting a device via the USB port (p. 498)
- Voice Control (p. 143)

Settings for Android Auto*

Settings for Android devices initially connected with Android Auto¹⁷.

Automatic start

1. Tap **Settings** in the Top view.
2. Tap **Communication** → **Android Auto** and select setting:
 - Check the box - Android Auto will start automatically when the USB cable is connected.
 - Uncheck the box - Android Auto will not start automatically when the USB cable is connected.

A maximum of 20 Android devices can be stored in the list. When the list is full and a new device is connected, the oldest one will be deleted.

A factory reset must be performed to delete the list.

System Volumes

1. Tap **Settings** in the Top view.

2. Tap **Sound** → **System Volumes** to change the settings for the following:

- **Voice Control**
- **Navi Voice Guidance**
- **Phone Ringtone**

Related information

- Android Auto* (p. 504)
- Using Android Auto* (p. 505)
- Resetting center display settings (p. 132)

Tips for using Android Auto*

Here are some useful tips for when you use Android Auto¹⁸.

- Ensure that your apps are updated.
- When starting the vehicle, wait until the center display has started, connect the device and then open Android Auto from the app view.
- In the event of problems with Android Auto, unplug your Android device from the USB port and then plug it in again. Otherwise, try closing the app on the device and then restarting the app.
- When a device is connected to Android Auto it is still possible to play media via Bluetooth to another media player. The Bluetooth function is on when Android Auto is used.
- If the Android Auto icon is grayed out, it means that a device is no longer connected. When you connect your device, the icon will light up. If there is no icon at all, the vehicle does not support connecting a device for this purpose.
- If the device is connected to the vehicle through Bluetooth, the connection will be broken when Android Auto is used. Resume Internet connection in the vehicle

¹⁶ Availability may vary depending on market.

¹⁷ Availability may vary depending on market.

¹⁸ Availability may vary depending on market.

by tethering using the device's Wi-Fi hotspot.

Related information

- Android Auto* (p. 504)
- Connecting the vehicle to the Internet via a phone (Wi-Fi) (p. 517)

Phone

A phone equipped with Bluetooth can be wirelessly connected to the vehicle's integrated hands-free system.

The audio and media system offers hands-free functionality for remotely controlling a number of the phone's features. The phone's integrated controls can also be used, even when it is connected to the vehicle.

When the phone has been paired and connected to the vehicle, it can be used as an Internet connection or to make or receive calls, send or receive text messages or wirelessly play music.

The phone is controlled from the center display, and the App menu (accessed using the right-side steering wheel keypad) and voice commands can also be used to control certain functions.

Overview

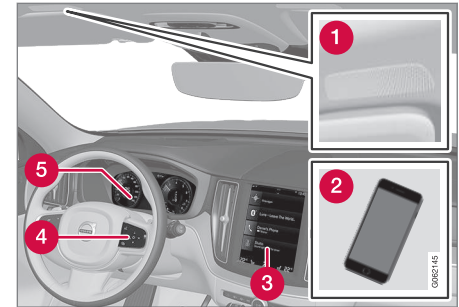

- 1 Microphone.
- 2 Phone.
- 3 Phone handling in the center display.
- 4 Keypad for controlling phone functions shown in the center display and voice commands.
- 5 Instrument panel.

Related information

- Handling phone calls (p. 511)
- Managing the phone book (p. 514)
- Handling text messages (p. 512)
- Connecting a phone to the car via Bluetooth for the first time (p. 508)



- Connecting a phone to the car via Bluetooth automatically (p. 510)
- Connecting a phone to the car via Bluetooth manually (p. 510)
- Disconnecting a Bluetooth-connected phone (p. 510)
- Switch between phones connected via Bluetooth (p. 511)
- Disconnecting Bluetooth-connected devices (p. 511)
- Phone settings (p. 514)
- Voice Control (p. 143)
- Handling the App menu in the instrument panel (p. 103)
- Sound settings (p. 470)
- Connecting the vehicle to the Internet via a Bluetooth-connected phone (p. 517)

Connecting a phone to the car via Bluetooth for the first time

Pair a Bluetooth-enabled phone to the vehicle to make calls, send/receive text messages and wirelessly play media from the vehicle, or connect the vehicle to the Internet.

Two Bluetooth devices can be connected at the same time, but in that case, only one will be used for wireless playback. The most recently paired phone will be automatically connected to make calls, send/receive text messages, play media or use as an Internet connection. It is possible to change what the phone is used for under **Bluetooth Devices** via the settings menu in the center display's Top view. The cellular phone must be equipped with Bluetooth and support tethering.

After the device has been connected/registered for the first time via Bluetooth, the device no longer needs to be visible/searchable. It just needs to have Bluetooth activated. A maximum of 20 paired Bluetooth devices can be stored in the vehicle.

There are two ways to pair a phone to the vehicle. Searching for the phone from the vehicle or searching for the vehicle from the phone.

Option 1 - searching for the phone from the vehicle

1. Make the phone discoverable/visible using its Bluetooth function.
2. Open the phone tile in the center display.
 - If no phone has been paired to the vehicle, tap **Add phone**.
 - If a phone has been paired to the vehicle, tap **Change** . Tap **Add phone** in the pop-up window.

> A list of available Bluetooth devices will be displayed. The list will be updated as new devices are discovered.
3. Tap the name of the phone you would like to connect.
4. Make sure that the code displayed in the vehicle matches the one in the phone. If it does, confirm the code in both places.
5. In the phone, accept or cancel the options for selecting the phone's contacts and text messages.

NOTE

- The message function must be activated in certain phones.
- Not all cell phones are fully compatible and may not be able to display contacts and messages in the vehicle.

Option 2 - searching for the vehicle from the phone

1. Open the phone tile in the center display.
 - If no phone has been paired to the vehicle, tap **Add phone** → **Make vehicle discoverable**.
 - If a phone has been paired to the vehicle, tap **Change** . Tap **Add phone** → **Make vehicle discoverable** in the pop-up window.
2. Activate Bluetooth in the phone.
3. Search in the phone for Bluetooth devices.
 - > A list of available Bluetooth devices will be displayed.
4. Select the vehicle's name from the list of devices in the phone.
5. A pop-up window for the connection is shown in the car. Confirm the connection.
6. Make sure that the code displayed in the vehicle matches the one shown in the external device. If it does, confirm the code in both places.
7. In the phone, accept or cancel the options for selecting the phone's contacts and text messages.

NOTE

- The message function must be activated in certain phones.
- Not all cell phones are fully compatible and may not be able to display contacts and messages in the vehicle.

NOTE

If the phone's operating system is being updated, it is possible that the connection will be interrupted. Delete the phone from the car and reconnect.

Related information

- Phone (p. 507)
- Connecting a phone to the car via Bluetooth automatically (p. 510)
- Connecting a phone to the car via Bluetooth manually (p. 510)
- Disconnecting a Bluetooth-connected phone (p. 510)
- Switch between phones connected via Bluetooth (p. 511)
- Disconnecting Bluetooth-connected devices (p. 511)
- Settings for Bluetooth devices (p. 515)
- Internet-connected vehicle* (p. 516)

- Connecting the vehicle to the Internet via a Bluetooth-connected phone (p. 517)

Connecting a phone to the car via Bluetooth automatically

A phone can be automatically connected to the vehicle via Bluetooth. The phone must have first been paired with the vehicle.

Only the two most recently connected phones can be connected automatically.

1. Activate Bluetooth in the phone before turning the vehicle's ignition to mode **I**.
2. Turn the ignition to **I** or higher.
 - > The phone will be connected.

Related information

- Phone (p. 507)
- Connecting a phone to the car via Bluetooth for the first time (p. 508)
- Connecting a phone to the car via Bluetooth manually (p. 510)
- Disconnecting a Bluetooth-connected phone (p. 510)
- Switch between phones connected via Bluetooth (p. 511)
- Disconnecting Bluetooth-connected devices (p. 511)
- Settings for Bluetooth devices (p. 515)
- Internet-connected vehicle* (p. 516)
- Connecting the vehicle to the Internet via a Bluetooth-connected phone (p. 517)
- Ignition modes (p. 415)

Connecting a phone to the car via Bluetooth manually

A phone can be manually connected to the vehicle via Bluetooth. The phone must have first been paired with the vehicle.

1. Activate Bluetooth in the phone.
2. Open the phone tile.
 - > A list of available phones will be displayed.
3. Tap the name of the phone you would like to connect.
 - > The phone will be connected.

Related information

- Phone (p. 507)
- Connecting a phone to the car via Bluetooth for the first time (p. 508)
- Connecting a phone to the car via Bluetooth automatically (p. 510)
- Disconnecting a Bluetooth-connected phone (p. 510)
- Switch between phones connected via Bluetooth (p. 511)
- Disconnecting Bluetooth-connected devices (p. 511)
- Settings for Bluetooth devices (p. 515)
- Internet-connected vehicle* (p. 516)
- Connecting the vehicle to the Internet via a Bluetooth-connected phone (p. 517)

Disconnecting a Bluetooth-connected phone

A Bluetooth-connected phone can be disconnected from the vehicle.

- When the phone is out of range of the vehicle, it will be automatically disconnected. If a call is in progress when the phone is disconnected from the vehicle, the call will be transferred from the vehicle's speakers and microphone to the cellular phone.
- The phone can also be disconnected by manually deactivating Bluetooth.

Related information

- Phone (p. 507)
- Phone settings (p. 514)
- Switch between phones connected via Bluetooth (p. 511)
- Disconnecting Bluetooth-connected devices (p. 511)
- Settings for Bluetooth devices (p. 515)

Switch between phones connected via Bluetooth

It is possible to switch between Bluetooth-connected phones.

1. Open the phone tile.
2. Tap **Change**  or pull down Top view and tap **Settings** → **Communication** → **Bluetooth Devices** → **Add device**.
> A list of available Bluetooth devices will be displayed.
3. Tap the name of the phone you would like to connect.

Related information

- Phone (p. 507)
- Connecting a phone to the car via Bluetooth for the first time (p. 508)
- Settings for Bluetooth devices (p. 515)
- Disconnecting a Bluetooth-connected phone (p. 510)
- Disconnecting Bluetooth-connected devices (p. 511)

Disconnecting Bluetooth-connected devices

Phones or other devices in the list of registered Bluetooth devices can be removed.

1. Tap **Settings** in the Top view.
2. Tap **Communication** → **Bluetooth Devices**.
> A list of registered Bluetooth devices is displayed.
3. Tap the name of the device you would like to remove.
4. Tap **Remove device** and confirm.
> The device is no longer registered in the vehicle.

Related information

- Phone (p. 507)
- Connecting a phone to the car via Bluetooth for the first time (p. 508)
- Disconnecting a Bluetooth-connected phone (p. 510)
- Switch between phones connected via Bluetooth (p. 511)
- Settings for Bluetooth devices (p. 515)

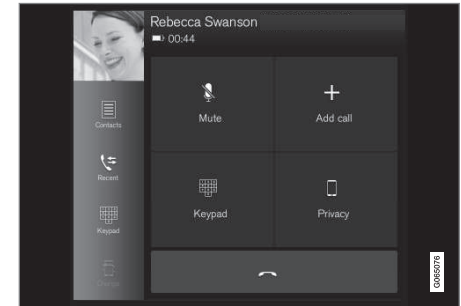

Handling phone calls

Handling phone calls in the vehicle for a Bluetooth-connected cellular phone.



Generic illustration.

Making calls

1. Open the phone tile.
2. Initiate a call by selecting the phone number from the recent calls list, entering the number on the keypad or selecting a number from the phone book (list of contacts). You can search or scroll to find a contact in the phone book. Tap  in the phone book to add a contact to **Favorites**.
3. Tap  to make a call.
4. Tap  to end the call.



Calls can also be made from the list of recent calls using the app menu, which can be



opened using the  button on the right-side steering wheel keypad.

Making multiple calls

While the call is in progress:

1. Tap **Add call**.
2. Select from the list of recent calls, favorites or contacts.
3. Tap an item/row in the list of recent calls or  for the contact in the phone book.
4. Tap **Swap call** to switch between calls.
5. Tap  to end the current call.

Group (conference) calls

While multiple calls are in progress:

1. Tap **Join calls** to merge ongoing calls.
2. Tap  to end the call.

Incoming calls

Incoming phone calls will be shown on the instrument panel and in the center display. Manage the calls using the right-side steering wheel keypad or the center display.

1. Tap **Answer/Reject**.
2. Tap  to end the call.

Incoming calls while another call is in progress

1. Tap **Answer/Reject**.

2. Tap  to end the call.

Privacy

- While a call is in progress, tap **Privacy** and select setting:
 - **Switch to mobile phone** - the hands-free function will be disabled and the call will proceed on the cellular phone.
 - **Driver focused** - the microphone in the ceiling liner on the passenger side will be muted and the call will proceed using the vehicle's hands-free function.

Related information

- Phone (p. 507)
- Connecting a phone to the car via Bluetooth for the first time (p. 508)
- Voice control for cellular phones (p. 146)
- Handling the App menu in the instrument panel (p. 103)
- Entering characters, letters and words by hand in the center display (p. 127)
- Managing the phone book (p. 514)
- Handling text messages (p. 512)
- Sound settings (p. 470)

Handling text messages¹⁹

A Bluetooth-connected cellular phone's text messages can be handled in the vehicle. Text message functionality needs to be activated in certain phones. Not all phones are fully compatible and therefore cannot display contacts and messages in the vehicle.

Handling text messages in the center display

Text messages are only shown in the center display if the relevant setting is made.

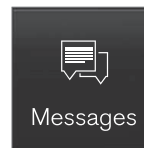

Tap **Messages** in App view to handle text messages in the center display.

i NOTE
<p>When the vehicle is moving:</p> <ul style="list-style-type: none"> • Only one row of the message will be displayed. Tap Read out to have the entire message read aloud. • The center display's keyboard cannot be used.

Reading text messages in the center display aloud



Tap the icon to have the message read aloud.

Sending text messages in the center display²⁰

- It is possible to reply to text messages or create a new message.
 - To reply to a text message - tap the name of the contact who sent the message and then tap **Answer**.
 - To create a new message - tap **Create new**. Select a contact or enter a phone number.
- Write the message.
- Tap **Send**.

Handling text messages in the instrument panel

Text messages are only shown in the instrument panel if the relevant setting is made.

Reading new text messages in the instrument panel aloud

- To have the message read aloud, select **Read out** using the steering wheel keypad.

Dictating replies in the instrument panel

After the text message has been read aloud, it is possible to dictate a brief reply if the vehicle has an Internet connection.

- Tap **Answer** using the steering wheel keypad. A dictation dialog will start.

Message alert

Alerts can be activated and deactivated in the text message settings.

Related information

- Phone (p. 507)
- Text message settings (p. 513)
- Phone settings (p. 514)
- Internet-connected vehicle* (p. 516)
- Voice control for cellular phones (p. 146)
- Entering characters, letters and words by hand in the center display (p. 127)
- Connecting a phone to the car via Bluetooth for the first time (p. 508)
- Terms of use and data sharing (p. 522)

Text message settings

Settings for handling text messages received through a connected phone can be personalized.

- Tap **Settings** in the Top view.
- Tap **Communication** → **Text Messages** and select settings:
 - Notification in center display** - display text message notifications in the center display's status bar.
 - Notification in driver display** - displays notifications in the driver's display and incoming messages can be managed using the steering wheel's right-hand keypad.
 - Text message tone** - select tone for incoming text messages.

Related information

- Phone (p. 507)
- Connecting a phone to the car via Bluetooth for the first time (p. 508)
- Handling text messages (p. 512)
- Phone settings (p. 514)

¹⁹ Only applies to certain markets. Contact a Volvo retailer for more information.

²⁰ Only certain phones can send text messages via the vehicle. The connected phone must support the Bluetooth profile Message Access Profile (MAP).

Managing the phone book

When a phone is connected with Bluetooth to the vehicle, contacts can be managed directly in the center display.

Up to 3,000 contacts can be displayed from the phone selected in the center display.

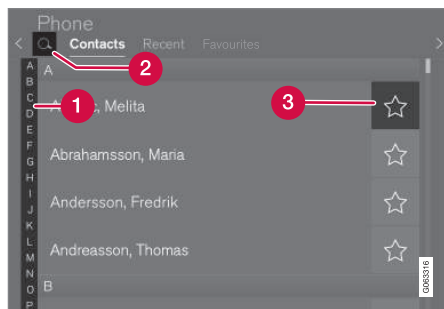

- 1 Scroll by letter or # to find contacts. Only letters matching existing contacts in the phone book will be shown.
- 2 Search contacts - tap to search by phone number or name in the phone book.
- 3 Favorites - tap to add/remove a contact from the list of favorites.

Sorting

The phone book is sorted in alphabetical order and special characters and numbers are sorted under #. The list can be sorted by either

first name or last name. This is adjusted in your cellular phone settings.

Related information

- Phone (p. 507)
- Phone settings (p. 514)
- Voice control for cellular phones (p. 146)
- Entering characters, letters and words by hand in the center display (p. 127)
- Connecting a phone to the car via Bluetooth for the first time (p. 508)

Phone settings

When the phone is connected to the car, the following settings can be made:

1. Tap **Settings** in the Top view.
2. Tap **Communication** → **Phone** and select settings:
 - **Ringtones** - select a ring tone. Ring tones from the cellular phone or the vehicle can be used. Some phones are not fully compatible and it may not be possible to use the phone's ring tones in the vehicle.
 - **Sort Order** - select sort order in the contact list.

Call notifications in head up display*

1. Tap **Settings** in the center display's Top view.
2. Tap **My Car** → **Displays** → **Head-Up Display Options**.
3. Select **Show Phone**.

Related information

- Phone (p. 507)
- Text message settings (p. 513)
- Settings for Bluetooth devices (p. 515)
- Connecting a phone to the car via Bluetooth for the first time (p. 508)

- Head-up display* (p. 140)
- Sound settings (p. 470)

Settings for Bluetooth devices

Settings for Bluetooth-connected devices.

1. Tap **Settings** in the Top view.
2. Tap **Communication → Bluetooth Devices** and select settings:
 - **Add device** - start the procedure for pairing a new device.
 - **Previously paired devices** - lists registered/paired devices.
 - **Remove device** - remove a connected device.
 - **Allowed services for this device** - select what the device will be used for: making calls, sending/receiving messages, streaming media, Internet connection.
 - **Internet connection** connect the vehicle to the Internet using the device's Bluetooth connection.

Bluetooth® declaration of conformity USA

FCC CAUTION

Changes or modifications not expressly approved by the party responsible for compliance could void the user's authority to operate the equipment. This transmitter must not be co-located or operated in conjunction with any other antenna or transmitter.

Canada

This device complies with Industry Canada license-exempt RSS standard(s). Operation is subject to the following two conditions:

- (1) this device may not cause interference, and
- (2) this device must accept any interference, including interference that may cause undesired operation of the device.

Related information

- Phone (p. 507)
- Phone settings (p. 514)
- Internet-connected vehicle* (p. 516)
- Connecting a phone to the car via Bluetooth for the first time (p. 508)

Internet-connected vehicle*

When the vehicle is connected to the Internet, it is possible to use web radio and music services via apps, download software and contact retailers from the vehicle.

The vehicle can be connected to the Internet using Bluetooth, Wi-Fi or the vehicle's integrated modem (SIM card).

When the vehicle is connected to the Internet, it is possible to share the vehicle's Internet connection (Wi-Fi hotspot) so that other devices, e.g. tablets, can access the Internet²¹.

The Internet status is shown by a symbol in the center display's status bar.



i NOTE

Data (data traffic) is transferred when using the internet, which can incur additional costs.

Activating data roaming can cause additional charges.

Contact your network operator about data traffic costs.

i NOTE

When using Apple CarPlay, it is only possible to connect the vehicle to the Internet using Wi-Fi or the vehicle's modem.

i NOTE

When using Android Auto, it is possible to connect the vehicle to the Internet using Wi-Fi, Bluetooth or the vehicle's modem.

Before the vehicle is connected to the Internet, search for support information about terms and conditions for services and the customer privacy policy at volvocars.com.

Related information

- Symbols in the center display status bar (p. 122)
- Connecting the vehicle to the Internet via a Bluetooth-connected phone (p. 517)
- Connecting the vehicle to the Internet via a phone (Wi-Fi) (p. 517)
- Connecting the vehicle to the Internet via vehicle modem (SIM card) (p. 518)
- Apps (p. 472)
- No or poor Internet connection (p. 521)
- Sharing Internet from the vehicle via Wi-Fi hotspot (tethering) (p. 520)
- Deleting Wi-Fi networks (p. 521)
- Wi-Fi technology and security (p. 522)
- Volvo ID (p. 26)
- Terms of use and data sharing (p. 522)

²¹ This is not possible when the vehicle is connected to another Wi-Fi hotspot.

Connecting the vehicle to the Internet via a Bluetooth-connected phone

Establish an Internet connection using Bluetooth and tethering from a phone and get access to multiple connected services in your vehicle.

1. To connect the vehicle to the Internet via a Bluetooth-connected phone, the phone must first be paired with the vehicle via Bluetooth.
2. Make sure that the phone supports Internet sharing (tethering) and that the function is activated. In an iPhone, the function is called "personal hotspot". In Android phones, the function can have different names, but is often called "hotspot". For iPhone phones, the "personal hotspot" menu page must also be open until the Internet connection has been made.
3. If the phone has been connected via Bluetooth previously, tap **Settings** in the center display's Top view.
4. Tap **Communication** → **Bluetooth Devices**.
5. Mark the window for **Bluetooth Internet connection** under the heading **Internet connection**.

6. If a different connection is being used, confirm the connection change.
 - > Your vehicle is now connected to the Internet via your Bluetooth-connected phone.

NOTE

The cellular phone and network operator must support tethering (sharing of Internet connection) and the subscription must include data traffic.

NOTE

When using Apple CarPlay, it is only possible to connect the vehicle to the Internet using Wi-Fi or the vehicle's modem.

Related information

- Internet-connected vehicle* (p. 516)
- Connecting the vehicle to the Internet via vehicle modem (SIM card) (p. 518)
- Connecting a phone to the car via Bluetooth for the first time (p. 508)
- Connecting the vehicle to the Internet via a phone (Wi-Fi) (p. 517)
- Apple® CarPlay®* (p. 500)
- No or poor Internet connection (p. 521)
- Settings for Bluetooth devices (p. 515)

Connecting the vehicle to the Internet via a phone (Wi-Fi)

Establish an Internet connection using Wi-Fi through Internet sharing (tethering) from a phone and get access to the connected services in your vehicle.

1. Make sure that the phone supports Internet sharing (tethering) and that the function is activated. In an iPhone, the function is called "personal hotspot". In Android phones, the function can have different names, but is often called "hotspot". For iPhone phones, the "personal hotspot" menu page must also be open until the Internet connection has been made.
 2. Tap **Settings** in the Top view.
 3. Proceed to **Communication** → **Wi-Fi**.
 4. Activate/deactivate by tapping to check/uncheck the Wi-Fi box.
 5. If a different connection is being used, confirm the connection change.
 6. Tap the name of the network you would like to connect.
 7. Enter the network password.
 - > The vehicle will connect to the network.
- Please note that certain cellular phones will disable Internet sharing (tethering) when the connection to the vehicle has been broken, e.g. when the phone has been removed from



- ◀ the vehicle. The phone's tethering function will then need to be reactivated the next time the phone's hotspot is used to connect to the Internet.

When a phone is connected to the vehicle, it will be saved for future use. To display a list of saved networks or to manually delete saved networks, tap **Settings** → **Communication** → **Wi-Fi** → **Saved networks**.

i NOTE
The cellular phone and network operator must support tethering (sharing of Internet connection) and the subscription must include data traffic.



Technical and security requirements for Wi-Fi connection are described in a separate section.

Related information

- Internet-connected vehicle* (p. 516)
- Deleting Wi-Fi networks (p. 521)
- No or poor Internet connection (p. 521)

- Wi-Fi technology and security (p. 522)

Connecting the vehicle to the Internet via vehicle modem (SIM card)

It is possible to establish an Internet connection via the vehicle modem and a personal SIM card (P-SIM).

Vehicles equipped with Volvo On Call will use the vehicle modem Internet connection for the services.

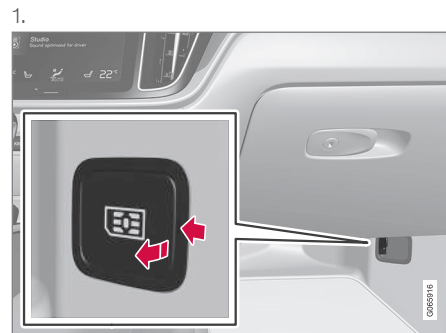

Insert a personal SIM card in the holder in the passenger-side footwell.

Note that the vehicle's card reader requires **mini SIM** cards.

2. Tap **Settings** in the Top view.

3. Tap **Communication** → **Vehicle Modem Internet**.
4. Activate/deactivate by tapping to check/uncheck the **Vehicle modem Internet** box.
5. If a different connection is being used, confirm the connection change.
6. Enter the SIM card's PIN code.
 - > The vehicle will connect to the network.

NOTE

Please note that the SIM card used for Internet connection via P-SIM cannot have the same telephone number as the SIM card used in the cellular phone. If the same card is used for both, phone calls will not be connected properly to the cellular phone. Use a SIM card with a separate phone number for the Internet connection or a data card that does not handle phone calls and can therefore not interfere with phone function.

Related information

- Internet-connected vehicle* (p. 516)
- No or poor Internet connection (p. 521)
- Vehicle modem settings (p. 519)

Vehicle modem settings

Your vehicle is equipped with a modem that can be used to connect the vehicle to the Internet. It is also possible to share this Internet connection over Wi-Fi.

1. Tap **Settings** in the Top view.
2. Tap **Communication** → **Vehicle Modem Internet** and select settings:
 - **Vehicle modem Internet** - select this to use the vehicle's modem to connect to the Internet.
 - **Data usage.** - tap **Reset** to reset the counter for the amount of data received and sent.
 - **Network.**
 - Select carrier** - select a service provider manually or automatically.
 - Data roaming** - if the box is checked, the vehicle modem will attempt to connect to the Internet when the vehicle is outside its home network (e.g. if you are in another country). Please note that this could entail additional charges. Consult with your service provider for data roaming terms under your contract.
- **SIM card PIN.**

Change PIN - a maximum of 4 digits can be entered.

Disable PIN - select whether a PIN code will be required to access the SIM card.

- **Send request code** - used to e.g. download or check the balance remaining on a prepaid phone card. This function is specific to your service provider.

NOTE

Please note that the SIM card used for Internet connection via P-SIM cannot have the same telephone number as the SIM card used in the cellular phone. If the same card is used for both, phone calls will not be connected properly to the cellular phone. Use a SIM card with a separate phone number for the Internet connection or a data card that does not handle phone calls and can therefore not interfere with phone function.

Related information

- Connecting the vehicle to the Internet via vehicle modem (SIM card) (p. 518)
- No or poor Internet connection (p. 521)

Sharing Internet from the vehicle via Wi-Fi hotspot (tethering)

When the vehicle is connected to the Internet, other devices may share the vehicle's Internet connection²².

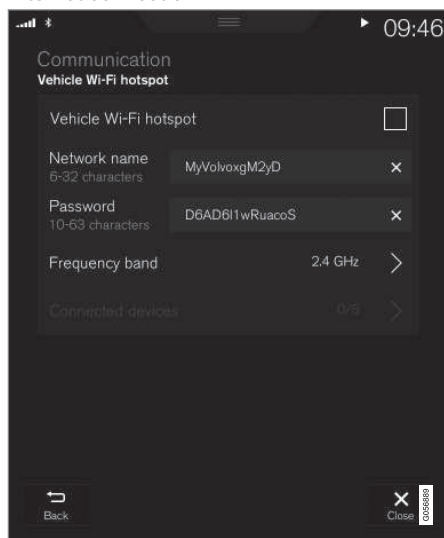

The network service provider (SIM card) must support Internet sharing (tethering).

1. Tap **Settings** in the Top view.

2. Tap **Communication** → **Vehicle Wi-Fi Hotspot**.
3. Tap **Network name** to assign a name to the hotspot.
4. Tap **Password** and create a password. This password can then be used to connect other devices to this hotspot.
5. Tap **Frequency band** and select a frequency for the hotspot to use to transmit data. Please note that selecting a frequency is not possible on all markets.
6. Activate/deactivate by tapping to check/uncheck the **Vehicle Wi-Fi Hotspot** box.
7. If Wi-Fi is being used to connect to the Internet, confirm the change of connections.
 - > It is now possible for external devices to connect to the vehicle's Wi-Fi hotspot.

i NOTE

Activation of Wi-Fi hotspot can cause additional charges from your network operator.

Contact your network operator about data traffic costs.

The connection status is shown by a symbol in the center display's status bar.

Tap **Connected devices** to see a list of currently connected devices.

Related information

- Symbols in the center display status bar (p. 122)
- Internet-connected vehicle* (p. 516)
- No or poor Internet connection (p. 521)

²² This does not apply when the vehicle is connected to the Internet via Wi-Fi.

No or poor Internet connection

Factors affecting the Internet connection.

The amount of data transmitted depends on the services or apps currently in use in the vehicle. Streaming music, for example, involves the transmission of a large amount of data, and this requires a good connection and a strong signal.

Phone to vehicle

Internet connection speed may vary depending on the location of the cellular phone in the vehicle. Move the phone closer to the center display to increase signal strength. Make sure that nothing is between the phone and center display that could be blocking the signal.

Phone to network operator

The speed of the mobile network varies depending on the coverage in the vehicle's current location. Coverage may be poorer in e.g. tunnels, mountainous areas, deep valleys or indoors. Connection speed is also dependent on the subscription you have with your service provider.

i NOTE

If you experience any problems with data traffic, contact your network service provider.

Restarting the phone

If you experience any Internet connection problems, it may help to restart your phone.

Related information

- Internet-connected vehicle* (p. 516)
- Wi-Fi technology and security (p. 522)

Deleting Wi-Fi networks

Networks that are not needed can be deleted.

1. Tap **Settings** in the Top view.
2. Proceed to **Communication** → **Wi-Fi** → **Saved networks**.
3. Tap **Forget** to delete the network.
4. Confirm the selection.
 - > The vehicle will no longer connect to the deleted network.

Deleting all networks

All networks can be deleted at once by performing a factory reset. Please note that all user data and system settings will be restored to original default factory settings.

Related information

- Internet-connected vehicle* (p. 516)
- No or poor Internet connection (p. 521)
- Resetting center display settings (p. 132)
- Connecting the vehicle to the Internet via a phone (Wi-Fi) (p. 517)

Wi-Fi technology and security

Networks must meet certain criteria in order for the vehicle to connect.

It is possible to connect to the following types of networks:

- Frequency - 2.4 or 5 GHz²³.
- Standards - 802.11 a/b/g/n.
- Security type - WPA2-AES-CCMP.

The vehicle's Wi-Fi system is designed to handle Wi-Fi devices inside the vehicle.

Performance may be impaired if multiple devices are using a frequency at the same time.

Related information

- Internet-connected vehicle* (p. 516)

Terms of use and data sharing

The first time certain services and apps are started, a pop-up window with the heading **Terms and conditions and Data sharing** may open.

The aim is to inform the user about Volvo's terms of use and data sharing policy. By accepting data sharing, the user accepts that certain information will be sent from the vehicle. This is required for certain services and apps to work with full functionality.

The data sharing function for connected services and apps is disabled by default²⁴. For certain connected services and apps in the vehicle to work, data sharing must be activated. Data sharing can be set from the center display's settings menu or when the services or apps are started in the center display.

Privacy and data sharing

The software update that became available in November 2017 introduced privacy and data sharing settings for connected services and downloaded apps. These settings can be found under **Privacy and data** in the settings menu in the vehicle's center display.

There, you can choose which connected services will be allowed to share data. Data sharing for downloaded apps can also be disabled

there. Note that services and apps cannot be used as intended if data sharing is disabled.

After a factory reset or e.g. a workshop visit or a software update, your data sharing preferences may be reset to default settings. You will then need to reactivate data sharing for connected services and downloaded apps.

NOTE

Settings for privacy and data sharing are unique for each driver profile.

Related information

- Activating and deactivating data sharing (p. 523)

²³ Selecting a frequency is not possible on all markets.

²⁴ Does not apply to Volvo On Call.

Activating and deactivating data sharing

Data sharing for relevant services and apps can be set via the Settings menu in the center display.

1. Tap **Settings** in the center display's Top view.
2. Tap **System** → **Privacy and data**.
3. Select to activate or deactivate data sharing for individual services and all apps.

If data sharing for a connected service or downloaded apps is not activated, this can be done when they are started in the center display. If this is the first time that a service is started, or e.g. after a factory reset or certain software updates, Volvo's terms and conditions for connected services must be accepted. Note that data sharing will then also be activated for other services or apps that sharing has already been accepted for.

i NOTE

After visiting a Volvo workshop, you may need to reactivate data sharing so that services and apps will work again.

Related information

- Terms of use and data sharing (p. 522)

Data sharing for services

If you haven't activated data sharing for a connected service or for downloaded apps, you can do this when you start them in your center display. The first time that you start a service, or e.g. after a factory reset or certain software updates, you will also need to accept Volvo's terms and conditions for connected services.

Enabling data sharing when starting a service

1. Select the function or service you want to activate.
 - > If this is the first time you are using the service or after e.g. a factory reset or certain software updates, you will first need to accept Volvo's terms and conditions for connected services in order to continue.

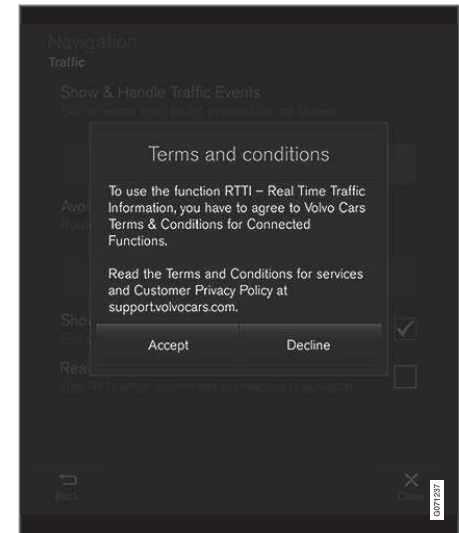

- ◀◀ 2. Accept data sharing for the service or cancel.

If you choose to accept, data sharing will be enabled and you can begin using the service.

Enabling data sharing when starting an app

To accept data sharing for an app that needs the function, start the app and tap **accept** in the pop-up window.

You can disable data sharing for services and apps in the settings menu under **System** → **Privacy and data** → **Data Sharing**.

Hard disk storage space

It is possible to view how much space is remaining on the vehicle's hard disk.

Storage information for the vehicle's hard disk can be shown, including total capacity, available capacity and how much space is used for installed apps. The information is found under

Settings → **System** → **System Information** → **Storage**.

Related information

- Apps (p. 472)

License agreement for audio and media

A license is an agreement on the right to conduct a certain activity or the right to use someone else's right according to terms and conditions specified in the agreement. The following texts are Volvo's agreements with manufacturers/developers.

Bowers & Wilkins



Bowers & Wilkins and B&W are trademarks of the B&W Group Ltd. Nautilus is a trademark of B&W Group Ltd. Continuum is a trademark of Bowers & Wilkins. Trademarks of Bowers & Wilkins are applicable in selected markets.

Dirac Unison®



Dirac Unison co-optimizes the loudspeakers in frequency, time and space for the best possible bass integration and clarity. It enables a faithful reproduction of the acoustic characteristics of specific performance venues. Using advanced algorithms, Dirac Unison controls all loudspeakers digitally based on acoustic high-precision measurements. Like a conductor of an orchestra, it guarantees that the loudspeakers perform in perfect unison.

DivX®



DivX®, DivX Certified® and associated logos are trademarks of DivX, LLC and are used under license.

This DivX Certified® device can play DivX® Home Theater video files up to 576p (including .avi, .divx). Download free software at www.divx.com to create, play and stream digital video.

ABOUT DIVX VIDEO-ON-DEMAND: This DivX Certified® device must be registered in order to play purchased DivX Video-on-Demand (VOD) movies. To obtain your registration code, locate the DivX VOD section in your device setup menu. Go to vod.divx.com for more information on completing the registration process.

Patent number

Covered by one or more of the following patents in the US: 7,295,673; 7,460,668; 7,515,710; 8,656,183; 8,731,369; RE45,052.

Gracenote®



◀ Portions of the content are copyright © of Gracenote or its providers.

Gracenote, the Gracenote logo and logotype, "Powered by Gracenote" and Gracenote MusicID are either registered trademarks or trademarks of Gracenote, Inc. in the United States and/or other countries.

Gracenote® End User License Agreement

This application or device contains software from Gracenote, Inc. in Emeryville, California, United States ("Gracenote"). The software from Gracenote (the "Gracenote Software") enables this application to perform disc and/or file identification and obtain music-related information, including name, artist, track, and title information ("Gracenote Data") from online servers or embedded databases (collectively "Gracenote Servers") and to perform other functions. You may use Gracenote Data only by means of the intended End-User functions of this application or device.

You agree that you will use Gracenote Data, the Gracenote Software, and Gracenote Servers for your own personal non-commercial use only. You agree not to assign, copy, transfer or transmit the Gracenote Software or any Gracenote Data to any third party. YOU AGREE NOT TO USE OR EXPLOIT GRACENOTE DATA, THE GRACENOTE SOFTWARE, OR GRACENOTE SERVERS, EXCEPT AS EXPRESSLY PERMITTED HEREIN.

You agree that your non-exclusive license to use the Gracenote Data, the Gracenote Software, and Gracenote Servers will terminate if you violate these restrictions. If your license terminates, you agree to cease any and all use of the Gracenote Data, the Gracenote Software, and Gracenote Servers. Gracenote reserves all rights in all Gracenote Data, all Gracenote Software, and all Gracenote Servers, including all ownership rights. Under no circumstances will Gracenote become liable for any payment to you for any information that you provide. You agree that Gracenote, Inc. may enforce its rights under this Agreement against you directly in its own name.

The Gracenote service uses a unique identifier to track queries for statistical purposes. The purpose of a randomly assigned numeric identifier is to allow the Gracenote service to count queries without knowing anything about who you are. For more information, see the web page for the Gracenote Privacy Policy for the Gracenote service.

The Gracenote Software and each item of Gracenote Data are licensed to you "AS IS." Gracenote makes no representations or warranties, express or implied, regarding the accuracy of any Gracenote Data from in the Gracenote Servers. Gracenote reserves the right to delete data from the Gracenote Servers or to change data categories for any cause that Gracenote deems sufficient. No warranty

is made that the Gracenote Software or Gracenote Servers are error-free or that functioning of Gracenote Software or Gracenote Servers will be uninterrupted. Gracenote is not obligated to provide you with new enhanced or additional data types or categories that Gracenote may provide in the future and is free to discontinue its services at any time.

GRACENOTE DISCLAIMS ALL WARRANTIES EXPRESS OR IMPLIED, INCLUDING, BUT NOT LIMITED TO, IMPLIED WARRANTIES OF MERCHANTABILITY, FITNESS FOR A PARTICULAR PURPOSE, TITLE, AND NON-INFRINGEMENT. GRACENOTE DOES NOT WARRANT THE RESULTS THAT WILL BE OBTAINED BY YOUR USE OF THE GRACENOTE SOFTWARE OR ANY GRACENOTE SERVER. IN NO CASE WILL GRACENOTE BE LIABLE FOR ANY CONSEQUENTIAL OR INCIDENTAL DAMAGES OR FOR ANY LOST PROFITS OR LOST REVENUES.

© Gracenote, Inc. 2009

Sensus software

This software uses parts of sources from clib2 and Prex Embedded Real-time OS - Source (Copyright (c) 1982, 1986, 1991, 1993, 1994), and Quercus Robusta (Copyright (c) 1990, 1993), The Regents of the University of California. All or some portions are derived from material licensed to the University of California by American Telephone and

Telegraph Co. or Unix System Laboratories, Inc. and are reproduced herein with the permission of UNIX System Laboratories, Inc. Redistribution and use in source and binary forms, with or without modification, are permitted provided that the following conditions are met: Redistributions of source code must retain the above copyright notice, this list of conditions and the following disclaimer. Redistributions in binary form must reproduce the above copyright notice, this list of conditions and the following disclaimer in the documentation and/or other materials provided with the distribution. Neither the name of the <ORGANIZATION> nor the names of its contributors may be used to endorse or promote products derived from this software without specific prior written permission. THIS SOFTWARE IS PROVIDED BY THE COPYRIGHT HOLDERS AND CONTRIBUTORS "AS IS" AND ANY EXPRESS OR IMPLIED WARRANTIES, INCLUDING, BUT NOT LIMITED TO, THE IMPLIED WARRANTIES OF MERCHANTABILITY AND FITNESS FOR A PARTICULAR PURPOSE ARE DISCLAIMED. IN NO EVENT SHALL THE COPYRIGHT OWNER OR CONTRIBUTORS BE LIABLE FOR ANY DIRECT, INDIRECT, INCIDENTAL, SPECIAL, EXEMPLARY, OR CONSEQUENTIAL DAMAGES (INCLUDING, BUT NOT LIMITED TO, PROCUREMENT OF SUBSTITUTE GOODS OR SERVICES; LOSS

OF USE, DATA, OR PROFITS; OR BUSINESS INTERRUPTION) HOWEVER CAUSED AND ON ANY THEORY OF LIABILITY, WHETHER IN CONTRACT, STRICT LIABILITY, OR TORT (INCLUDING NEGLIGENCE OR OTHERWISE) ARISING IN ANY WAY OUT OF THE USE OF THIS SOFTWARE, EVEN IF ADVISED OF THE POSSIBILITY OF SUCH DAMAGE.

This software is based in part on the work of the Independent JPEG Group.

This software uses parts of sources from "libtess". The Original Code is: OpenGL Sample Implementation, Version 1.2.1, released January 26, 2000, developed by Silicon Graphics, Inc. The Original Code is Copyright (c) 1991-2000 Silicon Graphics, Inc. Copyright in any portions created by third parties is as indicated elsewhere herein. All Rights Reserved. Copyright (C) [1991-2000] Silicon Graphics, Inc. All Rights Reserved. Permission is hereby granted, free of charge, to any person obtaining a copy of this software and associated documentation files (the "Software"), to deal in the Software without restriction, including without limitation the rights to use, copy, modify, merge, publish, distribute, sublicense, and/or sell copies of the Software, and to permit persons to whom the Software is furnished to do so, subject to the following conditions: The above copyright notice including the dates of

first publication and either this permission notice or a reference to <http://oss.sgi.com/projects/FreeB/> shall be included in all copies or substantial portions of the Software. THE SOFTWARE IS PROVIDED "AS IS", WITHOUT WARRANTY OF ANY KIND, EXPRESS OR IMPLIED, INCLUDING BUT NOT LIMITED TO THE WARRANTIES OF MERCHANTABILITY, FITNESS FOR A PARTICULAR PURPOSE AND NONINFRINGEMENT. IN NO EVENT SHALL SILICON GRAPHICS, INC. BE LIABLE FOR ANY CLAIM, DAMAGES OR OTHER LIABILITY, WHETHER IN AN ACTION OF CONTRACT, TORT OR OTHERWISE, ARISING FROM, OUT OF OR IN CONNECTION WITH THE SOFTWARE OR THE USE OR OTHER DEALINGS IN THE SOFTWARE. Except as contained in this notice, the name of Silicon Graphics, Inc. shall not be used in advertising or otherwise to promote the sale, use or other dealings in this Software without prior written authorization from Silicon Graphics, Inc.

This software is based in parts on the work of the FreeType Team.

This software uses parts of SSLeay Library: Copyright (C) 1995-1998 Eric Young (eay@cryptsoft.com). All rights reserved

Linux software



- ◀◀ This product contains software licensed under GNU General Public License (GPL) or GNU Lesser General Public License (LGPL), etc.

You have the right of acquisition, modification, and distribution of the source code of the GPL/LGPL software.

You may download Source Code from the following website at no charge: http://www.embedded-carmultimedia.jp/linux/oss/download/TVM_8351_013

The website provides the Source Code "As Is" and without warranty of any kind.

By downloading Source Code, you expressly assume all risk and liability associated with downloading and using the Source Code and complying with the user agreements that accompany each Source Code.

Please note that we cannot respond to any inquiries regarding the source code.

camellia:1.2.0

Copyright (c) 2006, 2007

NTT (Nippon Telegraph and Telephone Corporation). All rights reserved.

Redistribution and use in source and binary forms, with or without modification, are permitted provided that the following conditions are met:

1. Redistributions of source code must retain the above copyright notice, this list of

conditions and the following disclaimer as the first lines of this file unmodified.

2. Redistributions in binary form must reproduce the above copyright notice, this list of conditions and the following disclaimer in the documentation and/or other materials provided with the distribution.

THIS SOFTWARE IS PROVIDED BY NTT "AS IS" AND ANY EXPRESS OR IMPLIED WARRANTIES, INCLUDING, BUT NOT LIMITED TO, THE IMPLIED WARRANTIES OF MERCHANTABILITY AND FITNESS FOR A PARTICULAR PURPOSE ARE DISCLAIMED. IN NO EVENT SHALL NTT BE LIABLE FOR ANY DIRECT, INDIRECT, INCIDENTAL, SPECIAL, EXEMPLARY, OR CONSEQUENTIAL DAMAGES (INCLUDING, BUT NOT LIMITED TO, PROCUREMENT OF SUBSTITUTE GOODS OR SERVICES; LOSS OF USE, DATA, OR PROFITS; OR BUSINESS INTERRUPTION) HOWEVER CAUSED AND ON ANY THEORY OF LIABILITY, WHETHER IN CONTRACT, STRICT LIABILITY, OR TORT (INCLUDING NEGLIGENCE OR OTHERWISE) ARISING IN ANY WAY OUT OF THE USE OF THIS SOFTWARE, EVEN IF ADVISED OF THE POSSIBILITY OF SUCH DAMAGE.

Unicode: 5.1.0

COPYRIGHT AND PERMISSION NOTICE

Copyright c 1991-2013 Unicode, Inc. All rights reserved. Distributed under the Terms of Use in <http://www.unicode.org/copyright.html>.



Permission is hereby granted, free of charge, to any person obtaining a copy of the Unicode data files and any associated documentation (the "Data Files") or Unicode software and any associated documentation (the "Software") to deal in the Data Files or Software without restriction, including without limitation the rights to use, copy, modify, merge, publish, distribute, and/or sell copies of the Data Files or Software, and to permit persons to whom the Data Files or Software are furnished to do so, provided that (a) the above copyright notice(s) and this permission notice appear with all copies of the Data Files or Software, (b) both the above copyright notice(s) and this permission notice appear in associated documentation, and (c) there is clear notice in each modified Data File or in the Software as well as in the documentation associated with the Data File(s) or Software that the data or software has been modified.

THE DATA FILES AND SOFTWARE ARE PROVIDED "AS IS", WITHOUT WARRANTY OF ANY KIND, EXPRESS OR IMPLIED, INCLUDING BUT NOT LIMITED TO THE WARRANTIES OF MERCHANTABILITY, FITNESS FOR A PARTICULAR PURPOSE AND NON-INFRINGEMENT OF THIRD PARTY RIGHTS. IN NO EVENT SHALL THE

COPYRIGHT HOLDER OR HOLDERS INCLUDED IN THIS NOTICE BE LIABLE FOR ANY CLAIM, OR ANY SPECIAL INDIRECT OR CONSEQUENTIAL DAMAGES, OR ANY DAMAGES WHATSOEVER RESULTING FROM LOSS OF USE, DATA OR PROFITS, WHETHER IN AN ACTION OF CONTRACT, NEGLIGENCE OR OTHER TORTIOUS ACTION, ARISING OUT OF OR IN CONNECTION WITH THE USE OR PERFORMANCE OF THE DATA FILES OR SOFTWARE.

Except as contained in this notice, the name of a copyright holder shall not be used in advertising or otherwise to promote the sale, use or other dealings in these Data Files or Software without prior written authorization of the copyright holder.

Declaration of Conformity

 <p>MITSUBISHI ELECTRIC Challenges for the Better</p>	<p>MITSUBISHI ELECTRIC CORPORATION SANDA WORKS 3-3-33, Miwa, Sanda-city, Hyogo 669-0113, Japan Phone: +81-78-596302</p>
<p>DECLARATION OF CONFORMITY For</p>	
	<p>Product: Audio Navigation Unit Model: NR-0V</p>
<p>Supplied by Mitsubishi Electric Corporation Sanda Works 2-3-33, Miwa, Sanda-city, Hyogo, 669-0113, Japan</p>	<p>Technical File held by Mitsubishi Electric Corporation Sanda Works 2-3-33, Miwa, Sanda-city, Hyogo, 669-1513, Japan</p>
<p>RATTE Directive (Safety)</p>	<p>Standard used for comply EN 60950-1: 2006 + Amend.1: 2009 + Amend.1: 2010 + Amend.2: 2011 + Amend.3: 2013 EN 62479: 2011</p>
<p>RE Directive (EMC)</p>	<p>EN 301 489-1 V2.1.1: 2017-02 EN 301 489-17 V3.3.1: 2017-02</p>
<p>RE Directive (Spectrum)</p>	<p>EN 300 328 V2.2.1: 2016-6-11 EN 303 345 V1.1.7: 2017-03(Final Draft)</p>
<p>Means of Conformity We declare under our sole responsibility that the Product(s) is conformity with the essential requirements and other relevant requirements of the Radio Equipment (RE) Directive (2014/53/EU).</p>	
<p>Date of issue: May 30, 2017</p>	
<p>Signature of Responsible Person:</p>	 <hr/> <p>Hirotsuka Minato Senior Manager Design B Car Multimedia Manufacturing-A Dept. MITSUBISHI ELECTRIC CORPORATION SANDA WORKS Minato.Hirotsuka@ap.MitsubishiElectric.co.jp</p>

USA

FCC CAUTION

Changes or modifications not expressly approved by the party responsible for compliance could void the user's authority to operate the equipment. This transmitter must not be co-located or operated in conjunction with any other antenna or transmitter.

Canada

This device complies with Industry Canada license-exempt RSS standards. Operation is subject to the following two conditions: (1) this device may not cause interference, and (2) this device must accept any interference, including interference that may cause undesired operation of the device.



Country/ Area	
Brazil:	<div data-bbox="225 208 368 353" data-label="Image"> </div> <p data-bbox="225 374 1465 421">Este equipamento opera em caráter secundário isto e, não tem direito a proteção contra interferência prejudicial, mesmo tipo, e não pode causar interferência a sistemas operando em caráter primário.</p> <p data-bbox="225 437 616 456">Para consultas, visite: www.anatel.gov.br</p>
EU:	<div data-bbox="225 479 300 555" data-label="Image"> </div> <p data-bbox="225 575 1289 594">Manufacturer: Mitsubishi Electric Corporation Sanda Works 2-3-33, Miwa, Sanda-city. Hyogo, 669-1513, Japan</p> <p data-bbox="225 611 1442 658">Mitsubishi Electric Corporation hereby declares that this type of radio equipment [Audio Navigation Unit] conforms with directive 2014/53/EU.</p> <p data-bbox="225 675 922 694">For further details, search for support information on www.volvocars.com.</p>
United Arab Emirates:	<div data-bbox="225 717 368 863" data-label="Image"> </div>

Country/ Area	
Kazakhstan:	 <p>Model name: NR-0V Manufacturer: Mitsubishi Electric Corporation Export country: Japan</p>



Country/ Area	
China:	<p>1.</p> <ul style="list-style-type: none"> ■ 使用频率：2.4 - 2.4835 GHz ■ 等效全向辐射功率 (EIRP)： 天线增益 < 10dBi 时： ≤100 mW 或 ≤20 dBm ① ■ 最大功率谱密度： 天线增益 < 10dBi 时： ≤20 dBm / MHz (EIRP) ① ■ 载频容限： 20 ppm ■ 带外发射功率 (在 2.4-2.4835GHz 频段以外) ≤-80 dBm / Hz (EIRP) ■ 杂散发射 (辐射) 功率 (对应载波 ±2.5 倍信道带宽以外)： <ul style="list-style-type: none"> • ≤-36 dBm / 100 kHz (30 - 1000 MHz) • ≤-33 dBm / 100 kHz (2.4 - 2.4835 GHz) • ≤-40 dBm / 1 MHz (3.4 - 3.53 GHz) • ≤-40 dBm / 1 MHz (5.725 - 5.85 GHz) • ≤-30 dBm / 1 MHz (其它 1 - 12.75 GHz) <p>2. 不得擅自更改发射频率、加大发射功率 (包括额外加装射频功率放大器)，不得擅自外接天线或改用其它发射天线；</p> <p>3. 使用时不得对各种合法的无线电通信业务产生有害干扰；一旦发现有干扰现象时，应立即停止使用，并采取措施消除干扰后方可继续使用；</p> <p>4. 使用微功率无线电设备，必须忍受各种无线电业务的干扰或工业、科学及医疗应用设备的辐射干扰；</p> <p>5. 不得在飞机和机场附近使用。</p>

Country/ Area	
Korea:	<p>B 급 기기 (가정용 방송통신기자재)</p> <p>이 기기는 가정용(B 급) 전자파적합기기로서 주로 가정에서 사용하는 것을 목적으로 하며, 모든 지역에서 사용할 수 있습니다.</p> <p>해당 무선설비는 전파혼신 가능성이 있으므로 인명안전과 관련된 서비스는 할 수 없습니다.</p>
Malaysia:	<div data-bbox="225 400 368 546" style="border: 1px solid black; padding: 5px; text-align: center;">  </div> <p>This device has been certified under the Communications & Multimedia Act of 1998, Communications and Multimedia (Technical Standards) Regulations 2000. To retrieve your device's serial number, please visit (volvocars.com/support) and search for "SIRIM Label Verification".</p> <p>Device category: Navigation equipment for vehicle (Bluetooth)</p> <p>Model: NR-0V</p> <p>Type Approval No.: RBAY/18A/1015S(15-4067)</p>



Country/ Area	
Mexico:	
Taiwan:	<p>低功率電波輻射性電機管理辦法</p> <p>第十二條</p> <p>經型式認證合格之低功率射頻電機，非經許可，公司、商號或使用者均不得擅自變更頻率、加大功率或變更原設計之特性及功能。</p> <p>第十四條</p> <p>低功率射頻電機之使用不得影響飛航安全及干擾合法通信；經發現有干擾現象時，應立即停用，改善至無干擾時方得繼續使用。前項合法通信，指依電信法規定作業之無線電通信。低功率射頻電機須忍受合法通信或工業、科學及醫療用電波輻射性電機設備之干擾。</p>

Related information

- Audio, media and Internet (p. 470)
- Internet-connected vehicle* (p. 516)
- Media player (p. 491)
- Gracenote® (p. 495)
- Sensus - connection and entertainment (p. 30)

WHEELS AND TIRES

Tires

The function of the tires is to carry loads, provide traction on road surfaces, reduce vibrations and protect the wheels from wear.

The tires significantly influence the vehicle's driving characteristics. The type, dimensions, tire pressure and speed rating have a considerable impact on how the vehicle performs.

Your vehicle is equipped with tires according to the vehicle's tire information placard on the B-pillar (the structural member at the side of the vehicle, at the rear of the driver's door opening).

WARNING

A damaged tire could cause the driver to lose control of the vehicle.

CAUTION

Some Volvo models are equipped with an Ultra High Performance tire and wheel combination designed to provide maximum dry pavement performance with consideration for hydroplaning resistance. They may be more susceptible to road hazard damage and, depending on driving conditions, may achieve a tread life of less than 30,000 km (20,000 miles). Even if this vehicle is equipped with Volvo's advanced AWD or stability system, these tires are not designed for winter driving, and should be replaced with winter tires when weather conditions dictate.

The tires have good road holding characteristics and offer good handling on dry and wet surfaces. It should be noted however that the tires have been developed to give these features on snow/ice-free surfaces.

Most models are equipped with "all-season" tires, which provide a somewhat higher degree of roadholding on slippery road surfaces than tires without the "all-season" rating. However, Volvo recommends using snow tires on all four wheels for good roadholding on icy or snow-covered roads.

When replacing tires, be sure that the new tires are the same size designation, type (radial) and preferably from the same manufacturer, on all four wheels. Otherwise there is a risk of altering the vehicle's roadholding and handling characteristics.

Recommended tires

On delivery, the car is equipped with Volvo original tires that have the VOL¹ marking on the side of the tires. These tires have been designed specifically for your vehicle. It is therefore important when replacing tires that the new tires have this same marking to help maintain the vehicle's driving characteristics, comfort and fuel consumption.

New tires

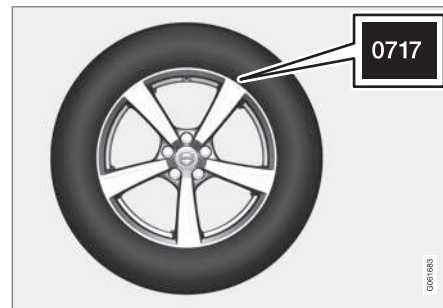

¹ This may vary for certain tire dimensions.

Tires are perishable goods. After a few years, they will begin to harden and their friction properties will gradually deteriorate. Always replace tires with the freshest tires possible. This is particularly important for snow tires. A series of numbers is imprinted on the sidewall of the tire. The last four digits in the series is the Department of Transportation (DOT) stamp and indicates the week and year the tire was manufactured. The tire in the illustration has 0717 as the last four digits, which means it was manufactured week 7 of 2017.

Tire age

Tires degrade over time, even when they are not being used. It is recommended that tires generally be replaced after 6 years of normal service. Heat caused by hot climates, frequent high loading conditions or Ultra Violet (U.V.) exposure can accelerate the aging process. The temporary spare ² should also be replaced at 6-year intervals, even if it has never been used. A tire with e.g., visible cracks or discoloration should be replaced immediately.

Tire economy

- Maintain correct tire pressure.
- Avoid fast starts, hard braking and tire screeching.
- Tire wear increases with speed.

- Correct front wheel alignment is very important.
- Unbalanced wheels impair tire economy and driving comfort.
- Tires must maintain the same direction of rotation throughout their lifetime.
- When replacing tires, the tires with the most tread should be mounted on the rear wheels to reduce the chance of oversteer during hard braking.
- Hitting curbs or potholes can damage the tires and/or wheels permanently.

Tire rotation

Your vehicle has no required tire rotation. Driving style, tire pressure, climate and road conditions affect how quickly the tires age and exhibit signs of wear. Maintaining the correct tire pressure helps keep tread wear evenly distributed.

To help prevent differences in tread depth and wear patterns forming on the tires, the front and rear wheels should be rotated, i.e. the front tires moved to the rear and the rear tires moved to the front. Ideally, tire rotation should be done the first time after approximately 5000 km (ca 3100 miles) and thereafter at 10,000 km (approx. 6200 miles) intervals.

If you have any questions regarding tread depth, Volvo recommends consulting an

authorized Volvo workshop. If significant differences in wear (> 1 mm difference in tread depth) between the tires have already occurred, the least worn tires should always be mounted on the rear wheels. A front-wheel skid (understeer) is usually easier to control than a rear-wheel skid (oversteer). If the front wheels skid, the vehicle will continue in a straight line instead of the rear wheels skidding to the side, which could cause you to completely lose control of the vehicle. It is therefore important that the rear wheels never lose grip before the front wheels.

Storing wheels and tires

When storing complete wheels (tires mounted on rims), they should be suspended off the floor or placed on their sides on the floor.

Tires not mounted on rims should be stored on their sides or standing upright, but should not be suspended.

CAUTION

Tires should preferably be stored in a cool, dry, dark place, and should never be stored in close proximity to solvents, gasoline, oils, etc.

² Not available on all models.



⚠ WARNING

- The wheel and tire sizes for your Volvo are specified to meet stringent stability and handling requirements. Unapproved wheel/tire size combinations can negatively affect your vehicle's stability and handling.
- Any damage caused by installation of unapproved wheel/tire size combinations will not be covered by your new vehicle warranty. Volvo assumes no responsibility for death, injury, or expenses that may result from such installations.

Related information

- Checking tire pressure (p. 543)
- Tire direction of rotation (p. 538)
- Tread wear indicator (p. 539)
- Tire pressure monitoring system* (p. 545)
- Tire sealing system (p. 557)
- Uniform Tire Quality Grading (p. 542)
- Tire terminology (p. 539)
- Tire sidewall designations (p. 540)
- Loading recommendations (p. 571)

Tire direction of rotation

Tires with tread designed to roll in only one direction are marked with an arrow on the sidewall.

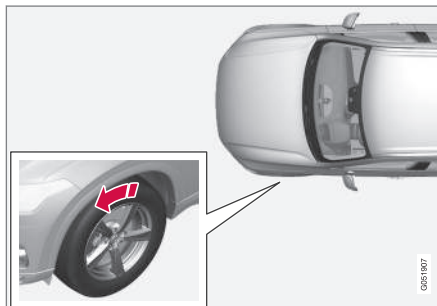

The arrow shows the tire's direction of rotation.

- The tire should maintain the same direction of rotation throughout its service life.
- Tires should only be moved between the front and back, never from right to left or vice versa.
- Incorrectly mounted tires impair the vehicle's braking properties and ability to force aside rain, snow and slush.
- The tires with the most tread should always be mounted on the rear wheels to help reduce the risk of skidding.

ⓘ NOTE

Use tires of the same type, dimensions and make (manufacturer) on each axle.

Related information

- Tires (p. 536)

Tread wear indicator

The tread wear indicator shows the status of the tire's tread.

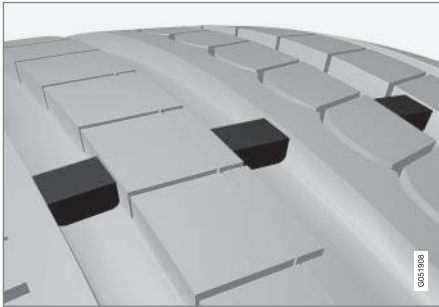

The tread wear indicator is a narrow elevated strip running across the tire's longitudinal tread grooves. The letters TWI (Tread Wear Indicator) are visible on the side of the tire. When approximately 1.6 mm (1/16 inch) is left on the tread, the tread will be at the same height as the tread wear indicator. Replace the tire as soon as possible. Tires with low tread offer very poor traction in rain or snow.

Related information

- Tires (p. 536)

Tire terminology

The following is a glossary of tire-related terms.

The tire suppliers may have additional markings, notes or warnings such as standard load, radial tubeless, etc.

- **Tire information placard:** A placard showing the OE (Original Equipment) tire sizes, recommended inflation pressure, and the maximum weight the vehicle can carry.
- **Tire Identification Number (TIN):** A number on the sidewall of each tire providing information about the tire brand and manufacturing plant, tire size and date of manufacture.
- **Inflation pressure:** A measure of the amount of air in a tire.
- **Standard load:** A class of P-metric or Metric tires designed to carry a maximum load at 35 psi [37 psi (2.5 bar) for Metric tires]. Increasing the inflation pressure beyond this pressure will not increase the tires load carrying capability.
- **Extra load:** A class of P-metric or Metric tires designed to carry a heavier maximum load at 41 psi [43 psi (2.9 bar) for Metric tires]. Increasing the inflation pressure beyond this pressure will not increase the tire's load carrying capability.
- **kPa:** Kilopascal, a metric unit of air pressure.
- **PSI:** Pounds per square inch, a standard unit of air pressure.
- **B-pillar:** The structural member at the side of the vehicle behind the front door.
- **Bead area of the tire:** Area of the tire next to the rim.
- **Sidewall of the tire:** Area between the bead area and the tread.
- **Tread area of the tire:** Area of the perimeter of the tire that contacts the road when mounted on the vehicle.
- **Rim:** The metal support (wheel) for a tire or a tire and tube assembly upon which the tire beads are seated.
- **Maximum load rating:** A figure indicating the maximum load in pounds and kilograms that can be carried by the tire. This rating is established by the tire manufacturer.
- **Maximum permissible inflation pressure:** The greatest amount of air pressure that should ever be put in the tire. This limit is set by the tire manufacturer.
- **Recommended tire inflation pressure:** Inflation pressure, established by Volvo, which is based on the type of tires that are mounted on a vehicle at the factory. This information can be found on the tire infla-



WHEELS AND TIRES

tion placard(s) located on the driver's side B-pillar and in the tire inflation table.

- **Cold tires:** The tires are considered to be cold when they have the same temperature as the surrounding (ambient) air. This temperature is normally reached after the vehicle has been parked for at least 3 hours.

Related information

- Tires (p. 536)

Tire sidewall designations

The following information can be found on a tire's sidewall.

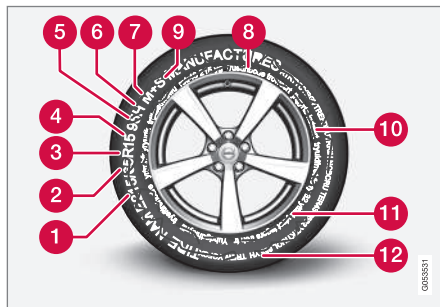

Federal law mandates that tire manufacturers place standardized information on the sidewall of all tires (see the illustration).

The vehicle has been certified with certain combinations of wheels and tires.

The following information is listed on the tire sidewall:

The tire designation:

i NOTE

Please be aware that the following tire designation is an **example only** and that this particular tire may not be available on your vehicle.

1. **215:** The width of the tire (in millimeters) from sidewall edge to sidewall edge. The larger the number, the wider the tire.
2. **65:** The ratio of the tire's height to its width in percent.
3. **R:** Radial tire (the designation **RF** and the  symbol indicate that the vehicle is equipped with optional self-supporting run flat tires³).
4. **15:** The diameter of the wheel rim (in inches).
5. **95:** The tire's load index. In this example, a load index of 95 equals a maximum load of 1521 lbs (690 kg).
6. **H:** The tire's speed rating, or the maximum speed at which the tire is designed to be driven for extended periods of time, carrying a permissible load for the vehicle, and with correct inflation pressure. For example, H indicates a speed rating of 210 km/h (130 mph).

³ Self-supporting run flat tires may not be available on all models.

i NOTE
 The tire's load index and speed rating may not appear on the sidewall because they are not required by law.

7. **M+S or M/S** = Mud and Snow, **AT** = All Terrain, **AS** = All Season
8. **U.S. DOT Tire Identification Number (TIN)**: This begins with the letters "DOT" and indicates that the tire meets all federal standards. The next two numbers are the factory code where the tire was manufactured, the next two are the tire size code and the last four numbers represent the week and year the tire was made. For example, 0717 means that the tire was manufactured during week 7 of 2017. The numbers in between are marketing codes used at the manufacturer's discretion. This information helps a tire manufacturer identify a tire for safety recall purposes.
9. **Tire Ply Composition and Material Used**: Indicates the number of plies indicates or the number of layers of rubber-coated fabric in the tire tread and sidewall. Tire manufacturers also must indicate the ply materials in the tire and the sidewall, which include steel, nylon, polyester, and others.
10. **Maximum Load**: Indicates the maximum load in pounds and kilograms that can be

carried by the tire. Refer to the vehicle's tire information placard located on the B-Pillar for the correct tire pressure for your vehicle.

11. **Treadwear, Traction, and Temperature grades.**
12. **Maximum permissible inflation pressure**: The greatest amount of air pressure that should ever be put in the tire. This limit is set by the tire manufacturer.

Speed Symbol

A tire's Speed Symbol (SS) indicates the maximum speed for which the tire has been certified and should be at least equivalent to the vehicle's top speed.

Winter tires, with or without studs, are exceptions and may use a lower SS. When winter tires are installed, the vehicle may not be driven faster than the tires' SS.

The vehicle's speed should always be determined by the posted speed limit and traffic and road conditions, not the tire's SS.

The following table indicates the maximum permissible speed for each SS.

M	130 km/h (81 mph)
Q	160 km/h (100 mph)

T	190 km/h (118 mph)
H	210 km/h (130 mph)
V	240 km/h (149 mph)
W	270 km/h (168 mph)
Y	300 km/h (186 mph)

⚠ WARNING

- The wheel and tire sizes for your Volvo are specified to meet stringent stability and handling requirements. Unapproved wheel/tire size combinations can negatively affect your vehicle's stability and handling.
- Any damage caused by installation of unapproved wheel/tire size combinations will not be covered by your new vehicle warranty. Volvo assumes no responsibility for death, injury, or expenses that may result from such installations.

Related information

- Tires (p. 536)

Uniform Tire Quality Grading

ALL PASSENGER VEHICLE TIRES MUST CONFORM TO FEDERAL SAFETY REQUIREMENTS IN ADDITION TO THESE GRADES.

Quality grades can be found, where applicable, on the tire sidewall between the tread shoulder and maximum section width. For example:

Treadwear 200 Traction AA Temperature A

TREADWEAR

The treadwear grade is a comparative rating based on the wear rate of the tire when tested under controlled conditions on a specified government test course. For example, a tire graded 150 would wear one and one half (1 ½) times as well on the government course as a tire graded 100. The relative performance of tires depends upon the actual conditions of their use, however, and many depart significantly from the norm due to variation in driving habits, maintenance practices and differences in road characteristics and climate.

TRACTION

The traction grades, from highest to lowest, are AA, A, B, and C, as measured under controlled conditions on specified government test surfaces of asphalt and concrete. A tire marked C may have poor traction performance.

WARNING

The traction grade assigned to this tire is based on braking (straight-ahead) traction tests and is not a measure of cornering (turning) traction.

TEMPERATURE

The temperature grades are A (the highest), B, and C, representing the tire's resistance to the generation of heat and its ability to dissipate heat when tested under controlled conditions on a specified indoor laboratory test wheel. Sustained high temperature can cause the material of the tire to degenerate and reduce tire life, and excessive temperature can lead to sudden tire failure. The grade C corresponds to a minimum level of performance that all passenger vehicle tires must meet under the Federal Motor Safety Standard No. 109. Grades B and A represent higher levels of performance on the laboratory test wheel than the minimum required by law.

WARNING

The temperature grade for this tire is established for a tire that is properly inflated and not overloaded. Excessive speed, underinflation, or excessive loading, either separately or in combination, can cause heat buildup and tire failure.

Related information

- Tires (p. 536)
- Tire sidewall designations (p. 540)

Checking tire pressure

Correct inflation pressure helps improve driving stability, save fuel and increase the service life of the tires.

Tire pressure decreases over time, which is normal. Tire pressure also varies depending on the ambient temperature. Driving on under-inflated tires could cause the vehicle to over-heat and lead to damage. Tire pressure affects traveling comfort, road noise and driving characteristics.

Check the pressure in the tires every month. Use the recommended inflation pressure for cold tires to help maintain good tire performance. Under-inflated or over-inflated tires could cause uneven tread wear.

Use an air pressure gauge and check the inflation pressure on all the tires, including the spare tire⁴, at least once a month and before long trips. Volvo recommends buying a reliable air pressure gauge, as the automatic gauges provided at service stations may be inaccurate.

WARNING

- Under-inflation is the most common cause of tire failure and may result in severe tire cracking, tread separation, or "blow-out," with unexpected loss of vehicle control and increased risk of injury.
- Under-inflated tires reduce the load carrying capacity of your vehicle.

Cold tires

Inflation pressure should be checked when the tires are cold. The tires are considered to be cold when they have the same temperature as the surrounding (ambient) air. This temperature is normally reached after the vehicle has been parked for at least 3 hours.

After driving for approximately 1.6 km (1 mile), the tires are considered to be warm. If you need to drive longer than that to inflate the tires, check and record the inflation pressure of the tires first and inflate accordingly when you arrive at the pump.

When the ambient temperature changes, so does the inflation pressure. A 10-degree temperature drop causes a corresponding drop in inflation pressure of 1 psi (7 kPa). Check the inflation pressure of the tires regularly and adjust to the correct pressure, which can be

found on the vehicle's tire information decal or certification label.

If you check inflation pressure when the tires are warm, you should never release air. The tires become warm after driving and it is normal for warm tires to have an inflation pressure above the recommended pressure for cold tires. A warm tire with an inflation pressure equal to or under the recommended pressure for cold tires could be significantly under-inflated.

Related information

- Adjusting tire pressure (p. 544)
- Recommended tire pressure (p. 545)
- Tire pressure monitoring system* (p. 545)
- Tires (p. 536)

⁴ Not available in all models.

Adjusting tire pressure

Tire pressure decreases over time, which is normal. The tire pressure must therefore be adjusted to maintain the recommended tire pressure.

Use the recommended inflation pressure for cold tires to help maintain good tire performance and even wear.

NOTE

To help prevent incorrect inflation pressure, pressure should be checked when the tires are cold. The tires are considered to be cold when they have reached the same temperature as the ambient temperature (about 3 hours after the vehicle was last driven). After driving for a few kilometers, the tires will warm up and the pressure will increase.

1. Remove the valve cap from the tire and press the air pressure gauge firmly onto the valve.
2. Inflate the tire to the correct inflation pressure; see the tire pressure placard on the driver's side B pillar for recommended pressures for factory-mounted tires.

3. Screw the valve cap back on.

NOTE

- After inflating a tire, always replace the valve cap to help prevent valve damage caused by gravel, dirt, etc.
- Use plastic valve caps only. Metal caps could corrode and become difficult to remove.

4. Visually inspect the tire to make sure there are no nails or other embedded objects that could puncture the tire and cause air leakage.
5. Check the sidewalls to make sure there are no gouges, cuts, bulges or other irregularities.
6. Repeat this procedure for each tire, including the spare tire⁵.

NOTE

If you have overfilled the tire, release air by pushing on the metal stem in the center of the valve. Then recheck the pressure with your tire gauge.

Some spare tires require higher inflation pressure than the other tires. Consult the tire inflation pressure table or the inflation pressure decal.

Related information

- Recommended tire pressure (p. 545)
- Checking tire pressure (p. 543)
- Inflate tires with the compressor included in the tire sealing system (p. 562)
- Approved tire pressure (p. 657)

⁵ Not available on all models.

Recommended tire pressure

The tire pressure placard on the driver's side B pillar (between the front and the rear door) indicates tire pressure for different loads and speed conditions.



Location of the tire pressure placard

The decal specifies the designation for the factory-mounted tires on the vehicle, as well as load limits and inflation pressures.

i NOTE

The decals shown in the Owner's Manual do not claim to be exact reproductions of those found in the vehicle. The purpose is to show approximately how they look and about where they are located on the vehicle. The information that applies for your vehicle in particular is found on the decal on the vehicle.

Related information

- Checking tire pressure (p. 543)
- Approved tire pressure (p. 657)

Tire pressure monitoring system*

The tire inflation pressure monitoring system⁶ provides an indicator symbol in the instrument panel if pressure is too low in one or more tires.



This symbol illuminates to indicate low inflation pressure. Check the inflation pressure in the **Car Status** app in the center display.

If there is a system malfunction, the inflation pressure warning symbol will flash for approximately one minute and then glow steadily.

System description

The tire pressure monitoring system measures differences in rotational speed between the wheels through the ABS system to determine if the tires are properly inflated. If inflation pressure in a tire is too low, its diameter (and consequently its rotational speed) changes. By comparing the tires with each other, the system can determine if the pressure in one or more tires is too low.



◀ **General information about the tire pressure monitoring system**

In the following description, the tire monitoring system is generally referred to as TPMS.

Each tire, including the spare (if provided)⁷ should be checked monthly when cold and inflated to the inflation pressure recommended by the vehicle manufacturer on the vehicle placard or tire inflation pressure label. (If your vehicle has tires of a different size than the size indicated on the vehicle placard or tire inflation pressure label, you should determine the proper tire inflation pressure for those tires.)

As an added safety feature, your vehicle has been equipped with a tire pressure monitoring system (TPMS) that illuminates a low tire pressure telltale when one or more of your tires is significantly under-inflated. Accordingly, when the low tire pressure telltale illuminates, you should stop and check your tires as soon as possible, and inflate them to the proper pressure.

Driving on a significantly under-inflated tire causes the tire to overheat and can lead to tire failure. Under-inflation also reduces fuel efficiency and tire tread life, and may affect the vehicle's handling and stopping ability. Please

note that the TPMS is not a substitute for proper tire maintenance, and it is the driver's responsibility to maintain correct tire pressure, even if under-inflation has not reached the level to trigger illumination of the TPMS low tire pressure telltale.

Your vehicle has also been equipped with a TPMS malfunction indicator to indicate when the system is not operating properly. The TPMS malfunction indicator is combined with the low tire pressure telltale. When the system detects a malfunction, the telltale will flash for approximately one minute and then remain continuously illuminated. This sequence will continue upon subsequent vehicle start-ups as long as the malfunction exists. When the malfunction indicator is illuminated, the system may not be able to detect or signal low tire pressure as intended.

TPMS malfunctions may occur for a variety of reasons, including the installation of replacement or alternate tires or wheels on the vehicle that prevent the TPMS from functioning properly.

Always check the TPMS malfunction telltale after replacing one or more tires or wheels on your vehicle to ensure that the replacement or alternate tires and wheels allow the TPMS to continue to function properly.

To keep in mind

- Always save the new inflation pressure in the system after changing a tire or adjusting the inflation pressure.
- If you switch to a tire of another size than the factory-mounted tires, the system must be reset by storing a new inflation pressure for these tires to avoid false warnings.
- If a spare wheel⁸ is used, it is possible that the tire pressure monitoring system will not work correctly due to the differences between the wheels.
- The system does not replace the need for regular tire inspection and maintenance.
- It is not possible to deactivate the tire pressure monitoring system.

WARNING

- Incorrect inflation pressure could lead to tire failure, which could cause the driver to lose control of the vehicle.
- The system cannot predict sudden tire damage.

⁶ Tire Pressure Monitoring System (TPMS)

⁷ Not available on all models.

⁸ Not available on all models.

Related information

- Recommended tire pressure (p. 545)
- Viewing tire pressure status in the center display* (p. 548)
- Action when warned of low tire pressure (p. 549)
- Saving new reference values for tire inflation pressure monitoring* (p. 547)
- Tire inflation pressure monitoring system* messages (p. 550)

Saving new reference values for tire inflation pressure monitoring*

In order for the tire inflation pressure monitoring system⁹ to function correctly, inflation pressure reference values must be saved correctly. To help ensure that the system can correctly alert the driver of low inflation pressure, this must be done each time the tires are changed or the inflation pressure is adjusted.

For example, when driving with a heavy load or at high speeds (over 160 km/h (100 mph)), tire pressure should be adjusted to the Volvo-recommended tire pressure values. The system should then be reset by saving the new inflation pressure.

To store the new inflation pressure as a reference value in the system:

1. Switch off the ignition.
2. Inflate the tire to the correct inflation pressure; see the tire pressure placard on the driver's side B pillar for recommended pressures for factory-mounted tires.
3. Start the vehicle.
4. Open the **Car Status** app in App view.
5. Tap **TPMS**.

i	NOTE
The vehicle must be stationary for the Store Pressure button to be selectable.	

6. Tap **Store Pressure**.
7. Tap **OK** to confirm that the tire pressure in all four tires has been checked and adjusted.
8. Drive the vehicle until the new inflation pressure has been saved. The new inflation pressure is stored when the vehicle is driven at speeds over 35 km/h (22 mph).
 - > When enough data has been collected for the system to detect low inflation pressure, the animation showing the progress of the storing procedure will disappear from the center display. The system will not provide any further confirmation that the new inflation pressure has been stored.

If storing cannot be performed, **Storing pressure unsuccessful. Try again.** will be displayed.

⁹ Tire Pressure Monitoring System (TPMS)





⚠ WARNING

The exhaust gases contain carbon monoxide, which is invisible and odorless but very poisonous. The procedure for saving a new inflation pressure must therefore always be performed outdoors or in a workshop with exhaust gas extraction.

Related information

- Recommended tire pressure (p. 545)
- Adjusting tire pressure (p. 544)
- Viewing tire pressure status in the center display* (p. 548)
- Action when warned of low tire pressure (p. 549)
- Tire pressure monitoring system* (p. 545)

Viewing tire pressure status in the center display*

With the system for tire inflation pressure monitoring¹⁰, inflation pressure status can be viewed in the center display.

Checking status

The vehicle may need to be driven for a few minutes at a speed above 35 km/h (22 mph) to activate the system.

1. Open the **Car Status** app in App view.
2. Tap **TPMS** to display the status of the tires.



The illustration is generic. Layout may vary depending on vehicle model or software version.

Related information

- Saving new reference values for tire inflation pressure monitoring* (p. 547)
- Action when warned of low tire pressure (p. 549)
- Tire pressure monitoring system* (p. 545)
- Vehicle status (p. 587)
- Tire inflation pressure monitoring system* messages (p. 550)

¹⁰ Tire Pressure Monitoring System (TPMS)

Action when warned of low tire pressure

When the tire inflation pressure monitoring system¹¹ detects low inflation pressure in a tire, immediate action is required.



If the system's indicator symbol illuminates and the message **Tire pressure low** is displayed, check the tire pressure and inflate if necessary.

1. Switch off the ignition.
2. Check the inflation pressure on all four tires using a tire pressure gauge.
3. Inflate the tire to the correct inflation pressure; see the tire pressure placard on the driver's side B pillar for recommended pressures for factory-mounted tires.
4. After the inflation pressure has been adjusted, always save the new inflation pressure in the system via the center display.

Please be aware that the indicator symbol will not go out until the low tire pressure has been corrected and a storing procedure has been started for the new inflation pressure.

NOTE

To help prevent incorrect inflation pressure, pressure should be checked when the tires are cold. The tires are considered to be cold when they have reached the same temperature as the ambient temperature (about 3 hours after the vehicle was last driven). After driving for a few kilometers, the tires will warm up and the pressure will increase.

NOTE

- After inflating a tire, always replace the valve cap to help prevent valve damage caused by gravel, dirt, etc.
- Use plastic valve caps only. Metal caps could corrode and become difficult to remove.

WARNING

- Incorrect inflation pressure could lead to tire failure, which could cause the driver to lose control of the vehicle.
- The system cannot predict sudden tire damage.

Related information

- Recommended tire pressure (p. 545)
- Adjusting tire pressure (p. 544)
- Saving new reference values for tire inflation pressure monitoring* (p. 547)
- Viewing tire pressure status in the center display* (p. 548)
- Tire pressure monitoring system* (p. 545)
- Inflate tires with the compressor included in the tire sealing system (p. 562)

¹¹ Tire Pressure Monitoring System (TPMS)

Tire inflation pressure monitoring system* messages

A number of messages related to the tire inflation pressure monitoring system¹² may be displayed. Several examples are provided below.

Instrument panel: Tire pressure low Check Car Status app in center display	The indicator symbol will illuminate to indicate that inflation pressure is low in one or more tires. See the Car Status app in the center display for more information.
Instrument panel: Tire pressure system Temporarily unavailable	The indicator symbol will flash for about 1 minute and then glow steadily. The system is temporarily unavailable and will be activated momentarily.
Instrument panel: Tire pressure system Service required	The indicator symbol will flash for about 1 minute and then glow steadily. If the system is not working properly, contact a workshop ^A .

^A An authorized Volvo workshop is recommended.

Related information

- Tire pressure monitoring system* (p. 545)
- Saving new reference values for tire inflation pressure monitoring* (p. 547)
- Action when warned of low tire pressure (p. 549)
- Vehicle status (p. 587)
- Volvo Cars support site (p. 21)

Changing a wheel

Wheel changes must always be carried out correctly. The following instructions show how to remove and install a wheel and what is important to keep in mind. Make sure that the tire dimension is approved for use on the vehicle.

 WARNING

- If a tire must be changed near passing traffic, make sure all passengers move to a safe location.
- Use a jack intended for the vehicle when changing a tire. For any other job, use stands to support the vehicle.
- Never crawl under or allow any part of your body to be extended under a vehicle supported by a jack.
- Never let anyone remain in the vehicle when it is raised on a jack.

¹² Tire Pressure Monitoring System (TPMS)

! CAUTION

- When not in use, the jack* should be kept in its storage compartment under the cargo compartment floor.
- The jack provided with your vehicle is intended to be used only in temporary situations such as changing wheels in the event of a flat tire. Only the jack that came with your particular model should be used to lift the vehicle. If the vehicle needs to be lifted more frequently or for a prolonged period, using a garage jack or hoist is recommended. Always follow this device's instructions for use.

Removing a wheel

Read through all instructions before starting. Before raising the vehicle using a jack or lift, take out all the tools you will need.

1. Turn on the vehicle's hazard warning flashers if a wheel change must be performed in an area with traffic.
2. Make sure that the parking brake is engaged and put the gear selector in **P** position.
3. Place chocks in front of and behind the wheels that are still on the ground. For example, use heavy wooden blocks or large stones.

4. Using the lug wrench, screw the towing eye into place as far as possible.

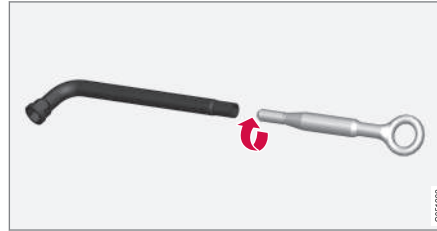

5. Remove the plastic covers from the wheel bolts using the designated tool.
6. With the vehicle still on the ground, use the lug wrench/towing eye to loosen the wheel bolts 1/2-1 turn by pressing downward (counterclockwise). Always start with the locking wheel bolts*.
7. Follow the instructions for safely lifting the vehicle using a jack.
8. Raise the vehicle until the wheel to be changed can move freely. Unscrew the wheel bolts and lift off the wheel.

Installing a wheel

1. Clean the contact surfaces between the wheel and the wheel hub.

2. Lift the wheel into place. Tighten the wheel bolts securely. Do **not** grease the wheel bolt threads.
3. Lower the vehicle so that the wheel cannot rotate.
4. Tighten the wheel bolts in a crisscross pattern (as shown in illustration). It is important that the wheel bolts are securely tightened. Tighten to 140 Nm (103 ft. lbs.). Use a torque wrench to check torque.



5. Press the plastic covers over the wheel bolts.
6. Check the tire inflation pressure and store the new inflation pressure in the tire pressure monitoring system*.





⚠ WARNING

The wheel bolts may need to be tightened again several days after a wheel change. Temperature fluctuations and vibrations can cause them to loosen slightly.

i NOTE

- After inflating a tire, always replace the valve cap to help prevent valve damage caused by gravel, dirt, etc.
- Use plastic valve caps only. Metal caps could corrode and become difficult to remove.

Related information

- Hoisting the vehicle (p. 590)
- Tool kit (p. 552)
- Saving new reference values for tire inflation pressure monitoring* (p. 547)

Tool kit

Tools for e.g. towing or changing wheels are provided in the vehicle's cargo compartment.



All the tools are located in a foam block under the cargo compartment floor.

- 1 Jack*
- 2 Tool for removing the plastic wheel bolt covers
- 3 Funnel for refilling fluids
- 4 Wheel bolt key* and towing eyelet

If the vehicle is equipped with a spare tire^{*13}, a jack and lug wrench are provided.

Related information

- Changing a wheel (p. 550)
- Jack* (p. 553)

- Tire sealing system (p. 557)
- Attaching and removing the towing eyelet (p. 461)

¹³ Not available on all models.

Jack*

The jack can be used to lift the vehicle to e.g. change a wheel.



! CAUTION

- When not in use, the jack* should be kept in its storage compartment under the cargo compartment floor.
- The jack provided with your vehicle is intended to be used only in temporary situations such as changing wheels in the event of a flat tire. Only the jack that came with your particular model should be used to lift the vehicle. If the vehicle needs to be lifted more frequently or for a prolonged period, using a garage jack or hoist is recommended. Always follow this device's instructions for use.

The jack needs to be cranked together to the correct position in order to fit.

For vehicles with **Leveling Control***: If the vehicle is equipped with the optional pneumatic suspension, it must be turned off before the vehicle is lifted on a jack.

Related information

- Tool kit (p. 552)
- Hoisting the vehicle (p. 590)

Wheel bolts

The wheel bolts hold the wheel in place on the wheel hub.

Only use rims that have been tested and approved by Volvo and are included in Volvo's original product range.

Use a torque wrench to check that the wheel bolts are tightened correctly.

Do **not** grease the wheel bolt threads.

! WARNING

The wheel bolts may need to be tightened again several days after a wheel change. Temperature fluctuations and vibrations can cause them to loosen slightly.

! CAUTION

The wheel bolts should be tightened to 140 Nm (103 ft. lbs.). Over-tightening or under-tightening could damage the threaded joints.

Locking wheel bolt kit*

To loosen or tighten the locking wheel bolts, turn the wrench in the locking bolt until it fully engages in the code grooves. When removing a wheel, always start with the locking wheel bolts. When mounting a wheel, end with the locking bolt.





CAUTION

Make sure you have a solid connection between bolt and wheel bolt key when loosening/tightening the wheel bolts. Applying force at an angle could damage the slots in the wheel bolts and the wheel bolt key and make it impossible to install or remove the wheel.

When the wheel bolt key is not being used, stow it in its designated location in the foam block under the cargo compartment floor. This is important to remember so that the tool is available if the vehicle is taken to a workshop. If you lose the key, contact your Volvo retailer.

Related information

- Changing a wheel (p. 550)
- Tool kit (p. 552)

Spare wheel¹⁴

The spare wheel is a Temporary Spare and can be used to temporarily replace a punctured tire on one of the vehicle's regular wheels.

The spare wheel is only intended for temporary use. Replace it with a normal wheel as soon as possible.

The driving characteristics of the vehicle change and ground clearance reduces when the spare wheel is used. Do not wash the vehicle in an automatic car wash while using the Temporary Spare.

The recommended tire pressure must be maintained regardless of at which position the temporary spare wheel is used on the vehicle.

If the spare wheel is damaged, a replacement can be purchased from a Volvo retailer.

WARNING

Current legislation prohibits the use of the "Temporary Spare" wheel other than as a temporary replacement for a punctured tire. It must be replaced as soon as possible by a standard tire. Roadholding and handling may be affected with the "Temporary Spare" wheel in use.

WARNING

- Never drive faster than 80 km/h (50 mph) with a spare tire mounted on the vehicle.
- The vehicle must never be driven with more than one "Temporary Spare" wheel mounted.
- Driving with a spare wheel may alter the driving characteristics of the vehicle. Replace the spare wheel with a normal wheel as soon as possible.
- The spare wheel is smaller than the normal wheel, which affects the vehicle's ground clearance. Watch for high curbs and do not wash the vehicle in an automatic car wash when a spare wheel is mounted.
- Follow the manufacturer's recommended tire inflation pressure for the spare wheel.
- On all-wheel drive vehicles, the drive on the rear axle can be disconnected.
- If the spare wheel is mounted on the front axle, snow chains must not be used.
- The spare wheel must not be repaired.

¹⁴ Not available on all models.

CAUTION

The vehicle must not be driven with tires of different dimensions or with a spare wheel other than the one that came with the vehicle. The use of different size wheels can seriously damage your vehicle's transmission.

Related information

- Changing a wheel (p. 550)
- Recommended tire pressure (p. 545)

Handling the spare wheel¹⁵

Follow these instructions regarding handling the spare wheel.

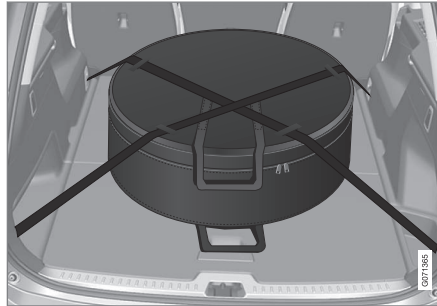

This illustration is generic and appearance may vary.

The spare wheel is stored in a bag and should be secured with two straps onto the floor of the trunk/cargo compartment when the vehicle is being driven. The straps should be strapped down crosswise over the wheel, attached to the load anchoring eyelets and pulled taut.

Wheel changing tools are located under the cargo compartment floor.

Polestar Engineered

If your vehicle is Polestar Engineered, Temporary Spare tires will not fit on the front wheel axle due to the larger brakes.

Tires should only be moved between the front and back, never from right to left or vice versa. If one of the front tires needs to be replaced with a spare tire:

1. Use the spare tire to replace the rear tire on the same side of the vehicle as the flat tire.
2. Move the rear tire to the front to replace the flat tire.

Related information

- Spare wheel (p. 554)
- Tool kit (p. 552)
- Changing a wheel (p. 550)

¹⁵ Not available on all models.

Snow tires

Snow tires are designed for winter driving conditions.

Volvo recommends snow tires with specific dimensions. The tire dimensions vary depending on engine type. When driving with snow tires, the correct type of tires must be mounted on all four wheels.

Tips for changing snow tires

When switching between regular tires and snow tires, mark the tires according to which side they were mounted on, e.g. **L** for left and **R** for right.

Contact a Volvo retailer for assistance determining the most suitable rims and tires.

Studded tires

Studded tires should be broken in by driving 500–1000 km (300–600 miles) slowly and gently to help the studs settle properly in the tires. This gives the tire, and especially the studs, a longer service life.

NOTE

Legal requirements concerning the use of studded tires may vary. Always follow local laws and regulations.

Tread depth

Road conditions with ice, slush and low temperatures place considerably higher demands

on tires than summer conditions. Volvo therefore recommends not driving on snow tires that have a tread depth of less than 4 mm (0.15 inch).

Related information

- Changing a wheel (p. 550)
- Winter driving (p. 446)
- Tread wear indicator (p. 539)
- Volvo Cars support site (p. 21)

Snow chains

Using snow chains and/or snow tires can help improve traction in winter driving conditions.

Volvo does not recommend use of snow chains on wheel dimensions other than 7.5x18 ET 45 235/45. Volvo does not recommend use of snow chains on for Polestar Engineered, but AutoSock can be used as a supplement to winter tires for the wheel dimension 8x19 ET 42 235/40.

WARNING

Use Volvo genuine snow chains or equivalent snow chains that are suitable for the vehicle model and the tire and wheel sizes. Only **one-sided** snow chains are permitted.

If uncertain about snow chains, Volvo recommends contacting an authorized Volvo workshop. Use of the wrong snow chains could cause serious damage to the vehicle and result in an accident.

! CAUTION

Snow chains can be used on the vehicle, with the following restrictions:

- Always follow the manufacturer's installation instructions carefully. Install chains as tightly as possible and retighten periodically.
- Only put snow chains on the front wheels (also applies to all-wheel drive vehicles).
- If accessory, aftermarket or "custom" tires and wheels with different dimensions than the original tires and wheels are used, snow chains in some cases may NOT be used. Sufficient distance between the chains and brakes, suspension and body components must be maintained.
- Check local regulations regarding the use of snow chains before installing.
- Never exceed the snow chain manufacturer's specified maximum speed limit. Under no circumstances should you exceed 50 km/h (30 mph).
- Avoid bumps, holes or sharp turns when driving with snow chains.
- Avoid driving on surfaces without snow as this wears out both the snow chains and the tires.

- The handling of the vehicle can be adversely affected when driving with chains. Avoid fast or sharp turns as well as locked wheel braking.
- Some types of strap-on chains affect brake components and therefore must NOT be used.

Consult a Volvo retailer for more information about snow chains.

Related information

- Winter driving (p. 446)

Tire sealing system¹⁶

The temporary tire sealing system can be used to seal a puncture in a tire or to check and adjust the pressure in the tire.

Models equipped with a spare wheel¹⁷ do not have the tire sealing system.

! WARNING**California Proposition 65**

Operating, servicing and maintaining a passenger vehicle can expose you to chemicals including engine exhaust, carbon monoxide, phthalates, and lead, which are known to the State of California to cause cancer and birth defects or other reproductive harm. To minimize exposure, avoid breathing exhaust, do not idle the engine except as necessary, service your vehicle in a well ventilated area and wear gloves or wash your hands frequently when servicing your vehicle. For more information go to www.P65Warnings.ca.gov/passenger-vehicle.

The tire sealing system consists of a compressor and a bottle containing sealing compound. The sealing functions as a temporary repair.





i NOTE

The sealing compound effectively seals tires with punctures in the tread but may not be able to fully seal tires with punctures in the sidewall. Do not use the tire sealing system on tires with large tears, cracks or similar damage.

i NOTE

The compressor is intended for temporary tire sealing and is approved by Volvo.

Location

The tire sealing system is located in a foam block under the cargo compartment floor.



Sealing compound expiration date

The sealing compound bottle must be replaced if its expiration date has passed (see the decal on the bottle). Handle the old bottle as hazardous waste.

Related information

- Using the tire sealing system (p. 558)
- Inflate tires with the compressor included in the tire sealing system (p. 562)
- Tires (p. 536)

Using the tire sealing system

The temporary tire sealing system (TMK¹⁸) can be used to seal a puncture in a tire. Read through all instructions before use.

Overview

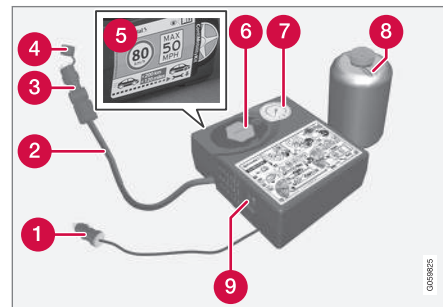

- 1 Electrical cable
- 2 Hose
- 3 Air release valve
- 4 Protective hose cover
- 5 Speed limit sticker
- 6 Bottle holder (orange cover)
- 7 Air pressure gauge

16 Certain models only.
 17 Not available on all models.
 18 Temporary Mobility Kit

8 Sealing compound bottle

9 Switch

Connecting

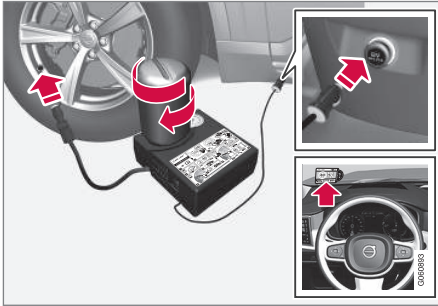

i NOTE

Do not break the seal of the bottle before use. The seal is broken automatically when the bottle is screwed into place.

! WARNING

Please keep the following points in mind when using the tire sealing system:

- The sealing compound bottle (no. 8 in the illustration) contains 1) rubber latex, natural and 2) ethanediol. These substances are harmful if swallowed.
- The contents of this bottle may cause allergic skin reactions or otherwise be potentially harmful to the respiratory tract, the skin, the central nervous system, and the eyes.

Precautions:

- Keep out of reach of children.
- Do not ingest the contents.
- Avoid prolonged or repeated contact with the skin. Remove any clothing that has come into contact with sealant.
- Wash thoroughly after handling.

First aid:

- Skin: Wash affected areas of the skin with soap and water. Get medical attention if symptoms occur.
- Eyes: Flush with plenty of water for at least 15 minutes, occasionally lifting the upper and lower eyelids. Get medical attention if symptoms occur.

- Inhalation: Move the exposed person to fresh air. If irritation persists, get medical attention.
- Ingestion: Do NOT induce vomiting unless directed to do so by medical personnel. Get medical attention.
- Disposal: Dispose of this material and its container at a hazardous or special waste collection point.

! WARNING

Do not remove the bottle or the hose while the tire sealing system is being used.

1. Preparations

Turn on the vehicle's hazard warning flashers if the tire sealing system is to be used in an area with traffic.

If the puncture was caused by a nail or similar object, do not remove it. It will help seal the hole.

2. Peel off the speed limit sticker from the side of the compressor. Affix the decal to a clearly visible location on the windshield to remind the driver not to exceed this speed limit. Do not drive faster than 80 km/h (50 mph) while using a tire that has been temporarily repaired with the tire sealing system.



WHEELS AND TIRES

- ◀ 3. Make sure the switch is in the **0** (Off) position and take out the electric cable and the hose.
4. Unscrew the orange cover on the compressor and unscrew the cap on the sealing compound bottle.
5. Screw the bottle onto the bottle holder as far as possible.

The bottle and the bottle holder are equipped with catches to help prevent the sealing compound from leaking. Once the bottle is screwed into place into the bottle holder, it cannot be unscrewed. The bottle can only be removed by a workshop¹⁹.

WARNING

Do not unscrew the bottle. It is equipped with a catch to prevent leakage.

6. Unscrew the tire's valve cap and screw the hose's valve connector as far as possible onto the valve.

Be sure the air release valve on the compressor's hose is completely closed.

7. **Begin tire sealing procedure**

Connect the electrical cable to the nearest 12 V outlet and start the vehicle.

NOTE

Make sure that none of the vehicle's other 12 V sockets are used while the compressor is running.

WARNING

Never leave children unattended in the vehicle while the engine is running.

WARNING

Inhaling exhaust fumes could lead to serious injury. Never leave the engine running in an enclosed space or a space without sufficient ventilation.

8. Start the compressor by moving the switch to the **I** (On) position.

When the compressor starts, the pressure can increase up to 6 bar (88 psi), but the pressure will decrease after approx. 30 seconds.

WARNING

Never stand next to a tire being inflated with the compressor. If cracks, bulges, etc. form on the tire, switch off the compressor immediately. The vehicle should not be driven. Call roadside assistance to have the vehicle towed to a workshop for inspection/replacement of the tire. Volvo recommends an authorized workshop.

9. Inflate the tire for 7 minutes.

CAUTION

To help avoid overheating, the compressor should never be used for more than 10 minutes at a time.

¹⁹ An authorized Volvo workshop is recommended.

- Switch off the compressor and check the inflation pressure using the air pressure gauge. The inflation pressure should be between 1.8 bar (22 psi) and 3.5 bar (51 psi). If the inflation pressure is too high, use the air release valve to release air.

⚠ WARNING

If pressure falls below 1.8 bar (22 psi), the hole in the tire may be too large. The vehicle should not be driven. Call roadside assistance to have the vehicle towed to a workshop for inspection/replacement of the tire. Volvo recommends an authorized workshop.

- Switch off the compressor and remove the electrical cable.
- Unscrew the hose from the tire's valve and screw the valve cap back on.

i NOTE

- After inflating a tire, always replace the valve cap to help prevent valve damage caused by gravel, dirt, etc.
- Use plastic valve caps only. Metal caps could corrode and become difficult to remove.

- Put the protective hose cover onto the hose to help prevent leakage of any residual sealing compound. Return the equipment to the cargo compartment.
- Immediately drive the vehicle at least 3 km (2 miles) at a maximum speed of 80 km/h (50 mph) to allow the sealing compound to seal the tire, and then recheck the inflation pressure.

⚠ WARNING

During the tire's first revolution, some sealing compound may spray out of the puncture hole. Before driving away, make sure that no one is near the vehicle who could be sprayed with sealing compound. Make sure no one is within 2 meters (7 feet) of the vehicle.

15. Rechecking the inflation pressure

Connect the hose to the tire's valve and screw the hose connector onto the valve as far as possible. The compressor must be switched off.

- Check the inflation pressure on the air pressure gauge.
 - If the pressure is under 1.3 bar (19 psi), the tire is not sufficiently sealed. The vehicle should not be driven. Call roadside assistance to have the vehicle towed.
 - If the inflation pressure is higher than 1.3 bar (19 psi), the tire must be inflated to the inflation pressure specified on the tire pressure decal on the driver's side door pillar (1 bar = 100 kPa = 14.5 psi). If the inflation pressure is too high, use the air release valve to release air.

⚠ WARNING

Check inflation pressure regularly.

Volvo recommends driving to the nearest authorized Volvo workshop to have the tire replaced/repared. Inform the workshop that the tire contains sealing compound.

The sealing compound bottle and the hose must be replaced after use. Volvo recommends contacting an authorized Volvo workshop for replacement.





⚠ WARNING

After using the tire sealing system, the vehicle should not be driven farther than approximately 200 km (120 miles).

i NOTE

The compressor is an electric device. Follow local regulations for disposal.

Related information

- Recommended tire pressure (p. 545)
- Tire sealing system (p. 557)
- Inflate tires with the compressor included in the tire sealing system (p. 562)
- Contacting Volvo (p. 26)

Inflate tires with the compressor included in the tire sealing system

The vehicle's original tires can be inflated using the compressor in the tire sealing system.

1. The compressor must be switched off. Make sure that the switch is in the **O** (Off) position and take out the electrical cable and the hose.

Be sure the air release valve on the compressor's hose is completely closed.
2. Unscrew the tire's valve cap and screw the hose's valve connector as far as possible onto the valve.
3. Connect the electrical cable to the nearest 12 V outlet and start the vehicle.

⚠ WARNING

Inhaling exhaust fumes could lead to serious injury. Never leave the engine running in an enclosed space or a space without sufficient ventilation.

⚠ WARNING

Never leave children unattended in the vehicle while the engine is running.

4. Start the compressor by moving the switch to the **I** (On) position.

! CAUTION

Risk of overheating. The compressor should not be running for longer than 10 minutes at a time.

5. Inflate the tire to the pressure specified on the tire pressure decal on the driver's side door pillar. If the inflation pressure is too high, use the air release valve to release air.
6. Switch off the compressor. Remove the hose and the electrical cable.
7. Screw the valve cap back onto the tire.

i NOTE

- After inflating a tire, always replace the valve cap to help prevent valve damage caused by gravel, dirt, etc.
- Use plastic valve caps only. Metal caps could corrode and become difficult to remove.

i NOTE

The compressor is an electric device. Follow local regulations for disposal.

Related information

- Recommended tire pressure (p. 545)
- Using the tire sealing system (p. 558)
- Tire sealing system (p. 557)

Determining the vehicle's permitted weight

Properly loading your vehicle will provide maximum return of vehicle design performance.

Weight designations

Before loading your vehicle, familiarize yourself with the following terms for determining your vehicle's weight ratings, with or without a trailer, from the vehicle's Federal/Canadian Motor Vehicle Safety Standards (FMVSS/CMVSS) label, and the vehicle's tire information placard:

Curb weight

The weight of the vehicle including a full tank of fuel and all standard equipment. It does not include passengers, cargo, or optional equipment.

Capacity weight

All weight added to the curb weight, including cargo and optional equipment. When towing, towbar weight is also part of cargo weight.

Permissible axle weight

The maximum allowable weight that can be carried by a single axle (front or rear). These numbers are shown on the Federal/Canadian Motor Vehicle Safety Standards (FMVSS/CMVSS) label. The total load on each axle must never exceed its maximum permissible weight.

Gross vehicle weight (GVW)

The vehicle's curb weight + cargo + passengers.

Steps for Determining Correct Load Limit

1. Locate the statement "the combined weight of occupants and cargo should never exceed XXX kg or XXX lbs." on your vehicle's placard.
2. Determine the combined weight of the driver and passengers that will be riding in your vehicle.
3. Subtract the combined weight of the driver and passengers from XXX kg or XXX lbs.
4. The resulting figure equals the available amount of cargo and luggage load capacity. For example, if the "XXX" amount equals 1400 lbs. and there will be five 150 lb. passengers in your vehicle, the amount of available cargo and luggage load capacity is 650 lbs. (1400 - 750 (5 × 150) = 650 lbs.)
5. Determine the combined weight of luggage and cargo being loaded on the vehicle. That weight may not safely exceed the available cargo and luggage load capacity calculated in Step 4.



WHEELS AND TIRES

- 6. If your vehicle will be towing a trailer, load from your trailer will be transferred to your vehicle. Consult this manual to determine how this reduces the available cargo and luggage load capacity of your vehicle.

WARNING

- Exceeding the permissible axle weight, gross vehicle weight, or any other weight rating limits can cause tire overheating resulting in permanent deformation or catastrophic failure.
- Do not use replacement tires with lower load carrying capacities than the tires that were original equipment on the vehicle because this will lower the vehicle's GVW rating. Use only tires with the correct load carrying capacity. Consult your Volvo retailer for information.

Related information

- Loading recommendations (p. 571)

LOADING, STORAGE AND PASSENGER
COMPARTMENT

Passenger compartment interior

Overview of the passenger compartment interior and storage spaces.

Front seats

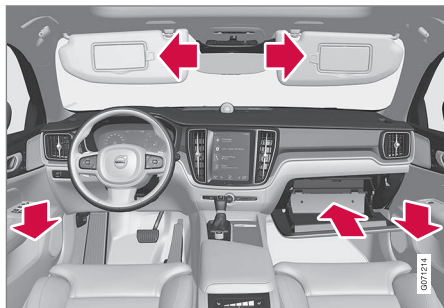

Storage compartment in door panel, glove compartment and sun visors.

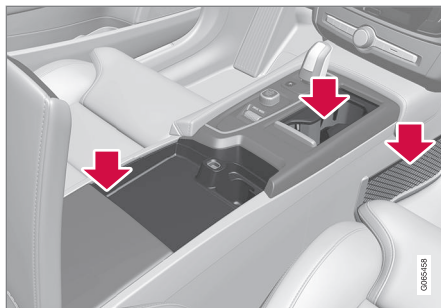

Storage compartments with cup holders, electrical outlets, net pocket* and USB ports in the tunnel console.

Rear seat

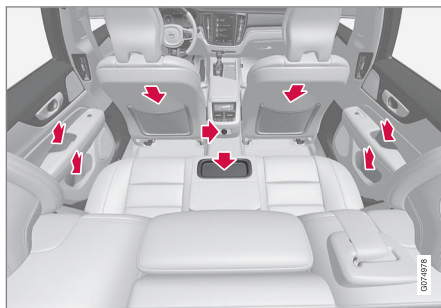

Storage compartment in the door panel, cup holders* in the center seat's backrest, storage pocket* in the front seat's backrest and USB ports in the tunnel console.

WARNING

Store loose objects, such as cell phone, camera, remote control for extra equipment, etc., in the glove compartment or another compartment. Otherwise, these could injure people in the vehicle in the event of hard braking or a collision.

CAUTION

Keep in mind that glossy surfaces can be easily scratched by e.g. metal objects. Do not place keys, phones or similar items on sensitive surfaces.

Related information

- Electrical outlets (p. 567)
- Using the glove compartment (p. 569)
- Sun visors (p. 570)
- Tunnel console (p. 567)
- Connecting a device via the USB port (p. 498)

Tunnel console

The tunnel console is located between the front seats.

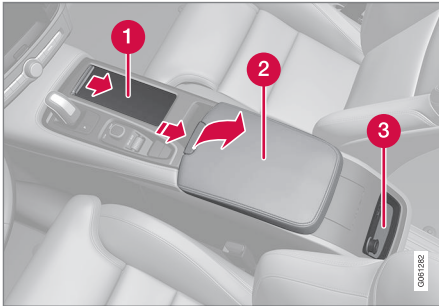

- ❶ Storage compartment with cup holder.
- ❷ Storage compartment with 12 V outlet and USB port under the armrest.
- ❸ Climate control panel for the rear seats* or storage compartment. There is also a USB port underneath.

⚠ WARNING

Store loose objects, such as cell phone, camera, remote control for extra equipment, etc., in the glove compartment or another compartment. Otherwise, these could injure people in the vehicle in the event of hard braking or a collision.

⚠ CAUTION

Keep in mind that glossy surfaces can be easily scratched by e.g. metal objects. Do not place keys, phones or similar items on sensitive surfaces.

i NOTE

One of the sensors for the alarm* is located under the cup holder in the center console. Avoid placing coins, keys and other metal objects in the cup holder as this could trigger the alarm.

i NOTE

The USB port can be used to e.g. charge a cellular phone or tablet. Only the front USB port can be used to play media through the vehicle's speakers.

Related information

- Passenger compartment interior (p. 566)
- Electrical outlets (p. 567)
- Climate system controls (p. 210)

Electrical outlets

There is a 12 V electrical outlet in the tunnel console and a 12 V electrical outlet* in the trunk/cargo compartment.

If a problem occurs with an electrical socket, contact a workshop - an authorized Volvo workshop is recommended.

12 V outlets

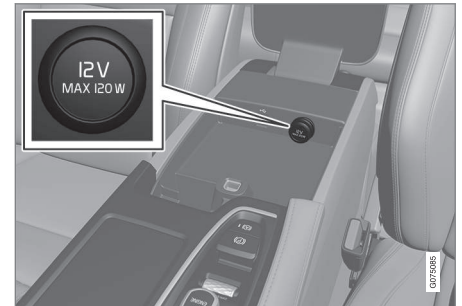

12 V outlet in the tunnel console, front seat.

The 12 V outlets can be used for devices intended for this such as MP3 players, coolers and cellular phones.



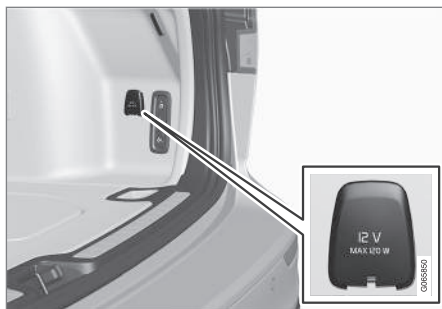

12 V outlet in trunk/cargo compartment*.

Related information

- Passenger compartment interior (p. 566)
- Using the electrical outlets (p. 568)

Using the electrical outlets

The 12 V outlet can be used for devices intended for this such as MP3 players, coolers and cellular phones.

The ignition must be in at least mode **I** for the outlets to supply current. The outlets will then be active as long as there is sufficient charge in the start battery.

If the engine is turned off and the vehicle is locked, the outlets will be deactivated. If the engine is turned off and the vehicle remains unlocked, the sockets will remain active for up to 7 minutes.

NOTE

Bear in mind that using the electrical outlets when the engine is off could cause the starter battery to have too low of a charge level, which could limit other functionality.

Accessories connected to the electrical outlets can be activated even when the vehicle electrical system is off or if preconditioning is used. For this reason, disconnect plugs when they are not in use to prevent the starter battery from becoming discharged.



WARNING

- Do not use accessories with large or heavy plugs – they could damage the outlet or come loose while you are driving.
- Do not use accessories that could cause disruptions to e.g. the vehicle's radio receiver or electrical system.
- Position the accessory so that there is no risk of it injuring the driver or passengers in the event of heavy braking or a collision.
- Pay attention to connected accessories as they can generate heat that could burn passengers or the interior.

Using 12 V outlets

1. Remove the stopper (tunnel console) or fold down the cover (trunk/cargo compartment) over the socket and plug in the device.
2. Unplug the device and put the stopper back in (tunnel console) or fold up the cover (trunk/cargo compartment) when the socket is not in use or left unattended.



CAUTION

The maximum power is 120 W (10 A) per outlet.

Related information

- Electrical outlets (p. 567)
- Passenger compartment interior (p. 566)

Using the glove compartment

The glove compartment is located on the passenger side. The glove compartment can be used to store the Owner's Manual, maps, etc. There is also room for a pen and a card holder.

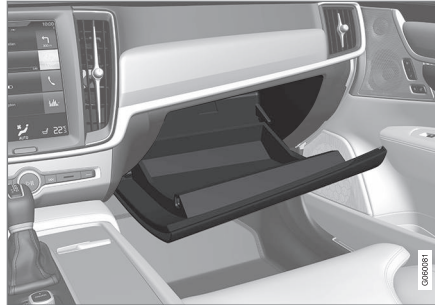
**Locking and unlocking the glove box***

The glove compartment can be locked when the vehicle is left at a workshop, hotel, etc. The glove compartment can then only be locked/unlocked with the glove compartment key.

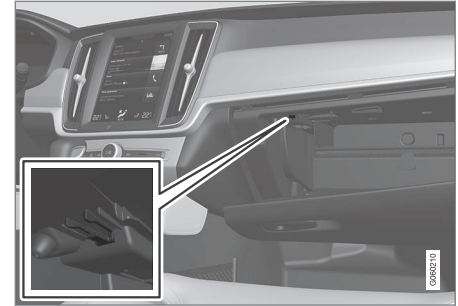

Storage compartment for the key. The illustration is generic – the design may vary.



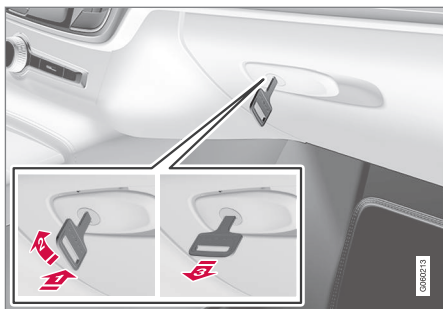

The illustration is generic – the design may vary.

To lock the glove compartment:

- 1 Insert the key into the lock on the glove compartment.
- 2 Turn the key 90 degrees clockwise.
- 3 Remove the key from the lock.

- To unlock, perform the above steps in reverse.

Related information

- Passenger compartment interior (p. 566)
- Private Locking (p. 262)

Sun visors

In the ceiling in front of the driver's and front passenger's seats, there are sun visors that can be lowered and angled to the side as necessary.



The illustration is generic – the design may vary.

The mirror lighting* comes on automatically when the visor is lifted up.

The mirror frame has a holder for e.g. cards or tickets.

Related information

- Passenger compartment interior (p. 566)

Cargo compartment

The vehicle has a flexible cargo compartment that makes it possible to carry and secure large objects.

The cargo capacity of the vehicle can be considerably increased by folding down the rear seat backrests. Use the load anchoring eyelets or grocery bag holders to help secure objects in place, and the retractable cargo compartment cover* to help conceal objects in the cargo compartment.

If the vehicle is equipped with a temporary spare tire, this is secured to the cargo compartment floor under the cover. The towing eyelet and tire sealing system are located under the cargo compartment floor.

Related information

- Loading recommendations (p. 571)
- Grocery bag holders (p. 572)
- Load anchoring eyelets (p. 573)
- Installing and removing the cargo compartment cover* (p. 574)

Loading recommendations

There are a number of things that are important to consider when carrying loads in or on the vehicle.

Load-carrying capacity is determined by the vehicle's curb weight. The total weight of all passengers and any installed accessories reduces the vehicle's load-carrying capacity by the corresponding amount.

WARNING

The vehicle's driving characteristics change depending on the weight and position of the load.

Loading the cargo compartment/trunk

Keep the following in mind when loading:

- Position objects so they are pressing against the rear seat backrests.
- Heavy objects should be positioned as low as possible. Avoid placing heavy objects on folded-down seat backrests.
- Cover sharp corners with a soft cloth or similar to help prevent damage to the upholstery.
- Use the load anchoring eyelets and tensioning straps or similar to secure all objects.

WARNING

In a head-on collision at a speed of 50 km/h (30 mph), an unsecured object weighing 20 kg (44 pounds) can reach a projectile weight equivalent to 1000 kg (2200 pounds).

WARNING

If objects are loaded higher than the upper edge of the side windows, leave a 10 cm (4 in.) space between the objects and the window. Objects placed closer to this could impede the function of the inflatable curtain concealed inside the headlining.

WARNING

Always secure the load. Otherwise, it may shift during heavy braking and injure people in the vehicle.

Cover sharp edges and sharp corners with something soft.

Turn off the engine and apply the parking brake when loading/unloading long objects. Otherwise, it is possible for the load to reach the gear lever or gear selector and move it to a drive position – which could cause the vehicle to begin rolling.

Extra cargo space

The rear seat backrests can be folded down to increase cargo space in the cargo compart-

ment/trunk and simplify loading. If the rear seat backrests are folded down, make sure that no objects loaded into the vehicle prevent the WHIPS system for the front seats from functioning correctly.

A ski hatch in the rear seat can be folded down to carry skis or other long, thin objects.

Related information

- Load anchoring eyelets (p. 573)
- Folding down the rear seat backrests (p. 192)
- Rear seat ski hatch (p. 574)
- Roof loads and load carriers (p. 572)
- Leveling control* and suspension (p. 440)
- Weights (p. 651)

Roof loads and load carriers

Volvo-developed load carriers are recommended for carrying loads on the roof of the vehicle.

Volvo load carriers are specially designed to help prevent damage to your vehicle and help ensure maximum safety while driving. Volvo load carriers are available from authorized Volvo retailers.

Carefully follow the installation instructions provided with the load carriers.

- Distribute the load evenly throughout the load carriers. Place heavier cargo at the bottom of the load.
- Check periodically to ensure that the load carriers and load are properly secured. Secure the load firmly using tie straps or similar.
- If the load is longer than the vehicle, such as a canoe or kayak, attach the towing eyelet in its front outlet and secure the tie straps in it.
- The vehicle's wind resistance and fuel consumption increase with the size of the load.
- Drive smoothly. Avoid rapid acceleration, hard braking and fast cornering.

WARNING

The vehicle's center of gravity and driving characteristics are altered by roof loads.

Follow the vehicle's specifications regarding weights and maximum permitted load.

Related information

- Loading recommendations (p. 571)
- Weights (p. 651)

Grocery bag holders

Grocery bag holders (hooks) help keep shopping bags in place and prevent them from falling over and spilling their contents in the cargo compartment.

On the sides of the cargo compartment

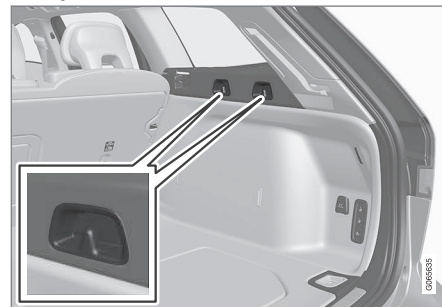

There are two grocery bag holders in the side panel on each side of the cargo compartment.

CAUTION

The grocery bag holders are only intended to hold weights up to 5 kg (11 lbs).

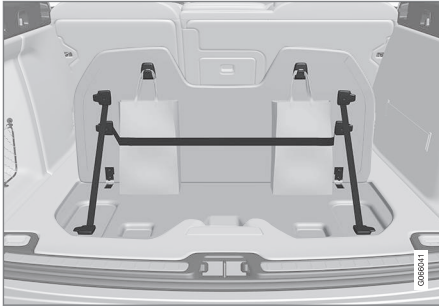
Under the floor hatch*

There are two grocery bag holders and an elastic band¹ in the hatch in the cargo compartment floor. The strap can be attached in four different positions.

Open the hatch to access the grocery bag holders. Use the provided elastic strap to secure shopping bags in a suitable position. Bags with handles of a suitable size can also be hung on the hooks.

Related information

- Loading recommendations (p. 571)
- Using the glove compartment (p. 569)
- Installing and removing the cargo net* (p. 578)

- Installing and removing the cargo compartment cover* (p. 574)
- Installing and removing the steel cargo grid* (p. 576)

¹ Additional elastic straps can be ordered from a Volvo retailer.

Load anchoring eyelets

The load anchoring eyelets in the cargo compartment can be used to secure objects with straps, a net, etc.

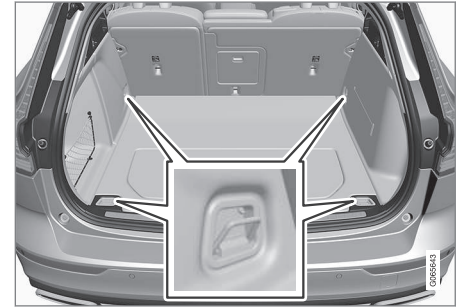
**⚠ WARNING**

Hard, sharp and/or heavy objects in or protruding from the vehicle can cause injury in the event of hard braking.

Always secure large and heavy objects with a seat belt or cargo retaining straps.

Related information

- Loading recommendations (p. 571)
- Weights (p. 651)

Rear seat ski hatch

The hatch in the rear seat backrest can be opened to transport long, narrow objects such as skis.



The illustration is generic - details may vary according to vehicle model.

1. In the cargo compartment, grasp the ski hatch handle and pull it down.
2. Fold down the armrest in the rear seat.

If the private locking function is used, the ski hatch must be closed.

Related information

- Loading recommendations (p. 571)
- Private Locking (p. 262)
- Load anchoring eyelets (p. 573)

Installing and removing the cargo compartment cover*

The cover can be rolled out to conceal objects in the cargo compartment.

Installing the cargo compartment cover



- 1 Press the end piece on one side of the cover into the retaining bracket in the side panel of the cargo compartment.
- 2 Then put the other end piece in the recess in the side panel on the opposite side.
- 3 Push the end piece down on both sides, one at a time.
 - > When a click is heard and the red marks on each end piece are no longer visible, the cover is in place. Check that it is secure.

Removing the cargo compartment cover

In retracted position:

1. Press the button on one of the cover's ends and lift out that end.
2. Carefully lift the cover up and out.
 - > The other end will release automatically and the cover can then be lifted out of the cargo compartment.

Related information

- Operating the cargo compartment cover* (p. 575)
- Loading recommendations (p. 571)

Operating the cargo compartment cover*

The cover can be used in two positions: fully open to completely cover the cargo compartment or partially retracted to make it easier to reach further into the cargo compartment.

Fully open

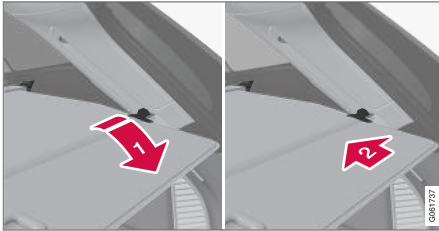

- 1 Grasp the handle and pull the cover out as far as possible.
- 2 Press the attachment pins in the recesses in the rear pillars of the cargo compartment.
 - > The cover will be secured in the fully open position.



Cover in the fully open position.

! **CAUTION**

Do not place objects on top of the cargo compartment cover.

Loading mode

From the fully opened position:

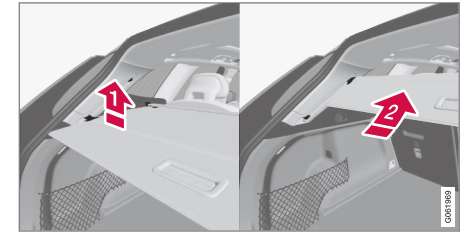

Press the handle section of the cargo compartment slightly upward.

- > The cover will move up until it stops in the partially retracted position.

Returning to the fully open position from the partially retracted position:

1. Grasp the handle and pull the cover down as far as possible. Angle the handle slightly upward so that the attaching pins can more easily move past the first set of grooves.
2. Release the handle so that the attaching pins engage into the grooves.
 - > The cover will be secured in the fully open position.





! CAUTION

When in the loading position, the cargo compartment cover can obstruct visibility to the rear. Make sure that the cargo compartment cover is fully extended or fully retracted during driving.

Retracting the cover

1. From the fully opened position:

Lift the cover's handle and pull it rearward to release the cover's attaching pins from the grooves. Let the cover retract.

From the partially retracted position:

Grasp the handle and pull the cover out of the grooves to the fully open position. Lift the handle and pull it rearward to release the cover's attaching pins from the grooves. Let the cover retract.

2. Let the cover retract with its attaching pins above the side panels until it stops in the fully retracted position.

Related information

- Installing and removing the cargo compartment cover* (p. 574)

Installing and removing the steel cargo grid*

The steel cargo grid prevents loads or pets in the cargo compartment from being thrown forward into the passenger compartment during hard braking.

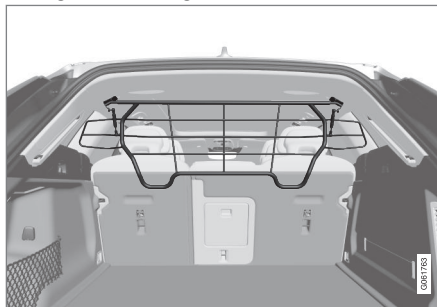

For safety reasons, the steel grid must always be installed and secured correctly.

! WARNING

Under no circumstances may a person be in the cargo compartment when the vehicle is moving. Heavy braking or a collision could lead to serious injury.

Installation

! CAUTION

The steel cargo grid may only be used in the rear position (behind the rear seat) described here.

Before installing the steel grid, the existing plastic ceiling mounting consoles must be replaced with steel consoles. Volvo recommends that the ceiling consoles are only replaced by an authorized Volvo workshop or retailer.

1. Fold down the rear seat backrests.
2. Make sure that the steel grid is facing the right direction. Lift the grid into the vehicle through one of the rear doors.

3.

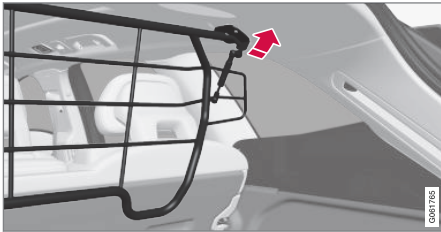

Position the grid's attachment points in the ceiling consoles.

The next step will be easier if two people hold the steel grid in the right position.

4.

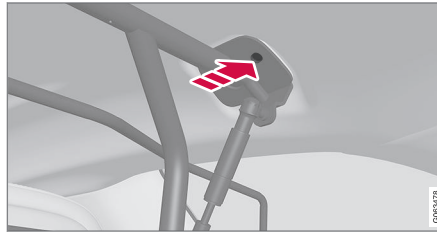

Screw the provided screw into place using the provided 6 mm Allen wrench. Repeat on the other side. Recommended torque: 20 Nm (15 ft-lb).

> Check to make sure the steel grid is securely in place.

5. Return the backrest to the upright position.

For more information on necessary tools and procedures for installing/removing, see the assembly instructions provided with the steel grid.



CAUTION

The steel cargo grid cannot be folded up or down when a cargo compartment cover is mounted.

Related information

- Loading recommendations (p. 571)
- Load anchoring eyelets (p. 573)

Installing and removing the cargo net*

The cargo net helps prevent objects in the cargo compartment from entering the passenger compartment in the event of a sudden stop or hard braking.

The cargo net is attached at four points.

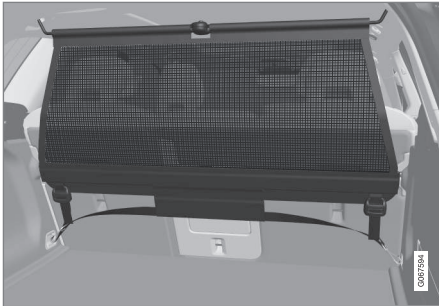

For safety reasons, the cargo net must always be mounted and secured according to the following description.

The net is made of strong nylon weave and can be attached in two different locations in the vehicle:

- Rear mounting - behind the rear seats.
- Front mounting - behind the front seats.

WARNING

Objects in the cargo compartment must always be securely anchored, even with a correctly installed cargo net.

Installing the cargo net

WARNING

All of the cargo net's upper consoles, hooks and straps must be securely mounted and attached before the net is used.

Never use the net if it is damaged.

NOTE

With front mounting, the cargo net is most easily installed via a rear door.

1. Fold out the cargo net and make sure that the upper rod folds out and locks into position.
2. Insert one of the net's hooks into the front or rear ceiling mounting point with the strap lock facing you.

3. Insert the net's other upper hook into the ceiling mounting point on the opposite side.

The telescopic spring-loaded hooks make mounting easier.

Make sure that the net's hooks are pushed forward as far as possible into their respective mounting points.

4.

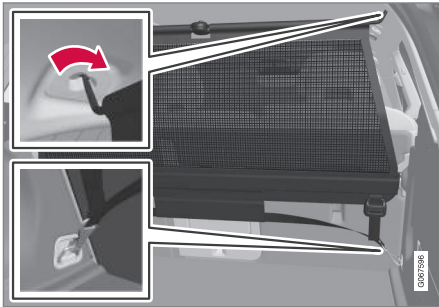

Rear mounting.

For rear mounting:

With the cargo net hooked into the rear ceiling mounting points, attach the net's straps into the front cargo anchoring eyelets in the cargo compartment.

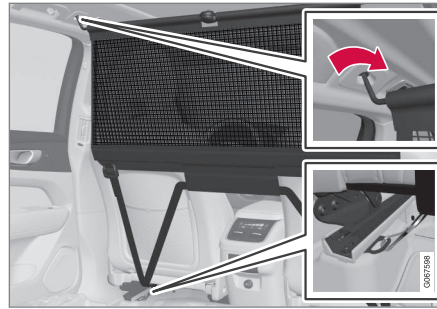

Front mounting.

For front mounting:

With the cargo net mounted in the front ceiling mounting points, hook the straps into the outer eyelets on the front seat rails behind the seats. Attaching the net is easier if the seat backrests are upright and the seats are moved slightly forward.

Move the seat or backrest only until it touches the net. Moving it with too much force or applying too much pressure to the net could lead to damage.

! **CAUTION**

If a seat or backrest is pressed with too much force back against the cargo net, the net and its ceiling brackets could be damaged.

5. Pull the straps until the cargo net is taut.

Removing the cargo net

The cargo net can be easily removed and folded up.

1. Loosen the cargo net by pressing the button on the strap locks on each side and pulling to allow some slack.
2. Press in the catches and release both of the strap hooks.
3. Unhook the upper hooks and remove the net from the ceiling mounting points.
4. Press the red button on the rod so that it can be folded. Fold and roll up the net. Store the net in its case.

Related information

- Loading recommendations (p. 571)
- Load anchoring eyelets (p. 573)

MAINTENANCE AND SERVICE

Volvo's service program

To keep the vehicle as safe and reliable as possible, follow the Volvo service schedule specified in the Warranty and Maintenance Records Information booklet.

WARNING

California Proposition 65

Operating, servicing and maintaining a passenger vehicle can expose you to chemicals including engine exhaust, carbon monoxide, phthalates, and lead, which are known to the State of California to cause cancer and birth defects or other reproductive harm. To minimize exposure, avoid breathing exhaust, do not idle the engine except as necessary, service your vehicle in a well ventilated area and wear gloves or wash your hands frequently when servicing your vehicle. For more information go to www.P65Warnings.ca.gov/passenger-vehicle.

Volvo recommends having an authorized Volvo workshop perform service and maintenance. Volvo workshops have the staff, service literature and special tools that can provide the highest quality of service.

CAUTION

To ensure the Volvo warranty is not invalidated, check and follow the Warranty and Service Records Information booklet.

Service and repairs

Service the vehicle regularly. Follow Volvo's recommended service intervals.

Detailed inspection and repairs may only be performed by an authorized workshop.

WARNING

Do not make any repairs on this vehicle yourself. Electrical cables and/or components that have come loose may only be corrected by an authorized workshop – an authorized Volvo workshop is recommended.

Introduction

The maintenance services contain several checks that require special instruments and tools and therefore must be performed by a qualified technician. To keep your Volvo in top condition, specify time-tested and proven Genuine Volvo Parts and Accessories.

The Federal Clean Air Act - U.S.

The Federal Clean Air Act requires vehicle manufacturers to furnish written instructions to the ultimate purchaser to assure the proper servicing and function of the components that control emissions. These services, which are listed in the "Warranty and Service Records Information" booklet, are not covered by the warranty. You will be required to pay for labor and material used.

Maintenance

Your Volvo passed several major inspections before it was delivered to you, in accordance with Volvo specifications. The maintenance procedures outlined in the Warranty and Service Records Information booklet, many of which will positively affect your vehicle's emissions, should be performed as indicated. It is recommended that receipts for vehicle emission maintenance be retained in case questions arise concerning maintenance. Inspection and maintenance should also be performed anytime a malfunction is observed or suspected.

Applicable warranties - U.S./Canada

In accordance with applicable U.S. and Canadian regulations, the following list of warranties is provided.

- New Vehicle Limited Warranty
- Parts and Accessories Limited Warranty
- Corrosion Protection Limited Warranty
- Seat Belt and Supplemental Restraint Systems Limited Warranty
- Emission Design and Defect Warranty
- Emission Performance Warranty

These are federal warranties; other warranties are provided as required by state/provincial law. Refer to your separate Warranty and Service Records Information booklet for detailed information concerning each of the warranties.

Periodic maintenance helps minimize emissions

 NOTE
<ul style="list-style-type: none"> • Refer to your Service and Warranty Booklet for a comprehensive service and maintenance schedule up to 240,000 km (150,000 miles). This program contains inspections and services necessary for the proper function of your vehicle and includes components that affect vehicle emissions. • The Warranty and Service Records Information booklet also contains detailed information concerning the warranties that apply to your vehicle.

On-board Diagnostic System

OBD II is part of your vehicle's computerized engine management system. It stores diagnostic information about your vehicle's emission controls. It can light the Check Engine light (MIL) if it detects an emission control "fault." A "fault" is a component or system that is not performing within an expected range. A fault may be permanent or temporary. OBD II will store a message about any fault.

Emission inspection readiness

How do states use OBD II for emission inspections?

Many states connect a computer directly to a vehicle's OBD II system. The inspector can then read "faults." In some states, this type of inspection has replaced the tailpipe emission test.

How can my vehicle fail OBD II emission inspection?

Your vehicle can fail OBD II emission inspection for any of the following reasons:

- If your Check Engine (MIL) light is lit, your vehicle may fail inspection.
- If your vehicle's Check Engine light was lit, but went out without any action on your part, OBD II will still have a recorded fault. Your vehicle may pass or fail, depending on the inspection practices in your area.
- If you had recent service that required disconnecting the battery, OBD II diagnostic information may be incomplete and "not ready" for inspection. A vehicle that is not ready may fail inspection.



◀◀ **How can I prepare for my next OBD II emission inspection?**

- If your Check Engine (MIL) light is lit or was lit but went out without service, have your vehicle diagnosed and, if necessary, serviced by a qualified Volvo technician.
- If you recently had service for a lit Check Engine light, or if you had service that required disconnecting the battery, a period of driving is necessary to bring the OBD II system to "ready" for inspection. Two half-hour trips of mixed stop-and-go/highway driving are typically needed to allow OBD II to reach readiness. Your Volvo retailer can provide you with more information on planning a trip.
- Maintain your vehicle in accordance with your vehicle's maintenance schedule.

Owner maintenance

Periodic maintenance requirements and intervals are described in your vehicle's Warranty and Service Records Information booklet.

The following points can be carried out between the normally scheduled maintenance services.

Each time the vehicle is refueled:

- Check the engine oil level.
- Clean the windshield, windshield wipers, headlights, and taillights.

Monthly:

- Check cold tire pressure in all tires. Inspect the tires for wear.
- Check that engine coolant and other fluid levels are between the indicated "min" and "max" markings.
- Clean interior glass surfaces with a glass cleaner and soft paper towels.
- Wipe driver information displays with a soft cloth.
- Visually inspect battery terminals for corrosion. Corrosion may indicate a loose terminal connector, or a battery near the end of its useful service life. Consult your Volvo retailer for additional information.

As needed:

Wash the vehicle, including the undercarriage, to reduce wear that can be caused by a buildup of dirt, and corrosion that can be caused by salt residues.

Clean leaves and twigs from air intake vents at the base of the windshield, and from other places where they may collect.

NOTE

Complete service information for qualified technicians is available online for purchase or subscription at www.volvotechinfo.com.

Related information

- Vehicle status (p. 587)
- Scheduling service and repairs (p. 587)
- Connecting equipment to the vehicle's data link connector (p. 37)
- Technician certification (p. 38)
- Climate control system service (p. 593)
- Maintenance of the brake system (p. 420)
- Engine compartment overview (p. 595)

Data transfer between vehicle and workshop over Wi-Fi

Volvo workshops have a designated Wi-Fi network for data transfer between your vehicle and the workshop. Your visit to the workshop will be easier and more effective when diagnostics information and software can be transferred over the workshop's network. At the workshop, your service technician can connect your vehicle to the workshop's Wi-Fi network to perform troubleshooting and download software. For this type of communication, the vehicle only connects to a workshop's network. It is not possible to connect the vehicle to another Wi-Fi network (e.g. your home network) in the same way as to a workshop's network.

Connecting with remote key

Connection is usually managed by the service technician, who will use the remote key buttons. It is therefore important to bring a key with buttons with you when you visit the workshop. Pressing the lock button on the remote key three times will connect the vehicle to the workshop's Wi-Fi network.

When the car is connected to a Wi-Fi network, the  symbol appears in the center display.

WARNING

The vehicle may not be driven when it is connected to the workshop's networks and systems.

Related information

- Handling system updates via Download Center (p. 586)
- Scheduling service and repairs (p. 587)

Download Center

With the vehicle connected to the Internet¹, updates for a number of the vehicle's systems can be downloaded from the center display.

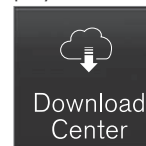

The **Download Center** app is started from the center display and makes it possible to:

- search for and update system software
- update Sensus Navigation* map data
- download, update and delete apps.

Related information

- Handling system updates via Download Center (p. 586)
- Download apps (p. 473)
- Updating apps (p. 473)
- Deleting apps (p. 474)
- Internet-connected vehicle* (p. 516)
- Navigating in the center display's views (p. 113)

¹ There may be a charge for transmitting data over the Internet, depending on your service plan.

Handling system updates via Download Center

Functions for Internet-connected vehicles and infotainment can be updated via Download Center. Updates can be done one at a time or all at the same time.

Searching for update

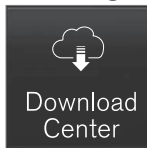

If an update is available, the message **New software updates available** See **Download Center** will be displayed in the center display's status field.

In order for system updates to be possible, the vehicle must have an Internet connection².

- Go to **Download Center** in the center display's App view.
 - > If no search has been performed since the last time the infotainment system was started, a search will be initiated. No search will begin if a software download is in progress.

A number in **System updates** shows how many updates are available. Tap to display a list of updates that can be installed in the vehicle.

i NOTE

Data downloading can affect other services such as transfer data, e.g. web radio. If the affect on other services is experienced as problematic, the download can be interrupted. Alternatively, it may be appropriate to switch off or cancel other services.

i NOTE

An update can be interrupted when the ignition is switched off and the vehicle is left.

However, the update does not have to be completed before the vehicle is left as the update is resumed the next time the vehicle is used.

Updating all system software

- Select **Install all** at the bottom of the list.

To avoid displaying a list, select **Install all** via **System updates**.

Updating individual system software

- Select **Install** to choose the software you would like to download.

Canceling software download

- Tap the checkbox in the activity indicator that replaced **Install** when the download began.

Note that only a download can be cancelled. An installation cannot be cancelled once it has begun.

Deactivating the background search for software update

Automatic searching for software updates is activated as the default factory setting, but the function can be deactivated.

1. Tap **Settings** in the center display's Top view.
2. Tap **System** → **Download Center**.
3. Tap to deselect **Auto Software Update**.

Related information

- Download Center (p. 585)
- Internet-connected vehicle* (p. 516)
- Navigating in the center display's views (p. 113)

² There may be a charge for transmitting data over the Internet, depending on your service plan.

Vehicle status

The general status of the vehicle can be viewed in the center display.



The **Car Status** app is started from the center display's App view and has four tabs:

- **Messages** - status messages
- **Status** – checking engine oil level and AdBlue level³
- **TPMS** - tire inflation pressure check
- **Appointments** - appointment information and vehicle information⁴

Related information

- Handling messages saved from the instrument panel (p. 106)
- Checking and filling engine oil (p. 597)
- Tire pressure monitoring system* (p. 545)
- Scheduling service and repairs (p. 587)
- Sending vehicle information to the workshop (p. 588)
- Navigating in the center display's views (p. 113)

³ AdBlue Diesel models only.

⁴ Certain markets only.

⁵ Certain markets only.

⁶ There may be a charge for transmitting data over the Internet, depending on your service plan.

Scheduling service and repairs⁵

This service offers a way to send a booking request for service and workshop appointments directly from the vehicle.

When it is time for service, and in certain cases if the vehicle requires repairs, a message will be displayed in the instrument panel and at the top of the center display. The time for service is determined by how much time has elapsed, the number of hours the engine has run, or the distance driven since the last service.

To use the service

- Create a Volvo ID and register it to the vehicle.
- To send and receive appointment information, the vehicle must be connected to the Internet⁶.

Book service

Book a service request when desired or when a message is displayed indicating that service or repairs are needed.

1. Open the **Car Status** app from App view in the center display.
2. Tap **Appointments**.

3. Tap **Request appointment**.
4. Check that your **Volvo ID** is correct.
5. Make sure your preferred **Workshop information** is correct.
6. In the **Tap to write information to the workshop** field, you can provide details on what you would like performed during the visit or other important information to your workshop.
7. Tap **Send appointment request**.
 - > You will receive an appointment suggestion by email within a couple of days⁷.

On some markets, the message in the instrument panel indicating that the vehicle requires service will go out once the appointment request has been sent.
8. Tap **Cancel request** if you would like to cancel your request.

The appointment request contains information about your vehicle that helps the workshop plan for your visit.

The retailer will send you a digital appointment suggestion. You also have information about



- ◀ your retailer available in the vehicle so that you can contact your workshop.

Accepting an appointment suggestion

When the vehicle has received an appointment suggestion, a message will be displayed at the top of the center display.

1. Tap the message.
2. To accept the suggested appointment, tap **Accept**. Otherwise, tap **Send new proposal** or **Decline**.

For some markets, the system reminds you when an appointment time is approaching and the navigation system⁸ can also guide you to the workshop at the appointed time.

NOTE

If you experience any problems with this service, contact your Volvo retailer.

Related information

- Vehicle status (p. 587)
- Sending vehicle information to the workshop (p. 588)
- Navigating in the center display's views (p. 113)
- Volvo ID (p. 26)

- Internet-connected vehicle* (p. 516)

Sending vehicle information to the workshop⁹

Vehicle-related information can be sent at any time from the vehicle, e.g. if you schedule a visit to a workshop and would like to assist your workshop by providing additional basic information. Sending vehicle information is not the same as scheduling service.

1. Open the **Car Status** app from App view in the center display.
2. Tap **Appointments**.
3. Tap **Send vehicle data**.
 - > A message confirming that vehicle-related information has been sent will appear at the top of the center display. You can cancel data transmission by tapping the checkbox in the activity indicator.

Information is sent via the vehicle's Internet connection¹⁰.

Vehicle information can be accessed by any retailer if they are provided with your vehicle identification number (VIN¹¹).

Vehicle information contents

The most recently saved vehicle-related information will be sent (the last time the vehicle

⁷ Timespan may vary depending on market.

⁸ For vehicles with Sensus Navigation*.

was turned on). This includes information regarding:

- service requirements
- time since last service was performed
- function status
- fluid levels
- mileage (odometer reading)
- Vehicle Identification Number (VIN¹¹)
- software version
- diagnostic information.

Related information

- Scheduling service and repairs (p. 587)
- Vehicle status (p. 587)
- Navigating in the center display's views (p. 113)
- Internet-connected vehicle* (p. 516)

⁹ Certain markets only.

¹⁰ There may be a charge for transmitting data over the Internet, depending on your service plan.

¹¹ Vehicle Identification Number.

Hoisting the vehicle

When hoisting the vehicle, it is important that the jack is positioned on the designated points under the vehicle.

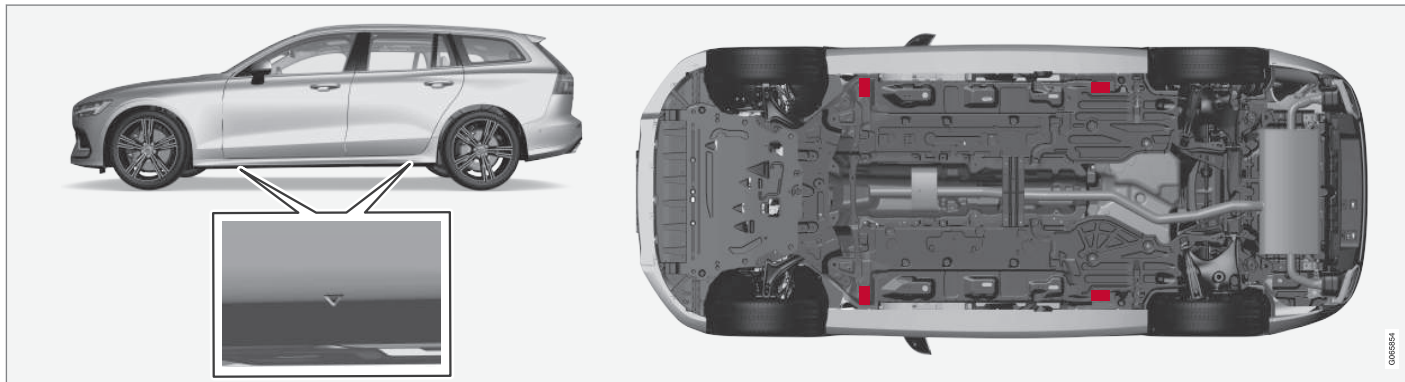

The triangles in the plastic covering indicate where the jack attachment points/lifting points (red areas) are located.

i NOTE

For vehicles with **Leveling Control***: If the vehicle is equipped with pneumatic suspension, this feature must be turned off before the vehicle is lifted onto a tow truck.

i NOTE

Volvo recommends only using the jack intended for your specific vehicle model. If a jack other than that recommended by Volvo is used, follow the instructions included with the equipment.

The vehicle's ordinary jack is only intended to be used in temporary situations for short periods of time, such as when changing wheels in the event of a flat tire. If the vehicle needs to be lifted more frequently, or for a longer period of time than for a wheel change, a garage jack or hoist is recommended. Always follow the instructions for use provided with the equipment.

⚠ WARNING

- Apply the parking brake and put the gear selector in the Park (**P**) position.
- Block the wheels standing on the ground, use rigid wooden blocks or large stones.
- Check that the jack is not damaged, the threads are properly lubricated and it is free from dirt.
- Be sure the jack is on a firm, level, non-slippery surface and that it is upright and not leaning.
- The jack must correctly engage in the jack attachment.
- No objects should be placed between the base of the jack and the ground, or between the jack and the attachment bar on the vehicle.
- Never let anyone remain in the vehicle when it is raised on a jack.
- If a tire must be changed near passing traffic, make sure all passengers move to a safe location.
- Use a jack intended for the vehicle when changing a tire. For any other job, use stands to support the vehicle.

- Never crawl under or allow any part of your body to be extended under a vehicle supported by a jack.

⚠ WARNING

If the vehicle is lifted on a garage jack, the jack must be placed under one of the four lifting points. Make sure that the vehicle is correctly positioned on the jack and that it cannot slide off. Make sure the jack plate has a rubber pad to help keep the vehicle stable and prevent damage. Always use axle stands or similar.

When not in use, the jack* should be kept in its storage compartment under the cargo compartment floor.

Read through all instructions before starting. Before raising the vehicle using a jack or lift, take out all the tools you will need.

1. Turn on the vehicle's hazard warning flashers if e.g. a wheel change must be performed in an area with traffic.
2. Apply the parking brake and put the gear selector in **P**, or first gear if the vehicle has a manual transmission.

If the vehicle is equipped with **Leveling Control***, this feature must be turned off before the vehicle is lifted onto a tow truck.

3. Place chocks in front of and behind the wheels that are still on the ground. For example, use heavy wooden blocks or large stones.
4. Position the jack or garage lift arms at the designated points under the vehicle. The triangle markings on the plastic cover indicate where the jack attachment points/lifting points are located. There are two jack attachment points on each side of the vehicle. There is a groove for the jack at each attachment point.

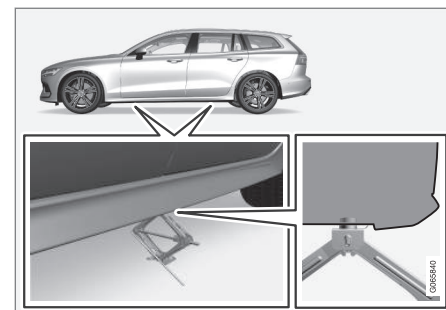

5. Position the jack under the attachment point being used, ensuring that the surface is firm, flat and not slippery.



MAINTENANCE AND SERVICE

- ◀◀ 6. Crank it up until it is properly aligned and it is in contact with the vehicle's jack attachment point. Make sure the top of the jack (or the garage lift arms) is correctly positioned in the attachment point, with the bump on the top of the jack in the recess in the attachment point and its base positioned vertically under the attachment point.
7. Turn the jack so that the crank is as far as possible from the side of the vehicle, which will position the jack's arms perpendicular to the vehicle's direction of movement.
8. Raise the vehicle to a suitable height for the operation to be performed.

Related information

- Jack* (p. 553)
- Wheel bolts (p. 553)
- Tool kit (p. 552)

Climate control system service

Service and repairs on the air conditioning system should only be done by an authorized workshop.

Troubleshooting and repairs

The air conditioning system contains a fluorescent tracer substance. Ultraviolet light is used to search for leaks in the system.

Volvo recommends contacting an authorized Volvo workshop.

The climate system in the vehicle uses a freon-free R1234yf refrigerant. For information regarding the refrigerant, refer to the decal located on the inside of the hood.

⚠ WARNING

The air conditioning system contains the refrigerant R1234yf under pressure. In accordance with SAE J2845 (Technician Training for Safe Service and Containment of Refrigerants Used in Mobile A/C System), service and repairs to the refrigerant system may only be performed by trained and certified technicians in order to ensure the safety of the system.

Related information

- Volvo's service program (p. 582)

Replacing a windshield with head-up display*

Vehicles with a head-up display have a special type of windshield that meets the requirements for displaying projected information.

Volvo recommends contacting an authorized Volvo workshop for assistance replacing the windshield. The correct type of replacement windshield must be used in order for the head-up display to function properly.

Related information

- Head-up display* (p. 140)
- Cleaning the head-up display* and instrument panel (p. 626)

Opening and closing the hood

To open the hood, pull the lever in the passenger compartment and then turn the handle under the hood.

Opening the hood

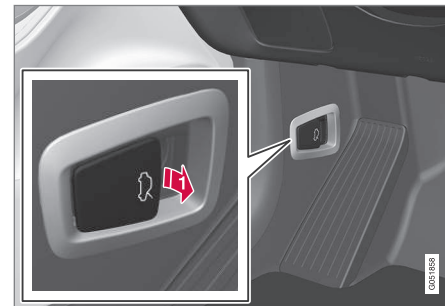

- f** Pull the handle to the left of the brake pedal to release the hood from its fully closed position.



- 2 Swipe your hand from left to right under the hood, grasp the handle and move it up and to the side to release the catch and lift the hood.

Warning - hood not closed



When the hood is released, a warning symbol and graphic will be displayed in the instrument panel and an audible signal will sound. If the vehicle begins to roll, the audible signal will be repeated several times.

i NOTE

If the warning symbol is illuminated or an audible warning signal sounds even though the hood is securely closed, consult a workshop - an authorized Volvo workshop is recommended.

Closing the hood

1. Press down the hood until it begins to close under its own weight.
2. When the hood reaches the catch at the handle in the front edge of the vehicle, press down on the hood to close it completely.

⚠ WARNING

Risk of injury! When closing, make sure that the hood is completely unobstructed and that no one can be injured.

⚠ WARNING

Make sure the hood locks securely after closing. It must audibly lock on both sides.



Hood not completely closed.



Hood completely closed.

⚠ WARNING



Never drive with the hood open!

If this symbol appears, or anything else indicates that the hood is not completely closed while driving, stop immediately and close it properly.

Related information

- Engine compartment overview (p. 595)
- Door and seat belt reminders (p. 54)

Engine compartment overview

This overview shows some service-related components. Some of the components included in the vehicle's electric drive system are located in the engine compartment. Exercise caution when accessing the engine compartment and only touch what is required for normal maintenance.

⚠ WARNING
Orange wiring may only be handled by qualified personnel.

⚠ WARNING
A number of electrical components in Twin Engine Plug-in Hybrid vehicles use high-voltage current and can be extremely dangerous if handled incorrectly.

- Do not touch anything that is not clearly described in this Owner's Manual.
- Be careful when checking/filling fluids in the engine compartment.

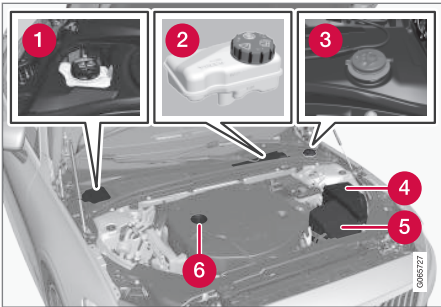

The layout of the engine compartment may vary depending on model and engine variant.

- 1 Coolant expansion tank
- 2 Brake fluid reservoir (located on the driver's side)
- 3 Washer fluid filler pipe
- 4 Fusebox
- 5 Air filter
- 6 Engine oil filler pipe

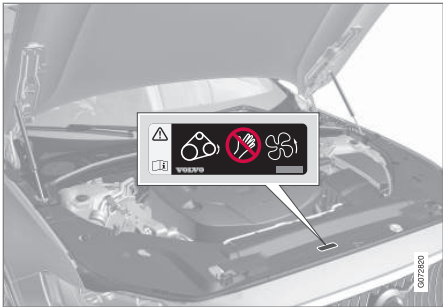

Location of warning decal for the engine compartment. The layout of the engine compartment may vary depending on model and engine variant.

i NOTE
The decals shown in the Owner's Manual do not claim to be exact reproductions of those found in the vehicle. The purpose is to show approximately how they look and about where they are located on the vehicle. The information that applies for your vehicle in particular is found on the decal on the vehicle.



⚠ WARNING

Bear in mind that the cooling fan (located at the front of the engine compartment behind the radiator) may start or continue running automatically up to about 6 minutes after the engine is turned off.

Always entrust engine washing to a workshop – an authorized Volvo workshop is recommended. If the engine is hot, there is a risk of fire.

⚠ WARNING

The ignition system works with extremely high and dangerous voltages. The vehicle electrical system should always be in ignition mode **0** when work is being performed in the engine compartment.

Do not touch any spark plugs or ignition coils when the vehicle electrical system is in ignition mode **II** or when the engine is warm.

Related information

- Opening and closing the hood (p. 593)
- Filling washer fluid (p. 643)
- Refilling coolant (p. 599)
- Fuses in the engine compartment (p. 606)
- Checking and filling engine oil (p. 597)
- Ignition modes (p. 415)

Engine oil

For the recommended service intervals and warranties to be applied, an approved engine oil must be used.

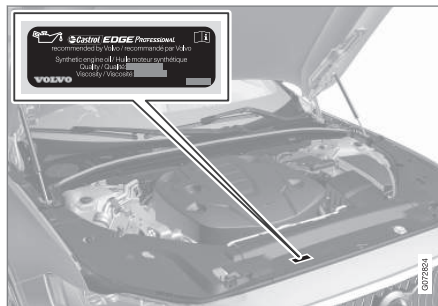

Location of warning decal for the engine compartment. The layout of the engine compartment may vary depending on model and engine variant.

Volvo recommends:



If the engine oil is not checked regularly and the level becomes low, this could cause serious engine damage.

i NOTE

The decals shown in the Owner's Manual do not claim to be exact reproductions of those found in the vehicle. The purpose is to show approximately how they look and about where they are located on the vehicle. The information that applies for your vehicle in particular is found on the decal on the vehicle.

CAUTION



To satisfy the requirements for the engine's service intervals, all engines are factory-filled with a specially adapted synthetic engine oil. Great care has been put into the choice of oil, with consideration given to service life, startability, fuel consumption and environmental impact.

For the recommended service intervals to apply, an approved engine oil must be used. Only use the prescribed oil grade to top off or change the oil. Otherwise, there is a risk of the vehicle's service life, startability, fuel consumption and environmental impact being affected.

Failure to use engine oil of the prescribed grade and viscosity could cause damage to engine-related components. Volvo disclaims warranty liability for such type of damage.

Volvo recommends entrusting oil changes to an authorized Volvo workshop.

Symbols for low oil level

Volvo uses different systems to warn if the oil level is too low/high or the oil pressure is low. For oil pressure sensors, a warning symbol is displayed in the instrument panel when oil pressure is low . For oil level sensors, the  warning symbol in the instrument panel

and display messages are used to alert the driver. Some engine variants have both systems. Contact a Volvo retailer for more information.

Change the engine oil and oil filter according to the schedule specified in the Warranty and Maintenance Records Information booklet. Oils of a higher grade than that specified may be used. If the vehicle is driven in adverse conditions, Volvo recommends using an oil with a higher grade than that specified.

Related information

- Checking and filling engine oil (p. 597)
- Engine oil specifications (p. 654)
- Volvo Cars support site (p. 21)

Checking and filling engine oil

The engine oil level is monitored by an electronic oil level sensor.

Viewing oil level in the center display

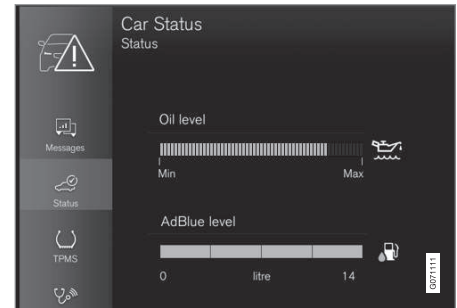

Example of the oil level graphic in the center display

The oil level can be viewed using the electronic oil level gauge in the center display once the vehicle has been started. The oil level should be checked regularly.

1. Open the **Car Status** app from App view in the center display.
2. Tap **Status** to display the oil level.





i NOTE

The system cannot directly detect changes when the oil is filled or drained. The vehicle must have been driven approximately 30 km (20 miles) and have been stationary 5 minutes on a level surface and with the engine off before the correct oil level will be displayed.

i NOTE

If the conditions for measuring oil level are not properly fulfilled (time after engine shutdown, vehicle inclination, ambient temperature, etc.) the message **No value available** will be shown in the center display. This does **not** mean that anything is wrong in the vehicle systems.

! CAUTION



If this symbol is shown, the oil pressure may be too low. Stop the vehicle as soon as possible and have it towed to a workshop – an authorized Volvo workshop is recommended.

Filling engine oil

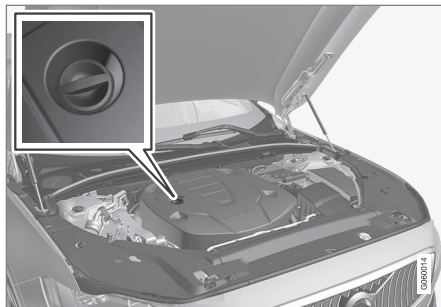

Filler pipe^{12, 13}

It may be necessary to top up engine oil between regularly scheduled services. No action is necessary with regard to engine oil level until a message appears in the instrument panel.

! WARNING

If the message **Engine oil level Service required** is displayed, drive to a workshop – an authorized Volvo workshop is recommended. The oil level may be too high.

! WARNING

Do not spill oil on the hot exhaust pipes as this could cause a fire.

! CAUTION

If the message **Engine oil level low Refill 1 liter** is displayed, fill only with the specified volume, e.g. 1 liter (1 quart).

Related information

- Engine oil (p. 596)
- Engine oil specifications (p. 654)
- Ignition modes (p. 415)
- Vehicle status (p. 587)
- Contacting Volvo (p. 26)

¹² Engines with an electronic oil level sensor do not have a dipstick.

¹³ The layout of the engine compartment may vary depending on model and engine variant.

Coolant

The coolant helps ensure that excess heat is distributed in the circuit in order to, for example, warm up the start battery or provide heating to the passenger compartment.

To avoid deterioration of the cooling system, engine trouble, etc., only approved Volvo coolant should be used.

Recommended grade: Volvo-approved pre-mixed coolant. If concentrated coolant is used, mix with 50% water of acceptable quality (i.e. not salt water, etc.). Consult a Volvo retailer if you have any questions.

To avoid deterioration of the cooling system, engine trouble, etc., only approved Volvo coolant should be used.

WARNING

Coolant is hazardous if ingested and could cause damage to organs (kidneys). The product contains ethylene glycol, inhibitor, water, etc.

Related information

- Refilling coolant (p. 599)

Refilling coolant

When refilling coolant, follow the instructions on the package. Never fill the cooling system with only water. The risk of freezing is increased with too low or too high amounts of coolant.

If there is coolant under the vehicle, smoke from the cooling system, or if more than 2 liters (about 2 quarts) of coolant has been added to the system, there could be something wrong with the cooling system and starting the vehicle could damage the engine. Call a tow truck and do not attempt to start the engine.

WARNING

The coolant may be very hot. Never unscrew the cap when the coolant is hot. If coolant must be filled, unscrew the expansion tank cap slowly to relieve overpressure.

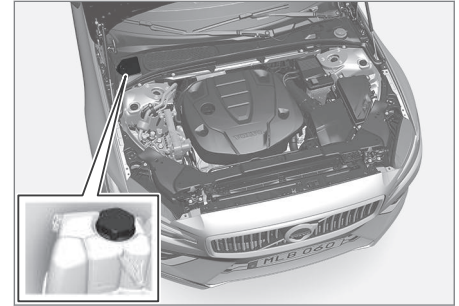

Coolant expansion tank

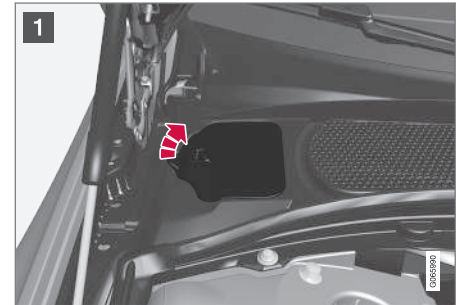



- 1 Open the cap in the plastic covering.
- 2 Unscrew the expansion tank cap and fill coolant as needed. The level should not exceed the yellow **MAX** mark inside the expansion tank.

Put the components back in place in the reverse order.

! **CAUTION**

- Do not ingest the contents. May cause damage to organs (kidneys).
- Use premixed coolant according to Volvo's recommendations. If concentrated coolant is used, make sure that the coolant mixture is 50% coolant and 50% water of acceptable quality.
- Do not mix different types of coolant.
- To help ensure sufficient corrosion protection in the system, only use new coolant when replacing larger components in the cooling system.
- Never run the engine unless the cooling system is properly filled. An improperly filled cooling system could lead to high temperatures and cracks in the cylinder heads.
- High levels of chlorine, chlorides and other salts may cause corrosion in the cooling system.

Related information

- Engine compartment overview (p. 595)
- Coolant (p. 599)

Starter battery

The starter battery is used to start the electrical system and power electrical equipment in the vehicle. The hybrid battery is used to start the combustion engine.

The vehicle has a single-pole electrical system that uses the chassis and engine mount as conductors.

The starter battery is a 12 V AGM (Absorbed Glass Mat) battery, dimensioned for regenerative charging and to support the function of the vehicle's various systems.

The service life and performance of the starter battery are affected by factors such as driving style, driving conditions, climate, battery discharges, number of starts, etc.

- Never disconnect the starter battery while the engine is running.
- Make sure the cables to the starter battery are correctly connected and the clamps are securely tightened.

WARNING

- Batteries generate hydrogen gas, which is flammable and explosive.
- Do not connect the jumper cable to any part of the fuel system or to any moving parts. Avoid touching hot manifolds.
- Battery fluid contains sulfuric acid. Do not allow battery fluid to contact eyes, skin, fabrics or painted surfaces.
- If contact occurs, flush the affected area immediately with water. Obtain medical help immediately if eyes are affected.
- Never expose the battery to open flame or electric spark. Do not smoke near the battery. Failure to follow the instructions for jump starting can lead to injury.

Starter battery service life and capacity

The service life of the starter battery is affected by several factors, such as number of starts, battery discharges, driving style, driving conditions, climate, etc. The starting capacity of the battery reduces gradually over time. The battery must therefore be recharged if the vehicle is not used for a long period of time or if it is only driven short distances. Severe cold

further limits starting capacity. If the starter battery becomes discharged too many times, its service life will be shortened.

To help keep the starter battery in good condition, the vehicle should be driven at least 15 minutes per week or the battery should be connected to a battery charger with automatic trickle charging. A starter battery that is always kept fully charged has the maximum service life.

Location

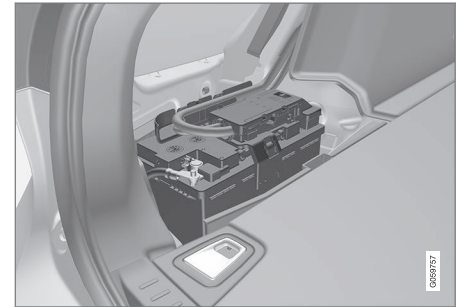

The starter battery is located in the cargo compartment.



⚠ WARNING

If the starter battery is disconnected, the function for automatic opening and closing must be reset to function correctly. A reset is required in order for the pinch protection to work.

⚠ CAUTION

On certain models, the battery is secured with a tensioning strap. Make sure that the tensioning strap is always securely tightened.

Specifications for starter battery

Battery type	H8 AGM
Voltage (V)	12
Cold start capacity ^A - CCA ^B (A)	850
Dimensions, L×W×H	353×175×190 mm (13.9×6.9×7.5 inches)
Capacity (Ah)	95

^A According to EN standard.

^B Cold Cranking Amperes.

Volvo recommends that batteries are replaced by an authorized Volvo workshop.

⚠ CAUTION

If replacing the battery, make sure you replace it with a battery of the same size, cold start capacity and type as the original battery (see the decal on the battery).

Related information

- Battery symbols (p. 603)
- Hybrid battery (p. 603)
- Jump starting using another battery (p. 455)
- Reset procedure for pinch protection (p. 165)
- Battery recycling (p. 604)

Hybrid battery

The vehicle's electric motor is powered by a rechargeable, maintenance-free, lithium-ion hybrid battery.

i NOTE

The vehicle cannot be started if the hybrid battery is discharged.

If both the starter battery and the hybrid battery are discharged, both batteries must be charged. In this situation, it is not possible to first charge only the hybrid battery. The starter battery must have a certain charge level in order for the hybrid battery to be charged.

⚠ WARNING

Hybrid battery replacement may only be performed by a workshop – an authorized Volvo workshop is recommended.

Hybrid battery service life and capacity

The capacity of the hybrid battery decreases with age and use, which could result in increased use of the combustion engine and thereby higher fuel consumption and reduced electric motor range.

Coolant

The hybrid battery's cooling system has its own expansion tank.

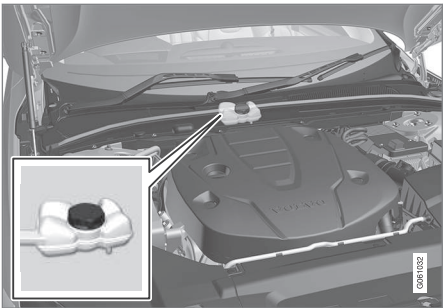

! CAUTION

Filling the hybrid battery coolant should only be performed by a workshop – an authorized Volvo workshop is recommended.

Specifications for hybrid battery

Type: Lithium-ion
Power reserve: 11.6 kWh.

Related information

- Battery symbols (p. 603)
- Starter battery (p. 601)
- Charging the hybrid battery (p. 391)
- Battery recycling (p. 604)

Battery symbols

There are warning symbols and information on the batteries.

	<p>Wear protective goggles.</p>
	<p>See the Owner's Manual for additional information.</p>
	<p>Keep batteries away from children.</p>
	<p>Batteries contain corrosive acid.</p>



	<p>Avoid smoking, open flames, and/or sparks.</p>
	<p>Risk of explosion.</p>
	<p>Recycle properly.</p>

Related information

- Starter battery (p. 601)
- Hybrid battery (p. 603)
- Battery recycling (p. 604)

Battery recycling

Start batteries must be recycled in an environmentally sound manner at the end of their service life.

Consult a workshop if you are uncertain of how to dispose of this type of waste – an authorized Volvo workshop is recommended.

Related information

- Starter battery (p. 601)
- Hybrid battery (p. 603)
- Battery symbols (p. 603)

Fuses and fuseboxes

All electrical functions and components are protected by a number of fuses in order to protect the vehicle's electrical system from damage by short circuiting or overloading.

⚠ WARNING

Never use a foreign object or a fuse with a higher amperage than that specified to replace a fuse. This could cause significant damage to the electrical system and possibly lead to a fire.

⚠ WARNING

Orange wiring may only be handled by qualified personnel.

⚠ WARNING

A number of electrical components in Twin Engine Plug-in Hybrid vehicles use high-voltage current and can be extremely dangerous if handled incorrectly.

Do not touch anything that is not clearly described in the vehicle's Owner's Manual.

If any electrical component or function is not responding, the component may have blown a fuse due to temporary overload. If the same fuse blows repeatedly, there may be a problem with the component. Volvo recommends contacting an authorized Volvo workshop to have the component checked.

Location of fuseboxes

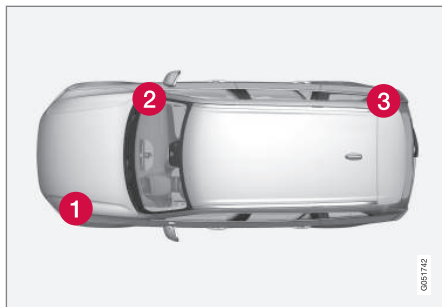

The illustration is generic - appearance may vary according to vehicle model.

- 1 Engine compartment
- 2 Under the glove compartment
- 3 Trunk/cargo compartment

Related information

- Replacing fuses (p. 605)
- Fuses in the cargo compartment (p. 619)
- Fuses in the engine compartment (p. 606)
- Fuses under the glove compartment (p. 613)

Replacing fuses

All electrical functions and components are protected by a number of fuses in order to protect the vehicle's electrical system from damage by short circuiting or overloading.

1. Refer to the fuse diagram to locate the fuse.
2. Pull out the fuse and examine it from the side to determine if the curved metal wire in the fuse is intact.
3. If the wire is broken, replace the fuse with a new fuse of the same color and amperage.

WARNING

Never use a foreign object or a fuse with a higher amperage than that specified to replace a fuse. This could cause significant damage to the electrical system and possibly lead to a fire.

WARNING

Contact an authorized Volvo workshop for assistance replacing fuses not listed in the Owner's Manual. If fuse replacement is performed incorrectly, significant damage can be caused to the electrical system.

Related information

- Fuses and fuseboxes (p. 604)
- Fuses in the cargo compartment (p. 619)
- Fuses in the engine compartment (p. 606)
- Fuses under the glove compartment (p. 613)

Fuses in the engine compartment

The fuses in the engine compartment help protect electrical components such as engine and brake functions.

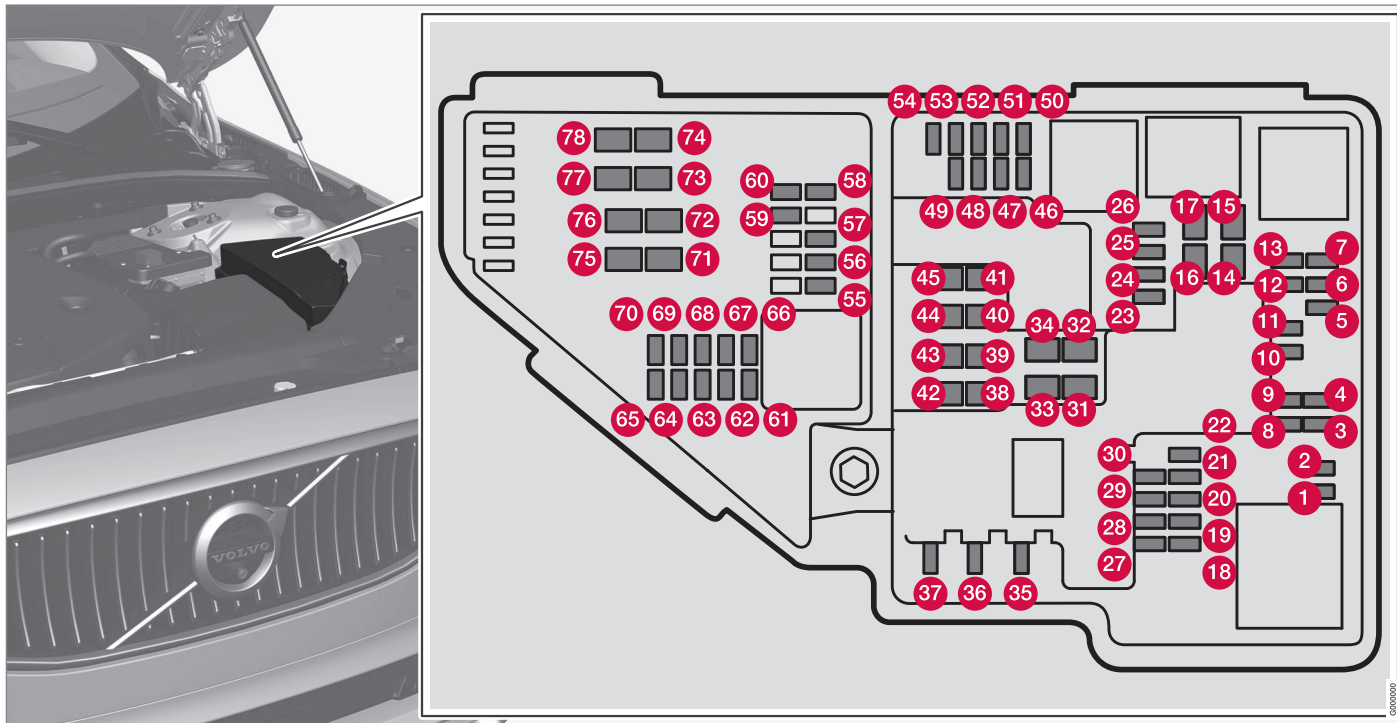

Fuse pliers are provided on the inside of the fuse box cover to assist in removing and inserting fuses.

There are also spaces for several extra fuses in the fusebox.

Positions

There is a decal with a diagram of the locations of the fuses on the inside of the cover.

	Function	Ampere	Type
1	–	–	Micro
2	–	–	Micro
3	–	–	Micro
4	Control module for actuator for engaging/changing gears, automatic transmission	5	Micro
5	High-voltage coolant heater control module	5	Micro
6	Control module for A/C; heat exchanger cut-off valve; cut-off valve for coolant through the climate system	5	Micro
7	Hybrid battery control module; high-voltage converter for combined high-voltage generator/starter motor with 500 V–12 V voltage converter	5	Micro
8	–	–	Micro
9	Converter for controlling feed to rear axle electric motor	10	Micro
10	Hybrid battery control module; high-voltage converter for combined high-voltage generator/starter motor with 500 V–12 V voltage converter	10	Micro
11	Charge module	5	Micro
12	Cut-off valve for hybrid battery coolant; coolant pump 1 for hybrid battery	15	Micro
13	Coolant pump for electric drive system	15	Micro





	Function	Ampere	Type
14	Hybrid component cooling fan	25	MCase ^A
15	–	–	MCase ^A
16	–	–	MCase ^A
17	–	–	MCase ^A
18	Calculation module	5	Micro
19	–	–	Micro
20	–	–	Micro
21	–	–	Micro
22	–	–	Micro
23	Front USB port in tunnel console, front*	7.5	Micro
24	12 V outlet in tunnel console, front	15	Micro
25	–	–	Micro
26	12 V outlet in trunk/cargo compartment*	15	Micro
27	–	–	Micro
28	Driver-side headlight, LED ^B	15	Micro
29	Passenger-side headlight, LED ^B	15	Micro
30	–	–	Micro

	Function	Ampere	Type
31	–	–	MCas ^A
32	–	–	MCas ^A
33	Headlight washers*	25	MCas ^A
34	Windshield washer	25	MCas ^A
35	–	–	Micro
36	Horn	20	Micro
37	Alarm siren*	5	Micro
38	Brake system control module (valves, parking brake)	30	MCas ^A
39	Wipers	30	MCas ^A
40	Rear window washer	25	MCas ^A
41	–	–	MCas ^A
42	Parking heater*	20	MCas ^A
43	–	–	MCas ^A
44	–	–	MCas ^A
45	–	–	MCas ^A
46	Fed when ignition is on: Engine control module; transmission components, electrical power steering, central electrical module	5	Micro





	Function	Ampere	Type
47	Exterior vehicle sound (certain markets)	5	Micro
48	Passenger-side headlight, LED ^B	15	Micro
49	–	–	Micro
50	–	–	Micro
51	–	–	Micro
52	Airbags; Passenger weight sensor	5	Micro
53	Driver-side headlight, LED ^B	15	Micro
54	Accelerator pedal sensor	5	Micro
55	Transmission control module; gear selector control module	15	Micro
56	Engine control module	5	Micro
57	–	–	Micro
58	–	–	Micro
59	–	–	Micro
60	–	–	Micro
61	Engine control module; actuator; throttle unit; turbo-charger valve	20	Micro
62	Solenoids, Fuel leakage control valve; Overpressure coupling	10	Micro
63	Vacuum regulator; Electric bypass valve: Ventilation valve	7.5	Micro

	Function	Ampere	Type
64	Spoiler damper control module; Cooler damper control module Fuel leakage control pump	5	Micro
65	–	–	Micro
66	Heated oxygen sensor front and rear	15	Micro
67	Oil pump solenoid; A/C magnetic coupling; Heated oxygen sensor front, center and rear	15	Micro
68	–	–	Micro
69	Engine control module	20	Micro
70	Ignition coils; spark plugs	15	Micro
71	–	–	MCase ^A
72	–	–	MCase ^A
73	Transmission oil pump control module	30	MCase ^A
74	–	–	MCase ^A
75	–	–	MCase ^A
76	–	–	MCase ^A
77	–	–	MCase ^A
78	–	–	MCase ^A

^A This type of fuse should be replaced by a workshop. An authorized Volvo workshop is recommended.

^B LED (Light Emitting Diode)

◀ **Related information**

- Fuses and fuseboxes (p. 604)
- Replacing fuses (p. 605)

Fuses under the glove compartment

Fuses under the glove compartment provide protection for e.g. electrical outlets, displays and door modules.

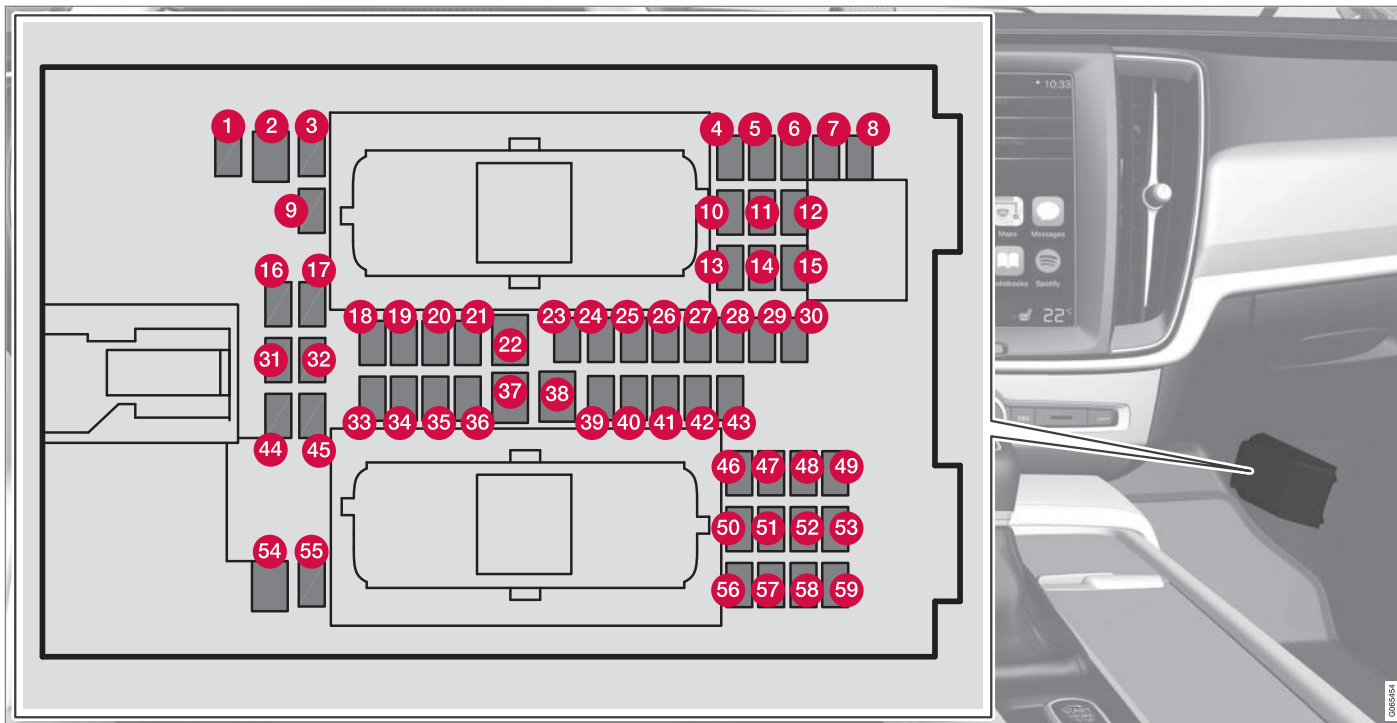

Fuse pliers are provided on the inside of the fuse box cover to assist in removing and inserting fuses.

There are also spaces for several extra fuses in the **distribution box in the engine compartment**.

Positions

There is a decal with a diagram of the locations of the fuses on the inside of the cover.

	Function	Ampere	Type
1	Medium voltage module ^A	10	Micro
2	–	–	MCas ^B
3	–	–	Micro
4	Movement sensor*	5	Micro
5	–	–	Micro
6	Instrument panel	5	Micro
7	Center console buttons	5	Micro
8	Sun sensor	5	Micro
9	–	–	Micro
10	–	–	Micro
11	Steering wheel module	5	Micro
12	Module for start knob and parking brake controls	5	Micro
13	Heated steering wheel* module	15	Micro
14	–	–	Micro
15	–	–	Micro
16	–	–	Micro
17	–	–	Micro





	Function	Ampere	Type
18	Climate system control module	10	Micro
19	–	–	Micro
20	Data link connector OBD-II	10	Micro
21	Center display	5	Micro
22	Climate system blower module (front)	40	MCase ^B
23	USB HUB	5	Micro
24	Instrument lighting; Interior lighting; Rearview mirror auto-dim function*; Rain and light sensors*; Rear tunnel console keypad, rear seat*; Power front seats*; Rear door control panels; Climate system blower module left/right	7.5	Micro
25	Control module for driver support functions	5	Micro
26	Panoramic roof with sun curtain*	20	Micro
27	Head-up display*	5	Micro
28	Passenger compartment lighting	5	Micro
29	Wireless charging pad	5	Micro
30	Ceiling console display (seat belt reminder/front passenger side airbag indicator)	5	Micro
31	–	–	Micro
32	–	–	Micro
33	–	–	Micro

	Function	Ampere	Type
34	–	–	Micro
35	Control module for Internet-connected vehicle; Control module for Volvo On Call	5	Micro
36	–	–	Micro
37	Infotainment control module (amplifier)	40	MCase ^B
38	–	–	MCase ^B
39	Multi-band antenna module	5	Micro
40	Front seat massage function*	5	Micro
41	–	–	Micro
42	Rear window wiper	15	Micro
43	Fuel pump control module	15	Micro
44	Relay coil for transmission oil pump Converter medium voltage; Integrated starter motor	5	Micro
45	Opening trunk/tailgate with foot movement*	5	Micro
46	Driver's seat heating	15	Micro
47	Front passenger's seat heating	15	Micro
48	Coolant pump	7.5	Micro
49	–	–	Micro





	Function	Ampere	Type
50	Power driver's seat*	20	Micro
51	Active chassis control module*	20	Micro
52	–	–	Micro
53	Sensus control module	10	Micro
54	–	–	MCase ^B
55	–	–	Micro
56	Power front passenger seat*	20	Micro
57	–	–	Micro
58	TV* (certain markets only)	5	Micro
59	Primary fuse for fuses 52, 53, 57 and 58	15	Micro

A Vehicles with 48 V support battery only.

B This type of fuse should be replaced by a workshop. An authorized Volvo workshop is recommended.

Related information

- Fuses and fuseboxes (p. 604)
- Replacing fuses (p. 605)

Fuses in the cargo compartment

The fuses in the cargo compartment help protect electrical components such as the power seats*, airbags and seat belt tensioners.



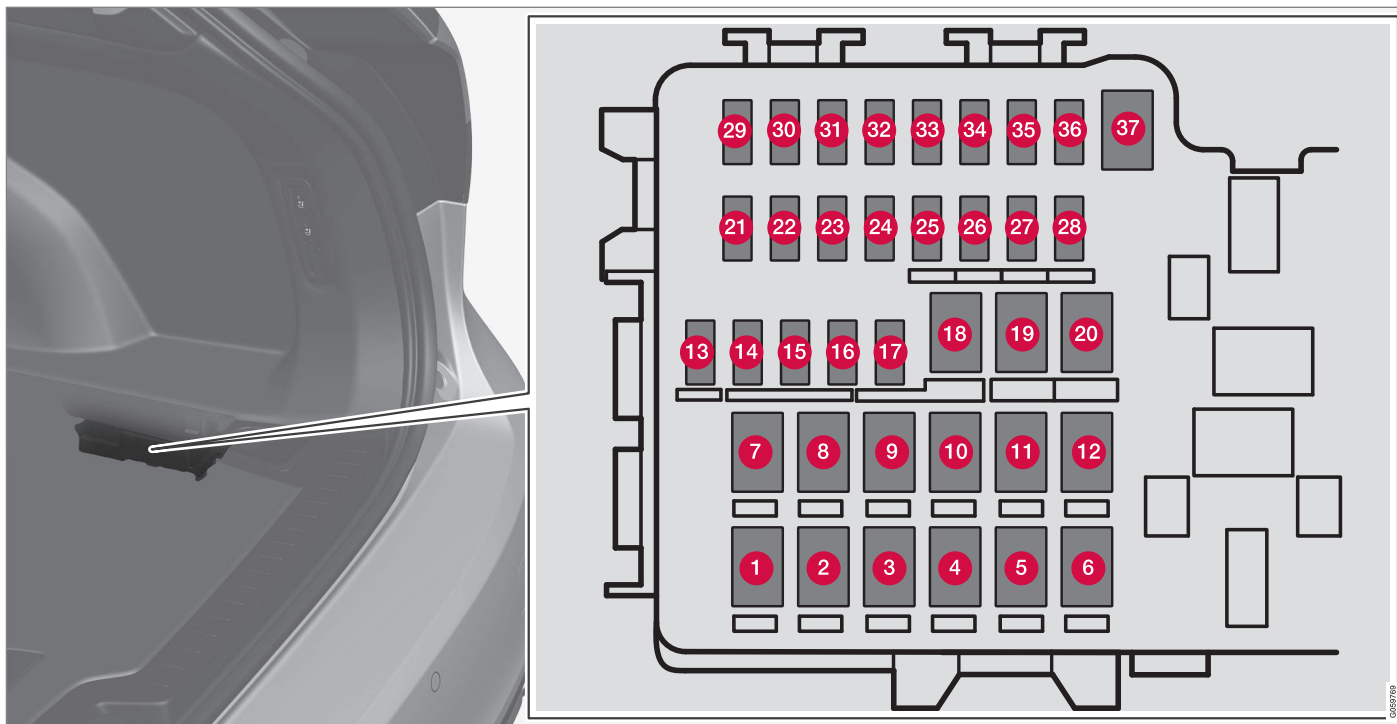

The fuse box is located on the right-hand side.

Fuse pliers are provided on the inside of the fuse box cover to assist in removing and inserting fuses.

There are also spaces for several extra fuses in the **distribution box in the engine compartment.**

Positions

	Function	Ampere	Type
1	–	–	MCas ^A
2	Central electrical module	40	MCas ^A
3	Pneumatic suspension* compressor	40	MCas ^A
4	–	–	MCas ^A
5	–	–	MCas ^A
6	–	–	MCas ^A
7	Door module right side, rear	20	MCas ^A
8	–	–	MCas ^A
	–	–	
	–	–	
9	Power tailgate*	25	MCas ^A
10	Power front passenger seat*	20	MCas ^A
	Door module right side, front		
11	Towbar* control module	40	MCas ^A
12	Seat belt tensioner module (right side)	40	MCas ^A
13	Internal relay windings	5	Micro



MAINTENANCE AND SERVICE



	Function	Ampere	Type
14	–	–	Micro
	–	–	
15	Door module left side, rear	20	Micro
16	USB hub/accessory port	5	Micro
17	–	–	Micro
18	Towbar* control module	25	MCase ^A
	Accessory module	40	
19	Power driver seat*	20	MCase ^A
	Door module left side, front		
20	Seat belt tensioner module (left side)	40	MCase ^A
21	Park Assist Camera*	5	Micro
22	–	–	Micro
23	–	–	Micro
24	–	–	Micro
25	Feed when ignition is on	10	Micro
26	–	–	Micro
27	–	–	Micro
28	Heated rear seat (left side)*	15	Micro

	Function	Ampere	Type
29	–	–	Micro
30	Blind Spot Information (BLIS)* Exterior reverse signal control module	5	Micro
31	–	–	Micro
32	Seat belt tensioner module, right	5	Micro
33	Emissions system actuator (gasoline, certain engine variants)	5	Micro
34	–	–	Micro
35	All Wheel Drive (AWD) control module*	15	Micro
36	Heated rear seat (right side)*	15	Micro
37	–	–	MCase ^A

^A This type of fuse should be replaced by a workshop. An authorized Volvo workshop is recommended.

Related information

- Fuses and fuseboxes (p. 604)
- Replacing fuses (p. 605)

Replacing bulbs

This vehicle is equipped with only LED¹⁵ lights, which means it does not have any replaceable bulbs. Contact a workshop¹⁴ if you experience any problems with the lighting.

If there is a problem with an LED¹⁵ light, the entire lamp unit will normally need to be replaced.

NOTE

For information on lights not mentioned in the Owner's Manual, contact a Volvo retailer or an authorized Volvo workshop.

NOTE

Exterior lighting such as headlights and taillights may develop temporary condensation on the inside of the lens. This is normal. All exterior lighting is designed to resist this. Condensation is normally vented out of the lamp housing once the light has been lit for some period of time.

NOTE

Bulbs for Active Bending Lights* contain traces of mercury and should therefore always be deposited at an authorized Volvo workshop.

Cleaning the interior

Use cleaning agents and car care products recommended by Volvo. Clean regularly and treat stains immediately. It is important to vacuum before using a cleaning agent.

CAUTION

- Some colored clothing (for example, dark jeans and suede garments) may stain the upholstery. If this occurs, it is important to clean and treat these parts of the upholstery as soon as possible.
- Never use strong solvents such as washer fluid, gasoline, mineral spirit or concentrated alcohol to clean the interior as this can damage the upholstery as well as other interior materials.
- Never spray cleaning agent directly onto components that have electrical buttons and controls. Wipe instead with a damp cloth with cleaning agent.
- Sharp objects and Velcro can damage the car's textile upholstery.
- Only use cleaning agent on the type of material it is intended for.

¹⁵ LED (Light Emitting Diode)

¹⁴ An authorized Volvo workshop is recommended.

Related information

- Cleaning the center display (p. 625)
- Cleaning fabric upholstery and ceiling liner (p. 626)
- Cleaning the seat belt (p. 627)
- Cleaning textile floor and inlay mats (p. 628)
- Cleaning leather upholstery* (p. 628)
- Cleaning the leather steering wheel (p. 629)
- Cleaning interior plastic, metal and wood surfaces (p. 630)

Cleaning the center display

Marks, stains, finger smudges etc. on the center display may affect its performance and readability. Clean the screen regularly with a microfiber cloth.



1. Turn off the center display by pressing and holding the Home button.
2. Wipe the screen clean with the microfiber cloth provided or use another microfiber cloth of similar quality. Wipe the screen with a clean, dry microfiber cloth using small, circular motions. If necessary, moisten the cloth slightly.
3. Reactivate the display by pressing the Home button briefly.

! CAUTION

The microfiber cloth must be free of sand and dirt when cleaning the center display.

! CAUTION

When cleaning the center display, apply only light pressure to the screen. Pressing too hard could damage the screen.

! CAUTION

Do not spray liquid or corrosive chemicals directly onto the center display. Do not use window cleaners, cleaning agents, aerosol sprays, solvents, alcohol, ammonia or detergents that contain abrasives.

Never use abrasive cloths, paper towels or tissue paper, as these may scratch the center display.

Related information

- Cleaning the interior (p. 624)
- Cleaning fabric upholstery and ceiling liner (p. 626)
- Cleaning the seat belt (p. 627)
- Cleaning textile floor and inlay mats (p. 628)
- Cleaning leather upholstery* (p. 628)



- Cleaning the leather steering wheel (p. 629)
- Cleaning interior plastic, metal and wood surfaces (p. 630)

Cleaning the head-up display* and instrument panel

Carefully wipe the glass covering the head-up display unit with a clean and dry microfiber cloth. If necessary, the cloth may be slightly moistened.

Never use strong stain removers. For difficult cleaning conditions, a special cleaning agent can be purchased at a Volvo retailer.

Related information

- Activating and deactivating the head-up display* (p. 142)
- Head-up display* (p. 140)

Cleaning fabric upholstery and ceiling liner

Use of textile cleaner is recommended when cleaning textile materials. Clean as needed and treat stains immediately.

CAUTION

Never scrape or rub a stain because this may damage the upholstery.

CAUTION

Never use stain removers or strong solvents because these may damage the upholstery.

Cleaning textile upholstery

1. Start by vacuuming the upholstery.
2. Follow the instructions of the textile cleaner.
3. When cleaning upholstery, a spray extraction cleaner is recommended for sucking up cleaning fluids and rinse water.

CAUTION

Certain dyed clothing (such as denim and suede garments) may stain the upholstery. Difficult stains, like oil, can be difficult to remove.

! CAUTION

Always clean all of the upholstery, even if it only has isolated stains. This helps to prevent permanent water rings.

i NOTE

Do not remove the upholstery when cleaning.

Cleaning the ceiling liner

1. Carefully brush the ceiling liner using a soft brush.
2. Follow the instructions of the textile cleaner.
3. Then use a soft, lint-free cloth to wipe the ceiling liner.

! CAUTION

Failure to take care during cleaning could lead to damage to the ceiling liner.

Related information

- Cleaning the interior (p. 624)
- Cleaning the center display (p. 625)
- Cleaning the seat belt (p. 627)
- Cleaning textile floor and inlay mats (p. 628)
- Cleaning leather upholstery* (p. 628)

- Cleaning the leather steering wheel (p. 629)
- Cleaning interior plastic, metal and wood surfaces (p. 630)

Cleaning the seat belt

Use cleaning agents and car care products recommended by Volvo. Clean regularly and treat stains immediately. It is important to vacuum before using a cleaning agent. Use water and a synthetic soap solution. Specially designed textile cleaning agents are available for purchase at Volvo retailers. Make sure the belt is dry before it is retracted.

Related information

- Cleaning the interior (p. 624)
- Cleaning the center display (p. 625)
- Cleaning fabric upholstery and ceiling liner (p. 626)
- Cleaning textile floor and inlay mats (p. 628)
- Cleaning leather upholstery* (p. 628)
- Cleaning the leather steering wheel (p. 629)
- Cleaning interior plastic, metal and wood surfaces (p. 630)

Cleaning textile floor and inlay mats

Use of textile cleaner is recommended when cleaning textile mats. Clean regularly and treat stains immediately. It is important to vacuum before using a cleaning agent.

Remove the inlay mats to clean the floor mats and inlay mats separately. Each inlay mat is secured into place with pins.

1. Remove the inlay mat by grasping the inlay mat at each pin and lifting the mat straight up.
2. Use a vacuum to remove dust and dirt.

i NOTE

Do not swing or strike the inlay mats violently against another object to remove dirt as this could damage the mats.

3. After vacuuming, a specially designed textile cleaning agent should be used to remove stains on floor mats.
4. After cleaning, put the inlay mat back into place by pressing it in at each pin.

! WARNING

- Never use more than one inlay mat at a time on the driver's floor. If any other type of floor mat is used, remove the original mat from the driver's seat floor before driving. All types of mats must be securely anchored in the attachment points in the floor. Make sure the floor mat does not impede the movement of the brake pedal or accelerator pedal in any way, as this could be a serious safety hazard.
- Volvo's floor mats are specially manufactured for your vehicle. They must be properly secured in the attachment points in the floor to help ensure they cannot slide and become trapped under the pedals.

Related information

- Cleaning the interior (p. 624)
- Cleaning the center display (p. 625)
- Cleaning fabric upholstery and ceiling liner (p. 626)
- Cleaning the seat belt (p. 627)
- Cleaning leather upholstery* (p. 628)
- Cleaning the leather steering wheel (p. 629)
- Cleaning interior plastic, metal and wood surfaces (p. 630)

Cleaning leather upholstery*

Use cleaning agents and car care products recommended by Volvo. Clean regularly and treat stains immediately. It is important to vacuum before using a cleaning agent.

Volvo's leather upholstery* is treated to protect its original appearance. Over time, sunlight, grease, dirt, etc. could break down the protective layer. This could result in scratches and cracking.

Leather upholstery* is a natural product that changes and acquires a beautiful patina over time. Regular cleaning and treatments are required to preserve the qualities and color of the leather. Volvo offers a comprehensive product, Volvo Leather Care KitWipes, for cleaning and treating leather upholstery. When used as directed, it helps preserve the leather's protective coating.

For optimal results, Volvo recommends cleaning and applying protective cream one to four times a year (or more often as needed). Volvo Leather Care Kit 951 0251 and Volvo Leather Softener 943 7429 are available for purchase at Volvo retailers.

Cleaning the leather upholstery

1. Apply the leather cleaner to a damp sponge and squeeze it until the cleaner foams.

2. Move the sponge in circular motions to apply the foam to the stain.
3. Dampen the stain thoroughly with the sponge. Let the sponge absorb the stain and do not rub.
4. Dry the stain using a soft towel and let the leather dry completely.

Protecting the leather upholstery

1. Apply a small amount of leather protector to a cloth and then apply the protector to the leather using light circular movements.
2. Let it dry for approximately 20 minutes.
 - > Protecting the leather upholstery makes it better able to withstand sunlight's harmful UV rays.

Related information

- Cleaning the interior (p. 624)
- Cleaning the center display (p. 625)
- Cleaning fabric upholstery and ceiling liner (p. 626)
- Cleaning the seat belt (p. 627)
- Cleaning textile floor and inlay mats (p. 628)
- Cleaning the leather steering wheel (p. 629)
- Cleaning interior plastic, metal and wood surfaces (p. 630)

Cleaning the leather steering wheel

Use cleaning agents and car care products recommended by Volvo. Clean regularly and treat stains immediately. It is important to vacuum before using a cleaning agent.

Leather needs to breathe. Never cover the leather steering wheel with a plastic protector. Volvo Leather Care Kit 951 0251 and Leather Softener 943 7429 are recommended for cleaning the leather steering wheel. First, remove dirt, dust, etc. with a damp sponge or cloth.

CAUTION

Sharp objects such as rings could damage the leather on the steering wheel.

Treating stains on the steering wheel:

Type 1 (ink, wine, coffee, milk, sweat or blood)

- Use a soft cloth or sponge. Wipe the steering wheel using a solution of 5% ammonia. For blood stains, mix approximately 2 dl (1 cup) of water with 25 g (one ounce) of salt and wipe the stain.

Type 2 (grease, oil, sauces or chocolate)

1. Same procedure as for Type 1 stains.
2. Finish by wiping the wheel with an absorbent paper or towel.

Type 3 (dry dirt or dust)

1. Remove the dirt/dust using a soft brush.
2. Same procedure as for Type 1 stains.

Related information

- Cleaning the interior (p. 624)
- Cleaning the center display (p. 625)
- Cleaning fabric upholstery and ceiling liner (p. 626)
- Cleaning the seat belt (p. 627)
- Cleaning textile floor and inlay mats (p. 628)
- Cleaning leather upholstery* (p. 628)
- Cleaning interior plastic, metal and wood surfaces (p. 630)

Cleaning interior plastic, metal and wood surfaces

Use cleaning agents and car care products recommended by Volvo. Clean regularly and treat stains immediately.

A lightly dampened microfiber cloth is recommended for cleaning interior details and surfaces. These cloths are available for purchase at Volvo retailers.

Never scrape or rub a stain. Never use strong stain removers.

CAUTION

Do not use solvent containing alcohol to clean the instrument panel glass.

CAUTION

Keep in mind that glossy surfaces can be easily scratched. Wipe these surfaces with a clean and dry microfiber cloth using small, circular motions. If necessary, moisten the cloth lightly with clean water.

Related information

- Cleaning the interior (p. 624)
- Cleaning the center display (p. 625)
- Cleaning fabric upholstery and ceiling liner (p. 626)
- Cleaning the seat belt (p. 627)

- Cleaning textile floor and inlay mats (p. 628)
- Cleaning leather upholstery* (p. 628)
- Cleaning the leather steering wheel (p. 629)

Cleaning the exterior

The vehicle should be washed as soon as it becomes dirty. This makes the vehicle easier to clean because dirt does not attach as strongly. It also reduces the risk of scratches and keeps the vehicle looking new. Wash the rims at a car wash or garage with an oil separator. Use a car washing detergent recommended by Volvo.

Related information

- Cleaning the exterior (p. 630)
- Polishing and waxing (p. 631)
- Hand washing (p. 632)
- Automatic car washes (p. 633)
- High-pressure washing (p. 634)
- Cleaning the wiper blades (p. 635)
- Cleaning exterior plastic, rubber and trim components (p. 635)
- Cleaning rims (p. 636)
- Corrosion protection (p. 637)

Polishing and waxing

Polish and wax the vehicle when the paint is dull or to provide extra protection. The vehicle does not need to be polished until it is at least a year old. However, it can be waxed during the first year. Do not polish or wax the vehicle in direct sunlight. The surface of the vehicle should not be warmer than 45 °C (113 °F).

- Wash and dry the vehicle very carefully before polishing or waxing. Remove asphalt and tar stains with asphalt remover or paint thinner. More stubborn stains can be removed with a grinding paste designed for vehicle paint. Use cleaning agents recommended by Volvo.
- Use polish first and then liquid or paste wax. Follow the instructions on the package carefully. Many products contain both polish and wax.
- A wide range of polymer-based waxes can be purchased today. These waxes are easy to use and produce a long-lasting, high-gloss finish that protects the bodywork against oxidation, road dirt and fading.

! CAUTION

Never polish or wax initially matte exterior details on the vehicle. This could destroy the matte effect and make the surface permanently shiny.

! CAUTION

Avoid waxing and polishing plastic and rubber.

If using degreaser on plastic and rubber, only rub (if necessary) with slight pressure. Use a soft sponge.

Polishing glossy trim moldings can wear away or damage the glossy surface layer.

Polish containing abrasives must not be used.

! CAUTION

Use cleaning agents recommended by Volvo. Other treatments, such as preservation, sealing, protection, luster sealing or similar, could damage the paintwork. Paintwork damage caused by such treatments are not covered by Volvo's warranty.

- Automatic car washes (p. 633)
- High-pressure washing (p. 634)
- Cleaning the wiper blades (p. 635)
- Cleaning exterior plastic, rubber and trim components (p. 635)
- Cleaning rims (p. 636)
- Corrosion protection (p. 637)

Related information

- Cleaning the exterior (p. 630)
- Hand washing (p. 632)

Hand washing

The vehicle should be washed as soon as it becomes dirty. This makes the vehicle easier to clean because dirt does not attach as strongly. It also reduces the risk of scratches and keeps the vehicle looking new. Wash the vehicle in a car wash or garage with an oil separator and use car washing detergent. Use cleaning agents and car care products recommended by Volvo.

Important to keep in mind when handwashing your vehicle

- Avoid washing the vehicle in direct sunlight. This could cause the detergent or wax to dry out and become abrasive.
- Remove bird droppings from paintwork as soon as possible. It contains chemicals that affect and discolor paintwork very quickly. Use e.g. soft paper or a sponge soaked in lots of water. Consult an authorized Volvo workshop for assistance removing discoloration.
- Hose down the underbody, including the wheel housings and bumper.
- Hose down the entire vehicle and remove any loose dirt, droppings etc. to reduce the risk of scratches from washing. Do not spray directly onto locks.

- If necessary, use cold degreaser on heavily soiled surfaces. Note that in such cases the surfaces must not be hot from the sun.
- Wash using a sponge, car washing detergent and plenty of lukewarm water. Make sure that the sponge is clean. A dirty sponge can scratch the paint.
- Clean the wiper blades with lukewarm soap solution or car washing detergent.
- Dry the vehicle using a clean, soft chamois or a squeegee. Try not to let drops of water dry in strong sunlight. This could cause water drying stains that may need to be polished out.
- In areas with heavy industrial emissions, more frequent washing of the vehicle's exterior is recommended.
- Tar spots from asphalt may remain even after washing. Use a Volvo-recommended tar remover to remove these spots after washing the vehicle.

WARNING

Always entrust engine washing to a workshop. If the engine is hot, there is a risk of fire.

CAUTION

Dirty headlights do not work as well. Clean them regularly, e.g. when refueling.

Do not use corrosive cleaners. Use water and a non-abrasive sponge.

NOTE

Exterior lighting such as headlights and taillights may develop temporary condensation on the inside of the lens. This is normal. All exterior lighting is designed to resist this. Condensation is normally vented out of the lamp housing once the light has been lit for some period of time.

CAUTION

- Make sure that the panoramic roof* and sun shade are closed before washing the vehicle.
- Never use abrasive polishing agents on the panoramic roof.
- Never use wax on the rubber seals around the panoramic roof.

! CAUTION

Remember to remove dirt from the drain holes in the doors and sills after washing the vehicle.

Related information

- Cleaning the exterior (p. 630)
- Polishing and waxing (p. 631)
- Automatic car washes (p. 633)
- High-pressure washing (p. 634)
- Cleaning the wiper blades (p. 635)
- Cleaning exterior plastic, rubber and trim components (p. 635)
- Cleaning rims (p. 636)
- Corrosion protection (p. 637)
- Settings for automatically activating the parking brake (p. 423)

Automatic car washes

The vehicle should be washed as soon as it becomes dirty. The longer the dirt remains, the more difficult it will be to keep the vehicle clean. It could also lead to paint damage.

Washing your vehicle in an automatic car wash is a fast and easy way to keep your vehicle clean, but it does not reach all areas of the vehicle. Volvo recommends washing your vehicle by hand or supplementing automatic car washes with a hand wash.

i NOTE

Volvo recommends not washing the vehicle in an automatic car wash during the first few months; the paintwork on new vehicles takes some time to fully harden.

! CAUTION

Before driving the vehicle into a car wash, deactivate the Automatic Braking when Stationary and Automatic Parking Brake Application functions. If the functions are not deactivated, the brake system will seize when the vehicle is stationary and the vehicle will not be able to roll.

! CAUTION

For automatic car washes in which the vehicle is pulled forward on rolling wheels:

1. Before washing the vehicle, make sure that the automatic rain sensor is deactivated. If it is not deactivated and inadvertently starts, the wiper arms could be damaged.
2. To help prevent damage from the automatic car wash machinery, make sure that the door mirrors are folded in, antennas retracted or removed, and any auxiliary lights secured.
3. Drive into the automatic car wash.
4. Turn off the "Automatic Braking when Stationary" function using the **(A)** button in the tunnel console.
5. Turn off the "Automatic Parking Brake Application" function in the center display's Top view.
6. Turn off the engine by turning the start knob in the tunnel console clockwise. Hold the knob in position for at least 2 seconds.

The vehicle is now ready for the automatic car wash.





CAUTION

The system will automatically change to **P** mode if the above steps are not followed. In **P** mode, the wheels are locked, which they should not be when the vehicle is being washed in a car wash.

NOTE

Keep in mind that if the vehicle is equipped with the keyless locking and unlocking function*, the doors and tailgate/trunk lid may open when washing the vehicle if the remote key is within range.

Testing the brakes

WARNING

Always test the brakes after washing the vehicle, including the parking brake, to ensure moisture and corrosion do not attach the brake pads and impair brake functionality.

Lightly depress the brake pedal from time to time when driving long distances in rain or slush. The heat from the friction will help warm up and dry the brake pads. Do the same after starting the vehicle in very damp or cold weather.

Related information

- Cleaning the exterior (p. 630)
- Polishing and waxing (p. 631)
- Hand washing (p. 632)
- High-pressure washing (p. 634)
- Cleaning the wiper blades (p. 635)
- Cleaning exterior plastic, rubber and trim components (p. 635)
- Cleaning rims (p. 636)
- Corrosion protection (p. 637)
- Auto-hold brakes (p. 424)
- Settings for automatically activating the parking brake (p. 423)
- Keyless and touch-sensitive surfaces* (p. 252)

High-pressure washing

The vehicle should be washed as soon as it becomes dirty. The longer the dirt remains, the more difficult it will be to keep the vehicle clean. It could also lead to paint damage. Wash the vehicle in a car wash or garage with an oil separator. Use a car washing detergent recommended by Volvo. If washing the vehicle with a high-pressure wash, use sweeping movements and keep the nozzle at least 30 cm (13 in.) from the vehicle. Do not spray directly onto locks.

Related information

- Cleaning the exterior (p. 630)
- Polishing and waxing (p. 631)
- Hand washing (p. 632)
- Automatic car washes (p. 633)
- Cleaning the wiper blades (p. 635)
- Cleaning exterior plastic, rubber and trim components (p. 635)
- Cleaning rims (p. 636)
- Corrosion protection (p. 637)

Cleaning the wiper blades

The vehicle should be washed as soon as it becomes dirty. The longer the dirt remains, the more difficult it will be to keep the vehicle clean. It could also lead to paint damage.

Wash the vehicle in a car wash or garage with an oil separator. Use a car washing detergent recommended by Volvo.

Asphalt, dust and salt residue on wiper blades, as well as insects, ice etc. on the windshield, shorten the service life of wiper blades.

When cleaning, put the wiper blades in the service position.

NOTE

Wash the wiper blades and windshield regularly with a lukewarm soap solution or vehicle shampoo. Do not use strong solvents.

Related information

- Cleaning the exterior (p. 630)
- Polishing and waxing (p. 631)
- Hand washing (p. 632)
- Automatic car washes (p. 633)
- High-pressure washing (p. 634)
- Cleaning exterior plastic, rubber and trim components (p. 635)
- Cleaning rims (p. 636)

- Corrosion protection (p. 637)

Cleaning exterior plastic, rubber and trim components

The vehicle should be washed as soon as it becomes dirty. The longer the dirt remains, the more difficult it will be to keep the vehicle clean. It could also lead to paint damage. Use a car washing detergent recommended by Volvo.

A special cleaning agent available from Volvo retailers is recommended for the cleaning and care of colored plastic parts, rubber and trim components, e.g. glossy trim. Follow the usage instructions for the cleaning agent carefully.

Avoid using car washing detergents with a pH value lower than 3.5 or higher than 11.5. Doing so could result in the discoloring of anodized aluminum surfaces* (as shown in the illustrations below). Abrasive polishing agents are not recommended for these areas (as shown in the illustrations below).



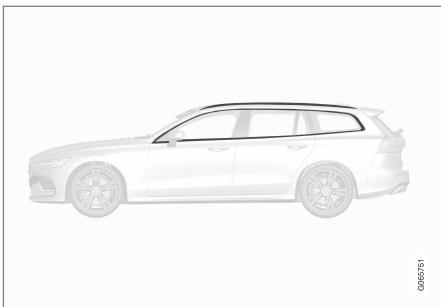

Components that should be washed with a cleaning product with a pH value between 3.5 and 11.5.

! CAUTION

Avoid waxing and polishing plastic and rubber.

If using degreaser on plastic and rubber, only rub (if necessary) with slight pressure. Use a soft sponge.

Polishing glossy trim moldings can wear away or damage the glossy surface layer.

Polish containing abrasives must not be used.

! CAUTION

Avoid washing the vehicle with cleaner with a pH value below 3.5 or above 11.5. This could cause discoloration of anodized aluminum components like the roof rail and around the side windows.

Never use metal polishing agent on anodized aluminum components. This could cause discoloration and destroy the surface treatment.

Related information

- Cleaning the exterior (p. 630)
- Polishing and waxing (p. 631)
- Hand washing (p. 632)
- Automatic car washes (p. 633)
- High-pressure washing (p. 634)
- Cleaning the wiper blades (p. 635)
- Cleaning rims (p. 636)
- Corrosion protection (p. 637)

Cleaning rims

The vehicle should be washed as soon as it becomes dirty. The longer the dirt remains, the more difficult it will be to keep the vehicle clean. It could also lead to paint damage. Wash the rims at a car wash or garage with an oil separator. Use a car washing detergent recommended by Volvo.

Use a rim cleaning agent recommended by Volvo.

Strong rim cleaning agents could damage the surface and stain the chromed aluminum rims.

Related information

- Cleaning the exterior (p. 630)
- Polishing and waxing (p. 631)
- Hand washing (p. 632)
- Automatic car washes (p. 633)
- High-pressure washing (p. 634)
- Cleaning exterior plastic, rubber and trim components (p. 635)
- Cleaning rims (p. 636)
- Corrosion protection (p. 637)

Corrosion protection

Your vehicle is constructed with protection against corrosion.

Corrosion protection for the body consists of modern metallic protective coatings on the sheet metal, a high-quality painting process, corrosion-protected and minimized metal overlap, and shielding plastic components, abrasion protection and supplemental rust inhibitor in exposed areas. In the chassis, exposed components of the wheel suspension are made of corrosion-resistant cast aluminum.

Inspection and maintenance

The corrosion protection does not normally require maintenance, but keeping the vehicle clean helps reduce the risk of corrosion. The use of strong alkaline or acidic cleaning fluids should be avoided on shiny body components. Any stone chips in the paint should be touched up as soon as they are discovered.

Related information

- Cleaning the exterior (p. 630)
- Polishing and waxing (p. 631)
- Hand washing (p. 632)
- Automatic car washes (p. 633)
- High-pressure washing (p. 634)
- Cleaning the wiper blades (p. 635)

- Cleaning exterior plastic, rubber and trim components (p. 635)
- Cleaning rims (p. 636)

Paintwork

The paintwork consists of multiple layers. It is an important part of the vehicle's corrosion protection and therefore needs to be checked regularly.

The most common types of paint damage are minor stone chips, scratches and damage to e.g. the edges of fenders, doors and bumpers. To help prevent corrosion, paint damage should be rectified immediately.

Related information

- Touching up minor paint damage (p. 638)
- Color codes (p. 639)

Touching up minor paint damage

The paintwork is an important part of the vehicle's corrosion protection and therefore needs to be checked regularly. The most common types of paint damage are minor stone chips, scratches and damage to e.g. the edges of fenders, doors and bumpers. To help prevent corrosion, paint damage should be rectified immediately.

i NOTE

Make sure the surface is clean and dry before performing any touch-ups to the paint. The surface temperature should be at least 15 °C (59 °F).

Materials that might be needed

- Primer – special adhesive primer is available in a spray can for e.g. plastic-covered bumpers.
- Base coat and clear coat – available in spray cans or as a touch-up pen/stick¹⁶.
- Masking tape.
- Fine-grain sandpaper.

Applying touch-up paint to a damaged surface

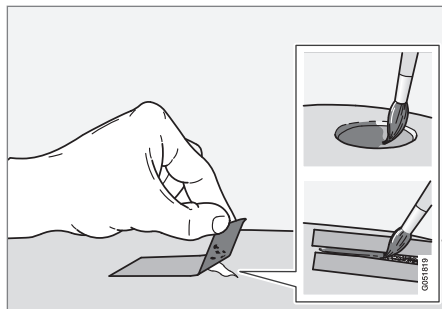

If the damage has not reached all the way down to the metal, then touch-up paint can be applied immediately after the surface has been cleaned.

1. Place a strip of masking tape over the damaged surface. Pull the tape off so that any loose flakes of paint adhere to it.

If the damage goes down to the bare metal, you may need to use primer first. If the paint damage is on a plastic surface, an adhesive primer should be used for better results. Spray the primer into the lid of the spray can and brush on thinly.

2. Light sanding with a very fine-grained sandpaper or similar may be required before painting (e.g. if there are uneven edges). Clean the area carefully to remove dirt, grease, salts, etc. and let it dry.
3. Thoroughly mix the primer and apply it with a small brush, toothpick or similar. When the primer is dry, apply one or more coats of paint and then a clear coat, letting the paint dry between each application.

If there is a longer scratch, follow the same procedure as above, but first mask off the surrounding area to protect the undamaged paint.

Touch-up pens/sticks and spray paint are available at Volvo retailers.

i NOTE

If the stone chip has not gone down to the bare metal and an undamaged coat of paint remains, apply base coat and clear coat immediately after cleaning the surface.

Related information

- Paintwork (p. 637)
- Color codes (p. 639)

¹⁶ Follow the instructions on the packaging for the touch-up pen/stick carefully.

Color codes

Color code

The color code decal is placed on the vehicle's left-side door pillar (B-pillar) between the front and rear doors and is visible when the left front door is open.

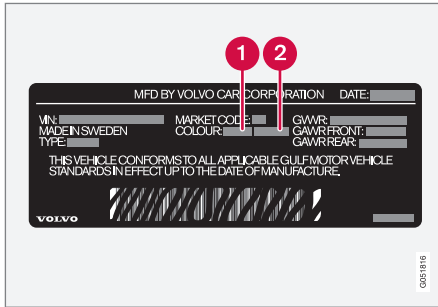

Sample color code (1): US models.

- 1 Exterior color code
- 2 Secondary exterior color code (if applicable)

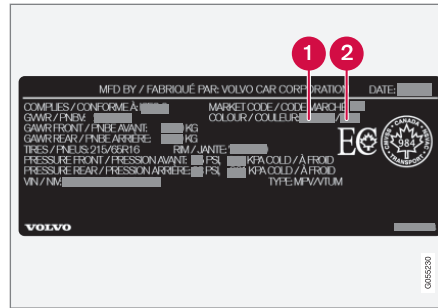

Sample color code (1): Canadian models.

- 1 Exterior color code
- 2 Secondary exterior color code (if applicable)

Related information

- Paintwork (p. 637)
- Touching up minor paint damage (p. 638)

Changing rear window wipers

The wiper blades help remove water from the windshield and rear window. Along with the washer fluid, they are designed to clean the glass and help improve visibility while driving. The windshield and rear window wiper blades can be replaced.



◀ Changing rear window wipers

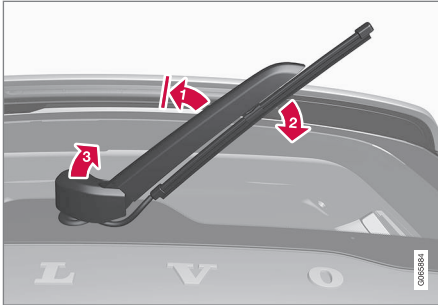

Lift the wiper arm from the window and pull the upper section of the blade down diagonally to the right.

- 1 Grasp the center of the wiper blade and lift it from the window to the stop position.

i NOTE

When the wiper arm is halfway folded out, it will stop in a locking position that helps prevent the arm from falling back onto the rear window. The wiper arm must be pulled past the locking position stop in order to change the wiper blade.

- 2 Grasp the center attachment point and pull it diagonally down to the right until the blade detaches from the arm.

- 3 Lift the sleeve on the wiper blade attachment. Make sure that the wiper arm doesn't accidentally retract toward the window.

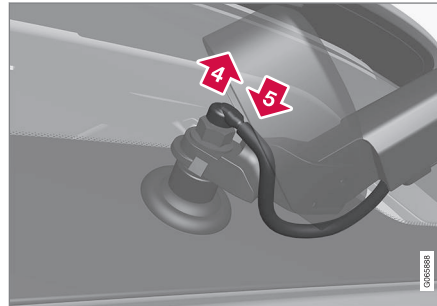

- 4 Remove the washer hose from the attachment.
- 5 Attach the new washer hose and wiper blade in the attachment. Fold down the sleeve on the wiper blade attachment.

i NOTE

Make sure that the hose is positioned as shown in the illustration. If the hose is not positioned as shown, it could be squeezed by the sleeve when it is folded down again.

- 6 Press the new wiper blade until it clicks into place. Check to make sure the blade is securely in place.
- 7 Fold the wiper arm back toward the window.

! CAUTION

Check the blades regularly. Neglected maintenance shortens the life of the blades.

Related information

- Using the rain sensor (p. 175)
- Using the windshield and headlight washers (p. 177)
- Using automatic rear window wiping when backing up (p. 179)
- Activating and deactivating the rain sensor's memory function (p. 176)
- Using the rear window wiper/washer (p. 178)
- Filling washer fluid (p. 643)
- Putting the wiper blades in service position (p. 642)
- Replacing windshield wiper blades (p. 641)
- Using the windshield wipers (p. 174)
- Wiper blades and washer fluid (p. 174)

Replacing windshield wiper blades

The wiper blades help remove water from the windshield and rear window. Along with the washer fluid, they are designed to clean the glass and help improve visibility while driving. The windshield and rear window wiper blades can be replaced.

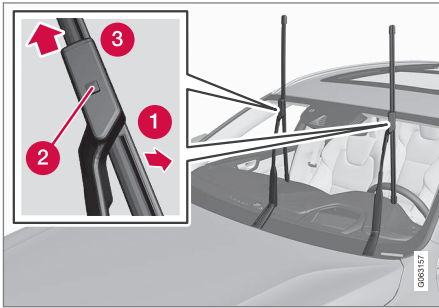

Raise the wiper arms to the service position. Service position is activated/deactivated via the function view in the center display when the car is stationary and the windshield wipers are not on.

- 1 Put the wiper blade in removal position by folding it out from the wiper arm until it clicks.
- 2 Press and hold the lock button on the wiper blade attachment.

- 3 While holding the button down, pull the blade straight out, parallel with the wiper arm.
4. Slide in the new wiper blade until it clicks into place.
5. Fold the blade back toward the arm until it clicks into place. The blade is no longer in its removal position and can once again be moved.
6. Check to make sure the wiper blade is securely in place.
7. Press the wiper blade back against the windshield.

Wiper blades come in varying lengths

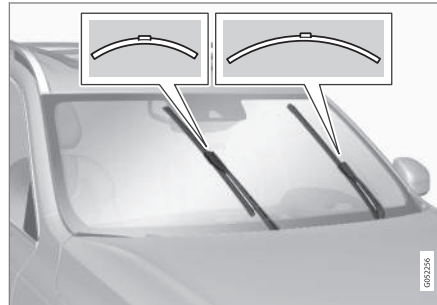

i NOTE

When changing wiper blades, make sure that the blades are of different lengths. The blade on the driver's side is longer than the one on the passenger side.

Related information

- Using the rain sensor (p. 175)
- Using the windshield and headlight washers (p. 177)
- Using automatic rear window wiping when backing up (p. 179)
- Activating and deactivating the rain sensor's memory function (p. 176)
- Using the rear window wiper/washer (p. 178)
- Filling washer fluid (p. 643)
- Putting the wiper blades in service position (p. 642)
- Changing rear window wipers (p. 639)
- Using the windshield wipers (p. 174)
- Wiper blades and washer fluid (p. 174)

Putting the wiper blades in service position

The windshield wiper blades must be in the service (vertical) position for certain operations, e.g. replacing the blades.



Windshield wipers in the service position.

The windshield wipers must be in the service position when replacing, washing or lifting the blades (e.g. to scrape ice or snow from the windshield).

! CAUTION

Before placing the wipers in service position, ensure that they have not frozen to the windshield.

Activating/deactivating service position

The service position can be activated/deactivated when the vehicle is stationary and the windshield wipers are switched off. Service position is activated/deactivated via Function view in the center display:

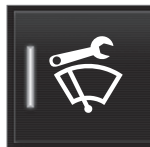

Tap the **Wiper Service Position** button. The indicator light in the button will illuminate when service position is activated. The wipers will move to the service position when activated. To deactivate

the service position, tap **Wiper Service Position** once. The indicator light in the button will go out when service position is deactivated.

The wiper blades will also move out of the service position if:

- The windshield wipers are turned on.
- The windshield washers are turned on.
- The rain sensor is activated.
- The vehicle begins moving.

! CAUTION

If the wiper arms in service position are raised from the windshield, they must be folded back against the windscreen before activating wiping, washing or rain sensor as well as before departure. This is to prevent scratching the paint on the hood.

Related information

- Using the rain sensor (p. 175)
- Using the windshield and headlight washers (p. 177)
- Using automatic rear window wiping when backing up (p. 179)
- Activating and deactivating the rain sensor's memory function (p. 176)
- Using the rear window wiper/washer (p. 178)
- Filling washer fluid (p. 643)
- Replacing windshield wiper blades (p. 641)
- Changing rear window wipers (p. 639)
- Using the windshield wipers (p. 174)
- Wiper blades and washer fluid (p. 174)

Filling washer fluid

Washer fluid is used to keep the headlights, windshield and rear window clean. Washer fluid containing anti-freeze should be used in very cold weather (below-freezing temperatures).

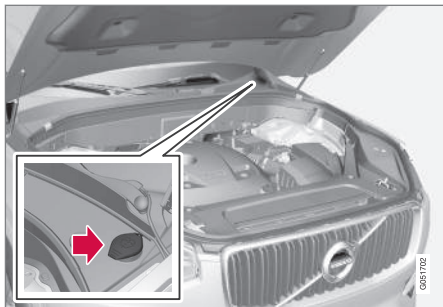

Fill washer fluid into the reservoir with the blue cover. The reservoir is used for the windshield washer, tailgate window washer and headlight washer*.

i NOTE

When there is approximately 1 liter (1 qt) of washer fluid remaining, the message **Washer fluid Level low, refill** and the  symbol will be displayed in the instrument panel.

Recommended grade: Washer fluid recommended by Volvo, with frost protection during cold weather and temperatures below the freezing point.

! CAUTION

Use Volvo's original washer fluid or an equivalent fluid with the recommended pH value between 6 and 8, diluted as recommended, e.g. in a 1:1 solution with pH-neutral water.

! CAUTION

Use washer fluid with anti-freeze when temperatures are below the freezing point to help keep the pump, reservoir and hoses from freezing.

Volume:

- Vehicles **with** headlight washing: 5.5 liters (5.8 qts).
- Vehicles **without** headlight washing: 3.5 liters (3.7 qts).

Related information

- Using the rain sensor (p. 175)
- Using the windshield and headlight washers (p. 177)
- Using automatic rear window wiping when backing up (p. 179)

- Activating and deactivating the rain sensor's memory function (p. 176)
- Using the rear window wiper/washer (p. 178)
- Putting the wiper blades in service position (p. 642)
- Replacing windshield wiper blades (p. 641)
- Changing rear window wipers (p. 639)
- Using the windshield wipers (p. 174)
- Wiper blades and washer fluid (p. 174)
- Opening and closing the hood (p. 593)

SPECIFICATIONS

Type designations

The decals in the vehicle contain information such as chassis number, type designation, color code, etc.

Location of decals

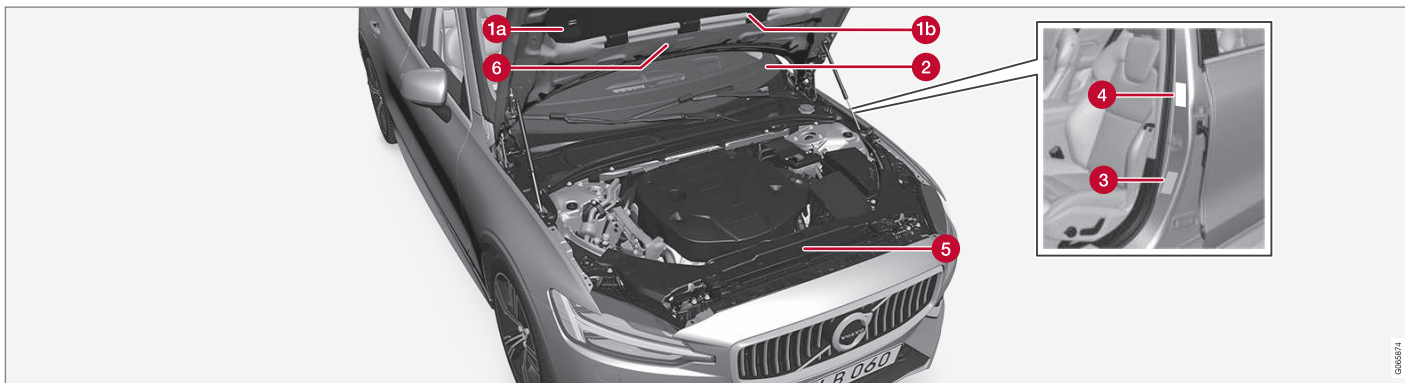

The illustration is general and details may vary depending on market and model.

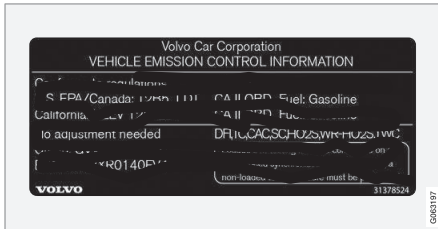

1a Vehicle Emission Control Information. US models. Your Volvo is designed to meet all applicable emission standards, as evidenced by the certification label on the underside of the hood. For further information regarding these regulations, please consult your Volvo retailer.

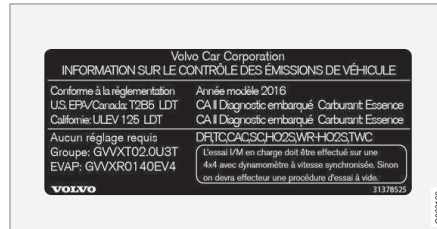

1b Vehicle Emission Control Information. Canadian models. Your Volvo is designed to meet all applicable emission standards, as evidenced by the certification label on the underside of the hood. For further information regarding these regulations, please consult your Volvo retailer.

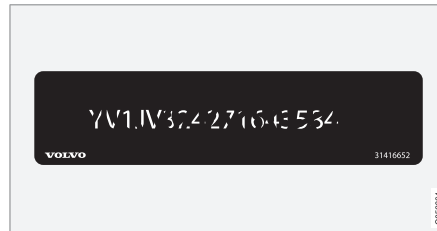

2 Vehicle Identification Number (VIN). The VIN plate is located on the top left surface of the dashboard. The Vehicle Identification Number (VIN) should always be quoted in all correspondence concerning your vehicle with the retailer and when ordering parts.

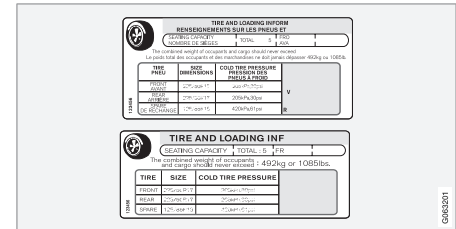

3 Tire inflation pressures. This label indicates the correct inflation pressures for the tires that were on the vehicle when it left the factory.



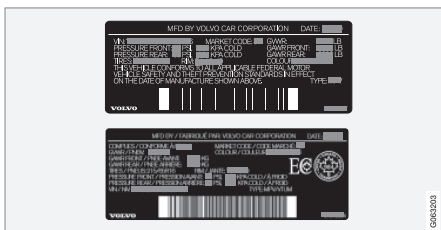

4 Federal Motor Vehicle Safety Standards (FMVSS) specifications (USA) and Ministry of Transport (CMVSS) standards (Canada). Your Volvo is designed to meet all applicable safety standards, as evidenced by the certification label on the driver's side B-pillar (the structural member at the side of the vehicle, at the rear of the driver's door opening). This label also includes codes for paint color, etc. For further information regarding these regulations, please consult your Volvo retailer. U.S. models have the upper decal; Canadian models have the lower one.



5 Engine oil. This label contains the recommended engine oil specifications.

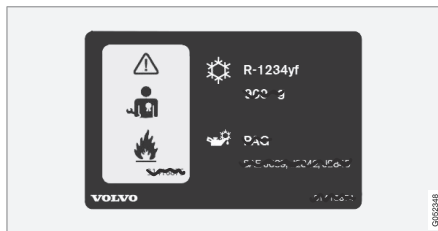

6 Decal A/C. Refrigerant R1234yf.

i NOTE

The decals shown in the Owner's Manual do not claim to be exact reproductions of those found in the vehicle. The purpose is to show approximately how they look and about where they are located on the vehicle. The information that applies for your vehicle in particular is found on the decal on the vehicle.

Related information

- Air conditioning specifications (p. 655)

Dimensions

The vehicle's length, height, etc. are shown in the table.

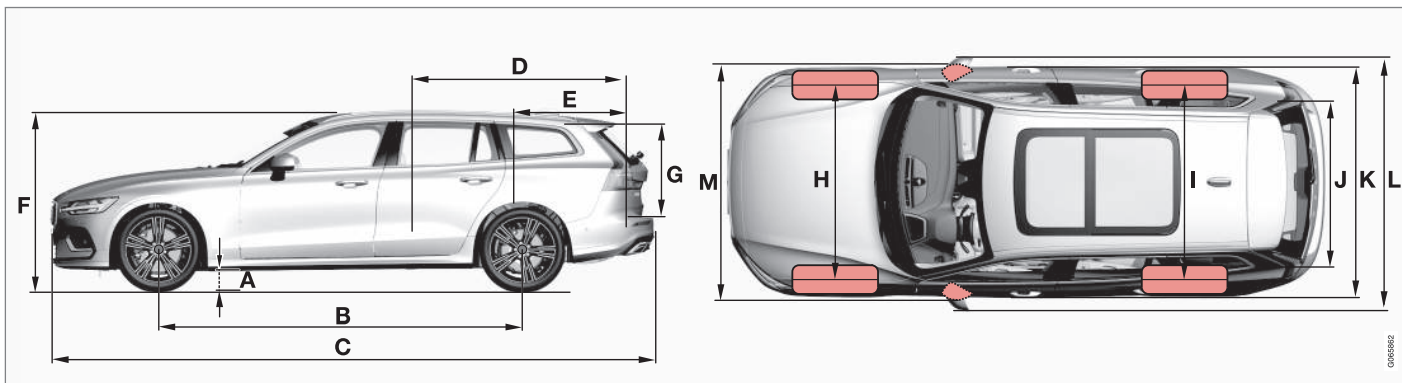

	Dimensions	mm	inches
A	Ground clearance ^A	142	5.6
B	Wheelbase	2872	113.1
C	Length	4761	187.4
D	Load length, floor, folded backrest	1821	71.7
E	Load length, floor	1033	40.7
F	Height ^B	1437	56.6

	Dimensions	mm	inches
G	Load height	644	25.4
H	Wheel track, front	1610 ^C	63.4 ^C
		1603 ^D	63.1 ^D
		1600 ^E	63.0 ^E
		1593 ^F	62.7 ^F

	Dimensions	mm	inches
I	Wheel track, rear	1610 ^C	63.4 ^C
		1603 ^D	63.1 ^D
		1600 ^E	63.0 ^E
		1593 ^F	62.7 ^F
J	Load width, floor	1064	41.9
K	Width	1850	72.8



SPECIFICATIONS



	Dimensions	mm	inches
L	Width incl. rearview mirrors	2040	80.3
M	Width incl. folded rearview mirrors	1916	75.4

A For curb weight plus 1 person. (Varies slightly depending on tire dimensions, chassis variant, etc.).

B Including roof antenna, at curb weight.

C Vehicles with 16-inch wheels.

D Vehicles with 17-inch wheels.

E Vehicles with 18/19-inch wheels.

F Vehicles with 20-inch wheels.

Related information

- Weights (p. 651)

Weights

The following table lists important weight data for your vehicle.

Category	USA (lbs)	Canada (kg)
Gross vehicle weight	5620	2550
Capacity weight	915	415
Permissible axle weights, front	2800	1270
Permissible axle weights, rear	2910	1320
Curb weight	3800–4540	1710–2070
Max. roof load	165	75

CAUTION

- When loading the vehicle, the maximum gross vehicle weight and permissible axle weights may not be exceeded.

Related information

- Type designations (p. 646)
- Towing capacity and tongue weight (p. 652)

Towing capacity and tongue weight

Towing capacity and tongue weight are shown in the table.

Category		USA (lbs)	Canada (kg)
Max. trailer weights	Without brakes:	1650	750
	With brakes:	2000	900
Max. tongue weight	–	200	90

! CAUTION

- The maximum trailer weights listed are only applicable for altitudes up to 3280 ft (1,000 m) above sea level. With increasing altitude the engine power and therefore the car's climbing ability are impaired because of the reduced air density, so the maximum trailer weight has to be reduced accordingly. The weight of the car and trailer must be reduced by 10% for every further 3280 ft (1,000 m) (or part thereof).

Related information

- Type designations (p. 646)
- Weights (p. 651)
- Driving with a trailer (p. 457)
- Trailer Stability Assist* (p. 459)

Engine specifications

Engine specifications (output, etc.) for each engine variant are shown in the table below. The specifications for Special Edition vehicles may vary.

Recharge vehicles are powered by both a gasoline engine and an electric motor (ERAD – Electric Rear Axle Drive).

i NOTE
Not all engines are available on all markets.

Engine	Engine code ^A	Output (kW/rps)	Output (hp/rpm)	Torque (Nm/rps)	Torque (ft. lbs./rpm)	Number of cylinders
T8 Recharge	B4204T28	233/100	313/6000	400/37–90	295/2200–5400	4
T8 Recharge Polestar	B4204T39	245/100	328/6000	430/75	317/4500	4

^A The engine code, component and manufacturer serial numbers can be found on the engine.

Electric motor

Max. output: 65 kW (87 hp).

Torque: 240 Nm.

Related information

- Type designations (p. 646)
- Engine oil specifications (p. 654)

SPECIFICATIONS

Engine oil specifications

Engine oil of type VCC RBS0-2AE 0W-20 must be used. Lower oil grades may not offer the same fuel economy, engine performance or engine protection.

Volvo recommends:



General

See the Service and warranty booklet for information about oil change intervals.

i NOTE

This vehicle is delivered from the factory with synthetic oil.

Do not use oil additives.

Oil viscosity

The wrong oil viscosity can shorten engine service life during normal use. VCC RBS0-2AE 0W-20 provides good fuel economy and engine protection. See the viscosity chart.

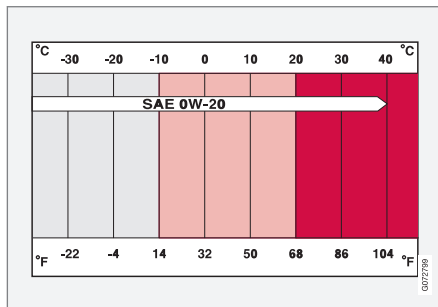

Viscosity chart

Oil volume

Engine oil volumes (including oil filter) are shown in the table.

Liter (approx)	5.6
US qts (approx)	5.9

Related information

- Type designations (p. 646)
- Checking and filling engine oil (p. 597)
- Engine oil (p. 596)

Transmission fluid specifications

Under normal driving conditions, the transmission fluid will not need to be changed during the transmission's service life. However, it may need to be changed if the vehicle is driven frequently in adverse driving conditions.

Automatic transmission

Prescribed transmission fluid:	AW-1
--------------------------------	------

Related information

- Type designations (p. 646)

Brake fluid specifications

The medium in the hydraulic brake system is called brake fluid and is used to transfer pressure from e.g. a brake pedal via a master brake cylinder, which in turn actuates the brake calipers.

Recommended grade: Volvo Original or similar fluid that meets a combination of Dot 4, 5.1 and ISO 4925 class 6.

i NOTE

Changing or filling brake fluid should be entrusted to an authorized Volvo workshop.

Related information

- Engine compartment overview (p. 595)

Fuel tank volume

The fuel tank's refillable volume is shown in the table below.

	All models
Liter (approx)	60
US gallons (approx)	15.9

Related information

- Refueling (p. 449)
- Octane rating (p. 451)

Air conditioning specifications

The climate system in the vehicle uses a freon-free R1234yf refrigerant. For information regarding the refrigerant, refer to the decal located on the inside of the hood.



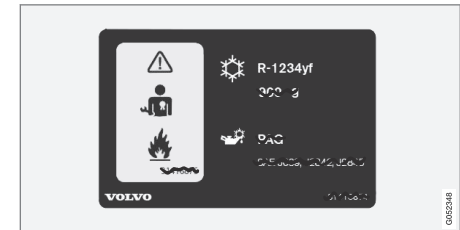

The prescribed grades and volumes for fluids and lubricants in the air conditioning system are shown below.

A/C Decal

Decal for R1234yf



◀◀ **Explanation of symbols for R1234yf**

Symbol	Explanation
	Caution
	Mobile air condition system (MAC)
	Lubricant
	Only a trained and certified technician can perform service on the mobile air conditioning system (MAC)
	Flammable refrigerant

Refrigerant

The refrigerant amount (charge level) is printed on a decal on the inside of the hood.

Vehicles with R1234yf refrigerant

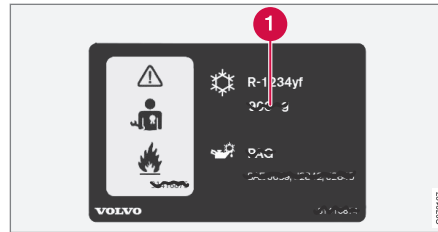

1 Refrigerant amount.

WARNING

The air conditioning system contains the refrigerant R1234yf under pressure. In accordance with SAE J2845 (Technician Training for Safe Service and Containment of Refrigerants Used in Mobile A/C System), service and repairs to the refrigerant system may only be performed by trained and certified technicians in order to ensure the safety of the system.

Compressor oil

Volume	Prescribed grade
100 ml (3.38 fl. oz.)	PAG SP-A2

Evaporator

CAUTION

The A/C system evaporator must never be repaired or replaced with a previously used evaporator. The new evaporator must be certified and labeled in accordance with SAE J2842.

Related information

- Climate control system service (p. 593)

Approved tire pressure

The following tire pressures are recommended by Volvo for your vehicle. Refer to

the tire inflation placard for information specific to the tires installed on your vehicle at the factory.

Tire dimensions	Cold tire pressure for up to five persons	
	Front psi (kPa)	Rear psi (kPa)
235/45 R18 235/40 R19	39 (270)	39 (270)
Temporary spare tire T125/80 R18	60 (420)	60 (420)

Related information

- Type designations (p. 646)
- Checking tire pressure (p. 543)
- Recommended tire pressure (p. 545)

INDEX

1, 2, 3 ...

4WD 432

A

ABS
anti-lock brakes 417

AC (Air conditioning) 221

Accessories and extra equipment 36
installation 37

Accessory installation warning 37

Active Bending Lights 156

Adapting driving characteristics 434

Adaptive Cruise Control 284
activating 287
auto-brake 313
change cruise control functionality 291
controls 286
deactivate 288
display 286
limitations 290
passing 308
set time interval 312
standby mode 289
stored speed 311
switching target vehicles 310
Symbols and messages 292

troubleshooting 290
WARNING 309

Adjusting the steering wheel 195

Advanced Air Cleaner 204

Airbag 55
activation/deactivation 59
driver's side 56
passenger side 56, 59

Air bag, see Airbag 55

Air conditioning 221

Air conditioning, fluid
volume and grade 655

Air distribution 204
air vents 204, 205
changing 205
defrosting 216
recirculation 215
table showing options 207

Air quality 201, 202
Advanced Air Cleaner 204
allergy and asthma 202
passenger compartment filter 203

Air recirculation 215

Alarm 264
deactivating 265

Alarm about slippery road conditions 274

Alarm on hazard warning flashers 274

Allergy and asthma-inducing substances 202

All Wheel Drive, AWD 432

All Wheel Drive (AWD) 432

All Wheel Drive (four-wheel drive) 432

Android Auto 504, 505, 506

Antenna
location 255

Apple CarPlay 500, 501, 503

Approach lighting 160

Apps 472

Assistance at risk of collision 335
activating/deactivating 336
at risk of run-off 336
during collision risks from behind 338
during collision risks from oncoming traffic 337
limitations 339
Symbols and messages 340

Audio and media 470

Audio system
HD digital radio 481
SiriusXM® Satellite radio 482, 483, 485

Auto-climate 214

Auto hold 424

INDEX

Auto-hold brakes	424
activating/deactivating	425
after collision	426
driver support	268
Automatic car wash	633
Automatic high beam	155
Automatic locking	258
Automatic relocking	239, 253
Automatic transmission	427, 428
kickdown	431
oil	654
Trailer	457
Auxiliary heater	231

B

Backrest	
front seat, adjusting	182, 183, 186,
187,	188,
rear seat, folding	189, 192
Battery	
hybrid battery	603
jump-start	455
Maintenance	601
recycling	604
starter battery	601
symbols on the battery	603

Blind Spot Information	342
BLIS	342
activating/deactivating	343
limitations	344
Symbols and messages	345
Blower	
adjusting	218
air distribution	205
air vents	205
Bluetooth	
connect	497
connecting vehicle to Internet	517
phone	507
settings	515
Book service and repair	587
Booster cushions	74
Brake assist	
after collision	426
Brake energy	418, 432
Brake fluid	
grade	655
Brake functions	417
Brake position	428
Brakes	417
anti-lock brakes, ABS	417
auto-brake with Pilot Assist	313

auto-braking with Adaptive Cruise Control	313
automatic when stationary	424
Brake Assist System, BAS	419
brake lights	159
brake system	417
emergency brake lights	159
Maintenance	420
on salted roads	420
on wet roads	420
parking brake	421
brake system	
fluid	655

C

Camera sensor	
see Camera	381
Camera unit	381
limitations	381
maintenance and cleaning	384
Symbols and messages	386
Capacity weight	563, 651
Care Key	
restricted remote key	246
settings	247
Cargo compartment	570
attachment points	573

cargo net	578	Charge		crossing traffic	327
electrical outlet	567, 568	vehicle function	445	delayed evasive maneuver	329
Lighting	161	Charge level		detecting obstacles	325
Cargo compartment cover	574, 575	vehicle function	445	evasive maneuver	328
cargo net	578	Charging		limitations	331
Cargo net	578	hybrid battery	391	limitations for evasive maneuvers	329
Car wash	630, 632, 633, 634, 635, 636	opening and closing the charging		limitations in crossing traffic	328
Catalytic converter	453	door	397	setting warning distance	324
recovery	461	start charging	397	sub-functions	322
Cell phone, see Phone	508	Status	399, 401, 404	Symbols and messages	334
Center console	567	stop charging	406	Cleaning	628, 629, 630
Center display		Charging cable	394	automatic car wash	633
change appearance	129	Charging current	392	car wash	630, 632, 633, 634, 635, 636
cleaning	625	Checking engine oil level	597	center display	625
climate controls	210	Child lock		Seat belts	627
Function view	120	activating/deactivating	257	textile upholstery	624, 626, 628
handling	110, 113, 117, 122	Child restraints	66, 68	upholstery	624, 626, 627, 628, 629,
keyboard	124	booster cushions	74	wheels	630
messages	138, 139	convertible seats	72	Cleaning wheels	636
overview	108	infant seats	70	Cleaning wiper blades	635
settings	130, 131	ISOFIX/LATCH anchors	77	CleanZone	201
switch off and change volume	129	lower attachment points	77	Clean Zone Interior Package	202
symbols in status bar	122	recalls and registration	68	Climate	198
views	113	top tether anchors	75	auto-regulation	214
Central locking	256	Child safety	66	blower control	218
Change of owner	132	Circuit breaker	395	parking	221
Changing target vehicle	310	City Safety	321	perceived temperature	199
		braking for oncoming vehicles	330		

INDEX

Sensors	199	Connected Safety	274	Cross Traffic Alert	350
temperature control	219, 220	activating/deactivating	275	activating/deactivating	351
voice control	200	limitations	275	limitations	351
zones	198	Connecting vehicle to Internet		messages	353
Climate controls	210	No connection or poor connection	521	Cruise control	281
center display	210	via a mobile device (WiFi)	517	activating	282
rear seat	210	via cellular phone (Bluetooth)	517	standby mode	284
Climate system	198, 210	via vehicle's modem	518	stored speed	311
Refrigerant	655	Connect phone	508	turn off	283
repairs	593	Contact information	26	Curb weight	651
Clock, setting	92	Control unit		Customer Privacy Policy	35
Collision	44, 49, 55, 64	charging status	401	CZIP (Clean Zone Interior Package)	202
Collision warner		Convertible seats	72		
crossing traffic rear	350	coolant	599	D	
see City Safety	321	filling	599	<hr/>	
Collision warning		Cooling system		Data	
from the rear	341	overheating	453	recording	33
with Adaptive Cruise Control	309	Cornering assistance	306	transferring between vehicle and	
with Pilot Assist	309	activating/deactivating	307	workshop	585
Color code, paintwork	639	limitations	307	Data sharing	522, 523
Color codes	639	Cornering illumination	157	Daytime running lights	152
Compass	466, 467	Corner Traction Control	269	Decals	
calibration	467	Corrosion protection	637	location	646
Condensation in headlights	632, 633, 634, 635	Covering		Defrosting	216
		cargo compartment	575	Detecting obstacles	
		Crash, see Collision	44	City Safety	325
		Crash event data	33		

Diagnosis		Driver Alert Control	346	electric motor	432
via the workshop's Wi-Fi	585	activating/deactivating	347	Driving	443
Dimensions	649	limitations	348	Range	442
Dipstick, electronic	597	rest stop guidance	347	Electric parking brake	421
Direction of rotation	538	Driver performance	90	Electronic immobilizer	250
Display		settings	91	emergency brake lights	159
driver information	82	Driver profile	134	Emission inspection readiness	582
Display lighting	162	edit	135, 136, 138	Energy distribution	
Distance Alert	348	select	135	using map data	439
activating/deactivating	349	Driver support system	268	Engine	
limitations	349	Drive mode	313	automatic start and stop of combustion engine	433
Set time interval	312	Drive systems	432	overheating	453
DivX®	496	Driving		start	412
Door mirrors	167	cooling system	453	turn off	414
compass	466, 467	with a trailer	457	Engine braking	417, 428
dimming	168	Driving through standing water	447	Engine compartment	
outer	167	driving with a trailer		coolant	599
power folding	168	towball load	652	engine oil	596
resetting	168	towing capacity	652	overview	595
store position	184, 185			Engine drag control	269
Download Center	585	E		Engine oil	596
use	586	Electrical outlet	567	checking and filling	597
Driveline		use	568	grade and volume	654
transmission	427	Electrical system	601	Engine shutdown	414
Drive mode	434	Electric drive motor		Engine specifications	653
changing	438	specifications	653		
when using driver support	313				

INDEX

Engine temperature	
high	453
Environment	28
Ethanol content	
max. 10% by volume	450
Exterior dimensions	649
Extra heater (Auxiliary heater)	231

F

Federal Clean Air Act	582
Ferry transport	440
Flooded road	447
Fluids, volumes	643, 655
Fluids and oils	599, 654, 655
Fog lights	
front	157
rear	158
Four-C	440
Front seat	
blower	218
climate	210
heating	211, 212
temperature	219
ventilation	213
Front seat manual	182

Front seats, power	183
adjusting passenger seat from driver's seat	191
adjusting seat	183
lumbar support	189
massage	186, 187, 188
multifunction control	186, 187, 188, 189
side bolsters	189
store position	184, 185
FSC, environmental labeling	23
Fuel	450
Travel Link service	489
Fuel filling	449
Fuel gauge	85
Fuel requirements	450, 451
Fuel tank	
volume	655
Fuse box	605
Fuses	604
below the glove compartment	613
in engine compartment	606
in the cargo compartment	619
replacing	605

G

Gasoline grade	450
Gauge	
fuel gauge	85
hybrid battery	86
Gear selector positions	
automatic transmission	428
Glass, laminated/reinforced	164
Glove compartment	569
Gracenote®	495
Grocery bag holders	572
Gross vehicle weight	651

H

Handbrake	421
Hand wash	632
Hard disk	
space	524
Hazard warning flashers	159
HD radio	479
Head restraint	193
Head-up display	140
activating/deactivating	142
cleaning	626

INDEX

IntelliSafe	
driver support	29
Interior Air Quality System	202
Intermittent wiping	175
Internet, see Internet-connected vehicle	516
Internet-connected vehicle	516
book service and repair	587
No connection or poor connection	521
send car data	588
system updates	586
iPod®, connecting	498
ISOFIX/LATCH anchors	77

J

Jack	553
Jump-start	455

K

Key	236
Keyboard	124, 127
change language	127

Keyless	
locking/unlocking	253
settings	254
touch-sensitive surfaces	252
Key tag	236

L

Labels	
location	646
Laminated glass	164
Lamps	
changing	624
Trailer	460
Lane Keeping Aid	314
activating/deactivating	316
display	320
limitations	317
see Lane Keeping Aid	314
select assistance option	317
Symbols and messages	318
Language	130
Large Animal Detection (LAD)	325
Launch function	431
Leather upholstery, cleaning instructions	628

Leveling control	
suspension	440
License agreement	96, 525
Lifting tools	553
Light bulbs	
changing	624
Light control	150, 162
Lighting	
Active Bending Lights	156
approach lighting	160
automatic high beam	155
brake lights	159
control, instrument, display	162
controls	150, 160
cornering illumination	157
daytime running lights	152
emergency brake lights	159
front fog lights	157
Hazard warning flashers	159
high beams	154, 155
home safe lighting	160
in passenger compartment	160
low beams	153
position lights	152
rear fog light	158
settings	151
Turn signals	156
Lighting, replacing bulbs	624
Limp home	427

Load anchoring eyelets	
cargo compartment	573
Load anchoring hooks	572
Load carriers	572
Load index	540
Loading	
general	571
load anchoring eyelets	573
long load	571
Lock indication	234
setting	236
Locking/unlocking	
Tailgate	241, 254
Locking wheel bolts	553
Locks	
locking/unlocking	239
Locks and remote keys	234
Long-term storage	409
Low battery charge level	
start battery	454
Low beams	153

M

Maintained climate comfort	227
start/stop	228
Maintenance	582
corrosion protection	637
Max. axle weight	651
Max. roof load	651
Media player	491, 492, 493
compatible file formats	499
voice control	147
Messages and symbols	
Adaptive Cruise Control	292
Assistance at risk of collision	340
BLIS	345
camera and radar unit	386
City Safety	334
Cross Traffic Alert	353
Lane Keeping Aid	318
Park Assist Camera	367
Park Assist Pilot	377
Parking Assist	358
Pilot Assist	304
stability and traction control system	272
Messages in display	104, 138
handling	105, 139
saved	106, 139
Mileage	87
electric motor	442

Misting	
condensation in headlights	630, 633
Mood lighting	162
adjusting	162

N

Net	
cargo compartment	578

O

Occupant safety	45
Occupant weight sensor	59
Octane rating	451
Oil, see also Engine oil	654
Oil filter	596
Oil level	597
On-board diagnostics	582
On-board Diagnostic socket	37
Option/accessory	21
Outside temperature gauge	92
Overheating	453, 457
Owner's information	16

INDEX

OWNER'S MANUAL	21	perpendicular parking	370	Passenger compartment lighting	160
environmental labeling	23	pulling out of a parking space	374	adjusting	162
in cellular phone	20	Symbols and messages	377	auto switch	161
in the center display	17, 18	use	371	Passing assistance	308
		Park Assist System	354	activating	308
		parking		personal information (Customer Privacy Policy)	35
		on hills	423	Phone	507
P		Parking Assist	354	changing to another	511
<hr/>		activating/deactivating	356	connect	508
Paddle at steering wheel	195	front, rear and sides	355	connect automatically	510
Paint		limitations	357	connect manually	510
color code	639	Symbols and messages	358	delete	511
paint damage and touch-up	637, 639	Parking brake	421	disconnect	510
638,	639	activating/deactivating	421	phone call	511, 514
Panoramic roof	170	automatic activation	423	text message	512
opening and closing	171	Low battery charge level	423	voice control	146
pinch protection	164	Parking climate	221	Pilot Assist	294
sun shade	173	Symbols and messages	229	activating	298
ventilation position	172	Parking heater	230	auto-brake	313
Parallel parking	369	Passenger compartment filter	203	controls	296
Park Assist Camera	359	Passenger compartment heater (Parking heater)	230	disengaged steering assistance	301
activating	365	Passenger compartment interior	566	display	297
limitations	381	center console	567	limitations	302
location and views	360	electrical outlet	567	passing	308
sensor field	364	glove compartment	569	set time interval	312
Symbols and messages	367	sun visor	570	standby mode	300
trajectory lines	362			stored speed	311
Park Assist Pilot	369			switching target vehicles	310
limitations	374				
parallel parking	370				

Symbols and messages 304
 turn off 299
 WARNING 309
 pinch protection 164
 resetting 165
 PIN code 519
 Private locking 263
 Polestar Engineered 440, 441
 Polishing 631
 Position lights 152
 Power 653
 electric motor 653
 Power folding door mirrors 168
 Power panoramic roof 170
 Power save mode 454
 Power seats 183
 Power windows 165, 166
 opening and closing 166
 pinch protection 164
 Precleaning 226
 start/stop 226
 Preconditioning 222
 start/stop 222
 timer 223
 Pressure wash 634
 Privacy Policy (Customer Privacy Policy) 35

Private locking 262
 activating/deactivating 263
 PROPOSITION 65 WARNING 455

R

Radar unit 378
 limitations 381
 maintenance and cleaning 384
 Symbols and messages 386
 type approval 379
 Radio 474
 changing radio waveband and radio station 476
 HD radio 479
 RBDS 478
 search radio station 476
 settings 478
 SiriusXM® Satellite radio 482, 483, 485
 start 475
 voice control 147
 Radio favorites 477
 Rain sensor 175, 176
 Rain sensor's memory function 176
 Rear camera 359

Rear Collision Warning 341
 limitations 341
 Rear seat
 climate 210
 folding backrest 192
 head restraint 193
 heating 212
 Rearview/door mirrors
 adjusting door mirrors 168
 dimming 168
 heating 217
 interior 167
 Rearview mirror 167
 dimming 168
 Rear window
 heating 217
 washers 178, 179
 wipers 178, 179
 Recalls 47
 Recharge
 general 390
 Recommendations when driving 446
 Recommendations when loading 571
 Recovery 462
 Refrigerant 593
 climate system 655

Side Impact Protection System	62, 63	Stability and traction control system	269	Storage compartments	566
SIM card	519	sport mode	270, 271	center console	567
SIPS (Side Impact Protection System)	62, 63	Symbols and messages	272	glove compartment	569
Sirius Satellite radio		Stains	624, 626, 627, 628, 629, 630	sun visor	570
Travel link	486	Start and lock system		Stored speed	311
SiriusXM® Satellite radio		type designations	250	Sunroof	
traffic information	482, 483, 485	Start battery	455, 601	pinch protection	164
Ski hatch	574	overload	454	Sun shade	
Slippery conditions	446	Start engine	412	panoramic roof	170, 173
Slippery road conditions	446	Starting the engine		pinch protection	164
Snow chains	556	after a collision	65	Sun visor	570
Software updates	33	Start the vehicle	412	mirror lighting	161
Sound experience	471	Steel cargo grid	576	Symbols	
Sound settings	470, 513	Steering assistance at risk of collision	335	dynamic	82
phone	514	Steering power level, see Steering wheel		indicator symbols	93
playing media	492, 493	resistance	268	warning symbols	93
text message	513	Steering wheel	195	Symbols and messages	
Spare tire	554	heating	214	center display's status bar	122
handling	555	keypad	195	hybrid-related	407
Speed camera information	278	paddle	195	parking climate	229
activating/deactivating	279	steering wheel adjustment	195	system updates	586
Speed symbols, tires	540	Steering wheel keypad	195		
Spin control	269	Steering wheel paddles	429		
		Steering wheel resistance, speed-dependent	268		
		Stone chips and scratches	637, 638, 639		

T

Tailgate	
closing and locking using button	259
locking/unlocking	241, 254

INDEX

open/close with foot movement	261	tread wear indicator	539	Transmission	427
unlocking from inside	257	winter tires	556	automatic	427, 428, 432
Technician certification	38	Tire sealing system	557	Transmission fluid	
Temperature		Inflating tires	562	grade	654
adjusting	219, 220	use	558	Travel Link	486
perceived	199	Tire tread	539	Fuel	489
Temperature monitoring	397	Tools	552	Notifications	489
Temporary Spare	554	Top tether anchors (child restraint systems)	75	Sports	491
Temporary tire sealing system	557	Top view	130	weather	487
Terms and conditions		Total airing function	236	Tread depth	539
services	35	Towing	461	winter tires	556
users	522	Towing capacity and towball load	652	Tread wear indicator	539
Time interval to the vehicle ahead	312	Towing eyelet	461	Trip computer	87
Tires		Towing capacity and towball load	652	display in instrument panel	89
age	536	TPMS - Tire Pressure Monitoring System	545	Trip odometer	87
designations	540	Traction control	269	Trip odometer resetting	90
direction of rotation	538	Traffic information	478	Trip statistics	90
economy and wear	536	Trailer		settings	91
glossary of terms	539	driving with a trailer	457	Troubleshooting	
inflation pressure table	657	Lamps	460	Adaptive Cruise Control	290
pressure	657	swaying	459	City Safety	331
recommended	536	Trailer Stability Assist	270	TSA - Trailer Stability Assist	459
removing and installing	550	trailer	459	Tunnel detection	153
rotation when changing	536	Trailer stabilizer	270, 459	Turn off engine	414
specifications	540, 657			Turn signals	156
speed rating	540				
storage	536				

Type approval	
HomeLink®	466
radar system	379

U

Uniform Tire Quality Grading	542
Units	130
Unlocking	
settings	240
with key blade	248
USB	
socket for connecting media	498

V

Vehicle care	630, 632, 633, 634,
	635, 636
leather upholstery	628
Vehicle Event Data	33
Vehicle functions	
in the center display	120
Vehicle key bat. low	242
Vehicle modem	
connecting vehicle to Internet	518
settings	519

Vehicle recovery	462
Vehicle status	587
inflation pressure	548
Vehicle upholstery	624, 626, 627,
	628, 629, 630
Vehicle weight	651
Ventilation	204, 205
Seats	213
Video	496, 498
settings	497
Voice control	143
climate	200
phone	146
radio and media	147
settings	148
use	144, 146, 147, 148
VOL mark	536
Volvo ID	26
create and register	27

W

Warning lights	
Adaptive Cruise Control	309
Pilot Assist	309
stability and traction control system	269
Warning sound	
parking brake	423
warning symbols	93
Warning symbols	
safety	44
Warranties	582
Washer	
headlights	177
rear window	178, 179
washer fluid, filling	643
Windshield	177
Washer fluid	174, 643
Waxing	631
Weights	
Curb weight	651
Wheel bolts	553
Wheels	
cleaning	636
removing and installing	550
Snow chains	556

INDEX

Wheels and tires	
Load index and speed symbol	540
Whiplash protection	48
Whiplash Protection System	48
WHIPS (Whiplash Protection System)	48
Wi-Fi	
connecting vehicle to Internet	517
delete network	521
sharing Internet connection, tethering, hotspot	520
technology and security	522
Windows and glass	164
Windshield	
projected image	140, 142
Windshield washing	177
Windshield wipers	174
rain sensor	175, 176
Winter driving	446
Snow chains	556
winter tires	556
Wiper blade	174
replacing	639, 641
service position	642
Wiper blade and washing fluid	174
Wiper blades, heated	174

 **WARNING**

California Proposition 65

Operating, servicing and maintaining a passenger vehicle can expose you to chemicals including engine exhaust, carbon monoxide, phthalates, and lead, which are known to the State of California to cause cancer and birth defects or other reproductive harm. To minimize exposure, avoid breathing exhaust, do not idle the engine except as necessary, service your vehicle in a well ventilated area and wear gloves or wash your hands frequently when servicing your vehicle. For more information go to www.P65Warnings.ca.gov/passenger-vehicle.

V O L V O